



KENTUCKY TRANSPORTATION CABINET
Department of Highways
DIVISION OF MAINTENANCE – PERMITS BRANCH

TC 99-210
Rev. 08/2018
Page 1 of 6

**ROLLING ROADBLOCK
FOR PERMITTED WORK ON FULLY CONTROLLED HIGHWAYS**

KYTC KEPT #: _____

SECTION 1: DESCRIPTION

Rolling roadblocks shall be utilized to temporarily slow traffic on fully controlled highways when a completed closure is not warranted or allowed (overhead utilities, signs, etc.). Rolling roadblocks should minimize delays and increase safety of the traveling public.

SECTION 2: GUIDELINES & REQUIREMENTS

- Applicable sections of the "*Policy and Procedures for the Safety and Mobility of Traffic through Work Zones*" must be followed.
- Traffic Control Plan (TCP) must be submitted and approved by the District prior to any work on right-of-way.
- A Public Information Plan must be submitted and approved by the District prior to any work on right-of-way.
- Traffic shall be paced at a safe speed to provide a gap in traffic and allow work activities to be performed.
- The pacing of traffic shall be controlled for each lane by pilot vehicles. Law enforcement (fully marked and roof bar blue lights flashing) driven by uniformed law enforcement personnel shall be provided in at least one lane of traffic for each direction. Law enforcement personnel must have completed the FHWA Work Zone for Law Enforcement Training in accordance to 23 CFR Part 630 Subpart K. Additional lanes of traffic can be controlled by contractor equipment with appropriate flashing lights.
- Once notified by the traffic control supervisor to begin the rolling roadblock operation, the safety vehicle at the indicated ramp shall turn their flashing lights on, and position the vehicle across the ramp lane(s) to close ramp access. Once the rolling roadblock operation passes the closed on-ramp, the safety vehicle on the ramp shall turn off their flashing lights, and move from the ramp lane(s) to allow traffic to enter the mainline rolling roadblock operation.
- Communicating devices must be utilized to provide constant communication between the location of work and contractor vehicles.
- Advanced signing warning motorists of the rolling roadblock shall be provided by variable message signs. Variable message signs shall be placed after the last possible entry location prior to the work area.
- Contractor shall provide additional equipment on-site in case of critical equipment malfunctions or failures.
- Truck mounted crash cushions meeting the current MUTCD shall be placed at the work area for any equipment in the driving lanes.
- Equipment located on shoulders must be protected by safety devices meeting the current MUTCD.





The Permit Traffic Control Plan (TCP) must at a minimum include the following:

- Identification of the qualified work zone traffic control personnel
- Work schedules
- Rolling roadblock schedule
- Anticipated time of delays to traveling public
- Proposed blocking procedures must be included for mainline and on-ramps
- List of critical equipment for work activity
- Name, Signature, and Work Zone Traffic Control Supervisor Number

GENERAL NOTES

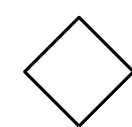
1. ROLLING ROADBLOCK IS A TRAFFIC CONTROL TECHNIQUE TO SLOW TRAFFIC TO FACILITATE SHORT DURATION WORK OPERATIONS WITHOUT AN ELABORATE AND DIFFICULT DETOUR. TRAFFIC CONTROL LAW ENFORCEMENT OFFICERS PACE, OR SLOW, THE TRAFFIC TO A SPEED THAT PROVIDES UP TO 15 MINUTES OF WORK TIME.
2. WHEN MORE THAN ONE ROLLING ROADBLOCK OPERATION IS REQUIRED IN ONE WORK PERIOD, THE CONTRACTOR SHALL ALLOW SUFFICIENT TIME BETWEEN ROLLING ROADBLOCK OPERATIONS TO PERMIT TRAFFIC TO RETURN TO NORMAL SPEEDS AND FLOW.
3. "POLICY AND PROCEDURES FOR THE SAFETY AND MOBILITY OF TRAFFIC THROUGH WORK ZONES FOR PERMIT PROJECTS" MUST BE FOLLOWED FOR ALL WORK. <http://transportation.ky.gov/Permits>
4. TEMPORARY TRAFFIC CONTROL PLAN (TTCP) MUST BE SUBMITTED AND APPROVED BY THE KYTC PRIOR TO ANY WORK ON STATE R/W.
5. LAW ENFORCEMENT PERSONNEL MUST HAVE COMPLETED THE FHWA "WORK ZONE FOR LAW ENFORCEMENT TRAINING" IN ACCORDANCE TO 23 CFR PART 630 SUBPART K.
6. COMMUNICATING DEVICES MUST BE UTILIZED TO PROVIDE CONSTANT COMMUNICATION BETWEEN THE WORK LOCATION, CONTRACTOR VEHICLES AND LAW ENFORCEMENT VEHICLES.
7. CONTRACTOR SHALL PROVIDE ADDITIONAL EQUIPMENT ON-SITE IN CASE OF CRITICAL EQUIPMENT MALFUNCTIONS OR FAILURES.
8. EQUIPMENT LOCATED ON SHOULDERS MUST BE PROTECTED BY CHANNELIZING DEVICES MEETING THE CURRENT MUTCD.
9. TRAFFIC CONTROL DEVICES SHALL BE PLACED AT A TIME AS CLOSE AS PRACTICAL TO THE BEGINNING OF THE ROLLING ROADBLOCK.
10. AFTER ROLLING ROADBLOCK OPERATIONS ARE COMPLETE, THE TRAFFIC CONTROL DEVICES THAT ARE NOT BEING UTILIZED FOR OTHER OPERATIONS SHALL BE IMMEDIATELY REMOVED.
11. ROLLING ROADBLOCKS REQUIRING THE CONTROL OF ON-RAMPS FROM MAJOR CROSSROADS WILL REQUIRE A MORE SPECIFIC/ DETAILED TTCP AND DETAILED DIAGRAMS.
12. A PAYMENT BOND SHALL BE RECEIVED BY THE DEPARTMENT IN AN AMOUNT SUFFICIENT TO COVER LIQUIDATED DAMAGES THAT MAY BE APPLIED IF THE ROADWAY IS CLOSED FOR MORE THAN THE TIME ALLOTTED FOR THE ROLLING ROADBLOCK.
13. LIQUIDATED DAMAGES MAY ALSO BE ASSESSED IF THE APPROVED TEMPORARY TRAFFIC CONTROL PLAN IS NOT FOLLOWED.
14. CONTRACTOR MUST NOTIFY AND RECEIVE APPROVAL FROM THE KYTC 7 DAYS IN ADVANCE OF THE ROLLING ROADBLOCK.

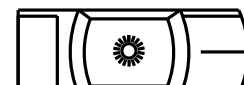
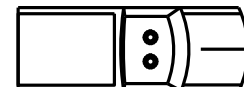
GENERAL SYMBOLS

-  STATIC SIGN (48" X 48")
-  PORTABLE VARIABLE MESSAGE SIGN (VMS)
-  LAW ENFORCEMENT VEHICLE WITH FLASHING BLUE LIGHTS
-  CONTRACTOR VEHICLE WITH FLASHING LIGHTS
-  DIRECTION OF TRAVEL
-  WORK AREA

<p>KENTUCKY TRANSPORTATION CABINET Department of Highways DIVISION OF MAINTENANCE - PERMITS BRANCH</p>	
<p>ROLLING ROADBLOCK For Permitted Work on Fully Controlled Highways</p>	
	TC 99-210 Rev. 08/2018 Page 2 of 6

TYPICAL PLACEMENT OF PCMS

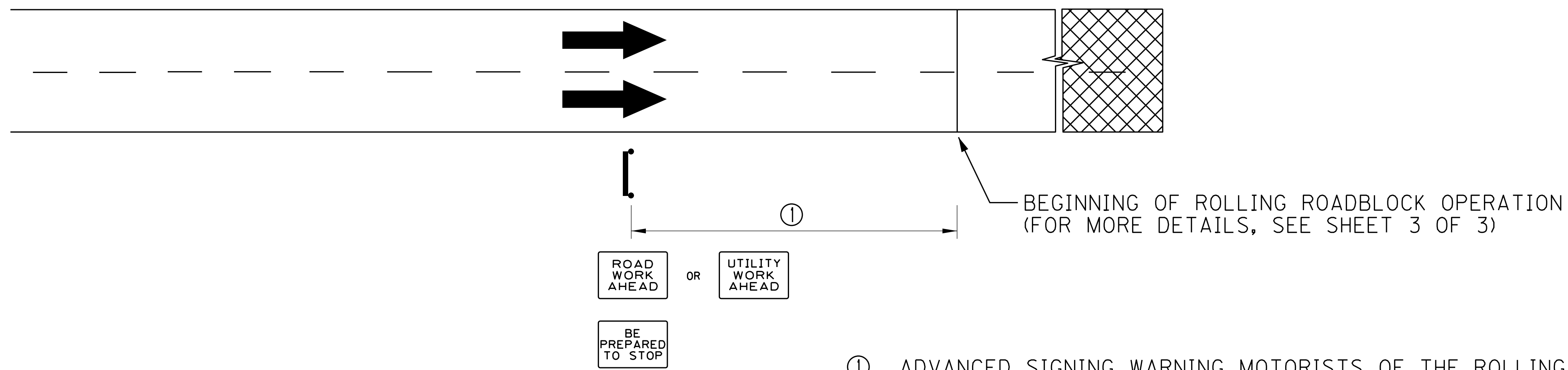

① ADVANCED SIGNING WARNING MOTORISTS OF THE ROLLING ROADBLOCK SHALL BE PROVIDED BY PORTABLE CHANGEABLE MESSAGE SIGNS (PCMS). PORTABLE CHANGEABLE MESSAGE SIGNS SHALL BE PLACED AFTER THE LAST POSSIBLE ENTRY LOCATION PRIOR TO THE WORK AREA BUT NO MORE THAN ONE (1) MILE PRIOR TO THE BEGINNING OF THE ROLLING ROADBLOCK.

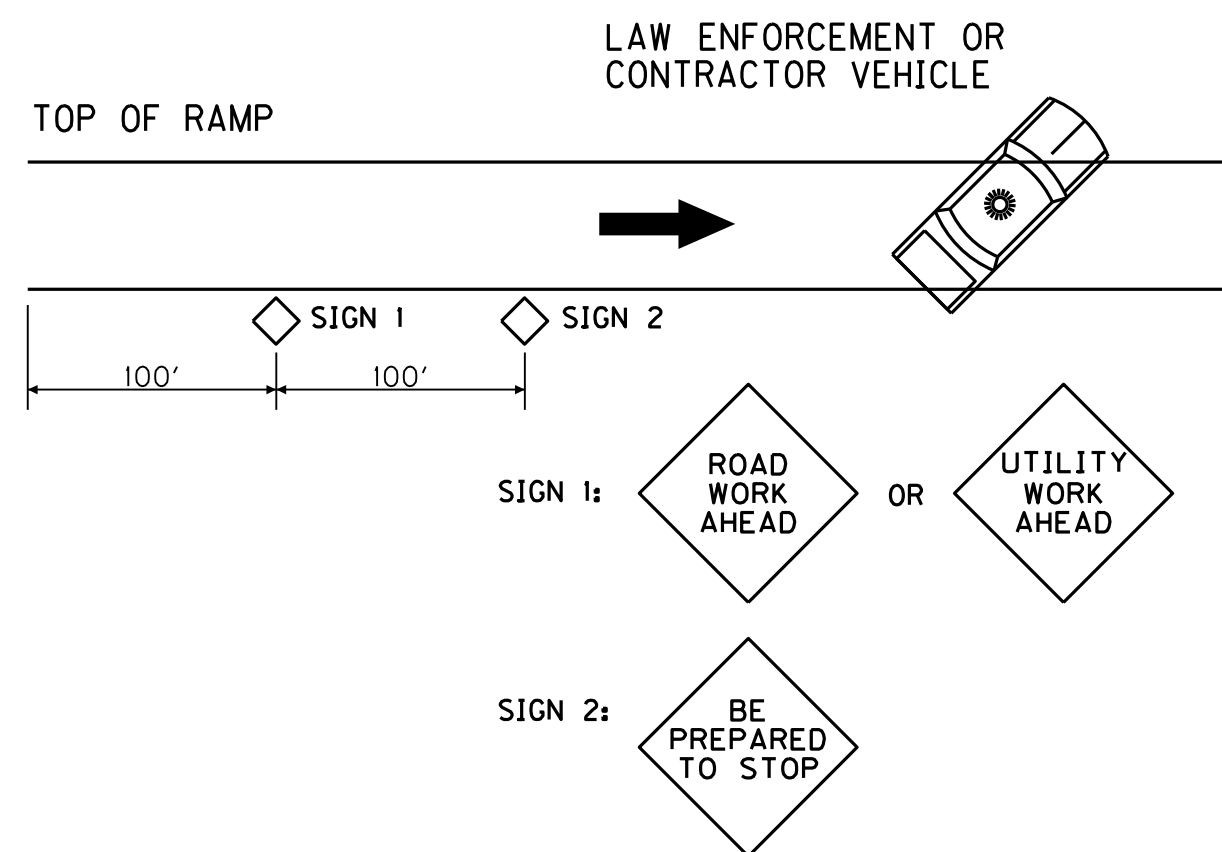

TYPICAL RAMP CLOSURE DETAIL

RAMP CLOSURE NOTES

TWO (2) STATIC SIGNS SHALL BE USED ON EACH CONTROLLED ON-RAMP. SIGN ONE (1) SHALL BE "ROAD WORK AHEAD" OR "UTILITY WORK AHEAD" SIGN AND SIGN TWO (2) SHALL BE "BE PREPARED TO STOP".

ONCE NOTIFIED BY THE TRAFFIC CONTROL SUPERVISOR TO BEGIN THE ROLLING ROADBLOCK OPERATION, THE SAFETY VEHICLE AT THE INDICATED RAMP SHALL TURN THEIR FLASHING LIGHTS ON, AND POSITION THE VEHICLE ACROSS THE RAMP LANE(S) TO CLOSE RAMP ACCESS.

ONCE THE ROLLING ROADBLOCK OPERATION PASSES THE CLOSED ON-RAMP, THE SAFETY VEHICLE ON THE RAMP SHALL TURN OFF THEIR FLASHING LIGHTS, AND MOVE FROM THE RAMP LANE(S) TO ALLOW TRAFFIC TO ENTER THE MAINLINE ROLLING ROADBLOCK OPERATION.

SITE SPECIFIC CONDITIONS MAY REQUIRE ADDITIONAL CONTROL DEVICES OR VEHICLES.

KENTUCKY TRANSPORTATION CABINET
Department of Highways
DIVISION OF MAINTENANCE - PERMITS BRANCH

ROLLING ROADBLOCK
For Permitted Work on Fully Controlled Highways



ROLLING ROADBLOCK
For Permitted Work on Fully Controlled Highways

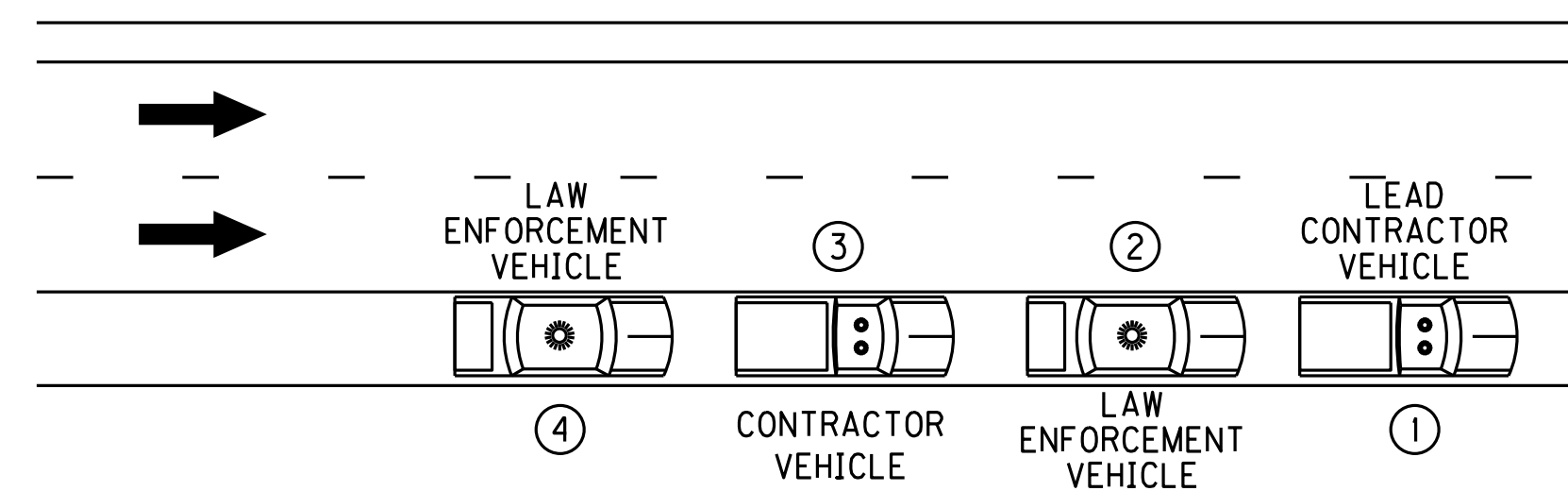

STAGE 1

STAGE 1 NOTES:

1. MINIMUM OF FOUR SAFETY VEHICLES LOCATED UPSTREAM OF THE ROLLING ROADBLOCK OPERATION WITH FLASHING LIGHTS OFF. A MINIMUM OF TWO (2) LAW ENFORCEMENT VEHICLES ARE REQUIRED. THE LOCATION OF STAGE 1 SHALL BE AT A LOCATION THAT GIVES A SUFFICIENT DISTANCE TO SLOW VEHICLES PRIOR TO THE BEGINNING MILEPOINT OF THE ROLLING ROADBLOCK.
2. THERE SHALL BE A PACE-SETTING VEHICLE IN EACH TRAVEL LANE.

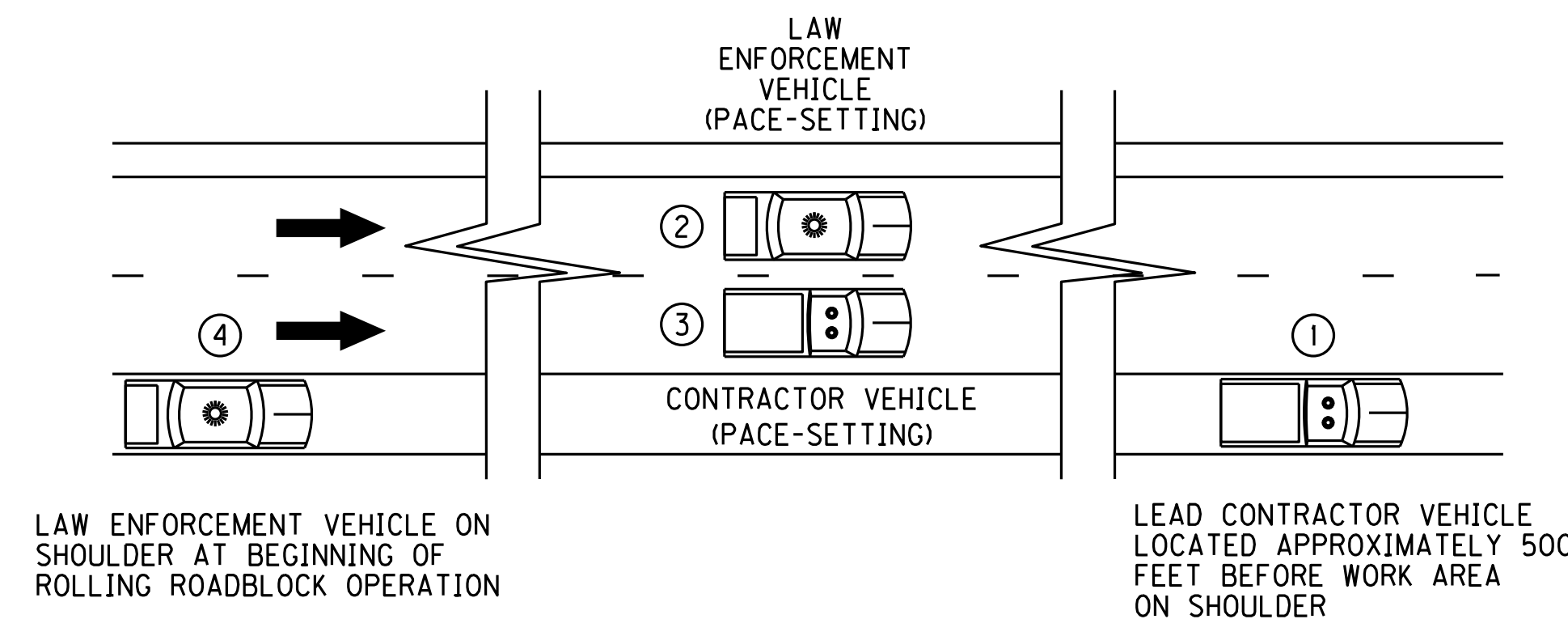

STAGE 3

STAGE 3 NOTES:

1. THE TWO (2) PACE-SETTING SAFETY VEHICLES NUMBERS TWO (2) AND THREE (3) SHALL BEGIN TO SLOW TO THE PACING SPEED (10 MPH MINIMUM), FOR THE DURATION OF THE ROLLING ROADBLOCK OPERATION.
2. THE LEAD CONTRACTOR VEHICLE NUMBER ONE (1) (FLASHING LIGHTS OFF) SHALL MATCH THE SPEED OF THE LAST VEHICLES AHEAD OF THE PACE-SETTING SAFETY VEHICLE NUMBERS TWO (2) AND THREE (3), AND CONTINUE FOLLOWING TRAFFIC UNTIL A POINT IN ADVANCE OF THE WORK AREA. THE LEAD CONTRACTOR VEHICLE NUMBER ONE (1) SHALL THEN COME TO A COMPLETE STOP ON THE RIGHT SHOULDER, AND THEN TURN ON ITS' FLASHING LIGHTS.

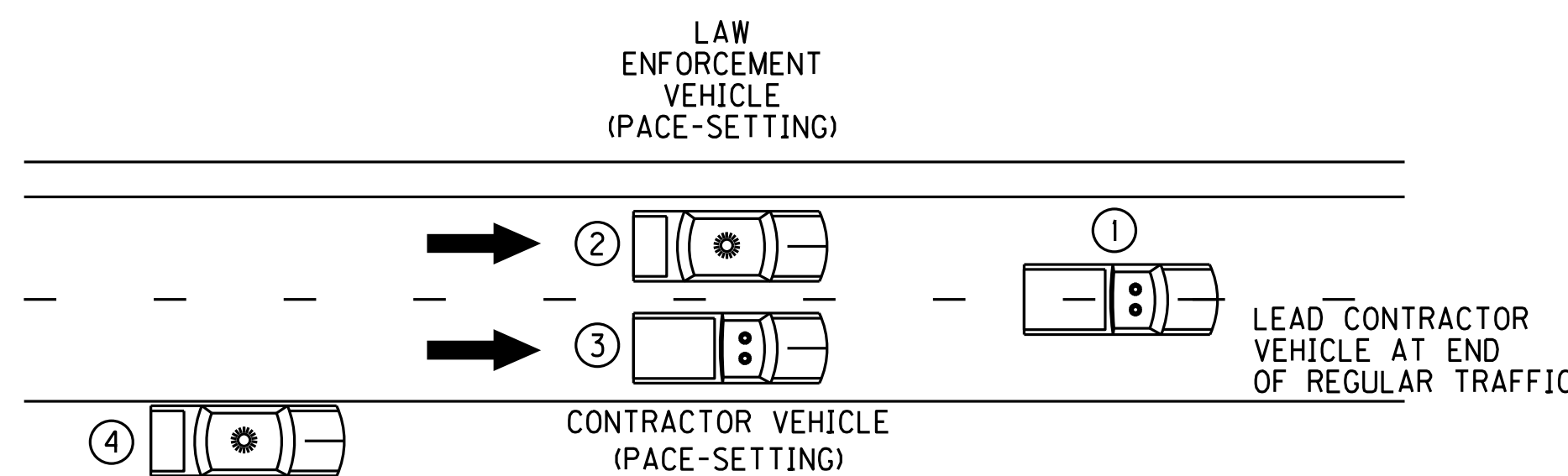

STAGE 2

STAGE 2 NOTE:

ONCE ALL SAFETY VEHICLES ARE IN PLACE AND THE SUPERVISOR AT THE WORK AREA NOTIFIES ALL SAFETY VEHICLES TO BEGIN THE ROLLING ROADBLOCK OPERATION, ALL SAFETY VEHICLES NUMBERS ONE (1), TWO (2), THREE (3) AND FOUR (4) SHALL TURN ON THEIR FLASHING LIGHTS. VEHICLE NUMBERS ONE (1), TWO (2) AND THREE (3) SHALL ENTER THE TRAVEL LANES, WITH VEHICLE NUMBERS TWO (2) AND THREE (3) IMMEDIATELY FORMING A SIDE-BY-SIDE "PACING OPERATION" OF ALL LANES BEHIND THE LEAD CONTRACTOR VEHICLE NUMBER ONE (1). ONCE VEHICLE NUMBER ONE (1) HAS ENTERED THE TRAVEL LANE FLASHING LIGHTS SHALL BE TURNED OFF.

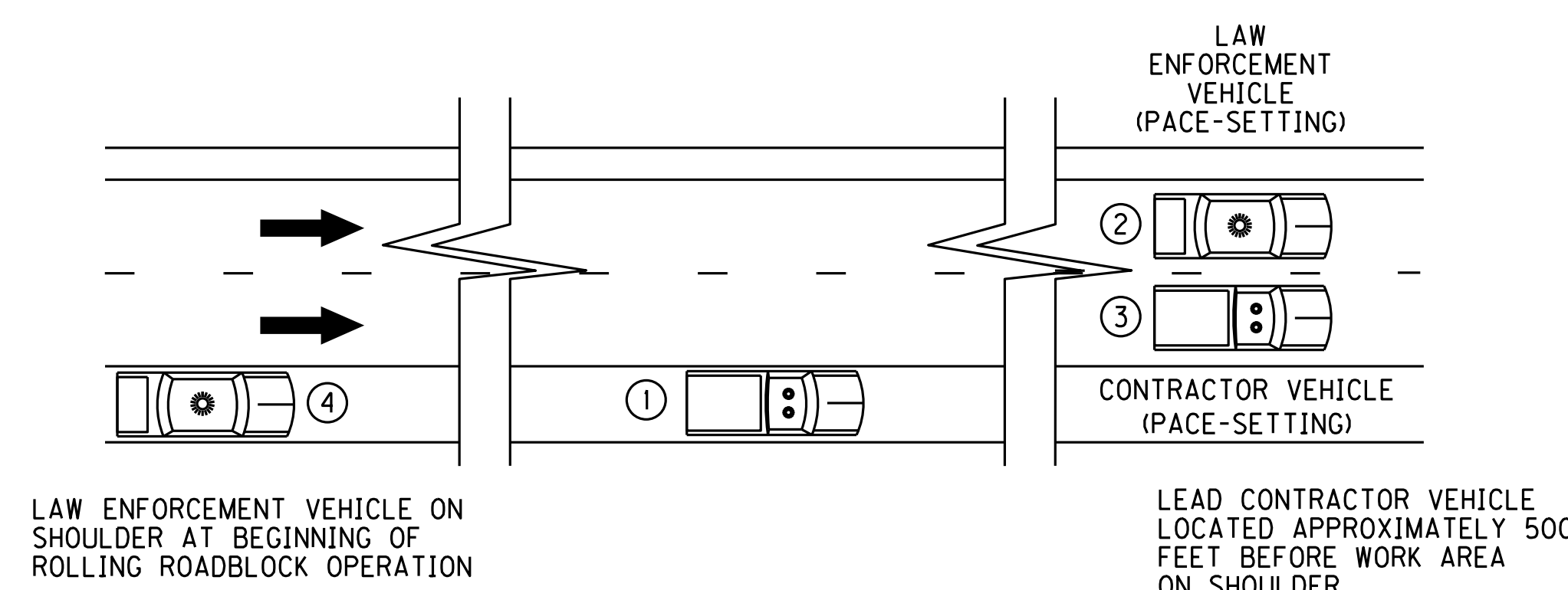

STAGE 4

STAGE 4 NOTES:

1. THE CONTRACTOR'S ON-SITE SUPERINTENDENT SHALL REMAIN IN CONSTANT CONTACT WITH THE PACE-SETTING SAFETY VEHICLES' NUMBERS TWO (2) AND THREE (3) LOCATION, THE CONTRACTOR SHALL HAVE THE TRAVEL LANES CLEARED, PRIOR TO SAFETY VEHICLES ARRIVAL, OF ALL EQUIPMENT AND DEBRIS IN ORDER TO REOPEN ALL TRAVEL LANES.
2. THE TWO (2) PACE-SETTING SAFETY VEHICLES NUMBERS TWO (2) AND THREE (3) SHALL CLEAR THE WORK AREA AND IMMEDIATELY MOVE TO THE RIGHT SHOULDER OR AN AREA DESIGNATED BY THE TRAFFIC CONTROL SUPERVISOR, AND TURN OFF THE FLASHING LIGHTS. ONCE THE TWO PACE-SETTING SAFETY VEHICLES NUMBERS TWO (2) AND THREE (3) PASS THE WORK AREA, THE TRAFFIC CONTROL SUPERVISOR SHALL INSTRUCT THE LEAD CONTRACTOR VEHICLE NUMBER ONE (1) AND THE LAW ENFORCEMENT VEHICLE NUMBER FOUR(4) TO TURN OFF THEIR FLASHING LIGHTS.

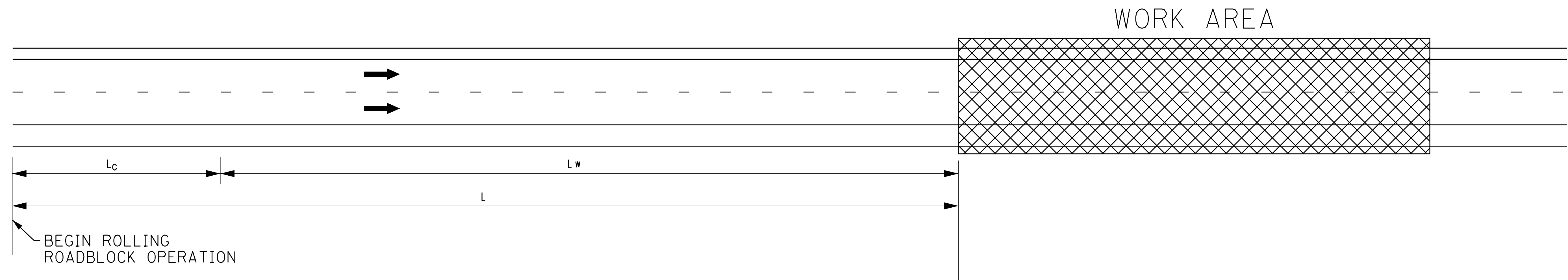

PACING DISTANCES, L (MILES)

Sp = 10 MPH			
SR	T _w (MIN.) 5	T _w (MIN.) 10	T _w (MIN.) 15
70	L= 0.97	1.94	2.92
65	L= 0.98	1.97	2.95
60	L= 1.00	2.00	3.00
55	L= 1.02	2.04	3.06
50	L= 1.04	2.08	3.13

Sp = 15 MPH			
SR	T _w (MIN.) 5	T _w (MIN.) 10	T _w (MIN.) 15
70	L= 1.59	3.18	4.77
65	L= 1.63	3.25	4.88
60	L= 1.67	3.33	5.00
55	L= 1.72	3.44	5.16
50	L= 1.79	3.57	5.36

Sp = 20 MPH			
SR	T _w (MIN.) 5	T _w (MIN.) 10	T _w (MIN.) 15
70	L= 2.33	4.67	7.00
65	L= 2.44	4.81	7.22
60	L= 2.50	5.00	7.50
55	L= 2.62	5.24	7.86
50	L= 2.78	5.56	8.33

S_R = REGULATORY SPEED, MPH

S_P = PACING SPEED, MPH

T_W = WORK DURATION, MINUTES

L = TOTAL PACING DISTANCE, MILES

$$= \frac{T_w}{60} S_p \left(\frac{S_p}{S_R - S_p} + 1 \right)$$

$$= L_c + L_w$$

L_C DISTANCE PACE-SETTING LAW ENFORCEMENT VEHICLES SHALL TRAVEL BEFORE THE VEHICLES AT REGULATORY SPEED HAVE CLEARED THE WORK AREA

$$= \frac{\left(\frac{T_w}{60} \times S_p^2 \right)}{S_R - S_p}$$

L_W DISTANCE PACE-SETTING LAW ENFORCEMENT VEHICLES TRAVEL WHILE CONSTRUCTION WORK IS PERFORMED

$$= \left(\frac{T_w}{60} \times S_p \right)$$

KENTUCKY TRANSPORTATION CABINET
 Department of Highways
DIVISION OF MAINTENANCE - PERMITS BRANCH

ROLLING ROADBLOCK
For Permitted Work on Fully Controlled Highways



SITE SPECIFIC ROLLING ROADBLOCK INFORMATION

APPLICANT COMPANY: _____

CONTACT NAME: _____

CONTACT PHONE#: _____

COUNTY: _____

ROUTE#: _____

MILE POINT OF WORK AREA: _____

NUMBER OF ROLLING ROADBLOCKS NEEDED (PER DIRECTION):

EASTBOUND/SOUTHBOUND _____ WESTBOUND/NORTHBOUND _____

WORK TIME REQUIRED FOR EACH ROLLING ROADBLOCK (T_w): _____ MINUTES

PACING SPEED OF ROLLING ROADBLOCK (S_p): _____ MPH

WORK DAY OF THE WEEK: _____

WORK STARTING TIME: _____ AM/PM

TRAFFIC CONTROL SUPERVISOR NAME: _____

CERTIFICATION#: _____

24 HR PHONE#: _____

LAW ENFORCEMENT CONTACT NAME: _____

COMPANY/DEPARTMENT NAME: _____

PHONE #: _____ CELL #: _____

MAINLINE ROLLING ROADBLOCK

BEGIN MP EASTBOUND/SOUTHBOUND: _____

PCMS POSITIONED AT MP EASTBOUND/SOUTHBOUND: _____

BEGIN MP WESTBOUND/NORTHBOUND: _____

PCMS POSITIONED AT MP WESTBOUND/NORTHBOUND: _____

LIST OF ALL ON-RAMPS AND MP EACH:

LIST OF CRITICAL EQUIPMENT REQUIRED TO COMPLETE WORK:

APPLICANT TRAFFIC CONTROL SUPERVISOR:

Printed Name

Work Zone Traffic Control Supervisor #:

Approval Signature

Date

KYTC TRAFFIC CONTROL SUPERVISOR:

Printed Name

Work Zone Traffic Control Supervisor #:

Approval Signature

Date

KENTUCKY TRANSPORTATION CABINET
Department of Highways
DIVISION OF MAINTENANCE - PERMITS BRANCH

ROLLING ROADBLOCK
For Permitted Work on Fully Controlled Highways

