



**CALL NO. 407**

**CONTRACT ID. 192913**

**LEWIS - FLEMING COUNTIES**

**FED/STATE PROJECT NUMBER 121GR19M067-FE02**

**DESCRIPTION DISTRICT 9 BRIDGE OVERLAYS.**

**WORK TYPE BRIDGE DECK RESTORATION & WATERPROOFING**

**PRIMARY COMPLETION DATE 11/15/2020**

**LETTING DATE: October 25,2019**

Sealed Bids will be received electronically through the Bid Express bidding service until 10:00 AM EASTERN DAYLIGHT TIME October 25,2019. Bids will be publicly announced at 10:00 AM EASTERN DAYLIGHT TIME.

**NO PLANS ASSOCIATED WITH THIS PROJECT.**

**REQUIRED BID PROPOSAL GUARANTY:** Not less than 5% of the total bid.

## TABLE OF CONTENTS

PART I	SCOPE OF WORK
	<ul style="list-style-type: none"><li>• PROJECT(S), COMPLETION DATE(S), &amp; LIQUIDATED DAMAGES</li><li>• CONTRACT NOTES</li><li>• STATE CONTRACT NOTES</li><li>• SPECIAL NOTE(S) APPLICABLE TO PROJECT</li><li>• LIQUIDATED DAMAGES</li><li>• TRAFFIC CONTROL PLAN</li><li>• SKETCH MAP(S)</li><li>• MATERIAL SUMMARY</li><li>• BRIDGE DRAWINGS</li></ul>
PART II	SPECIFICATIONS AND STANDARD DRAWINGS
	<ul style="list-style-type: none"><li>• SPECIFICATIONS REFERENCE</li><li>• SUPPLEMENTAL SPECIFICATION</li><li>• STANDARD DRAWINGS THAT APPLY</li></ul>
PART III	EMPLOYMENT, WAGE AND RECORD REQUIREMENTS
	<ul style="list-style-type: none"><li>• LABOR AND WAGE REQUIREMENTS</li><li>• EXECUTIVE BRANCH CODE OF ETHICS</li><li>• KENTUCKY EQUAL EMPLOYMENT OPPORTUNITY ACT OF 1978 LOCALITY / STATE</li><li>• PROJECT WAGE RATES / STATE FUNDED</li></ul>
PART IV	INSURANCE
PART V	BID ITEMS

**PART I**  
**SCOPE OF WORK**

### ADMINISTRATIVE DISTRICT - 09

**CONTRACT ID - 192913**

**121GR19M067-FE02**

**COUNTY - FLEMING**

**PCN - MB03500111901**

**FE02 035 0011 B00070N**

KY 11 (MP 0.019). BRIDGE OVER LICKING RIVER.BRIDGE DECK RESTORATION & WATERPROOFING  
GEOGRAPHIC COORDINATES LATITUDE 38:16:52.00 LONGITUDE 83:48:25.00

**PCN - MB03500321901**

**FE02 035 0032X B00078N**

KY 32X (MP 2.437). BRIDGE OVER FLEMING CREEK.BRIDGE DECK RESTORATION & WATERPROOFING  
GEOGRAPHIC COORDINATES LATITUDE 38:24:28.00 LONGITUDE 83:42:56.00

**PCN - MB03500321902**

**FE02 035 0032 B00079N**

KY 32 (MP 11.668). BRIDGE OVER FLEMING CREEK.BRIDGE DECK RESTORATION & WATERPROOFING  
GEOGRAPHIC COORDINATES LATITUDE 38:24:10.00 LONGITUDE 83:43:30.00

**PCN - MB03501701901**

**FE02 035 0170 B00066N**

KY 170 (MP 3.545). BRIDGE OVER FLEMING CREEK.BRIDGE DECK RESTORATION & WATERPROOFING  
GEOGRAPHIC COORDINATES LATITUDE 38:22:44.00 LONGITUDE 83:49:44.00

**COUNTY - LEWIS**

**PCN - MB06800091901**

**FE02 068 0009 B00038N**

KY 9 (MP 17.303). BRIDGE OVER BEN WILLEN BRANCH.BRIDGE DECK RESTORATION & WATERPROOFING  
GEOGRAPHIC COORDINATES LATITUDE 38:35:07.00 LONGITUDE 83:25:03.00

**PCN - MB06800091902**

**FE02 068 0009 B00099N**

KY 9 (MP 13.626). BRIDGE OVER SALT LICK CREEK.BRIDGE DECK RESTORATION & WATERPROOFING  
GEOGRAPHIC COORDINATES LATITUDE 38:35:09.00 LONGITUDE 83:21:14.00

**PCN - MB06800091903**

**FE02 068 0009 B00105N**

KY 9 (MP 4.259). BRIDGE OVER KINNICONICK CREEK.BRIDGE DECK RESTORATION & WATERPROOFING  
GEOGRAPHIC COORDINATES LATITUDE 38:32:43.00 LONGITUDE 83:13:15.00

**COMPLETION DATE(S):**

COMPLETED BY 11/15/2020	APPLIES TO ENTIRE CONTRACT
30 CALENDAR Days	APPLIES TO 035B00066N
30 CALENDAR Days	APPLIES TO 035B00070N
30 CALENDAR Days	APPLIES TO 035B00078N
30 CALENDAR Days	APPLIES TO 035B00079N
30 CALENDAR Days	APPLIES TO 068B00038N
30 CALENDAR Days	APPLIES TO 068B00099N
30 CALENDAR Days	APPLIES TO 068B00105N

## **CONTRACT NOTES**

### **PROPOSAL ADDENDA**

All addenda to this proposal must be applied when calculating bid and certified in the bid packet submitted to the Kentucky Department of Highways. Failure to use the correct and most recent addenda may result in the bid being rejected.

### **BID SUBMITTAL**

Bidder must use the Department's electronic bidding software. The Bidder must download the bid file located on the Bid Express website ([www.bidx.com](http://www.bidx.com)) to prepare a bid packet for submission to the Department. The bidder must submit electronically using Bid Express.

### **JOINT VENTURE BIDDING**

Joint venture bidding is permissible. All companies in the joint venture must be prequalified in one of the work types in the Qualifications for Bidders for the project. The bidders must get a vendor ID for the joint venture from the Division of Construction Procurement and register the joint venture as a bidder on the project. Also, the joint venture must obtain a digital ID from Bid Express to submit a bid. A joint bid bond of 5% may be submitted for both companies or each company may submit a separate bond of 5%.

### **UNDERGROUND FACILITY DAMAGE PROTECTION**

The contractor shall make every effort to protect underground facilities from damage as prescribed in the Underground Facility Damage Protection Act of 1994, Kentucky Revised Statute KRS 367.4901 to 367.4917. It is the contractor's responsibility to determine and take steps necessary to be in compliance with federal and state damage prevention directives. When prescribed in said directives, the contractor shall submit Excavation Locate Requests to the Kentucky Contact Center (KY811) via web ticket entry. The submission of this request does not relieve the contractor from the responsibility of contacting non-member facility owners, whom shall be contacted through their individual Protection Notification Center. Non-compliance with these directives can result in the enforcement of penalties.

### **REGISTRATION WITH THE SECRETARY OF STATE BY A FOREIGN ENTITY**

Pursuant to KRS 176.085(1)(b), an agency, department, office, or political subdivision of the Commonwealth of Kentucky shall not award a state contract to a person that is a foreign entity required by [KRS 14A.9-010](#) to obtain a certificate of authority to transact business in the Commonwealth ("certificate") from the Secretary of State under [KRS 14A.9-030](#) unless the person produces the certificate within fourteen (14) days of the bid or proposal opening. If the foreign entity is not required to obtain a certificate as provided in [KRS 14A.9-010](#), the foreign entity should identify the applicable exception. Foreign entity is defined within [KRS 14A.1-070](#).

**For all foreign entities required to obtain a certificate of authority to transact business in the Commonwealth, if a copy of the certificate is not received by the contracting agency within the time frame identified above, the foreign entity's solicitation response shall be deemed non-responsive or the awarded contract shall be cancelled.**

Businesses can register with the Secretary of State at <https://secure.kentucky.gov/sos/ftbr/welcome.aspx>.

### **SPECIAL NOTE FOR PROJECT QUESTIONS DURING ADVERTISEMENT**

Questions about projects during the advertisement should be submitted in writing to the Division of Construction Procurement. This may be done by fax (502) 564-7299 or email to [kytc.projectquestions@ky.gov](mailto:kytc.projectquestions@ky.gov). The Department will attempt to answer all submitted questions. The Department reserves the right not to answer if the question is not pertinent or does not aid in clarifying the project intent.

The deadline for posting answers will be 3:00 pm Eastern Daylight Time, the day preceding the Letting. Questions may be submitted until this deadline with the understanding that the later a question is submitted, the less likely an answer will be able to be provided.

The questions and answers will be posted for each Letting under the heading "Questions & Answers" on the Construction Procurement website ([www.transportation.ky.gov/contract](http://www.transportation.ky.gov/contract)). The answers provided shall be considered part of this Special Note and, in case of a discrepancy, will govern over all other bidding documents.

### **HARDWOOD REMOVAL RESTRICTIONS**

The US Department of Agriculture has imposed a quarantine in Kentucky and several surrounding states, to prevent the spread of an invasive insect, the emerald ash borer. Hardwood cut in conjunction with the project may not be removed from the state. Chipping or burning on site is the preferred method of disposal.

### **INSTRUCTIONS FOR EXCESS MATERIAL SITES AND BORROW SITES**

Identification of excess material sites and borrow sites shall be the responsibility of the Contractor. The Contractor shall be responsible for compliance with all applicable state and federal laws and may wish to consult with the US Fish and Wildlife Service to seek protection under Section 10 of the Endangered Species Act for these activities.

### **ACCESS TO RECORDS**

The contractor, as defined in KRS 45A.030 (9) agrees that the contracting agency, the Finance and Administration Cabinet, the Auditor of Public Accounts, and the Legislative Research Commission, or their duly authorized representatives, shall have access to any books, documents, papers, records, or other evidence, which are directly pertinent to this contract for the purpose of financial audit or program review. Records and other prequalification information confidentially

disclosed as part of the bid process shall not be deemed as directly pertinent to the contract and shall be exempt from disclosure as provided in KRS 61.878(1)(c). The contractor also recognizes that any books, documents, papers, records, or other evidence, received during a financial audit or program review shall be subject to the Kentucky Open Records Act, KRS 61.870 to 61.884.

In the event of a dispute between the contractor and the contracting agency, Attorney General, or the Auditor of Public Accounts over documents that are eligible for production and review, the Finance and Administration Cabinet shall review the dispute and issue a determination, in accordance with Secretary's Order 11-004.

April 30, 2018

## **SPECIAL NOTE FOR RECIPROCAL PREFERENCE**

### **RECIPROCAL PREFERENCE TO BE GIVEN BY PUBLIC AGENCIES TO RESIDENT BIDDERS**

By reference, KRS 45A.490 to 45A.494 are incorporated herein and in compliance regarding the bidders residency. Bidders who want to claim resident bidder status should complete the Affidavit for Claiming Resident Bidder Status along with their bid in the electronic bidding software. Submittal of the Affidavit should be done along the bid in Bid Express.

April 30, 2018



## **SPECIAL NOTE FOR BRIDGE RESTORATION AND WATERPROOFING WITH CONCRETE OVERLAYS**

- I. DESCRIPTION.** Perform all work in accordance with the Kentucky Transportation Cabinet, Department of Highway's 2019 Standard Specifications for Road and Bridge Construction and applicable Supplemental Specifications, the Standard Drawings, this Note, and the attached detail drawings. Section references are to the Standard Specifications.

This work consists of the following: (1) Furnish all labor, materials, tools, and equipment; (2) Remove the existing overlay or machine prep the existing slab; (3) Complete full-depth and partial depth repairs as directed by the Engineer; (4) Repair/replace damaged and corroded reinforcing bars; (5) Place new concrete overlay and epoxy-sand slurry in accordance with Section 606; (6) Complete asphalt approach pavement; (7) Maintain and control traffic; and (8) Any other work specified as part of this contract.

All construction will be in accordance with Section 606 unless otherwise specified.

**II. MATERIALS.**

- A. Latex Concrete.** See Section 606.03.17.
- B. Class "M" Concrete.** Use either "M1" or "M2". See Section 601.
- C. Bituminous Asphalt.** Use CL2 ASPH SURF 0.38D PG64-22.
- D. Epoxy-Sand Slurry.** See Section 606.03.10.

**III. CONSTRUCTION.**

- A. Machine prep of existing slab.** For all bridges in this contract except 068B00038N, remove concrete from existing slab to a depth of at least ¼" below the existing surface, and remove all patches completely, in accordance with the requirements of Section 606.03.03.
- B. Remove Existing Overlay.** In addition to Section 606.03.03, totally remove the existing concrete overlay for 068B00038N by milling.
- C. Partial Depth Slab Repair and Latex Overlay.** Remove areas determined to be unsound by the Engineer via hydrodemolition or via hand held jackhammers weighing less than 45lbs in accordance with Section 606.02.10 D. Repair/Replace all damaged or severely corroded reinforcing bars prior to partial depth repair operation. The Department will not measure material removal and will consider this work incidental to the bid item "PARTIAL DEPTH PATCHING". Mix and place Latex Modified Concrete Overlay in accordance with Sections 606.03.08 and 606.03.17.
- D. Asphalt Approach Pavement.** Mill each existing asphalt approach for a distance of 50' for 068B00038N, and 100' for all other bridges in this contract, from the bridge ends. Remove the bituminous material uniformly by making an edge key, so as to provide a smooth transition to the finished bridge when a new bituminous overlay of compacted depth of approximately 1½" is added to the approaches. The grinding depth may vary depending of the condition of the existing approach and final elevation of bridge end. Dispose of all removed material away from the site.

**E. Surface Texturing.** Texture the concrete surface of the overlay in accordance with Section 609.03.10.

**IV. MEASUREMENT.** See Section 606 and the following:

**A. Latex Modified Concrete for Concrete Overlay.** The Department will measure the quantity in cubic yards using the theoretical volume as follows for each bridge:

035B00066N	(194'x28'x1.50")	= 25.1 cuyd
035B00070N	(414'x44'x1.50")	= 84.3 cuyd
035B00078N	(177'x40'x1.50")	= 32.8 cuyd
035B00079N	(204'x30'x1.50")	= 28.3 cuyd
068B00038N	(87'x44'x1.50")	= 17.7 cuyd
068B00099N	(243'x44'x1.50")	= 49.5 cuyd
068B00105N	(403'x44'x1.50")	= 82.1 cuyd

**B. Latex Modified Concrete for Partial Depth Patching and variable thickness of Overlay.** The Department will measure the quantity in cubic yards by deducting the theoretical volume of bridge deck overlay (LMC) from the total volume (as indicated by the batch quantity tickets) of Concrete required to obtain the finished grade shown on the Plans or established by the Engineer.

**C. Machine Prep of Slab.** The Department will measure the machine preparation of the existing bridge deck for all bridges except 068B00038N in square yards, which shall include all labor, equipment, and material needed to complete this work.

**D. Remove Existing Overlay.** The Department will measure the removal of the existing overlay for 068B00038N in square yards, which shall include all labor, equipment, and material needed to complete this work.

**E. Steel Reinforcement.** The Department will measure any reinforcing steel necessary for the partial or full depth patch in pounds, which shall include all labor, equipment, and material needed to complete this work.

**F. Asphalt Approach Pavement.** The Department will measure the quantity in square yards, which shall include all labor, equipment, and material needed to complete this work.

**V. PAYMENT.** See Section 606 and the following:

**A. Latex Modified Concrete for Overlay.** The Department will make payment for the Latex Modified Concrete under bid item #08534 "CONCRETE OVERLAY – LATEX" for the quantity in cubic yards complete in place.

**B. Latex Modified Concrete for Partial Depth Patching and variable thickness of Overlay.** The Department will make payment for the Partial Depth Patching under bid item #24094EC "PARTIAL DEPTH PATCHING". Payment will be for the quantity per cubic yard complete in place.

**C. Machine Prep of Slab.** The Department will make payment for the machine prep of existing slab for all bridges except 068B00038N, under bid item #08551 "MACHINE PREP OF SLAB". Payment will be for the square yard complete.

- D. Remove Existing Overlay.** The Department will make payment for the removal of the existing overlay for 068B00038N under the bid item #08510 "REM EPOXY BIT FOREIGN OVERLAY". Payment will be for the square yard complete.
- E. Steel Reinforcement.** The Department will make payment for steel reinforcement, if necessary, under bid item #08150 "STEEL REINFORCEMENT". Payment will be at the unit price per pound.
- F. Asphalt Approach Pavement.** The Department will make payment for the completed and accepted quantity of this work under the bid item #03304 "BRIDGE OVERLAY APPROACH PAVEMENT".

## **SPECIAL NOTE FOR REPLACING EXPANSION DAMS AND/OR INSTALLING ARMORED EDGES FOR CONCRETE ON BRIDGES**

**I. DESCRIPTION.** Perform all work in accordance with the Kentucky Transportation Cabinet, Department of Highway's 2019 Standard Specifications for Road and Bridge Construction and applicable Supplemental Specifications, the Standard Drawings, this Note, and the attached detail drawings. Section references are to the Standard Specifications.

This work consists of the following: (1) Furnish all labor, materials, tools, and equipment; (2) Remove existing concrete and expansion device(s) and/or bridge ends; (3) Install armored edges and new concrete as specified and in accordance with the attached detail drawings; (4) Install new joint seals (where required); (5) Maintain and control traffic; and (6) Any other work specified as part of this contract.

### **II. MATERIALS.**

**A. Class "M" Concrete.** Use either "M1" or "M2". See Section 601.

**B. Structural Steel.** Use new, commercial grade steel suitable for welding. The Engineer will base acceptance on visual inspection. For armored edges that make up the 4" neoprene joint, use Steelflex Strip Seal expansion joint by DS Brown, or approved equal. To be approved, armored edge extrusions must be embedded.

**C. Stud Anchors.** The armored edge stud anchors are 3/4" x 6" embedded stud shear connectors conforming to ASTM A108, Grade 1015 (Nelson Studs or equal).

**D. Steel Reinforcement.** Use Grade 60. See Section 602.

**E. Epoxy Bond Coat.** See Section 511.

**F. Pre-Compressed Horizontal Expansion Joint System.** It shall have a cellular, or micro-cell, polyurethane foam impregnated with a hydrophobic acrylic emulsion, or a hydrophobic polymer. The polyurethane foam external facing shall be factory coated and cured with highway-grade, fuel resistant silicone or a highway-grade elastomeric coating at a width greater than the maximum joint expansion.

**G. Neoprene Strip Seals.** See attached detail drawings and Section 807.

### **III. EQUIPMENT.**

**A. Hammers.** See Section 606.02.10 B.

**B. Sawing Equipment.** See Section 606.02.10 C.

**C. Hydraulic Impact Equipment.** See Section 606.02.10 D.

### **IV. CONSTRUCTION.**

**A. Remove Existing Materials.** Remove existing Expansion Dam, Bridge End, Armored Edges and specified areas of concrete as shown on the attached sketches. Remove debris and/or expansion joint filler as directed by the Engineer. . Clean and leave all existing steel reinforcement encountered in place. Damaged steel reinforcement will be repaired/replaced as directed by the Engineer at no additional cost to the Department.

Dispose of all removed material entirely away from the job site. This work is incidental to the contract unit price for "Expansion Joint Replacement" or "Armored Edge for Concrete".

**B. Place New Concrete and Armored Edges.** After all specified existing materials have been removed; place new armored edges to match the grade of the proposed overlay or to match the original grade (See attached detail drawings). Place the new Class "M" concrete to the scarified grade and finish to receive the new overlay or place the new Class "M" concrete to the original grade and finish with broom strokes drawn transversely from curb to curb.

All new structural steel shall be cleaned and painted in accordance with requirements of Section 607.03.23, except that surfaces to come in contact with concrete are not to be painted.

Blast clean all areas of existing concrete and structural steel to come in contact with new concrete until free of all laitance and deleterious substances immediately prior to the placement of the Class "M" Concrete. The surface areas of existing concrete to come in contact with the new Class "M" Concrete are to be coated with an epoxy bond coat immediately prior to placing new concrete in accordance with Section 511. The interfaces of the new and old concrete shall be as nearly vertical and horizontal as possible.

**C. Additional Steel Reinforcement.** Furnish for replacement, as directed by the Engineer, 2800 linear feet of #4 steel reinforcing bars in 20' lengths. Place these bars in areas deemed by the Engineer to require additional reinforcement. Field cutting and bending is permitted. Do not place any additional steel reinforcement above the height of the top row of Nelson Studs on the armored edges. Ensure that all exposed steel reinforcement is tied in accordance with Section 602.03.04 prior to pouring the new Class "M" concrete. Deliver unused bars to the Local County Maintenance Barn. Payment will be made in accordance with Section 602.

**D. Stage Construction.** Installation of concrete and armored edges in two (or more if specified) stages is necessary. Join the armored edges at or near the centerline of the roadway or lane line, field weld and grind smooth.

**E. Pre-Compressed Horizontal Expansion Joint System.** System shall be supplied in pre-compressed sticks for easy installation. System shall be installed in accordance with manufacturer's recommendations concerning approved adhesives, welds between sticks and appurtenances, and adhesion to concrete deck or armored edges. Joint seal is to be installed 1/2" recessed from the surface.

**G. Preformed Neoprene Strip Seal.** Place the preformed joint seal in one continuous, unbroken length. Place neoprene strip seals as recommended by the manufacturer and in accordance with Section 609.03.04

**F. Shop Plans.** Shop plans will not be required. The Contractor is responsible for obtaining field measurements and supplying properly sized materials to complete the work.

## V. MEASUREMENT.

**A. Expansion Joint Replacement – 2", 4".** The Department will measure the quantity in linear feet from gutterline to gutterline along the centerline of the joint.

**B. Armored Edge for Concrete.** The Department will measure the quantity in linear feet from gutterline to gutterline along the face of the bridge end.

**C. Steel Reinforcement.** See Section 602.

**VI. PAYMENT.**

- A. Expansion Joint Replacement – 2", 4".** Payment at the contract unit price per linear foot is full compensation for removing specified existing materials, furnishing and installing the new armored edges, concrete, neoprene strip seal or pre-compressed horizontal expansion joint system, and all incidental items necessary to complete the work (except the overlay material) within the specified pay limits as specified by this note and as shown on the attached detail drawings.
- B. Armored Edge for Concrete.** Payment at the contract unit price per linear foot is full compensation for removing specified existing materials, furnishing and installing the new armored edges, concrete and all incidental items necessary to complete the work (except the overlay material) within the specified pay limits as specified by this note and as shown on the attached detail drawings.
- C. Steel Reinforcement.** See Section 602.

### **SPECIAL NOTE FOR CONTRACT COMPLETION DATE AND LIQUIDATED DAMAGES ON BRIDGE REPAIR CONTRACTS**

- I. COMPLETION DATE.** The Contractor has the option of selecting the starting date for this Contract. Once selected, notify the Department in writing of the date selected at least two weeks prior to beginning work. All work is to be completed by November 15, 2020. An allotted number of Calendar days are assigned to each structure in this contract as shown below.

<u>STRUCTURE</u>	<u>NO. OF CALENDAR DAYS</u>	<u>COMPLETION DATE</u>
035B00066N	30	November 15, 2020
035B00070N	30	November 15, 2020
035B00078N	30	November 15, 2020
035B00079N	30	November 15, 2020
068B00038N	30	November 15, 2020
068B00099N	30	November 15, 2020
068B00105N	30	November 15, 2020

Contrary to Section 108.07.02, the Engineer will begin charging calendar days for a structure on the day the Contractor starts work or sets up traffic control on that particular structure.

- II. LIQUIDATED DAMAGES.** Liquidated damages will be assessed the Contractor in accordance with the Transportation Cabinet, Department of Highway's 2019 Standard Specifications for Road and Bridge Construction, Section 108.09, when either the allotted number of calendar days or the November 15, 2020 date is exceeded.

Contrary to the Standard Specifications, liquidated damages will be assessed the Contractor during the months of December, January, February and March when the contract time has expired on any individual bridge or bridges. Contract time will be charged during these months.

All construction must be completed in accordance with the weather limitations specified in Section 606 and/or Section 601 as applicable. No extension of Contract time will be granted due to inclement weather or temperature limitations that occur due to starting work on the Contract or a structure late in the construction season.

## **SPECIAL NOTE FOR TRAFFIC CONTROL ON BRIDGE REPAIR CONTRACTS**

### **I. TRAFFIC CONTROL GENERAL**

Except as provided herein, traffic shall be maintained in accordance with the 2019 Standard Specifications, Section 112. Except for the roadway and traffic control bid items listed, all items of work necessary to maintain and control traffic will be paid at the lump sum bid price to “Maintain and Control Traffic”.

Contrary to Section 106.01, traffic control devices used on this project may be new or used in new condition, at the beginning of the work and maintained in like new condition until completion of the work.

### **II. TRAFFIC COORDINATOR**

Furnish a Traffic Coordinator as per Section 112. The Traffic Coordinator shall inspect the project maintenance of traffic, at least three times daily, or as directed by the Engineer, during the Contractor’s operations and at any time a lane closure is in place. The personnel shall have access on the project to a radio or telephone to be used in case of emergencies or accidents.

The Traffic Coordinator shall report all incidents throughout the work zone to the Engineer on the project. The Contractor shall furnish the name and telephone number where the Traffic Coordinator can be contacted at all times.

### **III. SIGNS**

Contrary to Section 112.04.02, only long term signs (sign intended to be continuously in place for more than 3 days) will be measured for payment; short term signs (signs intended to be left in place for 3 days or less) will not be measured for payment but will be incidental to Maintain and Control Traffic.

The contractor is to install warning signs for wide loads in advance of the bridge under the direction of the Engineer. The Department will not measure installation, maintenance, or removal for payment, and will consider these incidentals to Maintain and Control Traffic.

### **IV. TEMPORARY PAVEMENT STRIPING**

Skip lines and/or solid lines through the length of the tapers for lane closures and other striping as directed by the Engineer shall be temporarily covered with 6” black removable tape. Permanent removal of all other pavement striping for traffic control shall be considered incidental to Maintain and Control Traffic. Temporary pavement striping shall be paid only once per course in accordance with Section 112.04.07. The Contractor shall replace any temporary striping that becomes damaged or fails to adhere to the pavement before dark on the day of the notification. Liquidated damages shall be assessed to the Contractor at a rate of \$500 per day for failing to replace temporary striping within this time limit.



## **V. PROJECT PHASING & CONSTRUCTION PROCEDURES**

Maintain one lane of traffic during construction in accordance with Standard Drawing No. TTC-110 for lane closures, and the attached detail drawing. The minimum clear lane width required is as follows:

035B00066N	13'-0"
035B00070N	13'-0"
035B00078N	13'-0"
035B00079N	13'-0"
068B00038N	13'-0"
068B00099N	13'-0"
068B00105N	13'-0"

## **VI. TEMPORARY SIGNAL**

Provide, install, and maintain a temporary 2 phase traffic signal. The Contractor must provide a 24-hour contact person and number available to maintain the temporary signals as needed.

# FLEMING AND LEWIS COUNTIES

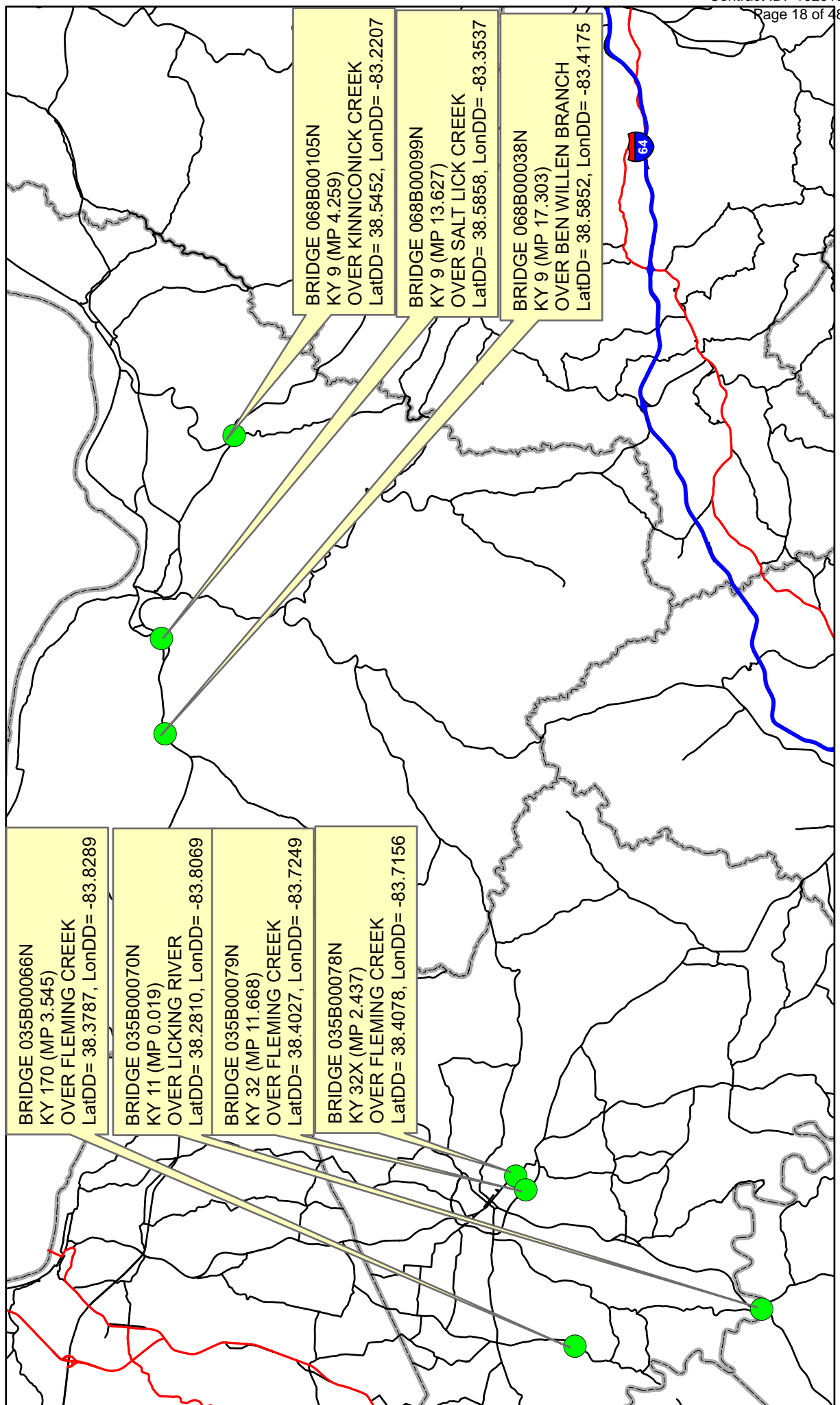
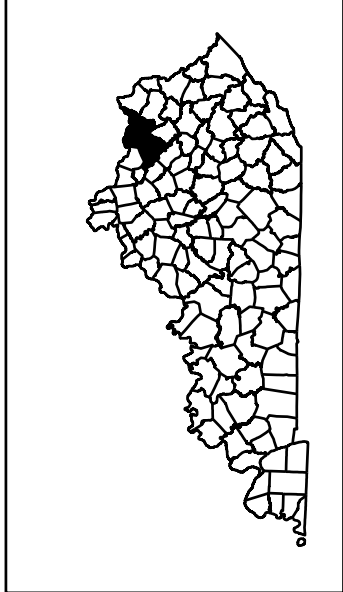

# MATERIAL SUMMARY

CONTRACT ID: 192913121GR19M067-FE02MB03500111901

KY 11 (MP 0.019). BRIDGE OVER LICKING RIVER. BRIDGE DECK RESTORATION &amp; WATERPROOFING.

Project Line No	Bid Code	DESCRIPTION	Quantity	Unit
0005	02562	TEMPORARY SIGNS	149.00	SQFT
0010	02650	MAINTAIN & CONTROL TRAFFIC - APPLIES TO 035B00070N	1.00	LS
0015	02653	LANE CLOSURE	2.00	EACH
0020	03298	EXPAN JOINT REPLACE 4 IN	89.20	LF
0025	03299	ARMORED EDGE FOR CONCRETE	89.20	LF
0030	03304	BRIDGE OVERLAY APPROACH PAVEMENT	978.00	SQYD
0035	04933	TEMP SIGNAL 2 PHASE	1.00	EACH
0040	06514	PAVE STRIPING-PERM PAINT-4 IN	2,456.00	LF
0045	06549	PAVE STRIPING-TEMP REM TAPE-B	500.00	LF
0050	06550	PAVE STRIPING-TEMP REM TAPE-W	1,000.00	LF
0055	06551	PAVE STRIPING-TEMP REM TAPE-Y	2,000.00	LF
0060	08150	STEEL REINFORCEMENT	267.20	LB
0065	08504	EPOXY SAND SLURRY	92.00	SQYD
0070	08526	CONC CLASS M FULL DEPTH PATCH	6.00	CUYD
0075	08534	CONCRETE OVERLAY-LATEX	84.30	CUYD
0080	08549	BLAST CLEANING	2,116.00	SQYD
0085	08551	MACHINE PREP OF SLAB	2,024.00	SQYD
0090	24094EC	PARTIAL DEPTH PATCHING	56.20	CUYD
0095	02569	DEMOBILIZATION	1.00	LS

# MATERIAL SUMMARY

**CONTRACT ID: 192913**

**121GR19M067-FE02**

**MB03500321901**

KY 32X (MP 2.437). BRIDGE OVER FLEMING CREEK. BRIDGE DECK RESTORATION & WATERPROOFING.

Project Line No	Bid Code	DESCRIPTION	Quantity	Unit
0195	02562	TEMPORARY SIGNS	149.00	SQFT
0200	02650	MAINTAIN & CONTROL TRAFFIC - APPLIES TO 035B00078N	1.00	LS
0205	02653	LANE CLOSURE	2.00	EACH
0210	03295	EXPAN JOINT REPLACE 2 IN	92.40	LF
0215	03299	ARMORED EDGE FOR CONCRETE	92.40	LF
0220	03304	BRIDGE OVERLAY APPROACH PAVEMENT	889.00	SQYD
0225	04933	TEMP SIGNAL 2 PHASE	1.00	EACH
0230	06514	PAVE STRIPING-PERM PAINT-4 IN	1,508.00	LF
0235	06549	PAVE STRIPING-TEMP REM TAPE-B	500.00	LF
0240	06550	PAVE STRIPING-TEMP REM TAPE-W	1,000.00	LF
0245	06551	PAVE STRIPING-TEMP REM TAPE-Y	2,000.00	LF
0250	08150	STEEL REINFORCEMENT	267.20	LB
0255	08504	EPOXY SAND SLURRY	39.30	SQYD
0260	08526	CONC CLASS M FULL DEPTH PATCH	6.00	CUYD
0265	08534	CONCRETE OVERLAY-LATEX	32.80	CUYD
0270	08549	BLAST CLEANING	826.00	SQYD
0275	08551	MACHINE PREP OF SLAB	787.00	SQYD
0280	24094EC	PARTIAL DEPTH PATCHING	21.90	CUYD
0285	02569	DEMOBILIZATION	1.00	LS

# MATERIAL SUMMARY

**CONTRACT ID: 192913**

**121GR19M067-FE02**

**MB03500321902**

KY 32 (MP 11.668). BRIDGE OVER FLEMING CREEK. BRIDGE DECK RESTORATION & WATERPROOFING.

Project Line No	Bid Code	DESCRIPTION	Quantity	Unit
0290	02562	TEMPORARY SIGNS	149.00	SQFT
0295	02650	MAINTAIN & CONTROL TRAFFIC - APPLIES TO 035B00079N.	1.00	LS
0300	02653	LANE CLOSURE	2.00	EACH
0305	03295	EXPAN JOINT REPLACE 2 IN	60.00	LF
0310	03299	ARMORED EDGE FOR CONCRETE	60.00	LF
0315	03304	BRIDGE OVERLAY APPROACH PAVEMENT	667.00	SQYD
0320	04933	TEMP SIGNAL 2 PHASE	1.00	EACH
0325	06514	PAVE STRIPING-PERM PAINT-4 IN	941.00	LF
0330	06549	PAVE STRIPING-TEMP REM TAPE-B	500.00	LF
0335	06550	PAVE STRIPING-TEMP REM TAPE-W	1,000.00	LF
0340	06551	PAVE STRIPING-TEMP REM TAPE-Y	2,000.00	LF
0345	08150	STEEL REINFORCEMENT	267.20	LB
0350	08504	EPOXY SAND SLURRY	45.30	SQYD
0355	08526	CONC CLASS M FULL DEPTH PATCH	6.00	CUYD
0360	08534	CONCRETE OVERLAY-LATEX	28.30	CUYD
0365	08549	BLAST CLEANING	725.00	SQYD
0370	08551	MACHINE PREP OF SLAB	680.00	SQYD
0375	24094EC	PARTIAL DEPTH PATCHING	18.90	CUYD
0380	02569	DEMOBILIZATION	1.00	LS

# MATERIAL SUMMARY

CONTRACT ID: 192913121GR19M067-FE02MB03501701901

KY 170 (MP 3.545). BRIDGE OVER FLEMING CREEK. BRIDGE DECK RESTORATION &amp; WATERPROOFING.

Project Line No	Bid Code	DESCRIPTION	Quantity	Unit
0100	02562	TEMPORARY SIGNS	149.00	SQFT
0105	02650	MAINTAIN & CONTROL TRAFFIC - APPLIES TO 035B00066N	1.00	LS
0110	02653	LANE CLOSURE	2.00	EACH
0115	03295	EXPAN JOINT REPLACE 2 IN	58.00	LF
0120	03299	ARMORED EDGE FOR CONCRETE	58.00	LF
0125	03304	BRIDGE OVERLAY APPROACH PAVEMENT	622.00	SQYD
0130	04933	TEMP SIGNAL 2 PHASE	1.00	EACH
0135	06514	PAVE STRIPING-PERM PAINT-4 IN	1,312.00	LF
0140	06549	PAVE STRIPING-TEMP REM TAPE-B	500.00	LF
0145	06550	PAVE STRIPING-TEMP REM TAPE-W	1,000.00	LF
0150	06551	PAVE STRIPING-TEMP REM TAPE-Y	2,000.00	LF
0155	08150	STEEL REINFORCEMENT	267.20	LB
0160	08504	EPOXY SAND SLURRY	143.70	SQYD
0165	08526	CONC CLASS M FULL DEPTH PATCH	6.00	CUYD
0170	08534	CONCRETE OVERLAY-LATEX	25.10	CUYD
0175	08549	BLAST CLEANING	747.00	SQYD
0180	08551	MACHINE PREP OF SLAB	604.00	SQYD
0185	24094EC	PARTIAL DEPTH PATCHING	16.80	CUYD
0190	02569	DEMOBILIZATION	1.00	LS

# MATERIAL SUMMARY

**CONTRACT ID: 192913**

**121GR19M067-FE02**

**MB06800091901**

KY 9 (MP 17.303). BRIDGE OVER BEN WILLEN BRANCH. BRIDGE DECK RESTORATION & WATERPROOFING.

Project Line No	Bid Code	DESCRIPTION	Quantity	Unit
0385	02562	TEMPORARY SIGNS	149.00	SQFT
0390	02650	MAINTAIN & CONTROL TRAFFIC - APPLIES TO 068B00038N	1.00	LS
0395	02653	LANE CLOSURE	2.00	EACH
0400	03299	ARMORED EDGE FOR CONCRETE	88.00	LF
0405	03304	BRIDGE OVERLAY APPROACH PAVEMENT	1.00	SQYD
0410	04933	TEMP SIGNAL 2 PHASE	1.00	EACH
0415	06514	PAVE STRIPING-PERM PAINT-4 IN	436.00	LF
0420	06549	PAVE STRIPING-TEMP REM TAPE-B	500.00	LF
0425	06550	PAVE STRIPING-TEMP REM TAPE-W	1,000.00	LF
0430	06551	PAVE STRIPING-TEMP REM TAPE-Y	2,000.00	LF
0435	08150	STEEL REINFORCEMENT	267.20	LB
0440	08504	EPOXY SAND SLURRY	49.90	SQYD
0445	08510	REM EPOXY BIT FOREIGN OVERLAY	425.00	SQYD
0450	08534	CONCRETE OVERLAY-LATEX	17.70	CUYD
0455	08549	BLAST CLEANING	475.00	SQYD
0460	24094EC	PARTIAL DEPTH PATCHING	11.80	CUYD
0465	02569	DEMOBILIZATION	1.00	LS

# MATERIAL SUMMARY

**CONTRACT ID: 192913**

**121GR19M067-FE02**

**MB06800091902**

KY 9 (MP 13.626). BRIDGE OVER SALT LICK CREEK. BRIDGE DECK RESTORATION & WATERPROOFING.

Project Line No	Bid Code	DESCRIPTION	Quantity	Unit
0470	02562	TEMPORARY SIGNS	149.00	SQFT
0475	02650	MAINTAIN & CONTROL TRAFFIC - APPLIES TO 068B00099N	1.00	LS
0480	02653	LANE CLOSURE	2.00	EACH
0485	03299	ARMORED EDGE FOR CONCRETE	88.00	LF
0490	03304	BRIDGE OVERLAY APPROACH PAVEMENT	489.00	SQYD
0495	04933	TEMP SIGNAL 2 PHASE	1.00	EACH
0500	06514	PAVE STRIPING-PERM PAINT-4 IN	1,032.00	LF
0505	06549	PAVE STRIPING-TEMP REM TAPE-B	500.00	LF
0510	06550	PAVE STRIPING-TEMP REM TAPE-W	1,000.00	LF
0515	06551	PAVE STRIPING-TEMP REM TAPE-Y	2,000.00	LF
0520	08150	STEEL REINFORCEMENT	267.20	LB
0525	08504	EPOXY SAND SLURRY	54.00	SQYD
0530	08551	MACHINE PREP OF SLAB	1,188.00	SQYD
0535	08534	CONCRETE OVERLAY-LATEX	49.50	CUYD
0540	08549	BLAST CLEANING	1,242.00	SQYD
0545	24094EC	PARTIAL DEPTH PATCHING	33.00	CUYD
0550	02569	DEMOBILIZATION	1.00	LS



# MATERIAL SUMMARY

**CONTRACT ID: 192913**

**121GR19M067-FE02**

**MB06800091903**

KY 9 (MP 4.259). BRIDGE OVER KINNICONICK CREEK. BRIDGE DECK RESTORATION & WATERPROOFING.

Project Line No	Bid Code	DESCRIPTION	Quantity	Unit
0555	02562	TEMPORARY SIGNS	149.00	SQFT
0560	02650	MAINTAIN & CONTROL TRAFFIC - APPLIES TO 068B00105N	1.00	LS
0565	02653	LANE CLOSURE	2.00	EACH
0570	03299	ARMORED EDGE FOR CONCRETE	88.00	LF
0575	03304	BRIDGE OVERLAY APPROACH PAVEMENT	489.00	SQYD
0580	04933	TEMP SIGNAL 2 PHASE	1.00	EACH
0585	06514	PAVE STRIPING-PERM PAINT-4 IN	2,008.00	LF
0590	06549	PAVE STRIPING-TEMP REM TAPE-B	500.00	LF
0595	06550	PAVE STRIPING-TEMP REM TAPE-W	1,000.00	LF
0600	06551	PAVE STRIPING-TEMP REM TAPE-Y	2,000.00	LF
0605	08150	STEEL REINFORCEMENT	267.20	LB
0610	08504	EPOXY SAND SLURRY	89.60	SQYD
0615	08534	CONCRETE OVERLAY-LATEX	82.10	CUYD
0620	08549	BLAST CLEANING	2,060.00	SQYD
0625	08551	MACHINE PREP OF SLAB	1,970.00	SQYD
0630	24094EC	PARTIAL DEPTH PATCHING	54.70	CUYD
0635	02569	DEMOBILIZATION	1.00	LS

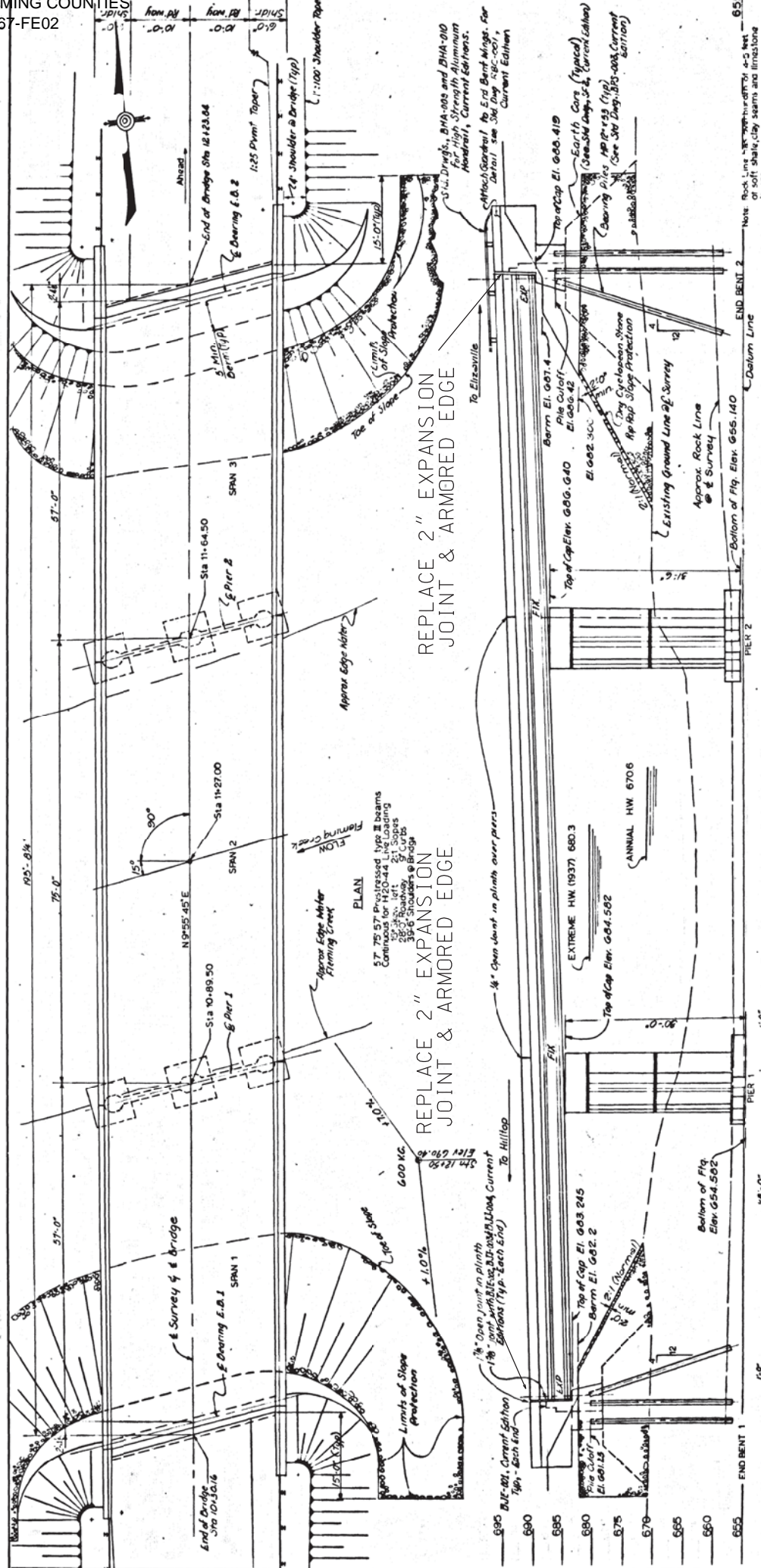

035B00066N

Sheet 3  
**COMMONWEALTH OF KENTUCKY**  
 DEPARTMENT OF HIGHWAYS  
 FRANKFORT  
 COUNTY OF  
**FLEMING**  
 HILLTOP-HELENA  
 ROAD  
 STATION 11+27.00  
 P. E. PROJECT NO. 18733  
 CONSTRUCTION PROJECT NO. 18733

LAYOUT

TYPICAL SECTION THRU DECK  
 Type III Prestressed Girders

ELEVATION

Note: Rock Line is approximate. If it is not at soft shale, clay seams and limestone layers.

LETTERING DATE



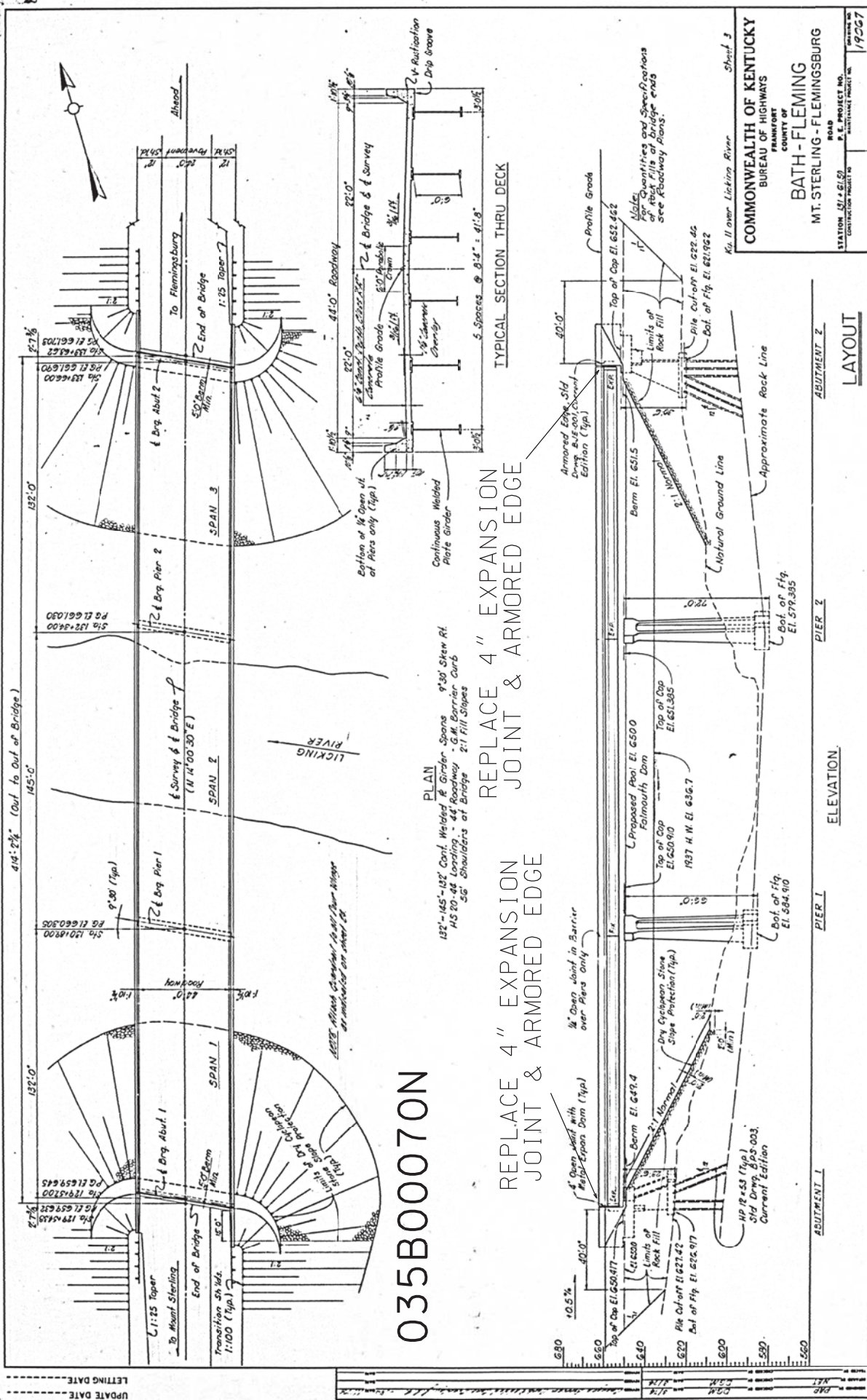

035B00070N

REPLACE 4" EXPANSION  
JOINT & ARMORED EDGE

TYPICAL SECTION THRU DECK

PLAN  
182'-145'-182' Cont. Welded #6 Girder Spans  
145'-20'-48' Loading - 44' Roadway - 6" M. Barrier Curb  
56' Shoulders at Bridge 2:1 Fill Slopes

ELEVATION  
PIER I  
PIER II  
PIER III  
ABUTMENT I  
ABUTMENT II  
ABUTMENT III

COMMONWEALTH OF KENTUCKY  
BUREAU OF HIGHWAYS  
FRANKFORT  
COUNTY OF  
BATH - FLEMING  
MT. STERLING - FLEMINGSBURG  
ROAD  
STATION 471+61.57  
CONSTRUCTION PROJECT NO. 192913

UPDATE DATE  
LETTING DATE

DATE	BY	CHK	APP



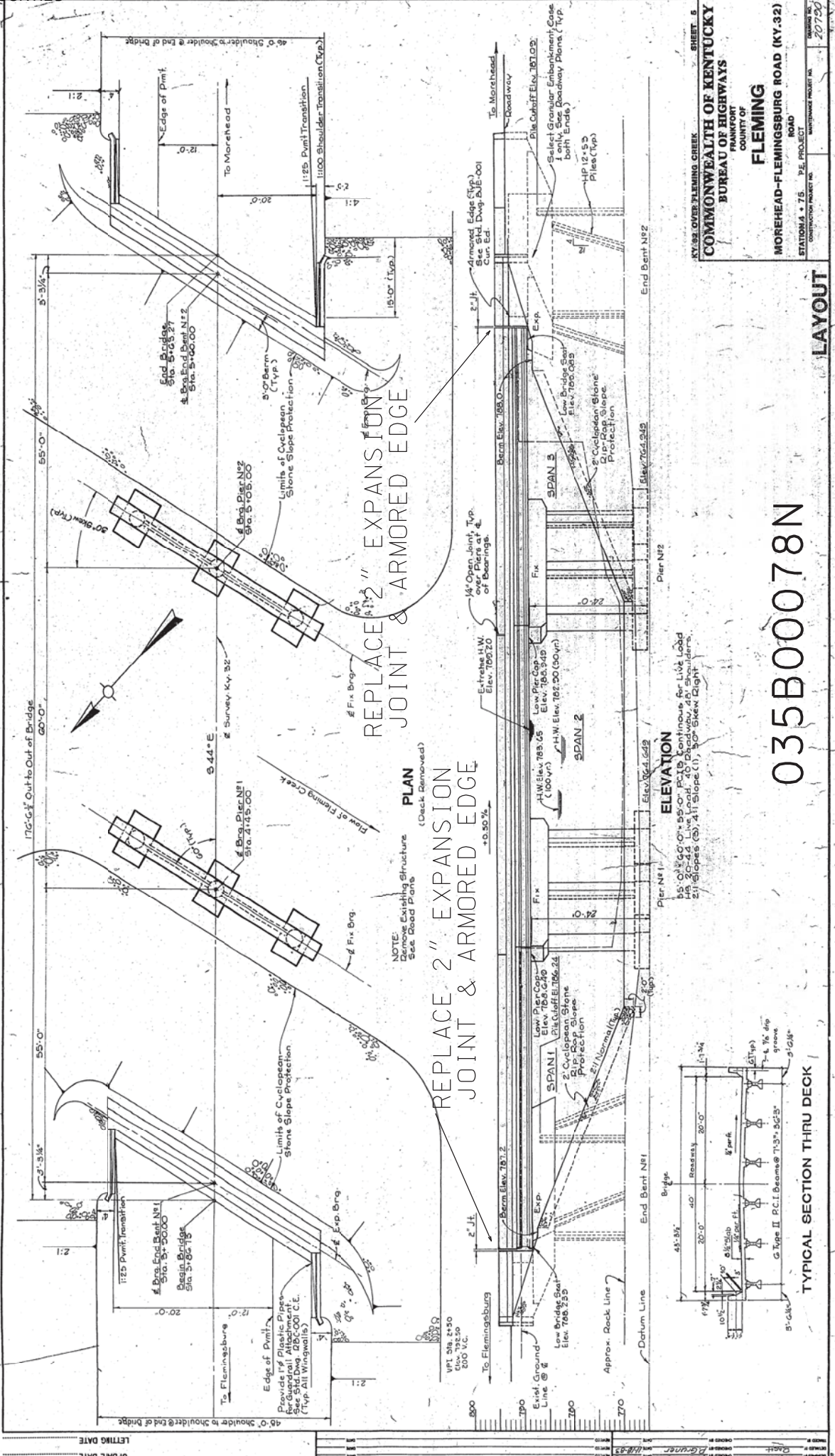

KY 82 OVER FLEMING CREEK  
**COMMONWEALTH OF KENTUCKY**  
 BUREAU OF HIGHWAYS  
 COUNTY OF FRANKFORT  
**FLEMING**  
 MOREHEAD-FLEMINGSBURG ROAD (KY 32)  
 STATION 75 + 75.00 PROJECT  
 CONTRACT NUMBER 035B00078N  
 SHEET 5  
 20750

035B00078N

LAYOUT

TYPICAL SECTION THRU DECK

DESIGNED BY	DATE	BY
CHECKED BY	DATE	BY
APPROVED BY	DATE	BY
PROJECT ENGINEER	DATE	BY
DATE	BY	

UPONE DATE  
 LETTING DATE





068B00038N

REPLACE ARMORED EDGE  
REPLACE ARMORED EDGE

**ELEVATION**  
3-28'-0" RCDC CONTINUOUS SPANS-2 SKEW  
2:1 FILL SLOPES-4'-0" ROADWAY  
HS20 LOADING-5'-8" SHOULDERS

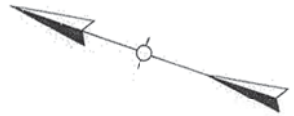
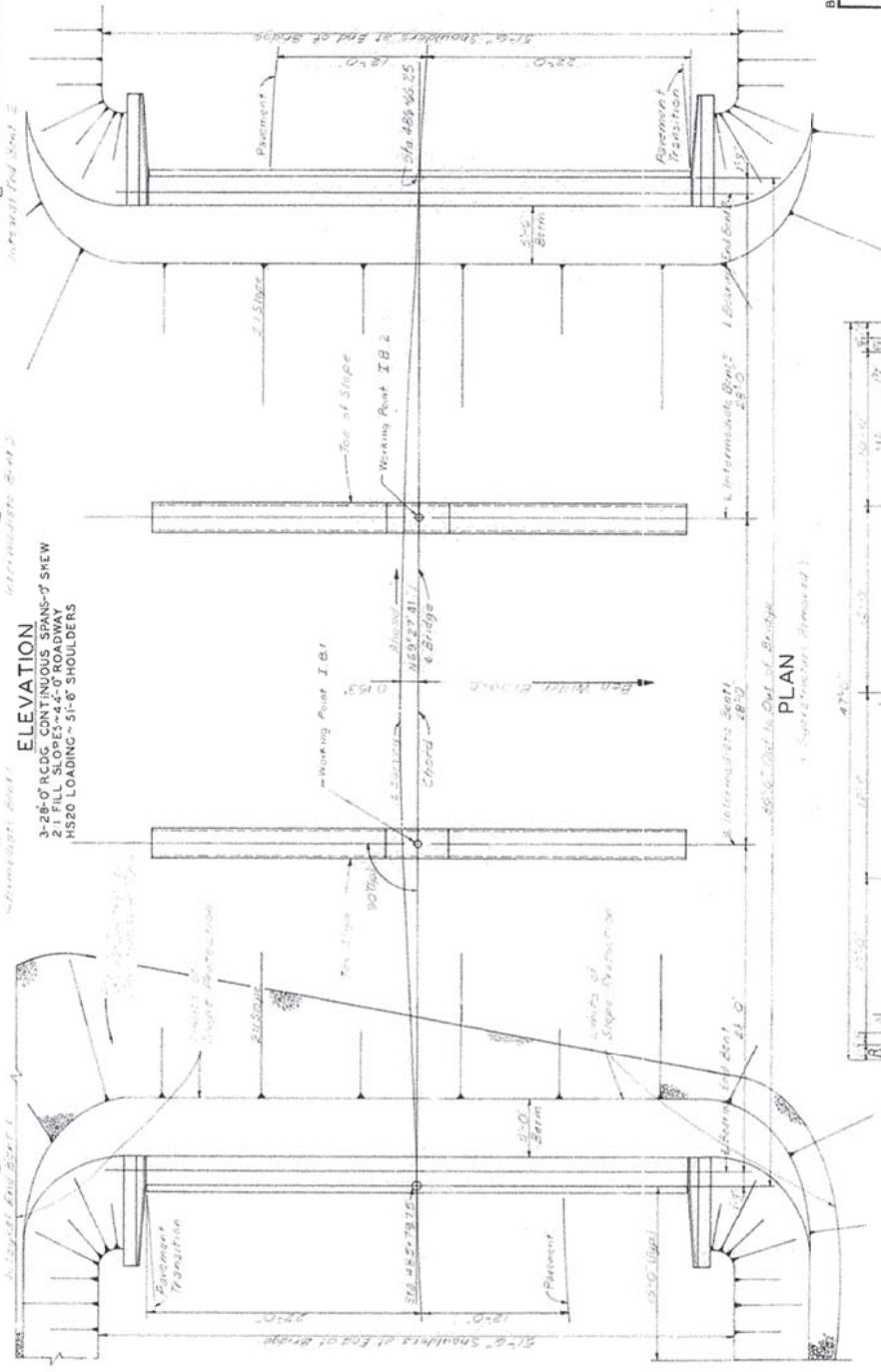

Curve Data  
R1 41594.00  
C1 190.250 RA  
T1 522.04  
L1 4754.72  
P1 3729.08  
T1 531.8  
L1 4754.72  
P1 3729.08  
R1 41594.00

**PLAN**

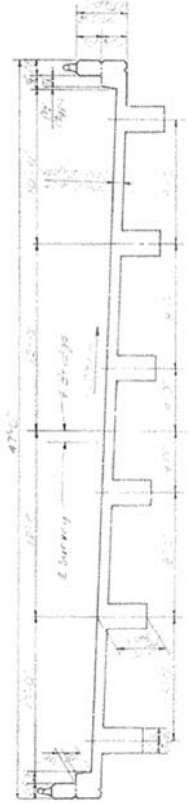

**TYPICAL SECTION**

**LAYOUT**

BRIDGE OVER BEN WILLEN BRANCH SHEET OF 3

COMMONWEALTH OF KENTUCKY  
DEPARTMENT OF HIGHWAYS  
FRANKFORT  
COUNTY OF  
**LEWIS**  
MAYSVILLE-VANCEBURG

ROAD  
P. C. PROJECT NO.  
STATION 456+23

DRAWING NO.  
18310

560  
550  
540

Note: Guardrail to be attached to each wing. See 518 Dwg. 17-61 and 518B.







# EXPANSION DAM DETAIL

## Abutments #1 and #2

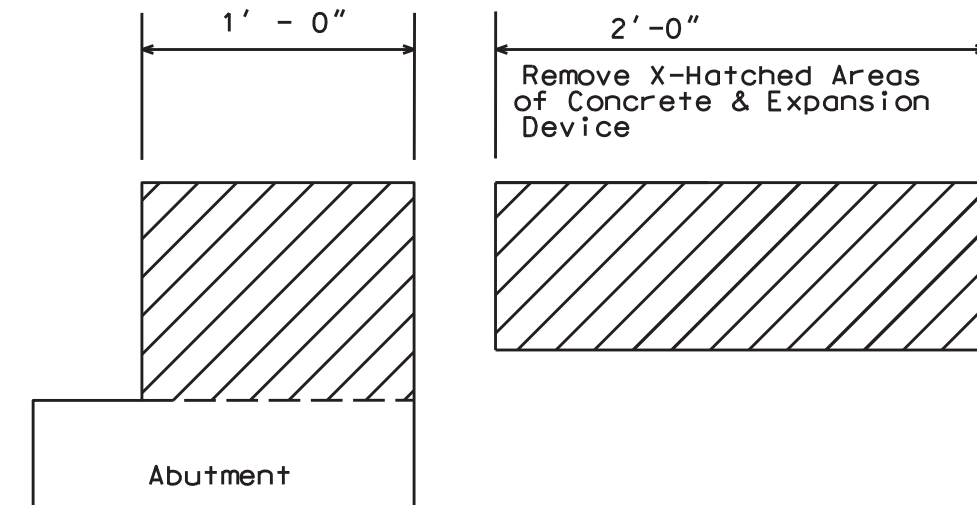

Clean & Leave  
Steel Reinf.  
in place.

## EXISTING SECTION

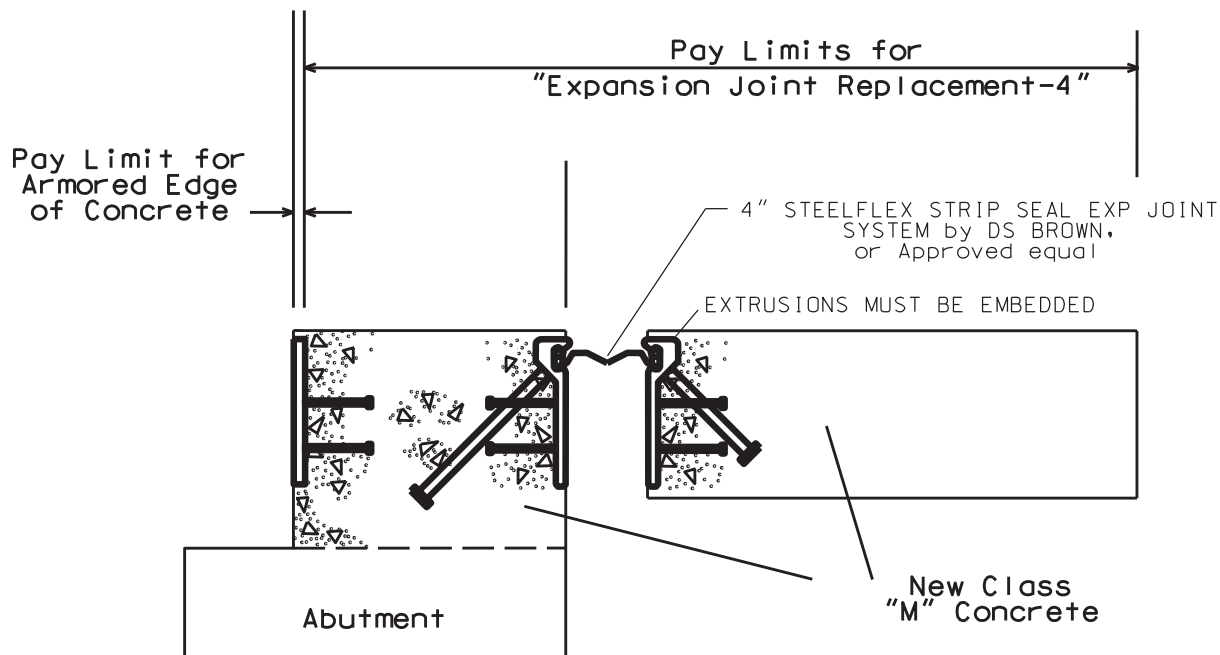

## PROPOSED SECTION

# CURB SECTION

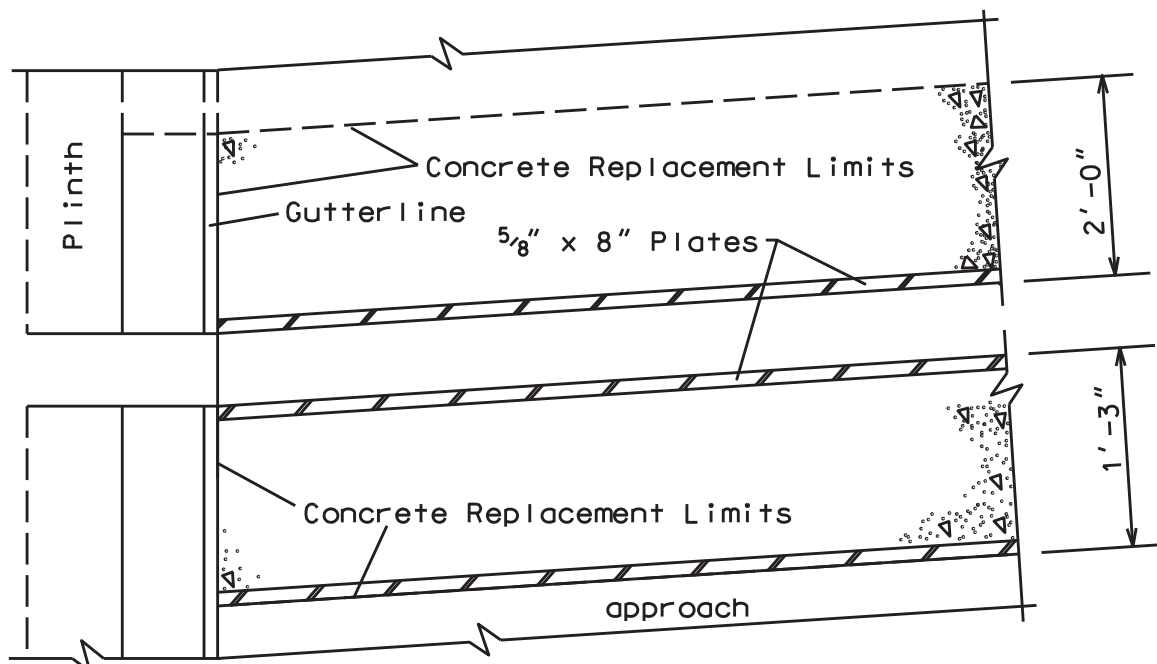

## PLAN VIEW @ CURB

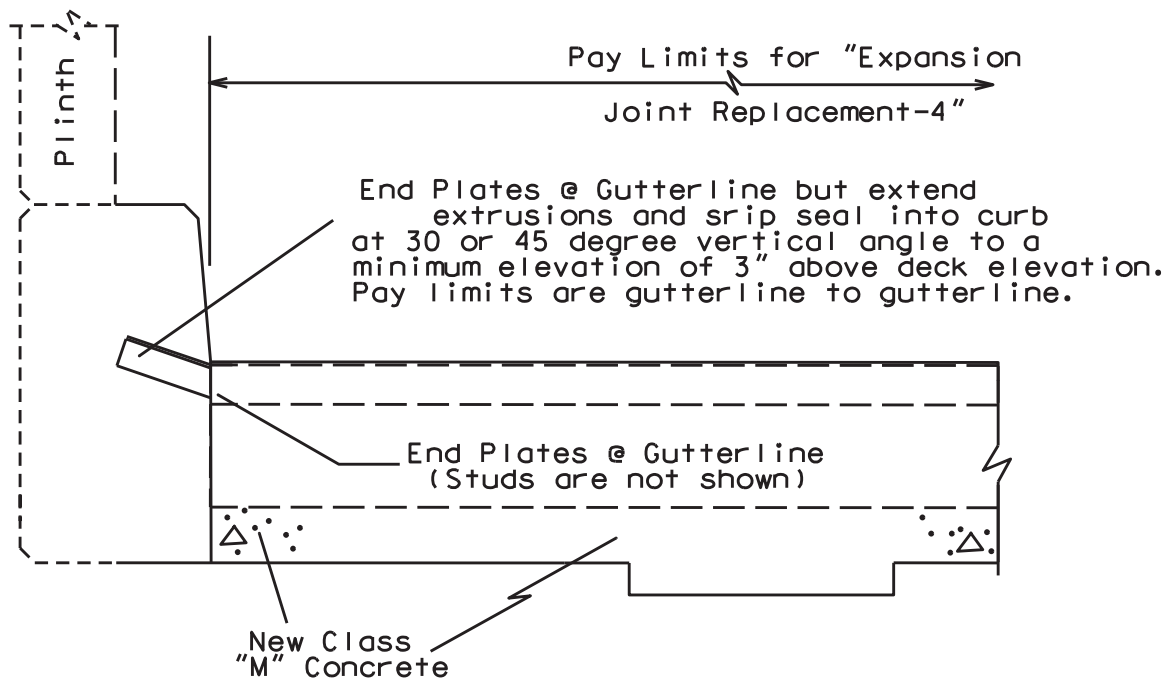

## PROPOSED SECTION @ CURB

# EXPANSION DAM DETAIL

Abutments #1 and #2

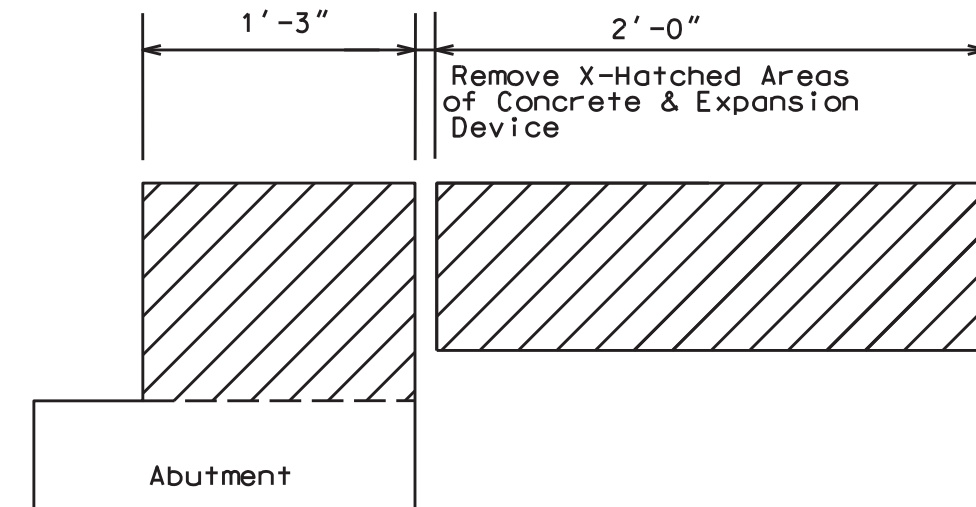

Clean & Leave  
Steel Reinf.  
in place.

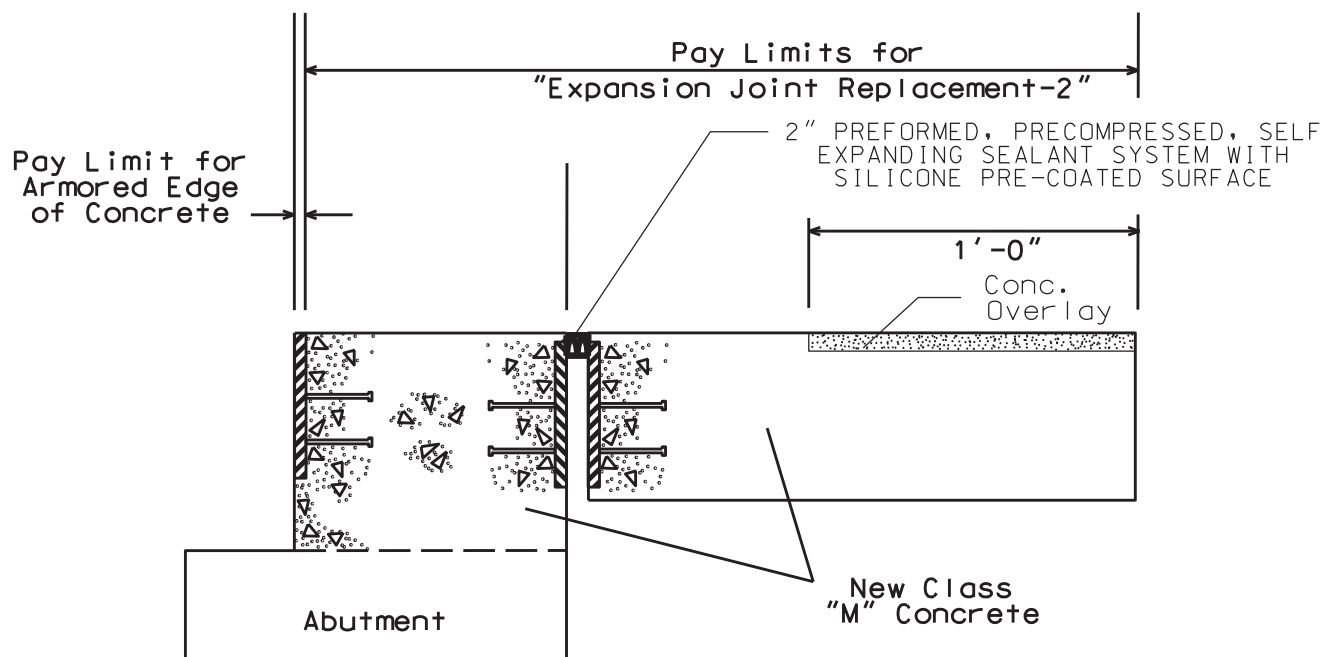

## PROPOSED SECTION

# CURB SECTION

Abutments #1 and #2

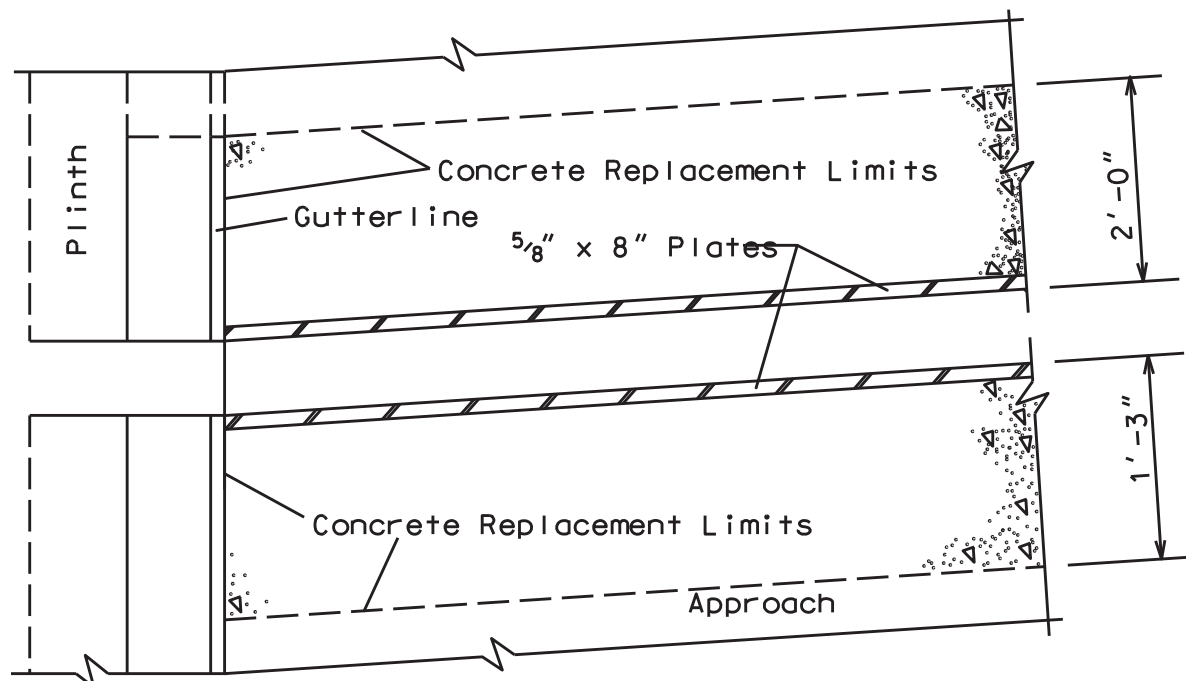

PLAN VIEW @ CURB

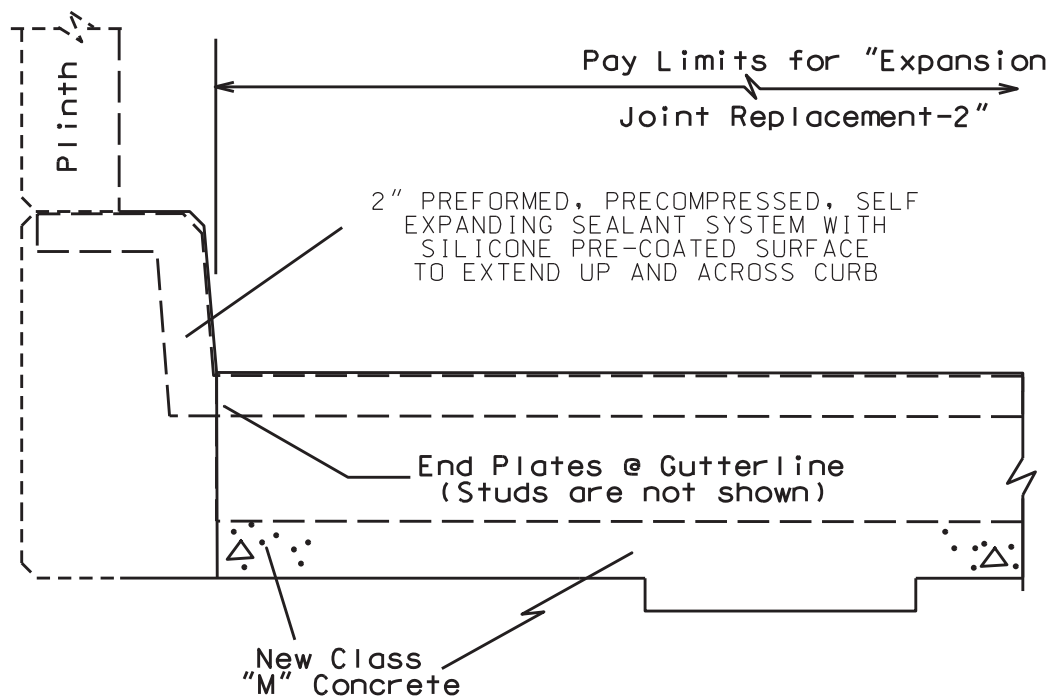

PROPOSED SECTION @ CURB

## **PART II**

### **SPECIFICATIONS AND STANDARD DRAWINGS**

### **SPECIFICATIONS REFERENCE**

Any reference in the plans or proposal to previous editions of the *Standard Specifications for Road and Bridge Construction* and *Standard Drawings* are superseded by *Standard Specifications for Road and Bridge Construction, Edition of 2019* and *Standard Drawings, Edition of 2016*.

## **SUPPLEMENTAL SPECIFICATIONS**

The contractor shall use the Supplemental Specifications that are effective at the time of letting.  
The Supplemental Specifications can be found at the following link:

<http://transportation.ky.gov/Construction/Pages/Kentucky-Standard-Specifications.aspx>

**STANDARD DRAWINGS THAT APPLY**

**TRAFFIC**  
**~ TEMPORARY ~**  
**TRAFFIC CONTROL**

LANE CLOSURE USING TRAFFIC SIGNALS	TTC-110
LANE CLOSURE MULTI-LANE HIGHWAY CASE I	TTC-115

**DEVICES**

POST SPLICING DETAIL	TTD-110
----------------------	---------

**BRIDGES**

**MISCELLANEOUS STANDARDS**

BRIDGE RESTORATION AND WATERPROOFING WITH CONCRETE OVERLAYS	BGX-009-04
--	------------

**JOINTS**

NEOPRENE EXPANSION DAMS AND ARMORED EDGES	BJE-001-11
---	------------



## **PART III**

### **EMPLOYMENT, WAGE AND RECORD REQUIREMENTS**

**TRANSPORTATION CABINET  
DEPARTMENT OF HIGHWAYS**

**LABOR AND WAGE REQUIREMENTS  
APPLICABLE TO OTHER THAN FEDERAL-AID SYSTEM PROJECTS**

- I. Application
- II. Nondiscrimination of Employees (KRS 344)

**I. APPLICATION**

1. These contract provisions shall apply to all work performed on the contract by the contractor with his own organization and with the assistance of workmen under his immediate superintendence and to all work performed on the contract by piecework, station work or by subcontract. The contractor's organization shall be construed to include only workmen employed and paid directly by the contractor and equipment owned or rented by him, with or without operators.

2. The contractor shall insert in each of his subcontracts all of the stipulations contained in these Required Provisions and such other stipulations as may be required.

3. A breach of any of the stipulations contained in these Required Provisions may be grounds for termination of the contract.

3. If the contractor is in control of apprenticeship or other training or retraining, including on-the-job training programs, he shall not discriminate against an individual because of his race, color, religion, national origin, sex, disability or age forty (40) and over, in admission to, or employment in any program established to provide apprenticeship or other training.

4. The contractor will send to each labor union or representative of workers with which he has a collective bargaining agreement or other contract or understanding, a notice to be provided advising the said labor union or workers' representative of the contractor's commitments under this section, and shall post copies of the notice in conspicuous places available to employees and applicants for employment. The contractor will take such action with respect to any subcontract or purchase order as the administrating agency may direct as a means of enforcing such provisions, including sanctions for non-compliance.

Revised: January 25, 2017

**II. NONDISCRIMINATION OF EMPLOYEES**

**AN ACT OF THE KENTUCKY  
GENERAL ASSEMBLY TO PREVENT  
DISCRIMINATION IN EMPLOYMENT  
KRS CHAPTER 344  
EFFECTIVE JUNE 16, 1972**

The contract on this project, in accordance with KRS Chapter 344, provides that during the performance of this contract, the contractor agrees as follows:

1. The contractor shall not fail or refuse to hire, or shall not discharge any individual, or otherwise discriminate against an individual with respect to his compensation, terms, conditions, or privileges of employment, because of such individual's race, color, religion, national origin, sex, disability or age (forty and above); or limit, segregate, or classify his employees in any way which would deprive or tend to deprive an individual of employment opportunities or otherwise adversely affect his status as an employee, because of such individual's race, color, religion, national origin, sex, disability or age forty (40) and over. The contractor agrees to post in conspicuous places, available to employees and applicants for employment, notices to be provided setting forth the provisions of this nondiscrimination clause.

2. The contractor shall not print or publish or cause to be printed or published a notice or advertisement relating to employment by such an employer or membership in or any classification or referral for employment by the employment agency, indicating any preference, limitation, specification, or discrimination, based on race, color, religion, national origin, sex, or age forty (40) and over, or because the person is a qualified individual with a disability, except that such a notice or advertisement may indicate a preference, limitation, or specification based on religion, national origin, sex, or age forty (40) and over, or because the person is a qualified individual with a disability, when religion, national origin, sex, or age forty (40) and over, or because the person is a qualified individual with a disability, is a bona fide occupational qualification for employment.

## EXECUTIVE BRANCH CODE OF ETHICS

In the 1992 regular legislative session, the General Assembly passed and Governor Brereton Jones signed Senate Bill 63 (codified as KRS 11A), the Executive Branch Code of Ethics, which states, in part:

KRS 11A.040 (7) provides:

No present or former public servant shall, within six (6) months following termination of his office or employment, accept employment, compensation, or other economic benefit from any person or business that contracts or does business with, or is regulated by, the state in matters in which he was directly involved during the last thirty-six (36) months of his tenure. This provision shall not prohibit an individual from returning to the same business, firm, occupation, or profession in which he was involved prior to taking office or beginning his term of employment, or for which he received, prior to his state employment, a professional degree or license, provided that, for a period of six (6) months, he personally refrains from working on any matter in which he was directly involved during the last thirty-six (36) months of his tenure in state government. This subsection shall not prohibit the performance of ministerial functions, including but not limited to filing tax returns, filing applications for permits or licenses, or filing incorporation papers, nor shall it prohibit the former officer or public servant from receiving public funds disbursed through entitlement programs.

KRS 11A.040 (9) states:

A former public servant shall not represent a person or business before a state agency in a matter in which the former public servant was directly involved during the last thirty-six (36) months of his tenure, for a period of one (1) year after the latter of:

- a) The date of leaving office or termination of employment; or
- b) The date the term of office expires to which the public servant was elected.

This law is intended to promote public confidence in the integrity of state government and to declare as public policy the idea that state employees should view their work as a public trust and not as a way to obtain private benefits.

If you have worked for the executive branch of state government within the past six months, you may be subject to the law's prohibitions. The law's applicability may be different if you hold elected office or are contemplating representation of another before a state agency.

Also, if you are affiliated with a firm which does business with the state and which employs former state executive-branch employees, you should be aware that the law may apply to them.

In case of doubt, the law permits you to request an advisory opinion from the Executive Branch Ethics Commission, 3 Fountain Place, Frankfort, Kentucky 40601; telephone (502) 564-7954.

Revised: January 27, 2017

### **Kentucky Equal Employment Opportunity Act of 1978**

The requirements of the Kentucky Equal Employment Opportunity Act of 1978 (KRS 45.560-45.640) shall apply to this Contract. The apparent low Bidder will be required to submit EEO forms to the Division of Construction Procurement, which will then forward to the Finance and Administration Cabinet for review and approval. No award will become effective until all forms are submitted and EEO/CC has certified compliance. The required EEO forms are as follows:

- EEO-1: Employer Information Report
- Affidavit of Intent to Comply
- Employee Data Sheet
- Subcontractor Report

These forms are available on the Finance and Administration's web page under ***Vendor Information, Standard Attachments and General Terms*** at the following address:  
**<https://www.eProcurement.ky.gov>**.

Bidders currently certified as being in compliance by the Finance and Administration Cabinet may submit a copy of their approval letter in lieu of the referenced EEO forms.

For questions or assistance please contact the Finance and Administration Cabinet by email at **[finance.contractcompliance@ky.gov](mailto:finance.contractcompliance@ky.gov)** or by phone at 502-564-2874.

# EMPLOYEE RIGHTS UNDER THE FAIR LABOR STANDARDS ACT

THE UNITED STATES DEPARTMENT OF LABOR WAGE AND HOUR DIVISION

## FEDERAL MINIMUM WAGE

# \$7.25

 PER HOUR

BEGINNING JULY 24, 2009

**OVERTIME PAY** At least 1½ times your regular rate of pay for all hours worked over 40 in a workweek.

**CHILD LABOR** An employee must be at least **16** years old to work in most non-farm jobs and at least **18** to work in non-farm jobs declared hazardous by the Secretary of Labor.

Youths **14** and **15** years old may work outside school hours in various non-manufacturing, non-mining, non-hazardous jobs under the following conditions:

**No more than**

- **3** hours on a school day or **18** hours in a school week;
- **8** hours on a non-school day or **40** hours in a non-school week.

Also, work may not begin before **7 a.m.** or end after **7 p.m.**, except from June 1 through Labor Day, when evening hours are extended to **9 p.m.** Different rules apply in agricultural employment.

**TIP CREDIT** Employers of “tipped employees” must pay a cash wage of at least \$2.13 per hour if they claim a tip credit against their minimum wage obligation. If an employee’s tips combined with the employer’s cash wage of at least \$2.13 per hour do not equal the minimum hourly wage, the employer must make up the difference. Certain other conditions must also be met.

**ENFORCEMENT** The Department of Labor may recover back wages either administratively or through court action, for the employees that have been underpaid in violation of the law. Violations may result in civil or criminal action.

Employers may be assessed civil money penalties of up to \$1,100 for each willful or repeated violation of the minimum wage or overtime pay provisions of the law and up to \$11,000 for each employee who is the subject of a violation of the Act’s child labor provisions. In addition, a civil money penalty of up to \$50,000 may be assessed for each child labor violation that causes the death or serious injury of any minor employee, and such assessments may be doubled, up to \$100,000, when the violations are determined to be willful or repeated. The law also prohibits discriminating against or discharging workers who file a complaint or participate in any proceeding under the Act.

### ADDITIONAL INFORMATION

- Certain occupations and establishments are exempt from the minimum wage and/or overtime pay provisions.
- Special provisions apply to workers in American Samoa and the Commonwealth of the Northern Mariana Islands.
- Some state laws provide greater employee protections; employers must comply with both.
- The law requires employers to display this poster where employees can readily see it.
- Employees under 20 years of age may be paid \$4.25 per hour during their first 90 consecutive calendar days of employment with an employer.
- Certain full-time students, student learners, apprentices, and workers with disabilities may be paid less than the minimum wage under special certificates issued by the Department of Labor.

For additional information:



# 1-866-4-USWAGE

(1-866-487-9243) TTY: 1-877-889-5627



# WWW.WAGEHOUR.DOL.GOV

**PART IV**  
**INSURANCE**

Refer to  
*Kentucky Standard Specifications for Road and Bridge Construction,*  
current edition

**PART V**  
**BID ITEMS**

## PROPOSAL BID ITEMS

192913

Report Date 9/26/19

Page 1 of 1

## Section: 0001 - BRIDGE

LINE	BID CODE	ALT	DESCRIPTION	QUANTITY	UNIT	UNIT PRIC	FP	AMOUNT
0010	02562		TEMPORARY SIGNS	1,043.00	SQFT		\$	
0020	02650		MAINTAIN & CONTROL TRAFFIC APPLIES TO 035B00066N	1.00	LS		\$	
0030	02650		MAINTAIN & CONTROL TRAFFIC APPLIES TO 035B00070N	1.00	LS		\$	
0040	02650		MAINTAIN & CONTROL TRAFFIC APPLIES TO 035B00078N	1.00	LS		\$	
0050	02650		MAINTAIN & CONTROL TRAFFIC APPLIES TO 035B00079N.	1.00	LS		\$	
0060	02650		MAINTAIN & CONTROL TRAFFIC APPLIES TO 068B00038N	1.00	LS		\$	
0070	02650		MAINTAIN & CONTROL TRAFFIC APPLIES TO 068B00099N	1.00	LS		\$	
0080	02650		MAINTAIN & CONTROL TRAFFIC APPLIES TO 068B00105N	1.00	LS		\$	
0090	02653		LANE CLOSURE	14.00	EACH		\$	
0100	03295		EXPAN JOINT REPLACE 2 IN	210.40	LF		\$	
0110	03298		EXPAN JOINT REPLACE 4 IN	89.20	LF		\$	
0120	03299		ARMORED EDGE FOR CONCRETE	563.60	LF		\$	
0130	03304		BRIDGE OVERLAY APPROACH PAVEMENT	4,135.00	SQYD		\$	
0140	04933		TEMP SIGNAL 2 PHASE	7.00	EACH		\$	
0150	06514		PAVE STRIPING-PERM PAINT-4 IN	9,693.00	LF		\$	
0160	06549		PAVE STRIPING-TEMP REM TAPE-B	3,500.00	LF		\$	
0170	06550		PAVE STRIPING-TEMP REM TAPE-W	7,000.00	LF		\$	
0180	06551		PAVE STRIPING-TEMP REM TAPE-Y	14,000.00	LF		\$	
0190	08150		STEEL REINFORCEMENT	1,870.40	LB		\$	
0200	08504		EPOXY SAND SLURRY	513.80	SQYD		\$	
0210	08510		REM EPOXY BIT FOREIGN OVERLAY	425.00	SQYD		\$	
0220	08526		CONC CLASS M FULL DEPTH PATCH	24.00	CUYD		\$	
0230	08534		CONCRETE OVERLAY-LATEX	319.80	CUYD		\$	
0240	08549		BLAST CLEANING	8,191.00	SQYD		\$	
0250	08551		MACHINE PREP OF SLAB	7,253.00	SQYD		\$	
0260	24094EC		PARTIAL DEPTH PATCHING	213.30	CUYD		\$	

## Section: 0002 - DEMOBILIZATION

LINE	BID CODE	ALT	DESCRIPTION	QUANTITY	UNIT	UNIT PRIC	FP	AMOUNT
0270	02569		DEMOBILIZATION	1.00	LS		\$	