



CALL NO. 321

CONTRACT ID. 192049

LETCHER COUNTY

FED/STATE PROJECT NUMBER FE06 067 0007 020-021

DESCRIPTION COLSON ROAD (KY 7)

WORK TYPE GUARDRAIL

PRIMARY COMPLETION DATE 6/30/2019

LETTING DATE: January 25,2019

Sealed Bids will be received electronically through the Bid Express bidding service until 10:00 AM EASTERN STANDARD TIME January 25,2019. Bids will be publicly announced at 10:00 AM EASTERN STANDARD TIME.

NO PLANS ASSOCIATED WITH THIS PROJECT.

REQUIRED BID PROPOSAL GUARANTY: Not less than 5% of the total bid.

TABLE OF CONTENTS

PART I	SCOPE OF WORK
	<ul style="list-style-type: none">• PROJECT(S), COMPLETION DATE(S), & LIQUIDATED DAMAGES• CONTRACT NOTES• STATE CONTRACT NOTES• WASTE AND BORROW SITES• SHOULDERING BY STATE FORCES• GUARDRAIL• TYPICAL SECTION DIMENSIONS• TRAFFIC CONTROL PLAN• EROSION CONTROL PLAN FOR MAINTENANCE PROJECTS• SKETCH MAP(S)• SUMMARY SHEET(S)• TYPICAL SECTION(S)
PART II	SPECIFICATIONS AND STANDARD DRAWINGS
	<ul style="list-style-type: none">• SPECIFICATIONS REFERENCE• SUPPLEMENTAL SPECIFICATION• 2016 STANDARD DRAWINGS THAT APPLY• TYPICAL GUARDRAIL INSTALLATIONS• STEEL BEAM GUARDRAIL ("W" BEAM)• STEEL GUARDRAIL POSTS• GUARDRAIL END TREATMENT TYPE 7 ALTERNATE ANCHOR• DELINEATORS FOR GUARDRAIL• GUARDRAIL END TREATMENT TYPE 7
PART III	EMPLOYMENT, WAGE AND RECORD REQUIREMENTS
	<ul style="list-style-type: none">• LABOR AND WAGE REQUIREMENTS• EXECUTIVE BRANCH CODE OF ETHICS• KENTUCKY EQUAL EMPLOYMENT OPPORTUNITY ACT OF 1978 LOCALITY / STATE• PROJECT WAGE RATES / STATE
PART IV	INSURANCE
PART V	BID ITEMS

PART I
SCOPE OF WORK

ADMINISTRATIVE DISTRICT - 12

CONTRACT ID - 192049

FE06 067 0007 020-021

COUNTY - LETCHER

PCN - MP06700071901

FE06 067 0007 020-021

COLSON ROAD (KY 7) (MP 20.128) FROM 0.29 MILES NORTH OF JORDAN LANE EXTENDING NORTH TO 0.11 MILE SOUTH OF COOLIE BAKER ROAD (MP 20.349), A DISTANCE OF 0.22 MILES.GUARDRAIL
GEOGRAPHIC COORDINATES LATITUDE 37:13:21.00 LONGITUDE 82:50:45.00

COMPLETION DATE(S):

COMPLETED BY 06/30/2019

SPECIFIED COMPLETION DATE -
ALL ITEMS IN CONTRACT

CONTRACT NOTES

PROPOSAL ADDENDA

All addenda to this proposal must be applied when calculating bid and certified in the bid packet submitted to the Kentucky Department of Highways. Failure to use the correct and most recent addenda may result in the bid being rejected.

BID SUBMITTAL

Bidder must use the Department's electronic bidding software. The Bidder must download the bid file located on the Bid Express website (www.bidx.com) to prepare a bid packet for submission to the Department. The bidder must submit electronically using Bid Express.

JOINT VENTURE BIDDING

Joint venture bidding is permissible. All companies in the joint venture must be prequalified in one of the work types in the Qualifications for Bidders for the project. The bidders must get a vendor ID for the joint venture from the Division of Construction Procurement and register the joint venture as a bidder on the project. Also, the joint venture must obtain a digital ID from Bid Express to submit a bid. A joint bid bond of 5% may be submitted for both companies or each company may submit a separate bond of 5%.

UNDERGROUND FACILITY DAMAGE PROTECTION

The contractor shall make every effort to protect underground facilities from damage as prescribed in the Underground Facility Damage Protection Act of 1994, Kentucky Revised Statute KRS 367.4901 to 367.4917. It is the contractor's responsibility to determine and take steps necessary to be in compliance with federal and state damage prevention directives. When prescribed in said directives, the contractor shall submit Excavation Locate Requests to the Kentucky Contact Center (KY811) via web ticket entry. The submission of this request does not relieve the contractor from the responsibility of contacting non-member facility owners, whom shall be contacted through their individual Protection Notification Center. Non-compliance with these directives can result in the enforcement of penalties.

REGISTRATION WITH THE SECRETARY OF STATE BY A FOREIGN ENTITY

Pursuant to KRS 176.085(1)(b), an agency, department, office, or political subdivision of the Commonwealth of Kentucky shall not award a state contract to a person that is a foreign entity required by [KRS 14A.9-010](#) to obtain a certificate of authority to transact business in the Commonwealth ("certificate") from the Secretary of State under [KRS 14A.9-030](#) unless the person produces the certificate within fourteen (14) days of the bid or proposal opening. If the foreign entity is not required to obtain a certificate as provided in [KRS 14A.9-010](#), the foreign entity should identify the applicable exception. Foreign entity is defined within [KRS 14A.1-070](#).

For all foreign entities required to obtain a certificate of authority to transact business in the Commonwealth, if a copy of the certificate is not received by the contracting agency within the time frame identified above, the foreign entity's solicitation response shall be deemed non-responsive or the awarded contract shall be cancelled.

Businesses can register with the Secretary of State at <https://secure.kentucky.gov/sos/ftbr/welcome.aspx>.

SPECIAL NOTE FOR PROJECT QUESTIONS DURING ADVERTISEMENT

Questions about projects during the advertisement should be submitted in writing to the Division of Construction Procurement. This may be done by fax (502) 564-7299 or email to kytc.projectquestions@ky.gov. The Department will attempt to answer all submitted questions. The Department reserves the right not to answer if the question is not pertinent or does not aid in clarifying the project intent.

The deadline for posting answers will be 3:00 pm Eastern Daylight Time, the day preceding the Letting. Questions may be submitted until this deadline with the understanding that the later a question is submitted, the less likely an answer will be able to be provided.

The questions and answers will be posted for each Letting under the heading "Questions & Answers" on the Construction Procurement website (www.transportation.ky.gov/contract). The answers provided shall be considered part of this Special Note and, in case of a discrepancy, will govern over all other bidding documents.

HARDWOOD REMOVAL RESTRICTIONS

The US Department of Agriculture has imposed a quarantine in Kentucky and several surrounding states, to prevent the spread of an invasive insect, the emerald ash borer. Hardwood cut in conjunction with the project may not be removed from the state. Chipping or burning on site is the preferred method of disposal.

INSTRUCTIONS FOR EXCESS MATERIAL SITES AND BORROW SITES

Identification of excess material sites and borrow sites shall be the responsibility of the Contractor. The Contractor shall be responsible for compliance with all applicable state and federal laws and may wish to consult with the US Fish and Wildlife Service to seek protection under Section 10 of the Endangered Species Act for these activities.

ACCESS TO RECORDS

The contractor, as defined in KRS 45A.030 (9) agrees that the contracting agency, the Finance and Administration Cabinet, the Auditor of Public Accounts, and the Legislative Research Commission, or their duly authorized representatives, shall have access to any books, documents, papers, records, or other evidence, which are directly pertinent to this contract for the purpose of financial audit or program review. Records and other prequalification information confidentially

disclosed as part of the bid process shall not be deemed as directly pertinent to the contract and shall be exempt from disclosure as provided in KRS 61.878(1)(c). The contractor also recognizes that any books, documents, papers, records, or other evidence, received during a financial audit or program review shall be subject to the Kentucky Open Records Act, KRS 61.870 to 61.884.

In the event of a dispute between the contractor and the contracting agency, Attorney General, or the Auditor of Public Accounts over documents that are eligible for production and review, the Finance and Administration Cabinet shall review the dispute and issue a determination, in accordance with Secretary's Order 11-004.

April 30, 2018

SPECIAL NOTE FOR RECIPROCAL PREFERENCE

RECIPROCAL PREFERENCE TO BE GIVEN BY PUBLIC AGENCIES TO RESIDENT BIDDERS

By reference, KRS 45A.490 to 45A.494 are incorporated herein and in compliance regarding the bidders residency. Bidders who want to claim resident bidder status should complete the Affidavit for Claiming Resident Bidder Status along with their bid in the electronic bidding software. Submittal of the Affidavit should be done along the bid in Bid Express.

April 30, 2018

SPECIAL PROVISION FOR WASTE AND BORROW SITES

Obtain U.S. Army Corps of Engineer's approval before utilizing a waste or borrow site that involves "Waters of the United States". The Corps of Engineers defines "Waters of the United States" as perennial or intermittent streams, ponds or wetlands. The Corps of Engineers also considers ephemeral streams, typically dry except during rainfall but having a defined drainage channel, to be jurisdictional waters. Direct questions concerning any potential impacts to "Waters of the United States" to the attention of the appropriate District Office for the Corps of Engineers for a determination prior to disturbance. Be responsible for any fees associated with obtaining approval for waste and borrow sites from the U.S. Army Corps of Engineer or other appropriate regulatory agencies.

1-296 Waste & Borrow Sites
01/02/2012

SPECIAL NOTE FOR SHOULDER PREPARATION
FE06 067 0007 020-021

If necessary, the Department will grade, shape, add additional materials, and compact shoulder as shown on the typical section, Standard Drawings, and as directed by the Engineer to provide proper template and foundation for the guardrail, end treatments, and terminal section.

SPECIAL NOTES FOR GUARDRAIL FE06 067 0007 020-021

I. DESCRIPTION

Except as specified herein, perform all work in accordance with the Department's 2012 Standard and Supplemental Specifications and Standard and Sepia Drawings, current editions. Article references are to the Standard Specifications.

Furnish all equipment, labor, materials, and incidentals for the following work items:

(1) Site and Shoulder Preparation; (2) Install Guardrail furnished by the Department; (3) Furnish and install End Treatments; (4) Furnish and install Delineators for Guardrail; (5) Maintain and control traffic; and (6) all other work specified as part of this contract.

II. MATERIALS

Except as specified herein, provide for all materials to be sampled and tested in accordance with the Department's Sampling Manual, and make the materials available for sampling a sufficient time in advance of the use of the materials to allow for the necessary time for testing.

A Maintain and Control Traffic. See Traffic Control Plan.

B. Guardrail. The Department will furnish guardrail elements and radius rail, steel posts, approximately 8 extra length steel posts (9 foot length), and off set blocks.in general conformance to Section 814 and the Standard Drawings, but may vary in some respects, such as gage, pre-punched hole patterns, etc. The Department will make the materials available to the Contractor at the Department's Bailey Bridge Lot in Frankfort, Kentucky, between the hours of 8:00 a.m. and 3:30 p.m. Monday through Friday. Determine curvature of radius rail for entrances and terminal sections and provide the Engineer a list of requirements fourteen (14) calendar days prior to beginning work. Load and deliver the guardrail materials to the project work site.

Punch additional post bolt slots as required in guardrail and paint with 2 coats of zinc dust-zinc oxide paint conforming to Federal Specification TT-P641.

The Contractor shall furnish guardrail hardware (nuts, bolts, and washers), End Treatments, and Terminal Sections in accordance with Section 814 and the Sepia Drawings.

C. Delineators for Guardrail. Furnish Bi-Directional White Delineators for Guardrail according to the Delineators for Guardrail Sepia Drawing.

D. Erosion Control. See Special Note for Erosion Control.

Guardrail
FE06 067 0007 020-021
Page 2 of 4

III. CONSTRUCTION METHODS

A. Maintain and Control Traffic. See Traffic Control Plan.

B. Site and Shoulder Preparation. Other than shoulder preparation performed by the Department, be responsible for all site preparation, including but not limited to, clearing and grubbing, excavation, embankment, and removal of all obstructions or any other items; temporary pollution and erosion control; disposal, of excess and waste materials and debris; and final dressing, cleanup, and seeding and protection. Perform all site preparation as approved or directed by the engineer.

C. Install Guardrail. Except as specified herein, install materials furnished by the Department and construct guardrail system according to Section 719 and the Standard Drawings. Determine curvature of radius rail for entrances and provide the Engineer a list of requirements fourteen (14) prior to beginning work.

Consider locations listed on the summary and/or shown on the drawings to be approximate only. The Engineer will determine the exact termini for individual guardrail installations at the time of construction. Unless directed otherwise by the Engineer, provide a minimum two (2) foot shoulder width. Construct radii at entrances and road intersections as directed by the Engineer.

Erect guardrail to the lines and grades shown on current Standard and Sepia Drawings or as directed by the Engineer by any method approved by the Engineer, which allows construction of the guardrail to the true grade without apparent sags.

When installing guardrail, do not leave blunt ends exposed where they would be hazardous to the public. When it is not practical to complete the construction of the guardrail and the permanent end treatments and terminal sections first, provide a temporary end by connecting at least 25 feet of rail to the last post, and by slightly flaring, and burying the end of the rail completely into the existing shoulder. If left overnight, place a drum with bridge panel in advance of the guardrail end and maintain during use.

D. Delineators for Guardrail. Construct Delineators for Guardrail according to the delineators for Guardrail Sepia Drawing, except space 50' on centers.

E. Property Damage. Be responsible for all damage to public and/or private property resulting from the work. Restore damaged roadway features and private property at no additional cost to the Department.

F. Coordination with Utility Companies. Locate all underground, above ground and overhead utilities prior to beginning construction. Be responsible for contacting and maintaining liaison with all utility companies that have utilities located within the project

Guardrail
FE06 067 0007 020-021
Page 3 of 4

limits. Do not disturb existing overhead or underground utilities. It is not anticipated that any utility facilities will need to be relocated and/or adjusted; however, in the event that it is discovered that the work does require that utilities be relocated and/or adjusted, the utility companies will work concurrently with the Contractor while relocating their facilities. Be responsible for repairing all utility damage that occurs as a result of guardrail operations at no additional cost to the Department.

G. Right of Way Limits. The Department has not established exact limits of the Right-of-Way. Limit work activities to obvious Right-of-Way, permanent or temporary easements, and work areas secured by the Department through consent and release of the adjacent property owners. Be responsible for all encroachments onto private lands.

H. Disposal of Waste. Dispose of all removed concrete, debris, and other waste and debris off the Right-of-Way at sites obtained by the Contractor at no additional cost to the Department. See Special Note for Waste and Borrow.

I. Final Dressing, Clean Up, and Seeding and Protection. Apply Class A Final Dressing to all disturbed areas, both on and off the Right-of-Way. Sow all disturbed earthen areas according to the Special Note for Erosion Control.

J. Erosion Control. See Special Note for Erosion Control.

IV. METHOD OF MEASUREMENT

A. Maintain and Control Traffic. See Traffic Control Plan.

B. Site and Shoulder Preparation. Other than the bid items listed, the Department will not measure Site and Shoulder Preparation for separate payment but shall be incidental to Guardrail, Steel W Beam Single Face, Install and End Treatments; Bridge End as applicable.

C. Guardrail, Steel W Beam Single Face, Install. The Department will measure the actual length of guardrail furnished by the Department and installed by the Contractor. Contrary to section 719.04.01, the Department will measure the actual length of shop curved guardrail furnished by the Department in linear feet and will not multiply the actual length by a factor of 1.3 to determine the pay quantity. The Department will not measure punching post slot holes in guardrail furnished by the Department for payment but shall be incidental to Guardrail, Steel W Beam Single Face, Install. The Department will not measure installation of extra length posts furnished by the department for payment but shall be incidental to Guardrail, Steel W Beam Single Face, Install.

Guardrail
FE06 067 0007 020-021
Page 4 of 4

D. Guardrail Hardware and Off Set Blocks. The Department will not measure guardrail hardware and Off Set Blocks for separate payment but shall be incidental to Guardrail, Steel W Beam Single Face, Install.

E. End Treatments. See Section 719.04

F. Delineators for Guardrail. See Delineators for Guardrail Sepia Drawing.

G. Erosion Control. See Special Note for Erosion Control.

V. BASIS OF PAYMENT

A. Maintain and Control Traffic. See Traffic Control Plan.

B. Guardrail, Steel W Beam Single Face, Install. See Section 719.05.

C. End Treatments. See Section 719.05.

D. Delineators for Guardrail. See Delineators for Guardrail Sepia Drawing.

E. Erosion Control. See Special Note for Erosion Control.

SPECIAL NOTE FOR TYPICAL SECTION DIMENSIONS

Consider the dimensions shown on the typical sections for pavement and shoulder widths and thickness' to be nominal or typical dimensions. The Engineer may direct or approve varying the actual dimensions to be constructed to fit existing conditions. Do not widen existing pavement or shoulders unless specified elsewhere in this proposal or directed by the engineer.

1-3725 Typical Section Dimensions
01/02/2012

TRAFFIC CONTROL PLAN **FE06 067 0007 020-021**

TRAFFIC CONTROL GENERAL

Except as provided herein, maintain and control traffic in accordance with the 2012 Standard and Supplemental Specifications and the Standard and Sepia Drawings, current editions. Except for the roadway and traffic control bid items listed, all items of work necessary to maintain and control traffic will be paid at the lump sum bid price to "Maintain and Control Traffic".

Contrary to Section 106.01, furnish new, or used in like new condition, traffic control devices at the beginning of the work and maintain in like new condition until completion of the work.

PROJECT PHASING & CONSTRUCTION PROCEDURES

The Engineer may specify days and hours when lane closures will not be allowed.

Maintain alternating one way traffic during construction. Provide a minimum clear lane width of ten (10) feet; however, provide for passage of vehicles of up to 16 feet in width. If traffic should be stopped due to construction operations, and a school bus on an official run arrives on the scene, make provisions for the passage of the bus as quickly as possible.

LANE CLOSURES

Do not leave lane closures in place during non-working hours.

SIGNS

The Engineer may require additional signing and/or traffic control devices in addition to the items shown on the Standard Drawings. Sign posts and splices shall be compliant with NCHRP 350 or MASH. Manufacturer's documentation validating this compliance shall be provided to the Engineer prior to installation. Signs, including any splices, shall be installed according to manufacturer's specifications and installation recommendations. Contrary to section 112.04.02, the Department will measure only long term signs (signs intended to be continuously in place for more than 3 days) for payment. The Department will not measure; short term signs (signs intended to be left in place for 3 days or less) for payment, but shall be incidental to Maintain and Control Traffic. Contrary to Section 112.04.02, the Department will measure individual signs only once for payment, regardless of how many times they are erected or relocated. The Department will not measure replacements for damaged signs directed by the Engineer to be replaced due to poor condition or reflectivity.

Traffic Control Plan
FE06 067 0007 020-021
Page 2 of 3

CHANGEABLE MESSAGE SIGNS

If deemed necessary by the Engineer, the Department will furnish, operate, and maintain Changeable Message Signs.

BARRICADES

The Department will not measure barricades used in lieu of barrels and cones for channelization or delineation, but shall be incidental to Maintain and Control Traffic according to Section 112.04.01.

PAVEMENT EDGE DROP-OFFS

Do not allow a pavement edge between opposing directions of traffic or lanes that traffic is expected to cross in a lane change situation with an elevation difference greater than 1½". Place Warning signs (MUTCD W8-11 or W8-9A) in advance of and at 1500' intervals throughout the drop-off area. Dual post the signs on both sides of the traveled way. Wedge all transverse transitions between resurfaced and unresurfaced areas which traffic may cross with asphalt mixture for leveling and wedging. Remove the wedges prior to placement of the final surface course.

Protect pavement edges that traffic is not expected to cross, except accidentally, as follows:

Less than 2" - No protection required.

2" to 4" - Place plastic drums, vertical panels, or barricades every 50 feet. During daylight working hours only, the Engineer will allow the Contractor to use cones in lieu of plastic drums, panels, and barricades. Wedge the drop-off with DGA or asphalt mixture for leveling and wedging with a 1:1 or flatter slope in daylight hours, or 3:1 or flatter slope during nighttime hours, when work is not active in the drop-off area.

Greater than 4" - Protect drop-offs greater than 4 inches within 10 feet of traffic by placing drums, vertical panels, or barricades every 25 feet. The Engineer will not allow the use of cones in lieu of drums, vertical panels, or barricades for drop-offs greater than 4". Place Type III Barricades directly in front of the drop-off facing on coming traffic in both directions of travel. Provide warning signs as shown on the Standard Drawings or as directed by the Engineer

Pedestrians & Bicycles - Protect pedestrian and bicycle traffic as directed by the engineer.

Traffic Control Plan
FE06 067 0007 020-021
Page 3 of 3

Guardrail Installation – Protect with lane closure during active operations. Protect partially completed guardrail installations with a shoulder closure during non-working hours.

SPECIAL NOTE FOR EROSION CONTROL

FE06 067 0007 020-021

I. DESCRIPTION

Perform all erosion and water pollution control work in accordance with the Department's 2012 Standard and Interim Supplemental Specifications, Special Provisions and Special Notes, and Standard and Sepia Drawings, current editions, and as directed by the Engineer. Section references are to the Standard Specifications. This work shall consist of:

(1) Developing and preparing a Best Management Practices Plan (BMP) tailored to suit the specific construction phasing for each site within the project; (2) Preparing the project site for construction, including locating, furnishing, installing, and maintaining temporary and/or permanent erosion and water pollution control measures as required by the BMP prior to beginning any earth disturbing activity on the project site; (3) Clearing and grubbing and removal of all obstructions as required for construction; (4) Removing all erosion control devices when no longer needed; (5) Restoring all disturbed areas as nearly as possible to their original condition; (6) Preparing seedbeds and permanently seeding all disturbed areas; (7) Providing a Kentucky Erosion Prevention and Sediment Control Program (KEPSC-RI) qualified inspector; and (8) Performing any other work to prevent erosion and/or water pollution as specified by this contract, required by the BMP, or as directed by the Engineer.

II. MATERIALS

Furnish materials in accordance with these notes, the Standard Specifications and Interim Supplemental Specifications, and applicable Special Provisions and Special Notes, and Standard and Sepia Drawings, current editions. Provide for all materials to be sampled and tested in accordance with the Department's Sampling Manual. Unless directed otherwise by the Engineer, make the materials available for sampling a sufficient time in advance of the use of the materials to allow for the necessary time for testing.

III. CONSTRUCTION

Be advised, these Erosion Control Plan Notes do not constitute a BMP plan for the project. Jointly with the Engineer, prepare a site specific BMP plan for each drainage area within the project in accordance with Section 213. Provide a unique BMP at each project site using good engineering practices taking into account existing site conditions, the type of work to be performed, and the construction phasing, methods and techniques to be utilized to complete the work. Be responsible for all erosion prevention, sediment control, and water pollution prevention measures required by the BMP for each site. Represent and warrant compliance with the Clean Water Act (33 USC

Erosion Control
FE06 067 0007 020-021
Page 2 of 3

Section 1251 et seq.), the 404 Permit, the 401 Water Quality Certification, and applicable state and local government agency laws, regulations, rules, specifications, and permits. Contrary to Section 105.05, in case of discrepancy between these notes, the Standard Specifications, Interim Supplemental Specifications, Special and Special Notes, Standard and Sepia Drawings, and such state and local government agency requirements, adhere to the most restrictive requirement.

Conduct operations in such a manner as to minimize the amount of disturbed ground during each phase of the construction and limit the haul roads to the minimum required to perform the work. Preserve existing vegetation not required to be removed by the work or the contract. Seed and/or mulch disturbed areas at the earliest opportunity. Use silt fence, silt traps, temporary ditches, brush barriers, erosion control blankets, sodding, channel lining, and other erosion control measures in a timely manner as required by the BMP and as directed or approved by the Engineer. Prevent sediment laden water from leaving the project, entering an existing drainage structure, or entering a stream.

Provide for erosion control measures to be in place and functioning prior to any earth disturbance within a drainage area. Compute the volume and size of silt control devices necessary to control sediment during each phase of construction. Remove sediment from silt traps before they become a maximum of ½ full. Maintain silt fence by removing accumulated trappings and/or replacing the geotextile fabric when it becomes clogged, damaged, or deteriorated, or when directed by the Engineer. Properly dispose of all materials trapped by erosion control devices at approved sites off the right of way obtained by the Contractor at no additional cost to the Department (See Special Note for Waste and Borrow).

As work progresses, add or remove erosion control measures as required by the BMP applicable to the Contractor's project phasing and construction methods and techniques. Update the volume calculations and modify the BMP as necessary throughout the duration of the project. Ensure that an updated BMP is kept on site and available for public inspection throughout the life of the project.

After all construction is complete, restore all disturbed areas in accordance with Section 212. Completely remove all temporary erosion control devices not required as part of the permanent erosion control from the construction site. Prior to removal, obtain the Engineer's concurrence of items to be removed. Grade the remaining exposed earth (both on and off the Right of-Way) as nearly as possible to its original condition, or as directed by the Engineer. Prepare the seed bed areas and sow all exposed earthen areas with the applicable seed mixture(s) according to Section 212.03.03.

Erosion Control
FE06 067 0007 020-021
Page 3 of 3

IV. MEASUREMENT

Erosion Control Blanket. If required by the BMP, the Department will measure Erosion Control Blanket according to Section 212.04.07.

Sodding. If required by the BMP, the Department will measure Sodding according to Section 212.04.08.

Channel Lining. If required by the BMP, the Department will measure Channel Lining according to Sections 703.04.04-703.04.07.

Erosion Control. Contrary to Sections 212.04, 213.04, and 703.04 other than Erosion Control Blankets, Sodding, and Channel Lining, the Department will not measure Erosion Control, including but not limited to, developing, updating, and maintaining a BMP plan for each site; providing a KEPSC-RI qualified inspector; locating, furnishing, installing, inspecting, maintaining, and removing erosion and water pollution control items; Roadway Excavation, Borrow Excavation, Embankment In Place, Topsoil Furnished and Placed, and Spreading Stockpiled Topsoil; Topdressing Fertilizer, Temporary and Permanent Seeding and Protection, Special Seeding Crown Vetch, and Temporary Mulch; Sedimentation Basin and Clean Sedimentation Basin, Silt Trap Type "A" and Clean Silt Trap Type "A"; Silt Trap Type "B" and Clean Silt Trap Type "B"; Silt Trap Type "C" and Clean Silt Trap Type "C"; Temporary Silt Fence and Clean Temporary Silt Fence; Plants, Vines, Shrubs, and Trees; Gabion and Dumped Stone Deflectors and Riffle Structures; Boulders; Temporary Ditches and clean Temporary Ditches; Geotextile Fabric, and all other erosion and water pollution control items required by the BMP or the Engineer, but shall be incidental to applicable items of work.

V. Basis of Payment

Erosion Control Blanket. If not listed as a bid item, but required by the BMP, the Department will pay for Erosion Control Blankets as Extra Work according to Sections 104.03 and 109.04.

Sodding. If not listed as a bid item, but required by the BMP, the Department will pay for Sodding as Extra Work according to Sections 104.03 and 109.04.

Channel Lining. If not listed as a bid item, but required by the BMP, the Department will pay for Channel Lining as Extra Work according to Sections 104.03 and 109.04.

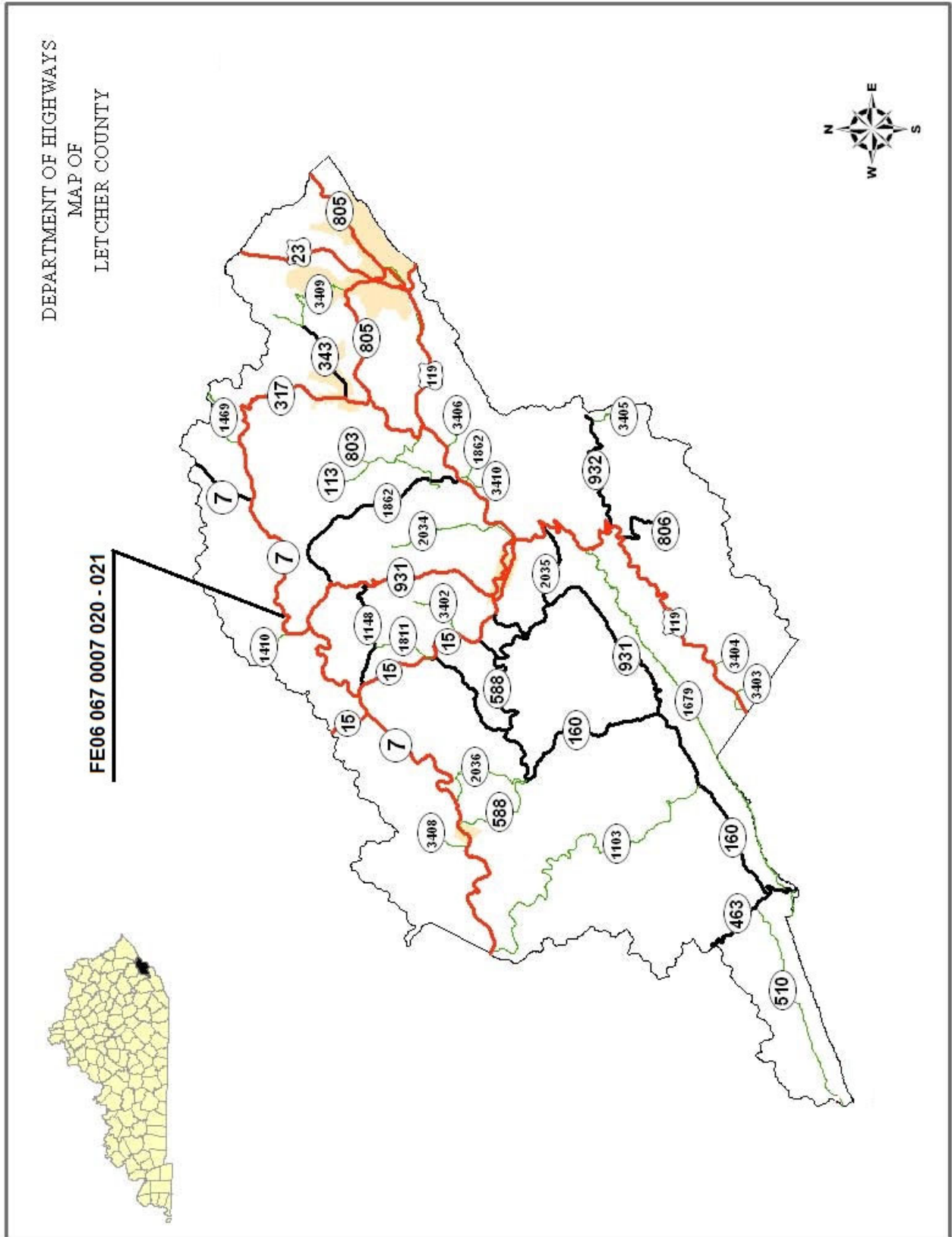

**GUARDRAIL SUMMARY
FE06 067 0007 020-021**

NEW GUARDRAIL						REMOVE GUARDRAIL					
LANE	END TREAT.	BEGIN MILEPOINT	END MILEPOINT	END TREAT.	LIN FEET	REMARKS	LANE	BEGIN MILEPOINT	END MILEPOINT	LIN FEET	REMARKS
C	Type 7	20.128	20.202	Type 7	400.0						
C	Type 7	20.236	20.349	Type 7	600.0						
TOTALS					1,000.0					0.0	

End Treatment Type 1 0
 End Treatment Type 2A 0
 End Treatment Type 3 0
 End Treatment Type 4 0
 End Treatment Type 7 4
 Terminal Section No. 1 0

PART II
SPECIFICATIONS AND STANDARD DRAWINGS

SPECIFICATIONS REFERENCE

Any reference in the plans or proposal to previous editions of the *Standard Specifications for Road and Bridge Construction* and *Standard Drawings* are superseded by *Standard Specifications for Road and Bridge Construction, Edition of 2012* and *Standard Drawings, Edition of 2016*.

SUPPLEMENTAL SPECIFICATIONS

The contractor shall use the Supplemental Specifications that are effective at the time of letting.
The Supplemental Specifications can be found at the following link:

<http://transportation.ky.gov/Construction/Pages/Kentucky-Standard-Specifications.aspx>

2016 APPLICABLE KENTUCKY STANDARD DRAWINGS
FE06 067 0007 020-021

TYPICAL GUARDRAIL INSTALLATIONS..... RBI-002-07
GUARDRAIL COMPONENTSRBR-005-11
GUARDRAIL TERMINAL SECTIONSRBR-010-06
CURVE WIDENING AND SUPERELEVATION TRANSITIONS.....RGS-001-07
MISCELLANEOUS STANDARDS..... RGX-001-06
APPROACHES, ENTRANCE’S, AND MAIL BOX TURNOUTS..... RPM-110-07
LANE CLOSURE TWO-LANE HIGHWAY..... TTC-100-04
SHOULDER CLOSURE TTC-135-02
PAVEMENT CONDITION WARNING SIGNS TTD-125-02

COUNTY OF	ITEM NO.	SHEET

- ~ NOTES ~
1. FOR END TREATMENT TYPE 4A USE CUR. STD. DWG. RBR-035 FOR OFFSETS.
 2. THE MINIMUM LENGTH OF GUARDRAIL, INCLUDING THE END TREATMENT, PRECEDING A FIXED OBJECT IS 200 FEET: (LENGTH MAY BE REDUCED SHOULD FIELD CONDITIONS WARRANT).

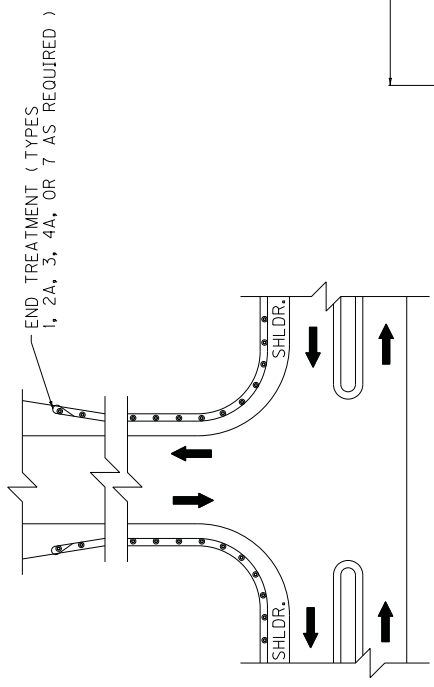

APPROACH ROADS

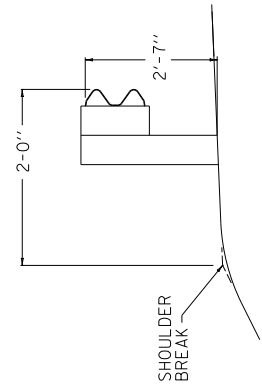

NORMAL GUARDRAIL INSTALLATION

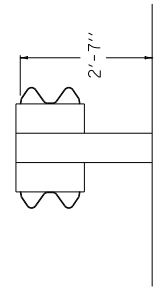

TYPICAL DOUBLE FACE GUARDRAIL INSTALLATION

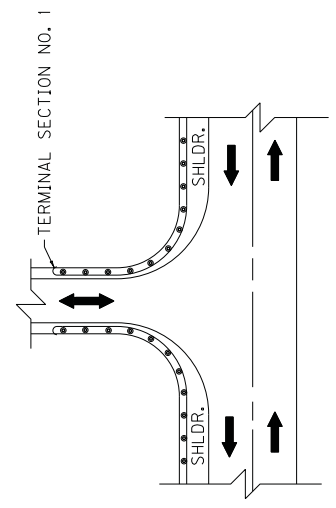

ENTRANCES

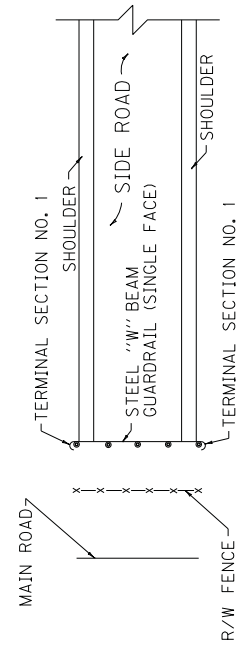

GUARDRAIL USED AS A BARRICADE

USE WITH CUR. STD. DWG.
RBI-002, RBR-035

KENTUCKY
DEPARTMENT OF HIGHWAYS

TYPICAL GUARDRAIL
INSTALLATIONS

SUBMITTED: *[Signature]* DIRECTOR DIVISION OF DESIGN
DATE: 11-17-17

024

COUNTY OF	ITEM NO.	SHEET NO.

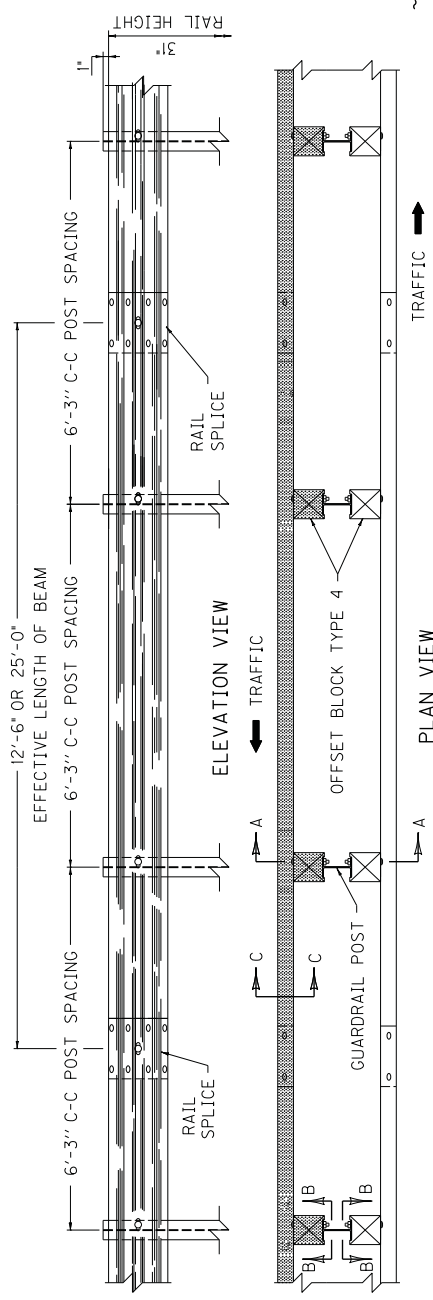

~ NOTES ~

- BID ITEM AND UNIT TO BID
GUARDRAIL-STEEL W BEAM-S FACE LF
OR
GUARDRAIL-STEEL W BEAM-D FACE LF
- DIMENSIONAL TOLERANCES NOT SHOWN OR IMPLIED ARE INTENDED TO BE THOSE CONSISTENT WITH THE PROPER FUNCTIONING OF THE PART, INCLUDING ITS APPEARANCE AND ACCEPTED MANUFACTURING PRACTICES.
 - THE RAIL ELEMENT SHALL COMPLY WITH AASHTO M-180 -CLASS A, TYPE II.
 - ALL LAPS SHALL BE PLACED IN THE DIRECTION OF TRAFFIC FLOW.
 - TOLERANCE + 1/4", -1/4"
 - 8-5/8" x 1/4" LONG BUTTON HEAD BOLTS AND HEX HEAD RECESS NUTS REQUIRED FOR EACH RAIL SPLICE.
 - LENGTH EQUALS POST AND BLOCK WIDTH PLUS 2" FOR BOLT OR 2 1/4" FOR THREADED ROD.
 - GALVANIZED STEEL 104 COMMON COATED NAIL (DRIVE NAIL AT THE TOP OR BOTTOM CENTER OF BLOCK AND POST AFTER BOLT IS INSTALLED).
 - 5/8" x 6" STEEL THREADED ROD AND TWO (2) HEX HEAD NUTS OR 5/8" x 6" BUTTON OR HEX HEAD BOLT AND HEX HEAD NUT.
 - 5/8" x 8" BUTTON HEAD BOLT, HEX HEAD RECESS NUT AND ONE 5/8" ROUND WASHER (TYP.). BOLT SHALL HAVE A MINIMUM THREAD LENGTH OF 2".
 - REQUIRED FOR DOUBLE RAIL.
 - BOTH 12'-6" AND 25' LENGTHS OF "W" BEAM GUARDRAIL SECTIONS WILL BE PERMITTED UNLESS OTHERWISE DIRECTED BY THE ENGINEER.

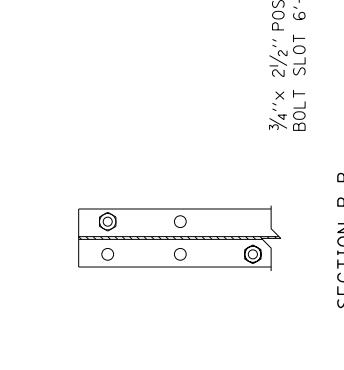
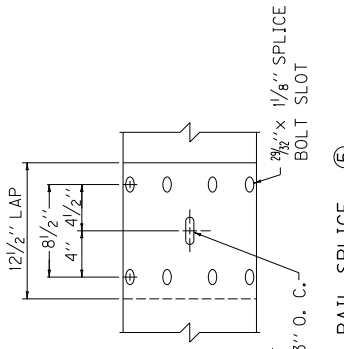
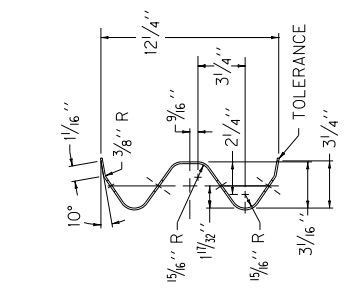

SECTION C-C
(RAIL CORRUGATED SHEET STEEL BEAM)

SECTION B-B

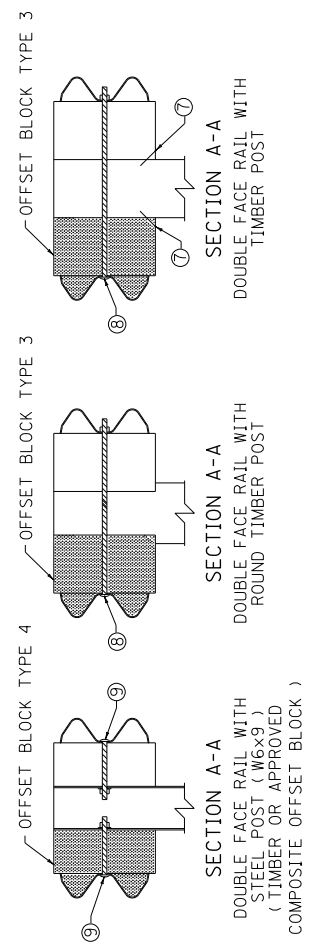

KENTUCKY
DEPARTMENT OF HIGHWAYS
STEEL BEAM
GUARDRAIL
("W" BEAM)
SUBMITTED: <i>Robert P. Schell</i> DIRECTOR DIVISION OF DESIGN 11-17-17 DATE 027

COUNTY OF	_____
TIERING	_____
SHEET	_____

- ~ NOTES ~
- ① W6 X 8.5 IS AN ACCEPTABLE ALTERNATE.
 - ② THESE HOLES ARE REQUIRED FOR ATTACHING RAIL.
 - ③ TIMBER OR COMPOSITE BLOCKOUTS MAY BE USED WITH STEEL POST.

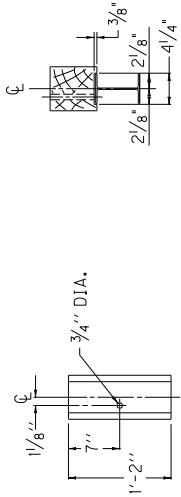
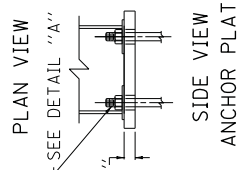
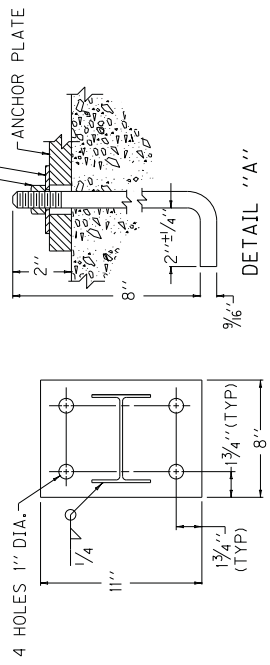
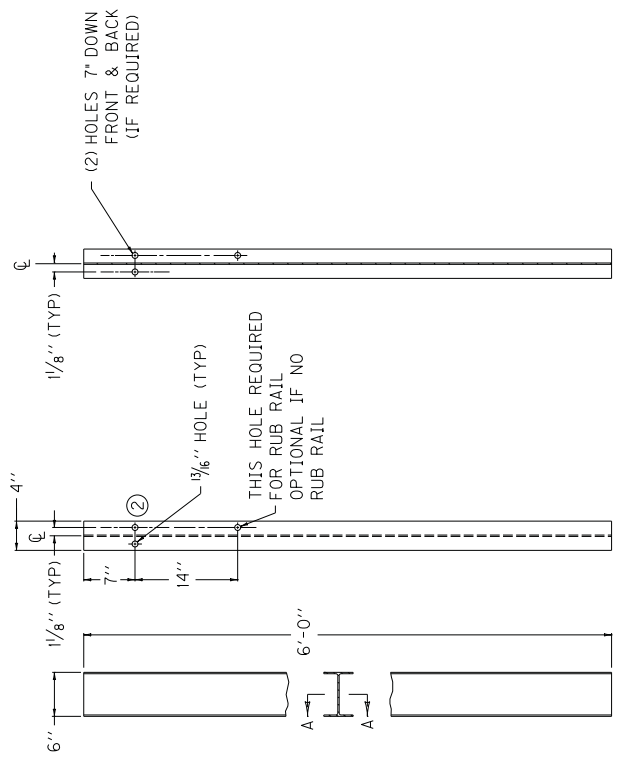

OFFSET BLOCK TYPE 4
6" X 8" (Nominal Size)
(TIMBER OR APPROVED COMPOSITE)
(FOR USE WITH STEEL POST ONLY)

KENTUCKY DEPARTMENT OF HIGHWAYS
STEEL GUARDRAIL POSTS
SUBMITTED: <i>Mark P. Sells</i> DIRECTOR DIVISION OF DESIGN
DATE: 3-06-18
028

COUNTY OF	ITEM NO.	SHEET NO.

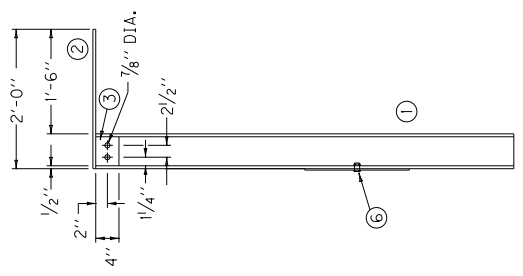

FRONT VIEW

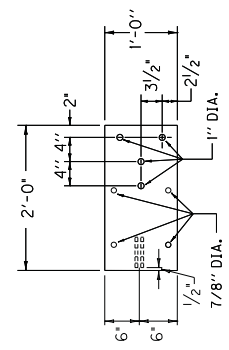

ANCHOR PLATE ASSEMBLY ②

USE WITH CUR. STD. DWG.
RBR-001, RBR-005, RBR-010
RBR-015, RBR-050

KENTUCKY
DEPARTMENT OF HIGHWAYS
GUARDRAIL END TREATMENT TYPE 7
ALTERNATE ANCHOR

SUBMITTED: *[Signature]*
DIRECTOR DIVISION OF DESIGN
DATE: 11-17-17
031

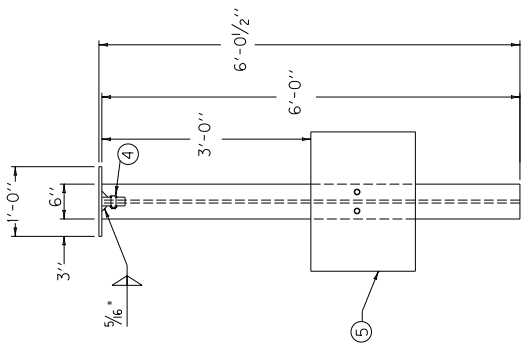

SIDE VIEW

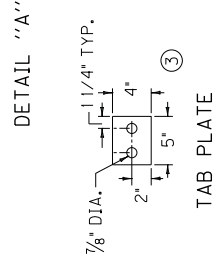

TAB PLATE

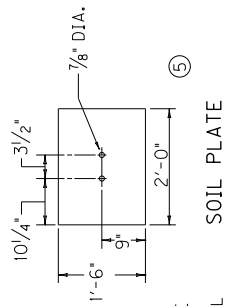

SOIL PLATE

BILL OF MATERIAL	
NO.	DESCRIPTION
①	1 W6x15 W-BEAM
②	1 2' x 1' x 1/2" ANCHOR PLATE ASSEMBLY
③	2 4" x 5" x 1/2" TAB PLATE
④	2 3/4" DIA. x 2 1/2" HEAVY HEX HD BOLT w/NUT & (2) FLAT WASHERS
⑤	1 2' x 18" x 1/4" SOIL PLATE
⑥	2 3/4" DIA. x 2" HEAVY HEX HD BOLT w/NUT & (2) FLAT WASHERS

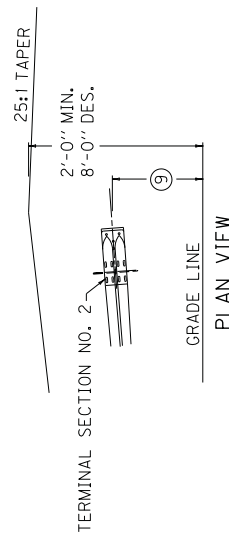

PLAN VIEW

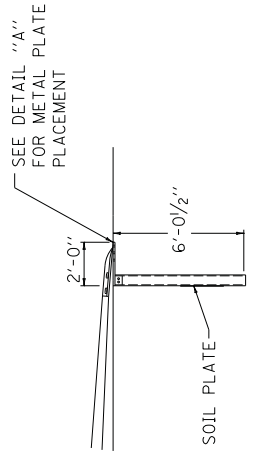

ELEVATION VIEW

~ NOTES ~

- 7. GUARDRAIL END TREATMENT TYPE 7 SHALL BE TO THE PAY LIMITS AS DETAILED AND THE CONTRACT UNIT PRICE EACH SHALL INCLUDE TERMINAL SECTION NO. 2, STEEL "W" BEAM GUARDRAIL (SINGLE FACE), GUARDRAIL POSTS, MI, STEEL ANCHOR PLATE AND POST, SOIL PLATE, TAB PLATES, EXCAVATION, LABOR, HARDWARE AND ALL INCIDENTALS NECESSARY FOR THE INSTALLATION.
- 8. SPLICE BOLTS AT TERMINAL SECTION NO. 2 SHALL BE LOOSELY TIGHTENED AND CENTERED TO ALLOW MAXIMUM MOVEMENT DUE TO EXPANSION. ONE (1) 1/6" ROUND WASHER AND (1) RECTANGULAR PLATE WASHER REQUIRED FOR EACH SPLICE BOLT, AT TERMINAL SECTION NO. 2.
- 9. THE DESIRABLE OFFSET DISTANCE FROM THE NORMAL GUARDRAIL LINE SHALL BE 4'-0". THE MINIMUM OFFSET DISTANCE FROM THE NORMAL GUARDRAIL LINE IS ZERO FEET.
- 10. SEE CUR. STD. DWG. RBR-001, RBR-005, RBR-010 AND RBR-015 FOR APPLICABLE DETAILS AND SPECIFICATIONS.
- 11. LEAVE CLEARANCE IN BETWEEN TAB PLATES FOR GALVANIZED W6 x 15 W-BEAM POST.

BID ITEM AND UNIT TO BID EACH GUARDRAIL END TREATMENT TYPE 7

COUNTY OF	ITEM NO.	SHEET NO.

~ NOTES ~

- BID ITEMS AND UNIT TO BID
 DELINEATOR FOR GUARDRAIL B/W EACH
 DELINEATOR FOR GUARDRAIL M/W EACH
 DELINEATOR FOR GUARDRAIL M/Y EACH
1. DELINEATORS SHALL BE MEASURED AND PAID FOR AT THE CONTRACT UNIT PRICE EACH AND SHALL INCLUDE ALL MATERIALS AND LABOR NECESSARY FOR ONE COMPLETE INSTALLATION.
 2. DELINEATOR SHAPE AND DIMENSIONS ARE SHOWN FOR ILLUSTRATION PURPOSES ONLY. TYPES OF DELINEATORS PERMITTED SHALL BE FROM THE LIST OF APPROVED MATERIALS.
 3. GUARDRAIL DELINEATORS SHALL BE REQUIRED ON ALL GUARDRAIL.
 4. DELINEATORS SHALL NOT BE INSTALLED WITHIN THE PAY LIMITS OF THE END TREATMENT.
 5. DELINEATORS SHALL BE MANUFACTURED FROM 12 GA. GALVANIZED STEEL.
 6. DIMENSIONS SHOWN ARE APPROXIMATE AND ARE SUBJECT TO MANUFACTURER'S TOLERANCES.
 7. WHEN CONCRETE BARRIERS EXTEND ACROSS BRIDGE STRUCTURES IN LIEU OF STEEL BEAM GUARDRAIL, DELINEATORS SHALL BE INSTALLED AT SAME VERTICAL ALIGNMENT AS ON THE GUARDRAIL, AND DELINEATORS SHALL COMPLY WITH CURRENT STANDARD DRAWING RBM-020.
 8. DELINEATORS SHALL BE INSTALLED IN ACCORDANCE WITH MANUFACTURER'S RECOMMENDATIONS.

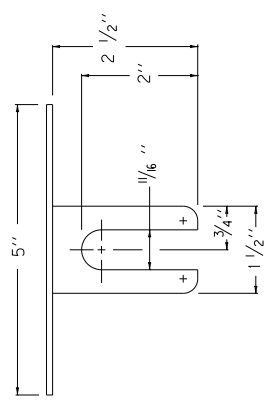

PLAN VIEW

TYPE IX SHEETING,
YELLOW OR WHITE

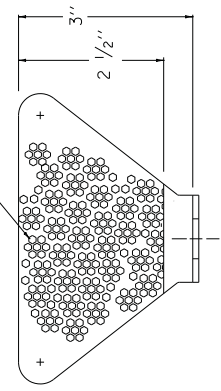

FRONT VIEW

SIDE VIEW

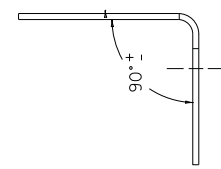

DIMENSIONS SHOWN ARE FOR ONE VERSION OF A WEB-MOUNTED GUARDRAIL DELINEATOR. DELINEATORS WITH ALTERNATE DIMENSIONS MAY BE CONSIDERED FOR INCLUSION ON THE APPROVED PRODUCTS LIST.

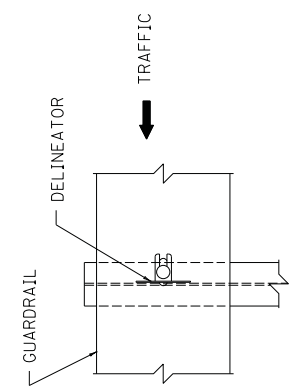

FRONT VIEW

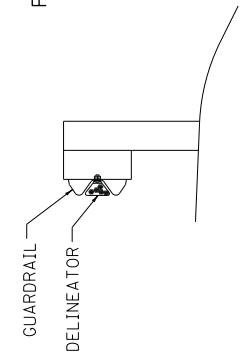

SIDE VIEW

BI-DIRECTIONAL WHITE DELINEATOR FOR GUARDRAIL FACING TRAFFIC

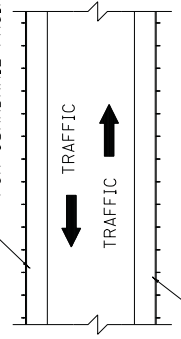

BI-DIRECTIONAL WHITE DELINEATOR FOR GUARDRAIL FACING TRAFFIC

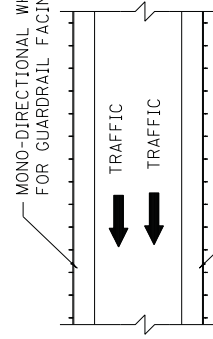

MONO-DIRECTIONAL WHITE DELINEATOR FOR GUARDRAIL FACING TRAFFIC

MONO-DIRECTIONAL YELLOW DELINEATOR FOR GUARDRAIL FACING TRAFFIC

PLACEMENT OF DELINEATORS FOR GUARDRAIL

APPROXIMATE DELINEATOR SPACING	
TANGENT	100'
CURVE	50'

SPACING SHOULD BE ADJUSTED IN CURVES SO THAT SEVERAL DELINEATORS ARE ALWAYS SIMULTANEOUSLY VISIBLE TO THE ROAD USER.

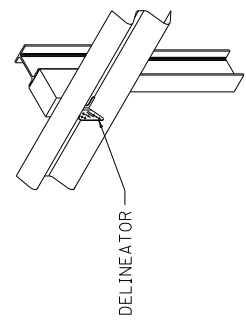

ISOMETRIC VIEW
USE WITH CUR. STD. DWGS.
RBM-020, RBR-060

KENTUCKY
DEPARTMENT OF HIGHWAYS
 DELINEATORS FOR GUARDRAIL

DATE: 11-17-12
 SUBMITTED: [Signature]
 DIRECTOR DIVISION OF DESIGN 032

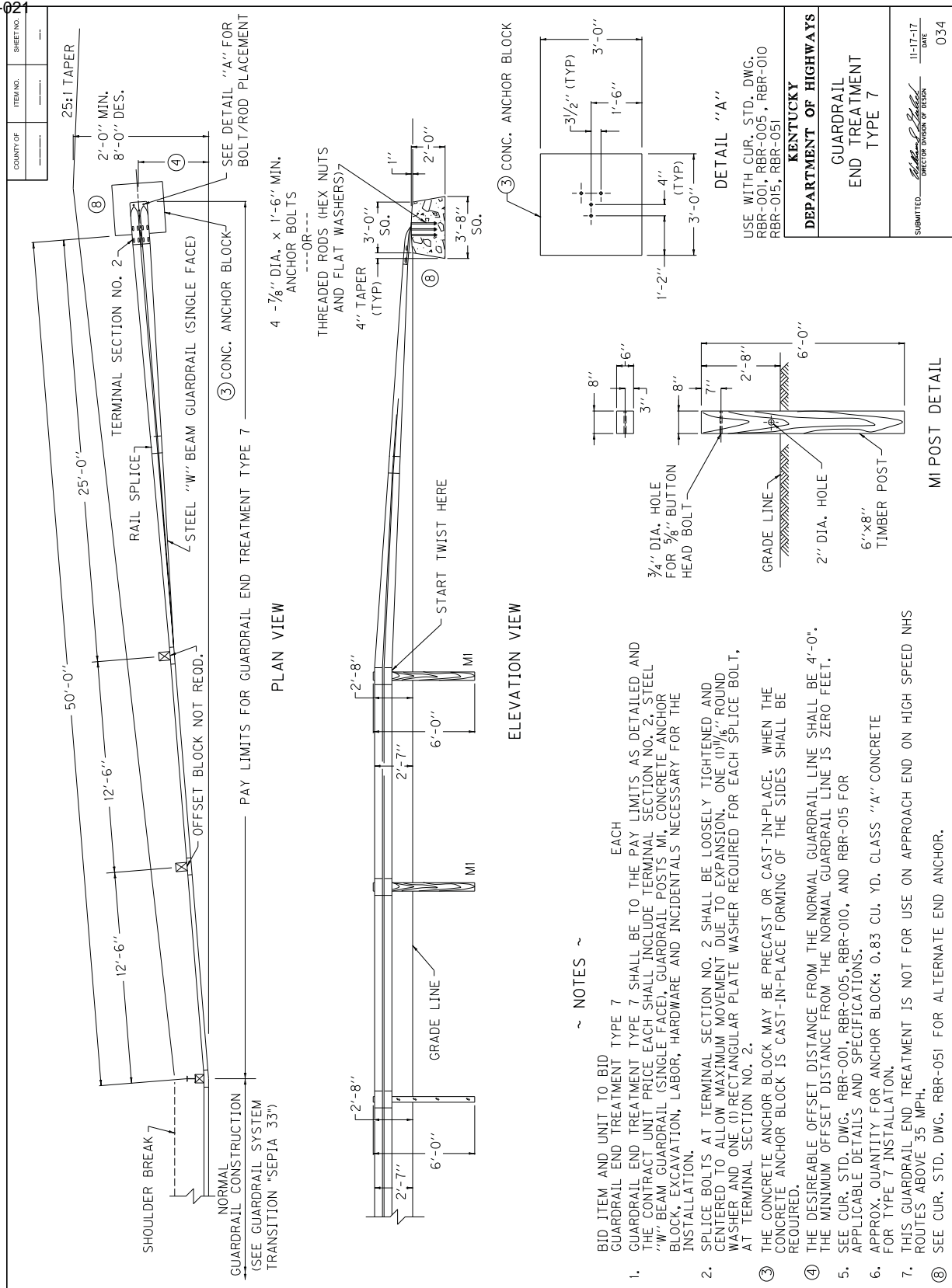

~ NOTES ~

1. BID ITEM AND UNIT TO BID GUARDRAIL END TREATMENT TYPE 7 EACH GUARDRAIL END TREATMENT TYPE 7 SHALL BE TO THE PAY LIMITS AS DETAILED AND THE CONTRACT UNIT PRICE EACH SHALL INCLUDE TERMINAL SECTION NO. 2, STEEL "W" BEAM GUARDRAIL (SINGLE FACE), GUARDRAIL POSTS MI, CONCRETE ANCHOR BLOCK, EXCAVATION, LABOR, HARDWARE AND INCIDENTALS NECESSARY FOR THE INSTALLATION.
2. SPLICE BOLTS AT TERMINAL SECTION NO. 2 SHALL BE LOOSELY TIGHTENED AND CENTERED TO ALLOW MAXIMUM MOVEMENT DUE TO EXPANSION. ONE (1) 1/8" ROUND WASHER AND ONE (1) RECTANGULAR PLATE WASHER REQUIRED FOR EACH SPLICE BOLT, AT TERMINAL SECTION NO. 2.
3. THE CONCRETE ANCHOR BLOCK MAY BE PRECAST OR CAST-IN-PLACE. WHEN THE CONCRETE ANCHOR BLOCK IS CAST-IN-PLACE FORMING OF THE SIDES SHALL BE REQUIRED.
4. THE DESIRABLE OFFSET DISTANCE FROM THE NORMAL GUARDRAIL LINE SHALL BE 4'-0". THE MINIMUM OFFSET DISTANCE FROM THE NORMAL GUARDRAIL LINE IS ZERO FEET.
5. SEE CUR. STD. DWG. RBR-001, RBR-005, RBR-010, AND RBR-015 FOR APPLICABLE DETAILS AND SPECIFICATIONS.
6. APPROX. QUANTITY FOR ANCHOR BLOCK: 0.83 CU. YD. CLASS "A" CONCRETE FOR TYPE 7 INSTALLATION.
7. THIS GUARDRAIL END TREATMENT IS NOT FOR USE ON APPROACH END ON HIGH SPEED NHS ROUTES ABOVE 35 MPH.
8. SEE CUR. STD. DWG. RBR-051 FOR ALTERNATE END ANCHOR.

ELEVATION VIEW

PLAN VIEW

MI POST DETAIL

DETAIL "A"

USE WITH CUR. STD. DWG.
RBR-001, RBR-005, RBR-010
RBR-015, RBR-051

KENTUCKY	
DEPARTMENT OF HIGHWAYS	
GUARDRAIL END TREATMENT TYPE 7	
SUBMITTED: _____	DATE: 11-17-17
DIRECTOR/CHIEF OF DESIGN: _____	034

PART III

EMPLOYMENT, WAGE AND RECORD REQUIREMENTS

**TRANSPORTATION CABINET
DEPARTMENT OF HIGHWAYS**

**LABOR AND WAGE REQUIREMENTS
APPLICABLE TO OTHER THAN FEDERAL-AID SYSTEM PROJECTS**

- I. Application
- II. Nondiscrimination of Employees (KRS 344)

I. APPLICATION

1. These contract provisions shall apply to all work performed on the contract by the contractor with his own organization and with the assistance of workmen under his immediate superintendence and to all work performed on the contract by piecework, station work or by subcontract. The contractor's organization shall be construed to include only workmen employed and paid directly by the contractor and equipment owned or rented by him, with or without operators.

2. The contractor shall insert in each of his subcontracts all of the stipulations contained in these Required Provisions and such other stipulations as may be required.

3. A breach of any of the stipulations contained in these Required Provisions may be grounds for termination of the contract.

3. If the contractor is in control of apprenticeship or other training or retraining, including on-the-job training programs, he shall not discriminate against an individual because of his race, color, religion, national origin, sex, disability or age forty (40) and over, in admission to, or employment in any program established to provide apprenticeship or other training.

4. The contractor will send to each labor union or representative of workers with which he has a collective bargaining agreement or other contract or understanding, a notice to be provided advising the said labor union or workers' representative of the contractor's commitments under this section, and shall post copies of the notice in conspicuous places available to employees and applicants for employment. The contractor will take such action with respect to any subcontract or purchase order as the administering agency may direct as a means of enforcing such provisions, including sanctions for non-compliance.

Revised: January 25, 2017

II. NONDISCRIMINATION OF EMPLOYEES

**AN ACT OF THE KENTUCKY
GENERAL ASSEMBLY TO PREVENT
DISCRIMINATION IN EMPLOYMENT
KRS CHAPTER 344
EFFECTIVE JUNE 16, 1972**

The contract on this project, in accordance with KRS Chapter 344, provides that during the performance of this contract, the contractor agrees as follows:

1. The contractor shall not fail or refuse to hire, or shall not discharge any individual, or otherwise discriminate against an individual with respect to his compensation, terms, conditions, or privileges of employment, because of such individual's race, color, religion, national origin, sex, disability or age (forty and above); or limit, segregate, or classify his employees in any way which would deprive or tend to deprive an individual of employment opportunities or otherwise adversely affect his status as an employee, because of such individual's race, color, religion, national origin, sex, disability or age forty (40) and over. The contractor agrees to post in conspicuous places, available to employees and applicants for employment, notices to be provided setting forth the provisions of this nondiscrimination clause.

2. The contractor shall not print or publish or cause to be printed or published a notice or advertisement relating to employment by such an employer or membership in or any classification or referral for employment by the employment agency, indicating any preference, limitation, specification, or discrimination, based on race, color, religion, national origin, sex, or age forty (40) and over, or because the person is a qualified individual with a disability, except that such a notice or advertisement may indicate a preference, limitation, or specification based on religion, national origin, sex, or age forty (40) and over, or because the person is a qualified individual with a disability, when religion, national origin, sex, or age forty (40) and over, or because the person is a qualified individual with a disability, is a bona fide occupational qualification for employment.

EXECUTIVE BRANCH CODE OF ETHICS

In the 1992 regular legislative session, the General Assembly passed and Governor Brereton Jones signed Senate Bill 63 (codified as KRS 11A), the Executive Branch Code of Ethics, which states, in part:

KRS 11A.040 (7) provides:

No present or former public servant shall, within six (6) months following termination of his office or employment, accept employment, compensation, or other economic benefit from any person or business that contracts or does business with, or is regulated by, the state in matters in which he was directly involved during the last thirty-six (36) months of his tenure. This provision shall not prohibit an individual from returning to the same business, firm, occupation, or profession in which he was involved prior to taking office or beginning his term of employment, or for which he received, prior to his state employment, a professional degree or license, provided that, for a period of six (6) months, he personally refrains from working on any matter in which he was directly involved during the last thirty-six (36) months of his tenure in state government. This subsection shall not prohibit the performance of ministerial functions, including but not limited to filing tax returns, filing applications for permits or licenses, or filing incorporation papers, nor shall it prohibit the former officer or public servant from receiving public funds disbursed through entitlement programs.

KRS 11A.040 (9) states:

A former public servant shall not represent a person or business before a state agency in a matter in which the former public servant was directly involved during the last thirty-six (36) months of his tenure, for a period of one (1) year after the latter of:

- a) The date of leaving office or termination of employment; or
- b) The date the term of office expires to which the public servant was elected.

This law is intended to promote public confidence in the integrity of state government and to declare as public policy the idea that state employees should view their work as a public trust and not as a way to obtain private benefits.

If you have worked for the executive branch of state government within the past six months, you may be subject to the law's prohibitions. The law's applicability may be different if you hold elected office or are contemplating representation of another before a state agency.

Also, if you are affiliated with a firm which does business with the state and which employs former state executive-branch employees, you should be aware that the law may apply to them.

In case of doubt, the law permits you to request an advisory opinion from the Executive Branch Ethics Commission, 3 Fountain Place, Frankfort, Kentucky 40601; telephone (502) 564-7954.

Revised: January 27, 2017

Kentucky Equal Employment Opportunity Act of 1978

The requirements of the Kentucky Equal Employment Opportunity Act of 1978 (KRS 45.560-45.640) shall apply to this Contract. The apparent low Bidder will be required to submit EEO forms to the Division of Construction Procurement, which will then forward to the Finance and Administration Cabinet for review and approval. No award will become effective until all forms are submitted and EEO/CC has certified compliance. The required EEO forms are as follows:

- EEO-1: Employer Information Report
- Affidavit of Intent to Comply
- Employee Data Sheet
- Subcontractor Report

These forms are available on the Finance and Administration's web page under ***Vendor Information, Standard Attachments and General Terms*** at the following address:
<https://www.eProcurement.ky.gov>.

Bidders currently certified as being in compliance by the Finance and Administration Cabinet may submit a copy of their approval letter in lieu of the referenced EEO forms.

For questions or assistance please contact the Finance and Administration Cabinet by email at **finance.contractcompliance@ky.gov** or by phone at 502-564-2874.

EMPLOYEE RIGHTS UNDER THE FAIR LABOR STANDARDS ACT

THE UNITED STATES DEPARTMENT OF LABOR WAGE AND HOUR DIVISION

FEDERAL MINIMUM WAGE

\$7.25

 PER HOUR

BEGINNING JULY 24, 2009

OVERTIME PAY At least 1½ times your regular rate of pay for all hours worked over 40 in a workweek.

CHILD LABOR An employee must be at least **16** years old to work in most non-farm jobs and at least **18** to work in non-farm jobs declared hazardous by the Secretary of Labor.

Youths **14** and **15** years old may work outside school hours in various non-manufacturing, non-mining, non-hazardous jobs under the following conditions:

No more than

- **3** hours on a school day or **18** hours in a school week;
- **8** hours on a non-school day or **40** hours in a non-school week.

Also, work may not begin before **7 a.m.** or end after **7 p.m.**, except from June 1 through Labor Day, when evening hours are extended to **9 p.m.** Different rules apply in agricultural employment.

TIP CREDIT Employers of “tipped employees” must pay a cash wage of at least \$2.13 per hour if they claim a tip credit against their minimum wage obligation. If an employee’s tips combined with the employer’s cash wage of at least \$2.13 per hour do not equal the minimum hourly wage, the employer must make up the difference. Certain other conditions must also be met.

ENFORCEMENT The Department of Labor may recover back wages either administratively or through court action, for the employees that have been underpaid in violation of the law. Violations may result in civil or criminal action.

Employers may be assessed civil money penalties of up to \$1,100 for each willful or repeated violation of the minimum wage or overtime pay provisions of the law and up to \$11,000 for each employee who is the subject of a violation of the Act’s child labor provisions. In addition, a civil money penalty of up to \$50,000 may be assessed for each child labor violation that causes the death or serious injury of any minor employee, and such assessments may be doubled, up to \$100,000, when the violations are determined to be willful or repeated. The law also prohibits discriminating against or discharging workers who file a complaint or participate in any proceeding under the Act.

ADDITIONAL INFORMATION

- Certain occupations and establishments are exempt from the minimum wage and/or overtime pay provisions.
- Special provisions apply to workers in American Samoa and the Commonwealth of the Northern Mariana Islands.
- Some state laws provide greater employee protections; employers must comply with both.
- The law requires employers to display this poster where employees can readily see it.
- Employees under 20 years of age may be paid \$4.25 per hour during their first 90 consecutive calendar days of employment with an employer.
- Certain full-time students, student learners, apprentices, and workers with disabilities may be paid less than the minimum wage under special certificates issued by the Department of Labor.

For additional information:



1-866-4-USWAGE

(1-866-487-9243) TTY: 1-877-889-5627



WWW.WAGEHOUR.DOL.GOV

PART IV
INSURANCE

INSURANCE

The Contractor shall procure and maintain the following insurance in addition to the insurance required by law:

- 1) Commercial General Liability-Occurrence form – not less than \$2,000,000 General aggregate, \$2,000,000 Products & Completed Aggregate, \$1,000,000 Personal & Advertising, \$1,000,000 each occurrence.
- 2) Automobile Liability- \$1,000,000 per accident
- 3) Employers Liability:
 - a) \$100,000 Each Accident Bodily Injury
 - b) \$500,000 Policy limit Bodily Injury by Disease
 - c) \$100,000 Each Employee Bodily Injury by Disease
- 4) The insurance required above must be evidenced by a Certificate of Insurance and this Certificate of Insurance must contain one of the following statements:
 - a) "policy contains no deductible clauses."
 - b) "policy contains _____ (amount) deductible property damage clause but company will pay claim and collect the deductible from the insured."
- 5) **KENTUCKY WORKMEN'S COMPENSATION INSURANCE.** The contractor shall furnish evidence of coverage of all his employees or give evidence of self-insurance by submitting a copy of a certificate issued by the Workmen's Compensation Board.

The cost of insurance is incidental to all contract items. All subcontractors must meet the same minimum insurance requirements.

PART V
BID ITEMS

PROPOSAL BID ITEMS

192049

Page 1 of 1

Report Date 12/27/18

Section: 0001 - GUARDRAIL

LINE	BID CODE	ALT	DESCRIPTION	QUANTITY	UNIT	UNIT PRIC	FP	AMOUNT
0010	01987		DELINEATOR FOR GUARDRAIL BI DIRECTIONAL WHITE	22.00	EACH		\$	
0020	02353		INSTALL GUARDRAIL-STEEL W BM-S FACE	1,000.00	LF		\$	
0030	02371		GUARDRAIL END TREATMENT TYPE 7	4.00	EACH		\$	
0040	02562		TEMPORARY SIGNS	256.00	SQFT		\$	
0050	02650		MAINTAIN & CONTROL TRAFFIC	1.00	LS		\$	

Section: 0002 - DEMOBILIZATION

LINE	BID CODE	ALT	DESCRIPTION	QUANTITY	UNIT	UNIT PRIC	FP	AMOUNT
0060	02569		DEMOBILIZATION	1.00	LS		\$	