



**CALL NO. 319**

**CONTRACT ID. 192910**

**KENTON COUNTY**

**FED/STATE PROJECT NUMBER FD04 059 0075 B00046N**

**DESCRIPTION BRENT SPENCE BRIDGE REPAIRS.**

**WORK TYPE BRIDGE REPAIR MISCELLANEOUS WORK**

**PRIMARY COMPLETION DATE 3/1/2020**

**LETTING DATE: August 23,2019**

Sealed Bids will be received electronically through the Bid Express bidding service until 10:00 AM EASTERN DAYLIGHT TIME August 23,2019. Bids will be publicly announced at 10:00 AM EASTERN DAYLIGHT TIME.

**NO PLANS ASSOCIATED WITH THIS PROJECT.**

**REQUIRED BID PROPOSAL GUARANTY:** Not less than 5% of the total bid.

## TABLE OF CONTENTS

PART I	SCOPE OF WORK
	<ul style="list-style-type: none"><li>• PROJECT(S), COMPLETION DATE(S), &amp; LIQUIDATED DAMAGES</li><li>• CONTRACT NOTES</li><li>• STATE CONTRACT NOTES</li><li>• SPECIAL NOTE(S) APPLICABLE TO PROJECT</li><li>• LIQUIDATED DAMAGES</li><li>• TRAFFIC CONTROL PLAN</li><li>• BRIDGE DRAWINGS</li></ul>
PART II	SPECIFICATIONS AND STANDARD DRAWINGS
	<ul style="list-style-type: none"><li>• SPECIFICATIONS REFERENCE</li><li>• SUPPLEMENTAL SPECIFICATION</li><li>• STANDARD DRAWINGS THAT APPLY</li></ul>
PART III	EMPLOYMENT, WAGE AND RECORD REQUIREMENTS
	<ul style="list-style-type: none"><li>• LABOR AND WAGE REQUIREMENTS</li><li>• EXECUTIVE BRANCH CODE OF ETHICS</li><li>• KENTUCKY EQUAL EMPLOYMENT OPPORTUNITY ACT OF 1978 LOCALITY / STATE</li><li>• PROJECT WAGE RATES / STATE</li></ul>
PART IV	INSURANCE
PART V	BID ITEMS

**PART I**  
**SCOPE OF WORK**

## ADMINISTRATIVE DISTRICT - 06

**CONTRACT ID - 192910**

**FD04 059 0075 B00046N**

**COUNTY - KENTON**

**PCN - MB05900751901**

**FD04 059 0075 B00046N**

BRENT SPENCE BRIDGE REPAIRS. BRIDGE OVER OHIO RIVER. BRIDGE REPAIR MISCELLANEOUS WORK SYP  
NO. 06-00017.07.

GEOGRAPHIC COORDINATES LATITUDE 39:05:26.00 LONGITUDE 84:31:21.00

**COMPLETION DATE(S):**

COMPLETED BY 03/01/2020

APPLIES TO ENTIRE CONTRACT

## **CONTRACT NOTES**

### **PROPOSAL ADDENDA**

All addenda to this proposal must be applied when calculating bid and certified in the bid packet submitted to the Kentucky Department of Highways. Failure to use the correct and most recent addenda may result in the bid being rejected.

### **BID SUBMITTAL**

Bidder must use the Department's electronic bidding software. The Bidder must download the bid file located on the Bid Express website ([www.bidx.com](http://www.bidx.com)) to prepare a bid packet for submission to the Department. The bidder must submit electronically using Bid Express.

### **JOINT VENTURE BIDDING**

Joint venture bidding is permissible. All companies in the joint venture must be prequalified in one of the work types in the Qualifications for Bidders for the project. The bidders must get a vendor ID for the joint venture from the Division of Construction Procurement and register the joint venture as a bidder on the project. Also, the joint venture must obtain a digital ID from Bid Express to submit a bid. A joint bid bond of 5% may be submitted for both companies or each company may submit a separate bond of 5%.

### **UNDERGROUND FACILITY DAMAGE PROTECTION**

The contractor shall make every effort to protect underground facilities from damage as prescribed in the Underground Facility Damage Protection Act of 1994, Kentucky Revised Statute KRS 367.4901 to 367.4917. It is the contractor's responsibility to determine and take steps necessary to be in compliance with federal and state damage prevention directives. When prescribed in said directives, the contractor shall submit Excavation Locate Requests to the Kentucky Contact Center (KY811) via web ticket entry. The submission of this request does not relieve the contractor from the responsibility of contacting non-member facility owners, whom shall be contacted through their individual Protection Notification Center. Non-compliance with these directives can result in the enforcement of penalties.

### **REGISTRATION WITH THE SECRETARY OF STATE BY A FOREIGN ENTITY**

Pursuant to KRS 176.085(1)(b), an agency, department, office, or political subdivision of the Commonwealth of Kentucky shall not award a state contract to a person that is a foreign entity required by [KRS 14A.9-010](#) to obtain a certificate of authority to transact business in the Commonwealth ("certificate") from the Secretary of State under [KRS 14A.9-030](#) unless the person produces the certificate within fourteen (14) days of the bid or proposal opening. If the foreign entity is not required to obtain a certificate as provided in [KRS 14A.9-010](#), the foreign entity should identify the applicable exception. Foreign entity is defined within [KRS 14A.1-070](#).

**For all foreign entities required to obtain a certificate of authority to transact business in the Commonwealth, if a copy of the certificate is not received by the contracting agency within the time frame identified above, the foreign entity's solicitation response shall be deemed non-responsive or the awarded contract shall be cancelled.**

Businesses can register with the Secretary of State at <https://secure.kentucky.gov/sos/ftbr/welcome.aspx>.

### **SPECIAL NOTE FOR PROJECT QUESTIONS DURING ADVERTISEMENT**

Questions about projects during the advertisement should be submitted in writing to the Division of Construction Procurement. This may be done by fax (502) 564-7299 or email to [kytc.projectquestions@ky.gov](mailto:kytc.projectquestions@ky.gov). The Department will attempt to answer all submitted questions. The Department reserves the right not to answer if the question is not pertinent or does not aid in clarifying the project intent.

The deadline for posting answers will be 3:00 pm Eastern Daylight Time, the day preceding the Letting. Questions may be submitted until this deadline with the understanding that the later a question is submitted, the less likely an answer will be able to be provided.

The questions and answers will be posted for each Letting under the heading "Questions & Answers" on the Construction Procurement website ([www.transportation.ky.gov/contract](http://www.transportation.ky.gov/contract)). The answers provided shall be considered part of this Special Note and, in case of a discrepancy, will govern over all other bidding documents.

### **HARDWOOD REMOVAL RESTRICTIONS**

The US Department of Agriculture has imposed a quarantine in Kentucky and several surrounding states, to prevent the spread of an invasive insect, the emerald ash borer. Hardwood cut in conjunction with the project may not be removed from the state. Chipping or burning on site is the preferred method of disposal.

### **INSTRUCTIONS FOR EXCESS MATERIAL SITES AND BORROW SITES**

Identification of excess material sites and borrow sites shall be the responsibility of the Contractor. The Contractor shall be responsible for compliance with all applicable state and federal laws and may wish to consult with the US Fish and Wildlife Service to seek protection under Section 10 of the Endangered Species Act for these activities.

### **ACCESS TO RECORDS**

The contractor, as defined in KRS 45A.030 (9) agrees that the contracting agency, the Finance and Administration Cabinet, the Auditor of Public Accounts, and the Legislative Research Commission, or their duly authorized representatives, shall have access to any books, documents, papers, records, or other evidence, which are directly pertinent to this contract for the purpose of financial audit or program review. Records and other prequalification information confidentially

disclosed as part of the bid process shall not be deemed as directly pertinent to the contract and shall be exempt from disclosure as provided in KRS 61.878(1)(c). The contractor also recognizes that any books, documents, papers, records, or other evidence, received during a financial audit or program review shall be subject to the Kentucky Open Records Act, KRS 61.870 to 61.884.

In the event of a dispute between the contractor and the contracting agency, Attorney General, or the Auditor of Public Accounts over documents that are eligible for production and review, the Finance and Administration Cabinet shall review the dispute and issue a determination, in accordance with Secretary's Order 11-004.

April 30, 2018

## **SPECIAL NOTE FOR RECIPROCAL PREFERENCE**

### **RECIPROCAL PREFERENCE TO BE GIVEN BY PUBLIC AGENCIES TO RESIDENT BIDDERS**

By reference, KRS 45A.490 to 45A.494 are incorporated herein and in compliance regarding the bidders residency. Bidders who want to claim resident bidder status should complete the Affidavit for Claiming Resident Bidder Status along with their bid in the electronic bidding software. Submittal of the Affidavit should be done along the bid in Bid Express.

April 30, 2018



## COORDINATION WITH OTHERS

The District may use the Contractor's lane closures to complete inspections or other work. The Contractor is expected to make any reasonable accommodations necessary. The following inspections/activities will need coordination.

- Fracture Critical inspection
- Asphalt rehabilitation project.

**SPECIAL NOTE FOR CONTRACT COMPLETION DATE AND  
LIQUIDATED DAMAGES ON BRIDGE REPAIR CONTRACTS**

- I. COMPLETION DATE.** The Contractor has the option of selecting the starting date for this Contract. Once selected, notify the Department in writing of the date selected at least two weeks prior to beginning work. All work is to be completed by October 30, 2019. An allotted number of Calendar days are assigned to each structure in this contract as shown below.

<u>STRUCTURE</u>	<u>NO. OF CALENDAR DAYS</u>	<u>COMPLETION DATE</u>
059B00046N	30	October 30, 2019

Contrary to Section 108.07.02, the Engineer will begin charging calendar days for a structure on the day the Contractor starts work or sets up traffic control on that particular structure.

- II. LIQUIDATED DAMAGES.** Liquidated damages will be assessed the Contractor in accordance with the Transportation Cabinet, Department of Highway's 2012 Standard Specifications for Road and Bridge Construction, Section 108.09, when either the allotted number of calendar days or the October 30, 2019 date is exceeded.

**Additionally, Liquidated Damages in the amount of \$10,000 will be assessed to the Contractor for every 15 minutes a lane closure is in effect after the stated time period. Similarly, Liquidated Damages in the amount of \$300,000 will be assessed to the Contractor for any additional weekends beyond the contract allotment of 4 weekends.**

Contrary to the Standard Specifications, liquidated damages will be assessed the Contractor during the months of December, January, February and March when the contract time has expired on any individual bridge or bridges. Contract time will be charged during these months.

All construction must be completed in accordance with the weather limitations specified in Section 606 and/or Section 601 as applicable. No extension of Contract time will be granted due to inclement weather or temperature limitations that occur due to starting work on the Contract or a structure late in the construction season.

## **SPECIAL NOTE FOR TRAFFIC CONTROL ON BRIDGE REPAIR CONTRACTS**

### **I. TRAFFIC CONTROL GENERAL**

Except as provided herein, traffic shall be maintained in accordance with the 2012 Standard Specifications, Section 112. Except for the roadway and traffic control bid items listed, all items of work necessary to maintain and control traffic will be paid at the lump sum bid price to "Maintain and Control Traffic".

Contrary to Section 106.01, traffic control devices used on this project may be new or used in new condition, at the beginning of the work and maintained in like new condition until completion of the work.

### **II. TRAFFIC COORDINATOR**

Furnish a Traffic Coordinator as per Section 112. The Traffic Coordinator shall inspect the project maintenance of traffic, at least three times daily, or as directed by the Engineer, during the Contractor's operations and at any time a lane closure is in place. The personnel shall have access on the project to a radio or telephone to be used in case of emergencies or accidents.

The Traffic Coordinator shall report all incidents throughout the work zone to the Engineer on the project. The Contractor shall furnish the name and telephone number where the Traffic Coordinator can be contacted at all times.

### **III. SIGNS**

Contrary to Section 112.04.02, only long term signs (sign intended to be continuously in place for more than 3 days) will be measured for payment; short term signs (signs intended to be left in place for 3 days or less) will not be measured for payment but will be incidental to Maintain and Control Traffic.

The contractor is to install warning signs for wide loads in advance of the bridge under the direction of the Engineer. The Department will not measure installation, maintenance, or removal for payment, and will consider these incidentals to Maintain and Control Traffic.

### **IV. TEMPORARY PAVEMENT STRIPING**

Skip lines and/or solid lines through the length of the tapers for lane closures and other striping as directed by the Engineer shall be temporarily covered with 6" black removable tape. Permanent removal of all other pavement striping for traffic control shall be considered incidental to Maintain and Control Traffic. Temporary pavement striping shall be paid only once per course in accordance with Section 112.04.07. The Contractor shall replace any temporary striping that becomes damaged or fails to adhere to the pavement before dark on the day of the notification. Liquidated damages shall be assessed to the Contractor at a rate of \$500 per day for failing to replace temporary striping within this time limit.

## **V. PROJECT PHASING & CONSTRUCTION PROCEDURES**

The Contractor shall maintain one lane of traffic on the Parkway at all times in accordance with Standard Drawing No. TTC-120 and the attached detail drawings. The clear lane width required is:

<u>Structure</u>	<u>Clear Lane Width</u>
059B00046N	<u>13</u> feet

Interstate lane closures will not be permitted on these days:  
Labor Day Weekend (Friday-Monday)

## **VI. BARRIER WALL**

Payment of the contract unit price per linear foot for "CONCRETE BARRIER WALL TYPE 9T" shall be full compensation for furnishing, installing, maintaining, adjusting alignment as needed, removing the barrier when no longer needed, and all incidental items necessary to complete the work.

Provide one side mounted barrier wall delineator per each section of barrier. See Standard Drawing RBM-020 for types. No direct payment allowed for delineators.

## **VII. CRASH CUSHION / END TREATMENTS**

To the satisfaction of the Engineer extend Barrier wall out of the clear zone. If Barrier wall is not extended out of the clear zone to the satisfaction of the engineer provide crash cushions / end treatments for the barrier wall.

Provide Barrier end treatments that comply with NCHRP 350 LEVEL 3.

# TRANSPORTATION CABINET DEPARTMENT OF HIGHWAYS DISTRICT 6 KENTON CO., KY. / HAMILTON CO., OH. COVINGTON - CINCINNATI BRENT SPENCE BRIDGE REPAIR PLANS

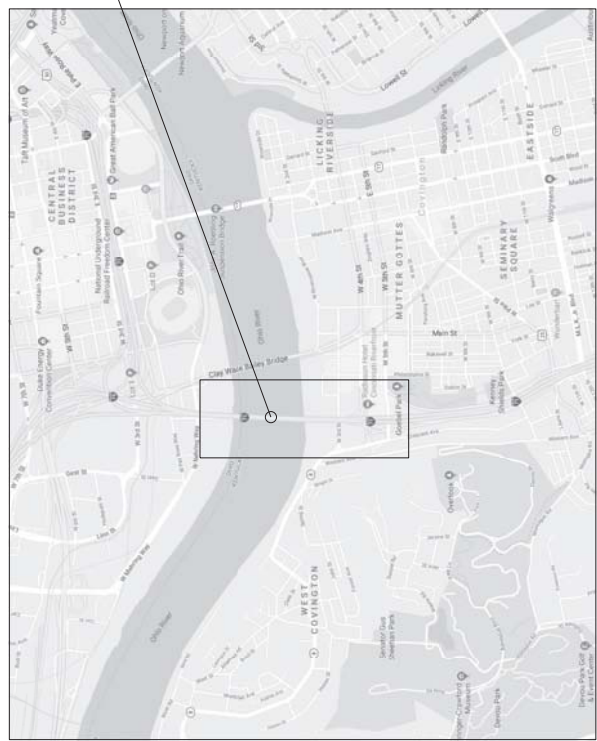

**BRIDGE SITE**  
**LATITUDE: 39°05'27" NORTH**  
**LONGITUDE: 84°31'22" WEST**

INDEX OF SHEETS	
Sheet No.	Description
S1	TITLE SHEET
S2	ESTIMATE OF QUANTITIES
S3	GENERAL NOTES
S4	LAYOUT - REPAIR LOCATIONS
S159	FINGER DAM BOLT REPLACEMENT
S10	FINGER DAM STRAP PLATES
S10	REPAIR OF FINGER DAM
S12	STRONGER BEARING STIFFENER
MT1-MT2	MAINTENANCE OF TRAFFIC NOTES
MT3-MT6	MOT PHASE 1
MT7-MT10	MOT PHASE 2
MT11	4TH STREET DETOUR
MT12	HWY 50 DETOUR
<b>SPECIAL NOTES</b>	
<b>SPECIAL PROVISIONS</b>	
4. Welding Steel Bridges	
<b>STANDARD DRAWINGS</b>	
RBE-103	Crash Cushion Type VI-B1
RBE-104	Crash Cushion Type VI-B1 (Type III, Impact 50 kJ)
RBE-105	Box Beam 517 (Type III, Impact 50 kJ) Concrete Barrier
TIC-115-03	Leak Closure Multi-Lane Highway Class 1
<b>SPECIFICATIONS</b>	
2012 Standard Specifications for Road and Bridge Construction with current Supplemental Specifications	
2002 AASHTO Standard Specifications for Highway Bridges with current Inter-lms.	

  
 DAVID EDWARD RUST  
 P. E. 28354  
 05/03/2019

Digitally signed by  
 David Rust  
 Date: 2019.05.03  
 1543317-04000

ITEM NUMBER	6-17.07
BRIDGE ID	059B00046N

REVISION	DATE	CHECKED BY
<b>Commonwealth of Kentucky</b>		
<b>DEPARTMENT OF HIGHWAYS</b>		
COUNTY		
<b>KENTON</b>		
CROSSING		
<b>OHIO RIVER</b>		
<b>TITLE SHEET</b>		
ROUTE	PREPARED BY	
1-71 / 1-79	PALMER ENGINEERING CO.	
SHEET NO.		28039

**NOTES**

PAYMENT FOR STRUCTURAL STEEL REPAIRS: THE UNIT PRICES BID FOR ALL QUANTITIES SHALL BE FULL PAYMENT FOR ALL STRUCTURAL STEEL, BOLTS, WASHERS, SHIM PLATES, WELDING AND WELD MATERIALS, DRILLING, GRINDING, CUTTING, AND FINISHING. THE CONTRACTOR SHALL BE RESPONSIBLE FOR ALL MATERIALS AND LABOR NECESSARY TO COMPLETE EACH ITEM OF WORK IN ACCORDANCE WITH THE PLANS AND SPECIFICATIONS.

COMPLETION OF THE STRUCTURE: THE CONTRACTOR IS REQUIRED TO COMPLETE THE STRUCTURE IN ACCORDANCE WITH THE PLANS AND SPECIFICATIONS. MATERIAL, LABOR, OR CONSTRUCTION OPERATIONS NOT OTHERWISE SPECIFIED, SHALL BE INCLUDED IN THE BID ITEM MOST APPROPRIATE TO THE WORK INVOLVED.

**ESTIMATE OF BRIDGE QUANTITIES**

BID ITEM CODE	21659NN	08536	04003	24879EC
	Bolt Replacement	Conc Class M Full	Remove Concrete	Steel Repair
UNIT	EA	CUYD	CUYD	EACH
Finger Dam Bolt Replacement	1700	2.5	7.5	1
Finger Dam Strap Plate				1
Finger Dam Support Member				1
Stringer Brg. Support				
<b>BRIDGE TOTALS</b>	1700	2.5	7.5	3

**ESTIMATE OF ROADWAY QUANTITIES**

BID ITEM CODE	02562	02650	02654	02671	02775	06549	06550	06551
	TEMPORARY SIGNS	MAINTAIN AND CONTROL TRAFFIC	TRUCK MOUNTED ATTENUATOR	PORTABLE CHANGEABLE MESSAGE SIGN	ARROW PANEL	PAVE STRIPING - TEMP REM TAPE-B	PAVE STRIPING - TEMP REM TAPE-W	PAVE STRIPING - TEMP REM TAPE-Y
UNIT	SQFT	LS	EACH	EACH	EACH	LF	LF	LF
GENERAL	1350	1	4	2	4	800	800	400
<b>BRIDGE TOTALS</b>	1350	1	4	2	4	800	800	400

DATE	REVISION	CHECKED BY
JUNE, 2018		DANON / RUST
DESIGNED BY: RUST / RUFENER		DANON / RUST
DETAILED BY: J. ROSE		DANON / RUST
<b>Commonwealth of Kentucky</b>		
<b>DEPARTMENT OF HIGHWAYS</b>		
<b>KENTON COUNTY</b>		
ROUTE	CROSSING	
71 / I-75	OHIO RIVER	
<b>ESTIMATE OF QUANTITIES</b>		
PREPARED BY		
<b>PALMER ENGINEERING CO.</b>		
SHEET NO.	CONTRACT NO.	
28039	059B00046N	

ITEM NUMBER	6-17.07
BRIDGE ID	059B00046N

**GENERAL NOTES**

REFERENCES TO THE SPECIFICATIONS ARE TO THE 2012 EDITION OF THE KENTUCKY DEPARTMENT OF HIGHWAYS STANDARD SPECIFICATIONS FOR ROAD AND BRIDGE CONSTRUCTION INCLUDING ANY CURRENT SUPPLEMENTAL SPECIFICATIONS FOR HIGHWAY BRIDGES, WITH INTERIMS. ALL REFERENCES TO THE EDITION OF THE ASHTO STANDARD SPECIFICATIONS FOR HIGHWAY BRIDGES, WITH INTERIMS, ALL REFERENCES TO THE ASHTO STANDARD SPECIFICATIONS ARE TO THE CURRENT EDITION OF THE ASTM STANDARD SPECIFICATIONS, WITH INTERIMS. MATERIALS: ASTM OR ASHTO SPECIFICATIONS, CURRENT EDITION, AS DESIGNATED IN THE PLANS AND SPECIFICATIONS SHALL GOVERN THE MATERIALS FURNISHED.

DIMENSIONS: DIMENSIONS SHOWN ON THESE PLANS ARE TAKEN FROM THE ORIGINAL CONSTRUCTION CONTRACT PLANS AND SHOP DRAWINGS; THEY DO NOT NECESSARILY REFLECT REVISIONS MADE DURING CONSTRUCTION OR REPAIRS PREVIOUSLY INSTALLED. THE CONTRACTOR SHALL VERIFY ELEVATIONS AND DIMENSIONS, INCLUDING DIMENSIONS OF FABRICATING STEELWORK, ALL DIMENSIONS ARE FOR A NORMAL TEMPERATURE OF 60°F. LAYOUT DIMENSIONS ARE HORIZONTAL DIMENSIONS.

BRIDGE PLANS: A COPY OF AVAILABLE ORIGINAL BRIDGE CONSTRUCTION PLANS AND SHOP DRAWINGS WILL BE MADE AVAILABLE TO THE SUCCESSFUL BIDDER UPON WRITTEN REQUEST. THE COMPLETENESS OF THESE DRAWINGS IS NOT GUARANTEED, AND NO RESPONSIBILITY IS ASSUMED BY THE DEPARTMENT OF HIGHWAYS FOR THEIR ACCURACY.

ON SITE INSPECTION: EACH CONTRACTOR SUBMITTING A BID FOR THIS WORK SHALL MAKE A THOROUGH INSPECTION OF THE BRIDGE AND THE WORK SITE PRIOR TO SUBMITTING A BID AND SHALL BE THOROUGHLY FAMILIAR WITH THE PLANS AND SPECIFICATIONS. THE CONTRACTOR SHALL BE RESPONSIBLE FOR VERIFYING THE ACCURACY OF THE SUBMISSION OF A BID WILL BE CONSIDERED EVIDENCE OF THIS INSPECTION HAVING BEEN MADE. ANY CLAIMS FROM SITE CONDITIONS WILL NOT BE HONORED BY THE DEPARTMENT OF HIGHWAYS.

VERIFYING FIELD CONDITIONS: PLAN DIMENSIONS AND DETAILS RELATIVE TO THE EXISTING STRUCTURE ARE SUBJECT TO NORMAL CONSTRUCTION VARIATIONS. IT SHALL BE THE CONTRACTOR'S RESPONSIBILITY TO VERIFY THE ACCURACY OF THE EXISTING STRUCTURE. SUCH VARIATIONS SHALL NOT BE CAUSE FOR ADDITIONAL COMPENSATION FOR A CHANGE IN THE SCOPE OF THE WORK, HOWEVER THE CONTRACTOR WILL BE PAID FOR THE EXTRA WORK REQUIRED TO CORRECT DEFICIENCIES. UNDERLAIN FORMULAS MAY BE APPLIED PROVIDED THAT THE REQUIREMENTS OF ARTICLE 104.02.02 OF THE STANDARD SPECIFICATIONS ARE SATISFIED.

COOPERATION BY CONTRACTORS: THE CONTRACTOR IS ADVISED THAT THERE ARE ONGOING HIGHWAY PROJECTS ADJACENT TO AND POTENTIALLY WITHIN THE LIMITS OF THIS PROJECT. THE CONTRACTOR IS ALSO ADVISED THAT ADDITIONAL CONTRACTS MAY BE LET WITHIN THE PROJECT LIMITS PRIOR TO THE COMPLETION OF THIS PROJECT. CONTRACTORS WORKING ON THE SAME PROJECT OR ADJACENT PROJECTS SHALL COOPERATE WITH EACH OTHER. MAINTAINING TRAFFIC: SEE MAINTENANCE OF TRAFFIC PLANS AND MAINTENANCE OF TRAFFIC NOTES.

RIVER NAVIGATION: CONTINUOUS MAINTENANCE AND SAFETY OF RIVER NAVIGATION THROUGHOUT THE TERM OF THE CONTRACT IS THE RESPONSIBILITY OF THE CONTRACTOR. THE CONTRACTOR SHALL BE RESPONSIBLE FOR VERIFYING THAT TRAFFIC IS CLEAR OF THE BRIDGE AREA.

AT LEAST 30 DAYS IN ADVANCE OF BEGINNING CONSTRUCTION, THE SUCCESSFUL CONTRACTOR SHALL SUBMIT TO THE DEPARTMENT FOR SUBMITTAL TO THE COAST GUARD A WORK PLAN FOR PERFORMING WORK OVER THE OHIO RIVER. THIS WORK PLAN SHALL INCLUDE BUT IS NOT LIMITED TO METHODS FOR CONTAINING DEBRIS, BELOW DECK ACCESS PROCEDURES, AND MAINTENANCE OF EXISTING NAVIGATIONAL TRAFFIC BARRING CONSTRUCTION.

THE CONTRACTOR MUST ADVISE THE COAST GUARD OF THE CONTRACTOR'S PROPOSED SCHEDULE OF WORK AT LEAST 10 DAYS PRIOR TO THE COMMENCEMENT OF ANY FIELD OPERATIONS. THE NOTIFICATION SHALL BE ADDRESSED TO:  
WESTERN RIVERS BRIDGE BRANCH  
1222 SPROULS STREET, SUITE C1  
ST. LOUIS, MISSOURI 63103  
PHONE: 314-269-2378

FALL PROTECTION: PROVIDE FLOORING FOR WORKERS IN SITUATIONS WHERE THE DANGER FROM A FALL IS NEARLY CERTAIN. THE FLOORING IS TO BE DESIGNED USING THE SUM OF DEAD LOAD AND LIVE VERTICAL LOADS, INCLUDING 50 PSF ON HORIZONTAL SURFACES AND THE WEIGHT OF ANY MATERIAL OR EQUIPMENT THAT IS PLACED OR ALLOWED TO FALL DURING CONSTRUCTION OR DEMOLITION OF THE BRIDGE. THE CONTRACTOR SHALL BE RESPONSIBLE FOR FURNISHING AND REMOVING THE FLOORING AS INCIDENTAL TO THE CONTRACT. THIS ITEM MAY BE CONSIDERED IN ADDITION TO ANY REQUIREMENT SET FORTH IN SUBSECTION 107.01.01 OF THE SPECIFICATIONS.

EXISTING STEEL REINFORCEMENT: THE COST OF CUTTING, BENDING, AND CLEANING EXISTING STEEL REINFORCEMENT SHALL BE INCIDENTAL TO THE REPAIR ITEM BEING COMPLETED.

MILL TEST REPORTS: NOTARIZED MILL TEST REPORTS SHALL BE FURNISHED IN TRIPLICATE TO THE DEPARTMENT SHOWING THAT ALL STRUCTURAL STEEL CONFORMS TO THE REQUIREMENTS OF THE PLANS AND SPECIFICATIONS. WELDING SPECIFICATIONS: ALL WELDING AND WELDING MATERIALS EXCEPT FOR REINFORCEMENT, SHALL CONFORM TO JOINT SPECIFICATION ANSI/AASHTO/AWS D1.5-2015 BRIDGE WELDING CODE. MODIFICATION AND ADDITIONS AS STATED ON THE PLANS SHALL SUPERSEDE THE JOINT SPECIFICATIONS.

PROHIBITED FIELD WELDING: EXCEPT WHERE SHOWN IN THE PLANS, NO WELDING OF ANY NATURE SHALL BE PERFORMED ON THE LOAD CARRYING MEMBERS OF THE BRIDGE WITHOUT THE WRITTEN CONSENT OF THE DIRECTOR. ALL WELDING SHALL BE DONE IN THE MANNER AND THEN ONLY IN THE LOCATIONS DESIGNATED IN THE AUTHORIZATION. WELDING REINFORCEMENT: THE WELDING AND WELD MATERIAL SHALL CONFORM TO THE REQUIREMENTS PRACTICES FOR WELDING REINFORCING STEEL AMERICAN WELDING SOCIETY SPECIFICATIONS. CURRENT EDITION, NO DIRECT PAYMENT SHALL BE MADE FOR WELDING OR WELD MATERIAL, BUT THE COST OF THESE ITEMS SHALL BE INCLUDED IN THE UNIT PRICE BID FOR THE REPAIR BEING COMPLETED.

WELDING PROCEDURES: QUALIFICATION TEST OF ALL WELDING PROCEDURES, WHEN REQUIRED BY AWS, SHALL BE COMPLETED BY THE CONTRACTOR AND APPROVED BY THE ENGINEER PRIOR TO THE FINAL APPROVAL OF THE SHOP DRAWINGS AND THE START OF THE FABRICATION.

REMOVAL OF EXISTING RIVETS AND BOLTS: THE CONTRACTOR WILL BE PERMITTED TO REMOVE RIVETS AND BOLTS IN ANY MANNER THAT DOES NOT DAMAGE ADJACENT STRUCTURAL STEEL. THIS MAY INCLUDE MECHANICAL REMOVAL OR OTHER METHODS APPROVED BY THE ENGINEER. USE OF CUTTING TORCHES WILL NOT BE PERMITTED.

HIGH STRENGTH BOLT CONNECTIONS: UNLESS OTHERWISE SPECIFIED ON THE PLANS, ALL BOLTED CONNECTIONS SHALL BE AS SHOWN ON THE PLANS. BOLTED CONNECTIONS SHALL BE MADE WITH HIGH STRENGTH BOLTS AND NUTS. THE BOLTED CONNECTIONS SHALL BE MADE FROM THE SHEAR PLANE IN ALL BOLTED CONNECTIONS, UNLESS OTHERWISE NOTED. BOLT TIGHTENING SHALL BE ENCLOSED FROM TYPE 1 MECHANICALLY GALVANIZED BOLTS SHALL BE USED AS DESCRIBED IN ASHTO M 164. ALL HIGH STRENGTH BOLTED CONNECTIONS ARE TO BE INSTALLED USING DIRECT TENSION INDICATORS (DTI) IN ACCORDANCE WITH THE STANDARD SPECIFICATIONS AND ASTM F959. ALL DTI'S SHALL BE MECHANICALLY ZINC COATED. INSTALLATION DETAILS OF THE DTI'S SHALL BE SHOWN ON THE SHOP PLANS.

SHOP DRAWINGS: THE CONTRACTOR IS TO SUBMIT DETAILED SHOP DRAWINGS AND MATERIAL SPECIFICATIONS FOR APPROVAL. THE CONTRACTOR SHALL BE RESPONSIBLE FOR OBTAINING APPROVAL FROM THE DEPARTMENT FOR APPROVAL OF ALL MATERIALS AND SPECIFICATIONS. THE CONTRACTOR SHALL BE RESPONSIBLE FOR OBTAINING APPROVAL FROM THE FABRICATOR TO THE SUPPLIER, OF THE STANDARD SPECIFICATIONS, WHEN ANY CHANGES ARE PROPOSED BY THE CONTRACTOR THROUGH THE SUPPLIER. THE SHOP DRAWINGS REFLECTING THESE CHANGES SHALL BE SUBMITTED TO THE DEPARTMENT THROUGH THE CONTRACTOR.

RESIDUAL LEAD: RESIDUAL LEAD PAINT MAY STILL BE ON THE STRUCTURE. THE CONTRACTOR IS ADVISED TO TAKE ALL NECESSARY PROTECTIVE MEASURES INCLUDING WORKER SAFETY AND ENVIRONMENTAL REGULATIONS WHEN REMOVING LEAD PAINT. LEAD PAINT REMOVAL SHALL BE PERFORMED IN ACCORDANCE WITH THE STANDARD SPECIFICATIONS ON RESIDUAL LEAD PAINT.

CLEANING AND PAINTING: ALL EXISTING EXPOSURE SURFACES WHERE NEW STEEL IS TO BE INSTALLED SHALL BE CLEANED AND RECEIVE THE PRIME COAT AS SPECIFIED IN SECTION 607.03.23 OF THE SPS. COMMERCIAL GRADE POWER TOOL CLEANING, ALL POWER TOOLS SHALL BE EQUIPPED WITH VACUUM SHROUDS AND FITTED WITH HEPA FILTERS AT THE AIR EXHAUSTS. MAINTAIN AND OPERATE ALL VACUUM SHROUDED POWER TOOLS TO COLLECT GENERATED DEBRIS.

PREPARE AND PRIME NEW STRUCTURAL STEEL: NEW STRUCTURAL STEEL SHALL RECEIVE SHOP SURFACE PREPARATION AND PRIME COAT AS SPECIFIED IN SECTION 607.03.23 OF THE SPS. FINISH COAT SHALL BE APPLIED TO ALL NEW STEEL PRIME COAT SPECIFIED, NECESSARY TOUCH UP REPAIR OF THE SHOP APPLIED PRIME COAT ON NEW STEEL MAY BE PERFORMED IN THE FIELD. FINISH COATINGS WILL BE FIELD APPLIED BY OTHERS AS PART OF A SEPARATE CONTRACT.

ALL COSTS FOR CLEANING AND PAINTING THE NEW AND EXISTING STEEL SHALL BE INCIDENTAL TO THE UNIT PRICE BID FOR THE MOST APPLICABLE BID ITEMS.

PAINTING DAMAGED AREAS: ALL AREAS OF NEW OR EXISTING STRUCTURAL STEEL ON WHICH THE PAINT HAS BEEN DAMAGED BY THE CONTRACTOR SHALL BE CLEANED AND SPOT PAINTED TO THE SATISFACTION OF THE ENGINEER. THE COST OF THIS TOUCH-UP PAINTING IS TO BE INCIDENTAL TO THE CONTRACT.

DISPOSAL OF MATERIALS: ALL MATERIALS AND DEBRIS REMOVED FROM OR BENEATH THE BRIDGE SHALL BECOME THE PROPERTY OF THE CONTRACTOR AND SHALL BE REMOVED FROM THE RIGHT-OF-WAY.

DAMAGE OUTSIDE CONSTRUCTION LIMITS: ANY AREA THAT IS DISTURBED OUTSIDE THE LIMITS OF THE CONSTRUCTION SHALL BE RESTORED TO ORIGINAL CONDITION. THE CONTRACTOR SHALL BE RESPONSIBLE FOR THE COST OF SUCH DAMAGE RESULT FROM THE CONTRACTOR'S ACTIONS.

DAMAGE TO THE STRUCTURE: THE CONTRACTOR SHALL BEAR FULL RESPONSIBILITY AND EXPENSE FOR REPAIR OF ANY AND ALL DAMAGES TO THE STRUCTURE, SHOULD SUCH DAMAGE RESULT FROM THE CONTRACTOR'S ACTIONS, AFTER COMPLETION OF ALL OPERATIONS. THE STRUCTURE SHALL BE LEFT IN A CONDITION THAT IS IN ACCORDANCE WITH SECTION 105.12 OF THE SPECIFICATIONS.

UTILITY PROTECTION: IF PRESENT, ANY ACTIVE UTILITY DUCTS AND ELECTRICAL CONDUIT SHALL BE REPAIRED AT THE CONTRACTOR'S EXPENSE.

DATE: JUNE, 2018	REVISION	DATE
DESIGNED BY: D. RUST	J. RUEFNER	CHECKED BY
DETAILED BY: J. ROSE	D. RUST	
<b>Commonwealth of Kentucky</b> <b>DEPARTMENT OF HIGHWAYS</b>		
COUNTY <b>KENTON</b>		
ROUTE <b>71 / I-75</b>	CROSSING <b>OHIO RIVER</b>	
<b>GENERAL NOTES</b>		
PREPARED BY <b>PALMER ENGINEERING CO.</b>		
SHEET NO. <b>28039</b>		

ITEM NUMBER	
6-17.07	
BRIDGE ID	
059B00046N	

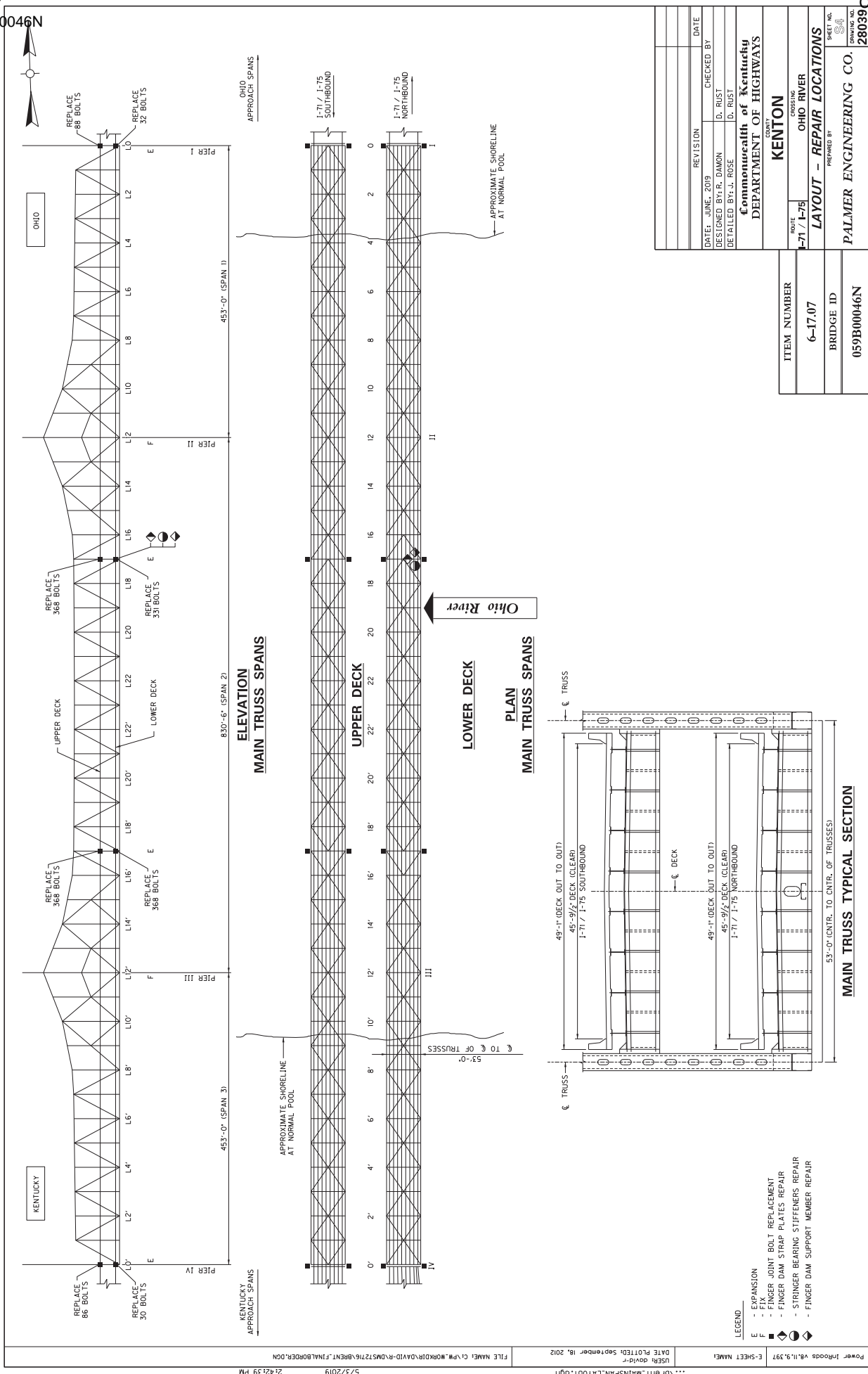

5/3/2019 2:42:39 PM  
 FILE NAME: C:\PM\WORKDIR\DAVID-R\DM57216\BRENT\_FINAL\BDRGN.DGN  
 USER: MAINSPAN.LAYOUT.dgn  
 DATE PLOTTED: September 18, 2012

C-SHEET NAME: 6-17.07  
 Power InRoads 8.11.9.337



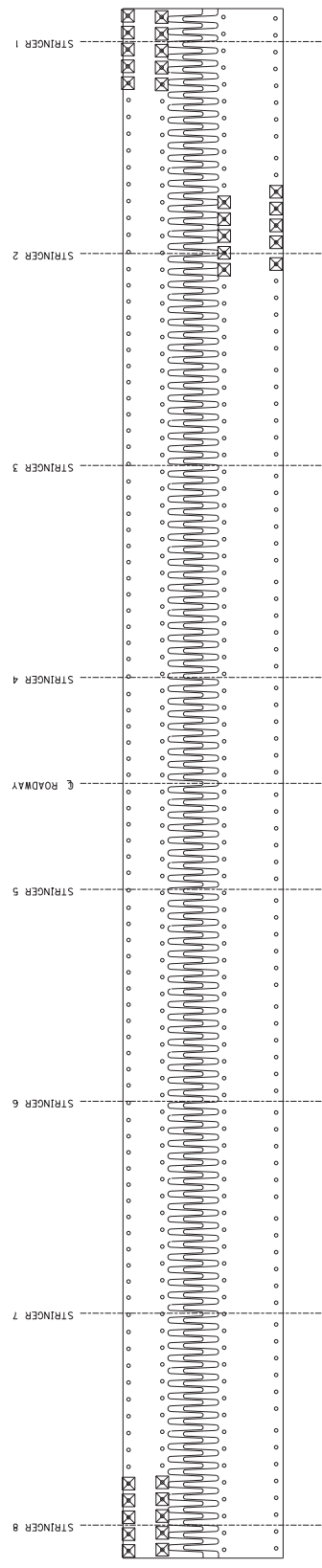

**LOWER DECK - PPO'**

30 BOLTS TO BE REPLACED  
ALL BOLTS ARE 8" IN LENGTH UNLESS OTHERWISE NOTED.

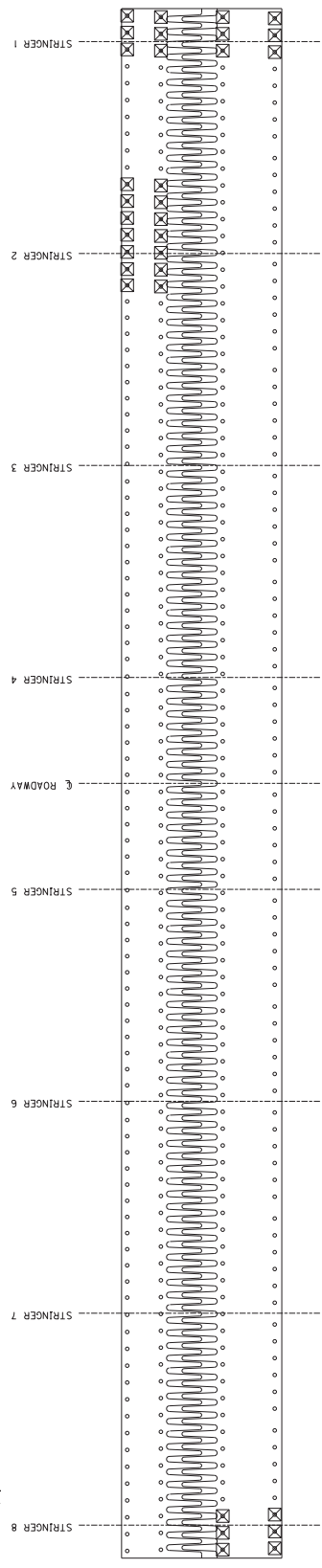
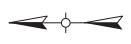

**LOWER DECK - PPO'**

32 BOLTS TO BE REPLACED  
ALL BOLTS ARE 8" IN LENGTH UNLESS OTHERWISE NOTED.

**NOTES**

- SEE SHEET S9 FOR FINGER DAM BOLT INSTALLATION DETAILS.
- LOCATION OF TRUSS STRINGERS IS APPROXIMATE.

**LEGEND**

☒ - DENOTES BOLT TO BE REPLACED

DATE: JUNE, 2019	REVISION	DATE
DESIGNED BY: R. DAMON		CHECKED BY
DETAILED BY: J. ROSE		D. RUST
<b>Commonwealth of Kentucky</b> DEPARTMENT OF HIGHWAYS		
COUNTY <b>KENTON</b>		
ROUTE	CROSSING	
71 / I-75	OHIO RIVER	
<b>FINGER DAM BOLT REPLACEMENT</b>		
ITEM NUMBER	BRIDGE ID	SHEET NO.
6-17.07		28039
PREPARED BY <b>PALMER ENGINEERING CO.</b>		

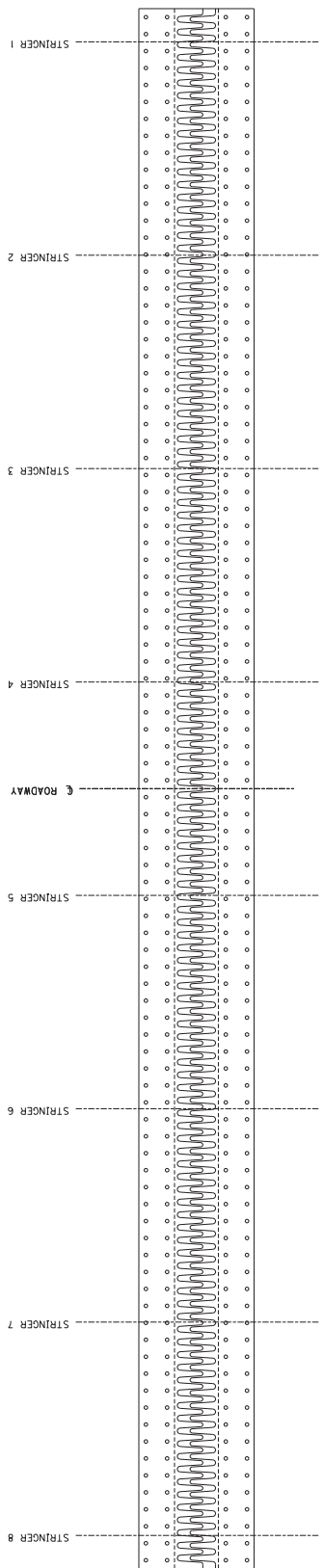

**LOWER DECK - PP17**  
368 BOLTS TO BE REPLACED  
ALL BOLTS TO BE REPLACED.  
ALL BOLTS ARE 8" IN LENGTH UNLESS OTHERWISE NOTED.

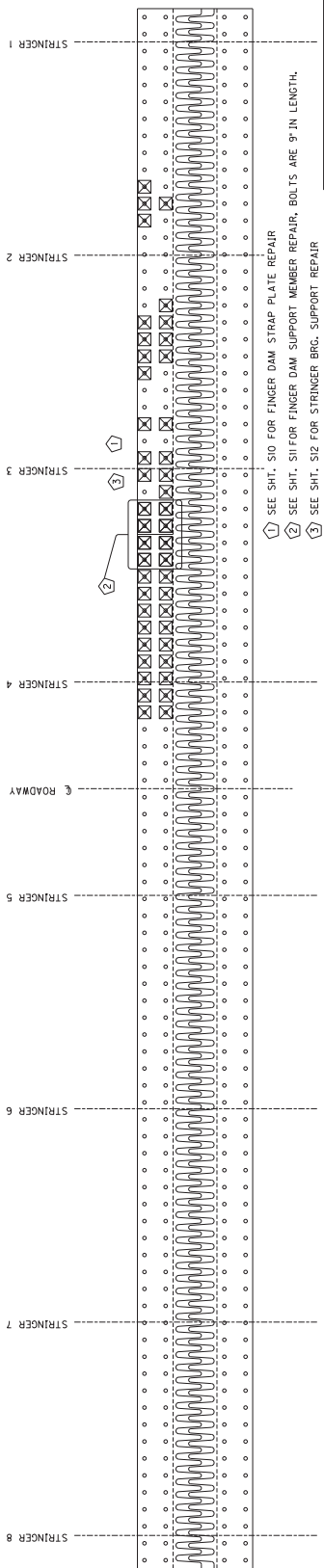

**LOWER DECK - PP17**  
368 BOLTS TO BE REPLACED  
ALL BOLTS TO BE REPLACED.  
THOSE REPLACED IN 2018 EMERGENCY REPAIRS TO BE GIVEN TO KYTC DISTRICT 6 FOR FUTURE USE.  
ALL BOLTS ARE 8" IN LENGTH UNLESS OTHERWISE NOTED.

**NOTES**

- SEE SHEET S9 FOR FINGER DAM BOLT INSTALLATION DETAILS.
- LOCATION OF TRUSS STRINGERS IS APPROXIMATE.

**LEGEND**

- ☒ BOLT RECENTLY REPLACED IN 2018 EMERGENCY REPAIRS, TO BE REPLACED. BOLT AND LOCK NUT TO BE GIVEN TO KYTC DISTRICT 6 FOR FUTURE USE.

- ☒ SEE SHT. S10 FOR FINGER DAM STRAP PLATE REPAIR
- ☒ SEE SHT. S11 FOR FINGER DAM SUPPORT MEMBER REPAIR, BOLTS ARE 9" IN LENGTH.
- ☒ SEE SHT. S12 FOR STRINGER BRG. SUPPORT REPAIR

REVISION	DATE
DESIGNED BY: R. DAMON	CHECKED BY: D. RUST
DETAILED BY: J. ROSE	D. RUST
Commonwealth of Kentucky DEPARTMENT OF HIGHWAYS	
COUNTY <b>KENTON</b>	
ROUTE 71 / I-75	CROSSING OHIO RIVER
<b>FINGER DAM BOLT REPLACEMENT</b>	
SHEET NO. 6-17.07	
PREPARED BY <b>PALMER ENGINEERING CO.</b>	
DRAWING NO. <b>280039</b>	

ITEM NUMBER	6-17.07
BRIDGE ID	059B00046N

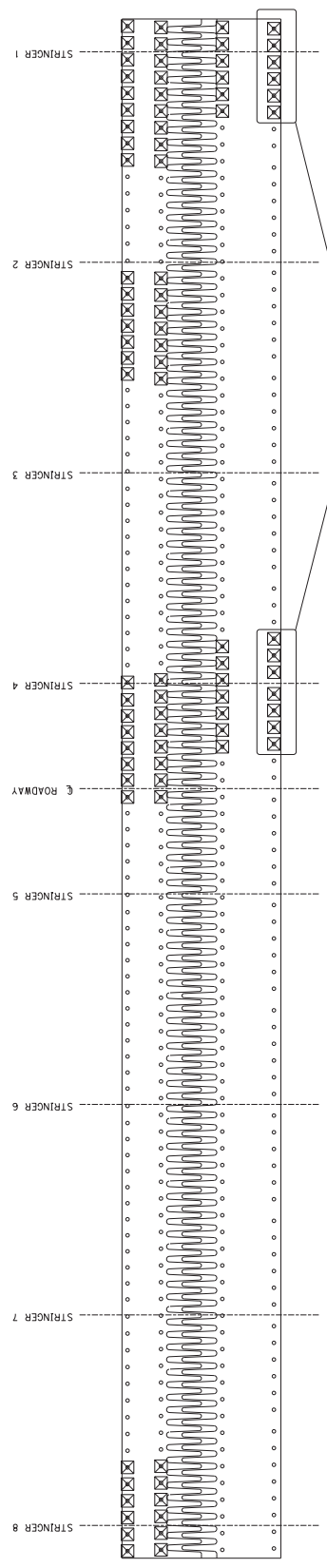

**UPPER DECK - PPO'**

86 BOLTS TO BE REPLACED  
ALL BOLTS ARE 8" IN LENGTH UNLESS OTHERWISE NOTED.

BOLTS ARE 12 1/4" IN LENGTH.

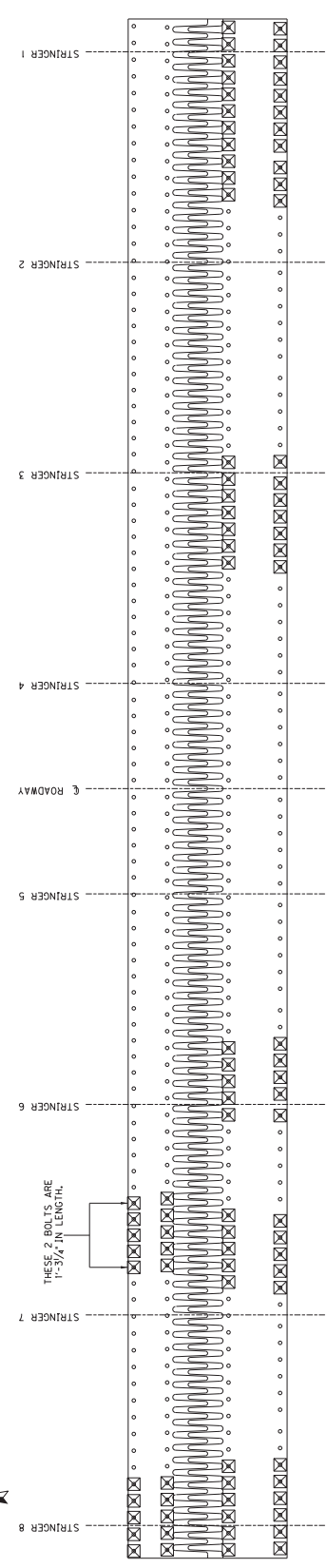

**UPPER DECK - PPO'**

88 BOLTS TO BE REPLACED  
ALL BOLTS ARE 8" IN LENGTH UNLESS OTHERWISE NOTED.

THESE 2 BOLTS ARE  
1'-3 1/4" IN LENGTH.

**NOTES**

- SEE SHEET S9 FOR FINGER DAM BOLT INSTALLATION DETAILS.
- LOCATION OF TRUSS STRINGERS IS APPROXIMATE.

**LEGEND**

☒ - DENOTES BOLT TO BE REPLACED

DATE: JUNE, 2019	REVISION	DATE
DESIGNED BY: R. DAMON	D. RUST	CHECKED BY
DETAILED BY: J. ROSE	D. RUST	
Commonwealth of Kentucky DEPARTMENT OF HIGHWAYS		
COUNTY <b>KENTON</b>		
ROUTE 1-71 / I-75	CROSSING OHIO RIVER	
<b>FINGER DAM BOLT REPLACEMENT</b>		
PREPARED BY PALMER ENGINEERING CO.	SHEET NO. S7	CONTRACT NO. 28039
ITEM NUMBER 6-17.07	BRIDGE ID 059B00046N	

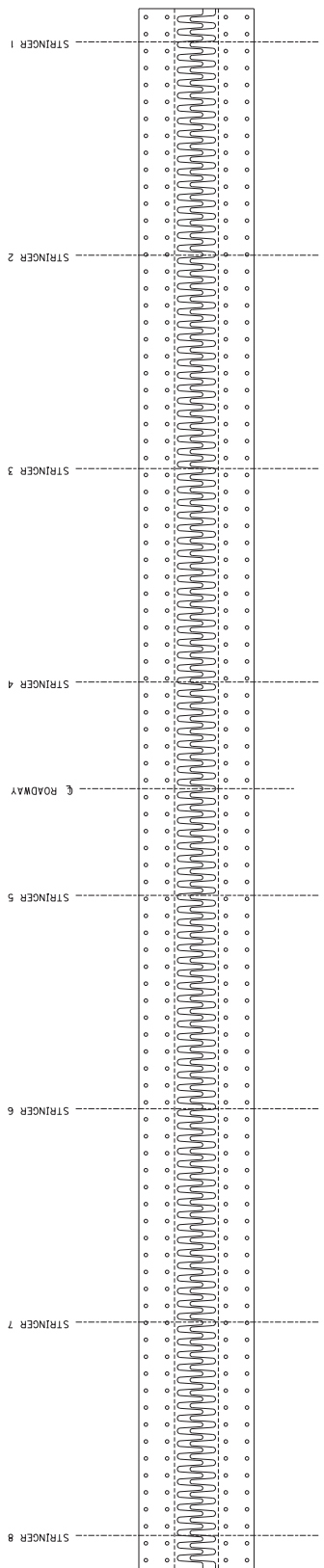

**UPPER DECK - PP17'**

368 BOLTS TO BE REPLACED  
ALL BOLTS TO BE REPLACED.  
ALL BOLTS ARE 7/2" IN LENGTH UNLESS OTHERWISE NOTED.

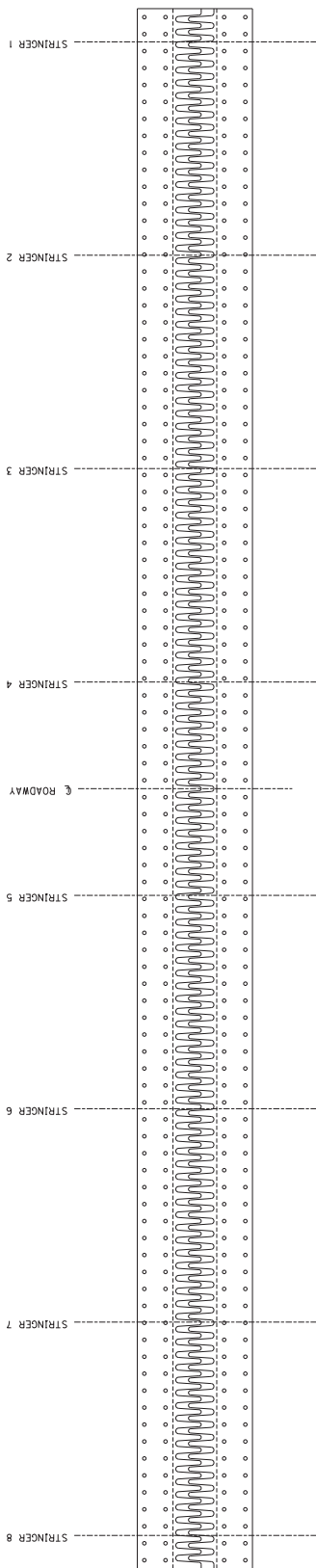
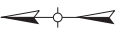

**UPPER DECK - PP17'**

368 BOLTS TO BE REPLACED  
ALL BOLTS TO BE REPLACED.  
ALL BOLTS ARE 7/2" IN LENGTH UNLESS OTHERWISE NOTED.

**NOTES**

1. SEE SHEET S9 FOR FINGER DAM BOLT INSTALLATION DETAILS.
2. LOCATION OF TRUSS STRINGERS IS APPROXIMATE.

DATE: JUNE, 2019	REVISION	DATE
DESIGNED BY: R. DAMON		CHECKED BY
DETAILED BY: J. ROSE		D. RUST
Commonwealth of Kentucky DEPARTMENT OF HIGHWAYS		
COUNTY <b>KENTON</b>		
ROUTE 1-71 / I-75	CROSSING	OHIO RIVER
<b>FINGER DAM BOLT REPLACEMENT</b>		
SHEET NO. PREPARED BY <b>PALMER ENGINEERING CO.</b>		
DRAWING NO. <b>28039</b>		

ITEM NUMBER	6-17.07
BRIDGE ID	059B00046N

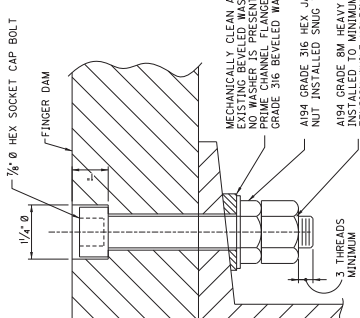
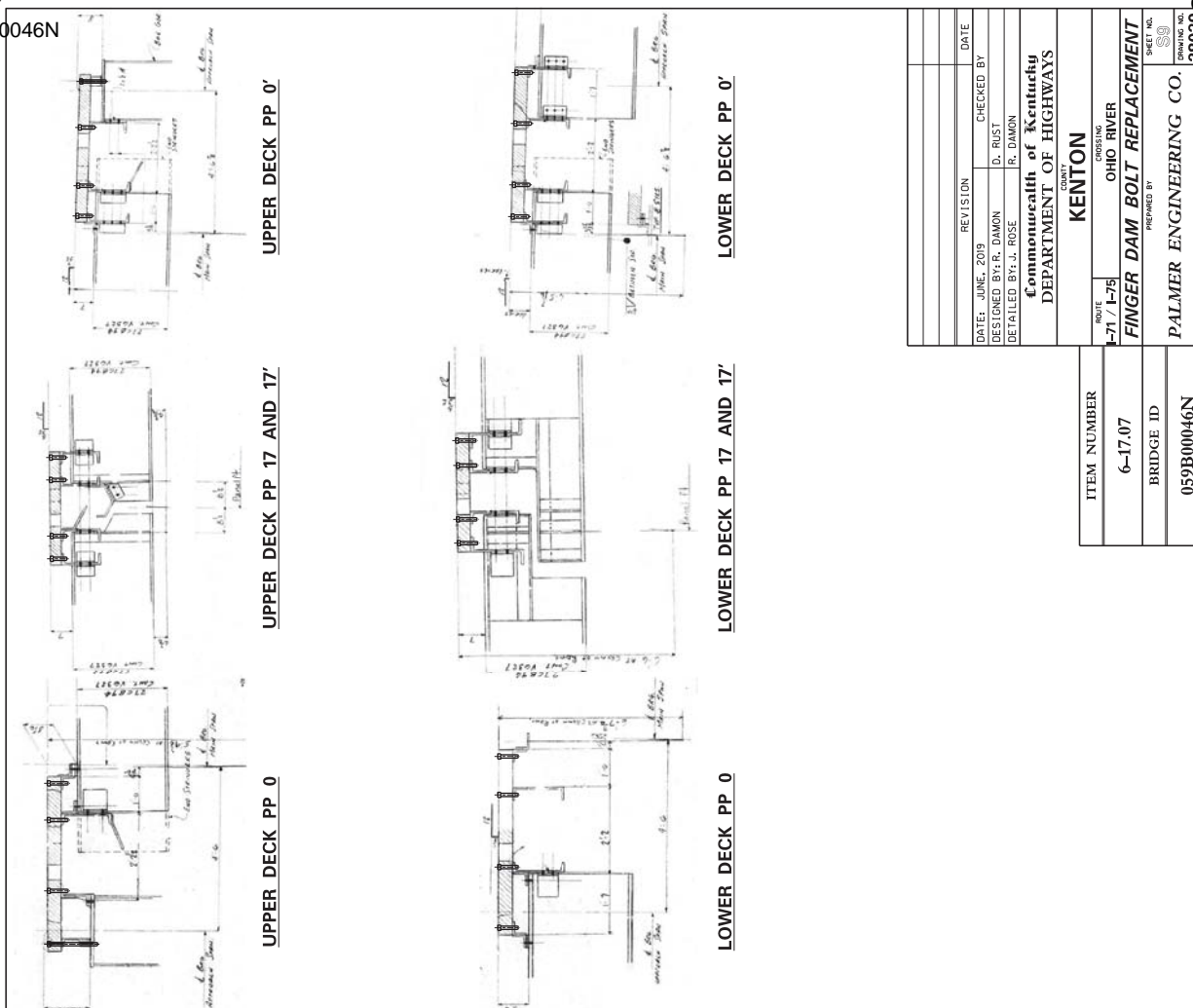

1/4" Ø

3/8" Ø HEX SOCKET CAP BOLT

FINGER DAM

MECHANICALLY CLEAN AND PRIME  
NO WASHER IS PRESENT CLEAN AND  
PRIME CHANNEL FLANGE AND INSTALL  
GRADE 316 BEVELED WASHER,  
A194 GRADE 316 HEX JAM  
NUT INSTALLED SNUG TIGHT  
A194 GRADE 8M HEAVY HEX NUT  
INSTALLED SNUG TIGHT  
TENSION WHILE HOLDING JAM  
NUT IN PLACE.

3 THREADS  
MINIMUM

NOTE: THREAD LENGTH TO BE 4" MINIMUM.

**REPLACEMENT FINGER DAM BOLTS**

**NOTES:**

1. FINGER DAM BOLT REPLACEMENT: Work shall include of existing bolts, nuts, and washers, preparation of the channel surface, and furnishing and installing new bolts, nuts, and washers. The Contractor shall provide all equipment and any other incidentals necessary to complete the work. The Contractor shall be responsible for any damage to the structure caused by falling materials, or other methods approved by the Engineer. Any damage to the remaining structure resulting from the Contractor's work shall be repaired at the Contractor's expense to the satisfaction of the Engineer at no cost to the Department.
2. REMOVAL OF EXISTING BOLTS, NUTS, AND WASHERS: Mechanically remove the bolts, nuts, and washers as indicated on the plans.
3. PREPARE THE SURFACE: Mechanically clean, and prime the existing beveled washers and channel flanges as directed by the general notes.
4. INSTALL BOLT: Install ASTM F837 grade 316 hex drive bolts with grade 316 beveled washers, and A194 Grade 316 heavy hex nuts. The Contractor shall install the A194 grade 8M heavy hex nuts by holding the jam nut in place and tightening the heavy hex nut to the minimum tension indicated by the Standard Specifications. See sheets 55-58 for bolt lengths and locations.
5. DETAILS FROM ORIGINAL SHOP PLANS: Note that the sections shown on this sheet are from the original shop drawings. Since these plans were developed, an overlay of the original shop drawings was developed, and the original plans to be replaced. Therefore, the bolt lengths shown on the original shop plans are too short. The lengths shown on sheets 55-58 take this into consideration by increasing the lengths to be 1/4" and 2/4", depending on other repairs in the area.

DATE	REVISION	CHECKED BY	DATE
JUNE, 2018		D. RUST	
DESIGNED BY: R. DAMON		R. DAMON	
DETAILED BY: L. ROSE			
<b>Commonwealth of Kentucky</b> DEPARTMENT OF HIGHWAYS			
COUNTY <b>KENTON</b>			
CROSSING OHIO RIVER			
PROJECT NO. <b>FINGER DAM BOLT REPLACEMENT</b>			
DESIGNED BY <b>PALMER ENGINEERING CO.</b>			
SHEET NO. <b>28039</b>			

ITEM NUMBER	6-17.07
BRIDGE ID	059B00046N

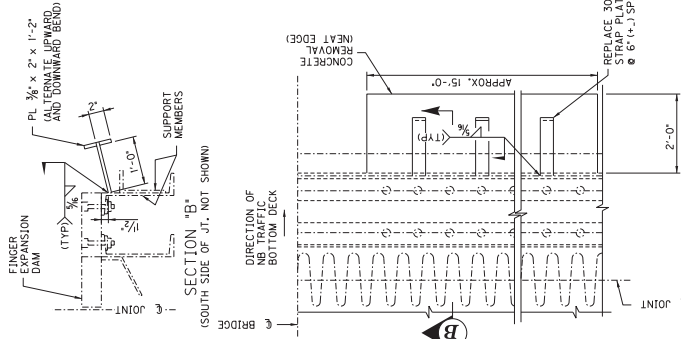
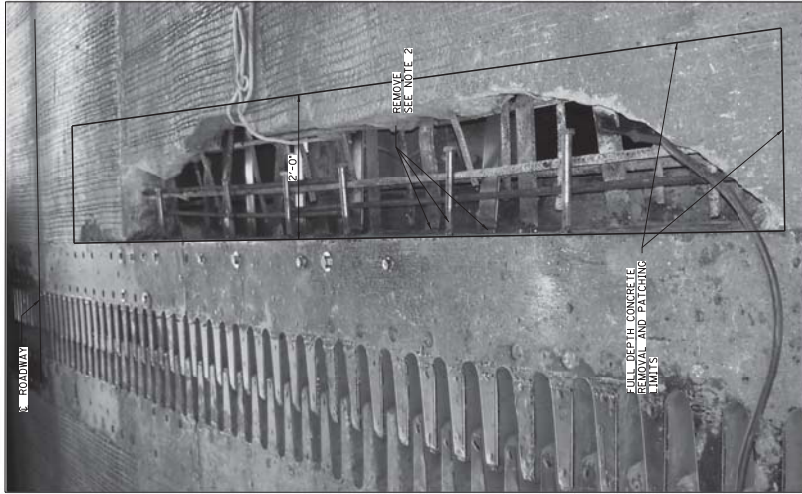

STRAP PLATE REPAIR  
(BOTTOM DECK AT PP 17, RIGHT 2 LANES)

- NOTES:**
1. REMOVAL OF EXISTING CONCRETE: Remove the reinforced concrete deck and reinforcement as directed by the Engineer. The Contractor shall be responsible for the removal and disposal of this material away from the bridge site. Any damage to the remaining existing structure, resulting from the Contractor's operation, shall be repaired by the Contractor at the Contractor's expense. The repair shall be made by the Contractor using the same methods approved by the Engineer. The concrete shall be removed without allowing broken concrete to drop into the river.
  2. The Contractor shall be responsible for any damage caused by falling concrete. The Contractor shall be responsible for the structure before removal begins. The surfaces presented as a result of the removal shall be reasonably true and even with sharp, straight corners that will permit the concrete to be placed and finished properly. Where existing bars are to extend from the remaining concrete into new concrete, the concrete shall be removed so as to leave the projecting bars clean and free of any debris. The Contractor shall be responsible for the removal and disposal of this material as directed by the Engineer at no additional cost to the Department.
  3. REMOVAL OF WELDED BOLTS AND PLATES: Mechanically remove all existing strap plates and bolts from the vertical surface of the Finger Expansion Dam and support members with hand held power tools.
  4. INSTALL NEW STRAP PLATES: Install new Finger Expansion Dam strap plates as shown in these plans. Fillet welds shall be 2" long, minimum.
  5. BONDING TO EXISTING CONCRETE USING STRUCTURAL ADHESIVES: Bond proposed strap plates to existing concrete using a structural adhesive as prescribed in Section 826 of the Specifications. Follow the manufacturer's recommended application instructions.
  6. INSTALL CONCRETE REPAIR PATCH: Place, finish, and cure concrete patch in accordance with the specifications for concrete repair materials listed on the KYC List of Approved Materials for "Rapid Hardening Repair Patch" or "Very Rapid Hardening Repair Patch".

REPAIR LOCATION BEFORE EMERGENCY PATCH  
(BOTTOM DECK AT PP 17, RIGHT 2 LANES)

REPAIR LOCATION AFTER EMERGENCY PATCH  
(BOTTOM DECK AT PP 17, RIGHT 2 LANES)

DATE: JUNE, 2019	REVISION	CHECKED BY
DESIGNED BY: R. DAMON		D. RUST
DETAILED BY: J. ROSE		D. RUST
<b>Commonwealth of Kentucky</b> DEPARTMENT OF HIGHWAYS		
COUNTY <b>KENTON</b>		
ROUTE 71 / I-75	CROSSING OHIO RIVER	
<b>FINGER DAM STRAP PLATES</b>		
PREPARED BY <b>PALMER ENGINEERING CO.</b>		
SHEET NO. 28039		

ITEM NUMBER	6-17.07
BRIDGE ID	059B00046N

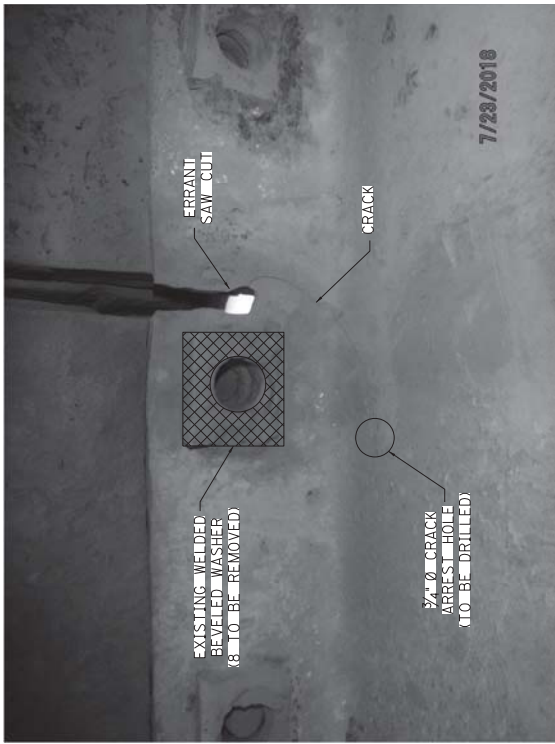

NOTE: PHOTO TAKEN LOOKING UP AND SOUTH AT MC13 x 40 FINGER DAM SUPPORT CHANNEL ON NORTH SIDE OF JOINT BEFORE TEMPORARY BOLTS WERE INSTALLED.

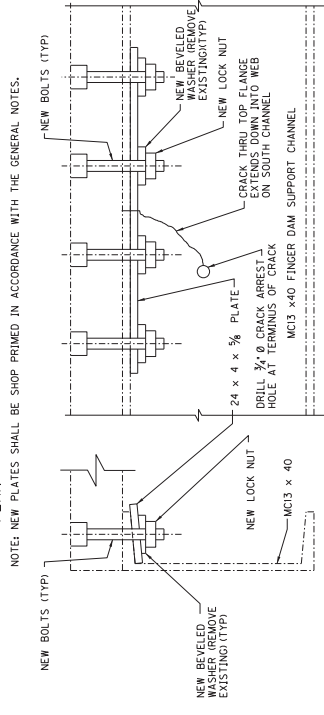
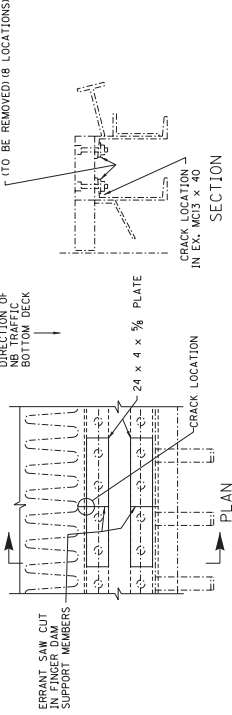

**FINGER DAM SUPPORT MEMBER STRENGTHENING & CRACK REPAIR**

BOTTOM DECK AT PP 17, NORTH SIDE OF JOINT BETWEEN STRINGERS 3 & 4

**NOTES:**

1. FINGER DAM SUPPORT MEMBER. Work shall include removal of existing nuts, bolts, and beveled washers. Installation of new plate nuts, bolts, and beveled washers, as well as grilling the crack arrest hole in the support member. The Contractor shall be responsible for any other incidentals necessary to complete the work. Steel must be disposed of to the satisfaction of the Engineer. The Contractor shall be responsible for any damage caused by falling steel. Steel shall be removed by the Contractor's operation and shall be disposed of to the satisfaction of the Engineer. Any damage to the remaining structure resulting from the Contractor's operation shall be repaired at the Contractor's expense. The Contractor shall be responsible for the cost of the Department.
2. REMOVAL OF BEVELED WASHERS: Mechanically remove the washers in the vicinity of the repair as shown in the plans.
3. INSTALL COVER PLATE: Cover plate shall be ASTM A572 Grade 50 steel and match the dimensions shown in these plans. Holes drilled shall be standard size and the plate shall be held in place with 1/2" diameter ASTM F837 Grade 316 hex nuts with A193 Grade 2H lock nuts and F45 beveled washers.
4. DRILL CRACK ARREST HOLE: Drill the 3/4" diameter crack arrest hole at the terminus of the crack. The terminus of the crack shall be located by dye penetrant or magnetic particle testing. This testing shall be incidental to steel repair.

REVISION	DATE	CHECKED BY
DESIGNED BY: R. DAMON	JUNE, 2018	D. RUST
DETAILED BY: J. ROSE		R. DAMON

Commonwealth of Kentucky  
 DEPARTMENT OF HIGHWAYS  
 COUNTY: KENTON  
 ROUTE: 71 / I-75  
 CROSSING: OHIO RIVER  
 PROJECT: FINGER DAM SUPPORT MEMBER  
 SHEET NO.: S11  
 CONTRACT NO.: 280339  
 PREPARED BY: PALMER ENGINEERING CO.

ITEM NUMBER	6-17.07
BRIDGE ID	059B00046N

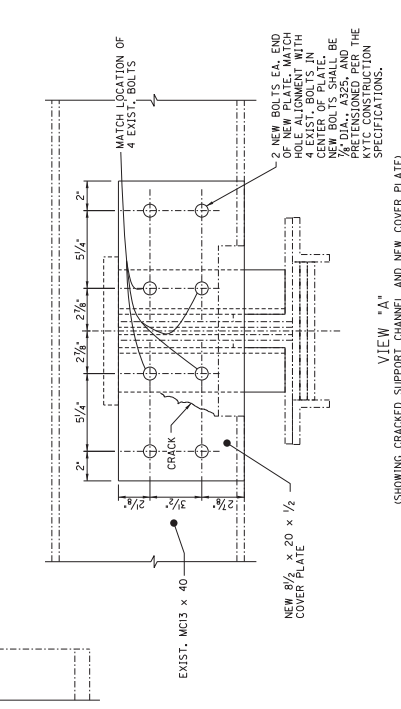
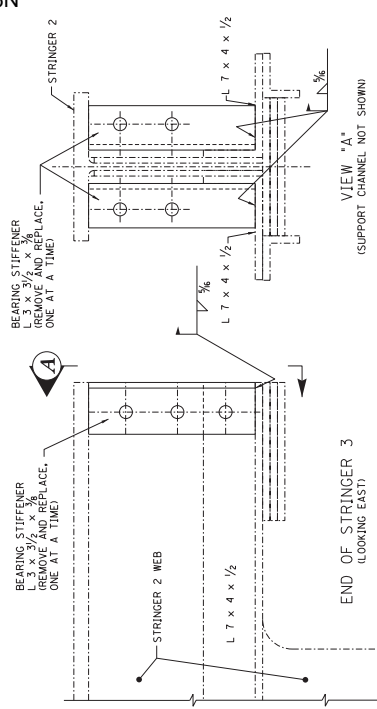

REVISION	DATE	CHECKED BY
1	JUNE, 2018	D. RUST
2		R. DIMON
DESIGNED BY: R. DIMON DETAILED BY: J. ROSE		
<b>Commonwealth of Kentucky</b> DEPARTMENT OF HIGHWAYS		
COUNTY <b>KENTON</b>		
ROUTE CROSSING <b>17 / I-75 OHIO RIVER</b>		
PROJECT NO. <b>STRINGER BRG. SUPPORT</b>		
PREPARED BY <b>PALMER ENGINEERING CO.</b>		
SHEET NO. <b>S12</b>		
CONTRACT NO. <b>28039</b>		



ITEM NUMBER	BRIDGE ID
6-17.07	059B00046N

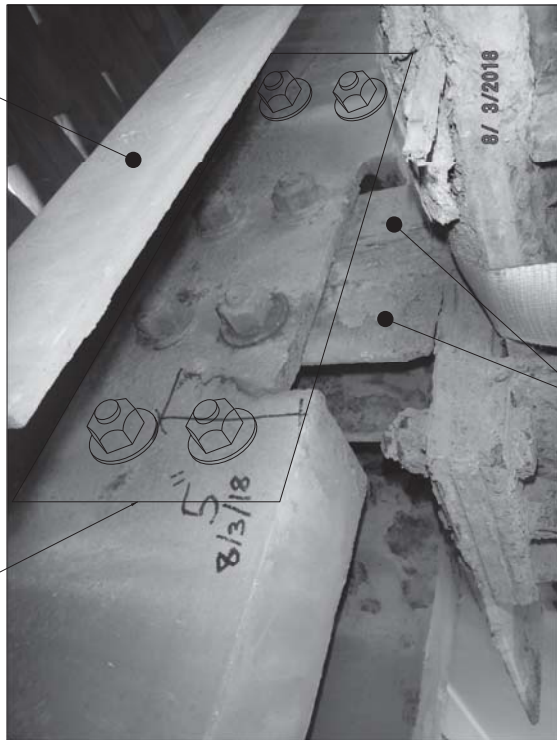

BEARING STIFFENERS TO BE REPLACED  
**STRINGER BEARING STIFFENERS & CRACKED SUPPORT CHANNEL REPAIR**  
 BOTTOM DECK AT PP 17, STRINGER 3

- NOTES:**
1. STRINGER BEARING SUPPORT REPAIRS: Work shall include removal of the existing cover plate, and removal and replacement of the bearing stiffeners as outlined in the drawings. The contractor shall be responsible for the equipment and any other materials necessary to complete the work. Steel removed shall not be allowed to fall into the river and must be disposed of to the satisfaction of the Engineer. The contractor shall be responsible for any damage caused by falling steel. Steel shall be removed by mechanical means, or other means approved by the Engineer. The contractor shall be responsible for the remaining structure resulting from the Contractor's operation shall be repaired by the Contractor to the satisfaction of the Engineer at no cost to the Department.
  2. REMOVAL OF SPLASH PLATE: Mechanically remove the splash plate in the vicinity of the repair. Repair access shall be completed. Reinstall or replace in kind after repairs are completed.
  3. INSTALL COVER PLATE: Cover plate shall be ASTM A572 Grade 50 steel and match the dimensions shown in these plans. Holes drilled shall be standard size and the plate shall be drilled with standard size and the plate shall be drilled with A550th nuts and F436 flat washers pretensioned per the specifications.
  4. BEARING STIFFENER REPLACEMENT: Remove and replace 1 bearing stiffener at a time. Bearings stiffeners shall be ASTM A36 steel.



**TRAFFIC CONTROL GENERAL NOTES**

- Except as provided herein, traffic shall be maintained in accordance with the Manual on Uniform Traffic Control Devices (MUTCD), the Standard Specifications for Road and Bridge Construction, and the Standard Drawings, current editions.
- Except for the roadway, and traffic control bid items listed, all items on the lump sum bid price to "Maintain and Control Traffic," as set forth in the current Standard Specifications for Road and Bridge Construction unless otherwise provided for in these notes.
- The Contractor shall maintain a minimum of two 11-foot lanes in each direction unless otherwise noted.
- Lane closures used on the project shall be in compliance with the appropriate Standard Drawings or the direction of the Engineer. Lane closures shall be measured to "control," but not considered incidental to the bid item "Maintain and Control Traffic," Lump Sum.
- Contrary to Section 106.01 of the Standard Specifications, traffic control devices used on this project may be new, or used but in like-new condition, at the beginning of the work, and maintained in like-new condition until it is complete. All signs shall conform to the Manual on Uniform Traffic Control Devices.
- Night work is required on this project. Existing overhead roadway lighting is available along I-71/75 from mast-arm poles located on the existing barrier wall and from poles located along the truss of the Brent Spence Bridge. Obtain approval from the Engineer for any proposed method of construction lighting other than the existing roadway lighting prior to its use.
- Reduce the speed limit in work areas to 45 miles per hour. Installation and placement of signs shall be completed at least 48 hours in advance of the date of the Contractor. Payment for the signs will be at the unit bid price for signs erected. Any relocation or covering of the signs shall be incidental to "Maintain and Control Traffic."
- Any lane closure or lane shift must be approved by the Engineer prior to the closure or lane shift. The Contractor must notify the Engineer at least five (5) days prior to any proposed lane closure or traffic pattern change.

**SPECIAL NOTES**

- Low Volume Traffic Hours Defined**  
In addition to the lane closures permitted in the maintenance of traffic phasing on sheet M12, additional lane closures can be performed during Low Volume Traffic Hours as detailed below:
- In these notes and the subsequent Construction Phasing notes, the phrase "Low Volume Traffic Hours" is used to specify a time frame in which a lane closure is allowed in order to perform particular construction activity or maintenance work. The "Low Volume Traffic Hours" are defined as the hours from 10:00 p.m. to 5:00 a.m., following local time.
- From 10 p.m. to 12 a.m. (midnight) the Contractor will be allowed to perform a single lane closure. From 12 a.m. (midnight) until 5 a.m., the Contractor will be allowed to perform a double lane closure.
- Lane Closures**  
When lane closures during Low Volume Traffic Hours are utilized outside of the Maintenance of Traffic Scheme identified in the contract plans, the lengths of lane closures shall be only the length needed for actual operations. Lane closures shall not exceed 2 miles in length. Only one lane closure in each direction shall be allowed at any one time. Lane closures shall be left in place only when in use.
- During the initial phase change and associated striping operations, when traffic hours are used, the lane closure operation is to be continuous until 9 p.m. on a Friday and the phase change operation is to be continuous until completed and the Maintenance of Traffic Scheme is implemented. Lane reductions for phase change operations may proceed outside of Low Volume Traffic Hours only on Saturdays or Sundays and only for striping or barrier wall operations.
- While the Maintenance of Traffic Scheme identified in the contract plans is implemented, the Department intends to maintain two lanes of traffic in each direction. Lane closures shall be limited to the length of the concrete barrier wall. A lane closure must be in place to create positive separation between the traveling public and the maintenance of traffic operation. A single lane closure for striping and barrier wall placement, in accordance with the Maintenance of Traffic Scheme will be allowed during the Low Volume hours previously defined.
- During lane closures, the clear lane width for the remaining travel lanes shall be feet minimum. A lane closure shall be used at all times when work is performed in the lane or the adjacent shoulder.

**Wrecker Service**

The Contractor will have continuously on call a 24-hour Wrecker Service that the Contractor will promptly contract to remove any disabled vehicle within the following items/capabilities: cell phone, gasoline, jumper cables, vehicle pushing, and tire changing. The Contractor will be charged three thousand dollars (\$3,000) liquidated damages for each 15 minute period for any incidence when the wrecker Service fails to reach the disabled vehicle beyond the 30 minutes of the Wrecker Service. Payment for the Wrecker Service will be considered incidental to the bid item "Maintain and Control Traffic."

**SPECIAL NOTES (cont.)**

**Truck Mounted Attenuators**  
Truck mounted attenuators (TMAs) that comply with Section 102.02.11 of the Standard Specifications shall be used on all trucks. The TMA shall be 500 feet between work sites, only a single TMA will be required at a location designated by the Engineer. Locate the TMAs at the individual work sites and the TMA installations are to be approved by the Engineer. Stackpile on the project site one set of additional replacement cartridges so that the TMA can be repaired immediately if hit. The TMAs will be paid for once, no matter how many times the TMA is replaced. The Department WILL NOT take possession of the TMAs upon completion of the work.

**SIGNS**

Traffic control signs in addition to those necessary to normal lane closure operations shall be provided for any lane closure. Additional signs needed for lane closures may include, but are not limited to, dual mounted:

TRUCKS USE LEFT/RIGHT LANE  
LEFT/RIGHT LANE CLOSED 1 MILE  
LEFT/RIGHT LANE CLOSED 2 MILES  
LEFT/RIGHT LANE CLOSED 3 MILES  
SLOWED/STOPPED TRAFFIC AHEAD

All traffic control signs, including signage for reduced speed limits will be furnished, relocated, and maintained by the Contractor. The Contractor will submit sign designs per MUTCD standards for the Engineer's approval prior to fabrication.

Contrary to Section 112 of the Standard Specifications, only long term signs (signs intended to be continuously in place for more than 3 days) will be furnished. Payment for signs (signs intended to be in place for more than 3 days) or less will be measured for payment but will be incidental to "Maintain and Control Traffic."

Individual signs will be measured only once for payment, regardless of how many times they are replaced. Replacements for damaged signs, or signs directed to be replaced by the Engineer due to poor legibility or reflectivity, will not be measured for payment.

A quantity of signs has been included for detours, lane shifts, and Roadwork Ahead signs on entrance ramps to be paid only once no matter how many times they are moved or relocated.

Signs to be located along the bridge shall be clipped to the primary truss members, concrete bridge railing, or temporary concrete barrier using industry standards. No welding or drilling shall be permitted.

Existing overhead and ground mounted panel signs will be covered as construction phasing requires. The Engineer will determine the duration of covering shall remain in place. Since most materials used in covering signs are not designed to be secured at the back of the signs or within an arched sheeting material may be used as specified in the following note. The use of tape, paper, plastic, or sheet metal covers is strictly prohibited. If any Contractor of no cost to the Department.

When modifying existing overhead and ground mounted panel signs, the new message shall be attached with coverings such manner to allow minimal contact with the existing sign face. Any holes or damaged portions of the existing sign shall be repaired by the Contractor at no additional cost to the Department. The Contractor shall be responsible for the removal of the existing sign to the Engineer for approval prior to attaching new panels to the existing signs. If existing copy, arrows, or shields are removed, they shall be properly stored and reinstalled at no additional cost to the Department.

**Project Traffic Coordinator**

Designate an employee to be the Project Traffic Coordinator (PTC). The designated Project Traffic Coordinator must be certified by the American Road & Builders Builders Association (ARBA). The Contractor shall provide for inspection of the project maintenance of traffic once every two hours during the Contractor's operations and at any time a lane closure is in place. The Contractor shall provide the PTC with the project location throughout the project zone to the Engineer. The Contractor shall furnish to the Engineer the name and telephone number where the Project Traffic Coordinator can be contacted at all times.

During any period when a lane closure is in place, the Project Traffic Coordinator will arrange for traffic control personnel to be present on the project at all times to inspect traffic control, and maintain the signing and devices.

The Traffic Control Coordinator must be equipped with a cellular phone and have access to a vehicle. The Contractor will be responsible for the cost of all as dollars (\$3,000) per day for any incidence that the traffic control coordinator is not on the project while work is actively in progress or if he is unable to respond to the project. Payment for the Traffic Control Coordinator will be considered incidental to the bid item "Maintain and Control Traffic."

**Channelizing Devices**

Traffic Drums (Barrels) shall be used in all instances and will be incidental to "Maintain and Control Traffic" according to Section 102.04.01 of the Standard Specifications.

**SPECIAL NOTES (cont.)**

**Advance Warning Arrow Boards (Panels)**  
The Contractor will provide Arrow Panels as indicated in the Maintenance of Traffic Plan. The Arrow Panels shall be mounted in traffic-worthy carriages. Payment for the Arrow Panels will be based on a contract unit price of each and will be full compensation for providing, place, operating, relocating and maintaining the Arrow Panels.

The Contractor will have available one reserve Arrow Panel to be placed into operation in the event of damage or mechanical/electrical failure. No direct property of the Contractor upon completion of the Project.

**Law Enforcement Officer**

Law enforcement officers shall be used when a lane closure is in place. Police officers shall be positioned at the beginning and end of the lane closure. Police having lawful jurisdiction within the work zone and a police car equipped with externally mounted flashing blue lights. It is anticipated that approximately 10 police officers will be placed at the direction of the Engineer.

**Portable Changeable Message Signs**

Provide Portable Changeable Message Signs in advance of sign within the project concurrently in both directions of travel, or if more than one lane closure is in place in the same direction of travel, provide additional Portable Changeable Message Signs. Portable Changeable Message Signs shall be approved by the Engineer prior to any shift in normal traffic configurations on the mainline or ramps. The Portable Changeable Message Signs shall be available for operation continuously. The Contractor shall immediately repair or replace the Portable Changeable Message Sign. Portable Changeable Message Signs will be paid for once, no matter how many times they are replaced. The Department WILL NOT take possession of the signs upon completion of the work.

**Traffic Queue Notification**

- Place one Portable Changeable Message Sign one mile prior to the longest approach ramp to the work zone. The Portable Changeable Message Sign should warn traffic of the distance to the upcoming work zone and advise motorists to be prepared to stop.
- Place Dual Mounted Advance Warning Signs with Continuously Flashing Type B Sign used for queue warning and the first work zone warning sign, or as specified in the Standard Specifications. The Advance Warning Signs should advise motorists to be prepared to stop.
- Place Advance Warning Signs with Continuously Flashing Type B Warning Lights on all entrance ramps between the Portable Changeable Message Sign used for queue warning and the first Advance Warning Sign for the work zone. The Advance Warning Signs should advise motorists to be prepared to stop.

Continuously Flashing Type B Warning Lights will only be required on signs identified in Type B for temporary signs. Includes all labor, placement, material, traffic control and incidental costs necessary to obtain, place, and maintain. Continuously Flashing Type B Warning Lights on the queue warning signage and in the Standard Specifications. Any requirements specified by the Manual on Uniform Traffic Control Devices.

**Emergency Vehicle Access**

The Contractor shall provide special access to emergency vehicles when possible. Temporary Pavement Markings  
Temporary Striping is required in the lane shift in Northbound Phase 2 of the Maintenance of Traffic Plan. All temporary striping shall be removed each time the maintenance of traffic setup is removed and traffic is returned to its normal condition.

Temporary Striping shall be removal pavement marking tape in accordance with Sections 112 and 831.  
All existing pavement markings that conflict with the markings required for the lane shift shall be covered with black, removable pavement marking tape per Section 631, as directed by the Engineer.

DATE: JUNE, 2019	REVISION	CHECKED BY
DESIGNED BY: J. RUFE		D. RUST
DETAILED BY: J. RUFE		J. RUFE
<b>Commonwealth of Kentucky</b>		
<b>DEPARTMENT OF HIGHWAYS</b>		
<b>KENTON COUNTY</b>		
ROUTE	CHOSING	
1-71 / I-75	OHIO RIVER	
<b>MAINTENANCE OF TRAFFIC NOTES</b>		
REVISED BY		
<b>PALMER ENGINEERING CO.</b>		
SHEET NO. <b>28039</b>		
DATE PLOTTED: September 18, 2012		
USER: jerr		
FILE NAME: C:\PM\WORKDIR\DAVID-R\MS1985\BENT.FTM\B0RGR.DGN		
5/23/2019		
24:43:27 PM		

ITEM NUMBER	6-17.07
BRIDGE ID	059B00046N

<p><b>PROJECT PHASING</b> Due to the double deck bridge design, the work on the lower and upper decks has to be performed simultaneously. This is necessary to prevent debris, etc. from falling on traffic and to access the work area repairs. The work will proceed in two phases: Phase 1 (Right) and Phase 2 (Left). This work will include lane closures and ramp closures to reduce traffic to two lanes in each direction on both northbound and southbound I-71/75. During the ramp closures, traffic will be detoured to an alternate route. The work detailed below is limited to weekends (Friday 10 pm - Monday 5 am) due to high traffic volumes. Lane closures will not be permitted on any weekday. In addition, this work is being performed on two consecutive weekends at Great American Ball Park, Paul Brown Stadium, or US Bank Arena. It is the responsibility of the contractor to verify the dates and times of events at these locations. The total number of weekends affected by closure should be no more than four.</p>	<p>No material should be allowed to drop into the waterway below, onto the deck from the upper deck, or onto the ground below the structure from the lower deck. This work shall be incidental to the bid item for "Maintain and Control Traffic".</p>	<p><b>PHASE 1 Northbound</b> Place temporary signing along I-71/75 northbound on the Kentucky approach, the Brent Spence Bridge, and the northbound Ohio approach and cover signs until needed (see Northbound Phase 1 Lower Deck drawings). Place detour signs along the following specified routes and cover until needed (see drawings). 4th Street on-ramp Close the 4th Street on-ramp to I-71/75 on the Kentucky approach and direct traffic to the signed detour route. Uncover the signing along northbound I-71/75 and put in place the traffic control devices for the left lane closure of I-71/75 southbound near the ramp Spence Bridge. On-ramp traffic from 3rd Street, 8th Street and Highway 50 is to be maintained during this closure.</p>	<p><b>PHASE 1 Southbound</b> Place temporary signing along I-75 southbound and I-71 southbound and cover signs until needed (see Southbound Phase 1 (Upper Deck) drawings). Uncover the signing along southbound I-71/75 and put in place the traffic control devices for the left lane closure of I-71 southbound near the ramp from 3rd Street and the right lane closure of I-75 near the ramp from 8th Street. Cover or remove any existing speed limit signs within the project area. Place channelizing devices as shown on the Southbound Phase 1 (Upper Deck) drawings to close the right lanes on the I-71 southbound and I-75 southbound, close the right two lanes on the Brent Spence Bridge, and place channelizing devices along the right approach, east side of the Brent Spence Bridge. On-ramp traffic from 3rd Street, 8th Street and Highway 50 is to be maintained during this closure. Proceed with Phase 1 work on the Brent Spence Bridge and Kentucky Approach Bridge.</p>	<p><b>PHASE 2 Northbound</b> Place any additional Phase 2 signing along I-71/75 northbound on the Kentucky approach, the Brent Spence Bridge, and the northbound Ohio approach and cover signs until needed (see Northbound Phase 2 (Lower Deck) drawings). Cover or remove any signage not needed from previous phase. Uncover the signing along northbound I-71/75 and put in place the traffic control devices for the left lane closure of I-71 southbound near the ramp Spence Bridge. On-ramp traffic from 3rd Street, 8th Street and Highway 50 is to be maintained during this closure. Place channelizing devices as shown on the Northbound Phase 1 (Lower Deck) drawings to close the left two lanes on the Brent Spence Bridge, and affect the lane shift on the I-71/75 approach just north of the Brent Spence Bridge. On-ramp traffic from 3rd Street, 8th Street and Highway 50 is to be maintained during this closure. Proceed with Phase 1 work on the Brent Spence Bridge and Kentucky Approach Bridge.</p>	<p><b>PHASE 2 Southbound</b> Place any additional Phase 2 signing along I-75 southbound and I-71 southbound and cover signs until needed (see Southbound Phase 2 (Upper Deck) drawings). Cover or remove any signage not needed from previous phase. Uncover the signing along southbound I-71/75 and put in place the traffic control devices for the left lane closure of I-71 southbound near the ramp Spence Bridge. On-ramp traffic from 3rd Street, 8th Street and Highway 50 is to be maintained during this closure. Place channelizing devices as shown on the Southbound Phase 1 (Upper Deck) drawings to close the left two lanes on the Brent Spence Bridge, and affect the lane shift on the I-71/75 approach just north of the Brent Spence Bridge. On-ramp traffic from 3rd Street, 8th Street and Highway 50 is to be maintained during this closure. Proceed with Phase 2 work on the Brent Spence Bridge and Kentucky Approach Bridge.</p>	<p>Upon completion of Phase 1, remove channelizing devices and cover all temporary signing. Remove all temporary signing not needed for Phase 2 Southbound.</p>	<p>Upon completion of Phase 1, remove channelizing devices and cover all temporary signing. Restore to their original condition, and any temporary signing shall be removed. Restore the existing speed limit signs.</p>										
<p>FILE NAME: C:\PM\WORK\RD\AVD-R\05M53985\BRENT.FIN\ABORGR.DGN DATE PLOTTED: September 18, 2012 USER: jeffr</p>	<p>MICROSOFT VISUAL BASIC C:\WINDOWS\SYSTEM32\GDI32.dll</p>	<p>DATE: JUNE, 2018 DESIGNED BY: J. RUFENER CHECKED BY: D. RUST DETAILED BY: J. RUFENER</p>	<p>REVISION DATE</p>	<p>COMMUNICATIO of Kentucky DEPARTMENT OF HIGHWAYS</p>	<p>KENTON COUNTY</p>	<p>OHIO RIVER CROSSING</p>	<p>MAINTENANCE OF TRAFFIC NOTES</p>	<p>BRIDGE ID</p>	<p>ITEM NUMBER</p>	<p>6-17.07</p>	<p>059B00046N</p>	<p>PROPOSED BY</p>	<p>Palmer Engineering Co.</p>	<p>PROJECT NO.</p>	<p>MT2</p>	<p>CONTRACT NO.</p>	<p>280339</p>

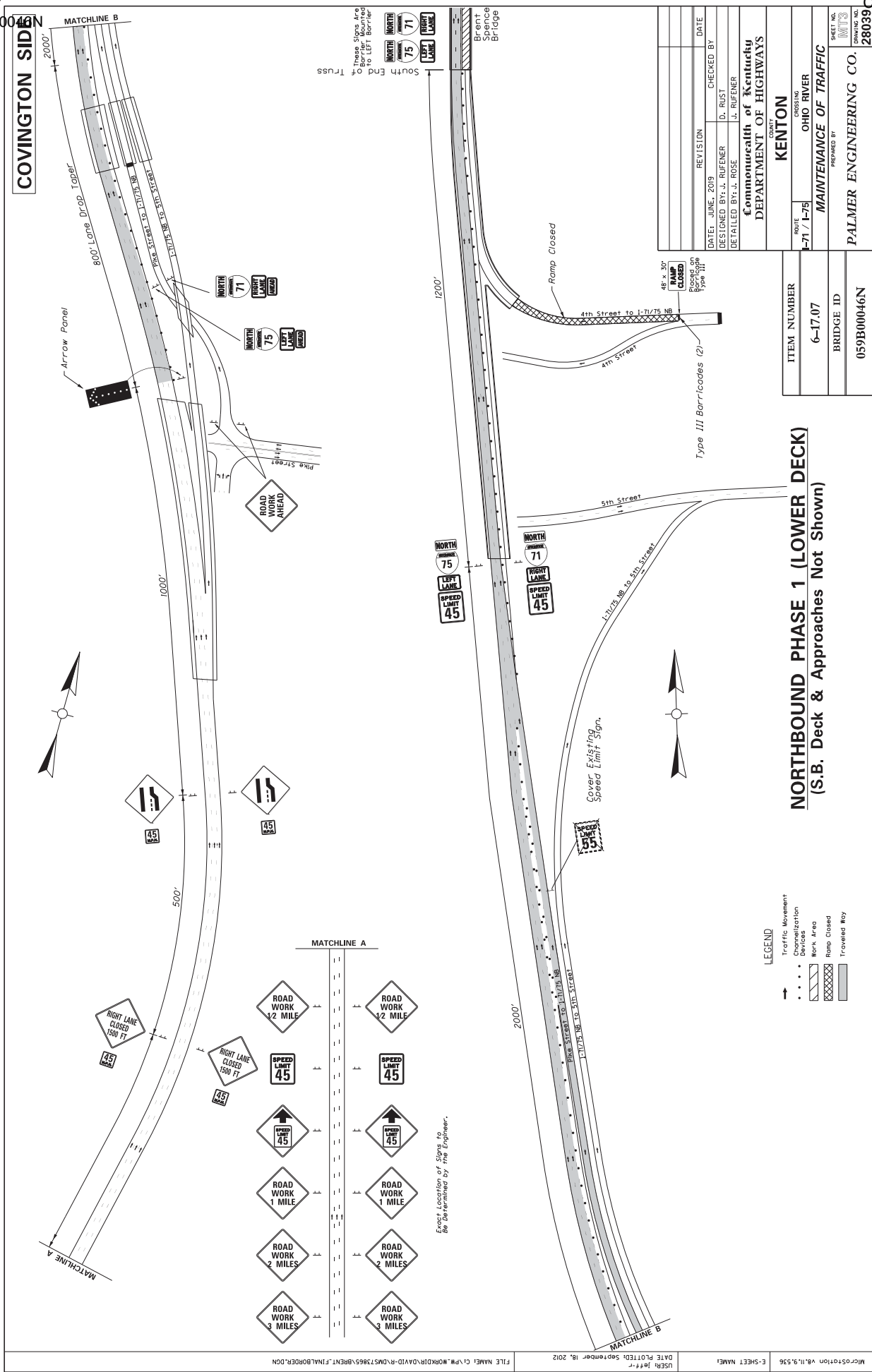

These Signs Are  
to be Mounted  
to LEFT Barrier  
of Truss

South End of  
Brent Spence  
Bridge

DATE: JUNE, 2019	REVISION	CHECKED BY	DATE
DESIGNED BY: J. ROSE		D. RUST	
DETAILED BY: J. ROSE		J. RUFENER	
Commonwealth of Kentucky DEPARTMENT OF HIGHWAYS			
COUNTY <b>KENTON</b>			
ROUTE	CROSSING	SHEET NO.	CONTRACT NO.
71 / I-75	OHIO RIVER	MAINTENANCE OF TRAFFIC	280339
PREPARED BY <b>PALMER ENGINEERING CO.</b>			

ITEM NUMBER	BRIDGE ID
6-17.07	059B00046N

**NORTHBOUND PHASE 1 (LOWER DECK)**  
(S.B. Deck & Approaches Not Shown)

**LEGEND**

↑	Traffic Movement
.....	Channelization
.....	Devices
.....	Work Area
.....	Ramp Closed
.....	Traveled Key

Exact Location of Signs to  
be Determined by the Engineer.

**CINCINNATI SIDE**

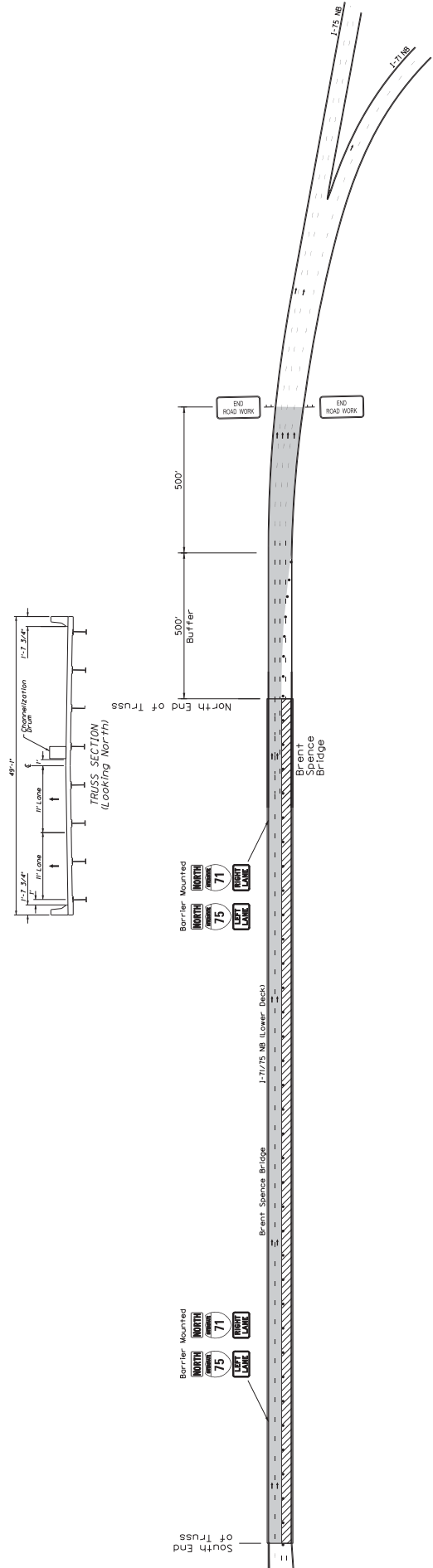
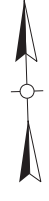

**NORTHBOUND PHASE 1 (LOWER DECK)**  
 (S.B. Deck & Approaches Not Shown)

DATE	REVISION	CHECKED BY
JUNE, 2019		D. RUST
		J. RUFENER
DESIGNED BY: J. RUFENER		
DETAILED BY: J. ROSE		
<b>Commonwealth of Kentucky</b> DEPARTMENT OF HIGHWAYS		
COUNTY <b>KENTON</b>		
ROUTE	CROSSING	
<b>71 / 1-75</b>	<b>OHIO RIVER</b>	
MAINTENANCE OF TRAFFIC		
PREPARED BY <b>PALMER ENGINEERING CO.</b>		
SHEET NO. <b>28039</b>		

ITEM NUMBER	<b>6-17.07</b>
BRIDGE ID	<b>059B00046N</b>

5/3/2019 2:43:32 PM  
 FILE NAME: C:\PM\WORKDIR\VAID-R\QMS7985\BRENT\_FINAL\BORBR.DGN  
 USER: jeff  
 DATE PLOTTED: September 18, 2012  
 C-SHEET NAME:  
 MICROSOFT EXCEL 98.11.9.536

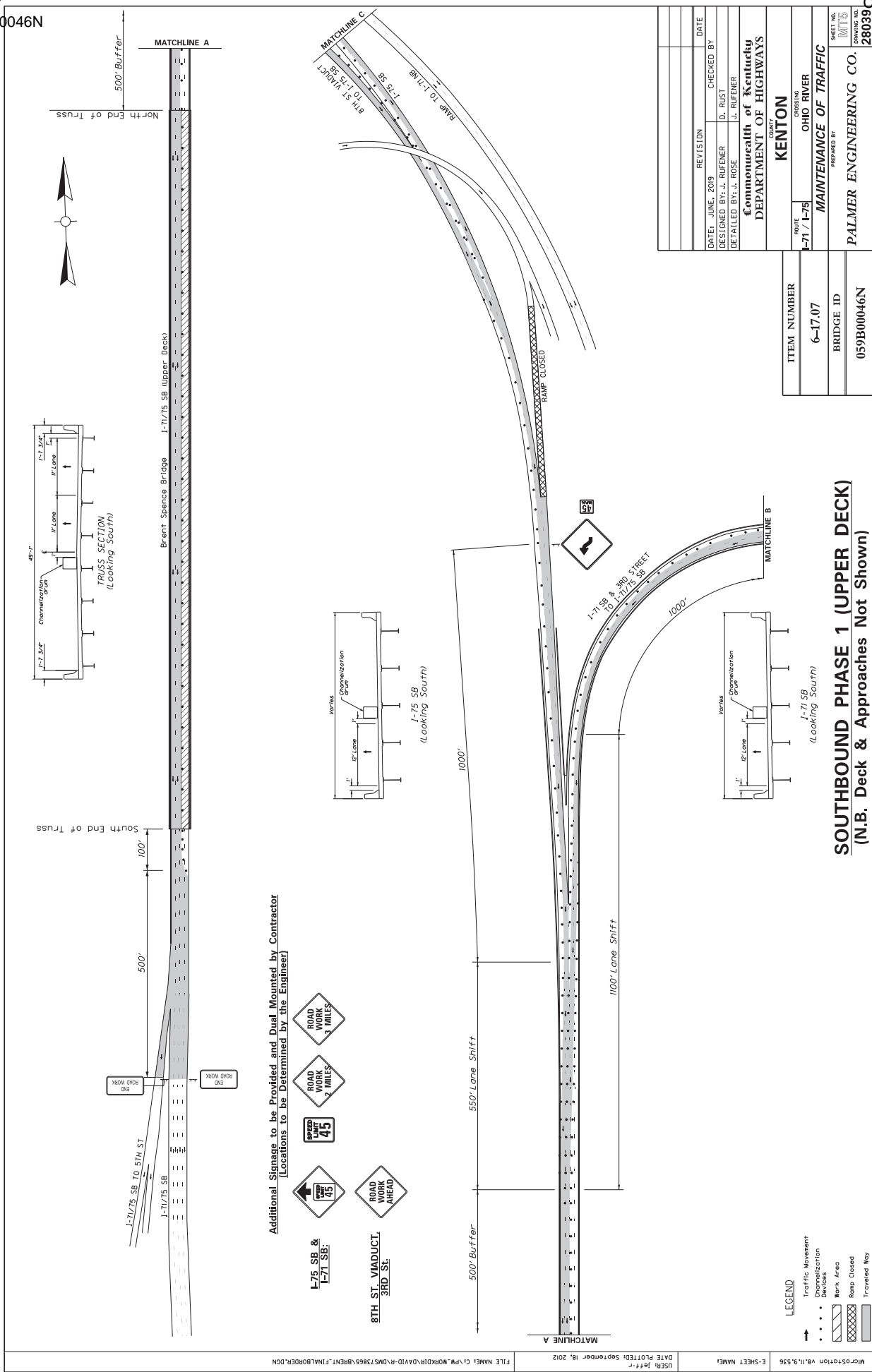

Additional Signage to be Provided and Dual Mounted by Contractor  
(Locations to be Determined by the Engineer)

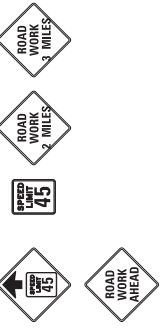

**LEGEND**  
 ↑ Traffic Movement  
 • Channelization  
 ••••• Work Area  
 [Hatched Box] Ramp Closed  
 [Dashed Box] Traveled Way

DATE: JUNE, 2018	REVISION	CHECKED BY
DESIGNED BY: J. RUFENER		D. RUST
DETAILED BY: J. RUFENER		J. RUFENER
Commonwealth of Kentucky DEPARTMENT OF HIGHWAYS		
COUNTY <b>KENTON</b>		
ROUTE	CROSSING	
I-71 / I-75	OHIO RIVER	
MAINTENANCE OF TRAFFIC		
PREPARED BY <b>PALMER ENGINEERING CO.</b>		
SHEET NO. <b>28039</b>		

ITEM NUMBER	6-17.07
BRIDGE ID	059B00046N

**SOUTHBOUND PHASE 1 (UPPER DECK)**  
(N.B. Deck & Approaches Not Shown)

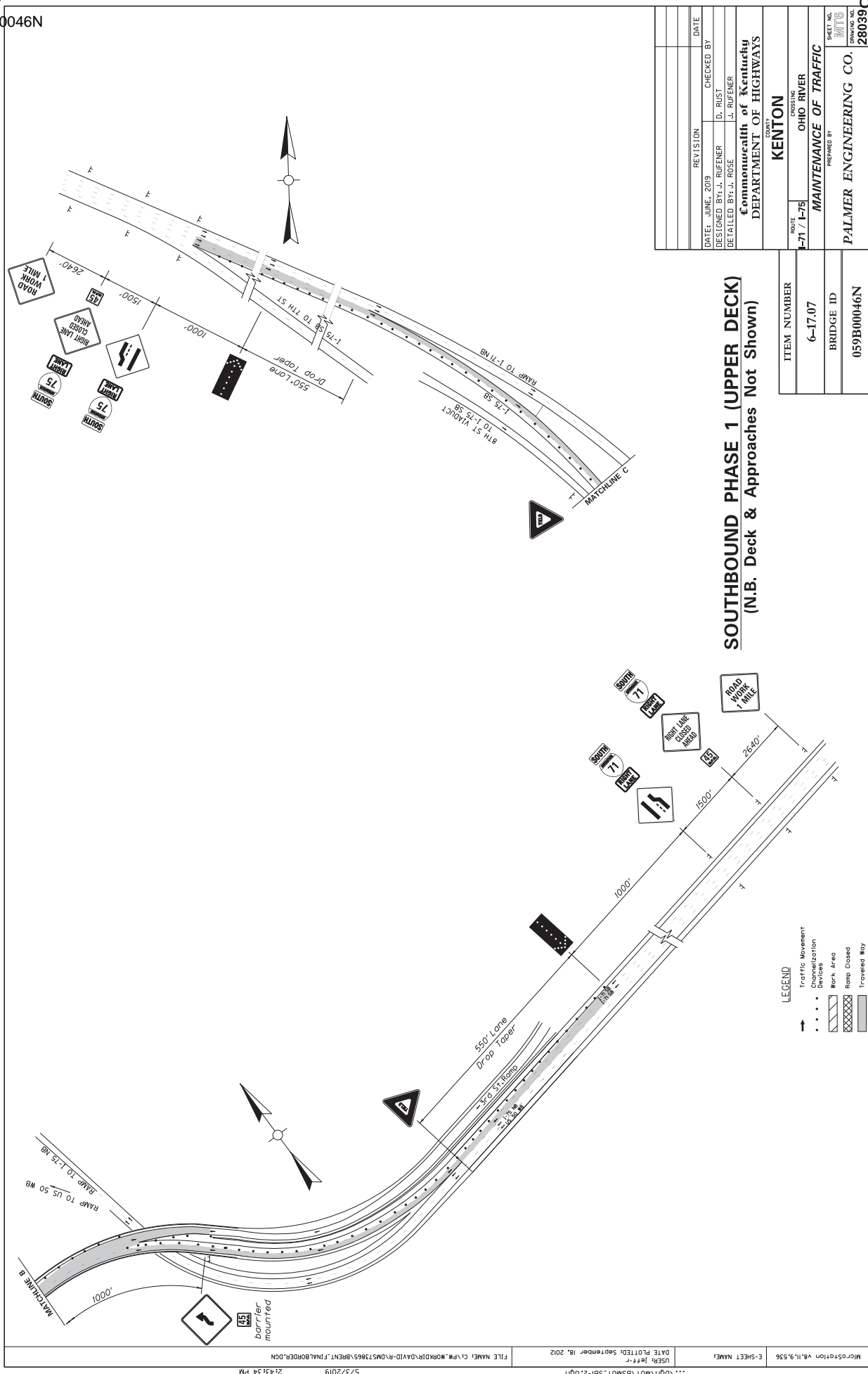

**SOUTHBOUND PHASE 1 (UPPER DECK)**  
(N.B. Deck & Approaches Not Shown)

REVISION	DATE	CHECKED BY
DATE: JUNE, 2019		D. RUST
DESIGNED BY: J. RUFENER		J. RUFENER
DETAILED BY: J. ROSE		

**Commonwealth of Kentucky**  
**DEPARTMENT OF HIGHWAYS**  
 COUNTY: **KENTON**  
 ROUTE: **71 / I-75** CROSSING: **OHIO RIVER**  
**MAINTENANCE OF TRAFFIC**  
 PREPARED BY: **PALMER ENGINEERING CO.**  
 SHEET NO.: **280339**  
 CONTRACT NO.: **059B00046N**

ITEM NUMBER	6-17.07
BRIDGE ID	059B00046N

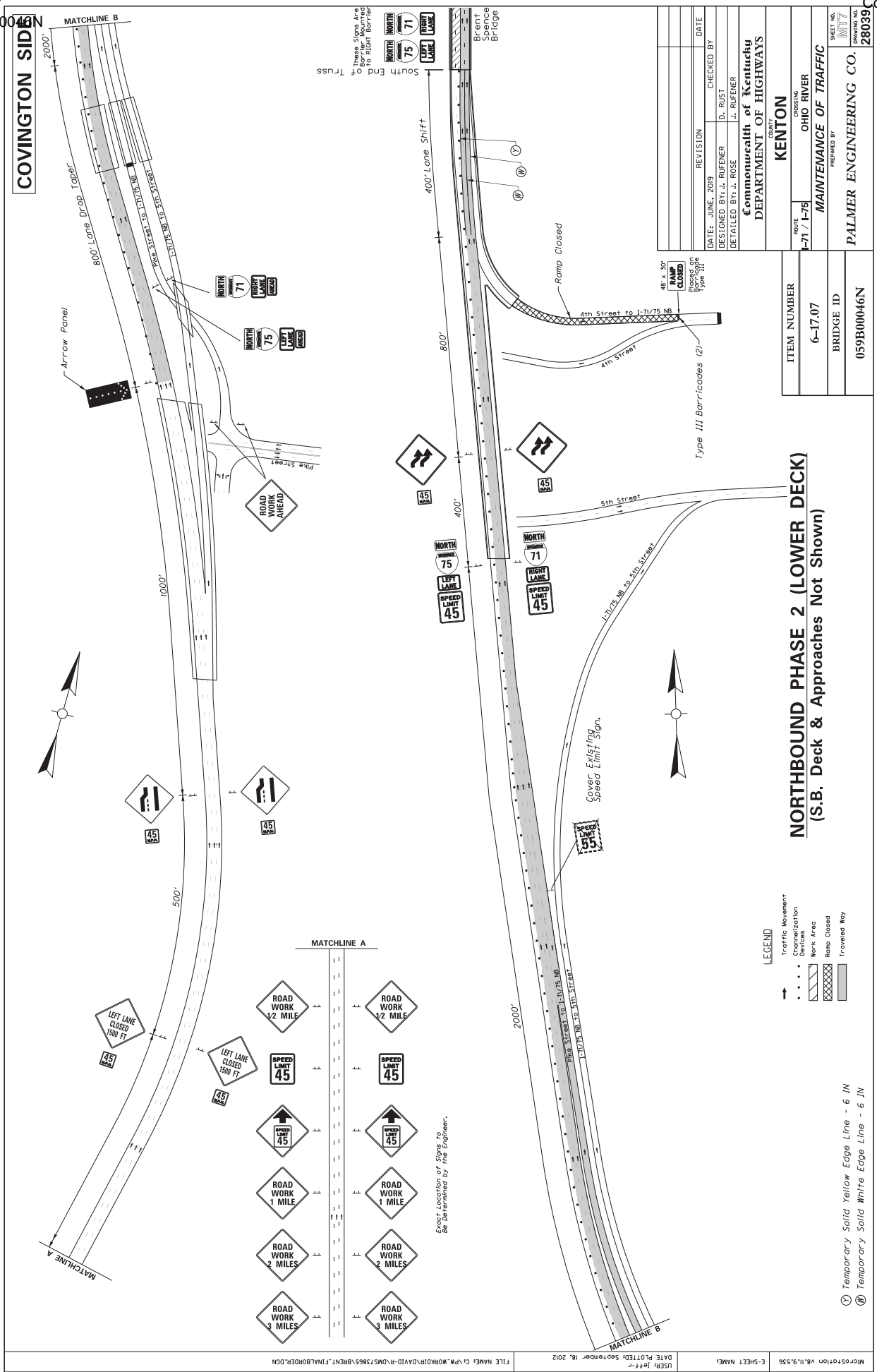

5/3/2019 2:43:36 PM  
 FILE NAME: C:\PM\WORKDIR\DAVID-R\MS73865\BRENT\_FINAL\BORER.DGN  
 USER: jeff  
 DATE PLOTTED: September 18, 2012  
 C-SHEET NAME: MICR05101\B5M0T\_NB2-1.dgn  
 C-SHEET NUMBER: 6-17.07  
 BRIDGE ID: 059B00046N  
 ITEM NUMBER: 6-17.07  
 COUNTY: KENTON  
 ROUTE: 71 / I-75  
 CROSSING: OHIO RIVER  
 MAINTENANCE OF TRAFFIC  
 PREPARED BY: PALMER ENGINEERING CO.  
 SHEET NO.: 28039  
 CONTRACT NO.: 192910

① Temporary Solid Yellow Edge Line - 6 IN  
 ② Temporary Solid White Edge Line - 6 IN

**NORTHBOUND PHASE 2 (LOWER DECK)**  
 (S.B. Deck & Approaches Not Shown)

DATE	REVISION	CHECKED BY	DATE
JUNE, 2013		D. RUST	
DESIGNED BY: J. ROSE			
DETAILED BY: J. ROSE			
J. RUFENER			
Commonwealth of Kentucky DEPARTMENT OF HIGHWAYS			
COUNTY: KENTON			
ROUTE: 71 / I-75 CROSSING: OHIO RIVER			
MAINTENANCE OF TRAFFIC			
PREPARED BY: PALMER ENGINEERING CO.			
SHEET NO.: 28039			CONTRACT NO.: 192910

CINCINNATI SIDE

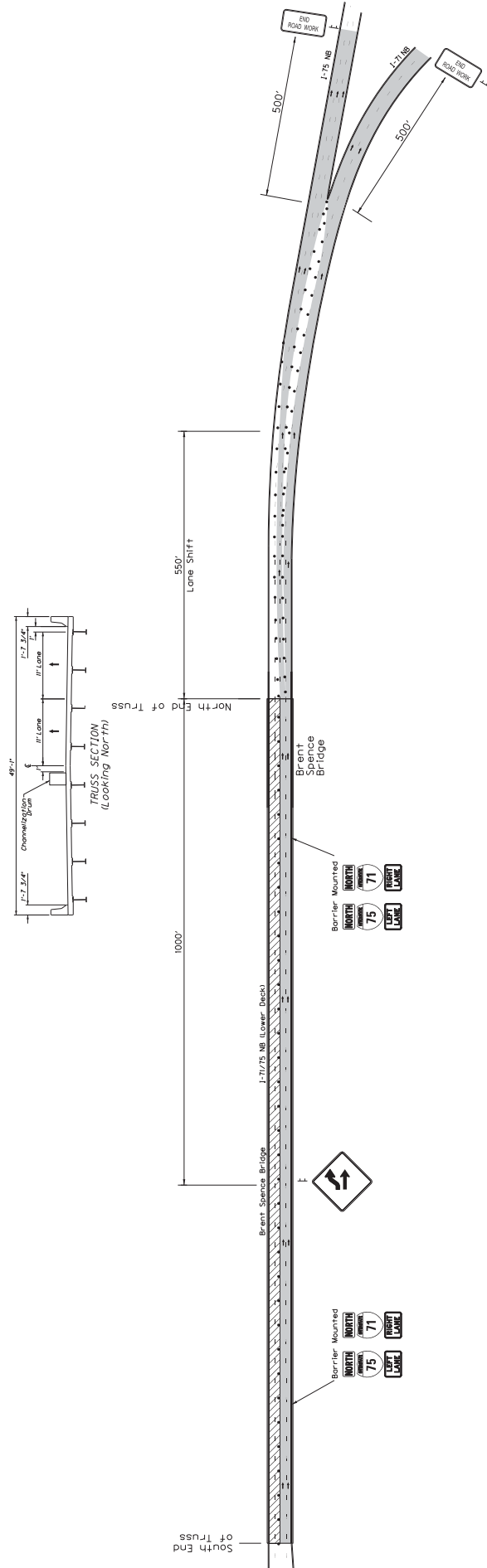

**NORTHBOUND PHASE 2 (LOWER DECK)**  
(S.B. Deck & Approaches Not Shown)

**LEGEND**

	Traffic Movement
	Channelization
	Devices
	Work Area
	Ramp Closed
	Trafficed Way

DATE: JUNE, 2019	REVISION	CHECKED BY
DESIGNED BY: J. RUFENER		D. RUST
DETAILED BY: J. ROSE		J. RUFENER
Commonwealth of Kentucky DEPARTMENT OF HIGHWAYS		
COUNTY <b>KENTON</b>		
ROUTE 1-71 / 1-75	CROSSING OHIO RIVER	
MAINTENANCE OF TRAFFIC		
PREPARED BY <b>PALMER ENGINEERING CO.</b>		
SHEET NO. <b>280339</b>		

ITEM NUMBER 6-17.07
BRIDGE ID 059B00046N

5/3/2019 2:43:37 PM  
 FILE NAME: C:\PM\WORKDIR\DAVID-R\QMS73865\BRENT\_FINAL\B00046N.DGN  
 DATE PLOTTED: September 18, 2012  
 USER: jeff  
 C-SHEET NAME: MicroStation v8.11.9.536



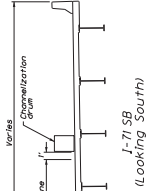
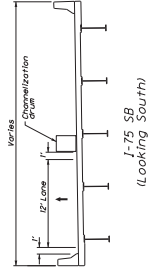
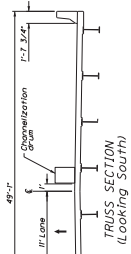
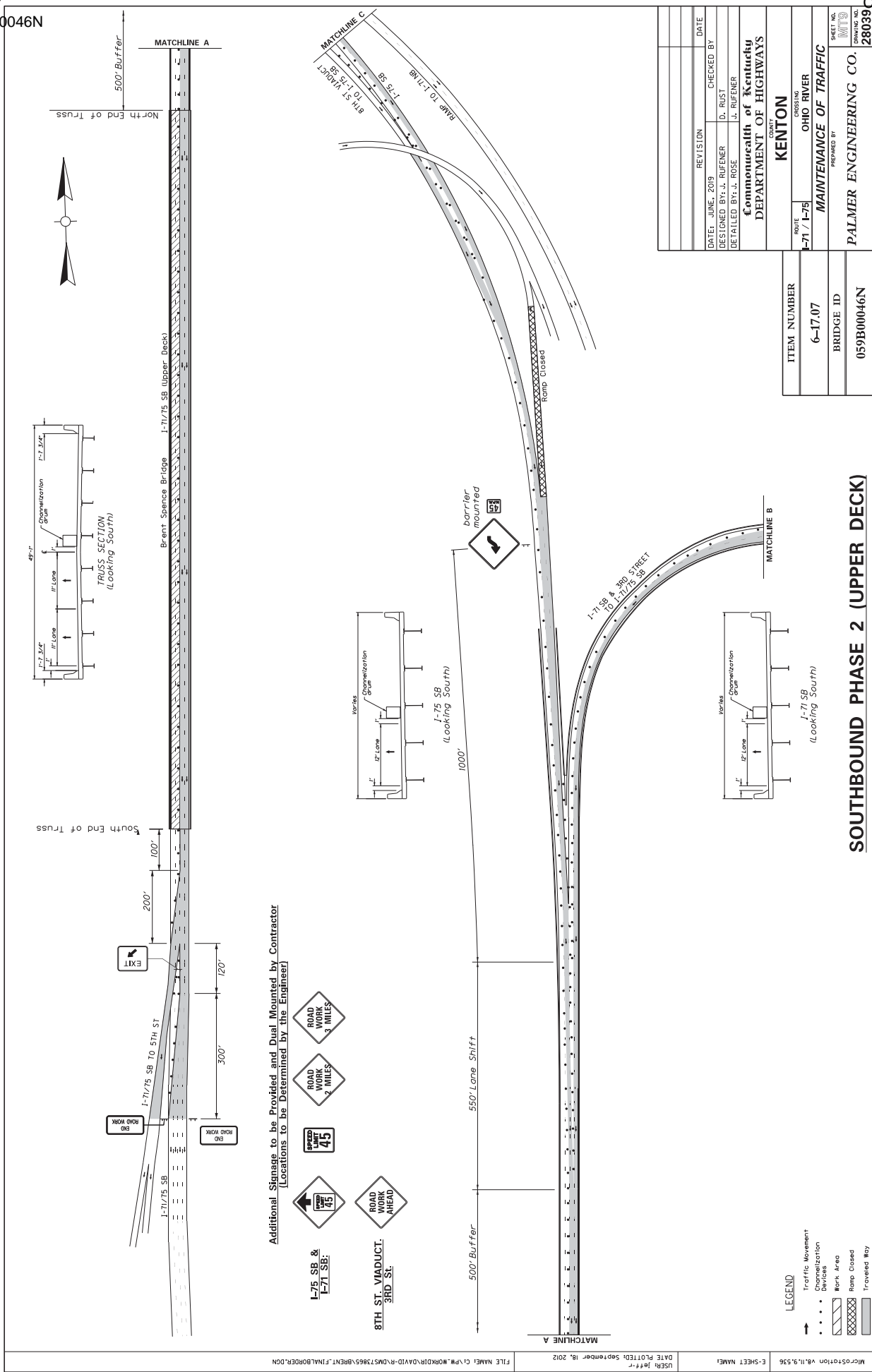

Additional Signage to be Provided and Dual Mounted by Contractor  
(Locations to be Determined by the Engineer)

- 8TH ST. VIADUCT. 3RD ST.
- I-75 SB & I-71 SB
- ROAD WORK AHEAD
- SPEED LIMIT 45
- ROAD WORK 2 MILES
- ROAD WORK 3 MILES
- EXIT

DATE: JUNE, 2018	REVISION	CHECKED BY
DESIGNED BY: J. RUFENER		D. RUST
DETAILED BY: J. RUFENER		J. RUFENER
Commonwealth of Kentucky DEPARTMENT OF HIGHWAYS		
COUNTY <b>KENTON</b>		
ROUTE	CROSSING	
I-71 / I-75	OHIO RIVER	
MAINTENANCE OF TRAFFIC		
PREPARED BY <b>PALMER ENGINEERING CO.</b>		
SHEET NO. <b>28039</b>		

ITEM NUMBER	6-17.07
BRIDGE ID	059B00046N

**SOUTHBOUND PHASE 2 (UPPER DECK)**

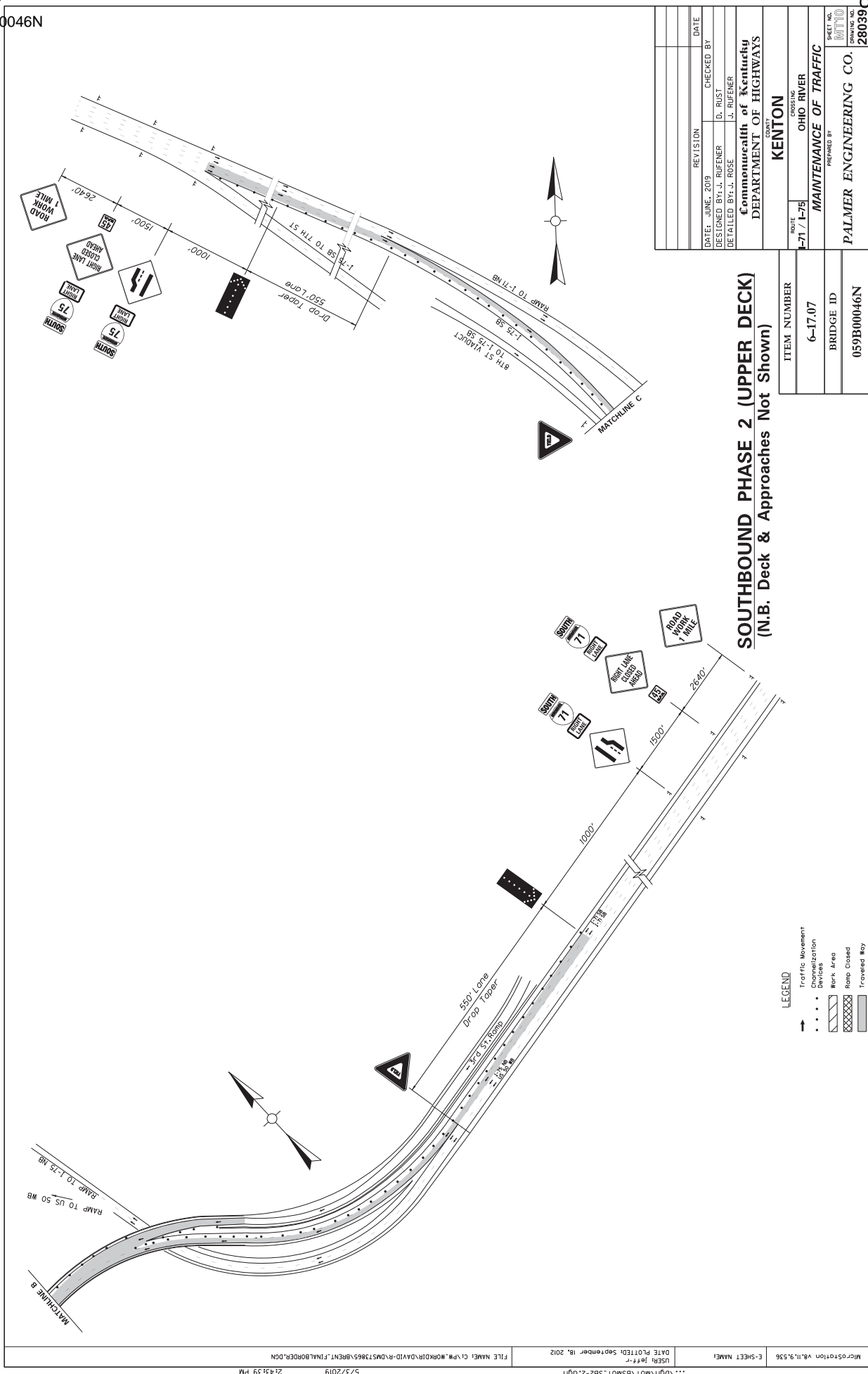

**SOUTHBOUND PHASE 2 (UPPER DECK)**  
**(N.B. Deck & Approaches Not Shown)**

DATE: JUNE, 2019	REVISION	CHECKED BY	DATE
DESIGNED BY: J. RUFENER		D. RUST	
DETAILED BY: J. ROSE		J. RUFENER	
<b>Commonwealth of Kentucky</b> <b>DEPARTMENT OF HIGHWAYS</b>			
<b>KENTON</b> COUNTY			
ROUTE	CROSSING	SHEET NO.	CONTRACT NO.
71 / I-75	OHIO RIVER	MAINTENANCE OF TRAFFIC	28039
PREPARED BY:			
PALMER ENGINEERING CO.			

ITEM NUMBER	BRIDGE ID
6-17.07	059B00046N

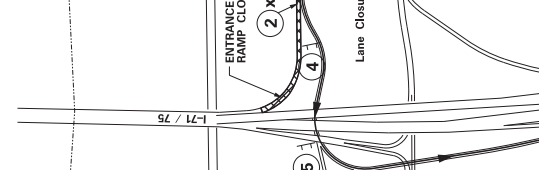
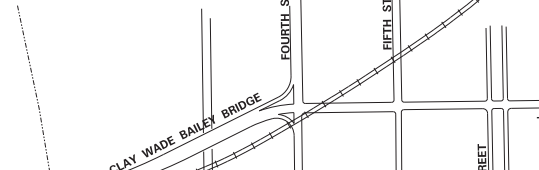
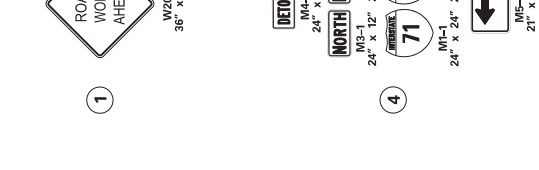
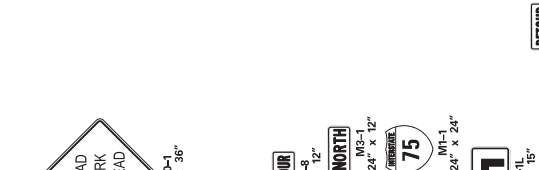
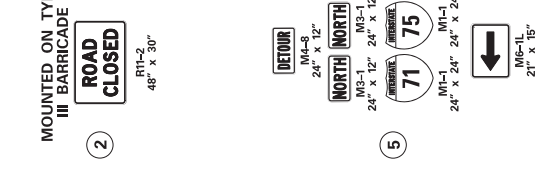
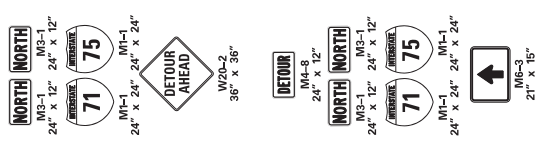
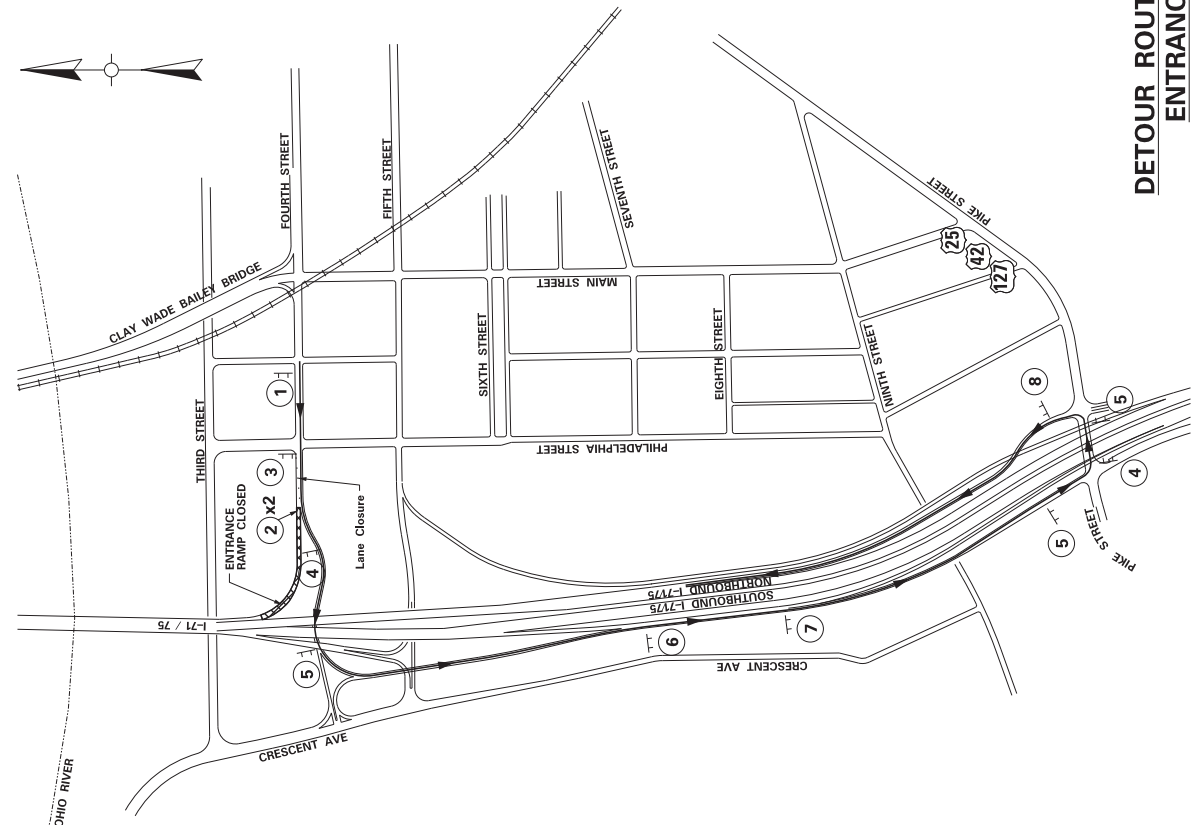

*These Signs are to be in place before work begins and are to remain in place until work is complete.*

DATE: JUNE, 2019	REVISION	CHECKED BY
DESIGNED BY: J. RUFENER		D. RUST
DETAILED BY: J. RUFENER		J. RUFENER
Commonwealth of Kentucky DEPARTMENT OF HIGHWAYS		
COUNTY <b>KENTON</b>		
ROUTE I-71 / I-75	CROSSING OHIO RIVER	SHEET NO. MAINTENANCE OF TRAFFIC
PREPARED BY PALMER ENGINEERING CO.		
SHEET NO. 280339		

ITEM NUMBER 6-17.07
BRIDGE ID 059B00046N

**DETOUR ROUTE FOR FOURTH STREET  
ENTRANCE RAMP CLOSURE**

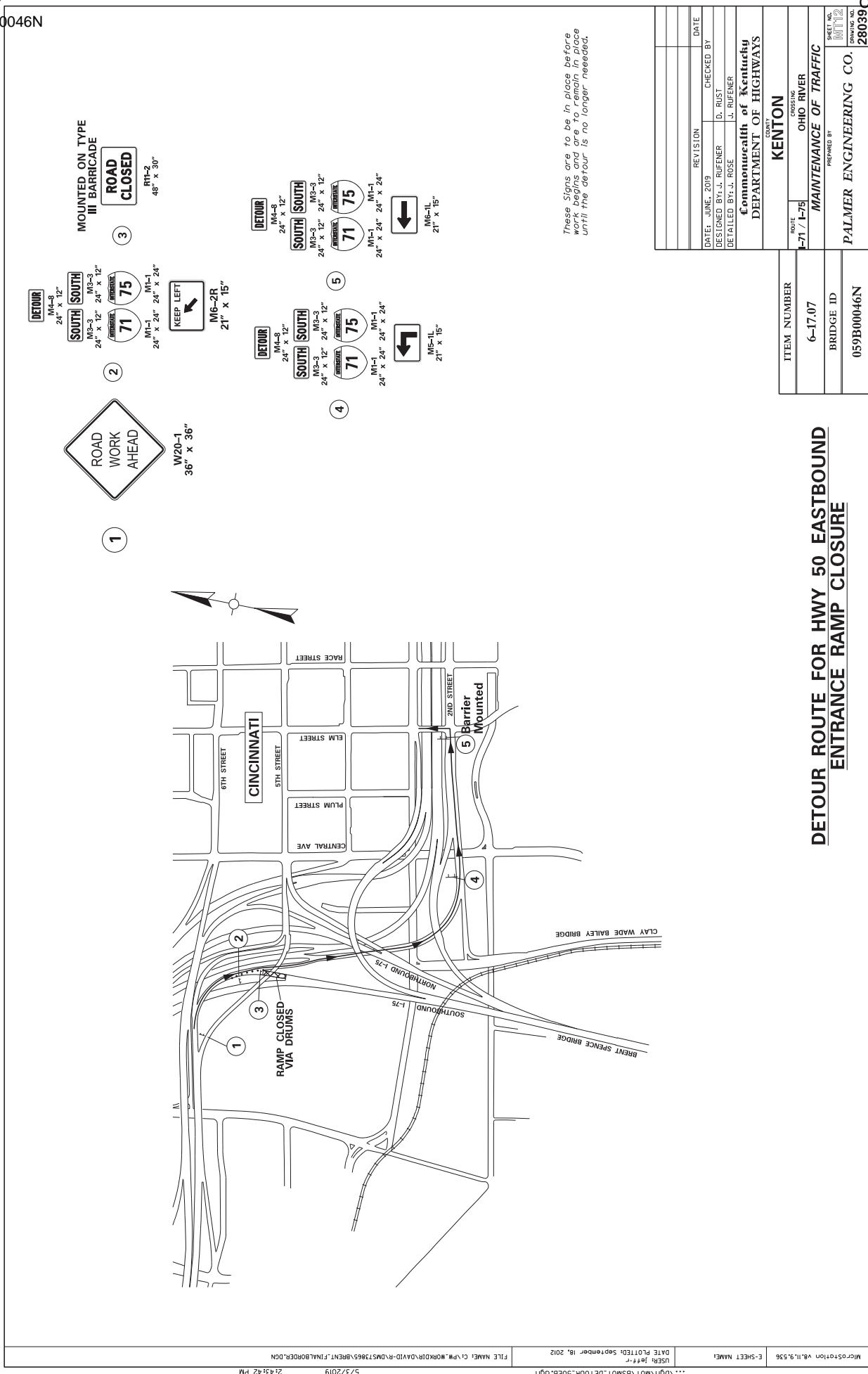

**1** ROAD WORK AHEAD  
36" x 36"

**2** **DETOUR** M4-S 24" x 12"  
**SOUTH SOUTH** M3-S 24" x 12" 24" x 12"  
**71** M1-1 24" x 24" 24" x 24"  
**75** M1-1 24" x 24" 24" x 24"  
**3** **ROAD CLOSED** III BARRICADE  
M1-2 48" x 30"

**4** **DETOUR** M4-S 24" x 12"  
**SOUTH SOUTH** M3-S 24" x 12" 24" x 12"  
**71** M1-1 24" x 24" 24" x 24"  
**75** M1-1 24" x 24" 24" x 24"  
**5** **Barrier Mounted** M6-1L 21" x 15"

**4** **DETOUR** M4-S 24" x 12"  
**SOUTH SOUTH** M3-S 24" x 12" 24" x 12"  
**71** M1-1 24" x 24" 24" x 24"  
**75** M1-1 24" x 24" 24" x 24"  
**5** **Barrier Mounted** M6-1L 21" x 15"

**4** **DETOUR** M4-S 24" x 12"  
**SOUTH SOUTH** M3-S 24" x 12" 24" x 12"  
**71** M1-1 24" x 24" 24" x 24"  
**75** M1-1 24" x 24" 24" x 24"  
**5** **Barrier Mounted** M6-1L 21" x 15"

**4** **DETOUR** M4-S 24" x 12"  
**SOUTH SOUTH** M3-S 24" x 12" 24" x 12"  
**71** M1-1 24" x 24" 24" x 24"  
**75** M1-1 24" x 24" 24" x 24"  
**5** **Barrier Mounted** M6-1L 21" x 15"

*These signs are to be in place before work begins and are to remain in place until the detour is no longer needed.*

REVISION	DATE
JUNE, 2019	CHECKED BY
D. RUST	DESIGNED BY: J. ROSE
J. RUFENER	DETAILED BY: J. ROSE
<b>Commonwealth of Kentucky</b> <b>DEPARTMENT OF HIGHWAYS</b>	
<b>KENTON</b> COUNTY	
ROUTE	CROSSING
71 / I-75	OHIO RIVER
<b>MAINTENANCE OF TRAFFIC</b>	
PREPARED BY	
<b>PALMER ENGINEERING CO.</b>	
SHEET NO.	CONTRACT NO.
MT12	28039

ITEM NUMBER	6-17.07
BRIDGE ID	059B00046N

**DETOUR ROUTE FOR HWY 50 EASTBOUND  
ENTRANCE RAMP CLOSURE**

**PART II**  
**SPECIFICATIONS AND STANDARD DRAWINGS**

### **SPECIFICATIONS REFERENCE**

Any reference in the plans or proposal to previous editions of the *Standard Specifications for Road and Bridge Construction* and *Standard Drawings* are superseded by *Standard Specifications for Road and Bridge Construction, Edition of 2019* and *Standard Drawings, Edition of 2016*.

## **SUPPLEMENTAL SPECIFICATIONS**

The contractor shall use the Supplemental Specifications that are effective at the time of letting.  
The Supplemental Specifications can be found at the following link:

<http://transportation.ky.gov/Construction/Pages/Kentucky-Standard-Specifications.aspx>

## 2016 STANDARD DRAWINGS THAT APPLY

### ROADWAY

#### ~ BARRIERS ~

##### ENERGY ABSORPTION DEVICES

CRASH CUSHION TYPE VI-BT .....RBE-100-10

##### CONCRETE MEDIAN BARRIERS

DELINEATORS FOR CONCRETE BARRIERS.....RBM-020-09

CONCRETE BARRIER WALL TYPE 9T (TEMPORARY).....RBM-115-10

### TRAFFIC

#### ~ TEMPORARY ~

##### TRAFFIC CONTROL

LANE CLOSURE TWO-LANE HIGHWAY .....TTC-100-04

LANE CLOSURE USING TRAFFIC SIGNALS .....TTC-110-03

LANE CLOSURE MULTI-LANE HIGHWAY CASE I .....TTC-115-03

LANE CLOSURE MULTI-LANE HIGHWAY CASE II.....TTC-120-03

##### DEVICES

DOUBLE FINES ZONES SIGNS .....TTD-120-02

PAVEMENT CONDITION WARNING SIGNS .....TTD-125-02

### BRIDGES

##### MISCELLANEOUS STANDARDS

BRIDGE RESTORATION AND WATERPROOFING WITH CONCRETE OVERLAYS.....BGX-009-04

##### JOINTS

NEOPRENE EXPANSION DAMS AND ARMORED EDGES .....BJE-001-13



## **PART III**

### **EMPLOYMENT, WAGE AND RECORD REQUIREMENTS**

**TRANSPORTATION CABINET  
DEPARTMENT OF HIGHWAYS**

**LABOR AND WAGE REQUIREMENTS  
APPLICABLE TO OTHER THAN FEDERAL-AID SYSTEM PROJECTS**

- I. Application
- II. Nondiscrimination of Employees (KRS 344)

**I. APPLICATION**

1. These contract provisions shall apply to all work performed on the contract by the contractor with his own organization and with the assistance of workmen under his immediate superintendence and to all work performed on the contract by piecework, station work or by subcontract. The contractor's organization shall be construed to include only workmen employed and paid directly by the contractor and equipment owned or rented by him, with or without operators.

2. The contractor shall insert in each of his subcontracts all of the stipulations contained in these Required Provisions and such other stipulations as may be required.

3. A breach of any of the stipulations contained in these Required Provisions may be grounds for termination of the contract.

3. If the contractor is in control of apprenticeship or other training or retraining, including on-the-job training programs, he shall not discriminate against an individual because of his race, color, religion, national origin, sex, disability or age forty (40) and over, in admission to, or employment in any program established to provide apprenticeship or other training.

4. The contractor will send to each labor union or representative of workers with which he has a collective bargaining agreement or other contract or understanding, a notice to be provided advising the said labor union or workers' representative of the contractor's commitments under this section, and shall post copies of the notice in conspicuous places available to employees and applicants for employment. The contractor will take such action with respect to any subcontract or purchase order as the administrating agency may direct as a means of enforcing such provisions, including sanctions for non-compliance.

Revised: January 25, 2017

**II. NONDISCRIMINATION OF EMPLOYEES**

**AN ACT OF THE KENTUCKY  
GENERAL ASSEMBLY TO PREVENT  
DISCRIMINATION IN EMPLOYMENT  
KRS CHAPTER 344  
EFFECTIVE JUNE 16, 1972**

The contract on this project, in accordance with KRS Chapter 344, provides that during the performance of this contract, the contractor agrees as follows:

1. The contractor shall not fail or refuse to hire, or shall not discharge any individual, or otherwise discriminate against an individual with respect to his compensation, terms, conditions, or privileges of employment, because of such individual's race, color, religion, national origin, sex, disability or age (forty and above); or limit, segregate, or classify his employees in any way which would deprive or tend to deprive an individual of employment opportunities or otherwise adversely affect his status as an employee, because of such individual's race, color, religion, national origin, sex, disability or age forty (40) and over. The contractor agrees to post in conspicuous places, available to employees and applicants for employment, notices to be provided setting forth the provisions of this nondiscrimination clause.

2. The contractor shall not print or publish or cause to be printed or published a notice or advertisement relating to employment by such an employer or membership in or any classification or referral for employment by the employment agency, indicating any preference, limitation, specification, or discrimination, based on race, color, religion, national origin, sex, or age forty (40) and over, or because the person is a qualified individual with a disability, except that such a notice or advertisement may indicate a preference, limitation, or specification based on religion, national origin, sex, or age forty (40) and over, or because the person is a qualified individual with a disability, when religion, national origin, sex, or age forty (40) and over, or because the person is a qualified individual with a disability, is a bona fide occupational qualification for employment.

## EXECUTIVE BRANCH CODE OF ETHICS

In the 1992 regular legislative session, the General Assembly passed and Governor Brereton Jones signed Senate Bill 63 (codified as KRS 11A), the Executive Branch Code of Ethics, which states, in part:

KRS 11A.040 (7) provides:

No present or former public servant shall, within six (6) months following termination of his office or employment, accept employment, compensation, or other economic benefit from any person or business that contracts or does business with, or is regulated by, the state in matters in which he was directly involved during the last thirty-six (36) months of his tenure. This provision shall not prohibit an individual from returning to the same business, firm, occupation, or profession in which he was involved prior to taking office or beginning his term of employment, or for which he received, prior to his state employment, a professional degree or license, provided that, for a period of six (6) months, he personally refrains from working on any matter in which he was directly involved during the last thirty-six (36) months of his tenure in state government. This subsection shall not prohibit the performance of ministerial functions, including but not limited to filing tax returns, filing applications for permits or licenses, or filing incorporation papers, nor shall it prohibit the former officer or public servant from receiving public funds disbursed through entitlement programs.

KRS 11A.040 (9) states:

A former public servant shall not represent a person or business before a state agency in a matter in which the former public servant was directly involved during the last thirty-six (36) months of his tenure, for a period of one (1) year after the latter of:

- a) The date of leaving office or termination of employment; or
- b) The date the term of office expires to which the public servant was elected.

This law is intended to promote public confidence in the integrity of state government and to declare as public policy the idea that state employees should view their work as a public trust and not as a way to obtain private benefits.

If you have worked for the executive branch of state government within the past six months, you may be subject to the law's prohibitions. The law's applicability may be different if you hold elected office or are contemplating representation of another before a state agency.

Also, if you are affiliated with a firm which does business with the state and which employs former state executive-branch employees, you should be aware that the law may apply to them.

In case of doubt, the law permits you to request an advisory opinion from the Executive Branch Ethics Commission, 3 Fountain Place, Frankfort, Kentucky 40601; telephone (502) 564-7954.

Revised: January 27, 2017

### **Kentucky Equal Employment Opportunity Act of 1978**

The requirements of the Kentucky Equal Employment Opportunity Act of 1978 (KRS 45.560-45.640) shall apply to this Contract. The apparent low Bidder will be required to submit EEO forms to the Division of Construction Procurement, which will then forward to the Finance and Administration Cabinet for review and approval. No award will become effective until all forms are submitted and EEO/CC has certified compliance. The required EEO forms are as follows:

- EEO-1: Employer Information Report
- Affidavit of Intent to Comply
- Employee Data Sheet
- Subcontractor Report

These forms are available on the Finance and Administration's web page under ***Vendor Information, Standard Attachments and General Terms*** at the following address:  
**<https://www.eProcurement.ky.gov>**.

Bidders currently certified as being in compliance by the Finance and Administration Cabinet may submit a copy of their approval letter in lieu of the referenced EEO forms.

For questions or assistance please contact the Finance and Administration Cabinet by email at **[finance.contractcompliance@ky.gov](mailto:finance.contractcompliance@ky.gov)** or by phone at 502-564-2874.

# EMPLOYEE RIGHTS UNDER THE FAIR LABOR STANDARDS ACT

THE UNITED STATES DEPARTMENT OF LABOR WAGE AND HOUR DIVISION

## FEDERAL MINIMUM WAGE

# \$7.25

 PER HOUR

BEGINNING JULY 24, 2009

**OVERTIME PAY** At least 1½ times your regular rate of pay for all hours worked over 40 in a workweek.

**CHILD LABOR** An employee must be at least **16** years old to work in most non-farm jobs and at least **18** to work in non-farm jobs declared hazardous by the Secretary of Labor.

Youths **14** and **15** years old may work outside school hours in various non-manufacturing, non-mining, non-hazardous jobs under the following conditions:

**No more than**

- **3** hours on a school day or **18** hours in a school week;
- **8** hours on a non-school day or **40** hours in a non-school week.

Also, work may not begin before **7 a.m.** or end after **7 p.m.**, except from June 1 through Labor Day, when evening hours are extended to **9 p.m.** Different rules apply in agricultural employment.

**TIP CREDIT** Employers of “tipped employees” must pay a cash wage of at least \$2.13 per hour if they claim a tip credit against their minimum wage obligation. If an employee’s tips combined with the employer’s cash wage of at least \$2.13 per hour do not equal the minimum hourly wage, the employer must make up the difference. Certain other conditions must also be met.

**ENFORCEMENT** The Department of Labor may recover back wages either administratively or through court action, for the employees that have been underpaid in violation of the law. Violations may result in civil or criminal action.

Employers may be assessed civil money penalties of up to \$1,100 for each willful or repeated violation of the minimum wage or overtime pay provisions of the law and up to \$11,000 for each employee who is the subject of a violation of the Act’s child labor provisions. In addition, a civil money penalty of up to \$50,000 may be assessed for each child labor violation that causes the death or serious injury of any minor employee, and such assessments may be doubled, up to \$100,000, when the violations are determined to be willful or repeated. The law also prohibits discriminating against or discharging workers who file a complaint or participate in any proceeding under the Act.

### ADDITIONAL INFORMATION

- Certain occupations and establishments are exempt from the minimum wage and/or overtime pay provisions.
- Special provisions apply to workers in American Samoa and the Commonwealth of the Northern Mariana Islands.
- Some state laws provide greater employee protections; employers must comply with both.
- The law requires employers to display this poster where employees can readily see it.
- Employees under 20 years of age may be paid \$4.25 per hour during their first 90 consecutive calendar days of employment with an employer.
- Certain full-time students, student learners, apprentices, and workers with disabilities may be paid less than the minimum wage under special certificates issued by the Department of Labor.

For additional information:



# 1-866-4-USWAGE

(1-866-487-9243)

TTY: 1-877-889-5627



# WWW.WAGEHOUR.DOL.GOV

**PROPOSAL BID ITEMS**

192910

Page 1 of 1

Report Date 8/9/19

**Section: 0001 - ROADWAY**

LINE	BID CODE	ALT	DESCRIPTION	QUANTITY	UNIT	UNIT PRIC	FP	AMOUNT
0010	02562		TEMPORARY SIGNS	1,350.00	SQFT		\$	
0020	02650		MAINTAIN & CONTROL TRAFFIC APPLIES TO 059B00046N	1.00	LS		\$	
0030	02654		TRUCK MOUNTED ATTENUATOR	4.00	EACH		\$	
0040	02671		PORTABLE CHANGEABLE MESSAGE SIGN	2.00	EACH		\$	
0050	02775		ARROW PANEL	4.00	EACH		\$	
0060	06549		PAVE STRIPING-TEMP REM TAPE-B	800.00	LF		\$	
0070	06550		PAVE STRIPING-TEMP REM TAPE-W	800.00	LF		\$	
0080	06551		PAVE STRIPING-TEMP REM TAPE-Y	400.00	LF		\$	

**Section: 0002 - BRIDGE**

LINE	BID CODE	ALT	DESCRIPTION	QUANTITY	UNIT	UNIT PRIC	FP	AMOUNT
0090	02403		REMOVE CONCRETE MASONRY	1.50	CUYD		\$	
0100	08526		CONC CLASS M FULL DEPTH PATCH	2.50	CUYD		\$	
0110	21650NN		BOLT/RIVET REPLACEMENT	1,700.00	EACH		\$	
0120	24879EC		STEEL REPAIR	3.00	EACH		\$	

**Section: 0003 - DEMOBILIZATION**

LINE	BID CODE	ALT	DESCRIPTION	QUANTITY	UNIT	UNIT PRIC	FP	AMOUNT
0130	02569		DEMOBILIZATION	1.00	LS		\$	