



CALL NO. 317

CONTRACT ID. 182044

MASON COUNTY

FED/STATE PROJECT NUMBER FD05 081 0009 007-011

DESCRIPTION AA HIGHWAY (KY 9)

WORK TYPE PAVEMENT (WITH ALTERNATES)

PRIMARY COMPLETION DATE 9/30/2018

LETTING DATE: January 26,2018

Sealed Bids will be received electronically through the Bid Express bidding service until 10:00 AM EASTERN STANDARD TIME January 26,2018. Bids will be publicly announced at 10:00 AM EASTERN STANDARD TIME.

NO PLANS ASSOCIATED WITH THIS PROJECT.

REQUIRED BID PROPOSAL GUARANTY: Not less than 5% of the total bid.

TABLE OF CONTENTS

PART I	SCOPE OF WORK
	<ul style="list-style-type: none">• PROJECT(S), COMPLETION DATE(S), & LIQUIDATED DAMAGES• CONTRACT NOTES• STATE CONTRACT NOTES• NATIONAL HIGHWAY• SURFACING AREAS• ASPHALT MIXTURE• INCIDENTAL SURFACING• COMPACTION OPTION B• SPECIAL NOTE(S) APPLICABLE TO PROJECT• ASPHALT MIX PAVEMENT WEDGE MONOLITHIC OPERATION• EDGE KEY• ASPHALT MILLING AND TEXTURING• TYPICAL SECTION DIMENSIONS• TRAFFIC CONTROL PLAN 4 LANE• DURABLE PAVEMENT EDGE DETAILS• SKETCH MAP(S)• SUMMARY SHEET(S)• TYPICAL SECTION(S)
PART II	SPECIFICATIONS AND STANDARD DRAWINGS
	<ul style="list-style-type: none">• SPECIFICATIONS REFERENCE• SUPPLEMENTAL SPECIFICATION• [SN-1I] PORTABLE CHANGEABLE SIGNS• [SN-11L] MICRO-SURFACING• 2016 STANDARD DRAWINGS THAT APPLY
PART III	EMPLOYMENT, WAGE AND RECORD REQUIREMENTS
	<ul style="list-style-type: none">• LABOR AND WAGE REQUIREMENTS• EXECUTIVE BRANCH CODE OF ETHICS• KENTUCKY EQUAL EMPLOYMENT OPPORTUNITY ACT OF 1978 LOCALITY / STATE• PROJECT WAGE RATES / STATE
PART IV	INSURANCE
PART V	BID ITEMS

PART I
SCOPE OF WORK

ADMINISTRATIVE DISTRICT - 09

CONTRACT ID - 182044

FD05 081 0009 007-011

COUNTY - MASON

PCN - MP08100091801

FD05 081 0009 007-011

AA HIGHWAY (KY 9) (MP 7.176) FROM 153 FEET NORTH OF STRODES RUN ROAD EXTENDING NORTH TO US 62
(MP 10.256), A DISTANCE OF 03.08 MILES.PAVEMENT (WITH ALTERNATES)
GEOGRAPHIC COORDINATES LATITUDE 38:37:01.00 LONGITUDE 83:46:44.00

COMPLETION DATE(S):

COMPLETED BY 09/30/2018

APPLIES TO ENTIRE CONTRACT

CONTRACT NOTES

PROPOSAL ADDENDA

All addenda to this proposal must be applied when calculating bid and certified in the bid packet submitted to the Kentucky Department of Highways. Failure to use the correct and most recent addenda may result in the bid being rejected.

BID SUBMITTAL

Bidder must use the Department's Expedite Bidding Program available on the Internet web site of the Department of Highways, Division of Construction Procurement. (www.transportation.ky.gov/construction-procurement)

The Bidder must download the bid file located on the Bid Express website (www.bidx.com) to prepare a bid packet for submission to the Department. The bidder must submit electronically using Bid Express.

JOINT VENTURE BIDDING

Joint venture bidding is permissible. All companies in the joint venture must be prequalified in one of the work types in the Qualifications for Bidders for the project. The bidders must get a vendor ID for the joint venture from the Division of Construction Procurement and register the joint venture as a bidder on the project. Also, the joint venture must obtain a digital ID from Bid Express to submit a bid. A joint bid bond of 5% may be submitted for both companies or each company may submit a separate bond of 5%.

UNDERGROUND FACILITY DAMAGE PROTECTION

The contractor shall make every effort to protect underground facilities from damage as prescribed in the Underground Facility Damage Protection Act of 1994, Kentucky Revised Statute KRS 367.4901 to 367.4917. It is the contractor's responsibility to determine and take steps necessary to be in compliance with federal and state damage prevention directives. When prescribed in said directives, the contractor shall submit Excavation Locate Requests to the Kentucky Contact Center (KY811) via web ticket entry. The submission of this request does not relieve the contractor from the responsibility of contacting non-member facility owners, whom shall be contacted through their individual Protection Notification Center. Non-compliance with these directives can result in the enforcement of penalties.

SPECIAL NOTE FOR COMPOSITE OFFSET BLOCKS

Contrary to the Standard Drawings (2016 edition) the Cabinet will allow 6" composite offset blocks in lieu of wooden offset blocks, except as specified on proprietary end treatments and crash cushions. The composite blocks shall be selected from the Cabinet's List of Approved Materials.

REGISTRATION WITH THE SECRETARY OF STATE BY A FOREIGN ENTITY

Pursuant to KRS 176.085(1)(b), an agency, department, office, or political subdivision of the Commonwealth of Kentucky shall not award a state contract to a person that is a foreign entity required by [KRS 14A.9-010](#) to obtain a certificate of authority to transact business in the Commonwealth (“certificate”) from the Secretary of State under [KRS 14A.9-030](#) unless the person produces the certificate within fourteen (14) days of the bid or proposal opening. If the foreign entity is not required to obtain a certificate as provided in [KRS 14A.9-010](#), the foreign entity should identify the applicable exception. Foreign entity is defined within [KRS 14A.1-070](#).

For all foreign entities required to obtain a certificate of authority to transact business in the Commonwealth, if a copy of the certificate is not received by the contracting agency within the time frame identified above, the foreign entity’s solicitation response shall be deemed non-responsive or the awarded contract shall be cancelled.

Businesses can register with the Secretary of State at <https://secure.kentucky.gov/sos/ftbr/welcome.aspx>.

SPECIAL NOTE FOR PROJECT QUESTIONS DURING ADVERTISEMENT

Questions about projects during the advertisement should be submitted in writing to the Division of Construction Procurement. This may be done by fax (502) 564-7299 or email to kytc.projectquestions@ky.gov. The Department will attempt to answer all submitted questions. The Department reserves the right not to answer if the question is not pertinent or does not aid in clarifying the project intent.

The deadline for posting answers will be 3:00 pm Eastern Daylight Time, the day preceding the Letting. Questions may be submitted until this deadline with the understanding that the later a question is submitted, the less likely an answer will be able to be provided.

The questions and answers will be posted for each Letting under the heading “Questions & Answers” on the Construction Procurement website (www.transportation.ky.gov/contract). The answers provided shall be considered part of this Special Note and, in case of a discrepancy, will govern over all other bidding documents.

HARDWOOD REMOVAL RESTRICTIONS

The US Department of Agriculture has imposed a quarantine in Kentucky and several surrounding states, to prevent the spread of an invasive insect, the emerald ash borer. Hardwood cut in conjunction with the project may not be removed from the state. Chipping or burning on site is the preferred method of disposal.

INSTRUCTIONS FOR EXCESS MATERIAL SITES AND BORROW SITES

Identification of excess material sites and borrow sites shall be the responsibility of the Contractor. The Contractor shall be responsible for compliance with all applicable state and federal laws and may wish to consult with the US Fish and Wildlife Service to seek protection under Section 10 of the Endangered Species Act for these activities.

ACCESS TO RECORDS

The contractor, as defined in KRS 45A.030 (9) agrees that the contracting agency, the Finance and Administration Cabinet, the Auditor of Public Accounts, and the Legislative Research Commission, or their duly authorized representatives, shall have access to any books, documents, papers, records, or other evidence, which are directly pertinent to this contract for the purpose of financial audit or program review. Records and other prequalification information confidentially disclosed as part of the bid process shall not be deemed as directly pertinent to the contract and shall be exempt from disclosure as provided in KRS 61.878(1)(c). The contractor also recognizes that any books, documents, papers, records, or other evidence, received during a financial audit or program review shall be subject to the Kentucky Open Records Act, KRS 61.870 to 61.884.

In the event of a dispute between the contractor and the contracting agency, Attorney General, or the Auditor of Public Accounts over documents that are eligible for production and review, the Finance and Administration Cabinet shall review the dispute and issue a determination, in accordance with Secretary's Order 11-004.

06/01/16

SPECIAL NOTE FOR RECIPROCAL PREFERENCE

Reciprocal preference to be given by public agencies to resident bidders

By reference, KRS 45A.490 to 45A.494 are incorporated herein and in compliance regarding the bidders residency. Bidders who want to claim resident bidder status should complete the Affidavit for Claiming Resident Bidder Status along with their bid in the Expedite Bidding Program. Submittal of the Affidavit should be done along with the bid in Bid Express.

03/01/2011

NATIONAL HIGHWAY

Be advised this project is on the NATIONAL HIGHWAY SYSTEM.

SURFACING AREAS

The Department estimates the mainline surfacing width to be varied 24-78 feet.

The Department estimates the total mainline area to be surfaced to be 96,209 square yards.

The Department estimates the shoulder width to be 1 foot on each side.

The Department estimates the total shoulder area to be surfaced to be 3,613 square yards.

ASPHALT MIXTURE

Unless otherwise noted, the Department estimates the rate of application for all asphalt mixtures to be 110 lbs/sy per inch of depth.

INCIDENTAL SURFACING

The Department has included in the quantities of asphalt mixtures established in the proposal estimated quantities required for resurfacing or surfacing mailbox turnouts, farm field entrances, residential and commercial entrances, curve widening, ramp gores and tapers, and road and street approaches, as applicable. Pave these areas to the limits as shown on Standard Drawing RPM-110-06 or as directed by the Engineer. In the event signal detectors are present in the intersecting streets or roads, pave the crossroads to the right of way limit or back of the signal detector, whichever is the farthest back of the mainline. Surface or resurface these areas as directed by the Engineer. The Department will not measure placing and compacting for separate payment but shall be incidental to the Contract unit price for the asphalt mixtures.

OPTION B

Be advised that the Department will control and accept compaction of asphalt mixtures furnished on this project under OPTION B in accordance with Sections 402 and 403.

SPECIAL NOTE FOR ASPHALT SCRUB SEAL

1. DESCRIPTION. This work consists of placing a polymer modified asphalt emulsion which is scrubbed with a broom to fill and seal cracks and covered with a layer of aggregate.

2. MATERIAL AND EQUIPMENT.

Asphalt Material. Furnish undiluted CMS-1P or CMS-1PC polymer modified emulsion that meets requirements below:

EMULSIFIED ASPHALT SPECIFICATION			
PROPERTY	METHOD	SPECIFICATION	
		CMS-1P	CMS-1PC
Test on Emulsion			
Viscosity @ 122 °F (SFS)	AASHTO T 59	50 - 350	50-350
Residue, w%, minimum. ⁽¹⁾	AASHTO T 59	67	60
pH	ASTM E 70	2.0-5.0	2.0-5.0
Sieve, w%, max.	AASHTO T 59	0.1	0.1
Oil distillate, w%, max.	AASHTO T 59	0.5	0.5
TEST ON RESIDUE			
Viscosity @ 140 °F, P, maximum.	AASHTO T 201	3000	-
Penetration @ 39.2 °F, minimum.	AASHTO T 49	40	30
Elastic Recovery on residue by distillation, %, minimum ⁽²⁾	AASHTO T 301	50	50
Test on Polymer:			
Tensile strength, die C dumbbell, psi, minimum	ASTM D 412 ⁽³⁾	500	800
Swelling in rejuvenating agent, % maximum; 48 hours exposure @ 104 °F	ASTM D 471 ⁽⁴⁾ Modified	40% intact film	40%
Latex Density @ 73 °F	ASTM D 6937 ^(5,6)	-	1.00-1.05
TEST ON REJUVENATING AGENT:			
Flash point, COC, °F	AASHTO T 48	380 Min	
Viscosity, 140 °F, CST	AASHTO T 201	50-175	
Saturate, % by wt.	ASTM D 2007	30 Max	
Asphaltenes	ASTM D 2007	1.0 Max.	
Test on Residue from RTFO	AASHTO T 240		
Weight Change, %		6.5 Max.	
Viscosity Ratio		3 Max	

- (1) Exception to AASHTO T59: Bring the temperature on the lower thermometer slowly to 350 ± 10 °F. Maintain at this temperature for 20 minutes. Complete total distillation in 60 ± 5 min from first application of heat.
- (2) Elastic Recovery @ 10 °C (50 °F): Hour glass sides, pull 20 cm, hold 5 minutes then cut, let sit 1 hour.
- (3) Tensile Strength Determination: Samples for testing for tensile strength in accordance with ASTM D412 shall be tested with the following test procedure modifications:
- (4) Prepare the polymer film, dilute the waterborne polymer to 40% Total Solids Content and pour 57 g into a Teflon or silicone release mold of dimensions 7" X 7" X ¼". Allow to dry at 23°C (73 °F) and 50% RH (controlled conditions) for 7 – 10 days total time, during which time the film should be flipped around once, preferably after 3 or 4 days. The film should be transparent in the end. To drive out any residual water, place the film in an oven at 50 °C for 30 min. Dried film thickness should be 25 ± 5 mils. Discard films <20 mil. Cut out dumbbell-shaped test specimens of dimension 75 mm total length, 25 mm mid-section (L) and 4 mm width of mid-section. Grip in Instron machine with gap size 1 inch, use 8 in/min cross-head speed.
- (5) Polymer testing shall be prepared from polymer as follows: Resistance to Swelling: Using a syringe, place 0.8 g of latex into an 18 mm diameter DSR mold. Allow the sample to dry at ambient lab conditions (air conditioned) on the bench for 72 hours. Sample should be easily removable from the mold. Take the "button" out of the mold and place the sample into a forced air oven at 40 °C (104 °F) for 48 h (on release paper). If at the end of the ambient dry, the sample sticks to the mold, place it into the oven and check it after 1-2 h. After 48 h, cool and weigh the sample to the nearest 0.0001 g and record the weight. Put ½ in of Rejuvenating Agent into a 3 oz penetration tin. Place the "button" on the rejuvenating agent, and add another ½ in of rejuvenating agent, so that the "button" is covered. Put the cap on the penetration tin and place it into the 40 °C oven for 48 h. Remove the "button" from the Rejuvenating Agent, blot surface of the "button" to remove excess Rejuvenating Agent, cool the "button" to room temperature and weigh it. Calculate weight gain of the "button", express as a percent.
- (6) Replace "Emulsified Asphalt" with "Latex" in text of test method. The testing temperature used should be 25 ± 3 °C. The calculation in Section 7 should be as follows:

$$D = (W_f - W_t) * 0.1$$

$$S.G. = D / 8.337$$

Where: W_f = Weight of filled cup (g)

W_t = Weight of empty cup (g)

The Department will require a sample of the polymerized emulsion to be taken from the distributor spray bar at a lot frequency of one sample per 5,000 gallons of emulsion. Take two 1 gallon samples of the heated material and forward the sample to the Division of Materials for testing. Ensure the product temperature is between 160° and 180° F at the time of sampling.

Aggregate. Provide a cleaned washed aggregate cover material from an approved aggregate producer and shall meet the material requirements that conform to **Section 805**, as applicable. However, contrary to **Section 805.15** the Department will base the reduction on the bid price for the chip aggregate. Also, contrary to **Section 805.05.04** provide coarse aggregates having no more than 2.0 percent passing the No. 200 sieve.

Equipment. Provide, and keep on the project at all times, an accurate thermometer, hand brooms, and other small tools and equipment essential for completion of the work.

Calibration of equipment application rates shall be completed on day at a time directed by the engineer. A test strip shall be required at the beginning of each new project or as directed by the engineer.

The asphalt distributor for the application of the emulsion shall have full circulation spray bar that is adjustable to at least 16 feet wide in 2 feet increments and capable of heating and circulating the emulsion simultaneously, conforming to **Section 406.02.05**. It must have computerized rate control for adjusting and controlling the application from the cab within 0.01 gallons per square yard increments. The distributor shall also be equipped with a volume measuring device and a thermometer for measuring the emulsion temperature in the tank. For each emulsion application, follow manufactures recommendations for proper nozzle type and adjustment.

The scrub broom shall be rigid in frame construction and attached to and pulled by the distributor. It shall be light enough so not to squeegee the emulsion off the roadway surface. The leading and trailing broom heads angled at 10 to 15 degrees off the centerline of the supporting member with stiff bristles at minimum height of 5 inches.

The aggregate spreader be a front discharge, continuous mechanical feed, self-propelled aggregate spreader with a screen capable of removing oversized materials. It must have computerized control for adjusting and regulating application rates, as well as width, from the operating platform. Ensure the spreader can evenly distribute the aggregate from the transporting vehicle directly onto the fresh asphalt material in smooth, uniform layers, independent of the forward speed. The spreader must be capable of being filled and moved without discharging aggregate. The spreader must be equipped with a locking mechanism compatible with the triaxle trucks used to supply aggregate.

Rollers. Pneumatic tire roller shall weigh at least 5 tons. Steel wheel type roller shall weigh at least 5 tons but no more than 8 tons.

3. CONSTRUCTION.

Weather Limitations. Application of chip seal shall be applied when air temperature is at least 50 degrees F and rising and a minimum surface temperature of 70 degrees F. Do not construct when the ambient temperature within the preceding 24 hours has been 35 degrees F or lower. Do not proceed with construction if rain is expected in a minimum period of 24 hours. If an unexpected shower arises during operations, the asphalt distributor should be shut off immediately and placement of aggregate continued until all asphalt has been covered.

Preparation of Mixture. Submit a complete mix design a minimum of 14 days prior to construction. Mix design shall be prepared by an approved laboratory, to verify the compatibility of the aggregate, asphalt emulsion and other additives. Perform the mix design with the same materials that will be used on the project.

Surface Preparation. Prior to operation, the contractor shall remove all existing thermoplastic striping, thermoplastic legends, and raised markers within application limits. All surfaces intended for application shall be thoroughly cleaned of all vegetation, loose material, dirt, or other objectionable material immediately before application of emulsion using a mechanical sweeper and wire hand brooms, when necessary. Clean the edges of the surface providing a full and uniformly clean width of roadway.

Where mud or earth exists, remove it in advance and allow surface to thoroughly dry before applying emulsion. Mowing or removal of shoulder vegetation and or brush may be necessary for proper application.

If cracks cannot be adequately filled by emulsion, fill with proper asphalt material or hot pour joint sealer conforming to **Section 807.03.01**. If applicable, apply cover aggregate before applying chip seal application.

Application Rates of Materials.

Properties	Minimum	Maximum
Application rate of emulsion, gal/sqyd*	0.25	0.40
Emulsion temperature, F	110	185
Application rate of aggregate, lb/sqyd*	10	25

*For double chip seal applications:

1st treatment layer shall be applied at 40% of total emulsion rate

2nd treatment layer shall be applied at 60% of total emulsion rate

*Engineer may adjust application rates due to existing conditions

*In cases where adequate emulsion application rates or coverage do not meet the engineer’s requirements, the engineer may remove the scrub broom from the application process.

4. APPLICATION.

Application of Emulsion. Heat and maintain emulsion between 110 and 185 degrees F during application. Polymer modified emulsion shall be applied when air temperature is at least 50 degrees F and rising and a minimum surface temperature of 70 degrees F.

Emulsion shall be applied using a pressure distributor in a uniform, continuous quantity at specified rates.

Keep the nozzles of the spray bar clean at all times. Immediately make any streaked areas uniform by use of a hand hose equipped with a nozzle.

Scrubbing. Mechanically scrub emulsion by dragging the broom directly in tow of the distributor, spreading the emulsion evenly over the road surface filling all cracks and voids.

Do not allow distributor and brooming equipment to apply asphalt material ahead of aggregate spreader for more than 150 feet.

When the scrub seal treatment is constructed in half-widths, provide complete coverage by overlapping the 2 applications approximately 4 inches along centerline.

Prevent spotting or discoloring curbs, headwalls, and other structures. When such discolorations occur, remove them at no expense to KYTC.

Utilize building paper or other materials approved by the engineer to provide a clean and proper construction joint. A straight edge shall be used to ensure a consistent and even joint.

Aggregate. Aggregate cover material shall be cleaned and washed to remove dirt and dust, ensuring appropriate adhesion with emulsion. Due to this process, aggregate may be damp during application. Immediately following scrubbing and prior to breaking of the emulsion, aggregate shall be continuously

and evenly spread with the proper equipment at the specified rates. Spreading equipment shall not contact the asphalt material before it is covered with aggregate. Precautions should be taken not to exceed the designated rate by more than 5 percent. Use hand brooms to correct any irregularities.

Rolling. Two self-propelled pneumatic tire rollers and one steel wheel roller shall be used for the required rolling of the aggregate. This shall be done no more than 5 minutes after the spreading of aggregate. Operate the rollers parallel to the centerline in a manner preventing the dislodgment of newly applied aggregate. Rolling should proceed from the outer edge to the center, with each pass overlapping the previous by one-half. Rolling shall consist of at least 2 passes or more with pneumatic tire roller, followed by at least 1 pass with the steel wheel roller when the engineer directs. Roller speeds shall not exceed 5 mph.

Sweeping. Power sweep and/or vacuum the completed application to remove all excess aggregate after the asphalt material has completely cured. The curing time shall be determined by the engineer. Surface shall be swept or vacuumed prior to any striping or other surface applications. A second sweeping may be required following the initial application day. If applying an additional surface treatment over the chip seal, it may be opened to traffic for an amount of time specified in the contract or as directed by the engineer.

Little to no aggregate shall be remaining on the following:

- Entrances
- Exit aprons
- Intersections
- Crossroads
- Driveways
- Lawns
- Curbs
- Shoulders

5. MEASUREMENT.

When an authorized adjustment is made, KYTC will measure quantities up to 5 percent in excess of the designated application rate for payment. KYTC will not measure quantities exceeding the designated application rate by more than 5 percent for payment.

Asphalt Material. KYTC will measure the quantity in tons according to **Section 109.**

Aggregate. KYTC will measure the quantity in sqyd according to **Section 109.**

6. PAYMENT.

KYTC will make payment for the completed and accepted quantities of emulsified asphalt according to the following:

Emulsified Asphalt Price Adjustment Schedule						
Test	Specification	100% Pay	90% Pay	80% Pay	50% Pay	0% Pay
CMS-1P						
Viscosity, 122 ° F (SFS) AASHTO T 59	50 - 350	48 - 355	47 356	46 357	45 358	≤44 • 359
pH, ASTM E 70	2.0 – 5.0	1.9 - 5.1	1.8 5.2	1.7 5.3	1.6 5.4	• 1.5 • 5.5
Residue Penetration @ 4 •C, AASHTO T 49	• 40	• 39	38	37	36	• 35
Particle Charge, AASHTO T 59	Positive					
Oil Distillate, %, AASHTO T 59	• 0.5	• 0.6	0.65	0.7	0.75	• 0.8
Residue, % AASHTO T 59	≥ 67.0	≥ 66.0	65.5	65	64.5	≤ 64.4
Sieve, % AASHTO T 59	• 0.1	• 0.2	0.3	0.4	0.5	• 0.51
Residue Elastic Recovery @ 50 ° F (cm) AASHTO T 301	≥ 50.0	≥ 48.0	47	46	45	≤ 44.9
Residue Viscosity @ 140 • F, P	• 3000	• 3020	3021- 3040	3041- 3060	3061- 3070	• 3071
CMS-1PC						
Viscosity, 122 ° F (SFS) AASHTO T 59	50 - 350	48 - 355	47 356	46 357	45 358	≤44 • 359
pH, ASTM E 70	2.0 – 5.0	1.9 - 5.1	1.8 5.2	1.7 5.3	1.6 5.4	• 1.5 • 5.5
Residue Penetration @ 4 •C, AASHTO T 49	• 30	• 29	28	27	26	• 25
Particle Charge, AASHTO T 59	Positive					
Oil Distillate, %, AASHTO T 59	• 0.5	• 0.6	0.65	0.7	0.75	• 0.8
Residue, % AASHTO T 59	≥ 60.0	≥ 59.0	58.5	58	57.5	≤ 57.4
Sieve, % AASHTO T 59	• 0.1	• 0.2	0.3	0.4	0.5	• 0.51
Residue Elastic Recovery @ 50 • F (cm) AASHTO T 301	• 50.0	• 48.0	47	46	45	• 44.9

Pay Item

Polymer Asphalt Emulsion for Scrub Seal
 Asphalt Seal Aggregate

Pay Unit

Ton
 Sqyd

KYTC will consider payment as full compensation for all work required under this section.

SPECIAL NOTE FOR POLISH-RESISTANT AGGREGATE IN NO 4 THINLAY ASPHALT MIXTURES

Contrary to Subsection 403.03.03, provide polish-resistant aggregate in the ASPH SURF NO.4 asphalt mixture conforming to one of the following requirements:

ASPH SURF NO.4A

- 100 percent of total combined aggregate is Class A polish-resistant aggregate.

ASPH SURF NO.4B

- 50 percent or more of the total combined aggregate is Class A polish-resistant aggregate; or
- 100 percent of total combined aggregate is Class B polish-resistant aggregate.

Contrary to Section 409.03.03 of the *Standards and Specifications*, for a 4.75mm asphalt mixture requiring a Class A or B polish resistant aggregate, the use of recycled/reclaimed materials is prohibited. For 4.75mm asphalt mixtures requiring Class D aggregate, recycled asphalt pavement (RAP) shall not

SPECIAL NOTE FOR TACK OIL APPLICATIONS FOR NO 4 THINLAY ASPHALT MIXTURES

Contrary to 406.03.03, apply tack at a rate to achieve an undiluted residue of 0.8 pounds (0.10 gallons) per square yard.

SPECIAL NOTE FOR PAVEMENT MARKING REMOVAL

Pavement Marking Removal is to be used to remove existing thermoplastic markings, as directed by the Engineer.

SPECIAL NOTE FOR PAVEMENT WEDGE AND SHOULDER MONOLITHIC OPERATION

1.0 MATERIALS. Provide an Asphalt Surface Mixture conforming to Section 403 of the Standard Specifications, as applicable to the project, for the pavement wedge.

2.0 CONSTRUCTION. Place the specified Asphalt Surface Mixture on shoulders monolithically with the driving lane. Prime the existing shoulder with tack material as the Engineer directs before placing the wedge. Construct according to Section 403.03 of the Standard Specifications.

Equip the paver with a modified screed that extends the full width of the wedge being placed and is tapered to produce a wedge. Obtain the Engineer's approval of the modified screed before placing shoulder wedge monolithically with the driving lane.

The wedge may vary in thickness at the edge of the milled area in the shoulder. If the area to receive the shoulder wedge is milled prior to placement, during rolling operations pinch the outside edge of the new inlay wedge to match the existing shoulder elevation not being resurfaced. Unless required otherwise by the Contract, construct rolled or sawed rumble strips according to Section 403.03.08, as applicable.

The following sketch is primarily for the computation of quantities; however, the wedge will result in a similar cross-section where sufficient width exists. Do not construct a shoulder for placing the wedge unless specified elsewhere in the Contract.

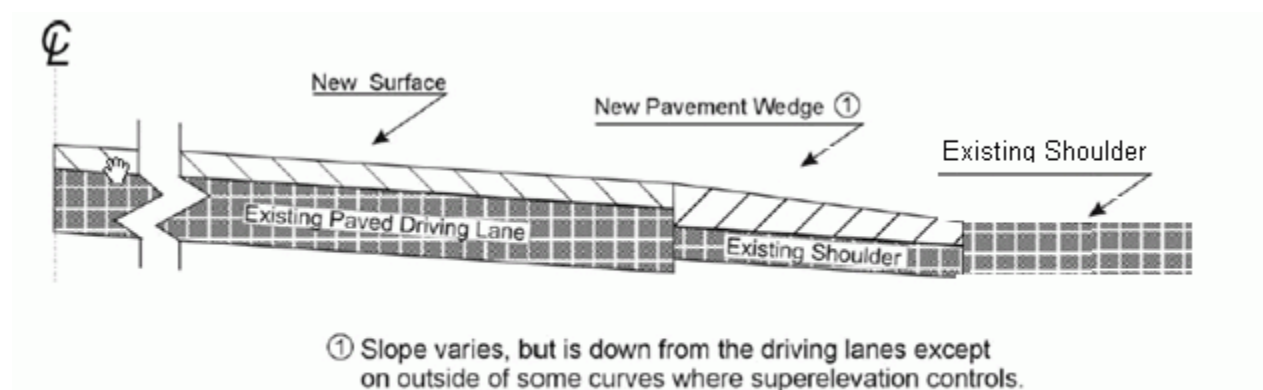

3.0 MEASUREMENT. The Department will measure Asphalt Surface Mixture placed as the pavement wedge according to Section 403.

4.0 PAYMENT. The Department will make payment for the completed and accepted quantities of Asphalt Surface Mixtures on pavement wedges according to Section 403.

SPECIAL NOTE FOR EDGE KEY

Construct Edge Keys at the beginning of project, end of project, at railroad crossings, and at ramps, as applicable. Unless specified in the Contract or directed by the Engineer, do not construct edge keys at intersecting streets, roads, alleys, or entrances. Cut out the existing asphalt surface to the required depth and width shown on the drawing and heel the new surface into the existing surface. The Department will make payment for this work at the Contract unit price per ton for Asphalt Pavement Milling and Texturing, which shall be full compensation for all labor, materials, equipment, and incidentals for removal and disposal of the existing asphalt surface required to construct the edge key.

EDGE KEY



Thickness = 1.00 Inches

L = 100 LF

L= Length of Edge Key

**SPECIAL NOTE FOR
ASPHALT MILLING AND TEXTURING**

Begin paving operations within **48 hours** of commencement of the milling operation. Continue paving operations continuously until completed. If paving operations are not begun within this time period, the Department will assess liquidated damages at the rate prescribed by Section 108.09 until such time as paving operations are begun.

Take possession of the millings and recycle the millings or dispose of the millings off the Right-of-Way at sites obtained by the Contractor at no additional cost to the Department.

1-3520 48 hours Contractor keeps millings
01/2/2012

SPECIAL NOTE FOR TYPICAL SECTION DIMENSIONS

Consider the dimensions shown on the typical sections for pavement and shoulder widths and thickness' to be nominal or typical dimensions. The Engineer may direct or approve varying the actual dimensions to be constructed to fit existing conditions. Do not widen existing pavement or shoulders unless specified elsewhere in this proposal or directed by the engineer.

1-3725 Typical Section Dimensions
01/02/2012

TRAFFIC CONTROL PLAN

TRAFFIC CONTROL GENERAL

Except as provided herein, maintain and control traffic in accordance with the Standard and Supplemental Specifications and the Standard and Sepia Drawings, current editions. Except for the roadway and traffic control bid items listed, all items of work necessary to maintain and control traffic will be paid at the lump sum bid price to "Maintain and Control Traffic".

Contrary to Section 106.01, furnish new, or used in like new condition, traffic control devices at the beginning of the work and maintain in like new condition until completion of the work.

PROJECT PHASING & CONSTRUCTION PROCEDURES

The Engineer may specify additional days and hours when lane closures will not be allowed.

At locations with three or more lanes, maintain one lane of traffic in each direction at all times during construction. At locations with two lanes, maintain alternating one way traffic during construction. Provide a minimum clear lane width of 11 feet; however, provide for passage of vehicles of up to 16 feet in width. If traffic should be stopped due to construction operations, and a school bus on an official run arrives on the scene, make provisions for the passage of the bus as quickly as possible.

SCRUB SEAL

At locations where the scrub seal is to be applied, provide "LOOSE GRAVEL" signs and "25 MPH" signs, as directed by the Engineer.

LANE CLOSURES

Do not leave lane closures in place during non-working hours.

SIGNS

Sign posts and splices shall be compliant with NCHRP 350 or MASH. Manufacturer's documentation validating this compliance shall be provided to the Engineer prior to installation. Signs, including any splices, shall be installed according to manufacturer's specifications and installation recommendations. Contrary to section 112.04.02, only long-term signs (signs intended to be continuously in place for more than 3 days) will be measured for payment. Short-term signs

Traffic Control Plan
Page 2 of 10

(signs intended to be left in place for 3 days or less) will not be measured for payment but will be incidental to Maintain and Control Traffic.

CHANGEABLE MESSAGE SIGNS

Provide changeable message signs in advance of and within the project at locations determined by the Engineer. If work is in progress concurrently in both directions or if more than one lane closure is in place in the same direction of travel, provide additional changeable message signs as directed by the Engineer. Place changeable message signs one mile in advance of the anticipated queue at each lane closure. As the actual queue lengthens and/or shortens, relocate or provide additional changeable message signs so that traffic has warning of slowed or stopped traffic at least one mile but not more than two miles before reaching the end of the actual queue. The Engineer may vary the designated locations as the work progresses. The Engineer will determine the messages to be displayed. In the event of damage or mechanical/electrical failure, repair or replace the Changeable Message Sign within 24 hours. The Department will measure for payment the maximum number of Changeable Message Signs in concurrent use at the same time on a single day on all sections of the contract. The Department will measure individual Changeable Message Signs only once for payment, regardless of how many times they are set, reset, removed, and relocated during the duration of the project. The Department will not measure replacements for damaged Changeable Message Signs or for signs the Engineer directs be replaced due to poor condition or readability. Retain possession of the Changeable Message Signs upon completion of the work.

ARROW PANELS

Use arrow panels as shown on the Standard Drawings or as directed by the Engineer. The Department will measure for payment the maximum number of arrow panels in concurrent use at the same time on a single day on all sections of the contract. The Department will measure for payment the maximum number of Arrow Panels in concurrent use at the same time on a single day on all sections of the contract. The Department will measure individual Arrow Panels only once for payment, regardless of how many times they are set, reset, removed, and relocated during the duration of the project. The Department will not measure replacements for damaged Arrow Panels or for panels signs the Engineer directs be replaced due to poor condition or readability for payment. Retain possession of the Arrow Panels upon completion of the work.

TEMPORARY ENTRANCES

The Engineer will not require the Contractor to provide continuous access to farms, single family, duplex, or triplex residential properties during working hours; however, provide reasonable egress and ingress to each such property when actual operations are not in progress at that location. Limit the time during which a farm or residential entrance is blocked to the minimum length of time required for actual operations, not extended for the Contractor's convenience, and in no case

Traffic Control Plan Page 3 of 10

exceeding six (6) hours. Notify all residents twenty-four hours in advance of any driveway or entrance closings and make any accommodations necessary to meet the access needs of disabled residents.

Except as allowed by the Phasing as specified above, maintain direct access to all side streets and roads, schools, churches, commercial properties and apartments or apartment complexes of four or more units at all times.

The Department will measure asphalt materials required to construct and maintain any temporary entrances which may be necessary to provide temporary access; however, the Department will not measure aggregates, excavation, and/or embankment, but shall be incidental to Maintain and Control Traffic. The Engineer will determine the type of surfacing material, asphalt or aggregate, to be used at each entrance.

THERMOPLASTIC INTERSECTION MARKINGS

Consider the locations listed on the summary as approximate only. Prior to milling and/or resurfacing, locate and document the locations of the existing markings. After resurfacing, replace the markings at their approximate existing locations or as directed by Engineer. Place markings not existing prior to resurfacing as directed by the Engineer.

BARRICADES

The Department will not measure barricades used in lieu of barrels and cones for channelization or delineation, but shall be incidental to Maintain and Control Traffic according to Section 112.04.01.

The Department will measure barricades used to protect pavement removal areas in individual units each. The Department will measure for payment the maximum number of barricades in concurrent use at the same time on a single day on all sections of the contract. The Department will measure individual barricades only once for payment, regardless of how many times they are set, reset, removed, and relocated during the duration of the project. The Department will not measure replacements for damaged barricades the Engineer directs to be replaced due to poor condition or reflectivity. Retain possession of the Barricades upon completion of the work.

PAVEMENT MARKINGS

If there is to be a deviation from the existing striping plan, the Engineer will furnish the Contractor a striping plan prior to placement of the final surface course. Install Temporary Striping according to Section 112 with the following exceptions:

1. Place Temporary or Permanent Striping before opening a lane to traffic; and

Traffic Control Plan
Page 4 of 10

2. If the Contractor's operations or phasing requires temporary markings that must subsequently be removed from the final surface course, use an approved removable lane tape; however, the Department will not measure removable lane tape for separate payment, but will measure and pay for removable lane tape as temporary striping.

PAVEMENT EDGE DROP-OFFS

Do not allow a pavement edge between opposing directions of traffic or lanes that traffic is expected to cross in a lane change situation with an elevation difference greater than 1½". Place Warning signs (MUTCD W8-11 or W8-9A) in advance of and at 1500' intervals throughout the drop-off area. Dual post the signs on both sides of the traveled way. Wedge all transverse transitions between resurfaced and unresurfaced areas which traffic may cross with asphalt mixture for leveling and wedging. Remove the wedges prior to placement of the final surface course.

Protect pavement edges that traffic is not expected to cross, except accidentally, as follows:

Less than 2" - No protection required.

2" to 4" - Place plastic drums, vertical panels, or barricades every 50 feet. During daylight working hours only, the Engineer will allow the Contractor to use cones in lieu of plastic drums, panels, and barricades. Wedge the drop-off with DGA or asphalt mixture for leveling and wedging with a 1:1 or flatter slope in daylight hours, or 3:1 or flatter slope during nighttime hours, when work is not active in the drop-off area.

Greater than 4" - Protect drop-offs greater than 4 inches within 10 feet of traffic by placing drums, vertical panels, or barricades every 25 feet. The Engineer will not allow the use of cones in lieu of drums, vertical panels, or barricades for drop-offs greater than 4". Place Type III Barricades directly in front of the drop-off facing on coming traffic in both directions of travel. Provide warning signs as shown on the Standard Drawings or as directed by the Engineer

Pedestrians & Bicycles - Protect pedestrian and bicycle traffic as directed by the engineer.

Traffic Control Plan
Page 5 of 10

USE AND PLACEMENT OF CHANGEABLE MESSAGE SIGNS

The following policy is based upon current Changeable Message Signs (CMS) standards and practice from many sources, including the Federal Highway Administration (FHWA), other State Departments of Transportation, and Traffic Safety Associations. It is understood that each CMS installation or use requires individual consideration due to the specific location or purpose. However, there will be elements that are constant in nearly all applications. Accordingly these recommended guidelines bring a level of uniformity, while still being open to regional experience and engineering judgment.

Application

The primary purpose of CMS is to advise the driver of unexpected traffic and routing situations. Examples of applications where CMS can be effective include:

- Closures (road, lane, bridge, ramp, shoulder, interstate)
- Changes in alignment or surface conditions
- Significant delays, congestion
- Construction/maintenance activities (delays, future activities)
- Detours/alternative routes
- Special events with traffic and safety implications
- Crash/incidents
- Vehicle restrictions (width, height, weight, flammable)
- Advance notice of new traffic control devices
- Real-time traffic conditions (must be kept up to date)
- Weather /driving conditions, environmental conditions, Roadway Weather Information Systems
- Emergency Situations
- Referral to Highway Advisory Radio (if available)
- Messages as approved by the County Engineer's Office

CMS should not be used for:

- Replacement of static signs (e.g. road work ahead), regulatory signage (e.g. speed limits), pavement markings, standard traffic control devices, conventional warning or guide signs.
- Replacement of lighted arrow board
- Advertising (Don't advertise the event unless clarifying "action" to be taken by driver – e.g. Speedway traffic next exit)
- Generic messages
- Test messages (portable signs only)
- Describe recurrent congestion (e.g. rush hour)
- Public service announcements (not traffic related)

Traffic Control Plan
Page 6 of 10

Messages

Basic principles that are important to providing proper messages and insuring the proper operation of a CMS are:

- Visible for at least ½ mile under ideal daytime and nighttime conditions
- Legible from all lanes a minimum of 650 feet
- Entire message readable twice while traveling at the posted speed
- Nor more than two message panels should be used (three panels may be used on roadways where vehicles are traveling less than 45 mph). A panel is the message that fits on the face of the sign without flipping or scrolling.
- Each panel should convey a single thought; short and concise
- Do not use two unrelated panels on a sign
- Do not use the sign for two unrelated messages
- Should not scroll text horizontally or vertically
- Should not contain both the words left and right
- Use standardized abbreviations and messages
- Should be accurate and timely
- Avoid filler/unnecessary words and periods (hazardous, a, an, the)
- Avoid use of speed limits
- Use words (not numbers) for dates

Placement

Placement of the CMS is important to insure that the signs is visible to the driver and provides ample time to take any necessary action. Some of the following principles may only be applicable to controlled access roadways. The basic principles of placement for a CMS are:

- When 2 signs are needed, place on same side of roadway and at least 1,000 feet apart
- Place behind semi-rigid/rigid protection (guardrail, barrier) or outside of the clear zone
- Place 1,000 feet in advance of work zone; at least one mile ahead of decision point
- Normally place on right side of roadway; but should be placed closest to the affected lane so that either side is acceptable
- Signs should not be dual mounted (one on each side of roadway facing same direction)
- Point trailer hitch downstream
- Secure to immovable object to prevent thief (if necessary)
- Do not place in sags or just beyond crest
- Check for reflection of sun to prevent the blinding of motorist
- Should be turned ~3 degrees outward from perpendicular to the edge of pavement
- Bottom of sign should be 7 feet above the elevation of edge of roadway
- Should be removed when not in use

Traffic Control Plan
 Page 7 of 10

Standard Abbreviations

The following is a list of standard abbreviations to be used on CMS.

<u>Word</u>	<u>Abbrev.</u>	<u>Example</u>
Access	ACCS	ACCIDENT AHEAD/USE ACCS RD NEXT RIGHT
Alternate	ALT	ACCIDENT AHEAD/USE ALT RTE NEXT RIGHT
Avenue	AVE	FIFTH AVE CLOSED/DETOUR NEXT LEFT
Blocked	BLKD	FIFTH AVE BLKD/MERGE LEFT
Boulevard	BLVD	MAIN BLVD CLOSED/USE ALT RTE
Bridge	BRDG	SMITH BRDG CLOSED/USE ALT RTE
Cardinal Directions	N, S, E, W	N I75 CLOSED/ DETOUR EXIT 30
Center	CNTR	CNTR LANE CLOSED/MERGE LEFT
Commercial	COMM	OVRSZ COMM VEH/USE I275
Condition	COND	ICY COND POSSIBLE
Congested	CONG	HVY CONG NEXT 3 MI
Construction	CONST	CONST WORK AHEAD/EXPECT DELAYS
Downtown	DWNTN	DWNTN TRAF USE EX 40
Eastbound	E-BND	E-BND I64 CLOSED/DETOUR EXIT 20
Emergency	EMER	EMER VEH AHEAD/PREPARE TO STOP
Entrance, Enter	EX, EXT	DWNTN TRAF USE EX 40
Expressway	EXPWY	WTRSN EXPWY CLOSED/DETOUR EXIT 10
Freeway	FRWY, FWY	GN SYNDR FWY CLOSED/DETOUR EXIT 15
Hazardous Materials	HAZMAT	HAZMAT IN ROADWAY/ALL TRAF EXIT 25
Highway	HWY	ACCIDENT ON AA HWY/EXPECT DELAYS
Hour	HR	ACCIDENT ON AA HWY/2 HR DELAY
Information	INFO	TRAF INFO TUNE TO 1240 AM
Interstate	I	E-BND I64 CLOSED/DETOUR EXIT 20
Lane	LN	LN CLOSED/MERGE LEFT
Left	LFT	LANE CLOSED/MERGE LFT
Local	LOC	LOC TRAF USE ALT RTE
Maintenance	MAINT	MAINT WRK ON BRDG/SLOW
Major	MAJ	MAJ DELWAYS I75/USE ALT RTE

Traffic Control Plan
 Page 8 of 10

Mile	MI	ACCIDENT 3 MI AHEAD/ USE ALT RTE
Minor	MNR	ACCIDENT 3 MI MNR DELAY
Minutes	MIN	ACCIDENT 3 MI/30 MIN DELAY
Northbound	N-BND	N-BND I75 CLOSED/ DETOUR EXIT 50
Oversized	OVRSZ	OVRSZ COMM VEH/USE I275 NEXT RIGHT
Parking	PKING	EVENT PKING NEXT RGT
Parkway	PKWY	CUM PKWAY TRAF/DETOUR EXIT 60
Prepare	PREP	ACCIDENT 3 MIL/PREP TO STOP
Right	RGT	EVENT PKING NEXT RGT
Road	RD	HAZMAT IN RD/ALL TRAF EXIT 25
Roadwork	RDWK	RDWK NEXT 4 MI/POSSIBLE DELAYS
Route	RTE	MAJ DELAYS I75/USE ALT RTE
Shoulder	SHLDR	SHLDR CLOSED NEXT 5 MI
Slippery	SLIP	SLIP COND POSSIBLE/ SLOW SPD
Southbound	S-BND	S-BND I75 CLOSED/DETOUR EXIT 50
Speed	SPD	SLIP COND POSSIBLE/ SLOW SPD
Street	ST	MAIN ST CLOSED/USE ALT RTE
Traffic	TRAF	CUM PKWAY TRAF/DETOUR EXIT 60
Vehicle	VEH	OVRSZ COMM VEH/USE I275 NEXT RIGHT
Westbound	W-BND	W-BND I64 CLOSED/DETOUR EXIT 50
Work	WRK	CONST WRK 2MI/POSSIBLE DELAYS

Certain abbreviations are prone to inviting confusion because another word is abbreviated or could be abbreviated in the same way. DO NO USE THESE ABBREVIATIONS.

<u>Abbrev.</u>	<u>Intended Word</u>	<u>Word Erroneously Given</u>
ACC	Accident	Access (Road)
CLRS	Clears	Colors
DLY	Delay	Daily
FDR	Feeder	Federal
L	Left	Lane (merge)
LOC	Local	Location
LT	Light (traffic)	Left
PARK	Parking	Park
POLL	Pollution (index)	Poll
RED	Reduce	Red
STAD	Stadium	Standard

Traffic Control Plan
Page 9 of 10

TEMP
WRNG

Temporary
Warning

Temperature
Wrong

TYPICAL MESSAGES

The following is a list of typical messages used on CMS. The list consists of the reason or problem that you want the driver to be aware of and the action that you want the driver to take.

Reason/Problem

ACCIDENT
ACCIDENT/XX MILES
XX ROAD CLOSED
XX EXIT CLOSED
BRIDGE CLOSED
BRIDGE/(SLIPPERY, ICE, ETC.)
CENTER/LANE/CLOSED
DELAY(S), MAJOR/DELAYS
DEBRIS AHEAD
DENSE FOG
DISABLED/VEHICLE
EMER/VEHICLES/ONLY
EVENT PARKING
EXIT XX CLOSED
FLAGGER XX MILES
FOG XX MILES
FREEWAY CLOSED
FRESH OIL
HAZMAT SPILL
ICE
INCIDENT AHEAD
LANES (NARROW, SHIFT, MERGE, ETC.)
LEFT LANE CLOSED
LEFT LANE NARROWS
LEFT 2 LANES CLOSED
LEFT SHOULDER CLOSED
LOOSE GRAVEL
MEDIAN WORK XX MILES
MOVING WORK ZONE, WORKERS IN ROADWAY
NEXT EXIT CLOSED
NO OVERSIZED LOADS
NO PASSING
NO SHOULDER
ONE LANE BRIDGE

Action

ALL TRAFFIC EXIT RT
AVOID DELAY USE XX
CONSIDER ALT ROUTE
DETOUR
DETOUR XX MILES
DO NOT PASS
EXPECT DELAYS
FOLLOW ALT ROUTE
KEEP LEFT
KEEP RIGHT
MERGE XX MILES
MERGE LEFT
MERGE RIGHT
ONE-WAY TRAFFIC
PASS TO LEFT
PASS TO RIGHT
PREPARE TO STOP
REDUCE SPEED
SLOW
SLOW DOWN
STAY IN LANE
STOP AHEAD
STOP XX MILES
TUNE RADIO 1610 AM
USE NN ROAD
USE CENTER LANE
USE DETOUR ROUTE
USE LEFT TURN LANE
USE NEXT EXIT
USE RIGHT LANE
WATCH FOR FLAGGER

Traffic Control Plan
Page 10 of 10

PEOPLE CROSSING
RAMP CLOSED
RAMP (SLIPPERY, ICE, ETC.)
RIGHT LANE CLOSED
RIGHT LANE NARROWS
RIGHT SHOULDER CLOSED
ROAD CLOSED
ROAD CLOSED XX MILES
ROAD (SLIPPERY, ICE, ETC.)
ROAD WORK
ROAD WORK (OR CONSTRUCTION) (TONIGHT, TODAY, TOMORROW, DATE)
ROAD WORK XX MILES
SHOULDER (SLIPPERY, ICE, SOFT, BLOCKED, ETC.)
NEW SIGNAL XX MILES
SLOW 1 (OR 2) - WAY TRAFFIC
SOFT SHOULDER
STALLED VEHICLES AHEAD
TRAFFIC BACKUP
TRAFFIC SLOWS
TRUCK CROSSING
TRUCKS ENTERING
TOW TRUCK AHEAD
UNEVEN LANES
WATER ON ROAD
WET PAINT
WORK ZONE XX MILES
WORKERS AHEAD

DURABLE PAVEMENT EDGE DETAIL

(Resurfacing adjacent to fill slope or ditch foreslope that is 3:1 or less)

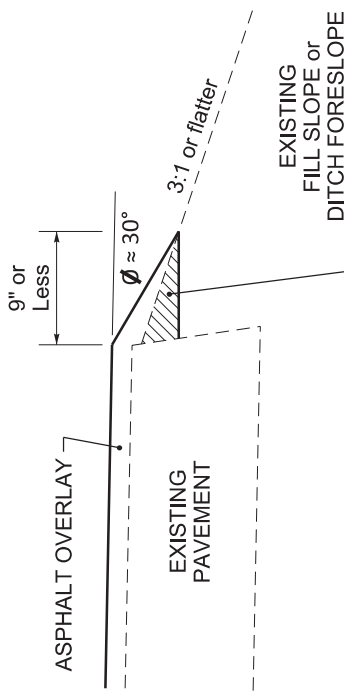

PREPARE SHOULDER ACCORDING TO STANDARD SPECIFICATIONS

DURABLE PAVEMENT EDGE DETAIL

(Resurfacing adjacent to low shoulder with dropoff of 5 inches or less)

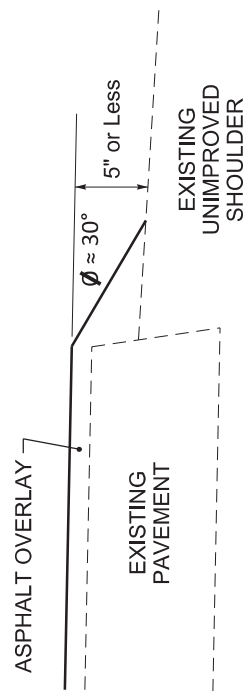

DURABLE PAVEMENT EDGE DETAIL

(Resurfacing adjacent to low shoulder with dropoff of more than 5 inches)

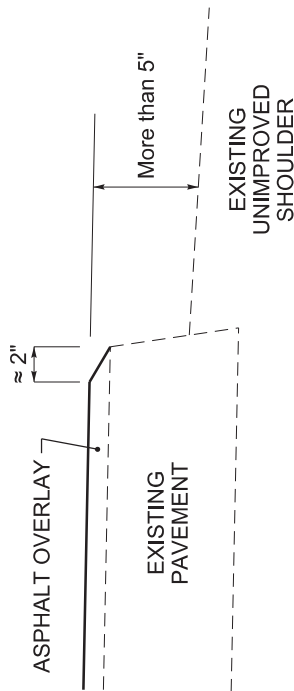

DURABLE PAVEMENT EDGE DETAIL

(Resurfacing adjacent to an obstruction, such as an existing headwall)

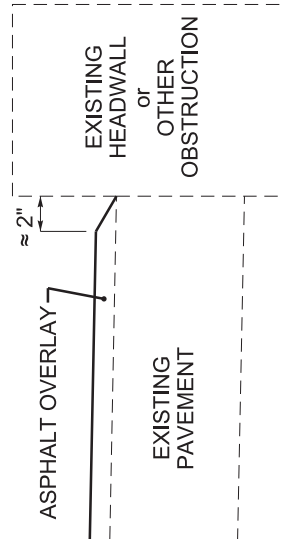

DURABLE PAVEMENT EDGE DETAIL

(Resurfacing adjacent to fill slope or ditch foreslope that is steeper than 3:1)

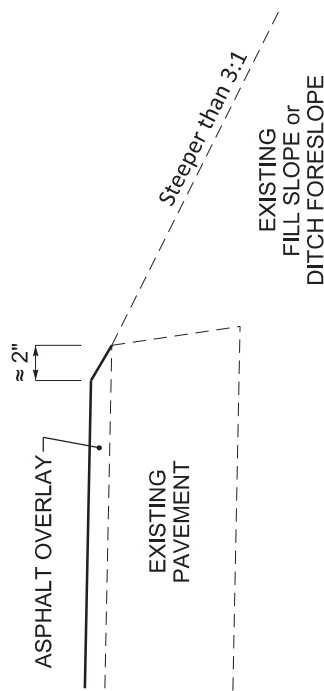

NOTES

1. DETAILS DO NOT APPLY TO OVERLAYS LESS THAN 1 INCH THICK.
2. THE DURABLE PAVEMENT EDGE DEVICE MAY BE DISENGAGED AT DRIVEWAYS, SIDE STREETS, HIGH SHOULDERS, AND OTHER LOCATIONS NOT FEASIBLE TO CONSTRUCT, AS APPROVED BY THE ENGINEER.

DRAWING NOT TO SCALE

DURABLE PAVEMENT EDGE DETAILS

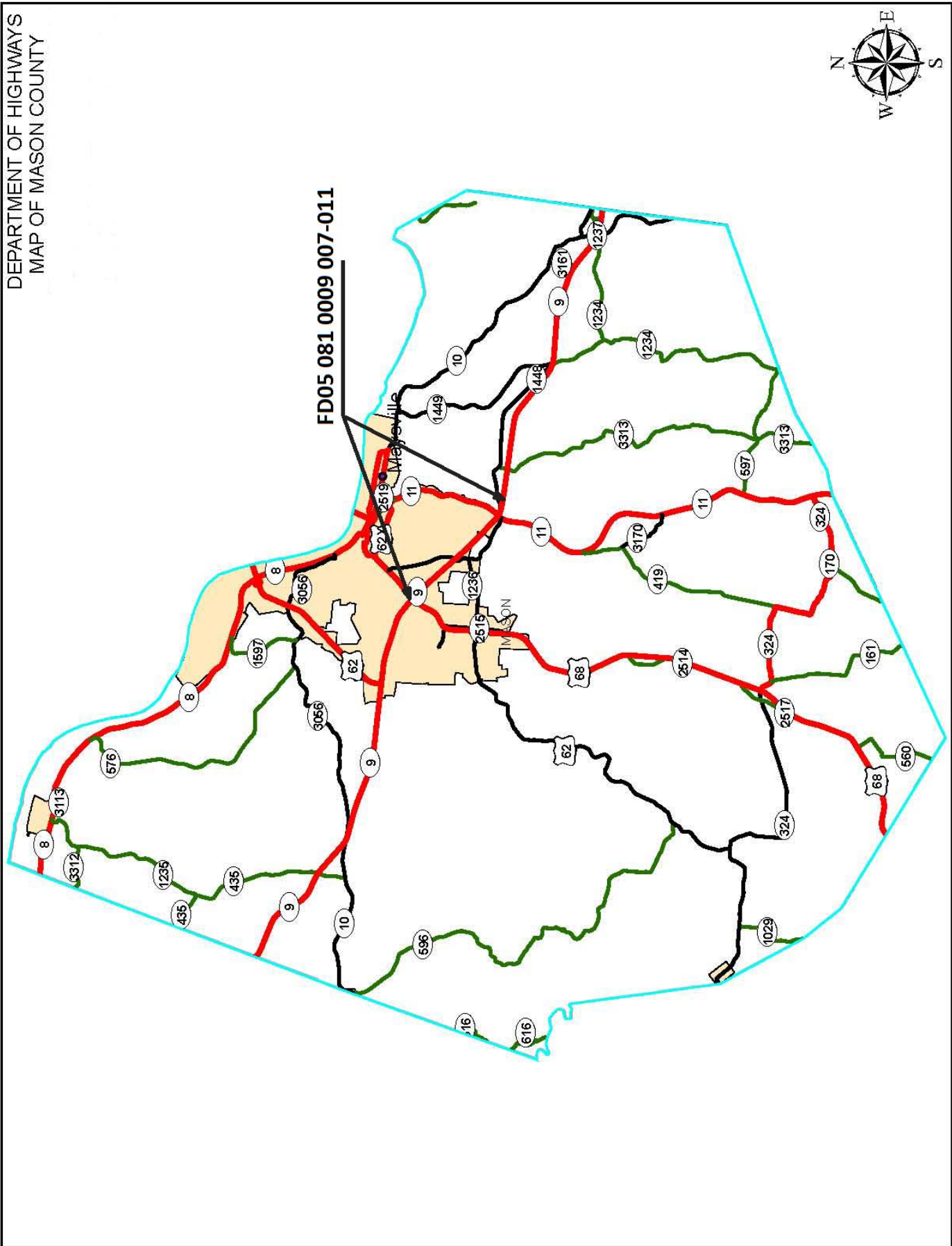

**Mason County
THERMOPLASTIC INTERSECTION PAVEMENT MARKINGS SUMMARY
FD05 081 0009 007-011**

MPT.	INTERSECTION	X-WALKS		STP BARS		CURVE		ARROWS		"ONLY"		REMOVE		NOTES
		6 INCH	LF	24 INCH	LF	EA	EA	STR	EA	EA	EA	EA	EA	
7.352	KY 1448					2								SB LEFT TURN LANE
8.971	KY 1448			40		2								NB LEFT TURN LANE
8.971	KY 1448			50		6								SB LT. & RT TURN LANES
9.274	WALMART WAY					5								NB LEFT TURN LANE
9.274	WALMART WAY					7								SB LT. & RT TURN LANES
9.435	WALMART WAY CONN			40		5								NB LEFT TURN LANE
9.435	WALMART WAY CONN			50		8								SB LT. & RT TURN LANES
9.610	TUCKER DRIVE					6								NB LT. & RT. TURN LANES
9.610	TUCKER DRIVE					4								SB LT. & RT TURN LANES
9.853	MARKET SQ. DIVIDE			40		4								NB LEFT TURN LANE
9.853	MARKET SQ. DIVIDE			50		3								SB LEFT TURN LANE
9.992	MARKET SQ. DRIVE					3								NB RIGHT TURN LANE
9.992	MARKET SQ. DRIVE					6								SB LT. & RT TURN LANES
10.256	US 62					2					2			NB LT. & RT. TURN LANES
TOTAL				270		63					2			

MASON COUNTY
 MILLING AND EDGE KEY SUMMARY

KY 9

<u>BEGIN</u>	<u>END</u>	<u>DESCRIPTION</u>	<u>LENGTH (FT)</u>	<u>WIDTH (FT)</u>	<u>AVG. DEPTH (IN)</u>	<u>TONS</u>	<u>NOTES</u>
7.176	7.195	EDGE KEY 1" TO 0"	100	26	0.5	7.97	
7.471	7.490	EDGE KEY 0" TO 1"	100	62	0.5	19.01	END OF CONCRETE TO 100'
7.490	7.550	MILL 1"	317	25	1.0	48.40	
7.586	7.615	MILL 1"	153	25	1.0	23.39	
7.615	7.634	EDGE KEY 1" TO 0"	100	62	0.5	19.01	END OF CONCRETE TO 100'
10.198	10.217	EDGE KEY 0" TO 1"	100	60	0.5	18.39	END OF CONCRETE TO 100'
10.217	10.256	MILL 1"	206	24	1.0	30.20	BETWEEN CONCRTE & CURB
						TOTAL:	98.77

MEDIAN AND SIDE ROAD EDGE KEYS 8' WIDTH

MASON COUNTY
FD05 081 0009 007-011
TYPICAL SECTION
MP 7.176 - 10.256
MICROSURFACE ALTERNATE

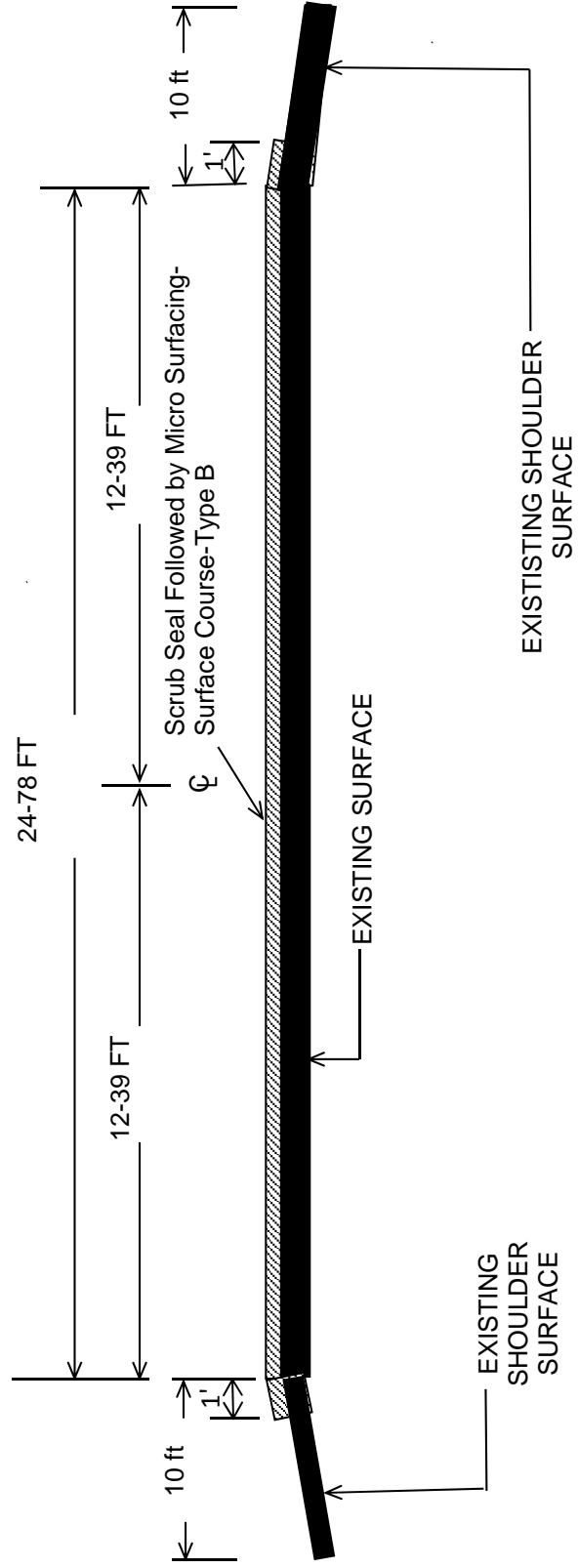

***PLACE SCRUB SEAL & SINGLE MICROSURFACING COURSE 1' ONTO EACH SHOULDER**

MASON COUNTY
FD05 081 0009 007-011
TYPICAL SECTION
MP 7.176 - 10.256
THINLAY ALTERNATE

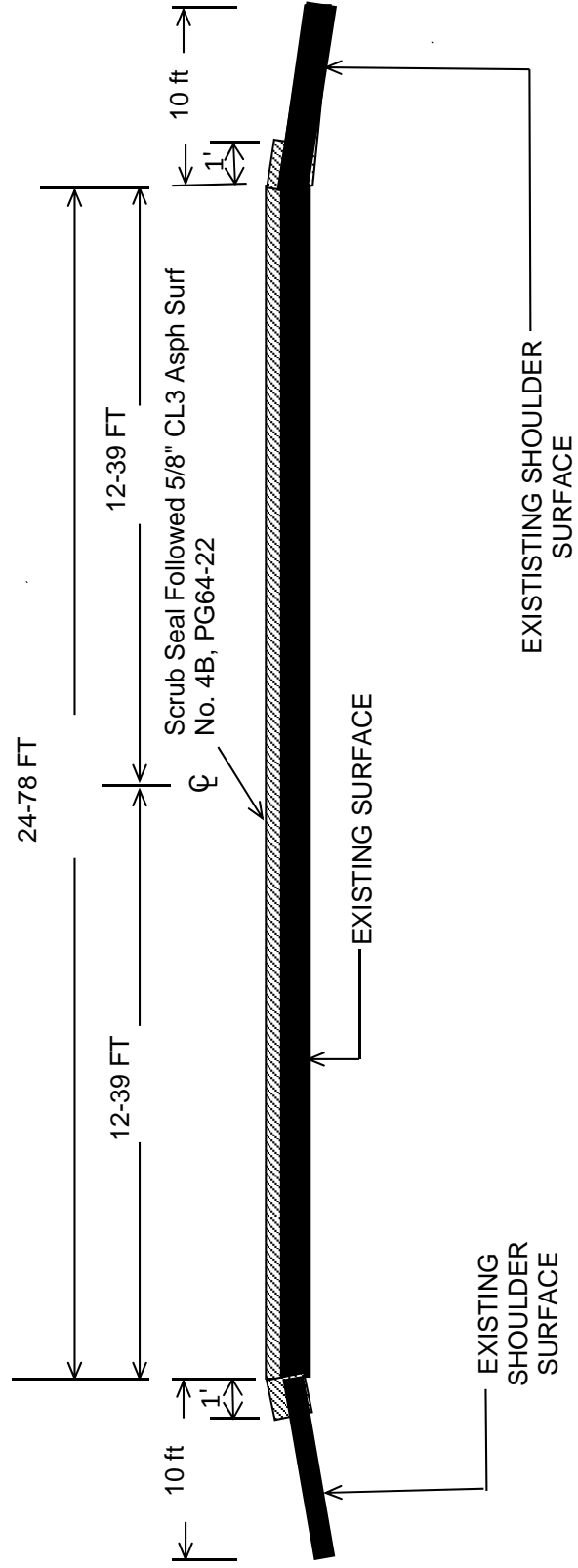

***PLACE SCRUB SEAL & SINGLE MICROSURFACING COURSE 1' ONTO EACH SHOULDER**

*****CURB AND GUTTER SECTIONS WILL BE EDGE KEYED ALONG GUTTER LINE 8' WIDE**

PART II
SPECIFICATIONS AND STANDARD DRAWINGS

SPECIFICATIONS REFERENCE

Any reference in the plans or proposal to previous editions of the *Standard Specifications for Road and Bridge Construction* and *Standard Drawings* are superseded by *Standard Specifications for Road and Bridge Construction, Edition of 2012* and *Standard Drawings, Edition of 2016*.

SUPPLEMENTAL SPECIFICATIONS

The contractor shall use the Supplemental Specifications that are effective at the time of letting.
The Supplemental Specifications can be found at the following link:

<http://transportation.ky.gov/Construction/Pages/Kentucky-Standard-Specifications.aspx>

SPECIAL NOTE FOR PORTABLE CHANGEABLE MESSAGE SIGNS

This Special Note will apply when indicated on the plans or in the proposal.

1.0 DESCRIPTION. Furnish, install, operate, and maintain variable message signs at the locations shown on the plans or designated by the Engineer. Remove and retain possession of variable message signs when they are no longer needed on the project.

2.0 MATERIALS.

2.1 General. Use LED Variable Message Signs Class I, II, or III, as appropriate, from the Department's List of Approved Materials.

Unclassified signs may be submitted for approval by the Engineer. The Engineer may require a daytime and nighttime demonstration. The Engineer will make a final decision within 30 days after all required information is received.

2.2 Sign and Controls. All signs must:

- 1) Provide 3-line messages with each line being 8 characters long and at least 18 inches tall. Each character comprises 35 pixels.
- 2) Provide at least 40 preprogrammed messages available for use at any time. Provide for quick and easy change of the displayed message; editing of the message; and additions of new messages.
- 3) Provide a controller consisting of:
 - a) Keyboard or keypad.
 - b) Readout that mimics the actual sign display. (When LCD or LCD type readout is used, include backlighting and heating or otherwise arrange for viewing in cold temperatures.)
 - c) Non-volatile memory or suitable memory with battery backup for storing pre-programmed messages.
 - d) Logic circuitry to control the sequence of messages and flash rate.
- 4) Provide a serial interface that is capable of supporting complete remote control ability through land line and cellular telephone operation. Include communication software capable of immediately updating the message, providing complete sign status, and allowing message library queries and updates.
- 5) Allow a single person easily to raise the sign to a satisfactory height above the pavement during use, and lower the sign during travel.
- 6) Be Highway Orange on all exterior surfaces of the trailer, supports, and controller cabinet.
- 7) Provide operation in ambient temperatures from -30 to + 120 degrees Fahrenheit during snow, rain and other inclement weather.
- 8) Provide the driver board as part of a module. All modules are interchangeable, and have plug and socket arrangements for disconnection and reconnection. Printed circuit boards associated with driver boards have a conformable coating to protect against moisture.
- 9) Provide a sign case sealed against rain, snow, dust, insects, etc. The lens is UV stabilized clear plastic (polycarbonate, acrylic, or other approved material) angled to prevent glare.
- 10) Provide a flat black UV protected coating on the sign hardware, character PCB, and appropriate lens areas.
- 11) Provide a photocell control to provide automatic dimming.

- 12) Allow an on-off flashing sequence at an adjustable rate.
- 13) Provide a sight to aim the message.
- 14) Provide a LED display color of approximately 590 nm amber.
- 15) Provide a controller that is password protected.
- 16) Provide a security device that prevents unauthorized individuals from accessing the controller.
- 17) Provide the following 3-line messages preprogrammed and available for use when the sign unit begins operation:

/KEEP/RIGHT/=>=>=>/	/MIN/SPEED/**MPH/
/KEEP/LEFT/<=<=<=</	/ICY/BRIDGE/AHEAD/ /ONE
/LOOSE/GRAVEL/AHEAD/	LANE/BRIDGE/AHEAD/
/RD WORK/NEXT/**MILES/	/ROUGH/ROAD/AHEAD/
/TWO WAY/TRAFFIC/AHEAD/	/MERGING/TRAFFIC/AHEAD/
/PAINT/CREW/AHEAD/	/NEXT/***/MILES/
/REDUCE/SPEED/**MPH/	/HEAVY/TRAFFIC/AHEAD/
/BRIDGE/WORK/***0 FT/	/SPEED/LIMIT/**MPH/
/MAX/SPEED/**MPH/	/BUMP/AHEAD/
/SURVEY/PARTY/AHEAD/	/TWO/WAY/TRAFFIC/

*Insert numerals as directed by the Engineer.
Add other messages during the project when required by the Engineer.

2.3 Power.

- 1) Design solar panels to yield 10 percent or greater additional charge than sign consumption. Provide direct wiring for operation of the sign or arrow board from an external power source to provide energy backup for 21 days without sunlight and an on-board system charger with the ability to recharge completely discharged batteries in 24 hours.

3.0 CONSTRUCTION. Furnish and operate the variable message signs as designated on the plans or by the Engineer. Ensure the bottom of the message panel is a minimum of 7 feet above the roadway in urban areas and 5 feet above in rural areas when operating. Use Class I, II, or III signs on roads with a speed limit less than 55 mph. Use Class I or II signs on roads with speed limits 55 mph or greater.

Maintain the sign in proper working order, including repair of any damage done by others, until completion of the project. When the sign becomes inoperative, immediately repair or replace the sign. Repetitive problems with the same unit will be cause for rejection and replacement.

Use only project related messages and messages directed by the Engineer, unnecessary messages lessen the impact of the sign. Ensure the message is displayed in either one or 2 phases with each phase having no more than 3 lines of text. When no message is needed, but it is necessary to know if the sign is operable, flash only a pixel.

When the sign is not needed, move it outside the clear zone or where the Engineer directs. Variable Message Signs are the property of the Contractor and shall be removed from the project when no longer needed. The Department will not assume ownership of these signs.

4.0 MEASUREMENT. The final quantity of Variable Message Sign will be

11

the actual number of individual signs acceptably furnished and operated during the project. The Department will not measure signs replaced due to damage or rejection.

5.0 PAYMENT. The Department will pay for the Variable Message Signs at the unit price each. The Department will not pay for signs replaced due to damage or rejection. Payment is full compensation for furnishing all materials, labor, equipment, and service necessary to, operate, move, repair, and maintain or replace the variable message signs. The Department will make payment for the completed and accepted quantities under the following:

<u>Code</u>	<u>Pay Item</u>	<u>Pay Unit</u>
02671	Portable Changeable Message Sign	Each

Effective June 15, 2012

October 2017

SPECIAL NOTE FOR MICROSURFACING

1. DESCRIPTION. This work consists of constructing a cold-laid, polymer-modified, emulsified asphalt pavement course to fill ruts or provide an intermediate or surface course for existing pavements. The paving mixture is composed of a polymer-modified emulsified asphalt, crushed aggregate, mineral filler, water, and possibly other additives. Follow the requirements outlined in ASTM D 6372, Standard Practice for Design, Testing, and Construction of Microsurfacing, with modifications as found in this note. Apply this material according to the lines, grades, and typical cross-sections in the plans or as established by the Engineer.

Unless otherwise noted, Section references herein are to the Department's Standard Specifications for Road and Bridge Construction, current edition. All applicable portions of the Department's Standard Specifications apply unless specifically modified herein.

2. MATERIALS AND EQUIPMENT.

2.1 Mineral Filler. Use Portland Cement, Type I, conforming to Section 801.

2.2 Aggregate. Provide 100-percent crushed aggregate conforming to Sections 804 and 805. Contrary to Subsection 403.03.03, provide polish-resistant aggregate in the asphalt mixture conforming to one of the following requirements:

Microsurfacing Type A

- 100 percent of total combined aggregate is Class A polish-resistant aggregate.

Microsurfacing Type B

- 100 percent of total combined aggregate is Class B or Class A polish-resistant aggregate.

Microsurfacing Type D

- No polish-resistant aggregate requirements

Contrary to ASTM D 6372, test sand equivalent according to AASHTO T 176, soundness according to Kentucky Method (KM) 64-610, and a maximum LA abrasion resistance of 35 percent when tested according to AASHTO T 96. Ensure all aggregates satisfy ASTM D 6372 for sand equivalent, soundness, and LA abrasion.

Do not use mineral aggregates that are inherently porous, such as blast-furnace slag, expanded shale, porous limestone, and lightweight aggregates, in this mixture.

2.3 Water. Conform to Section 803.

October 2017

2.4 Emulsified Asphalt. The polymer-modified emulsion will be a CQS-1hP conforming to AASHTO M 316 and tested according to T59. Distill sample at 350 °F. In addition, ensure that the emulsified asphalt conforms to the following criteria:

<u>Test</u>	<u>Criteria</u>
Ductility at 77 °F (AASHTO T 51)	40 cm (min)

Ensure the asphalt supplied can be found on the List of Approved Materials.

2.5 Equipment. All equipment necessary for the satisfactory performance of the work shall be on hand and approved before the work is permitted to begin. All equipment, tools, and machines used in the performance of this work shall be maintained in satisfactory working condition.

All trucks shall be covered immediately after loading with a cover of canvas or other suitable material. The cover shall lap down along the sides and rear of the truck bed a minimum of 6 in. and be secured by tie downs at a maximum of 5 ft. spacing along the sides and rear of the truck bed. All trucks must be equipped to meet the above requirements prior to commencing hauling operations.

2.6 Mixing Equipment. Produce the mixture in a self-propelled, front-feed, continuous-loading machine equipped with a conveyer-belt aggregate-delivery system and an interconnected, positive-displacement, water-jacketed gear pump and/or a variable displacement computerized rate control pump, to accurately proportion the aggregate and asphalt emulsion. Locate the mineral filler feed so the proper amount of mineral filler is dropped on the aggregate before discharge into the pug mill. Provide a spray bar to completely pre-wet the aggregate dropping down to the pug mill with additive and water before the introduction of the asphalt emulsion. Provide a twin-shaft, continuous-flow, multi-blade pug mill that is a minimum of 49 in. long. Ensure that the blade size and side clearances meet the equipment manufacturer's recommendations. Introduce the emulsion within the first one-third of the mixer length to ensure proper mixing of all materials before exiting the pug mill.

Equip the machine with opposite-side driving stations to allow full control of the machine from either side. Equip the mixer with a remote, forward-speed control at the rear mixing platform so the rear operator can control the forward speed and level of mixture in the paving or rut box. Provide material control devices that are readily accessible and positioned so the amount of each material used can be determined at any time.

Equip the mixing machine with a water pressure system and nozzle-type spray bar to provide a water spray ahead of and outside the spreader box when required. Apply water at a rate that will dampen the surface but not create free-flowing water ahead of the spreader box.

October 2017

The mixer shall be equipped with a computerized material monitoring system with integrated material control devices that are readily accessible and positioned so the amount of each material used can be determined at any time. The mixer shall be equipped with a back-up electronic materials counter that is capable of recording running count totals for each material being monitored. The mixer shall include an attached radar ground measuring device or comparable device. Each material control device shall be calibrated prior to each mix application and at the discretion of the Engineer. The computer system shall have the capability to record, display, and print the following information:

- Individual sensor counts for emulsion, aggregate, cement, water and additive
- Aggregate, emulsion, and cement output in pounds per minute
- Ground travel distance
- Spread rate in pounds per square yard
- Percentages of emulsion, cement, water and additive
- Cumulative totals of aggregate, emulsion, cement, water and additive
- Scale factor for all materials

The computer system shall be functional at the beginning of work, and throughout the entire work operation.

2.7 Aggregate Equipment. In an effort to eliminate oversize materials in the finished mat, aggregate shall be screened directly into the trucks and weighed when removed from the stockpile and prior to delivery to the paver. The inspector shall view the screen for oversized aggregate and if it is found to have gaps, it shall be replaced or repaired before continuing to place the material.

2.8 Spreading Equipment. If a leveling or surface course is specified, apply the mixture uniformly by means of a conventional spreader box.

If a rut-fill course is specified, apply the mixture with a 5-6ft width, "V-shaped" rut-filling spreader box. Equip the rut-filling spreader box with a steel strike-off device.

Attach either type of spreader box to the mixer, and equip it with augers mounted on an adjustable shaft to continually agitate and distribute the materials throughout the box. Ensure that the equipment provides sufficient turbulence to prevent the mix from setting in the box or causing excessive build-up or lumps. To prevent loss of the mixture from the box, attach flexible seals, front and rear, in contact with the road. Operate the spreading equipment in such a manner as to prevent the loss of the mixture on super-elevated curves.

For surface courses, attach a secondary strike-off device to the spreader. Use neoprene rubber drags to obtain the desired finish. Replace drags having excessive buildup. Do NOT use burlap drags.

October 2017

2.9 Calibration Equipment. Supply all of the equipment, materials, and scales necessary to perform the calibration according to Section 3.5 of this note.

3. CONSTRUCTION.

3.1 Preparation and Proportioning of Mixture. Submit a complete mix design to the Division of Construction and to the Division of Materials, Asphalt Branch and Aggregate Section. Mix design shall be prepared by an approved laboratory, to verify the compatibility of the aggregate, asphalt emulsion, mineral filler, and other additives. Perform the mix design with the same materials that will be used on the project.

Ensure the mix design has a residual asphalt content, by dry weight of aggregate, of 7.0 to 8.5 percent for leveling and surface courses and 6.5 to 8.0 percent for rut-filling mixes. Also ensure the mixture contains no reclaimed materials and a mineral filler content between 0.25 and 2.0 percent by dry weight of aggregate.

In addition to the mix design information required by KM 64-421, provide the following (all percentages are based on the dry weight of aggregate):

- minimum and maximum percentage of water; and
- percentage of mix-set additives, if required.

Provide test results from an accredited laboratory that conform to ASTM D 6372.

Submit the mix design and two full 5-gallon buckets of the aggregate blend for the mixture to the Division of Materials for verification according to Subsection 402.03 a minimum of four weeks prior to initial use for testing and approval.

When requested by the Engineer, the Contractor shall calculate the % asphalt content of the mixture from the equipment computer display readings. If no request is made by the Engineer, the Contractor shall calculate the % asphalt content of the mixture from the equipment computer display readings randomly, a minimum of 3 times a day. The quality control tolerances from the mix design is $\pm 0.5\%$.

3.2 Mixture Gradation. Conform to the Type II requirements from ASTM D 6372 for surface courses and Type III requirements from ASTM D 6372 for leveling and rut-fill courses.

3.3 Weather Limitations. In addition to the applicable requirements in ASTM D 6372, apply the mixture only when rain is not imminent and the existing pavement surface temperature is at least 50 °F. The ambient temperature shall be at least 45 °F and rising and no forecasted temperatures shall be below 32 °F within a 24 hour period after placement. Do not place the material between November 1 and May 1.

October 2017

3.4 Surface Preparation. Before applying application, ensure the surface is clean and free from any debris

Remove pavement markers. Prior to application, fill depressions with microsurface material, asphalt material, or other approved material meeting the engineer's specifications.

Remove existing thermoplastic and/or excessive paint markings prior to application.

Contrary to Section 406, apply an approved tack coat material at rate of 0.03 to 0.06 gal/yd². Application rate shall be adjusted based on the surface texture and/or porosity. Do not apply tack coat on top of a rut fill or leveling course prior to placing surface course. Only apply tack coat to surfaces that will be covered by the application in the same day.

3.5 Calibration. Before mix production, calibrate the mixing equipment in the presence of the Engineer. Generate documentation for the Engineer, including individual calibrations of each material at various settings. Perform a new calibration if there is any change in the mix design. Following calibration and adjustments for changes in the mix design, do not make any further calibration adjustments to the mixing equipment without the Engineer's approval.

3.6 Application. Apply the paving mixture in a manner to fill minor surface irregularities and achieve a uniform surface without causing streaking, drag marks, skips, lumps, or tears. Carry a sufficient amount of material in the spreader box at all times to ensure complete and uniform coverage. Avoid overloading the spreader box. Do not allow lumping, balling, or unmixed aggregate in the spreader box.

If a rut-fill course is specified, apply enough material to fill the wheel paths without excess crowning (overfilling). An excess crown is defined as 1/8 in. after 24 h of traffic compaction. Apply rut-fill courses in widths from 5 to 6 ft for each wheel path. If rut depth exceeds 1.0 inches, apply rut fill course in multiple layers. Provide a smooth, neat seam where two rut-fill passes meet. Restore the design profile of the pavement cross-section. Feather the edges of the rut-fill course to minimize the use of excess material. Rut fill course shall not exhibit drag marks or tears greater than 1 inch wide, 1/2 inch in depth and greater than 12 inches in length. Rut fill course shall not exhibit excessive flushing or excessive roughness.

If a leveling course is specified, ensure the material covers the entire surface area. The leveling course may exhibit minor raveling upon opening to traffic but shall not exhibit any continued raveling after the first four hours to traffic. Leveling course shall not exhibit drag marks or tears greater than 1/2 inch wide, 1/4 inch in depth and greater than 12 inches in length. Leveling course shall not exhibit flushing or excessive roughness.

October 2017

If a leveling course is specified, apply the paving mixture at a dry aggregate rate of 14 ± 2 lb/yd². If a surface course is specified over a leveling or rut-fill course, apply the paving mixture at a dry aggregate rate of 18 ± 2 lb/yd². If a surface course only is specified, apply the paving mixture at a dry aggregate rate of 24 ± 2 lb/yd². For leveling course provide an even layer creating a neat center seam with no overlap where two passes meet. For surface courses, provide a smooth, neat center seam with a maximum overlap of 2 inches where two passes meet.

Construct surface courses wide enough to cover the outside edges of rut-fill and leveling courses. Maintain straight edge lines along curbs and shoulders. Do not allow runoff in these areas. Ensure that lines at the intersections are straight. Immediately remove excess material from the ends of each run.

Use squeegees and lutes to spread the mixture in areas inaccessible to the spreader box and areas requiring hand-spreading. With the Engineer's approval, adjust the mix-set additive to provide a slower setting time if hand-spreading is needed. Do not adjust the water content. If hand-spreading, pour the mixture in a small windrow along one edge of the surface to be covered, and spread it uniformly by a hand squeegee or lute.

Ensure the material cures at a rate that will permit traffic on the pavement within one hour of placement or time specified by the engineer.

If the final surface is not uniform in texture, free from streaks, drag marks, lumps, or tears, stop applying mixture and correct the problem. Do not resume work until the engineer is satisfied the problem has been corrected. If surface correction is necessary, due to traffic, rain, or other causes during construction of the project, repair areas of the surface.

3.7 Acceptance and Verification.

3.7.1 Proportion and Spread Rate. Maintain continuous control of the emulsified asphalt-to-dry aggregate proportion to conform to the approved mix design within a tolerance of ± 2 gal/ton. Ensure the spread rate satisfies the specified quantity of aggregate per square yard on a dry-weight basis.

When requested by the Engineer, the Contractor shall calculate the yield of the course being placed from the equipment computer display readings. If no request is made by the Engineer, the Contractor shall calculate the yield of the course being placed from the equipment computer display readings randomly, a minimum of 3 times a day. The quality control tolerance from the specified application rate is ± 2 lbs/sy.

The Department will base acceptance of the emulsified asphalt-to-dry aggregate proportion and the spread rate on the Engineer's summary of daily quantities. The Department will accept a day's application of Microsurfacing provided the Engineer's summary indicates conformance with the requirements for proportion and spread rate.

October 2017

3.7.2 Emulsified Asphalt. Submit samples of the polymer-modified emulsion to the Division of Materials for testing at a frequency of one sample per lot.

3.7.3 Mixture Gradation. Perform combined-gradation determinations on the aggregates used in the Microsurfacing at a frequency of one per day of production. The Department will allow the tested gradation to vary within the tolerances given in ASTM D 6372 provided the percent passing any sieve remains within the master gradation limits from ASTM D 6372.

The Department will perform combined-gradation determinations on the aggregates used in the Microsurfacing at a frequency of one per four days of production and compare those results with the contractor's combined-gradation results according to Subsection 402.03.03.

3.8 Documentation. The Contractor shall maintain a daily report including the following information:

- Aggregate used, ton (dry)
- Microsurfacing emulsion used, ton
- Bituminous Materials for Tack Coat, ton
- Cement used, ton
- Water used in mixture, gallons
- Additive used in mixture, gallons

3.9 Test Strip Construction. Prior to production application, the Contractor shall place a test section 1,000 ft. in length and one lane wide. The test strip shall demonstrate the mix and set time of the material and the ability to perform under traffic. If handwork will be required on the project, include handwork in the test strip. The test strip shall be placed at the same general time of day as paving is to take place (night or day), and under similar ambient conditions. The test strip shall be able to carry normal traffic within 60 minutes. If normal traffic cannot be carried, the emulsion or mixture must be adjusted and another test strip will be required. Upon approval of the test strip, the Contractor can begin application. Payment will only be made for the first test strip.

4. MEASUREMENT. The Department will pay for surface and leveling Microsurfacing courses by the number of square yards, complete and accepted in place. The Department will pay for Microsurfacing rut-fill course by the number of tons of dry aggregate used, complete and accepted in place. The weight of the dry aggregate used will be based on the calibrated weight of aggregate provided by the paving machine.

The Department will base the width of the pavement course on the width shown on the plans or as directed by the Engineer. The Department will measure the length along the centerline of each roadway or ramp.

October 2017

The Department will not measure the surface preparation or tack coat for payment and will consider them incidental to the Microsurfacing.

5. PAYMENT. The Department will consider the unit bid price per square yard to include all labor, materials, and equipment necessary to complete the work. The Department will make payment for the completed and accepted quantities according to the following:

Emulsified Asphalt Price Adjustment Schedule						
Test	Specification	100% Pay	90% Pay	80% Pay	50% Pay	0% Pay
CQS-1hP						
Viscosity, 77 ° F (SFS) AASHTO T 59	20 - 100	18 - 110	15 - 17 111 - 120	12 - 14 121 - 130	9 - 11 131 - 140	≤8 • 141
Residue Penetration, 77 •F AASHTO T 59	40 - 90	37 - 98	34 - 36 99 - 108	31 - 33 109 - 120	28 - 30 121 - 130	• 27 • 131
Softening Point, AASHTO T 53	• 135	• 130	127 - 134	128 - 129	126 - 127	• 125
Distillation Residue, % AASHTO T 59, 350•F	≥ 62.0	≥ 60.0	59.5	59.0	58.5	≤ 58.4
Sieve, % AASHTO T 59	• 0.1	• 0.3	0.31 - 0.45	0.46 - 0.60	0.61 - 0.75	• 0.76
Residue Elastic Recovery @ 50 ° F, % AASHTO T 301	≥ 60.0	≥ 58.0	57.0	56.0	55.0	≤ 54.9
Residue Ductility @ 77 • F, cm	• 40	• 38	37	36	35	• 34

<u>Code</u>	<u>Pay Item</u>	<u>Pay Unit</u>
20814EC	Micro Surfacing-Surface Course	Square Yard
21652EN	Micro Surfacing-Leveling Course	Square Yard
24515EC	Micro Surfacing-Rut Fill Course	Ton

**2016 KENTUCKY STANDARD DRAWINGS
SUPPLEMENTS TO STANDARD SPECIFICATIONS
TABLE OF CONTENTS**

CURVE WIDENING AND SUPERELEVATION TRANSITIONS.....RGS-001-07
SUPERELEVATION FOR MULTILANE PAVEMENT.....RGS-002-06
MISCELLANEOUS STANDARDSRGX-001-06
APPROACHES, ENTRANCES, AND MAIL BOX TURNOUT.....RPM-110-07
LANE CLOSURE MULTI-LANE HIGHWAY CASE I.....TTC-115-03
LANE CLOSURE MULTI-LANE HIGHWAY CASE II.....TTC-120-03
SHOULDER CLOSURE.....TTC-135-02
PAVEMENT CONDITION WARNING SIGNSTTD-125-02
MOBILE OPERATION FOR PAINT STRIPING CASE III.....TTS-110-02
MOBILE OPERATION FOR PAINT STRIPING CASE IVTTS-115-02

PART III

EMPLOYMENT, WAGE AND RECORD REQUIREMENTS

**TRANSPORTATION CABINET
DEPARTMENT OF HIGHWAYS**

**LABOR AND WAGE REQUIREMENTS
APPLICABLE TO OTHER THAN FEDERAL-AID SYSTEM PROJECTS**

- I. Application
- II. Nondiscrimination of Employees (KRS 344)

I. APPLICATION

1. These contract provisions shall apply to all work performed on the contract by the contractor with his own organization and with the assistance of workmen under his immediate superintendence and to all work performed on the contract by piecework, station work or by subcontract. The contractor's organization shall be construed to include only workmen employed and paid directly by the contractor and equipment owned or rented by him, with or without operators.

2. The contractor shall insert in each of his subcontracts all of the stipulations contained in these Required Provisions and such other stipulations as may be required.

3. A breach of any of the stipulations contained in these Required Provisions may be grounds for termination of the contract.

3. If the contractor is in control of apprenticeship or other training or retraining, including on-the-job training programs, he shall not discriminate against an individual because of his race, color, religion, national origin, sex, disability or age forty (40) and over, in admission to, or employment in any program established to provide apprenticeship or other training.

4. The contractor will send to each labor union or representative of workers with which he has a collective bargaining agreement or other contract or understanding, a notice to be provided advising the said labor union or workers' representative of the contractor's commitments under this section, and shall post copies of the notice in conspicuous places available to employees and applicants for employment. The contractor will take such action with respect to any subcontract or purchase order as the administrating agency may direct as a means of enforcing such provisions, including sanctions for non-compliance.

Revised: January 25, 2017

II. NONDISCRIMINATION OF EMPLOYEES

**AN ACT OF THE KENTUCKY
GENERAL ASSEMBLY TO PREVENT
DISCRIMINATION IN EMPLOYMENT
KRS CHAPTER 344
EFFECTIVE JUNE 16, 1972**

The contract on this project, in accordance with KRS Chapter 344, provides that during the performance of this contract, the contractor agrees as follows:

1. The contractor shall not fail or refuse to hire, or shall not discharge any individual, or otherwise discriminate against an individual with respect to his compensation, terms, conditions, or privileges of employment, because of such individual's race, color, religion, national origin, sex, disability or age (forty and above); or limit, segregate, or classify his employees in any way which would deprive or tend to deprive an individual of employment opportunities or otherwise adversely affect his status as an employee, because of such individual's race, color, religion, national origin, sex, disability or age forty (40) and over. The contractor agrees to post in conspicuous places, available to employees and applicants for employment, notices to be provided setting forth the provisions of this nondiscrimination clause.

2. The contractor shall not print or publish or cause to be printed or published a notice or advertisement relating to employment by such an employer or membership in or any classification or referral for employment by the employment agency, indicating any preference, limitation, specification, or discrimination, based on race, color, religion, national origin, sex, or age forty (40) and over, or because the person is a qualified individual with a disability, except that such a notice or advertisement may indicate a preference, limitation, or specification based on religion, national origin, sex, or age forty (40) and over, or because the person is a qualified individual with a disability, when religion, national origin, sex, or age forty (40) and over, or because the person is a qualified individual with a disability, is a bona fide occupational qualification for employment.

EXECUTIVE BRANCH CODE OF ETHICS

In the 1992 regular legislative session, the General Assembly passed and Governor Brereton Jones signed Senate Bill 63 (codified as KRS 11A), the Executive Branch Code of Ethics, which states, in part:

KRS 11A.040 (7) provides:

No present or former public servant shall, within six (6) months following termination of his office or employment, accept employment, compensation, or other economic benefit from any person or business that contracts or does business with, or is regulated by, the state in matters in which he was directly involved during the last thirty-six (36) months of his tenure. This provision shall not prohibit an individual from returning to the same business, firm, occupation, or profession in which he was involved prior to taking office or beginning his term of employment, or for which he received, prior to his state employment, a professional degree or license, provided that, for a period of six (6) months, he personally refrains from working on any matter in which he was directly involved during the last thirty-six (36) months of his tenure in state government. This subsection shall not prohibit the performance of ministerial functions, including but not limited to filing tax returns, filing applications for permits or licenses, or filing incorporation papers, nor shall it prohibit the former officer or public servant from receiving public funds disbursed through entitlement programs.

KRS 11A.040 (9) states:

A former public servant shall not represent a person or business before a state agency in a matter in which the former public servant was directly involved during the last thirty-six (36) months of his tenure, for a period of one (1) year after the latter of:

- a) The date of leaving office or termination of employment; or
- b) The date the term of office expires to which the public servant was elected.

This law is intended to promote public confidence in the integrity of state government and to declare as public policy the idea that state employees should view their work as a public trust and not as a way to obtain private benefits.

If you have worked for the executive branch of state government within the past six months, you may be subject to the law's prohibitions. The law's applicability may be different if you hold elected office or are contemplating representation of another before a state agency.

Also, if you are affiliated with a firm which does business with the state and which employs former state executive-branch employees, you should be aware that the law may apply to them.

In case of doubt, the law permits you to request an advisory opinion from the Executive Branch Ethics Commission, 3 Fountain Place, Frankfort, Kentucky 40601; telephone (502) 564-7954.

Revised: January 27, 2017

Kentucky Equal Employment Opportunity Act of 1978

The requirements of the Kentucky Equal Employment Opportunity Act of 1978 (KRS 45.560-45.640) shall apply to this Contract. The apparent low Bidder will be required to submit EEO forms to the Division of Construction Procurement, which will then forward to the Finance and Administration Cabinet for review and approval. No award will become effective until all forms are submitted and EEO/CC has certified compliance. The required EEO forms are as follows:

- EEO-1: Employer Information Report
- Affidavit of Intent to Comply
- Employee Data Sheet
- Subcontractor Report

These forms are available on the Finance and Administration's web page under ***Vendor Information, Standard Attachments and General Terms*** at the following address:
<https://www.eProcurement.ky.gov>.

Bidders currently certified as being in compliance by the Finance and Administration Cabinet may submit a copy of their approval letter in lieu of the referenced EEO forms.

For questions or assistance please contact the Finance and Administration Cabinet by email at **finance.contractcompliance@ky.gov** or by phone at 502-564-2874.

EMPLOYEE RIGHTS UNDER THE FAIR LABOR STANDARDS ACT

THE UNITED STATES DEPARTMENT OF LABOR WAGE AND HOUR DIVISION

FEDERAL MINIMUM WAGE

\$7.25

 PER HOUR

BEGINNING JULY 24, 2009

OVERTIME PAY

At least 1½ times your regular rate of pay for all hours worked over 40 in a workweek.

CHILD LABOR

An employee must be at least **16** years old to work in most non-farm jobs and at least **18** to work in non-farm jobs declared hazardous by the Secretary of Labor.

Youths **14** and **15** years old may work outside school hours in various non-manufacturing, non-mining, non-hazardous jobs under the following conditions:

No more than

- **3** hours on a school day or **18** hours in a school week;
- **8** hours on a non-school day or **40** hours in a non-school week.

Also, work may not begin before **7 a.m.** or end after **7 p.m.**, except from June 1 through Labor Day, when evening hours are extended to **9 p.m.** Different rules apply in agricultural employment.

Contract ID: 182044
Page 56 of 60

TIP CREDIT

Employers of “tipped employees” must pay a cash wage of at least \$2.13 per hour if they claim a tip credit against their minimum wage obligation. If an employee's tips combined with the employer's cash wage of at least \$2.13 per hour do not equal the minimum hourly wage, the employer must make up the difference. Certain other conditions must also be met.

ENFORCEMENT

The Department of Labor may recover back wages either administratively or through court action, for the employees that have been underpaid in violation of the law. Violations may result in civil or criminal action.

Employers may be assessed civil money penalties of up to \$1,100 for each willful or repeated violation of the minimum wage or overtime pay provisions of the law and up to \$11,000 for each employee who is the subject of a violation of the Act's child labor provisions. In addition, a civil money penalty of up to \$50,000 may be assessed for each child labor violation that causes the death or serious injury of any minor employee, and such assessments may be doubled, up to \$100,000, when the violations are determined to be willful or repeated. The law also prohibits discriminating against or discharging workers who file a complaint or participate in any proceeding under the Act.

ADDITIONAL INFORMATION

- Certain occupations and establishments are exempt from the minimum wage and/or overtime pay provisions.
- Special provisions apply to workers in American Samoa and the Commonwealth of the Northern Mariana Islands.
- Some state laws provide greater employee protections; employers must comply with both.
- The law requires employers to display this poster where employees can readily see it.
- Employees under 20 years of age may be paid \$4.25 per hour during their first 90 consecutive calendar days of employment with an employer.
- Certain full-time students, student learners, apprentices, and workers with disabilities may be paid less than the minimum wage under special certificates issued by the Department of Labor.

For additional information:



1-866-4-USWAGE

(1-866-487-9243)

TTY: 1-877-889-5627



WWW.WAGEHOUR.DOL.GOV

U.S. Department of Labor | Wage and Hour Division

PART IV
INSURANCE

INSURANCE

The Contractor shall procure and maintain the following insurance in addition to the insurance required by law:

- 1) Commercial General Liability-Occurrence form – not less than \$2,000,000 General aggregate, \$2,000,000 Products & Completed Aggregate, \$1,000,000 Personal & Advertising, \$1,000,000 each occurrence.
- 2) Automobile Liability- \$1,000,000 per accident
- 3) Employers Liability:
 - a) \$100,000 Each Accident Bodily Injury
 - b) \$500,000 Policy limit Bodily Injury by Disease
 - c) \$100,000 Each Employee Bodily Injury by Disease
- 4) The insurance required above must be evidenced by a Certificate of Insurance and this Certificate of Insurance must contain one of the following statements:
 - a) "policy contains no deductible clauses."
 - b) "policy contains _____ (amount) deductible property damage clause but company will pay claim and collect the deductible from the insured."
- 5) KENTUCKY WORKMEN'S COMPENSATION INSURANCE. The contractor shall furnish evidence of coverage of all his employees or give evidence of self-insurance by submitting a copy of a certificate issued by the Workmen's Compensation Board.

The cost of insurance is incidental to all contract items. All subcontractors must meet the same minimum insurance requirements.

PART V
BID ITEMS

PROPOSAL BID ITEMS

182044

Page 1 of 1

Report Date 12/28/17

Section: 0001 - MICROSURFACE

LINE	BID CODE	ALT	DESCRIPTION	QUANTITY	UNIT	UNIT PRIC	FP	AMOUNT
0010	24957EC		MICROSURFACING-SURFACE COURSE - TYPE B	99,822.00	SQYD		\$	

Section: 0002 - THINLAY

LINE	BID CODE	ALT	DESCRIPTION	QUANTITY	UNIT	UNIT PRIC	FP	AMOUNT
0020	02676		MOBILIZATION FOR MILL & TEXT	1.00	LS		\$	
0030	02677		ASPHALT PAVE MILLING & TEXTURING	98.00	TON		\$	
0040	23307EC		CL3 ASPH SURF NO.4B PG64-22	3,450.00	TON		\$	

Section: 0003 - ROADWAY

LINE	BID CODE	ALT	DESCRIPTION	QUANTITY	UNIT	UNIT PRIC	FP	AMOUNT
0050	02562		TEMPORARY SIGNS	250.00	SQFT		\$	
0060	02650		MAINTAIN & CONTROL TRAFFIC	1.00	LS		\$	
0070	02671		PORTABLE CHANGEABLE MESSAGE SIGN	4.00	EACH		\$	
0080	02775		ARROW PANEL	2.00	EACH		\$	
0090	06511		PAVE STRIPING-TEMP PAINT-6 IN	80,000.00	LF		\$	
0100	06515		PAVE STRIPING-PERM PAINT-6 IN	80,000.00	LF		\$	
0110	06568		PAVE MARKING-THERMO STOP BAR-24IN	270.00	LF		\$	
0120	06574		PAVE MARKING-THERMO CURV ARROW	63.00	EACH		\$	
0130	06575		PAVE MARKING-THERMO COMB ARROW	2.00	EACH		\$	
0140	06598		PAVEMENT MARKING REMOVAL	540.00	SQFT		\$	
0150	06600		REMOVE PAVEMENT MARKER TYPE V	821.00	EACH		\$	
0160	20205EC		PAVE MARK STOP BAR-24 IN PAINT	270.00	LF		\$	
0170	20208NC		PAVE MARK-PAINT ARROWS	40.00	EACH		\$	
0180	23875NC		REMOVE THERMOPLASTIC ARROWS	65.00	EACH		\$	
0190	24858EC		POLYMER ASPHALT EMULSION FOR SCRUB SEAL	119.00	TON		\$	
0200	24961EC		ASPHALT SEAL AGGREGATE - TYPE D (NO. 9M)	99,822.00	SQYD		\$	

Section: 0004 - DEMOBILIZATION

LINE	BID CODE	ALT	DESCRIPTION	QUANTITY	UNIT	UNIT PRIC	FP	AMOUNT
0210	02569		DEMOBILIZATION	1.00	LS		\$	