



CALL NO. 212

CONTRACT ID. 194117

VARIOUS COUNTIES

FED/STATE PROJECT NUMBER 121GR19T012-HSIP

DESCRIPTION THERMOPLASTIC STRIPING ON VARIOUS ROUTES IN DISTRICT 2
& 3

WORK TYPE THERMOPLASTIC PAVEMENT STRIPING

PRIMARY COMPLETION DATE 8/15/2020

LETTING DATE: July 26,2019

Sealed Bids will be received electronically through the Bid Express bidding service until 10:00 AM EASTERN DAYLIGHT TIME July 26,2019. Bids will be publicly announced at 10:00 AM EASTERN DAYLIGHT TIME.

NO PLANS ASSOCIATED WITH THIS PROJECT.

DBE CERTIFICATION REQUIRED - 0%

REQUIRED BID PROPOSAL GUARANTY: Not less than 5% of the total bid.

TABLE OF CONTENTS

PART I	SCOPE OF WORK
	<ul style="list-style-type: none">• PROJECT(S), COMPLETION DATE(S), & LIQUIDATED DAMAGES• CONTRACT NOTES• FEDERAL CONTRACT NOTES• NATIONAL HIGHWAY• SPECIAL NOTE(S) APPLICABLE TO PROJECT• LIQUIDATED DAMAGES• COORDINATION OF WORK WITH OTHER CONTRACTS• TRAFFIC CONTROL PLAN• RIGHT OF WAY NOTES• UTILITY IMPACT & RAIL CERTIFICATION NOTES• SKETCH MAP(S)• MATERIAL SUMMARY• SUMMARY SHEET(S)• DETAIL SHEET(S)
PART II	SPECIFICATIONS AND STANDARD DRAWINGS
	<ul style="list-style-type: none">• SPECIFICATIONS REFERENCE• SUPPLEMENTAL SPECIFICATION• 2016 STANDARD DRAWINGS THAT APPLY• TYPICAL MARKINGS FOR TURN LANES• TYPICAL MARKINGS AT SIGNALIZED INTERSECTIONS• TYPICAL MARKINGS FOR GORE AREAS• TYPICAL MARKINGS FOR ISLANDS AND MEDIANS
PART III	EMPLOYMENT, WAGE AND RECORD REQUIREMENTS
	<ul style="list-style-type: none">• FEDERAL-AID CONSTRUCTION CONTRACTS - FHWA 1273• NONDISCRIMINATION OF EMPLOYEES• EXECUTIVE BRANCH CODE OF ETHICS• PROJECT WAGE RATES LOCALITY 1 / FEDERAL• PROJECT WAGE RATES LOCALITY 2 / FEDERAL• NOTICE OF REQUIREMENT FOR AFFIRMATIVE ACTION TO ENSURE EEO ALLEN• NOTICE OF REQUIREMENT FOR AFFIRMATIVE ACTION TO ENSURE EEO BARREN• NOTICE OF REQUIREMENT FOR AFFIRMATIVE ACTION TO ENSURE EEO DAVIESS• NOTICE OF REQUIREMENT FOR AFFIRMATIVE ACTION TO ENSURE EEO LOGAN• NOTICE OF REQUIREMENT FOR AFFIRMATIVE ACTION TO ENSURE EEO MCLEAN• NOTICE OF REQUIREMENT FOR AFFIRMATIVE ACTION TO ENSURE EEO METCALFE• NOTICE OF REQUIREMENT FOR AFFIRMATIVE ACTION TO ENSURE EEO MUHLENBERG
PART IV	INSURANCE
PART V	BID ITEMS

PART I
SCOPE OF WORK

ADMINISTRATIVE DISTRICT - 03

CONTRACT ID - 194117

121GR19T012-HSIP

COUNTY - VARIOUS

PCN - 0212199991901

HSIP 9010 (392)

THERMOPLASTIC STRIPING ON VARIOUS ROUTES IN DISTRICT 2 THERMOPLASTIC STRIPING ON VARIOUS ROUTES IN DISTRICT 2 THERMOPLASTIC PAVEMENT STRIPING SYP NO. 02-00924.00.

GEOGRAPHIC COORDINATES LATITUDE 37:24:07.74 LONGITUDE -87:22:04.34

PCN - 0312199991901

HSIP 9010 (393)

THERMOPLASTIC STRIPING ON VARIOUS ROUTES IN DISTRICT 3 THERMOPLASTIC STRIPING ON VARIOUS ROUTES IN DISTRICT 3 THERMOPLASTIC PAVEMENT STRIPING SYP NO. 03-00931.00.

GEOGRAPHIC COORDINATES LATITUDE 36:54:46.26 LONGITUDE -86:20:11.31

COMPLETION DATE(S):

COMPLETED BY 10/15/2019

COMPLETED BY 08/15/2020

SEE SPECIAL NOTE FOR
COMPLETION DATES AND
LIQUIDATED DAMAGES

APPLIES TO ENTIRE PROJECT

CONTRACT NOTES

PROPOSAL ADDENDA

All addenda to this proposal must be applied when calculating bid and certified in the bid packet submitted to the Kentucky Department of Highways. Failure to use the correct and most recent addenda may result in the bid being rejected.

BID SUBMITTAL

Bidder must use the Department's electronic bidding software. The Bidder must download the bid file located on the Bid Express website (www.bidx.com) to prepare a bid packet for submission to the Department. The bidder must submit electronically using Bid Express.

JOINT VENTURE BIDDING

Joint venture bidding is permissible. All companies in the joint venture must be prequalified in one of the work types in the Qualifications for Bidders for the project. The bidders must get a vendor ID for the joint venture from the Division of Construction Procurement and register the joint venture as a bidder on the project. Also, the joint venture must obtain a digital ID from Bid Express to submit a bid. A joint bid bond of 5% may be submitted for both companies or each company may submit a separate bond of 5%.

UNDERGROUND FACILITY DAMAGE PROTECTION

The contractor shall make every effort to protect underground facilities from damage as prescribed in the Underground Facility Damage Protection Act of 1994, Kentucky Revised Statute KRS 367.4901 to 367.4917. It is the contractor's responsibility to determine and take steps necessary to be in compliance with federal and state damage prevention directives. When prescribed in said directives, the contractor shall submit Excavation Locate Requests to the Kentucky Contact Center (KY811) via web ticket entry. The submission of this request does not relieve the contractor from the responsibility of contacting non-member facility owners, whom shall be contacted through their individual Protection Notification Center. Non-compliance with these directives can result in the enforcement of penalties.

REGISTRATION WITH THE SECRETARY OF STATE BY A FOREIGN ENTITY

Pursuant to KRS 176.085(1)(b), an agency, department, office, or political subdivision of the Commonwealth of Kentucky shall not award a state contract to a person that is a foreign entity required by [KRS 14A.9-010](#) to obtain a certificate of authority to transact business in the Commonwealth ("certificate") from the Secretary of State under [KRS 14A.9-030](#) unless the person produces the certificate within fourteen (14) days of the bid or proposal opening. If the foreign entity is not required to obtain a certificate as provided in [KRS 14A.9-010](#), the foreign entity should identify the applicable exception. Foreign entity is defined within [KRS 14A.1-070](#).

For all foreign entities required to obtain a certificate of authority to transact business in the Commonwealth, if a copy of the certificate is not received by the contracting agency within the time frame identified above, the foreign entity's solicitation response shall be deemed non-responsive or the awarded contract shall be cancelled.

Businesses can register with the Secretary of State at <https://secure.kentucky.gov/sos/ftbr/welcome.aspx>.

SPECIAL NOTE FOR PROJECT QUESTIONS DURING ADVERTISEMENT

Questions about projects during the advertisement should be submitted in writing to the Division of Construction Procurement. This may be done by fax (502) 564-7299 or email to kytc.projectquestions@ky.gov. The Department will attempt to answer all submitted questions. The Department reserves the right not to answer if the question is not pertinent or does not aid in clarifying the project intent.

The deadline for posting answers will be 3:00 pm Eastern Daylight Time, the day preceding the Letting. Questions may be submitted until this deadline with the understanding that the later a question is submitted, the less likely an answer will be able to be provided.

The questions and answers will be posted for each Letting under the heading "Questions & Answers" on the Construction Procurement website (www.transportation.ky.gov/contract). The answers provided shall be considered part of this Special Note and, in case of a discrepancy, will govern over all other bidding documents.

HARDWOOD REMOVAL RESTRICTIONS

The US Department of Agriculture has imposed a quarantine in Kentucky and several surrounding states, to prevent the spread of an invasive insect, the emerald ash borer. Hardwood cut in conjunction with the project may not be removed from the state. Chipping or burning on site is the preferred method of disposal.

INSTRUCTIONS FOR EXCESS MATERIAL SITES AND BORROW SITES

Identification of excess material sites and borrow sites shall be the responsibility of the Contractor. The Contractor shall be responsible for compliance with all applicable state and federal laws and may wish to consult with the US Fish and Wildlife Service to seek protection under Section 10 of the Endangered Species Act for these activities.

ACCESS TO RECORDS

The contractor, as defined in KRS 45A.030 (9) agrees that the contracting agency, the Finance and Administration Cabinet, the Auditor of Public Accounts, and the Legislative Research Commission, or their duly authorized representatives, shall have access to any books, documents, papers, records, or other evidence, which are directly pertinent to this contract for the purpose of financial audit or program review. Records and other prequalification information confidentially

disclosed as part of the bid process shall not be deemed as directly pertinent to the contract and shall be exempt from disclosure as provided in KRS 61.878(1)(c). The contractor also recognizes that any books, documents, papers, records, or other evidence, received during a financial audit or program review shall be subject to the Kentucky Open Records Act, KRS 61.870 to 61.884.

In the event of a dispute between the contractor and the contracting agency, Attorney General, or the Auditor of Public Accounts over documents that are eligible for production and review, the Finance and Administration Cabinet shall review the dispute and issue a determination, in accordance with Secretary's Order 11-004.

April 30, 2018

FEDERAL CONTRACT NOTES

The Kentucky Department of Highways, in accordance with the Regulations of the United States Department of Transportation 23 CFR 635.112 (h), hereby notifies all bidders that failure by a bidder to comply with all applicable sections of the current Kentucky Standard Specifications, including, but not limited to the following, may result in a bid not being considered responsive and thus not eligible to be considered for award:

102.02 Current Capacity Rating 102.10 Delivery of Proposals
102.8 Irregular Proposals 102.14 Disqualification of Bidders
102.9 Proposal Guaranty

CIVIL RIGHTS ACT OF 1964

The Kentucky Department of Highways, in accordance with the provisions of Title VI of the Civil Rights Act of 1964 (78 Stat. 252) and the Regulations of the Federal Department of Transportation (49 C.F.R., Part 21), issued pursuant to such Act, hereby notifies all bidders that it will affirmatively insure that the contract entered into pursuant to this advertisement will be awarded to the lowest responsible bidder without discrimination on the ground of race, color, or national origin.

NOTICE TO ALL BIDDERS

To report bid rigging activities call: 1-800-424-9071.

The U.S. Department of Transportation (DOT) operates the above toll-free "hotline" Monday through Friday, 8:00 a.m. to 5:00 p.m. eastern time. Anyone with knowledge of possible bid rigging, bidder collusion, or other fraudulent activities should use the "hotline" to report such activities.

The "hotline" is part of the DOT's continuing effort to identify and investigate highway construction contract fraud and abuse and is operated under the direction of the DOT Inspector General. All information will be treated confidentially and caller anonymity will be respected.

SECOND TIER SUBCONTRACTS

Second Tier subcontracts on federally assisted projects shall be permitted. However, in the case of DBE's, second tier subcontracts will only be permitted where the other subcontractor is also a DBE. All second tier subcontracts shall have the consent of both the Contractor and the Engineer.

DISADVANTAGED BUSINESS ENTERPRISE PROGRAM

It is the policy of the Kentucky Transportation Cabinet (“the Cabinet”) that Disadvantaged Business Enterprises (“DBE”) shall have the opportunity to participate in the performance of highway construction projects financed in whole or in part by Federal Funds in order to create a level playing field for all businesses who wish to contract with the Cabinet. To that end, the Cabinet will comply with the regulations found in 49 CFR Part 26, and the definitions and requirements contained therein shall be adopted as if set out verbatim herein.

The Cabinet, contractors, subcontractors, and sub-recipients shall not discriminate on the basis of race, color, national origin, or sex in the performance of work performed pursuant to Cabinet contracts. The contractor shall carry out applicable requirements of 49 CFR 26 in the award and administration of federally assisted highway construction projects. The contractor will include this provision in all its subcontracts and supply agreements pertaining to contracts with the Cabinet.

Failure by the contractor to carry out these requirements is a material breach of its contract with the Cabinet, which may result in the termination of the contract or such other remedy as the Cabinet deems necessary.

DBE GOAL

The Disadvantaged Business Enterprise (DBE) goal established for this contract, as listed on the front page of the proposal, is the percentage of the total value of the contract.

The contractor shall exercise all necessary and reasonable steps to ensure that Disadvantaged Business Enterprises participate in a least the percent of the contract as set forth above as goals for this contract.

OBLIGATION OF CONTRACTORS

Each contractor prequalified to perform work on Cabinet projects shall designate and make known to the Cabinet a liaison officer who is assigned the responsibility of effectively administering and promoting an active program for utilization of DBEs.

If a formal goal has not been designated for the contract, all contractors are encouraged to consider DBEs for subcontract work as well as for the supply of material and services needed to perform this work.

Contractors are encouraged to use the services of banks owned and controlled by minorities and women.

CERTIFICATION OF CONTRACT GOAL

Contractors shall include the following certification in bids for projects for which a DBE goal has been established. BIDS SUBMITTED WHICH DO NOT INCLUDE CERTIFICATION OF DBE PARTICIPATION WILL NOT BE ACCEPTED. These bids will not be considered for award by the Cabinet and they will be returned to the bidder.

“The bidder certifies that it has secured participation by Disadvantaged Business Enterprises (“DBE”) in the amount of ____ percent of the total value of this contract and that the DBE participation is in compliance with the requirements of 49 CFR 26 and the policies of the Kentucky Transportation Cabinet pertaining to the DBE Program.”

The certification statement is located in the electronic bid file. All contractors must certify their DBE participation on that page. DBEs utilized in achieving the DBE goal must be certified and prequalified for the work items at the time the bid is submitted.

DBE PARTICIPATION PLAN

Lowest responsive bidders must submit the *DBE Plan/ Subcontractor Request*, form TC 14-35 DBE, within **5** days of the letting. This is necessary before the Awards Committee will review and make a recommendation. **The project will not be considered for award prior to submission and approval of the apparent low bidder’s DBE Plan/Subcontractor Request.**

The DBE Participation Plan shall include the following:

- 1 Name and address of DBE Subcontractor(s) and/or supplier(s) intended to be used in the proposed project;
- 2 Description of the work each is to perform including the work item , unit, quantity, unit price and total amount of the work to be performed by the individual DBE. The Project Code Number (PCN), Category Number, and the Project Line Number can be found in the “material listing” on the Construction Procurement website under the specific letting;
- 3 The dollar value of each proposed DBE subcontract and the percentage of total project contract value this represents. DBE participation may be counted as follows; a) If DBE suppliers and manufactures assume actual and contractual responsibility, the dollar value of materials to be furnished will be counted toward the goal as follows:
 - The entire expenditure paid to a DBE manufacturer;
 - 60 percent of expenditures to DBE suppliers that are not manufacturers provided the supplier is a regular dealer in the product involved. A regular dealer must be engaged in, as its principal business and in its own name, the sale of products to the public, maintain an inventory and own and operate distribution equipment; and
 - The amount of fees or commissions charged by the DBE firms for a bona fide service, such as professional, technical, consultant, or managerial services and assistance in the procurement of essential personnel, facilities, equipment, materials, supplies, delivery of materials and supplies or for furnishing bonds, or insurance, providing such fees or commissions are determined to be reasonable and customary.

- b) The dollar value of services provided by DBEs such as quality control testing, equipment repair and maintenance, engineering, staking, etc.;
 - c) The dollar value of joint ventures. DBE credit for joint ventures will be limited to the dollar amount of the work actually performed by the DBE in the joint venture;
- 4 Written and signed documentation of the bidder's commitment to use a DBE contractor whose participation is being utilized to meet the DBE goal; and
- 5 Written and signed confirmation from the DBE that it is participating in the contract as provided in the prime contractor's commitment.

UPON AWARD AND BEFORE A WORK ORDER WILL BE ISSUED

Contractors must submit the signed subcontract between the contractor and the DBE contractor, the DBE's certificate of insurance, and an affidavit for bidders, offerors, and contractors from the DBE to the Division of Construction Procurement. The affidavit can be found on the Construction Procurement website. If the DBE is a supplier of materials for the project, a signed purchase order and an affidavit for bidders, offerors, and contractors must be submitted to the Division of Construction Procurement.

Changes to DBE Participation Plans must be approved by the Cabinet. The Cabinet may consider extenuating circumstances including, but not limited to, changes in the nature or scope of the project, the inability or unwillingness of a DBE to perform the work in accordance with the bid, and/or other circumstances beyond the control of the prime contractor.

CONSIDERATION OF GOOD FAITH EFFORTS REQUESTS

If the DBE participation submitted in the bid by the apparent lowest responsive bidder does not meet or exceed the DBE contract goal, the apparent lowest responsive bidder must submit a Good Faith Effort Package to satisfy the Cabinet that sufficient good faith efforts were made to meet the contract goals prior to submission of the bid. Efforts to increase the goal after bid submission will not be considered in justifying the good faith effort, unless the contractor can show that the proposed DBE was solicited prior to the letting date. DBEs utilized in achieving the DBE goal must be certified and prequalified for the work items at the time the bid is submitted. One complete set and nine (9) copies of this information must be received in the office of the Division of Contract Procurement no later than 12:00 noon of the tenth calendar day after receipt of notification that they are the apparent low bidder.

Where the information submitted includes repetitious solicitation letters it will be acceptable to submit a sample representative letter along with a distribution list of the firms solicited. Documentation of DBE quotations shall be a part of the good faith effort submittal as necessary to demonstrate compliance with the factors listed below which the Cabinet considers in judging good faith efforts. This documentation may include written subcontractors' quotations, telephone log notations of verbal quotations, or other types of quotation documentation.

The Good Faith Effort Package shall include, but may not be limited to information showing evidence of the following:

- 1 Whether the bidder attended any pre-bid meetings that were scheduled by the Cabinet to inform DBEs of subcontracting opportunities;
- 2 Whether the bidder provided solicitations through all reasonable and available means;
- 3 Whether the bidder provided written notice to all DBEs listed in the DBE directory at the time of the letting who are prequalified in the areas of work that the bidder will be subcontracting;
- 4 Whether the bidder followed up initial solicitations of interest by contacting DBEs to determine with certainty whether they were interested. If a reasonable amount of DBEs within the targeted districts do not provide an intent to quote or no DBEs are prequalified in the subcontracted areas, the bidder must notify the DBE Liaison in the Office of Minority Affairs to give notification of the bidder's inability to get DBE quotes;
- 5 Whether the bidder selected portions of the work to be performed by DBEs in order to increase the likelihood of meeting the contract goals. This includes, where appropriate, breaking out contract work items into economically feasible units to facilitate DBE participation, even when the prime contractor might otherwise perform these work items with its own forces;
- 6 Whether the bidder provided interested DBEs with adequate and timely information about the plans, specifications, and requirements of the contract;
- 7 Whether the bidder negotiated in good faith with interested DBEs not rejecting them as unqualified without sound reasons based on a thorough investigation of their capabilities. Any rejection should be so noted in writing with a description as to why an agreement could not be reached;
- 8 Whether quotations were received from interested DBE firms but were rejected as unacceptable without sound reasons why the quotations were considered unacceptable. The fact that the DBE firm's quotation for the work is not the lowest quotation received will not in itself be considered as a sound reason for rejecting the quotation as unacceptable. The fact that the bidder has the ability and/or desire to perform the contract work with its own forces will not be considered a sound reason for rejecting a DBE quote. Nothing in this provision shall be construed to require the bidder to accept unreasonable quotes in order to satisfy DBE goals;
- 9 Whether the bidder specifically negotiated with subcontractors to assume part of the responsibility to meet the contract DBE goal when the work to be subcontracted includes potential DBE participation;
- 10 Whether the bidder made any efforts and/or offered assistance to interested DBEs in obtaining the necessary equipment, supplies, materials, insurance and/or bonding to satisfy the work requirements of the bid proposal; and
- 11 Any other evidence that the bidder submits which may show that the bidder has made reasonable good faith efforts to include DBE participation.

FAILURE TO MEET GOOD FAITH REQUIREMENT

Where the apparent lowest responsive bidder fails to submit sufficient participation by DBE firms to meet the contract goal and upon a determination by the Good Faith Committee based upon the information submitted that the apparent lowest responsive bidder failed to make sufficient reasonable efforts to meet the contract goal, the bidder will be offered the opportunity to meet in person for administrative reconsideration. The bidder will be notified of the Committee's decision within 24 hours of its decision. The bidder will have 24 hours to request reconsideration of the Committee's decision. The reconsideration meeting will be held within two days of the receipt of a request by the bidder for reconsideration.

The request for reconsideration will be heard by the Office of the Secretary. The bidder will have the opportunity to present written documentation or argument concerning the issue of whether it met the goal or made an adequate good faith effort. The bidder will receive a written decision on the reconsideration explaining the basis for the finding that the bidder did or did not meet the goal or made adequate Good Faith efforts to do so.

The result of the reconsideration process is not administratively appealable to the Cabinet or to the United States Department of Transportation.

The Cabinet reserves the right to award the contract to the next lowest responsive bidder or to rebid the contract in the event that the contract is not awarded to the low bidder as the result of a failure to meet the good faith requirement.

SANCTIONS FOR FAILURE TO MEET DBE REQUIREMENTS OF THE PROJECT

Failure by the prime contractor to fulfill the DBE requirements of a project under contract or to demonstrate good faith efforts to meet the goal constitutes a breach of contract. When this occurs, the Cabinet will hold the prime contractor accountable, as would be the case with all other contract provisions. Therefore, the contractor's failure to carry out the DBE contract requirements shall constitute a breach of contract and as such the Cabinet reserves the right to exercise all administrative remedies at its disposal including, but not limited to the following:

- Disallow credit toward the DBE goal;
- Withholding progress payments;
- Withholding payment to the prime in an amount equal to the unmet portion of the contract goal; and/or
- Termination of the contract.

PROMPT PAYMENT

The prime contractor will be required to pay the DBE within seven (7) working days after he or she has received payment from the Kentucky Transportation Cabinet for work performed or materials furnished.

CONTRACTOR REPORTING

All contractors must keep detailed records and provide reports to the Cabinet on their progress in meeting the DBE requirement on any highway contract. These records may include, but shall not be limited to payroll, lease agreements, cancelled payroll checks, executed subcontracting agreements, etc. Prime contractors will be required to complete and submit a signed and notarized affidavit (TC 18-7) and copies of checks for any monies paid to each DBE subcontractor or supplier utilized to meet a DBE goal. **These documents must be submitted within 10 days of being paid by the Cabinet.**

Payment information that needs to be reported includes date the payment is sent to the DBE, check number, Contract ID, amount of payment and the check date. Before Final Payment is made on this contract, the Prime Contractor will certify that all payments were made to the DBE subcontractor and/or DBE suppliers.

The Prime Contractor should supply the payment information at the time the DBE is compensated for their work. Form to use is located at:

<http://transportation.ky.gov/Construction/Pages/Subcontracts.aspx>

The prime contractor should notify the KYTC Office of Civil Rights and Small Business Development seven (7) days prior to DBE contractors commencing work on the project. The contact is Melvin Bynes and the telephone number is (502) 564-3601.

Photocopied payments and completed, signed and notarized affidavit must be submitted by the Prime Contractor to: Office of Civil Rights and Small Business Development
6th Floor West 200 Mero Street
Frankfort, KY 40622

DEFAULT OR DECERTIFICATION OF THE DBE

If the DBE subcontractor or supplier is decertified or defaults in the performance of its work, and the overall goal cannot be credited for the uncompleted work, the prime contractor may utilize a substitute DBE or elect to fulfill the DBE goal with another DBE on a different work item. If after exerting good faith effort in accordance with the Cabinet's Good Faith Effort policies and procedures, the prime contractor is unable to replace the DBE, then the unmet portion of the goal may be waived at the discretion of the Cabinet.

1/27/2017

LEGAL REQUIREMENTS AND RESPONSIBILITY TO THE PUBLIC – CARGO PREFERENCE ACT (CPA).

(REV 12-17-15) (1-16)

SECTION 7 is expanded by the following new Article:

102.10 **Cargo Preference Act – Use of United States-flag vessels.**

Pursuant to Title 46CFR Part 381, the Contractor agrees

- To utilize privately owned United States-flag commercial vessels to ship at least 50 percent of the gross tonnage (computed separately for dry bulk carriers, dry cargo liners, and tankers) involved, whenever shipping any equipment, material, or commodities pursuant to this contract, to the extent such vessels are available at fair and reasonable rates for United States-flag commercial vessels.

- To furnish within 20 days following the date of loading for shipments originating within the United States or within 30 working days following the date of loading for shipments originating outside the United States, a legible copy of a rated, 'on-board' commercial ocean bill-of-lading in English for each shipment of cargo described in paragraph 1 of this section to both the Contracting Officer (through the prime contractor in the case of subcontractor bills-of-lading) and to the Division of National Cargo, Office of Market Development, Maritime Administration, Washington, DC 20590.

- To insert the substance of the provisions of this clause in all subcontracts issued pursuant to this contract.

NATIONAL HIGHWAY

Be advised this project is on the NATIONAL HIGHWAY SYSTEM.

Special Notes for 6" Striping on Various Routes in Districts 2 and 3

CAUTION

The information in this proposal and the type of work listed herein are approximate only and are not to be taken as an exact evaluation of the materials and conditions to be encountered during construction; the bidder must draw his/her own conclusions when developing the Unit Bid Prices for each bid item. As such, if the conditions encountered are not in accordance with the information shown, the Department does not guarantee any changes to the Unit Bid Prices nor extension of the contract will be considered. The Department will pay for bid item quantity overruns, but only if pre-approved by the Engineer.

CONTROL

Perform all work under the absolute control of the Department of Highways. Obtain the Engineer's approval of all designs required to be furnished by the Contractor prior to incorporation into the work. The Department reserves the right to have other work performed by other contractors and its own forces and to permit public utility companies and others to do work during the construction within the limits of, or adjacent to, the project. Conduct operations and cooperate with such other parties so that interference with such other work will be reduced to a minimum. The Department will not honor any claims for money or time extension created by the operations of such other parties. Should a difference of opinion arise as to the rights of the Contractor and others working within the limits of, or adjacent to, the project, the Engineer will decide as to the respective rights of the various parties involved in order to assure the completion of the Department's work in general harmony and in a satisfactory manner, and his/her decision shall be final and binding upon the Contractor.

SCOPE OF WORK

Furnish and apply 6" thermoplastic striping on asphalt pavement and Durable Type 1 tape for 6 inch lines on concrete surfaces to the sections of roadway provided in this Contract. This Contract is for the installation of centerlines, lane lines, edgelines, ramp lines, dotted lines and gore markings only. Special markings such as stop bars, crosswalks, cross-hatching, railroad markings, etc. are not to be installed under this Contract.

Markings that would require application by equipment other than the striping truck are not to be installed under this Contract.

Retrace existing lines on the listed routes. The Department will pre-mark any section of roadway where there are no existing markings, old markings are no longer visible, or where the existing markings are to be changed. Do not place edge lines on any section of roadway where edgelines do not currently exist.

DESCRIPTION OF WORK

Except as specified herein, perform all work in accordance with the Department's Standard Specifications, Supplemental Specifications, applicable Special Notes and Special Provisions, and applicable Standard and Sepia Drawings, current editions. Furnish all materials, labor, equipment, and incidentals for the following work:

Installation of Spray Applied Thermoplastic 6". Install according to Special Note for Spray Applied Thermoplastic Pavement Marking Materials and according to Section 714 of the Standard Specifications. Contrary to section 714, existing stripe on asphalt will not be removed prior to installation of spray thermoplastic stripe.

General Notes & Description of Work

Page 2 of 3

Installation of Durable Type 1 Tape 6". Install according to manufacturer's instructions and Section 714 of the Standard Specifications. The quantities estimated for this project are to be used on **concrete surfaces only**. Waterblast existing stripe before installation of Type 1 tape, this work is incidental to the bid item 6556 PAVE STRIPING-DUR TY 1-6 IN W and 6557 PAVE STRIPING-DUR TY 1-6 IN Y.

Priority Routes. The following priority routes shall be striped by October 15, 2019.

- Logan US 68

Application of Striping

Furnish and apply 6" thermoplastic striping on asphalt pavement and Durable Type 1 tape for 6 inch lines on concrete surfaces to the sections of roadway provided in this Contract. This Contract is for the installation of centerlines, lane lines, edgelines, ramp lines, dotted lines and gore markings only. Special markings such as stop bars, crosswalks, cross-hatching, railroad markings, etc. are not to be installed under this Contract.

Markings that would require application by equipment other than the striping truck are not to be installed under this Contract.

Retrace existing lines on the listed routes. The Department will pre-mark any section of roadway where there are no existing markings, old markings are no longer visible, or where the existing markings are to be changed. Do not place edge lines on any section of roadway where edgelines do not currently exist.

The six-inch line shall be not less than six inches nor more than seven inches in width. The centerline of all newly applied lines shall be within one inch of the centerline of the existing stripe. All lines shall have distinct, clean edges with proper bead distribution across the entire width and length of the line.

Passing zones and lane lines shall be installed as a 10' segment of paint with a 30' gap. The length of the 10' segment shall not be less than 10' nor longer than 10 feet 6 inches. The stripe-gap cycle shall be not less than 39 feet 6 inches and no longer than 40 feet 6 inches.

The Contractor shall be responsible for protecting the painted line from traffic until dry in order to eliminate tracking. Retroreflectivity readings will be taken on zones with substantial amounts of tracking and the readings will be used in the calculation of payment. If the Contractor elects to use additional traffic control devices beyond what is specified in the TRAFFIC CONTROL PLAN, the additional cost shall be incidental to the bid item "Maintain and Control Traffic".

If the Engineer determines that the quality of the striping applied by the Contractor is unsatisfactory with regard to retroreflectivity, bead distribution, paint thickness, overspray, accuracy of retracing, line width, consistency, tracking, etc., the Engineer may stop the striping operation immediately until the Contractor can demonstrate that the problem has been corrected. If it is determined by the Engineer that the striping is not applied at the specified application rate, restriping will be required

General Notes & Description of Work
Page 3 of 3

MARKING REMOVAL

The Contractor shall be responsible for all necessary cleanup of any paint or other material that is spilled onto the pavement or elsewhere as a result of his operations and for correcting any striping error (including tracking and rain damage) that the Engineer determines removal to be required. Upon notification of a striping error or paint spill by the Engineer, the Contractor shall be required to begin the process of correcting the striping error or paint spill within five (5) working days and shall work continuously to complete the corrective work prior to striping any other section of roadway included in this Contract.

PAINT ON VEHICLES

The Contractor shall be responsible for addressing disputes with the public regarding paint on vehicles that occur as a result of his/her operations. All complaints from the public shall be addressed in a timely manner and the Contractor must demonstrate a "good faith" attempt to resolve disputes to the satisfaction of the citizen. However, the Contractor shall have the right to dispute fault and refuse settlement in cases where the Contractor feels that paint on the vehicle was a result of negligence on the part of the citizen. Unresolved disputes involving paint on vehicles shall be handled through the legal system. The Department shall not be held responsible for paint on vehicles under any circumstances.

SPECIAL NOTE FOR SPRAY APPLIED THERMOPLASTIC PAVEMENT MARKING MATERIALS

I. DESCRIPTION

Except as provided herein, all work shall be performed in accordance with the Department’s Standard Specifications, Interim Supplemental Specifications, applicable Standard and Sepia Drawings, applicable Special Provisions and Special Notes, current editions. Article references are to the Standard Specifications. This project shall consist of furnishing all labor, equipment, materials and incidentals for the following:

- (1) Spray applied thermoplastic pavement marking materials with reflectorized glass beads for permanent applications

II. MATERIALS

- A. **DROP ON BEADS.** Use beads that will ensure the pavement marking material will meet retroreflectivity requirements. The Department will evaluate the beads as part of the marking system through retroreflectivity readings.
- B. **APPROVAL.** Select materials that conform to the composition and physical characteristic requirements below when evaluated in accordance with AASHTO T-250 or other test methods as cited. The Department will sample and evaluate for approval each lot of thermoplastic material delivered for use per contract prior to installation of the thermoplastic material. Do not allow the installation of thermoplastic material until it has been approved by the Division of Materials. Allow the Department a minimum of 10 working days to evaluate and approve thermoplastic material from the date sampled.
- C. **Composition.** Use a maleic-modified glycerol ester resin (alkyd binder) to formulate the thermoplastic material. Ensure the pigment, pre-mix beads, and filler are uniformly dispersed in the resin. Use material that is free from all dirt and foreign material. Provide independent analysis data and certification for each formulation stating the total concentration of each heavy metal present, the test method used for each determination, and compliance to 40 CFR 261 for leachable heavy metals content.

COMPOSITION (Percentage by Weight)		
Component	White	Yellow
Binder, ⁽¹⁾	26.0 min.	26.0 min.
Glass Beads (Premixed)	30 - 40	30 - 40
Titanium Dioxide (Rutile, Type II)	10.0 min.	—
Calcium Carbonate & Inert Fillers ⁽²⁾	42.0 max.	50.0 max.
Heavy Metals Content	Comply with 40 CFR 261	Comply with 40 CFR 261

⁽¹⁾Use a binder that consists of a mixture of synthetic resins, at least one being solid at room temperature, and high boiling point plasticizers. Ensure that at least one-third of the binder composition is solid maleic-modified glycerol ester resin and is not less than 8 percent by weight of the entire material formulation. Do not use alkyd binder that contains petroleum based hydrocarbon resins.

⁽²⁾The manufacturer may choose the amount of calcium carbonate and inert fillers, providing all other requirements of this section are met.

Spray Applied Thermoplastic
Page 2 of 3

D. Physical Characteristics. For thermoplastic material heated for 4 hours at 425°F under agitation, conform to the following requirements.

a) **Color.** As determined with a spectrophotometer using D65 illuminant with a 45 degree entrance angle and 0 degree observation angle geometry.

CIELAB Color Coordinates		
	Yellow	White
Daytime Color (CIELAB) Spectrophotometer using illuminant D65 at 45° illumination and 0° viewing with a 2° observer	L* 81.76 a* 19.79 b* 89.89 Maximum allowable variation 6.0ΔE*	L* 93.51 a* -1.01 b* 0.70 Maximum allowable variation 6.0ΔE*
Nighttime Color (CIELAB) Spectrophotometer using illuminant A at 45° illumination and 0° viewing with a 2° observer	L* 86.90 a* 24.80 b* 95.45 Maximum allowable variation 6.0ΔE*	L* 93.45 a* -0.79 b* 0.43 Maximum allowable variation 6.0ΔE*

b) **Set Time.** Use material that, when applied at a temperature range of 375 ± 25 °F and thickness of 60 ± 10 mils, sets to bear traffic in not more than 2 minutes when the air and road surface temperature is approximately ≥ 50 ± 3 °F, and not more than 10 minutes when the air and road surface temperature is approximately < 50 ± 3 °F.

c) **Softening Point.** Ensure that the thermoplastic material has a softening point of 180 ± 15 °F.

d) **Bond Strength.** Ensure that the bond strength of the thermoplastic material to concrete exceeds 180 psi.

e) **Cracking Resistance at Low Temperature.** Ensure that the thermoplastic material shows no cracks when observed from a distance exceeding one foot.

f) **Impact Resistance.** Ensure the impact resistance of the thermoplastic material is a minimum of 50 inch-pounds.

g) **Flash Point.** Use thermoplastic material that has a flash point not less than 475 °F.

E. PACKAGING. Package thermoplastic material in suitable 50 pound containers to which the material shall not adhere during shipment or storage. Include a label stating that the thermoplastic material is to be maintained with a temperature range of 350 – 400°F during application. Provide the thermoplastic material in granular form.

F. SHELF LIFE. Ensure that the thermoplastic material conforms to this section for a period of one year. Replace any thermoplastic material not conforming to the above requirements.

G. MANUFACTURER’S TESTING. Perform testing in accordance with AASHTO T-250 on a minimum of one composite sample per 10,000 pounds, or portion thereof, per lot of thermoplastic produced.

H. CERTIFICATION. Submit manufacturer’s certification stating conformance to the requirements of this section for each lot of extruded thermoplastic delivered for use on projects. Clearly state the manufacture, formulation identification, product name, color, date of manufacturer, total quantity of lot produced, actual quantity of thermoplastic material represented, sampling method utilized to obtain the samples, and required manufacturer’s testing data for each composite sample tested to represent each lot produced.

III. CONSTRUCTION METHODS

- A. **SURFACE PREPARATION.** Contrary to Section 714.03.02 the removal of existing pavement markings will not be required for installation of thermoplastic markings. The contractor will be required to sweep all pavement surfaces prior to striping and maintain the cleaning operation far enough in advance of the striping operation to prevent any dust from the cleaning operation from mixing with the paint. The sweeper must maintain contact with the roadway. When the Engineer determines abnormal amounts of debris or other material have accumulated beyond the capability of the required sweeping unit which will require shoveling or other means to remove, the Engineer will make arrangements, prior to painting, to have the material removed by the Department.
- B. **INSTALLATION.** Install thermoplastic materials in accordance with Section 714, Durable Pavement Striping, and the following exceptions:
 - Install the thermoplastic materials at a minimum thickness of 60 mils.
 - Ensure the material temperature is maintained between 350 and 400°F.
 - Do not allow the material temperature to exceed 400°F.
 - Removal of existing stripe on asphalt surfaces is not required.
- C. **RETROREFLECTIVITY.** The Department will evaluate installed markings in accordance with Section 714.03.06, Proving Period for Durable Markings.

IV. METHOD OF MEASUREMENT

- A. **ACCEPTANCE AND PAYMENT.** The Department will accept spray applied thermoplastic materials based on compliance of the manufacturer’s certification and conformance of test results obtained by the Department to the requirements of this special note.

Contrary to Section 714.03.08, Acceptance of Non-Specification Thermoplastic Markings, the Department will not accept non-specification compliant markings. Remove non-specification compliant markings by water blasting. The Department will perform random thickness tests on applied markings to determine compliance to thickness requirements

IV. BASIS OF PAYMENT

The Department will make payment for the completed and accepted quantities under the following:

<u>Code</u>	<u>Pay Item</u>	<u>Pay Unit</u>
24995EC	PAVE STRIPING-SPRAY THERMO-6 IN W	LF
24996EC	PAVE STRIPING-SPRAY THERMO-6 IN Y	LF

The Department will consider payment as full compensation for furnishing all labor, materials, equipment, and incidentals required to construct spray applied thermoplastic pavement markings.

CONTRACT COMPLETION AND LIQUIDATED DAMAGES

All routes that are required to be striped under this Contract shall be completed by **August 15, 2020**. Liquidated damages will apply in accordance with Section 108.09 of the Standard Specifications for failure to complete the striping by August 15, 2020.

All routes identified in the proposal as a "Priority Route" shall be striped by **October 15, 2019**. Liquidated damages in the amount specified in Section 108.09 of the Standard Specifications will be assessed for each day that any Priority Route remains unstriped after October 15, 2019. The Department shall expect strict adherence to the weather limitations of the striping. If the Engineer determines that excessive weather limitations occur during the period after the notice to proceed of the contract and prior to the October 15, 2019 deadline for Priority Routes, and such weather limitations make it unreasonable for the Contractor to complete the Priority Routes by October 15, 2019, then the Engineer may waive the Liquidated Damages associated with the October 15, 2019 deadline for Priority Routes.

Any necessary corrective work must be completed within 15 calendar days after notification by the Engineer. If corrective work for a Priority Route is identified after October 1, 2019 and such corrective work cannot be completed by October 15, 2019 deadline, the corrective work may be completed in the spring of 2020. Such corrective work for a priority route will have a completion date of May 31, 2020.

Remove all striping errors and spills within five (5) working days after notification by the Engineer. Liquidated damages, in the amount specified in Section 108.09 of the Standard Specifications, shall apply for each day beyond the five (5) working days that the Contractor has not begun to correct the striping error/spill or continuously work to complete the corrective work.

The Department will apply all Liquidated Damages accumulatively.

COORDINATION OF WORK WITH OTHER CONTRACTS

Be advised, there may be an active project(s) adjacent to or within this project. The Engineer will coordinate the work of the Contractors. See Section 105.06.

1-3193 Coordination Contracts
01/02/2012

TRAFFIC CONTROL PLAN

6" Thermoplastic Striping

1. Maintain and Control Traffic in accordance with the Standard Specifications for Road and Bridge Construction, Supplemental Specification, Standard and Sepia Drawings, and the MUTCD, current editions.
2. Contrary to Section 112, include all items necessary to maintain and control traffic in the lump sum bid item "Maintain and Control Traffic". The Department will measure and pay only the bid items listed; consider all other work and necessary items to be incidental to the listed bid items. The Department will measure and pay "Maintain and Control Traffic" as one lump sum.
3. Maintain possession of all temporary traffic control items, devices, materials, and incidentals, unless otherwise specified in the proposal, when no longer needed.
4. If the Contractor desires to deviate from the traffic control scheme outlined in the Standard Drawings, prepare an alternate plan and present it in writing to the Engineer. Do not use the alternate plan until reviewed and approved by the District Engineer and the Divisions of Construction, Maintenance, and Traffic Operations.
5. Provide for the Contractor's vehicles to always move with and not across or against the flow of traffic. Do not allow vehicles to make U-turns at any location. Do not allow the striper to stop and back down the road or ramps to stripe gore lines and turn lanes. Require vehicles to enter or leave work areas in a manner that will not be hazardous to, or interfere with, normal traffic flow. Do not allow vehicles to park or stop within the right-of-way except within work areas designated by the Engineer. Do not allow personal vehicles to park within the right-of-way except in specific areas designated by the Engineer.
6. Do not allow the paint supply truck to operate as one of the traffic control vehicles shown on the Standard Drawings. If one of the required traffic control vehicles experiences mechanical problems or for some other reason is not available to remain in position as shown in the traffic control scheme, cease the striping operation until all required vehicles are in place.
7. Do not perform striping operations on any roadway during the peak times of the day, holiday periods, or special events as determined by the Engineer.
8. On two-lane, two-way highways, make provisions to the satisfaction of the Engineer to periodically allow traffic to safely pass the train of vehicles in the striping operation.
9. In low speed, urban situations, the Engineer may permit the Contractor to delete the intermediate trail vehicle between the striper and the final trail vehicle shown on the Standard Drawings.

	KENTUCKY TRANSPORTATION CABINET Department of Highways DIVISION OF RIGHT OF WAY & UTILITIES	TC 62-226 Rev. 01/2016 Page 1 of 1
RIGHT OF WAY CERTIFICATION		

<input checked="" type="checkbox"/> Original	<input type="checkbox"/> Re-Certification	RIGHT OF WAY CERTIFICATION	
ITEM #	COUNTY	PROJECT # (STATE)	PROJECT # (FEDERAL)
2-924	VARIOUS	FD52 121 9999 000-000	HSIP 9010(392)

PROJECT DESCRIPTION
INSTALLATION OF 6" STRIPING ON VARIOUS ROUTES IN DISTRICT 2

No Additional Right of Way Required
 Construction will be within the limits of the existing right of way. The right of way was acquired in accordance to FHWA regulations under the Uniform Relocation Assistance and Real Property Acquisitions Policy Act of 1970, as amended. No additional right of way or relocation assistance were required for this project.



Condition # 1 (Additional Right of Way Required and Cleared)
 All necessary right of way, including control of access rights when applicable, have been acquired including legal and physical possession. Trial or appeal of cases may be pending in court but legal possession has been obtained. There may be some improvements remaining on the right-of-way, but all occupants have vacated the lands and improvements, and KYTC has physical possession and the rights to remove, salvage, or demolish all improvements and enter on all land. Just Compensation has been paid or deposited with the court. All relocations have been relocated to decent, safe, and sanitary housing or that KYTC has made available to displaced persons adequate replacement housing in accordance with the provisions of the current FHWA directive.

Condition # 2 (Additional Right of Way Required with Exception)
 The right of way has not been fully acquired, the right to occupy and to use all rights-of-way required for the proper execution of the project has been acquired. Some parcels may be pending in court and on other parcels full legal possession has not been obtained, but right of entry has been obtained, the occupants of all lands and improvements have vacated, and KYTC has physical possession and right to remove, salvage, or demolish all improvements. Just Compensation has been paid or deposited with the court for most parcels. Just Compensation for all pending parcels will be paid or deposited with the court prior to AWARD of construction contract



Condition # 3 (Additional Right of Way Required with Exception)
 The acquisition or right of occupancy and use of a few remaining parcels are not complete and/or some parcels still have occupants. All remaining occupants have had replacement housing made available to them in accordance with 49 CFR 24.204. KYTC is hereby requesting authorization to advertise this project for bids and to proceed with bid letting even though the necessary right of way will not be fully acquired, and/or some occupants will not be relocated, and/or the just compensation will not be paid or deposited with the court for some parcels until after bid letting. KYTC will fully meet all the requirements outlined in 23 CFR 635.309(c)(3) and 49 CFR 24.102(j) and will expedite completion of all acquisitions, relocations, and full payments after bid letting and prior to AWARD of the construction contract or force account construction.

Total Number of Parcels on Project	0	EXCEPTION (S) Parcel #	ANTICIPATED DATE OF POSSESSION WITH EXPLANATION
Number of Parcels That Have Been Acquired			
Signed Deed			
Condemnation			
Signed ROE			

Notes/ Comments (Use Additional Sheet if necessary)

LPA RW Project Manager		Right of Way Supervisor	
Printed Name		Printed Name	Jennifer K. Cox
Signature		Signature	 jenniferk.cox@ky.gov 2019.05.23 12:06:59 -05'00'
Date		Date	
Right of Way Director		FHWA	
Printed Name		Printed Name	No Signature Required as per FHWA-KYTC Current Stewardship Agreement
Signature	 2019.05.23	Signature	
Date	13:49:58 -05'00'	Date	

	KENTUCKY TRANSPORTATION CABINET Department of Highways DIVISION OF RIGHT OF WAY & UTILITIES RIGHT OF WAY CERTIFICATION	TC 62-226 Rev. 01/2016 Page 1 of 1
---	--	--

<input checked="" type="checkbox"/>	Original	<input type="checkbox"/>	Re-Certification	RIGHT OF WAY CERTIFICATION			
ITEM #		COUNTY		PROJECT # (STATE)		PROJECT # (FEDERAL)	
3-931		VARIOUS		FD52 121 9999 000-000		HSIP 9010(393)	
PROJECT DESCRIPTION							
INSTALLATION OF 6" STRIPING ON VARIOUS ROUTES IN DISTRICT 3							
<input checked="" type="checkbox"/> No Additional Right of Way Required							
Construction will be within the limits of the existing right of way. The right of way was acquired in accordance to FHWA regulations under the Uniform Relocation Assistance and Real Property Acquisitions Policy Act of 1970, as amended. No additional right of way or relocation assistance were required for this project.							
<input type="checkbox"/> Condition # 1 (Additional Right of Way Required and Cleared)							
All necessary right of way, including control of access rights when applicable, have been acquired including legal and physical possession. Trial or appeal of cases may be pending in court but legal possession has been obtained. There may be some improvements remaining on the right-of-way, but all occupants have vacated the lands and improvements, and KYTC has physical possession and the rights to remove, salvage, or demolish all improvements and enter on all land. Just Compensation has been paid or deposited with the court. All relocations have been relocated to decent, safe, and sanitary housing or that KYTC has made available to displaced persons adequate replacement housing in accordance with the provisions of the current FHWA directive.							
<input type="checkbox"/> Condition # 2 (Additional Right of Way Required with Exception)							
The right of way has not been fully acquired, the right to occupy and to use all rights-of-way required for the proper execution of the project has been acquired. Some parcels may be pending in court and on other parcels full legal possession has not been obtained, but right of entry has been obtained, the occupants of all lands and improvements have vacated, and KYTC has physical possession and right to remove, salvage, or demolish all improvements. Just Compensation has been paid or deposited with the court for most parcels. Just Compensation for all pending parcels will be paid or deposited with the court prior to AWARD of construction contract							
<input type="checkbox"/> Condition # 3 (Additional Right of Way Required with Exception)							
The acquisition or right of occupancy and use of a few remaining parcels are not complete and/or some parcels still have occupants. All remaining occupants have had replacement housing made available to them in accordance with 49 CFR 24.204. KYTC is hereby requesting authorization to advertise this project for bids and to proceed with bid letting even though the necessary right of way will not be fully acquired, and/or some occupants will not be relocated, and/or the just compensation will not be paid or deposited with the court for some parcels until after bid letting. KYTC will fully meet all the requirements outlined in 23 CFR 635.309(c)(3) and 49 CFR 24.102(j) and will expedite completion of all acquisitions, relocations, and full payments after bid letting and prior to AWARD of the construction contract or force account construction.							
Total Number of Parcels on Project		0	EXCEPTION (S) Parcel #		ANTICIPATED DATE OF POSSESSION WITH EXPLANATION		
Number of Parcels That Have Been Acquired							
Signed Deed							
Condemnation							
Signed ROE							
Notes/ Comments (Use Additional Sheet if necessary)							
LPA RW Project Manager				Right of Way Supervisor			
Printed Name				Printed Name		Allen Arnold	
Signature				Signature		 <small>Digitally signed by Allen Arnold Date: 2019.05.23 08:18:20 -05'00'</small>	
Date				Date		05/23/2019	
Right of Way Director				FHWA			
Printed Name		Kelly Divine		Printed Name			
Signature		 <small>2019.05.23 09:08:21 -05'00'</small>		Signature		No Signature Required as per FHWA-KYTC Current Stewardship Agreement	
Date		05/23/2019		Date			

UTILITIES AND RAIL CERTIFICATION NOTE

**Various Counties; HSIP 9010 (392); FD52 121 9999 000-000
Installation of 6" Striping
on Various Routes in District 2
Item No. 2-924.00**

No utility relocation work is required to complete this project.

THE FOLLOWING RAIL COMPANIES HAVE FACILITIES IN CONJUNCTION WITH THIS PROJECT AS NOTED

No Rail Involved **Minimal Rail Involved (See Below)** **Rail Involved (See Below)**

UNDERGROUND FACILITY DAMAGE PROTECTION – BEFORE YOU DIG

The contractor shall make every effort to protect underground facilities from damage as prescribed in the Underground Facility Damage Protection Act of 1994, Kentucky Revised Statute KRS 367.4901 to 367.4917. It is the contractor’s responsibility to determine and take steps necessary to be in compliance with federal and state damage prevention directives. The contractor is instructed to contact KY 811 for the location of existing underground utilities. Contact shall be made a minimum of two (2) and no more than ten (10) business days prior to excavation.

The contractor shall submit Excavation Locate Requests to the Kentucky Contact Center (KY 811) via web ticket entry. The submission of this request does not relieve the contractor from the responsibility of contacting non-member facility owners, whom are to be contacted through their individual Protection Notification Center. It may be necessary for the contractor to contact the County Court Clerk to determine what utility companies have facilities in the area. Non-compliance with these directives can result in the enforcement of penalties.

SPECIAL CAUTION NOTE – PROTECTION OF UTILITIES

The contractor will be responsible for contacting all utility facility owners on the subject project to coordinate his activities. The contractor will coordinate his activities to minimize and, where possible, avoid conflicts with utility facilities. Due to the nature of the work proposed, it is unlikely to conflict with the existing utilities beyond minor facility adjustments. Where conflicts with utility facilities are unavoidable, the contractor will coordinate any necessary relocation work with the facility owner and the Engineer. The Kentucky Transportation Cabinet maintains the right to remove or alter portions of this contract if a utility conflict occurs.

The utility facilities as noted in the previous section(s) have been determined using data garnered by varied means and with varying degrees of accuracy: from the facility owners, a result of S.U.E., field inspections, and/or reviews of record drawings. The facilities defined may not be inclusive of all utilities in the project scope and are not Level A quality, unless specified as such. It is the contractor’s responsibility to verify all utilities and their respective locations before excavating.

Please Note: The information presented in this Utility Note is informational in nature and the information contained herein is not guaranteed.

UTILITIES AND RAIL CERTIFICATION NOTE

**Various Counties; HSIP 9010 (393); FD52 121 9999 000-000
Installation of 6" Striping
on Various Routes in District 3
Item No. 3-931.00**

No utility relocation work is required to complete this project.

THE FOLLOWING RAIL COMPANIES HAVE FACILITIES IN CONJUNCTION WITH THIS PROJECT AS NOTED

No Rail Involved **Minimal Rail Involved (See Below)** **Rail Involved (See Below)**

UNDERGROUND FACILITY DAMAGE PROTECTION – BEFORE YOU DIG

The contractor shall make every effort to protect underground facilities from damage as prescribed in the Underground Facility Damage Protection Act of 1994, Kentucky Revised Statute KRS 367.4901 to 367.4917. It is the contractor’s responsibility to determine and take steps necessary to be in compliance with federal and state damage prevention directives. The contractor is instructed to contact KY 811 for the location of existing underground utilities. Contact shall be made a minimum of two (2) and no more than ten (10) business days prior to excavation.

The contractor shall submit Excavation Locate Requests to the Kentucky Contact Center (KY 811) via web ticket entry. The submission of this request does not relieve the contractor from the responsibility of contacting non-member facility owners, whom are to be contacted through their individual Protection Notification Center. It may be necessary for the contractor to contact the County Court Clerk to determine what utility companies have facilities in the area. Non-compliance with these directives can result in the enforcement of penalties.

SPECIAL CAUTION NOTE – PROTECTION OF UTILITIES

The contractor will be responsible for contacting all utility facility owners on the subject project to coordinate his activities. The contractor will coordinate his activities to minimize and, where possible, avoid conflicts with utility facilities. Due to the nature of the work proposed, it is unlikely to conflict with the existing utilities beyond minor facility adjustments. Where conflicts with utility facilities are unavoidable, the contractor will coordinate any necessary relocation work with the facility owner and the Engineer. The Kentucky Transportation Cabinet maintains the right to remove or alter portions of this contract if a utility conflict occurs.

The utility facilities as noted in the previous section(s) have been determined using data garnered by varied means and with varying degrees of accuracy: from the facility owners, a result of S.U.E., field inspections, and/or reviews of record drawings. The facilities defined may not be inclusive of all utilities in the project scope and are not Level A quality, unless specified as such. It is the contractor’s responsibility to verify all utilities and their respective locations before excavating.

Please Note: The information presented in this Utility Note is informational in nature and the information contained herein is not guaranteed.

DISTRICT 2

Daviess Co.
US-431 MP 0.000 - 10.238

McLean Co.
US-431 MP 0.745 - 0.840
US-431 MP 2.766 - 11.573

Muhlenberg Co.
US-431 MP 0.000 - 11.460
US-431 MP 19.397 - 28.311



***Refer to the Summary Sheet or the discretion of the Engineer for exact milepoints**

DISTRICT 3

Allen Co.
US-31E MP 7.546 - 13.129
US-31E MP 19.156 - 19.188

Barren Co.
US-31E MP 0.000 - 8.079
KY-90 MP 0.000 - 0.426
KY-90 MP 8.345 - 18.041

Logan Co.
US-68 MP 14.100 - 20.956
US-431 MP 0.000 - 11.593
US-431 MP 18.292 - 28.747

Metcalfe Co.
KY-90 MP 0.000 - 6.951

*Refer to the Summary Sheet
or the discretion of the
Engineer for exact
milepoints

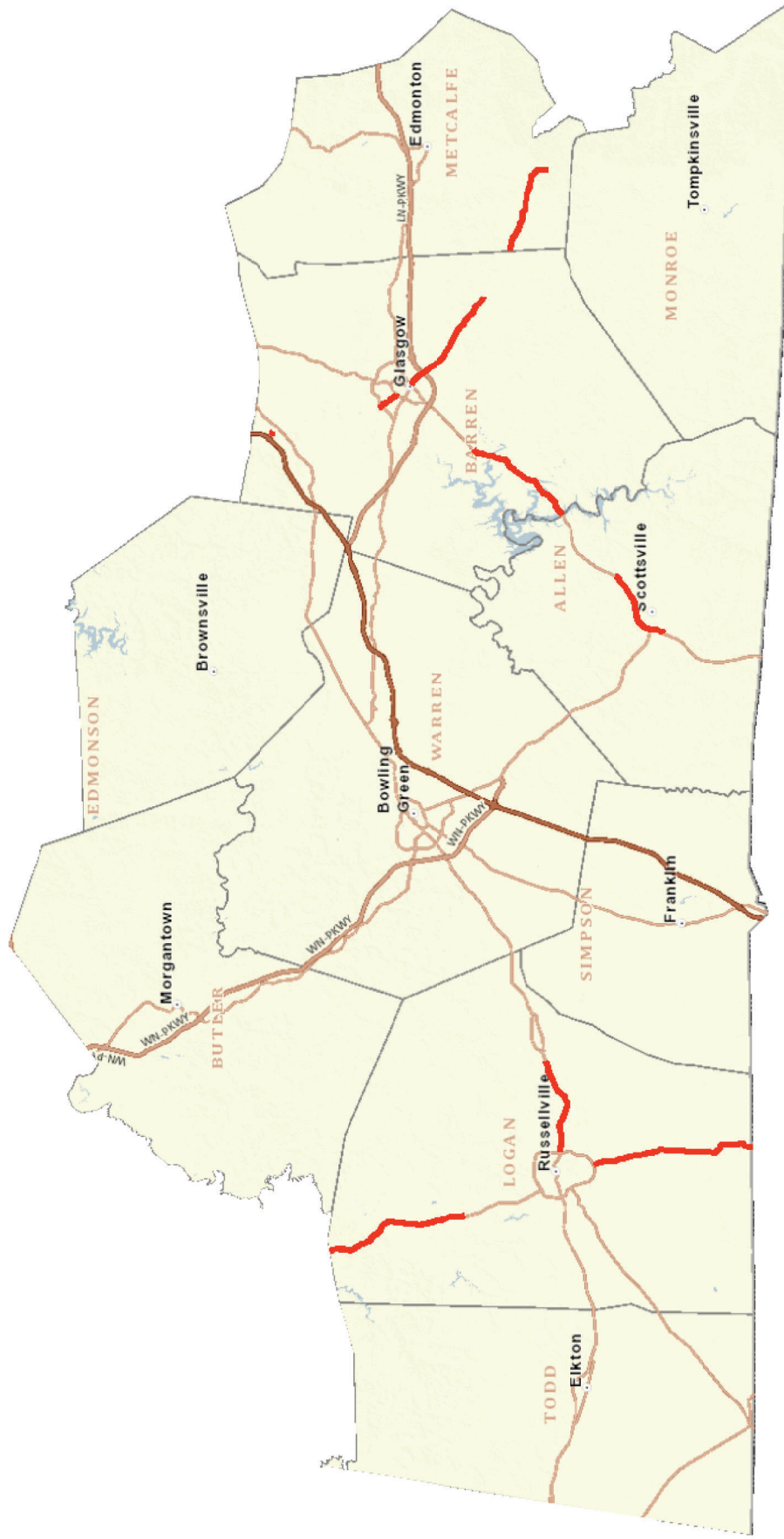

MATERIAL SUMMARY

CONTRACT ID: 194117

121GR19T012-HSIP

0212199991901

THERMOPLASTIC STRIPING ON VARIOUS ROUTES IN DISTRICT 2 THERMOPLASTIC STRIPING ON VARIOUS ROUTES IN DISTRICT 2 THERMOPLASTIC PAVEMENT STRIPING.

Project Line No	Bid Code	DESCRIPTION	Quantity	Unit
0005	02650	MAINTAIN & CONTROL TRAFFIC - DISTRICT 2	1.00	LS
0010	06556	PAVE STRIPING-DUR TY 1-6 IN W	8,511.00	LF
0015	06557	PAVE STRIPING-DUR TY 1-6 IN Y	8,511.00	LF
0020	24995EC	PAVE STRIPING-SPRAY THERMO-6 IN W	409,746.00	LF
0025	24996EC	PAVE STRIPING-SPRAY THERMO-6 IN Y	408,725.00	LF
0030	02569	DEMOBILIZATION	1.00	LS

CONTRACT ID: 194117

121GR19T012-HSIP

0312199991901

THERMOPLASTIC STRIPING ON VARIOUS ROUTES IN DISTRICT 3 THERMOPLASTIC STRIPING ON VARIOUS ROUTES IN DISTRICT 3 THERMOPLASTIC PAVEMENT STRIPING.

Project Line No	Bid Code	DESCRIPTION	Quantity	Unit
0035	02650	MAINTAIN & CONTROL TRAFFIC - DISTRICT 3	1.00	LS
0040	06556	PAVE STRIPING-DUR TY 1-6 IN W	9,667.00	LF
0045	06557	PAVE STRIPING-DUR TY 1-6 IN Y	9,762.00	LF
0050	24995EC	PAVE STRIPING-SPRAY THERMO-6 IN W	742,529.00	LF
0055	24996EC	PAVE STRIPING-SPRAY THERMO-6 IN Y	709,796.00	LF
0060	02569	DEMOBILIZATION	1.00	LS

County	Route	BMP	EMP	Typical	Asphalt or Concrete?	Roadway Information				6" TYPE 1 TAPE		Comments		
						Turn Lanes		Truck Climbing Lanes		Asphalt Surfaces			Concrete Surfaces	
						# of Turn Lanes	Average Length	Estimated Quantity	# of Truck Climbing Lanes	Average Length	Estimated Quantity		Total 6556 PAVE STRIPING - DUR TY 1-6 IN W (Linear Feet)	Total 6557 PAVE STRIPING - DUR TY 1-6 IN Y (Linear Feet)
Muhlenberg	US 431	0.000	3.453	2-lane with edgelines	Asphalt	0	0	0	0	0	0			
		3.453	3.483	2-lane with edgelines	Concrete	0	0	0	0	0	0	317		
		3.483	9.194	2-lane with edgelines	Asphalt	0	0	0	0	0	0	60,308		
		9.194	9.453	2-lane with edgelines	Asphalt	1	336	336	0	0	0	2,735		
		9.453	11.460	2-lane with edgelines	Asphalt	0	0	0	0	0	0	21,194		
		19.397	19.467	2-lane with edgelines	Concrete	0	0	0	0	0	0	739		
		19.467	21.766	2-lane with edgelines	Asphalt	2	170	340	0	0	0	24,277		
		21.766	21.811	2-lane with edgelines	Concrete	0	0	0	0	0	0	475		
		21.811	28.221	2-lane with edgelines	Asphalt	3	160	480	0	0	0	67,690		
		28.221	28.311	2-lane with edgelines	Concrete	0	0	0	0	0	0	950		
Mclean	US 431	0.745	0.840	2-lane with edgelines	Concrete	0	0	0	0	0	0	1,003		
		2.766	2.915	Other	Asphalt	1	218	218	0	0	0	1,711		
		2.915	4.626	2-lane with edgelines	Asphalt	0	0	0	0	0	0	18,068		
		4.626	4.691	2-lane with edgelines	Concrete	0	0	0	0	0	0	686		
		4.691	5.095	2-lane with edgelines	Asphalt	0	0	0	0	0	0	4,266		
		5.095	5.406	2-lane with edgelines	Concrete	0	0	0	0	0	0	3,284		
		5.406	5.858	2-lane with edgelines	Asphalt	0	0	0	0	0	0	4,773		
		5.858	5.903	2-lane with edgelines	Asphalt	0	0	0	0	0	0	475		
		5.903	5.943	2-lane with edgelines	Asphalt	1	137	137	0	0	0	422		
		5.943	6.069	2-lane with TW/TL no edgelines	Asphalt	0	0	0	0	0	0	1,531		
Davies	US 431	6.074	6.106	2-lane with edgelines	Asphalt	1	150	150	0	0	0	338		
		6.106	6.185	2-lane with edgelines	Asphalt	0	0	0	0	0	0	834		
		6.185	8.160	2-lane with edgelines	Asphalt	0	0	0	0	0	0	20,856		
		8.160	8.215	2-lane with edgelines	Asphalt	0	0	0	0	0	0	581		
		8.215	8.325	2-lane with edgelines	Asphalt	2	185	370	0	0	0	1,162		
		8.325	8.364	2-lane with edgelines	Asphalt	0	0	0	0	0	0	412		
		8.364	9.134	2-lane with edgelines	Asphalt	0	0	0	0	0	0	8,131		
		9.134	9.144	2-lane with edgelines	Concrete	0	0	0	0	0	0	106		
		9.144	11.573	2-lane with edgelines	Asphalt	0	0	0	0	0	0	25,650		
		11.573	7.019	2-lane with edgelines	Asphalt	0	0	0	0	0	0	74,121		
Davies	US 431	7.019	7.074	2-lane with edgelines	Asphalt	1	322	322	0	0	0	903		
		7.074	7.159	2-lane with edgelines	Asphalt	1	318	318	0	0	0	1,004		
		7.159	7.210	2-lane with edgelines	Asphalt	1	150	150	0	0	0	689		
		7.210	8.557	2-lane with edgelines	Asphalt	1	122	122	0	0	0	14,241		
		8.557	8.627	2-lane with edgelines	Concrete	0	0	0	0	0	0	739		
		8.627	9.041	2-lane with edgelines	Asphalt	0	0	0	0	0	0	4,372		
		9.041	9.061	2-lane with edgelines	Concrete	0	0	0	0	0	0	211		
		9.061	10.041	2-lane with edgelines	Asphalt	0	0	0	0	0	0	10,349		
		10.041	10.238	2-lane with edgelines	Asphalt	2	232	464	0	0	0	2,544		

Totals	409,746	408,725	8,511
---------------	----------------	----------------	--------------

County	Route	BMP	EMP	Typical	Asphalt or Concrete?	Turn Lanes			Truck Climbing Lanes			6" SPRAY THERMOPLASTIC Asphalt Surfaces		6" TYPE 1 TAPE Concrete Surfaces		Comments
						# of Turn Lanes	Average Length	Estimated Quantity	# of Truck Climbing Lanes	Average Length	Estimated Quantity	Total 24495EC PAVE STRIPING-6 W SPRAY THERMO (Linear Feet)	Total 24496EC PAVE STRIPING-THERMO - 6 Y (Linear Feet)	Total 6556 PAVE STRIPING-IN W (Linear Feet)	Total 6557 PAVE STRIPING-DUR TY 1-6 IN Y (Linear Feet)	
Logan	0.000	0.955	2-lane with edgelines	Asphalt	0	0	0	0	0	0	10,085	10,085	634	634		
	0.955	1.015	2-lane with edgelines	Concrete	0	0	0	0	0	0	0	0	0	0	634	
	1.015	1.950	2-lane no edgelines	Asphalt	0	0	0	0	0	0	0	0	0	0	9,874	
	1.950	4.022	2-lane with edgelines	Asphalt	0	0	0	0	0	0	21,880	21,880	634	634		
	4.022	4.082	2-lane with edgelines	Concrete	0	0	0	0	0	0	76,592	76,592	634	634		
	4.082	11.335	2-lane with edgelines	Asphalt	0	0	0	0	0	0	3,294	2,724	634	634		
	11.335	11.593	2-lane with edgelines	Asphalt	1	570	570	0	0	0	0	0	0	0	0	
	18.292	19.121	2-lane with edgelines	Asphalt	4	369	1476	0	0	0	10,230	8,754	634	634		
	19.121	24.257	2-lane with edgelines	Asphalt	0	0	0	0	0	0	54,236	54,236	517	517		
	24.257	24.306	2-lane with edgelines	Concrete	0	0	0	0	0	0	0	0	0	0	0	
	24.306	24.571	2-lane with edgelines	Asphalt	0	0	0	0	0	0	2,798	2,798	275	275		
	24.571	24.597	2-lane with edgelines	Concrete	0	0	0	0	0	0	1,637	1,637	158	158		
	24.597	24.752	2-lane with edgelines	Asphalt	0	0	0	0	0	0	42,029	42,029	158	158		
	24.752	24.767	2-lane with edgelines	Concrete	0	0	0	0	0	0	2,350	1,500	158	158		
	24.767	28.747	2-lane with edgelines	Asphalt	2	238	476	0	0	0	509	327	158	158		
0.000	0.142	4-lane undivided with edgelines	Asphalt	1	100	100	0	0	0	2,080	2,080	327	327			
0.142	0.198	4-lane undivided with edgelines	Asphalt	0	0	0	0	0	0	0	0	0	0	0		
0.198	0.395	2-lane with edgelines	Asphalt	0	0	0	0	0	0	0	0	0	0	0		
0.395	0.426	2-lane with edgelines	Concrete	0	0	0	0	0	0	0	0	0	0	0		
0.426	0.436	2-lane with edgelines	Concrete	0	0	0	0	0	0	0	0	0	0	0		
0.436	0.425	2-lane with edgelines	Asphalt	0	0	0	0	0	0	0	0	0	0	0		
0.425	0.976	2-lane with edgelines	Asphalt	10	325	3250	0	0	0	9,069	5,819	433	433			
0.976	0.976	2-lane with edgelines	Asphalt	10	325	3250	0	0	0	9,069	5,819	433	433			
0.976	9.376	2-lane with edgelines	Asphalt	1	533	533	0	0	0	1,600	1,067	158	158			
9.376	9.477	2-lane with edgelines	Asphalt	1	533	533	0	0	0	1,600	1,067	158	158			
9.477	9.906	4-lane undivided with edgelines	Asphalt	2	240	480	0	0	0	6,143	4,530	190	190			
9.906	10.507	2-lane with edgelines	Asphalt	1	55	55	0	0	0	6,222	6,167	190	190			
10.507	10.525	2-lane with edgelines	Concrete	0	0	0	0	0	0	0	0	0	0	0		
10.525	11.056	2-lane with edgelines	Asphalt	0	0	0	0	0	0	5,607	5,607	190	190			
11.056	11.126	4-lane divided	Asphalt	0	0	0	0	0	0	924	739	190	190			
11.126	11.141	Other	Asphalt	1	75	75	0	0	0	395	300	190	190			
11.141	11.188	Other	Concrete	1	250	250	0	0	0	0	0	0	0	0		
11.188	11.216	Other	Asphalt	1	82	82	0	0	0	430	480	190	190			
11.216	11.314	4-lane divided	Asphalt	1	50	50	0	0	0	1,344	1,035	190	190			
11.314	12.629	4-lane with TWLTL and edgelines	Asphalt	2	100	200	0	0	0	17,558	17,358	190	190			
12.629	12.763	Other	Asphalt	1	175	175	0	0	0	1,586	2,072	190	190			
12.763	12.788	Other	Concrete	0	0	0	0	0	0	0	0	0	0	0		
12.788	14.835	2-lane with edgelines	Asphalt	0	0	0	1	5092	1273	22,889	21,616	190	190			
14.835	17.731	2-lane with edgelines	Asphalt	2	50	100	1	3364	841	31,523	30,582	190	190			
17.731	17.756	2-lane with edgelines	Concrete	0	0	0	0	0	0	0	0	0	0	0		
17.756	18.041	2-lane with edgelines	Asphalt	0	0	0	0	0	0	3,010	3,010	264	264			
0.000	1.125	2-lane with edgelines	Asphalt	0	0	0	0	0	0	11,880	11,880	106	106			
1.125	1.135	2-lane with edgelines	Concrete	0	0	0	0	0	0	0	0	0	0	0		
1.135	6.951	2-lane with edgelines	Asphalt	3	207	621	2	2104	1052	63,090	61,417	106	106			

Allen	US 31E	7.546	8.488	2-lane with edgelines	Asphalt	15	345	5175	0	0	0	15,123	9,948		
		8.488	8.845	2-lane with edgelines	Asphalt	3	325	975	0	0	0	4,745	3,770		
		8.845	9.641	2-lane with edgelines	Asphalt	0	0	0	0	0	0	8,406	8,406		
		9.641	9.686	2-lane with edgelines	Concrete	0	0	0	0	0	0		475	475	
		9.686	10.351	2-lane with edgelines	Asphalt	0	0	0	0	0	0	7,022	7,022		
		10.351	11.302	2-lane with edgelines	Asphalt	3	200	600	0	0	0	10,643	10,043		
		11.302	11.342	2-lane with edgelines	Concrete	0	0	0	0	0	0		422	422	
		11.342	13.129	2-lane with edgelines	Asphalt	0	0	0	1	4000	1000	19,871	18,871		
		13.129	19.188	2-lane with edgelines	Concrete	0	0	0	0	0	0		338	338	
		19.188	0.000	2-lane with edgelines	Concrete	0	0	0	0	0	0		655	655	
		0.000	0.062	2-lane with edgelines	Asphalt	0	0	0	2	3184	1592	23,145	21,553		
		0.062	2.103	2-lane with edgelines	Concrete	0	0	0	0	0	0		623	623	
		2.103	2.162	2-lane with edgelines	Asphalt	0	0	0	4	2424	2424	50,060	47,636		
		2.162	6.673	2-lane with edgelines	Concrete	0	0	0	0	0	0		528	528	
		6.673	6.723	2-lane with edgelines	Asphalt	0	0	0	0	0	0	14,319	14,319		
6.723	8.079	2-lane with edgelines	Asphalt	0	0	0	0	0	0	5,021	4,633				
8.079	14.100	2-lane with edgelines	Asphalt	2	360	720	1	2376	594	90,216	68,693				
14.100	14.451	2-lane with TWLTL and edgelines	Asphalt	15	290	4350	0	0	0						
14.451	20.956	4-lane divided	Asphalt												

Totals	742,529	709,796	9,667	9,762
---------------	----------------	----------------	--------------	--------------

Thermoplastic Retrofit Detail

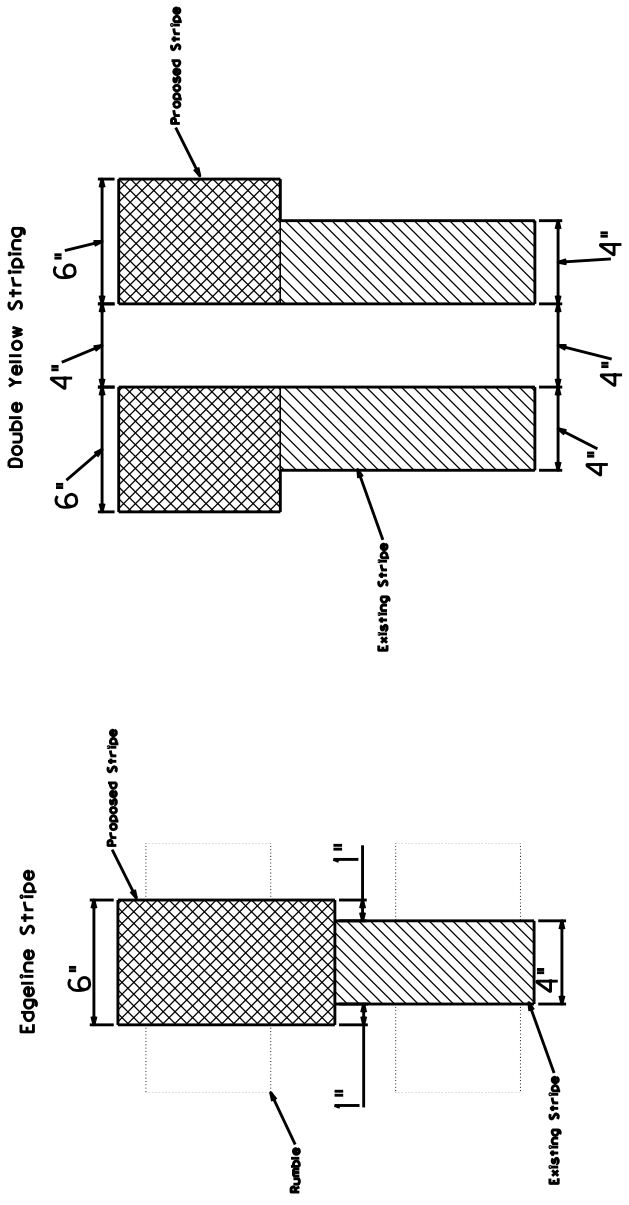

Proposed Edgeline Striping For Curb and Gutter

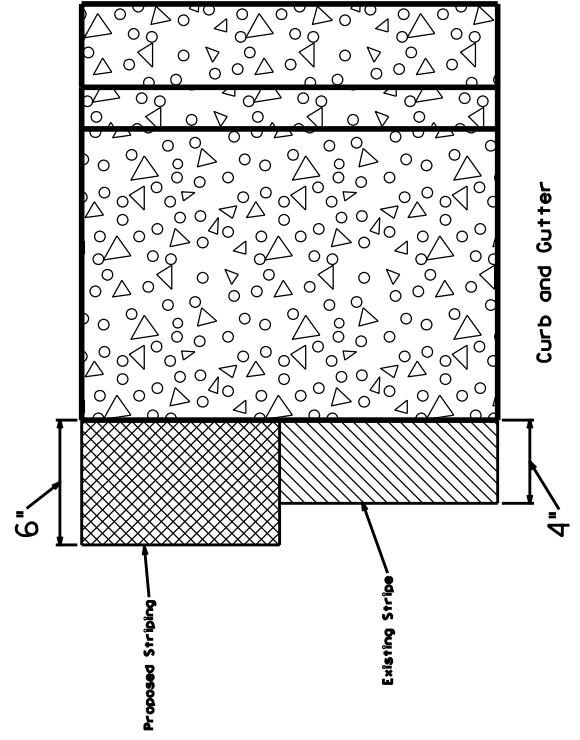

• Striping Detail intended to demonstrate the preferred methods to obtain 6" width for various striping scenarios.

PART II
SPECIFICATIONS AND STANDARD DRAWINGS

SPECIFICATIONS REFERENCE

Any reference in the plans or proposal to previous editions of the *Standard Specifications for Road and Bridge Construction* and *Standard Drawings* are superseded by *Standard Specifications for Road and Bridge Construction, Edition of 2019* and *Standard Drawings, Edition of 2016*.

SUPPLEMENTAL SPECIFICATIONS

The contractor shall use the Supplemental Specifications that are effective at the time of letting.
The Supplemental Specifications can be found at the following link:

<http://transportation.ky.gov/Construction/Pages/Kentucky-Standard-Specifications.aspx>

2016 STANDARD DRAWINGS THAT APPLY

TRAFFIC ~ *TEMPORARY* ~ TRAFFIC CONTROL

LANE CLOSURE TWO-LANE HIGHWAY	TTC-100-04
LANE CLOSURE USING TRAFFIC SIGNALS	TTC-110-03
LANE CLOSURE MULTI-LANE HIGHWAY CASE I.....	TTC-115-03
LANE CLOSURE MULTI-LANE HIGHWAY CASE II.....	TTC-120-03
DOUBLE LANE CLOSURE	TTC-125-03
SHOULDER CLOSURE.....	TTC-135-02
MEDIAN CROSSOVER CASE I	TTC-140-03
MEDIAN CROSSOVER CASE I	TTC-141-03
MEDIAN CROSSOVER CASE II	TTC-145-03
MEDIAN CROSSOVER CASE II	TTC-146-03
ROAD CLOSURE WITH DIVERSION	TTC-150-03
TEMPORARY PAVEMENT MARKER ARRANGEMENTS FOR CONSTRUCTION ZONES	TTC-155-02
TEMPORARY PAVEMENT MARKER ARRANGEMENTS FOR LANE CLOSURES	TTC-160-02

STRIPING OPERATIONS

MOBILE OPERATION FOR PAINT STRIPING CASE I.....	TTS-100-02
MOBILE OPERATION FOR PAINT STRIPING CASE II	TTS-105-02
MOBILE OPERATION FOR PAINT STRIPING CASE III	TTS-110-02
MOBILE OPERATION FOR PAINT STRIPING CASE IV	TTS-115-02
MOBILE OPERATION FOR DURABLE STRIPING CASE I.....	TTS-120-02
MOBILE OPERATION FOR DURABLE STRIPING CASE II	TTS-125-02
MOBILE OPERATION FOR DURABLE STRIPING CASE III.....	TTS-130-02
MOBILE OPERATION FOR DURABLE STRIPING CASE IV.....	TTS-135-02

COUNTY OF	ITEM NO.	SHEET NO.

STRIPING NOTES:

- ARROWS SHALL BE USED IN ANY EXCLUSIVE TURN LANES.
- IN A SINGLE TURN LANE, DOTTED WHITE LANE LINE EXTENSIONS MAY BE USED THROUGH THE TAPER OF THE TURN LANE.
- IF USED, DOTTED WHITE LANE LINE EXTENSIONS SHALL BE NORMAL WIDTH, AND SHOULD BE 2' LONG, WITH A GAP OF 2-6' BETWEEN EACH LINE.
- IN DUAL TURN LANES, DOTTED WHITE LANE LINE EXTENSIONS SHOULD BE USED THROUGH THE TAPER OF THE TURN LANE. BOTH SOLID LINES FORMING THE TURN LANES SHALL BEGIN AT THE DOWNSTREAM END OF THE TAPER.

ARROW SPACING NOTES:

- IN SINGLE-DIRECTION TURN LANES, ARROWS SHOULD BE SPACED AS FOLLOWS:
- AT LEAST TWO ARROWS SHOULD BE USED IN EACH TURN LANE. HOWEVER, IF A TURN LANE IS LESS THAN 80' IN LENGTH, THE DOWNSTREAM ARROW MAY BE ELIMINATED.
- THE FIRST UPSTREAM ARROW SHALL BE PLACED AT THE BEGINNING OF THE SOLID LINE FOR THE TURN LANE.
- THE LAST DOWNSTREAM ARROW SHOULD BE PLACED 40' FROM THE STOP BAR.
- ANY ADDITIONAL ARROWS SHOULD BE EVENLY SPACED. SPACING SHOULD NOT EXCEED 80'.
- ARROW SPACING AND NUMBER OF ARROWS MAY VARY BASED ON SITE CONDITIONS.

DOTTED EXTENSION DIMENSIONS:



Dotted extensions shall be normal width.

KENTUCKY DEPARTMENT OF HIGHWAYS

TYPICAL MARKINGS FOR TURN LANES

SUBMITTED: *R. [Signature]* DATE: 11-30-18 **042**

DRAWING NOT TO SCALE

LEGEND

MARKINGS	WHITE
	YELLOW

Single turn lane

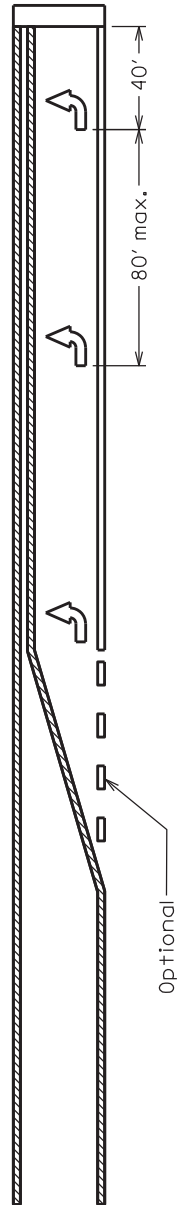

Dual turn lane

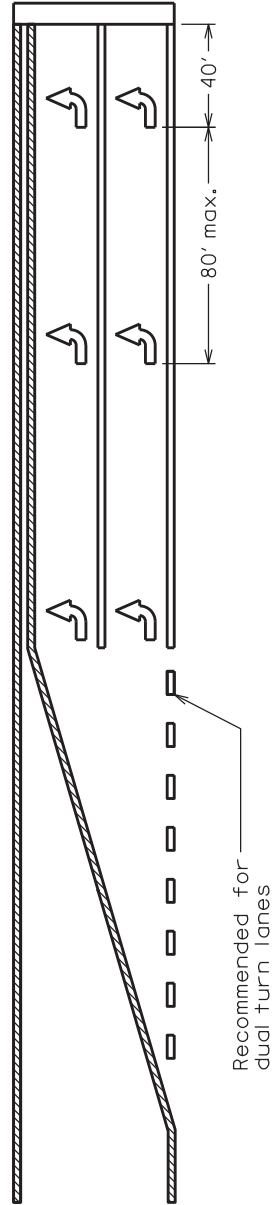

Offset turn lane

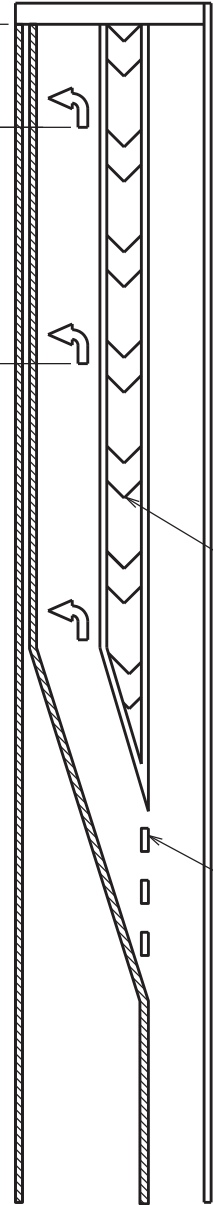

Chevron markings shall be used for offsets greater than 6'. Follow crosshatching guidelines shown in Sepia 046 for dimensions and spacing.

Optional for offset left-turn lanes

SHEET	COUNTY OF	ITEM NO.

LANE_DROP_MARKINGS_NOTES:

- IN SITUATIONS WHERE A THROUGH LANE BECOMES A MANDATORY TURN LANE, THE FOLLOWING GUIDELINES APPLY:
- A WIDE SOLID LINE SHOULD EXTEND BACK A MINIMUM OF 200' FROM THE STOP BAR.
- A WIDE, DOTTED LINE SHALL EXTEND FROM THE END OF THE SOLID LINE BACK A MINIMUM OF THE DISTANCE SHOWN IN THE CHART (A). THESE LINES SHALL BE 3' LONG, WITH A SPACE OF 9' BETWEEN LINES.
- ALTERNATING ARROWS AND "ONLY" WORD MESSAGES SHALL BE USED, WITH THE FIRST AND LAST MARKING BEING AN ARROW.
- ALTERNATING ARROWS AND "ONLY" WORD MESSAGES SHOULD BE SPACED EVENLY, FOLLOWING GUIDELINES FOR ARROW SPACING.
- THESE SYMBOLS SHALL EXTEND BACK AT LEAST TO THE END OF THE SOLID STRIPE, BUT MAY BE EXTENDED BACK FARTHER IF ADDITIONAL GUIDANCE IS NEEDED.

TWO-WAY LEFT-TURN LANE NOTES:

- IN A TWO-WAY LEFT-TURN LANE, THE FOLLOWING GUIDELINES APPLY:
- ONE SET OF ARROWS SHOULD BE PLACED AT OR NEAR THE BEGINNING OF THE TWO-WAY LEFT-TURN LANE.
- ADDITIONAL SETS OF ARROWS SHOULD BE PLACED THROUGHOUT THE TWO-WAY LEFT-TURN LANE IF LEFT TURN MOVEMENTS ARE EXPECTED. THEY SHOULD BE SPACED NO LESS THAN 300' AND NO MORE THAN 1/2 MILE.
- THE SPACING BETWEEN EACH ARROW IN A SINGLE ARROW SET SHOULD BE 16 FEET.
- TWO-WAY LEFT-TURN LANES SHALL TERMINATE IN A DEDICATED LEFT-TURN LANE AT A SIGNALIZED INTERSECTION. THEY MAY TERMINATE IN A DEDICATED LEFT-TURN LANE AT OTHER LOCATIONS IF DEEMED NECESSARY.
- CONTACT TRAFFIC ENGINEER FOR RECOMMENDED DISTANCE FOR LEFT TURN STORAGE AT INTERSECTIONS.
- REFER TO THE TRAFFIC OPERATIONS GUIDANCE MANUAL SECTION TO-504 FOR MORE GUIDANCE ON TWO-WAY LEFT-TURN LANES.

Lane drop scenario

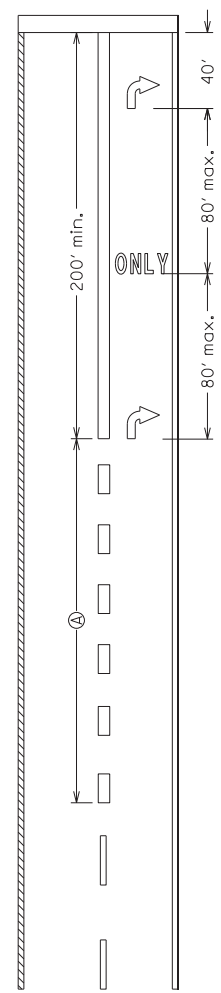

Speed Limit	(A)
25	125'
35	245'
45	540'
55	660'
65	780'

WIDE DOTTED LANE LINE DIMENSIONS:

3' → [] → 9' [] →

Dotted lane lines shall be twice the normal width in lane drop scenarios.

Two-way left-turn lane

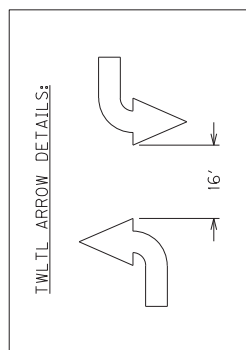
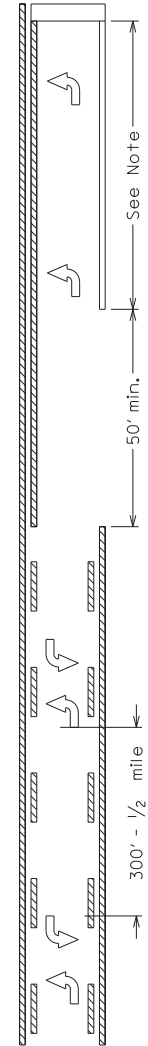

DRAWING NOT TO SCALE

LEGEND

MARKINGS	WHITE
[Hatched Box]	YELLOW

KENTUCKY DEPARTMENT OF HIGHWAYS

TYPICAL MARKINGS FOR TURN LANES

SUBMITTED: *R. Offenberg* 4-22-19 DATE 043

SHEET NO.	ITEM NO.	COUNTY OF
-----------	----------	-----------

STOP LINE NOTES

1. STOP LINES SHALL BE 24" WHITE AND SHALL EXTEND ACROSS ALL APPROACH LANES.
2. STOP LINES SHOULD BE PLACED A MINIMUM OF 4' IN ADVANCE OF THE NEAREST EDGE OF A MARKED CROSSWALK. IN THE ABSENCE OF A MARKED CROSSWALK, STOP LINES SHOULD BE PLACED NO MORE THAN 30' OR NO LESS THAN 4' FROM THE NEAREST EDGE OF THE INTERSECTING ROADWAY.
3. STOP LINES IN LEFT TURN LANES MAY BE PULLED BACK SO AS NOT TO INTERFERE WITH THE WHEEL PATH OF TURNING VEHICLES.

CROSSWALK DETAIL

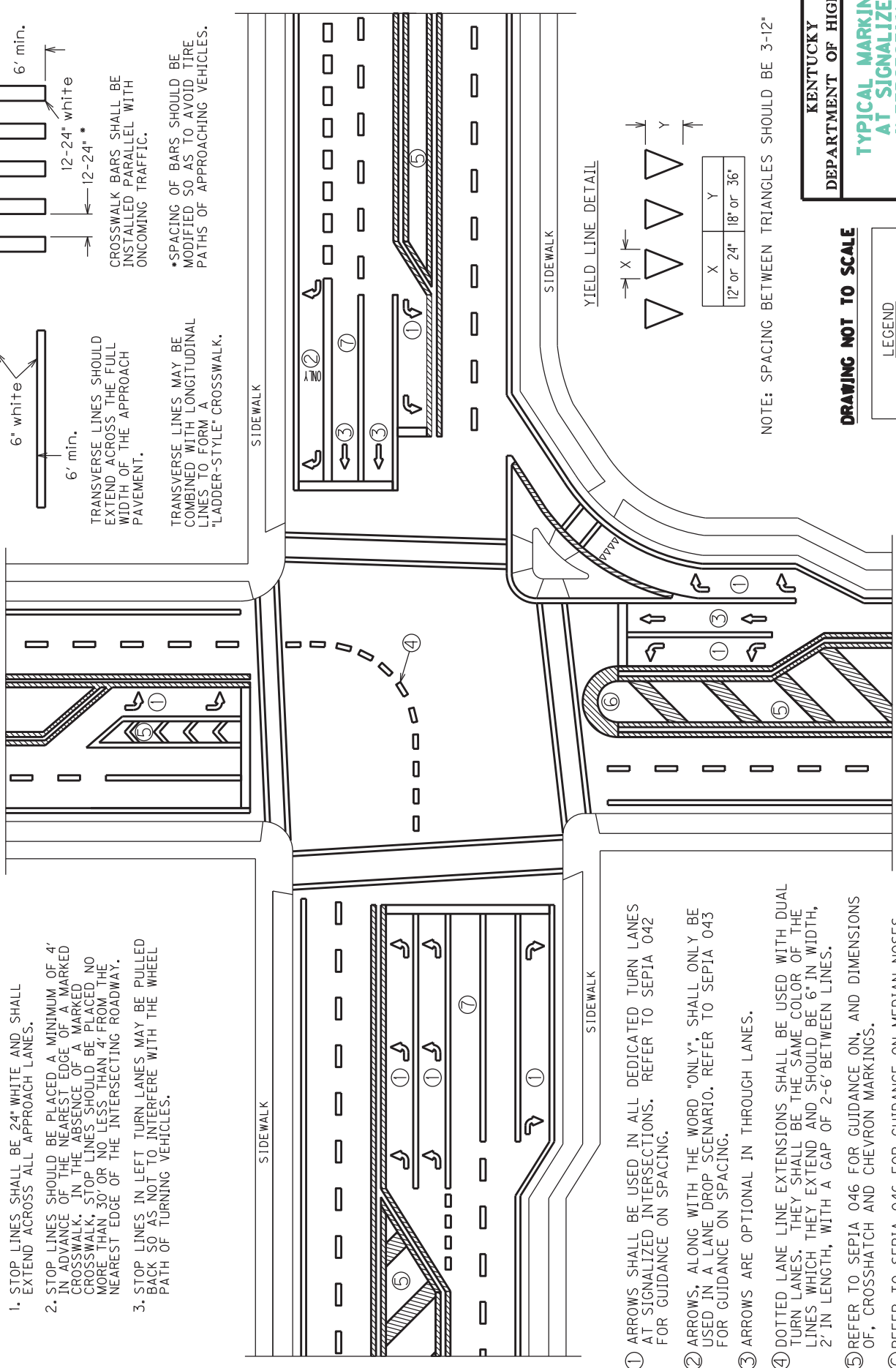
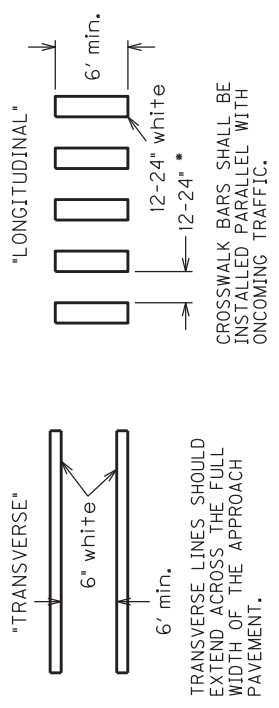

- ① ARROWS SHALL BE USED IN ALL DEDICATED TURN LANES AT SIGNALIZED INTERSECTIONS. REFER TO SEPIA 042 FOR GUIDANCE ON SPACING.
- ② ARROWS, ALONG WITH THE WORD "ONLY", SHALL ONLY BE USED IN A LANE DROP SCENARIO. REFER TO SEPIA 043 FOR GUIDANCE ON SPACING.
- ③ ARROWS ARE OPTIONAL IN THROUGH LANES.
- ④ DOTTED LANE LINE EXTENSIONS SHALL BE USED WITH DUAL TURN LANES. THEY SHALL BE THE SAME COLOR OF THE LINES WHICH THEY EXTEND AND SHOULD BE 6" IN WIDTH, 2-IN LENGTH, WITH A GAP OF 2-6' BETWEEN LINES.
- ⑤ REFER TO SEPIA 046 FOR GUIDANCE ON, AND DIMENSIONS OF, CROSSHATCH AND CHEVRON MARKINGS.
- ⑥ REFER TO SEPIA 046 FOR GUIDANCE ON MEDIAN NOSES.
- ⑦ SOLID LINE SEPARATING THROUGH LANES SHOULD EXTEND BACK A MINIMUM OF 50' FROM THE STOP BAR.

*NOTE: OTHER THAN LONGITUDINAL STRIPING, ALL MARKINGS SHOWN ON THIS DRAWING SHOULD BE THERMOPLASTIC.

DRAWING NOT TO SCALE

LEGEND	
MARKINGS	
WHITE	▭
YELLOW	▨

KENTUCKY
DEPARTMENT OF HIGHWAYS

TYPICAL MARKINGS AT SIGNALIZED INTERSECTIONS

SUBMITTED *R. [Signature]* DATE **11-30-18**

046

COUNTY OF	ITEM NO.	SHEET NO.

TYPICAL EXIT RAMP GORE MARKINGS

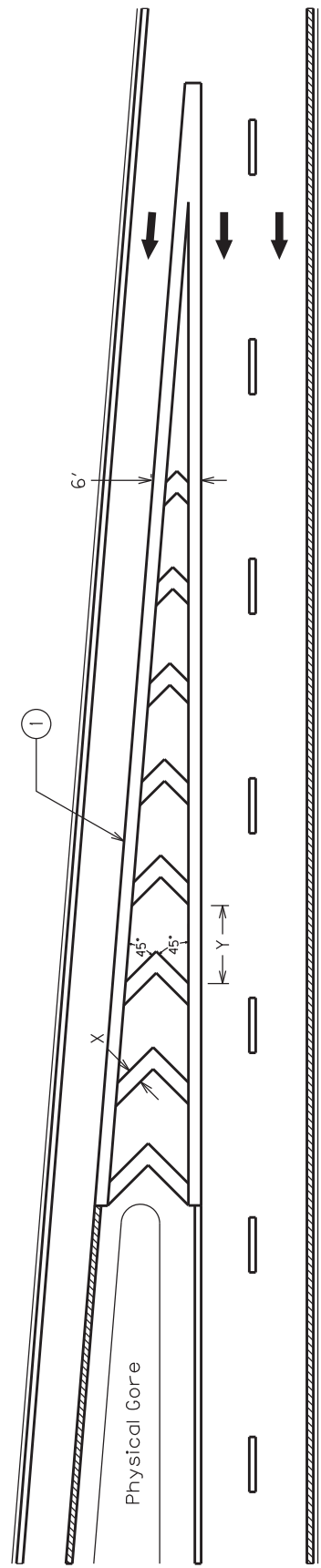

TYPICAL ENTRANCE RAMP GORE MARKINGS

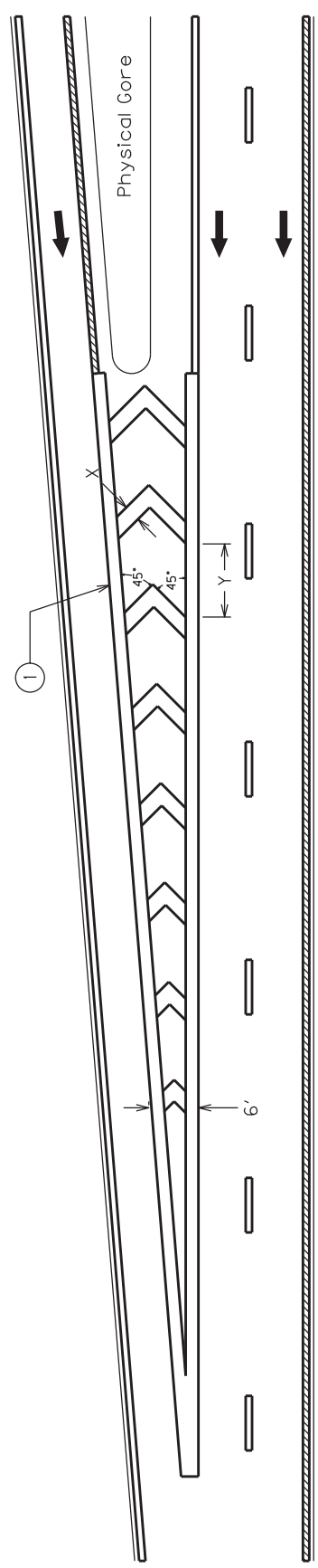

- 1 12" SOLID WHITE LINE TO BE INSTALLED AS SHOWN. THIS LINE SHOULD TERMINATE AT THE PHYSICAL GORE.
- 2 CHEVRON MARKINGS SHOULD BEGIN WHEN THE 12" WHITE CHANNELIZING LINES ARE APPROXIMATELY 6' APART.
- 3 A MINIMUM OF THREE CHEVRON MARKINGS SHOULD BE USED. IF AT LEAST THREE MARKINGS WILL NOT FIT INTO THE GORE AREA, NO CHEVRON MARKINGS SHOULD BE PLACED.
- 4 THE MINIMUM CHEVRON MARKING WIDTH (X) SHOULD BE 2'. THE MINIMUM SPACING BETWEEN CHEVRON MARKINGS (Y) SHOULD BE 20'. THESE DIMENSIONS MAY BE INCREASED. FOR EACH ADDITIONAL 1' OF WIDTH (X), INCREASE THE SPACING (Y) BY 10'.
- 5 GORE AREA CHEVRON MARKINGS SHALL BE THERMOPLASTIC.

DRAWING NOT TO SCALE

LEGEND	
MARKINGS	
	WHITE
	YELLOW

KENTUCKY
DEPARTMENT OF HIGHWAYS

TYPICAL MARKINGS FOR GORE AREAS

SUBMITTED: *R. [Signature]* 11-30-18 DATE **045**

COUNTY OF	ITEM NO.	SHEET NO.

TYPICAL RIGHT-TURN CHANNELIZING ISLAND MARKINGS

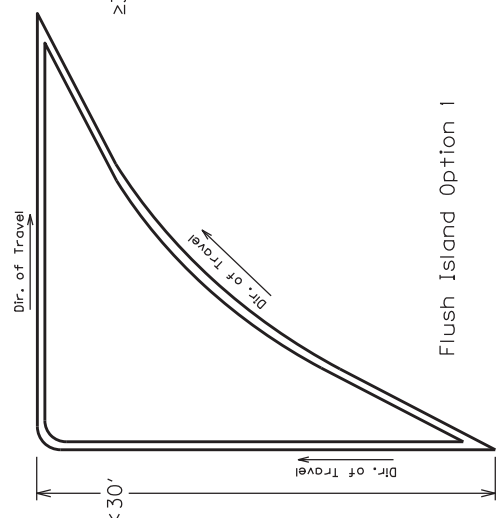

Flush Island Option 1

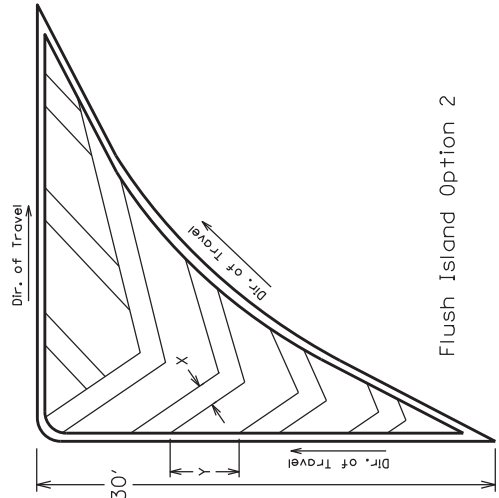

Flush Island Option 2

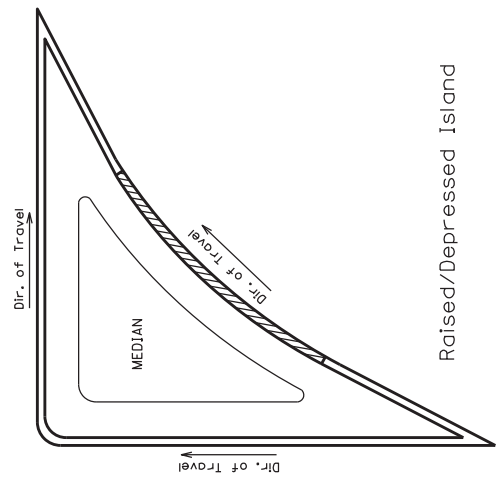

Raised/Depressed Island

GENERAL NOTES

- THE MINIMUM WIDTH (X) OF CROSSHATCH MARKINGS IS 12" FOR LOW SPEED ROADS (<math>< 45\text{ MPH}</math>) AND 24" FOR HIGH SPEED ROADS ($\ge 45\text{ MPH}$).
- THE SPACE BETWEEN ADJACENT CROSSHATCH MARKINGS (Y) SHOULD BE SET AT 10 TIMES THE WIDTH (X) OF THE CROSSHATCH MARKINGS.
- CROSSHATCH MARKINGS SHOULD NOT BE PLACED IN A MEDIAN LESS THAN 6' IN WIDTH.
- CROSSHATCH MARKINGS SHOULD NOT BE PLACED IN AND ISLAND IF ANY SIDE OF AN ISLAND IS LESS THAN 30' IN LENGTH.
- THE OUTLINE OF AN ISLAND SHOULD BE EITHER 8" OR 12".
- MEDIAN NOSES MAY BE EITHER A SINGLE 12" LINE OR A SOLID SEMI-CIRCLE.
- CROSSHATCH AND CHEVRON MARKINGS SHOULD BE THERMOPLASTIC.

TYPICAL LEFT-TURN LANE / FLUSH MEDIAN CROSSHATCH MARKINGS

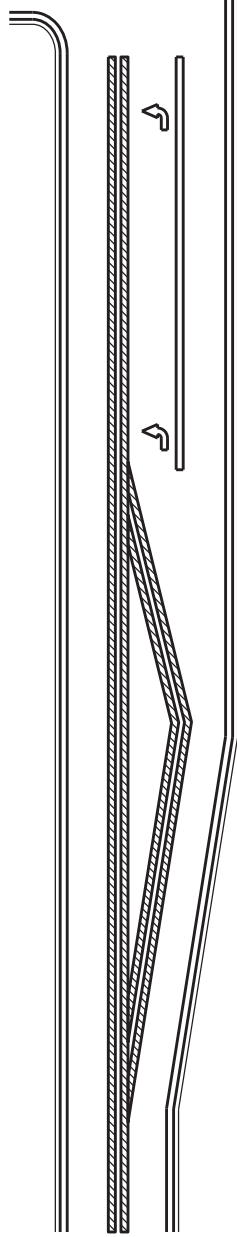

TYPICAL TWO-WAY LEFT-TURN LANE (TWLTL) TRANSITION MARKINGS

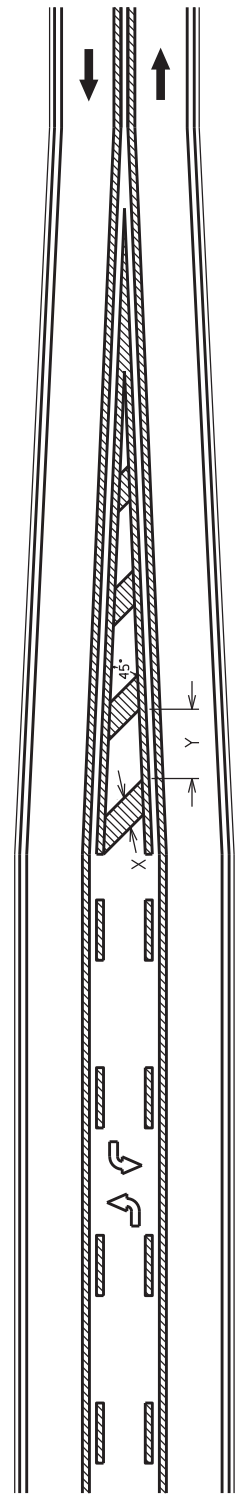

LEGEND

MARKINGS	WHITE
	YELLOW

DRAWING NOT TO SCALE

KENTUCKY
DEPARTMENT OF HIGHWAYS
**TYPICAL MARKINGS
FOR ISLANDS
AND MEDIANS**

Note: Crosshatch markings shall be placed in the transition area of a TWLTL.

SUBMITTED: *R. [Signature]* DATE: 11-30-18
046

PART III

EMPLOYMENT, WAGE AND RECORD REQUIREMENTS

FHWA-1273 -- Revised May 1, 2012

**REQUIRED CONTRACT PROVISIONS
FEDERAL-AID CONSTRUCTION CONTRACTS**

- I. General
- II. Nondiscrimination
- III. Nonsegregated Facilities
- IV. Davis-Bacon and Related Act Provisions
- V. Contract Work Hours and Safety Standards Act Provisions
- VI. Subletting or Assigning the Contract
- VII. Safety: Accident Prevention
- VIII. False Statements Concerning Highway Projects
- IX. Implementation of Clean Air Act and Federal Water Pollution Control Act
- X. Compliance with Governmentwide Suspension and Debarment Requirements
- XI. Certification Regarding Use of Contract Funds for Lobbying

ATTACHMENTS

A. Employment and Materials Preference for Appalachian Development Highway System or Appalachian Local Access Road Contracts (included in Appalachian contracts only)

I. GENERAL

1. Form FHWA-1273 must be physically incorporated in each construction contract funded under Title 23 (excluding emergency contracts solely intended for debris removal). The contractor (or subcontractor) must insert this form in each subcontract and further require its inclusion in all lower tier subcontracts (excluding purchase orders, rental agreements and other agreements for supplies or services).

The applicable requirements of Form FHWA-1273 are incorporated by reference for work done under any purchase order, rental agreement or agreement for other services. The prime contractor shall be responsible for compliance by any subcontractor, lower-tier subcontractor or service provider.

Form FHWA-1273 must be included in all Federal-aid design-build contracts, in all subcontracts and in lower tier subcontracts (excluding subcontracts for design services, purchase orders, rental agreements and other agreements for supplies or services). The design-builder shall be responsible for compliance by any subcontractor, lower-tier subcontractor or service provider.

Contracting agencies may reference Form FHWA-1273 in bid proposal or request for proposal documents, however, the Form FHWA-1273 must be physically incorporated (not referenced) in all contracts, subcontracts and lower-tier subcontracts (excluding purchase orders, rental agreements and other agreements for supplies or services related to a construction contract).

2. Subject to the applicability criteria noted in the following sections, these contract provisions shall apply to all work performed on the contract by the contractor's own organization and with the assistance of workers under the contractor's immediate superintendence and to all work performed on the contract by piecework, station work, or by subcontract.

3. A breach of any of the stipulations contained in these Required Contract Provisions may be sufficient grounds for withholding of progress payments, withholding of final payment, termination of the contract, suspension / debarment or any other action determined to be appropriate by the contracting agency and FHWA.

4. Selection of Labor: During the performance of this contract, the contractor shall not use convict labor for any purpose within the limits of a construction project on a Federal-aid highway unless it is labor performed by convicts who are on parole, supervised release, or probation. The term Federal-aid highway does not include roadways functionally classified as local roads or rural minor collectors.

II. NONDISCRIMINATION

The provisions of this section related to 23 CFR Part 230 are applicable to all Federal-aid construction contracts and to all related construction subcontracts of \$10,000 or more. The provisions of 23 CFR Part 230 are not applicable to material supply, engineering, or architectural service contracts.

In addition, the contractor and all subcontractors must comply with the following policies: Executive Order 11246, 41 CFR 60, 29 CFR 1625-1627, Title 23 USC Section 140, the Rehabilitation Act of 1973, as amended (29 USC 794), Title VI of the Civil Rights Act of 1964, as amended, and related regulations including 49 CFR Parts 21, 26 and 27; and 23 CFR Parts 200, 230, and 633.

The contractor and all subcontractors must comply with: the requirements of the Equal Opportunity Clause in 41 CFR 60-1.4(b) and, for all construction contracts exceeding \$10,000, the Standard Federal Equal Employment Opportunity Construction Contract Specifications in 41 CFR 60-4.3.

Note: The U.S. Department of Labor has exclusive authority to determine compliance with Executive Order 11246 and the policies of the Secretary of Labor including 41 CFR 60, and 29 CFR 1625-1627. The contracting agency and the FHWA have the authority and the responsibility to ensure compliance with Title 23 USC Section 140, the Rehabilitation Act of 1973, as amended (29 USC 794), and Title VI of the Civil Rights Act of 1964, as amended, and related regulations including 49 CFR Parts 21, 26 and 27; and 23 CFR Parts 200, 230, and 633.

The following provision is adopted from 23 CFR 230, Appendix A, with appropriate revisions to conform to the U.S. Department of Labor (US DOL) and FHWA requirements.

1. Equal Employment Opportunity: Equal employment opportunity (EEO) requirements not to discriminate and to take affirmative action to assure equal opportunity as set forth under laws, executive orders, rules, regulations (28 CFR 35, 29 CFR 1630, 29 CFR 1625-1627, 41 CFR 60 and 49 CFR 27) and orders of the Secretary of Labor as modified by the provisions prescribed herein, and imposed pursuant to 23 U.S.C. 140 shall constitute the EEO and specific affirmative action standards for the contractor's project activities under

this contract. The provisions of the Americans with Disabilities Act of 1990 (42 U.S.C. 12101 et seq.) set forth under 28 CFR 35 and 29 CFR 1630 are incorporated by reference in this contract. In the execution of this contract, the contractor agrees to comply with the following minimum specific requirement activities of EEO:

a. The contractor will work with the contracting agency and the Federal Government to ensure that it has made every good faith effort to provide equal opportunity with respect to all of its terms and conditions of employment and in their review of activities under the contract.

b. The contractor will accept as its operating policy the following statement:

"It is the policy of this Company to assure that applicants are employed, and that employees are treated during employment, without regard to their race, religion, sex, color, national origin, age or disability. Such action shall include: employment, upgrading, demotion, or transfer; recruitment or recruitment advertising; layoff or termination; rates of pay or other forms of compensation; and selection for training, including apprenticeship, pre-apprenticeship, and/or on-the-job training."

2. EEO Officer: The contractor will designate and make known to the contracting officers an EEO Officer who will have the responsibility for and must be capable of effectively administering and promoting an active EEO program and who must be assigned adequate authority and responsibility to do so.

3. Dissemination of Policy: All members of the contractor's staff who are authorized to hire, supervise, promote, and discharge employees, or who recommend such action, or who are substantially involved in such action, will be made fully cognizant of, and will implement, the contractor's EEO policy and contractual responsibilities to provide EEO in each grade and classification of employment. To ensure that the above agreement will be met, the following actions will be taken as a minimum:

a. Periodic meetings of supervisory and personnel office employees will be conducted before the start of work and then not less often than once every six months, at which time the contractor's EEO policy and its implementation will be reviewed and explained. The meetings will be conducted by the EEO Officer.

b. All new supervisory or personnel office employees will be given a thorough indoctrination by the EEO Officer, covering all major aspects of the contractor's EEO obligations within thirty days following their reporting for duty with the contractor.

c. All personnel who are engaged in direct recruitment for the project will be instructed by the EEO Officer in the contractor's procedures for locating and hiring minorities and women.

d. Notices and posters setting forth the contractor's EEO policy will be placed in areas readily accessible to employees, applicants for employment and potential employees.

e. The contractor's EEO policy and the procedures to implement such policy will be brought to the attention of employees by means of meetings, employee handbooks, or other appropriate means.

4. Recruitment: When advertising for employees, the contractor will include in all advertisements for employees the notation: "An Equal Opportunity Employer." All such advertisements will be placed in publications having a large circulation among minorities and women in the area from which the project work force would normally be derived.

a. The contractor will, unless precluded by a valid bargaining agreement, conduct systematic and direct recruitment through public and private employee referral sources likely to yield qualified minorities and women. To meet this requirement, the contractor will identify sources of potential minority group employees, and establish with such identified sources procedures whereby minority and women applicants may be referred to the contractor for employment consideration.

b. In the event the contractor has a valid bargaining agreement providing for exclusive hiring hall referrals, the contractor is expected to observe the provisions of that agreement to the extent that the system meets the contractor's compliance with EEO contract provisions. Where implementation of such an agreement has the effect of discriminating against minorities or women, or obligates the contractor to do the same, such implementation violates Federal nondiscrimination provisions.

c. The contractor will encourage its present employees to refer minorities and women as applicants for employment. Information and procedures with regard to referring such applicants will be discussed with employees.

5. Personnel Actions: Wages, working conditions, and employee benefits shall be established and administered, and personnel actions of every type, including hiring, upgrading, promotion, transfer, demotion, layoff, and termination, shall be taken without regard to race, color, religion, sex, national origin, age or disability. The following procedures shall be followed:

a. The contractor will conduct periodic inspections of project sites to insure that working conditions and employee facilities do not indicate discriminatory treatment of project site personnel.

b. The contractor will periodically evaluate the spread of wages paid within each classification to determine any evidence of discriminatory wage practices.

c. The contractor will periodically review selected personnel actions in depth to determine whether there is evidence of discrimination. Where evidence is found, the contractor will promptly take corrective action. If the review indicates that the discrimination may extend beyond the actions reviewed, such corrective action shall include all affected persons.

d. The contractor will promptly investigate all complaints of alleged discrimination made to the contractor in connection with its obligations under this contract, will attempt to resolve such complaints, and will take appropriate corrective action within a reasonable time. If the investigation indicates that the discrimination may affect persons other than the complainant, such corrective action shall include such other persons. Upon completion of each investigation, the contractor will inform every complainant of all of their avenues of appeal.

6. Training and Promotion:

a. The contractor will assist in locating, qualifying, and increasing the skills of minorities and women who are

applicants for employment or current employees. Such efforts should be aimed at developing full journey level status employees in the type of trade or job classification involved.

b. Consistent with the contractor's work force requirements and as permissible under Federal and State regulations, the contractor shall make full use of training programs, i.e., apprenticeship, and on-the-job training programs for the geographical area of contract performance. In the event a special provision for training is provided under this contract, this subparagraph will be superseded as indicated in the special provision. The contracting agency may reserve training positions for persons who receive welfare assistance in accordance with 23 U.S.C. 140(a).

c. The contractor will advise employees and applicants for employment of available training programs and entrance requirements for each.

d. The contractor will periodically review the training and promotion potential of employees who are minorities and women and will encourage eligible employees to apply for such training and promotion.

7. Unions: If the contractor relies in whole or in part upon unions as a source of employees, the contractor will use good faith efforts to obtain the cooperation of such unions to increase opportunities for minorities and women. Actions by the contractor, either directly or through a contractor's association acting as agent, will include the procedures set forth below:

a. The contractor will use good faith efforts to develop, in cooperation with the unions, joint training programs aimed toward qualifying more minorities and women for membership in the unions and increasing the skills of minorities and women so that they may qualify for higher paying employment.

b. The contractor will use good faith efforts to incorporate an EEO clause into each union agreement to the end that such union will be contractually bound to refer applicants without regard to their race, color, religion, sex, national origin, age or disability.

c. The contractor is to obtain information as to the referral practices and policies of the labor union except that to the extent such information is within the exclusive possession of the labor union and such labor union refuses to furnish such information to the contractor, the contractor shall so certify to the contracting agency and shall set forth what efforts have been made to obtain such information.

d. In the event the union is unable to provide the contractor with a reasonable flow of referrals within the time limit set forth in the collective bargaining agreement, the contractor will, through independent recruitment efforts, fill the employment vacancies without regard to race, color, religion, sex, national origin, age or disability; making full efforts to obtain qualified and/or qualifiable minorities and women. The failure of a union to provide sufficient referrals (even though it is obligated to provide exclusive referrals under the terms of a collective bargaining agreement) does not relieve the contractor from the requirements of this paragraph. In the event the union referral practice prevents the contractor from meeting the obligations pursuant to Executive Order 11246, as amended, and these special provisions, such contractor shall immediately notify the contracting agency.

8. Reasonable Accommodation for Applicants / Employees with Disabilities: The contractor must be familiar

with the requirements for and comply with the Americans with Disabilities Act and all rules and regulations established there under. Employers must provide reasonable accommodation in all employment activities unless to do so would cause an undue hardship.

9. Selection of Subcontractors, Procurement of Materials and Leasing of Equipment: The contractor shall not discriminate on the grounds of race, color, religion, sex, national origin, age or disability in the selection and retention of subcontractors, including procurement of materials and leases of equipment. The contractor shall take all necessary and reasonable steps to ensure nondiscrimination in the administration of this contract.

a. The contractor shall notify all potential subcontractors and suppliers and lessors of their EEO obligations under this contract.

b. The contractor will use good faith efforts to ensure subcontractor compliance with their EEO obligations.

10. Assurance Required by 49 CFR 26.13(b):

a. The requirements of 49 CFR Part 26 and the State DOT's U.S. DOT-approved DBE program are incorporated by reference.

b. The contractor or subcontractor shall not discriminate on the basis of race, color, national origin, or sex in the performance of this contract. The contractor shall carry out applicable requirements of 49 CFR Part 26 in the award and administration of DOT-assisted contracts. Failure by the contractor to carry out these requirements is a material breach of this contract, which may result in the termination of this contract or such other remedy as the contracting agency deems appropriate.

11. Records and Reports: The contractor shall keep such records as necessary to document compliance with the EEO requirements. Such records shall be retained for a period of three years following the date of the final payment to the contractor for all contract work and shall be available at reasonable times and places for inspection by authorized representatives of the contracting agency and the FHWA.

a. The records kept by the contractor shall document the following:

(1) The number and work hours of minority and non-minority group members and women employed in each work classification on the project;

(2) The progress and efforts being made in cooperation with unions, when applicable, to increase employment opportunities for minorities and women; and

(3) The progress and efforts being made in locating, hiring, training, qualifying, and upgrading minorities and women;

b. The contractors and subcontractors will submit an annual report to the contracting agency each July for the duration of the project, indicating the number of minority, women, and non-minority group employees currently engaged in each work classification required by the contract work. This information is to be reported on [Form FHWA-1391](#). The staffing data should represent the project work force on board in all or any part of the last payroll period preceding the end of July. If on-the-job training is being required by special provision, the contractor

will be required to collect and report training data. The employment data should reflect the work force on board during all or any part of the last payroll period preceding the end of July.

III. NONSEGREGATED FACILITIES

This provision is applicable to all Federal-aid construction contracts and to all related construction subcontracts of \$10,000 or more.

The contractor must ensure that facilities provided for employees are provided in such a manner that segregation on the basis of race, color, religion, sex, or national origin cannot result. The contractor may neither require such segregated use by written or oral policies nor tolerate such use by employee custom. The contractor's obligation extends further to ensure that its employees are not assigned to perform their services at any location, under the contractor's control, where the facilities are segregated. The term "facilities" includes waiting rooms, work areas, restaurants and other eating areas, time clocks, restrooms, washrooms, locker rooms, and other storage or dressing areas, parking lots, drinking fountains, recreation or entertainment areas, transportation, and housing provided for employees. The contractor shall provide separate or single-user restrooms and necessary dressing or sleeping areas to assure privacy between sexes.

IV. DAVIS-BACON AND RELATED ACT PROVISIONS

This section is applicable to all Federal-aid construction projects exceeding \$2,000 and to all related subcontracts and lower-tier subcontracts (regardless of subcontract size). The requirements apply to all projects located within the right-of-way of a roadway that is functionally classified as Federal-aid highway. This excludes roadways functionally classified as local roads or rural minor collectors, which are exempt. Contracting agencies may elect to apply these requirements to other projects.

The following provisions are from the U.S. Department of Labor regulations in 29 CFR 5.5 "Contract provisions and related matters" with minor revisions to conform to the FHWA-1273 format and FHWA program requirements.

1. Minimum wages

a. All laborers and mechanics employed or working upon the site of the work, will be paid unconditionally and not less often than once a week, and without subsequent deduction or rebate on any account (except such payroll deductions as are permitted by regulations issued by the Secretary of Labor under the Copeland Act (29 CFR part 3)), the full amount of wages and bona fide fringe benefits (or cash equivalents thereof) due at time of payment computed at rates not less than those contained in the wage determination of the Secretary of Labor which is attached hereto and made a part hereof, regardless of any contractual relationship which may be alleged to exist between the contractor and such laborers and mechanics.

Contributions made or costs reasonably anticipated for bona fide fringe benefits under section 1(b)(2) of the Davis-Bacon Act on behalf of laborers or mechanics are considered wages paid to such laborers or mechanics, subject to the provisions

of paragraph 1.d. of this section; also, regular contributions made or costs incurred for more than a weekly period (but not less often than quarterly) under plans, funds, or programs which cover the particular weekly period, are deemed to be constructively made or incurred during such weekly period. Such laborers and mechanics shall be paid the appropriate wage rate and fringe benefits on the wage determination for the classification of work actually performed, without regard to skill, except as provided in 29 CFR 5.5(a)(4). Laborers or mechanics performing work in more than one classification may be compensated at the rate specified for each classification for the time actually worked therein: Provided, That the employer's payroll records accurately set forth the time spent in each classification in which work is performed. The wage determination (including any additional classification and wage rates conformed under paragraph 1.b. of this section) and the Davis-Bacon poster (WH-1321) shall be posted at all times by the contractor and its subcontractors at the site of the work in a prominent and accessible place where it can be easily seen by the workers.

b.(1) The contracting officer shall require that any class of laborers or mechanics, including helpers, which is not listed in the wage determination and which is to be employed under the contract shall be classified in conformance with the wage determination. The contracting officer shall approve an additional classification and wage rate and fringe benefits therefore only when the following criteria have been met:

(i) The work to be performed by the classification requested is not performed by a classification in the wage determination; and

(ii) The classification is utilized in the area by the construction industry; and

(iii) The proposed wage rate, including any bona fide fringe benefits, bears a reasonable relationship to the wage rates contained in the wage determination.

(2) If the contractor and the laborers and mechanics to be employed in the classification (if known), or their representatives, and the contracting officer agree on the classification and wage rate (including the amount designated for fringe benefits where appropriate), a report of the action taken shall be sent by the contracting officer to the Administrator of the Wage and Hour Division, Employment Standards Administration, U.S. Department of Labor, Washington, DC 20210. The Administrator, or an authorized representative, will approve, modify, or disapprove every additional classification action within 30 days of receipt and so advise the contracting officer or will notify the contracting officer within the 30-day period that additional time is necessary.

(3) In the event the contractor, the laborers or mechanics to be employed in the classification or their representatives, and the contracting officer do not agree on the proposed classification and wage rate (including the amount designated for fringe benefits, where appropriate), the contracting officer shall refer the questions, including the views of all interested parties and the recommendation of the contracting officer, to the Wage and Hour Administrator for determination. The Wage and Hour Administrator, or an authorized representative, will issue a determination within 30 days of receipt and so advise the contracting officer or

will notify the contracting officer within the 30-day period that additional time is necessary.

(4) The wage rate (including fringe benefits where appropriate) determined pursuant to paragraphs 1.b.(2) or 1.b.(3) of this section, shall be paid to all workers performing work in the classification under this contract from the first day on which work is performed in the classification.

c. Whenever the minimum wage rate prescribed in the contract for a class of laborers or mechanics includes a fringe benefit which is not expressed as an hourly rate, the contractor shall either pay the benefit as stated in the wage determination or shall pay another bona fide fringe benefit or an hourly cash equivalent thereof.

d. If the contractor does not make payments to a trustee or other third person, the contractor may consider as part of the wages of any laborer or mechanic the amount of any costs reasonably anticipated in providing bona fide fringe benefits under a plan or program. Provided, That the Secretary of Labor has found, upon the written request of the contractor, that the applicable standards of the Davis-Bacon Act have been met. The Secretary of Labor may require the contractor to set aside in a separate account assets for the meeting of obligations under the plan or program.

2. Withholding

The contracting agency shall upon its own action or upon written request of an authorized representative of the Department of Labor, withhold or cause to be withheld from the contractor under this contract, or any other Federal contract with the same prime contractor, or any other federally-assisted contract subject to Davis-Bacon prevailing wage requirements, which is held by the same prime contractor, so much of the accrued payments or advances as may be considered necessary to pay laborers and mechanics, including apprentices, trainees, and helpers, employed by the contractor or any subcontractor the full amount of wages required by the contract. In the event of failure to pay any laborer or mechanic, including any apprentice, trainee, or helper, employed or working on the site of the work, all or part of the wages required by the contract, the contracting agency may, after written notice to the contractor, take such action as may be necessary to cause the suspension of any further payment, advance, or guarantee of funds until such violations have ceased.

3. Payrolls and basic records

a. Payrolls and basic records relating thereto shall be maintained by the contractor during the course of the work and preserved for a period of three years thereafter for all laborers and mechanics working at the site of the work. Such records shall contain the name, address, and social security number of each such worker, his or her correct classification, hourly rates of wages paid (including rates of contributions or costs anticipated for bona fide fringe benefits or cash equivalents thereof of the types described in section 1(b)(2)(B) of the Davis-Bacon Act), daily and weekly number of hours worked, deductions made and actual wages paid. Whenever the Secretary of Labor has found under 29 CFR 5.5(a)(1)(iv) that the wages of any laborer or mechanic include the amount of any costs reasonably anticipated in providing benefits under a plan or program described in section 1(b)(2)(B) of the Davis-

Bacon Act, the contractor shall maintain records which show that the commitment to provide such benefits is enforceable, that the plan or program is financially responsible, and that the plan or program has been communicated in writing to the laborers or mechanics affected, and records which show the costs anticipated or the actual cost incurred in providing such benefits. Contractors employing apprentices or trainees under approved programs shall maintain written evidence of the registration of apprenticeship programs and certification of trainee programs, the registration of the apprentices and trainees, and the ratios and wage rates prescribed in the applicable programs.

b.(1) The contractor shall submit weekly for each week in which any contract work is performed a copy of all payrolls to the contracting agency. The payrolls submitted shall set out accurately and completely all of the information required to be maintained under 29 CFR 5.5(a)(3)(i), except that full social security numbers and home addresses shall not be included on weekly transmittals. Instead the payrolls shall only need to include an individually identifying number for each employee (e.g., the last four digits of the employee's social security number). The required weekly payroll information may be submitted in any form desired. Optional Form WH-347 is available for this purpose from the Wage and Hour Division Web site at <http://www.dol.gov/esa/whd/forms/wh347instr.htm> or its successor site. The prime contractor is responsible for the submission of copies of payrolls by all subcontractors. Contractors and subcontractors shall maintain the full social security number and current address of each covered worker, and shall provide them upon request to the contracting agency for transmission to the State DOT, the FHWA or the Wage and Hour Division of the Department of Labor for purposes of an investigation or audit of compliance with prevailing wage requirements. It is not a violation of this section for a prime contractor to require a subcontractor to provide addresses and social security numbers to the prime contractor for its own records, without weekly submission to the contracting agency..

(2) Each payroll submitted shall be accompanied by a "Statement of Compliance," signed by the contractor or subcontractor or his or her agent who pays or supervises the payment of the persons employed under the contract and shall certify the following:

(i) That the payroll for the payroll period contains the information required to be provided under §5.5 (a)(3)(ii) of Regulations, 29 CFR part 5, the appropriate information is being maintained under §5.5 (a)(3)(i) of Regulations, 29 CFR part 5, and that such information is correct and complete;

(ii) That each laborer or mechanic (including each helper, apprentice, and trainee) employed on the contract during the payroll period has been paid the full weekly wages earned, without rebate, either directly or indirectly, and that no deductions have been made either directly or indirectly from the full wages earned, other than permissible deductions as set forth in Regulations, 29 CFR part 3;

(iii) That each laborer or mechanic has been paid not less than the applicable wage rates and fringe benefits or cash equivalents for the classification of work performed, as specified in the applicable wage determination incorporated into the contract.

(3) The weekly submission of a properly executed certification set forth on the reverse side of Optional Form WH-347 shall satisfy the requirement for submission of the "Statement of Compliance" required by paragraph 3.b.(2) of this section.

(4) The falsification of any of the above certifications may subject the contractor or subcontractor to civil or criminal prosecution under section 1001 of title 18 and section 231 of title 31 of the United States Code.

c. The contractor or subcontractor shall make the records required under paragraph 3.a. of this section available for inspection, copying, or transcription by authorized representatives of the contracting agency, the State DOT, the FHWA, or the Department of Labor, and shall permit such representatives to interview employees during working hours on the job. If the contractor or subcontractor fails to submit the required records or to make them available, the FHWA may, after written notice to the contractor, the contracting agency or the State DOT, take such action as may be necessary to cause the suspension of any further payment, advance, or guarantee of funds. Furthermore, failure to submit the required records upon request or to make such records available may be grounds for debarment action pursuant to 29 CFR 5.12.

4. Apprentices and trainees

a. Apprentices (programs of the USDOL).

Apprentices will be permitted to work at less than the predetermined rate for the work they performed when they are employed pursuant to and individually registered in a bona fide apprenticeship program registered with the U.S. Department of Labor, Employment and Training Administration, Office of Apprenticeship Training, Employer and Labor Services, or with a State Apprenticeship Agency recognized by the Office, or if a person is employed in his or her first 90 days of probationary employment as an apprentice in such an apprenticeship program, who is not individually registered in the program, but who has been certified by the Office of Apprenticeship Training, Employer and Labor Services or a State Apprenticeship Agency (where appropriate) to be eligible for probationary employment as an apprentice.

The allowable ratio of apprentices to journeymen on the job site in any craft classification shall not be greater than the ratio permitted to the contractor as to the entire work force under the registered program. Any worker listed on a payroll at an apprentice wage rate, who is not registered or otherwise employed as stated above, shall be paid not less than the applicable wage rate on the wage determination for the classification of work actually performed. In addition, any apprentice performing work on the job site in excess of the ratio permitted under the registered program shall be paid not less than the applicable wage rate on the wage determination for the work actually performed. Where a contractor is performing construction on a project in a locality other than that in which its program is registered, the ratios and wage rates (expressed in percentages of the journeyman's hourly rate) specified in the contractor's or subcontractor's registered program shall be observed.

Every apprentice must be paid at not less than the rate specified in the registered program for the apprentice's level of progress, expressed as a percentage of the journeymen hourly

rate specified in the applicable wage determination. Apprentices shall be paid fringe benefits in accordance with the provisions of the apprenticeship program. If the apprenticeship program does not specify fringe benefits, apprentices must be paid the full amount of fringe benefits listed on the wage determination for the applicable classification. If the Administrator determines that a different practice prevails for the applicable apprentice classification, fringes shall be paid in accordance with that determination.

In the event the Office of Apprenticeship Training, Employer and Labor Services, or a State Apprenticeship Agency recognized by the Office, withdraws approval of an apprenticeship program, the contractor will no longer be permitted to utilize apprentices at less than the applicable predetermined rate for the work performed until an acceptable program is approved.

b. Trainees (programs of the USDOL).

Except as provided in 29 CFR 5.16, trainees will not be permitted to work at less than the predetermined rate for the work performed unless they are employed pursuant to and individually registered in a program which has received prior approval, evidenced by formal certification by the U.S. Department of Labor, Employment and Training Administration.

The ratio of trainees to journeymen on the job site shall not be greater than permitted under the plan approved by the Employment and Training Administration.

Every trainee must be paid at not less than the rate specified in the approved program for the trainee's level of progress, expressed as a percentage of the journeyman hourly rate specified in the applicable wage determination. Trainees shall be paid fringe benefits in accordance with the provisions of the trainee program. If the trainee program does not mention fringe benefits, trainees shall be paid the full amount of fringe benefits listed on the wage determination unless the Administrator of the Wage and Hour Division determines that there is an apprenticeship program associated with the corresponding journeyman wage rate on the wage determination which provides for less than full fringe benefits for apprentices. Any employee listed on the payroll at a trainee rate who is not registered and participating in a training plan approved by the Employment and Training Administration shall be paid not less than the applicable wage rate on the wage determination for the classification of work actually performed. In addition, any trainee performing work on the job site in excess of the ratio permitted under the registered program shall be paid not less than the applicable wage rate on the wage determination for the work actually performed.

In the event the Employment and Training Administration withdraws approval of a training program, the contractor will no longer be permitted to utilize trainees at less than the applicable predetermined rate for the work performed until an acceptable program is approved.

c. Equal employment opportunity. The utilization of apprentices, trainees and journeymen under this part shall be in conformity with the equal employment opportunity requirements of Executive Order 11246, as amended, and 29 CFR part 30.

d. Apprentices and Trainees (programs of the U.S. DOT).

Apprentices and trainees working under apprenticeship and skill training programs which have been certified by the Secretary of Transportation as promoting EEO in connection with Federal-aid highway construction programs are not subject to the requirements of paragraph 4 of this Section IV. The straight time hourly wage rates for apprentices and trainees under such programs will be established by the particular programs. The ratio of apprentices and trainees to journeymen shall not be greater than permitted by the terms of the particular program.

5. Compliance with Copeland Act requirements. The contractor shall comply with the requirements of 29 CFR part 3, which are incorporated by reference in this contract.

6. Subcontracts. The contractor or subcontractor shall insert Form FHWA-1273 in any subcontracts and also require the subcontractors to include Form FHWA-1273 in any lower tier subcontracts. The prime contractor shall be responsible for the compliance by any subcontractor or lower tier subcontractor with all the contract clauses in 29 CFR 5.5.

7. Contract termination: debarment. A breach of the contract clauses in 29 CFR 5.5 may be grounds for termination of the contract, and for debarment as a contractor and a subcontractor as provided in 29 CFR 5.12.

8. Compliance with Davis-Bacon and Related Act requirements. All rulings and interpretations of the Davis-Bacon and Related Acts contained in 29 CFR parts 1, 3, and 5 are herein incorporated by reference in this contract.

9. Disputes concerning labor standards. Disputes arising out of the labor standards provisions of this contract shall not be subject to the general disputes clause of this contract. Such disputes shall be resolved in accordance with the procedures of the Department of Labor set forth in 29 CFR parts 5, 6, and 7. Disputes within the meaning of this clause include disputes between the contractor (or any of its subcontractors) and the contracting agency, the U.S. Department of Labor, or the employees or their representatives.

10. Certification of eligibility.

a. By entering into this contract, the contractor certifies that neither it (nor he or she) nor any person or firm who has an interest in the contractor's firm is a person or firm ineligible to be awarded Government contracts by virtue of section 3(a) of the Davis-Bacon Act or 29 CFR 5.12(a)(1).

b. No part of this contract shall be subcontracted to any person or firm ineligible for award of a Government contract by virtue of section 3(a) of the Davis-Bacon Act or 29 CFR 5.12(a)(1).

c. The penalty for making false statements is prescribed in the U.S. Criminal Code, 18 U.S.C. 1001.

V. CONTRACT WORK HOURS AND SAFETY STANDARDS ACT

The following clauses apply to any Federal-aid construction contract in an amount in excess of \$100,000 and subject to the overtime provisions of the Contract Work Hours and Safety Standards Act. These clauses shall be inserted in addition to the clauses required by 29 CFR 5.5(a) or 29 CFR 4.6. As used in this paragraph, the terms laborers and mechanics include watchmen and guards.

1. Overtime requirements. No contractor or subcontractor contracting for any part of the contract work which may require or involve the employment of laborers or mechanics shall require or permit any such laborer or mechanic in any workweek in which he or she is employed on such work to work in excess of forty hours in such workweek unless such laborer or mechanic receives compensation at a rate not less than one and one-half times the basic rate of pay for all hours worked in excess of forty hours in such workweek.

2. Violation; liability for unpaid wages; liquidated damages. In the event of any violation of the clause set forth in paragraph (1.) of this section, the contractor and any subcontractor responsible therefor shall be liable for the unpaid wages. In addition, such contractor and subcontractor shall be liable to the United States (in the case of work done under contract for the District of Columbia or a territory, to such District or to such territory), for liquidated damages. Such liquidated damages shall be computed with respect to each individual laborer or mechanic, including watchmen and guards, employed in violation of the clause set forth in paragraph (1.) of this section, in the sum of \$10 for each calendar day on which such individual was required or permitted to work in excess of the standard workweek of forty hours without payment of the overtime wages required by the clause set forth in paragraph (1.) of this section.

3. Withholding for unpaid wages and liquidated damages. The FHWA or the contracting agency shall upon its own action or upon written request of an authorized representative of the Department of Labor withhold or cause to be withheld, from any moneys payable on account of work performed by the contractor or subcontractor under any such contract or any other Federal contract with the same prime contractor, or any other federally-assisted contract subject to the Contract Work Hours and Safety Standards Act, which is held by the same prime contractor, such sums as may be determined to be necessary to satisfy any liabilities of such contractor or subcontractor for unpaid wages and liquidated damages as provided in the clause set forth in paragraph (2.) of this section.

4. Subcontracts. The contractor or subcontractor shall insert in any subcontracts the clauses set forth in paragraph (1.) through (4.) of this section and also a clause requiring the subcontractors to include these clauses in any lower tier subcontracts. The prime contractor shall be responsible for compliance by any subcontractor or lower tier subcontractor with the clauses set forth in paragraphs (1.) through (4.) of this section.

VI. SUBLETTING OR ASSIGNING THE CONTRACT

This provision is applicable to all Federal-aid construction contracts on the National Highway System.

1. The contractor shall perform with its own organization contract work amounting to not less than 30 percent (or a greater percentage if specified elsewhere in the contract) of the total original contract price, excluding any specialty items designated by the contracting agency. Specialty items may be performed by subcontract and the amount of any such specialty items performed may be deducted from the total original contract price before computing the amount of work required to be performed by the contractor's own organization (23 CFR 635.116).

a. The term "perform work with its own organization" refers to workers employed or leased by the prime contractor, and equipment owned or rented by the prime contractor, with or without operators. Such term does not include employees or equipment of a subcontractor or lower tier subcontractor, agents of the prime contractor, or any other assignees. The term may include payments for the costs of hiring leased employees from an employee leasing firm meeting all relevant Federal and State regulatory requirements. Leased employees may only be included in this term if the prime contractor meets all of the following conditions:

- (1) the prime contractor maintains control over the supervision of the day-to-day activities of the leased employees;
- (2) the prime contractor remains responsible for the quality of the work of the leased employees;
- (3) the prime contractor retains all power to accept or exclude individual employees from work on the project; and
- (4) the prime contractor remains ultimately responsible for the payment of predetermined minimum wages, the submission of payrolls, statements of compliance and all other Federal regulatory requirements.

b. "Specialty Items" shall be construed to be limited to work that requires highly specialized knowledge, abilities, or equipment not ordinarily available in the type of contracting organizations qualified and expected to bid or propose on the contract as a whole and in general are to be limited to minor components of the overall contract.

2. The contract amount upon which the requirements set forth in paragraph (1) of Section VI is computed includes the cost of material and manufactured products which are to be purchased or produced by the contractor under the contract provisions.

3. The contractor shall furnish (a) a competent superintendent or supervisor who is employed by the firm, has full authority to direct performance of the work in accordance with the contract requirements, and is in charge of all construction operations (regardless of who performs the work) and (b) such other of its own organizational resources (supervision, management, and engineering services) as the contracting officer determines is necessary to assure the performance of the contract.

4. No portion of the contract shall be sublet, assigned or otherwise disposed of except with the written consent of the contracting officer, or authorized representative, and such consent when given shall not be construed to relieve the contractor of any responsibility for the fulfillment of the contract. Written consent will be given only after the contracting agency has assured that each subcontract is

evidenced in writing and that it contains all pertinent provisions and requirements of the prime contract.

5. The 30% self-performance requirement of paragraph (1) is not applicable to design-build contracts; however, contracting agencies may establish their own self-performance requirements.

VII. SAFETY: ACCIDENT PREVENTION

This provision is applicable to all Federal-aid construction contracts and to all related subcontracts.

1. In the performance of this contract the contractor shall comply with all applicable Federal, State, and local laws governing safety, health, and sanitation (23 CFR 635). The contractor shall provide all safeguards, safety devices and protective equipment and take any other needed actions as it determines, or as the contracting officer may determine, to be reasonably necessary to protect the life and health of employees on the job and the safety of the public and to protect property in connection with the performance of the work covered by the contract.

2. It is a condition of this contract, and shall be made a condition of each subcontract, which the contractor enters into pursuant to this contract, that the contractor and any subcontractor shall not permit any employee, in performance of the contract, to work in surroundings or under conditions which are unsanitary, hazardous or dangerous to his/her health or safety, as determined under construction safety and health standards (29 CFR 1926) promulgated by the Secretary of Labor, in accordance with Section 107 of the Contract Work Hours and Safety Standards Act (40 U.S.C. 3704).

3. Pursuant to 29 CFR 1926.3, it is a condition of this contract that the Secretary of Labor or authorized representative thereof, shall have right of entry to any site of contract performance to inspect or investigate the matter of compliance with the construction safety and health standards and to carry out the duties of the Secretary under Section 107 of the Contract Work Hours and Safety Standards Act (40 U.S.C.3704).

VIII. FALSE STATEMENTS CONCERNING HIGHWAY PROJECTS

This provision is applicable to all Federal-aid construction contracts and to all related subcontracts.

In order to assure high quality and durable construction in conformity with approved plans and specifications and a high degree of reliability on statements and representations made by engineers, contractors, suppliers, and workers on Federal-aid highway projects, it is essential that all persons concerned with the project perform their functions as carefully, thoroughly, and honestly as possible. Willful falsification, distortion, or misrepresentation with respect to any facts related to the project is a violation of Federal law. To prevent any misunderstanding regarding the seriousness of these and similar acts, Form FHWA-1022 shall be posted on each Federal-aid highway project (23 CFR 635) in one or more places where it is readily available to all persons concerned with the project:

18 U.S.C. 1020 reads as follows:

"Whoever, being an officer, agent, or employee of the United States, or of any State or Territory, or whoever, whether a person, association, firm, or corporation, knowingly makes any false statement, false representation, or false report as to the character, quality, quantity, or cost of the material used or to be used, or the quantity or quality of the work performed or to be performed, or the cost thereof in connection with the submission of plans, maps, specifications, contracts, or costs of construction on any highway or related project submitted for approval to the Secretary of Transportation; or

Whoever knowingly makes any false statement, false representation, false report or false claim with respect to the character, quality, quantity, or cost of any work performed or to be performed, or materials furnished or to be furnished, in connection with the construction of any highway or related project approved by the Secretary of Transportation; or

Whoever knowingly makes any false statement or false representation as to material fact in any statement, certificate, or report submitted pursuant to provisions of the Federal-aid Roads Act approved July 1, 1916, (39 Stat. 355), as amended and supplemented;

Shall be fined under this title or imprisoned not more than 5 years or both."

IX. IMPLEMENTATION OF CLEAN AIR ACT AND FEDERAL WATER POLLUTION CONTROL ACT

This provision is applicable to all Federal-aid construction contracts and to all related subcontracts.

By submission of this bid/proposal or the execution of this contract, or subcontract, as appropriate, the bidder, proposer, Federal-aid construction contractor, or subcontractor, as appropriate, will be deemed to have stipulated as follows:

1. That any person who is or will be utilized in the performance of this contract is not prohibited from receiving an award due to a violation of Section 508 of the Clean Water Act or Section 306 of the Clean Air Act.

2. That the contractor agrees to include or cause to be included the requirements of paragraph (1) of this Section X in every subcontract, and further agrees to take such action as the contracting agency may direct as a means of enforcing such requirements.

X. CERTIFICATION REGARDING DEBARMENT, SUSPENSION, INELIGIBILITY AND VOLUNTARY EXCLUSION

This provision is applicable to all Federal-aid construction contracts, design-build contracts, subcontracts, lower-tier subcontracts, purchase orders, lease agreements, consultant contracts or any other covered transaction requiring FHWA approval or that is estimated to cost \$25,000 or more – as defined in 2 CFR Parts 180 and 1200.

1. Instructions for Certification – First Tier Participants:

a. By signing and submitting this proposal, the prospective first tier participant is providing the certification set out below.

b. The inability of a person to provide the certification set out below will not necessarily result in denial of participation in this

covered transaction. The prospective first tier participant shall submit an explanation of why it cannot provide the certification set out below. The certification or explanation will be considered in connection with the department or agency's determination whether to enter into this transaction. However, failure of the prospective first tier participant to furnish a certification or an explanation shall disqualify such a person from participation in this transaction.

c. The certification in this clause is a material representation of fact upon which reliance was placed when the contracting agency determined to enter into this transaction. If it is later determined that the prospective participant knowingly rendered an erroneous certification, in addition to other remedies available to the Federal Government, the contracting agency may terminate this transaction for cause of default.

d. The prospective first tier participant shall provide immediate written notice to the contracting agency to whom this proposal is submitted if any time the prospective first tier participant learns that its certification was erroneous when submitted or has become erroneous by reason of changed circumstances.

e. The terms "covered transaction," "debarred," "suspended," "ineligible," "participant," "person," "principal," and "voluntarily excluded," as used in this clause, are defined in 2 CFR Parts 180 and 1200. "First Tier Covered Transactions" refers to any covered transaction between a grantee or subgrantee of Federal funds and a participant (such as the prime or general contract). "Lower Tier Covered Transactions" refers to any covered transaction under a First Tier Covered Transaction (such as subcontracts). "First Tier Participant" refers to the participant who has entered into a covered transaction with a grantee or subgrantee of Federal funds (such as the prime or general contractor). "Lower Tier Participant" refers any participant who has entered into a covered transaction with a First Tier Participant or other Lower Tier Participants (such as subcontractors and suppliers).

f. The prospective first tier participant agrees by submitting this proposal that, should the proposed covered transaction be entered into, it shall not knowingly enter into any lower tier covered transaction with a person who is debarred, suspended, declared ineligible, or voluntarily excluded from participation in this covered transaction, unless authorized by the department or agency entering into this transaction.

g. The prospective first tier participant further agrees by submitting this proposal that it will include the clause titled "Certification Regarding Debarment, Suspension, Ineligibility and Voluntary Exclusion-Lower Tier Covered Transactions," provided by the department or contracting agency, entering into this covered transaction, without modification, in all lower tier covered transactions and in all solicitations for lower tier covered transactions exceeding the \$25,000 threshold.

h. A participant in a covered transaction may rely upon a certification of a prospective participant in a lower tier covered transaction that is not debarred, suspended, ineligible, or voluntarily excluded from the covered transaction, unless it knows that the certification is erroneous. A participant is responsible for ensuring that its principals are not suspended, debarred, or otherwise ineligible to participate in covered transactions. To verify the eligibility of its principals, as well as the eligibility of any lower tier prospective participants, each participant may, but is not required to, check the Excluded Parties List System website (<https://www.epls.gov/>), which is compiled by the General Services Administration.

i. Nothing contained in the foregoing shall be construed to require the establishment of a system of records in order to render in good faith the certification required by this clause. The knowledge and information of the prospective participant is not required to exceed that which is normally possessed by a prudent person in the ordinary course of business dealings.

j. Except for transactions authorized under paragraph (f) of these instructions, if a participant in a covered transaction knowingly enters into a lower tier covered transaction with a person who is suspended, debarred, ineligible, or voluntarily excluded from participation in this transaction, in addition to other remedies available to the Federal Government, the department or agency may terminate this transaction for cause or default.

* * * * *

2. Certification Regarding Debarment, Suspension, Ineligibility and Voluntary Exclusion – First Tier Participants:

a. The prospective first tier participant certifies to the best of its knowledge and belief, that it and its principals:

(1) Are not presently debarred, suspended, proposed for debarment, declared ineligible, or voluntarily excluded from participating in covered transactions by any Federal department or agency;

(2) Have not within a three-year period preceding this proposal been convicted of or had a civil judgment rendered against them for commission of fraud or a criminal offense in connection with obtaining, attempting to obtain, or performing a public (Federal, State or local) transaction or contract under a public transaction; violation of Federal or State antitrust statutes or commission of embezzlement, theft, forgery, bribery, falsification or destruction of records, making false statements, or receiving stolen property;

(3) Are not presently indicted for or otherwise criminally or civilly charged by a governmental entity (Federal, State or local) with commission of any of the offenses enumerated in paragraph (a)(2) of this certification; and

(4) Have not within a three-year period preceding this application/proposal had one or more public transactions (Federal, State or local) terminated for cause or default.

b. Where the prospective participant is unable to certify to any of the statements in this certification, such prospective participant shall attach an explanation to this proposal.

2. Instructions for Certification - Lower Tier Participants:

(Applicable to all subcontracts, purchase orders and other lower tier transactions requiring prior FHWA approval or estimated to cost \$25,000 or more - 2 CFR Parts 180 and 1200)

a. By signing and submitting this proposal, the prospective lower tier is providing the certification set out below.

b. The certification in this clause is a material representation of fact upon which reliance was placed when this transaction was entered into. If it is later determined that the prospective lower tier participant knowingly rendered an erroneous certification, in addition to other remedies available to the Federal Government, the department, or agency with which

this transaction originated may pursue available remedies, including suspension and/or debarment.

c. The prospective lower tier participant shall provide immediate written notice to the person to which this proposal is submitted if at any time the prospective lower tier participant learns that its certification was erroneous by reason of changed circumstances.

d. The terms "covered transaction," "debarred," "suspended," "ineligible," "participant," "person," "principal," and "voluntarily excluded," as used in this clause, are defined in 2 CFR Parts 180 and 1200. You may contact the person to which this proposal is submitted for assistance in obtaining a copy of those regulations. "First Tier Covered Transactions" refers to any covered transaction between a grantee or subgrantee of Federal funds and a participant (such as the prime or general contract). "Lower Tier Covered Transactions" refers to any covered transaction under a First Tier Covered Transaction (such as subcontracts). "First Tier Participant" refers to the participant who has entered into a covered transaction with a grantee or subgrantee of Federal funds (such as the prime or general contractor). "Lower Tier Participant" refers any participant who has entered into a covered transaction with a First Tier Participant or other Lower Tier Participants (such as subcontractors and suppliers).

e. The prospective lower tier participant agrees by submitting this proposal that, should the proposed covered transaction be entered into, it shall not knowingly enter into any lower tier covered transaction with a person who is debarred, suspended, declared ineligible, or voluntarily excluded from participation in this covered transaction, unless authorized by the department or agency with which this transaction originated.

f. The prospective lower tier participant further agrees by submitting this proposal that it will include this clause titled "Certification Regarding Debarment, Suspension, Ineligibility and Voluntary Exclusion-Lower Tier Covered Transaction," without modification, in all lower tier covered transactions and in all solicitations for lower tier covered transactions exceeding the \$25,000 threshold.

g. A participant in a covered transaction may rely upon a certification of a prospective participant in a lower tier covered transaction that is not debarred, suspended, ineligible, or voluntarily excluded from the covered transaction, unless it knows that the certification is erroneous. A participant is responsible for ensuring that its principals are not suspended, debarred, or otherwise ineligible to participate in covered transactions. To verify the eligibility of its principals, as well as the eligibility of any lower tier prospective participants, each participant may, but is not required to, check the Excluded Parties List System website (<https://www.epls.gov/>), which is compiled by the General Services Administration.

h. Nothing contained in the foregoing shall be construed to require establishment of a system of records in order to render in good faith the certification required by this clause. The knowledge and information of participant is not required to exceed that which is normally possessed by a prudent person in the ordinary course of business dealings.

i. Except for transactions authorized under paragraph e of these instructions, if a participant in a covered transaction knowingly enters into a lower tier covered transaction with a person who is suspended, debarred, ineligible, or voluntarily excluded from participation in this transaction, in addition to other remedies available to the Federal Government, the

department or agency with which this transaction originated may pursue available remedies, including suspension and/or debarment.

* * * * *

Certification Regarding Debarment, Suspension, Ineligibility and Voluntary Exclusion--Lower Tier Participants:

1. The prospective lower tier participant certifies, by submission of this proposal, that neither it nor its principals is presently debarred, suspended, proposed for debarment, declared ineligible, or voluntarily excluded from participating in covered transactions by any Federal department or agency.

2. Where the prospective lower tier participant is unable to certify to any of the statements in this certification, such prospective participant shall attach an explanation to this proposal.

* * * * *

XI. CERTIFICATION REGARDING USE OF CONTRACT FUNDS FOR LOBBYING

This provision is applicable to all Federal-aid construction contracts and to all related subcontracts which exceed \$100,000 (49 CFR 20).

1. The prospective participant certifies, by signing and submitting this bid or proposal, to the best of his or her knowledge and belief, that:

a. No Federal appropriated funds have been paid or will be paid, by or on behalf of the undersigned, to any person for influencing or attempting to influence an officer or employee of any Federal agency, a Member of Congress, an officer or employee of Congress, or an employee of a Member of Congress in connection with the awarding of any Federal contract, the making of any Federal grant, the making of any Federal loan, the entering into of any cooperative agreement, and the extension, continuation, renewal, amendment, or modification of any Federal contract, grant, loan, or cooperative agreement.

b. If any funds other than Federal appropriated funds have been paid or will be paid to any person for influencing or attempting to influence an officer or employee of any Federal agency, a Member of Congress, an officer or employee of Congress, or an employee of a Member of Congress in connection with this Federal contract, grant, loan, or cooperative agreement, the undersigned shall complete and submit Standard Form-LLL, "Disclosure Form to Report Lobbying," in accordance with its instructions.

2. This certification is a material representation of fact upon which reliance was placed when this transaction was made or entered into. Submission of this certification is a prerequisite for making or entering into this transaction imposed by 31 U.S.C. 1352. Any person who fails to file the required certification shall be subject to a civil penalty of not less than \$10,000 and not more than \$100,000 for each such failure.

3. The prospective participant also agrees by submitting its bid or proposal that the participant shall require that the language of this certification be included in all lower tier subcontracts, which exceed \$100,000 and that all such recipients shall certify and disclose accordingly.

**ATTACHMENT A - EMPLOYMENT AND MATERIALS
PREFERENCE FOR APPALACHIAN DEVELOPMENT
HIGHWAY SYSTEM OR APPALACHIAN LOCAL ACCESS
ROAD CONTRACTS**

This provision is applicable to all Federal-aid projects funded under the Appalachian Regional Development Act of 1965.

1. During the performance of this contract, the contractor undertaking to do work which is, or reasonably may be, done as on-site work, shall give preference to qualified persons who regularly reside in the labor area as designated by the DOL wherein the contract work is situated, or the subregion, or the Appalachian counties of the State wherein the contract work is situated, except:

a. To the extent that qualified persons regularly residing in the area are not available.

b. For the reasonable needs of the contractor to employ supervisory or specially experienced personnel necessary to assure an efficient execution of the contract work.

c. For the obligation of the contractor to offer employment to present or former employees as the result of a lawful collective bargaining contract, provided that the number of nonresident persons employed under this subparagraph (1c) shall not exceed 20 percent of the total number of employees employed by the contractor on the contract work, except as provided in subparagraph (4) below.

2. The contractor shall place a job order with the State Employment Service indicating (a) the classifications of the laborers, mechanics and other employees required to perform the contract work, (b) the number of employees required in each classification, (c) the date on which the participant estimates such employees will be required, and (d) any other pertinent information required by the State Employment Service to complete the job order form. The job order may be placed with the State Employment Service in writing or by telephone. If during the course of the contract work, the information submitted by the contractor in the original job order is substantially modified, the participant shall promptly notify the State Employment Service.

3. The contractor shall give full consideration to all qualified job applicants referred to him by the State Employment Service. The contractor is not required to grant employment to any job applicants who, in his opinion, are not qualified to perform the classification of work required.

4. If, within one week following the placing of a job order by the contractor with the State Employment Service, the State Employment Service is unable to refer any qualified job applicants to the contractor, or less than the number requested, the State Employment Service will forward a certificate to the contractor indicating the unavailability of applicants. Such certificate shall be made a part of the contractor's permanent project records. Upon receipt of this certificate, the contractor may employ persons who do not normally reside in the labor area to fill positions covered by the certificate, notwithstanding the provisions of subparagraph (1c) above.

5. The provisions of 23 CFR 633.207(e) allow the contracting agency to provide a contractual preference for the use of mineral resource materials native to the Appalachian region.

6. The contractor shall include the provisions of Sections 1 through 4 of this Attachment A in every subcontract for work which is, or reasonably may be, done as on-site work.

**KENTUCKY TRANSPORTATION CABINET
DEPARTMENT OF HIGHWAYS**

**EMPLOYMENT REQUIREMENTS
RELATING TO
NONDISCRIMINATION OF EMPLOYEES
(APPLICABLE TO FEDERAL-AID SYSTEM CONTRACTS)**

**AN ACT OF THE KENTUCKY GENERAL ASSEMBLY
TO PREVENT DISCRIMINATION IN EMPLOYMENT**

**KRS CHAPTER 344
EFFECTIVE JUNE 16, 1972**

The contract on this project, in accordance with KRS Chapter 344, provides that during the performance of this contract, the contractor agrees as follows:

1. The contractor shall not fail or refuse to hire, or shall not discharge any individual, or otherwise discriminate against an individual with respect to his compensation, terms, conditions, or privileges of employment, because of such individual's race, color, religion, national origin, sex, disability or age (forty and above); or limit, segregate, or classify his employees in any way which would deprive or tend to deprive an individual of employment opportunities or otherwise adversely affect his status as an employee, because of such individual's race, color, religion, national origin, sex, disability or age forty (40) and over. The contractor agrees to post in conspicuous places, available to employees and applicants for employment, notices to be provided setting forth the provisions of this nondiscrimination clause.

2. The contractor shall not print or publish or cause to be printed or published a notice or advertisement relating to employment by such an employer or membership in or any classification or referral for employment by the employment agency, indicating any preference, limitation, specification, or discrimination, based on race, color, religion, national origin, sex, or age forty (40) and over, or because the person is a qualified individual with a disability, except that such a notice or advertisement may indicate a preference, limitation, or specification based on religion, national origin, sex, or age forty (40) and over, or because the person is a qualified individual with a disability, when religion, national origin, sex, or age forty (40) and over, or because the person is a qualified individual with a disability, is a bona fide occupational qualification for employment.

3. If the contractor is in control of apprenticeship or other training or retraining, including on-the-job training programs, he shall not discriminate against an individual because of his race, color, religion, national origin, sex, disability or age forty (40) and over, in admission to, or employment in any program established to provide apprenticeship or other training.

4. The contractor will send to each labor union or representative of workers with which he has a collective bargaining agreement or other contract or understanding, a notice to be provided advising the said labor union or workers' representative of the contractor's commitments under this section, and shall post copies of the notice in conspicuous places available to employees and applicants for employment. The contractor will take such action with respect to any subcontract or purchase order as the administering agency may direct as a means of enforcing such provisions, including sanctions for non-compliance.

Revised: January 25, 2017

Standard Title VI/Non-Discrimination Assurances

During the performance of this contract, the contractor, for itself, its assignees, and successors in interest (hereinafter referred to as the “contractor”) agrees as follows:

1. **Compliance with Regulations:** The contractor (hereinafter includes consultants) will comply with the Acts and the Regulations relative to Non-discrimination in Federally-assisted programs of the U.S. Department of Transportation, **Federal Highway Administration**, as they may be amended from time to time, which are herein incorporated by reference and made a part of this contract.
2. **Non-discrimination:** The contractor, with regard to the work performed by it during the contract, will not discriminate on the grounds of race, color, or national origin in the selection and retention of subcontractors, including procurements of materials and leases of equipment. The contractor will not participate directly or indirectly in the discrimination prohibited by the Acts and the Regulations, including employment practices when the contract covers any activity, project, or program set forth in Appendix B of 49 CFR Part 21.
3. **Solicitations for Subcontracts, Including Procurements of Materials and Equipment:** In all solicitations, either by competitive bidding, or negotiation made by the contractor for work to be performed under a subcontract, including procurements of materials, or leases of equipment, each potential subcontractor or supplier will be notified by the contractor of the contractor’s obligations under this contract and the Acts and the Regulations relative to Non-discrimination on the grounds of race, color, or national origin.
4. **Information and Reports:** The contractor will provide all information and reports required by the Acts, the Regulations, and directives issued pursuant thereto and will permit access to its books, records, accounts, other sources of information, and its facilities as may be determined by the Recipient or the **Federal Highway Administration** to be pertinent to ascertain compliance with such Acts, Regulations, and instructions. Where any information required of a contractor is in the exclusive possession of another who fails or refuses to furnish the information, the contractor will so certify to the Recipient or the **Federal Highway Administration**, as appropriate, and will set forth what efforts it has made to obtain the information.
5. **Sanctions for Noncompliance:** In the event of a contractor’s noncompliance with the Non-discrimination provisions of this contract, the Recipient will impose such contract sanctions as it or the **Federal Highway Administration** may determine to be appropriate, including, but not limited to:
 - a. withholding payments to the contractor under the contract until the contractor complies; and/or
 - b. cancelling, terminating, or suspending a contract, in whole or in part.
6. **Incorporation of Provisions:** The contractor will include the provisions of paragraphs one through six in every subcontract, including procurements of materials and leases of equipment, unless exempt by the Acts, the Regulations and directives issued pursuant thereto. The contractor will take action with respect to any subcontract or procurement as the Recipient or the **Federal Highway Administration** may direct as a means of enforcing such provisions including sanctions for noncompliance. Provided, that if the contractor becomes involved in, or is threatened with litigation by a subcontractor, or supplier because of such direction, the contractor may request the Recipient to enter into any litigation to protect the interests of the Recipient. In addition, the contractor may request the United States to enter into the litigation to protect the interests of the United States.

Standard Title VI/Non-Discrimination Statutes and Authorities

During the performance of this contract, the contractor, for itself, its assignees, and successors in interest (hereinafter referred to as the “contractor”) agrees to comply with the following non-discrimination statutes and authorities; including but not limited to:

- Title VI of the Civil Rights Act of 1964 (42 U.S.C. § 2000d *et seq.*, 78 stat. 252), (prohibits discrimination on the basis of race, color, national origin); and 49 CFR Part 21;
- The Uniform Relocation Assistance and Real Property Acquisition Policies Act of 1970, (42 U.S.C. § 4601), (prohibits unfair treatment of persons displaced or whose property has been acquired because of Federal or Federal-aid programs and projects);
- Federal-Aid Highway Act of 1973, (23 U.S.C. § 324 *et seq.*), (prohibits discrimination on the basis of sex);
- Section 504 of the Rehabilitation Act of 1973, (29 U.S.C. § 794 *et seq.*), as amended, (prohibits discrimination on the basis of disability); and 49 CFR Part 27;
- The Age Discrimination Act of 1975, as amended, (42 U.S.C. § 6101 *et seq.*), (prohibits discrimination on the basis of age);
- Airport and Airway Improvement Act of 1982, (49 USC § 471, Section 47123), as amended, (prohibits discrimination based on race, creed, color, national origin, or sex);
- The Civil Rights Restoration Act of 1987, (PL 100-209), (Broadened the scope, coverage and applicability of Title VI of the Civil Rights Act of 1964, The Age Discrimination Act of 1975 and Section 504 of the Rehabilitation Act of 1973, by expanding the definition of the terms “programs or activities” to include all of the programs or activities of the Federal-aid recipients, sub-recipients and contractors, whether such programs or activities are Federally funded or not);
- Titles II and III of the Americans with Disabilities Act, which prohibit discrimination on the basis of disability in the operation of public entities, public and private transportation systems, places of public accommodation, and certain testing entities (42 U.S.C. §§ 12131 -- 12189) as implemented by Department of Transportation regulations at 49 C.F.R. parts 37 and 38;
- The Federal Aviation Administration’s Non-discrimination statute (49 U.S.C. § 47123) (prohibits discrimination on the basis of race, color, national origin, and sex);
- Executive Order 12898, Federal Actions to Address Environmental Justice in Minority Populations and Low-Income Populations, which ensures non-discrimination against minority populations by discouraging programs, policies, and activities with disproportionately high and adverse human health or environmental effects on minority and low-income populations;
- Executive Order 13166, Improving Access to Services for Persons with Limited English Proficiency, and resulting agency guidance, national origin discrimination includes discrimination because of limited English proficiency (LEP). To ensure compliance with Title VI, you must take reasonable steps to ensure that LEP persons have meaningful access to your programs (70 Fed. Reg. at 74087 to 74100);
- Title IX of the Education Amendments of 1972, as amended, which prohibits you from discriminating because of sex in education programs or activities (20 U.S.C. 1681 *et seq.*)

EXECUTIVE BRANCH CODE OF ETHICS

In the 1992 regular legislative session, the General Assembly passed and Governor Brereton Jones signed Senate Bill 63 (codified as KRS 11A), the Executive Branch Code of Ethics, which states, in part:

KRS 11A.040 (7) provides:

No present or former public servant shall, within six (6) months following termination of his office or employment, accept employment, compensation, or other economic benefit from any person or business that contracts or does business with, or is regulated by, the state in matters in which he was directly involved during the last thirty-six (36) months of his tenure. This provision shall not prohibit an individual from returning to the same business, firm, occupation, or profession in which he was involved prior to taking office or beginning his term of employment, or for which he received, prior to his state employment, a professional degree or license, provided that, for a period of six (6) months, he personally refrains from working on any matter in which he was directly involved during the last thirty-six (36) months of his tenure in state government. This subsection shall not prohibit the performance of ministerial functions, including but not limited to filing tax returns, filing applications for permits or licenses, or filing incorporation papers, nor shall it prohibit the former officer or public servant from receiving public funds disbursed through entitlement programs.

KRS 11A.040 (9) states:

A former public servant shall not represent a person or business before a state agency in a matter in which the former public servant was directly involved during the last thirty-six (36) months of his tenure, for a period of one (1) year after the latter of:

- a) The date of leaving office or termination of employment; or
- b) The date the term of office expires to which the public servant was elected.

This law is intended to promote public confidence in the integrity of state government and to declare as public policy the idea that state employees should view their work as a public trust and not as a way to obtain private benefits.

If you have worked for the executive branch of state government within the past six months, you may be subject to the law's prohibitions. The law's applicability may be different if you hold elected office or are contemplating representation of another before a state agency.

Also, if you are affiliated with a firm which does business with the state and which employs former state executive-branch employees, you should be aware that the law may apply to them.

In case of doubt, the law permits you to request an advisory opinion from the Executive Branch Ethics Commission, 3 Fountain Place, Frankfort, Kentucky 40601; telephone (502) 564-7954.

Revised: January 27, 2017

General Decision Number: KY190040 05/17/2019 KY40

Superseded General Decision Number: KY20180102

State: Kentucky

Construction Type: Highway

Counties: Allen, Ballard, Butler, Caldwell, Calloway, Carlisle, Christian, Crittenden, Daviess, Edmonson, Fulton, Graves, Hancock, Henderson, Hickman, Hopkins, Livingston, Logan, Lyon, Marshall, McCracken, McLean, Muhlenberg, Ohio, Simpson, Todd, Trigg, Union, Warren and Webster Counties in Kentucky.

HIGHWAY CONSTRUCTION PROJECTS (excluding tunnels, building structures in rest area projects & railroad construction; bascule, suspension & spandrel arch bridges designed for commercial navigation, bridges involving marine construction; and other major bridges).

Note: Under Executive Order (EO) 13658, an hourly minimum wage of \$10.60 for calendar year 2019 applies to all contracts subject to the Davis-Bacon Act for which the contract is awarded (and any solicitation was issued) on or after January 1, 2015. If this contract is covered by the EO, the contractor must pay all workers in any classification listed on this wage determination at least \$10.60 per hour (or the applicable wage rate listed on this wage determination, if it is higher) for all hours spent performing on the contract in calendar year 2019. If this contract is covered by the EO and a classification considered necessary for performance of work on the contract does not appear on this wage determination, the contractor must pay workers in that classification at least the wage rate determined through the conformance process set forth in 29 CFR 5.5(a)(1)(ii) (or the EO minimum wage rate, if it is higher than the conformed wage rate). The EO minimum wage rate will be adjusted annually. Please note that this EO applies to the above-mentioned types of contracts entered into by the federal government that are subject to the Davis-Bacon Act itself, but it does not apply to contracts subject only to the Davis-Bacon Related Acts, including those set forth at 29 CFR 5.1(a)(2)-(60). Additional information on contractor requirements and worker protections under the EO is available at www.dol.gov/whd/govcontracts.

Modification Number	Publication Date
0	01/04/2019
1	02/01/2019
2	02/15/2019
3	05/17/2019

BRIN0004-002 06/01/2017

BALLARD, BUTLER, CALDWELL, CARLISLE, CRITTENDEN, DAVIESS, EDMONSON, FULTON, GRAVES, HANCOCK, HENDERSON, HICKMAN, HOPKINS, LIVINGSTON, LYON, MARSHALL, MCCRACKEN, MCLEAN,

MUHLENBERG, OHIO, UNION, and WEBSTER COUNTIES

	Rates	Fringes
BRICKLAYER		
Ballard, Caldwell, Carlisle, Crittenden, Fulton, Graves, Hickman, Livingston, Lyon, Marshall, and McCracken Counties.....	\$ 30.50	15.16
Butler, Edmonson, Hopkins, Muhlenberg, and Ohio Counties.....	\$ 26.80	12.38
Daviess, Hancock, Henderson, McLean, Union, and Webster Counties.....	\$ 30.00	15.16

BRTN0004-005 06/01/2017

ALLEN, CALLOWAY, CHRISTIAN, LOGAN, SIMPSON, TODD, TRIGG, and
WARREN COUNTIES

	Rates	Fringes
BRICKLAYER.....	\$ 26.80	12.38

CARP0357-002 04/01/2016

	Rates	Fringes
CARPENTER.....	\$ 27.70	17.03
Diver.....	\$ 41.93	17.03
PILEDRIVERMAN.....	\$ 27.95	17.03

ELEC0369-006 05/30/2018

BUTLER, EDMONSON, LOGAN, TODD & WARREN COUNTIES:

	Rates	Fringes
ELECTRICIAN.....	\$ 31.66	17.01

ELEC0429-001 06/01/2018

ALLEN & SIMPSON COUNTIES:

	Rates	Fringes
ELECTRICIAN.....	\$ 26.77	12.94

ELEC0816-002 05/28/2018

BALLARD, CALDWELL, CALLOWAY, CARLISLE, CHRISTIAN, CRITTENDEN,
FULTON (Except a 5 mile radius of City Hall in Fulton), GRAVES,
HICKMAN, LIVINGSTON, LYON, MARSHALL, MCCRACKEN & TRIGG COUNTIES:

	Rates	Fringes
ELECTRICIAN.....	\$ 32.87	25.5%+7.05

Cable spicers receive \$.25 per hour additional.

ELEC1701-003 06/01/2018

DAVIESS, HANCOCK, HENDERSON, HOPKINS, MCLEAN, MUHLENBERG, OHIO,
UNION & WEBSTER COUNTIES:

	Rates	Fringes
ELECTRICIAN.....	\$ 31.04	15.74

Cable spicers receive \$.25 per hour additional.

ELEC1925-002 01/01/2019

FULTON COUNTY (Up to a 5 mile radius of City Hall in Fulton):

	Rates	Fringes
CABLE SPLICER.....	\$ 25.80	12.16
ELECTRICIAN.....	\$ 25.20	13.74

ENGI0181-017 07/01/2017

	Rates	Fringes
POWER EQUIPMENT OPERATOR		
GROUP 1.....	\$ 31.95	15.15
GROUP 2.....	\$ 29.09	15.15
GROUP 3.....	\$ 29.54	15.15
GROUP 4.....	\$ 28.77	15.15

OPERATING ENGINEER CLASSIFICATIONS

GROUP 1 - A-Frame Winch Truck; Auto Patrol; Backfiller; Batcher Plant; Bituminous Paver; Bituminous Transfer Machine; Boom Cat; Bulldozer; Mechanic; Cableway; Carry-All Scoop; Carry Deck Crane; Central Compressor Plant; Cherry Picker; Clamshell; Concrete Mixer (21 cu. ft. or Over); Concrete Paver; Truck-Mounted Concrete Pump; Core Drill; Crane; Crusher Plant; Derrick; Derrick Boat; Ditching & Trenching Machine; Dragline; Dredge Operator; Dredge Engineer; Elevating Grader & Loaders; Grade-All; Gurries; Heavy Equipment Robotics Operator/Mechanic; High Lift; Hoe-Type Machine; Hoist (Two or More Drums); Hoisting Engine (Two or More Drums); Horizontal Directional Drill Operator; Hydrocrane; Hyster; KeCal Loader; LeTourneau; Locomotive; Mechanic; Mechanically Operated Laser Screed; Mechanic Welder; Mucking Machine; Motor Scraper; Orangepeel Bucket; Overhead Crane; Piledriver; Power Blade; Pumpcrete; Push Dozer; Rock Spreader, attached to equipment; Rotary Drill; Roller (Bituminous); Rough Terrain Crane; Scarifier; Scoopmobile; Shovel; Side Boom; Subgrader; Tailboom; Telescoping Type Forklift; Tow or Push Boat; Tower Crane (French, German & other types); Tractor Shovel; Truck

BUTLER COUNTY (Townships of Aberdeen, Bancock, Casey, Dexterville, Dunbar, Elfie, Gilstrap, Huntsville, Logansport, Monford, Morgantown, Provo, Rochester, South Hill & Welchs Creek);
 CALDWELL COUNTY (Northeastern third, including the Township of Creswell);
 CHRISTIAN COUNTY (Northern third, including the Townships of Apex, Crofton, Kelly, Mannington & Wynns);
 CRITTENDEN COUNTY (Northeastern half, including the Townships of Grove, Mattoon, Repton, Shady Grove & Tribune);
 MUHLENBERG COUNTY (Townships of Bavier, Beech Creek Junction, Benton, Brennen, Browder, Central City, Cleaton, Depoy, Drakesboro, Eunis, Graham, Hillside, Luzerne, Lynn City, Martwick, McNary, Millport, Moorman, Nelson, Paradise, Powderly, South Carrollton, Tarina & Weir)

	Rates	Fringes
Ironworkers:.....	\$ 28.66	22.435

IRON0492-003 05/01/2018		

ALLEN, LOGAN, SIMPSON, TODD & WARREN COUNTIES
 BUTLER COUNTY (Southern third, including the Townships of Boston, Berrys Lick, Dimple, Jetson, Quality, Sharer, Sugar Grove & Woodbury);
 CHRISTIAN COUNTY (Eastern two-thirds, including the Townships of Bennettstown, Casky, Herndon, Hopkinsville, Howell, Masonville, Pembroke & Thompsonville);
 EDMONSON COUNTY (Southern fourth, including the Townships of Chalybeate & Rocky Hill);
 MUHLENBERG COUNTY (Southern eighth, including the Townships of Dunnior, Penrod & Rosewood)

	Rates	Fringes
Ironworkers:.....	\$ 26.11	14.02

IRON0782-006 05/01/2018		

BALLARD, CALLOWAY, CARLISLE, FULTON, GRAVES, HICKMAN, LIVINGSTON, LYON, MARSHALL, MCCRACKEN & TRIGG COUNTIES
 CALDWELL COUNTY (Southwestern two-thirds, including the Townships of Cedar Bluff, Cider, Claxton, Cobb, Crowtown, Dulaney, Farmersville, Fredonia, McGowan, Otter Pond & Princeton);
 CHRISTIAN COUNTY (Western third, Excluding the Townships of Apex, Crofton, Kelly, Mannington, Wynns, Bennettstown, Casky, Herndon, Hopkinsville, Howell, Masonville, Pembroke & Thompsonville);
 CRITTENDEN COUNTY (Southwestern half, including the Townships of Crayne, Dycusburg, Frances, Marion, Mexico, Midway, Sheridan & Told)

	Rates	Fringes
Ironworkers:		

Projects with a total
contract cost of
\$20,000,000.00 or above.....\$ 28.79 24.17
All Other Work.....\$ 27.20 22.75

LABO0189-005 07/01/2018

BALLARD, CALLOWAY, CARLISLE, FULTON, GRAVES, HICKMAN,
LIVINGSTON, LYON, MARSHALL & MCCRACKEN COUNTIES

	Rates	Fringes
Laborers:		
GROUP 1.....	\$ 23.07	14.21
GROUP 2.....	\$ 23.32	14.21
GROUP 3.....	\$ 23.37	14.21
GROUP 4.....	\$ 23.97	14.21

LABORER CLASSIFICATIONS

GROUP 1 - Aging & Curing of Concrete; Asbestos Abatement Worker; Asphalt Plant; Asphalt; Batch Truck Dump; Carpenter Tender; Cement Mason Tender; Cleaning of Machines; Concrete; Demolition; Dredging; Environmental - Nuclear, Radiation, Toxic & Hazardous Waste - Level D; Flagperson; Grade Checker; Hand Digging & Hand Back Filling; Highway Marker Placer; Landscaping, Mesh Handler & Placer; Puddler; Railroad; Rip-rap & Grouter; Right-of-Way; Sign, Guard Rail & Fence Installer; Signal Person; Sound Barrier Installer; Storm & Sanitary Sewer; Swamper; Truck Spotter & Dumper; Wrecking of Concrete Forms; General Cleanup

GROUP 2 - Batter Board Man (Sanitary & Storm Sewer); Brickmason Tender; Mortar Mixer Operator; Scaffold Builder; Burner & Welder; Bushhammer; Chain Saw Operator; Concrete Saw Operator; Deckhand Scow Man; Dry Cement Handler; Environmental - Nuclear, Radiation, Toxic & Hazardous Waste - Level C; Forklift Operator for Masonary; Form Setter; Green Concrete Cutting; Hand Operated Grouter & Grinder Machine Operator; Jackhammer; Pavement Breaker; Paving Joint Machine; Pipelayer; Plastic Pipe Fusion; Power Driven Georgia Buggy & Wheel Barrow; Power Post Hole Digger; Precast Manhole Setter; Walk-Behind Tamper; Walk-Behind Trencher; Sand Blaster; Concrete Chipper; Surface Grinder; Vibrator Operator; Wagon Driller

GROUP 3 - Asphalt Luteman & Raker; Gunnite Nozzleman; Gunnite Operator & Mixer; Grout Pump Operator; Blaster; Side Rail Setter; Rail Paved Ditches; Screw Operator; Tunnel (Free Air); Water Blaster

GROUP 4 - Caisson Worker (Free Air); Cement Finisher; Environmental - Nuclear, Radiation, Toxic & Hazardous Waste - Levels A & B; Miner & Driller (Free Air); Tunnel Blaster; & Tunnel Mucker (Free Air); Directional & Horizontal Boring; Air Track Drillers (All Types); Powdermen & Blasters; Troxler & Concrete Tester if Laborer is Utilized

LABO0189-006 07/01/2018

ALLEN, BUTLER, CALDWELL, CHRISTIAN, DAVIESS, EDMONSON, HANCOCK,
HOPKINS, LOGAN, MCLEAN, MUHLENBERG, OHIO, SIMPSON, TODD, TRIGG
& WARREN COUNTIES

	Rates	Fringes
Laborers:		
GROUP 1.....	\$ 23.07	14.21
GROUP 2.....	\$ 23.32	14.21
GROUP 3.....	\$ 23.37	14.21
GROUP 4.....	\$ 23.97	14.21

LABORER CLASSIFICATIONS

GROUP 1 - Aging & Curing of Concrete; Asbestos Abatement Worker; Asphalt Plant; Asphalt; Batch Truck Dump; Carpenter Tender; Cement Mason Tender; Cleaning of Machines; Concrete; Demolition; Dredging; Environmental - Nuclear, Radiation, Toxic & Hazardous Waste - Level D; Flagperson; Grade Checker; Hand Digging & Hand Back Filling; Highway Marker Placer; Landscaping, Mesh Handler & Placer; Puddler; Railroad; Rip-rap & Grouter; Right-of-Way; Sign, Guard Rail & Fence Installer; Signal Person; Sound Barrier Installer; Storm & Sanitary Sewer; Swamper; Truck Spotter & Dumper; Wrecking of Concrete Forms; General Cleanup

GROUP 2 - Batter Board Man (Sanitary & Storm Sewer); Brickmason Tender; Mortar Mixer Operator; Scaffold Builder; Burner & Welder; Bushhammer; Chain Saw Operator; Concrete Saw Operator; Deckhand Scow Man; Dry Cement Handler; Environmental - Nuclear, Radiation, Toxic & Hazardous Waste - Level C; Forklift Operator for Masonary; Form Setter; Green Concrete Cutting; Hand Operated Grouter & Grinder Machine Operator; Jackhammer; Pavement Breaker; Paving Joint Machine; Pipelayer; Plastic Pipe Fusion; Power Driven Georgia Buggy & Wheel Barrow; Power Post Hole Digger; Precast Manhole Setter; Walk-Behind Tamper; Walk-Behind Trencher; Sand Blaster; Concrete Chipper; Surface Grinder; Vibrator Operator; Wagon Driller

GROUP 3 - Asphalt Luteman & Raker; Gunnite Nozzleman; Gunnite Operator & Mixer; Grout Pump Operator; Blaster; Side Rail Setter; Rail Paved Ditches; Screw Operator; Tunnel (Free Air); Water Blaster

GROUP 4 - Caisson Worker (Free Air); Cement Finisher; Environmental - Nuclear, Radiation, Toxic & Hazardous Waste - Levels A & B; Miner & Driller (Free Air); Tunnel Blaster; & Tunnel Mucker (Free Air); Directional & Horizontal Boring; Air Track Drillers (All Types); Powdermen & Blasters; Troxler & Concrete Tester if Laborer is Utilized

LABO0561-001 07/01/2018

CRITTENDEN, HENDERSON, UNION & WEBSTER COUNTIES

	Rates	Fringes
Laborers:		
GROUP 1.....	\$ 22.71	15.00
GROUP 2.....	\$ 22.96	15.00
GROUP 3.....	\$ 23.01	15.00
GROUP 4.....	\$ 23.61	15.00

LABORER CLASSIFICATIONS

GROUP 1 - Aging & Curing of Concrete; Asbestos Abatement Worker; Asphalt Plant; Asphalt; Batch Truck Dump; Carpenter Tender; Cement Mason Tender; Cleaning of Machines; Concrete; Demolition; Dredging; Environmental - Nuclear, Radiation, Toxic & Hazardous Waste - Level D; Flagperson; Grade Checker; Hand Digging & Hand Back Filling; Highway Marker Placer; Landscaping, Mesh Handler & Placer; Puddler; Railroad; Rip-rap & Grouter; Right-of-Way; Sign, Guard Rail & Fence Installer; Signal Person; Sound Barrier Installer; Storm & Sanitary Sewer; Swamper; Truck Spotter & Dumper; Wrecking of Concrete Forms; General Cleanup

GROUP 2 - Batter Board Man (Sanitary & Storm Sewer); Brickmason Tender; Mortar Mixer Operator; Scaffold Builder; Burner & Welder; Bushhammer; Chain Saw Operator; Concrete Saw Operator; Deckhand Scow Man; Dry Cement Handler; Environmental - Nuclear, Radiation, Toxic & Hazardous Waste - Level C; Forklift Operator for Masonary; Form Setter; Green Concrete Cutting; Hand Operated Grouter & Grinder Machine Operator; Jackhammer; Pavement Breaker; Paving Joint Machine; Pipelayer; Plastic Pipe Fusion; Power Driven Georgia Buggy & Wheel Barrow; Power Post Hole Digger; Precast Manhole Setter; Walk-Behind Tamper; Walk-Behind Trencher; Sand Blaster; Concrete Chipper; Surface Grinder; Vibrator Operator; Wagon Driller

GROUP 3 - Asphalt Luteman & Raker; Gunnite Nozzleman; Gunnite Operator & Mixer; Grout Pump Operator; Blaster; Side Rail Setter; Rail Paved Ditches; Screw Operator; Tunnel (Free Air); Water Blaster

GROUP 4 - Caisson Worker (Free Air); Cement Finisher; Environmental - Nuclear, Radiation, Toxic & Hazardous Waste - Levels A & B; Miner & Driller (Free Air); Tunnel Blaster; & Tunnel Mucker (Free Air); Directional & Horizontal Boring; Air Track Drillers (All Types); Powdermen & Blasters; Troxler & Concrete Tester if Laborer is Utilized

PAIN0032-002 09/01/2018

BALLARD COUNTY

	Rates	Fringes
Painters:		
Bridges.....	\$ 33.56	16.13
All Other Work.....	\$ 31.86	16.13
Spray, Blast, Steam, High & Hazardous (Including Lead		

Abatement) and All Epoxy - \$1.00 Premium

PAIN0118-003 06/01/2014

EDMONSON COUNTY:

	Rates	Fringes
Painters:		
Brush & Roller.....	\$ 18.50	11.97
Spray, Sandblast, Power Tools, Waterblast & Steam Cleaning.....	\$ 19.50	11.97

PAIN0156-006 04/01/2015

DAVIESS, HANCOCK, HENDERSON, MCLEAN, OHIO, UNION & WEBSTER
COUNTIES

	Rates	Fringes
Painters:		
BRIDGES		
GROUP 1.....	\$ 27.60	12.85
GROUP 2.....	\$ 27.85	12.85
GROUP 3.....	\$ 28.60	12.85
GROUP 4.....	\$ 29.60	12.85
ALL OTHER WORK:		
GROUP 1.....	\$ 26.45	12.85
GROUP 2.....	\$ 26.70	12.85
GROUP 3.....	\$ 27.45	12.85
GROUP 4.....	\$ 28.45	12.85

PAINTER CLASSIFICATIONS

GROUP 1 - Brush & Roller

GROUP 2 - Plasterers

GROUP 3 - Spray; Sandblast; Power Tools; Waterblast;
Steamcleaning; Brush & Roller of Mastics, Creosotes, Kwinch
Koate & Coal Tar Epoxy

GROUP 4 - Spray of Mastics, Creosotes, Kwinch Koate & Coal
Tar Epoxy

PAIN0500-002 06/01/2018

CALDWELL, CALLOWAY, CARLISLE, CHRISTIAN, CRITTENDEN, FULTON,
GRAVES, HICKMAN, HOPKINS, LIVINGSTON, LYON, MARSHALL, MCCRACKEN
& TRIGG COUNTIES:

	Rates	Fringes
Painters:		
Bridges.....	\$ 27.75	13.60

All Other Work.....\$ 21.50 13.60

Waterblasting units with 3500 PSI and above - \$.50 premium
Spraypainting and all abrasive blasting - \$1.00 premium
Work 40 ft. and above ground level - \$1.00 premium

PLUM0184-002 07/01/2018

BALLARD, CALDWELL, CALLOWAY, CARLISLE, CHRISTIAN, CRITTENDEN,
FULTON, GRAVES, HICKMAN, LIVINGSTON, LYON, MARSHALL, MCCRACKEN
and TRIGG COUNTIES

	Rates	Fringes
Plumber; Steamfitter.....	\$ 35.06	18.18

PLUM0502-004 08/01/2018

ALLEN, BUTLER, EDMONSON, SIMPSON & WARREN

	Rates	Fringes
Plumber; Steamfitter.....	\$ 34.62	20.78

PLUM0633-002 07/01/2017

DAVIESS, HANCOCK, HENDERSON, HOPKINS, LOGAN, MCLEAN,
MUHLENBERG, OHIO, TODD, UNION & WEBSTER COUNTIES:

	Rates	Fringes
PLUMBER/PIPEFITTER.....	\$ 31.47	16.80

* TEAM0089-003 04/01/2019

ALLEN, BUTLER, EDMONSON, LOGAN, SIMPSON & WARREN COUNTIES

	Rates	Fringes
Truck drivers:		
Zone 1:		
Group 1.....	\$ 20.82	21.96
Group 2.....	\$ 21.00	21.96
Group 3.....	\$ 21.08	21.96
Group 4.....	\$ 21.10	21.96

GROUP 1 - Greaser; Tire Changer

GROUP 2 - Truck Mechanic; Single Axle Dump; Flat Bed; All
Terrain Vehicles when used to haul materials; Semi Trailer
or Pole Trailer when used to pull building materials and
equipment; Tandem Axle Dump; Driver of Distributors

GROUP 3 - Mixer All Types

GROUP 4 - Winch and A-Frame when used in transporting
materials; Ross Carrier; Fork Lift when used to transport

building materials; Driver on Pavement Breaker; Euclid and Other Heavy Earth Moving Equipment; Low Boy; Articulator Cat; Five Axle Vehicle

* TEAM0215-003 04/01/2019

DAVIESS, HANCOCK, HENDERSON, HOPKINS, MCLEAN, MUHLENBERG, OHIO & WEBSTER COUNTIES

	Rates	Fringes
TRUCK DRIVER		
Group 1.....	\$ 22.45	21.96
Group 2.....	\$ 22.68	21.96
Group 3.....	\$ 22.75	21.96
Group 4.....	\$ 22.76	21.96

GROUP 1: Greaser, Tire Changer

GROUP 2: Truck Mechanic

GROUP 3: Single Axle Dump; Flat Bed; All Terrain Vehicle when used to haul materials; Semi Trailer or Pole Trailer when used to pull building materials and equipment; Tandem Axle Dump; Driver of Distributors; Mixer All Types

GROUP 4: Euclid and other heavy earth moving equipment; Low Boy; Articulator Cat; 5 Axle Vehicle; Winch and A- Frame when used in transporting materials; Ross Carrier; Fork Lift when used to transport building materials; Driver on Pavement Breaker

* TEAM0236-001 04/01/2019

BALLARD, CALDWELL, CALLOWAY, CARLISLE, CHRISTIAN, CRITTENDEN, FULTON, GRAVES, HICKMAN, LIVINGSTON, LYON, MARSHALL, MCCRACKEN, TODD & TRIGG COUNTIES

	Rates	Fringes
TRUCK DRIVER		
Group 1.....	\$ 20.82	21.96
Group 2.....	\$ 21.00	21.96
Group 3.....	\$ 21.00	21.96
Group 4.....	\$ 20.10	21.96
Group 5.....	\$ 21.08	21.96

GROUP 1: Greaser, Tire Changer

GROUP 2: Truck Mechanic

GROUP 3: Single Axle Dump; Flat Bed; All Terrain Vehicle when used to haul materials; Semi Trailer or Pole Trailer when used to pull building materials and equipment; Tandem Axle Dump; Drivers of Distributors

GROUP 4: Euclid and other heavy earth moving equipment; Low Boy; Articulator Cat; Five Axle Vehicle; Winch and A-Frame when used in transporting materials; Ross Carrier

GROUP 5: Mixer All Types

WELDERS - Receive rate prescribed for craft performing operation to which welding is incidental.

=====
Note: Executive Order (EO) 13706, Establishing Paid Sick Leave for Federal Contractors applies to all contracts subject to the Davis-Bacon Act for which the contract is awarded (and any solicitation was issued) on or after January 1, 2017. If this contract is covered by the EO, the contractor must provide employees with 1 hour of paid sick leave for every 30 hours they work, up to 56 hours of paid sick leave each year. Employees must be permitted to use paid sick leave for their own illness, injury or other health-related needs, including preventive care; to assist a family member (or person who is like family to the employee) who is ill, injured, or has other health-related needs, including preventive care; or for reasons resulting from, or to assist a family member (or person who is like family to the employee) who is a victim of, domestic violence, sexual assault, or stalking. Additional information on contractor requirements and worker protections under the EO is available at www.dol.gov/whd/govcontracts.

Unlisted classifications needed for work not included within the scope of the classifications listed may be added after award only as provided in the labor standards contract clauses (29CFR 5.5 (a) (1) (ii)).

The body of each wage determination lists the classification and wage rates that have been found to be prevailing for the cited type(s) of construction in the area covered by the wage determination. The classifications are listed in alphabetical order of "identifiers" that indicate whether the particular rate is a union rate (current union negotiated rate for local), a survey rate (weighted average rate) or a union average rate (weighted union average rate).

Union Rate Identifiers

A four letter classification abbreviation identifier enclosed in dotted lines beginning with characters other than "SU" or "UAVG" denotes that the union classification and rate were prevailing for that classification in the survey. Example: PLUM0198-005 07/01/2014. PLUM is an abbreviation identifier of the union which prevailed in the survey for this classification, which in this example would be Plumbers. 0198 indicates the local union number or district council number where applicable, i.e., Plumbers Local 0198. The next number,

005 in the example, is an internal number used in processing the wage determination. 07/01/2014 is the effective date of the most current negotiated rate, which in this example is July 1, 2014.

Union prevailing wage rates are updated to reflect all rate changes in the collective bargaining agreement (CBA) governing this classification and rate.

Survey Rate Identifiers

Classifications listed under the "SU" identifier indicate that no one rate prevailed for this classification in the survey and the published rate is derived by computing a weighted average rate based on all the rates reported in the survey for that classification. As this weighted average rate includes all rates reported in the survey, it may include both union and non-union rates. Example: SULA2012-007 5/13/2014. SU indicates the rates are survey rates based on a weighted average calculation of rates and are not majority rates. LA indicates the State of Louisiana. 2012 is the year of survey on which these classifications and rates are based. The next number, 007 in the example, is an internal number used in producing the wage determination. 5/13/2014 indicates the survey completion date for the classifications and rates under that identifier.

Survey wage rates are not updated and remain in effect until a new survey is conducted.

Union Average Rate Identifiers

Classification(s) listed under the UAVG identifier indicate that no single majority rate prevailed for those classifications; however, 100% of the data reported for the classifications was union data. EXAMPLE: UAVG-OH-0010 08/29/2014. UAVG indicates that the rate is a weighted union average rate. OH indicates the state. The next number, 0010 in the example, is an internal number used in producing the wage determination. 08/29/2014 indicates the survey completion date for the classifications and rates under that identifier.

A UAVG rate will be updated once a year, usually in January of each year, to reflect a weighted average of the current negotiated/CBA rate of the union locals from which the rate is based.

WAGE DETERMINATION APPEALS PROCESS

1.) Has there been an initial decision in the matter? This can be:

- * an existing published wage determination
- * a survey underlying a wage determination
- * a Wage and Hour Division letter setting forth a position on a wage determination matter
- * a conformance (additional classification and rate) ruling

On survey related matters, initial contact, including requests for summaries of surveys, should be with the Wage and Hour Regional Office for the area in which the survey was conducted because those Regional Offices have responsibility for the Davis-Bacon survey program. If the response from this initial contact is not satisfactory, then the process described in 2.) and 3.) should be followed.

With regard to any other matter not yet ripe for the formal process described here, initial contact should be with the Branch of Construction Wage Determinations. Write to:

Branch of Construction Wage Determinations
Wage and Hour Division
U.S. Department of Labor
200 Constitution Avenue, N.W.
Washington, DC 20210

2.) If the answer to the question in 1.) is yes, then an interested party (those affected by the action) can request review and reconsideration from the Wage and Hour Administrator (See 29 CFR Part 1.8 and 29 CFR Part 7). Write to:

Wage and Hour Administrator
U.S. Department of Labor
200 Constitution Avenue, N.W.
Washington, DC 20210

The request should be accompanied by a full statement of the interested party's position and by any information (wage payment data, project description, area practice material, etc.) that the requestor considers relevant to the issue.

3.) If the decision of the Administrator is not favorable, an interested party may appeal directly to the Administrative Review Board (formerly the Wage Appeals Board). Write to:

Administrative Review Board
U.S. Department of Labor
200 Constitution Avenue, N.W.
Washington, DC 20210

4.) All decisions by the Administrative Review Board are final.

=====
END OF GENERAL DECISION

Fringe benefit amounts are applicable for all hours worked except when otherwise noted.

No laborer, workman or mechanic shall be paid at a rate less than that of a Journeyman except those classified as bona fide apprentices.

Apprentices or trainees shall be permitted to work as such subject to Administrative Regulations adopted by the Commissioner of Workplace Standards. Copies of these regulations will be furnished upon request from any interested person.

Before using apprentices on the job the contractor shall present to the Contracting Officer written evidence of registration of such employees in a program of a State apprenticeship and training agency approved and recognized by the U. S. Bureau of Apprenticeship and Training. In the absence of such a State agency, the contractor shall submit evidence of approval and registration by the U. S. Bureau of Apprenticeship and Training.

The contractor shall submit to the Contracting Officer, written evidence of the established apprenticeship-journeyman ratios and wage rates in the project area, which will be the basis for establishing such ratios and rates for the project under the applicable contract provisions.

TO: EMPLOYERS/EMPLOYEES

PREVAILING WAGE SCHEDULE:

The wages indicated on this wage schedule are the least permitted to be paid for the occupations indicated. When an employee works in more than one classification, the employer must record the number of hours worked in each classification at the prescribed hourly base rate.

OVERTIME:

Overtime is to be paid to an employee at a rate not less than one and one-half times the basic rate of pay for all hours worked in excess of forty (40) hours in such workweek. Wage violations or questions should be directed to the designated Engineer or the undersigned.

Director
Division of Construction Procurement
Frankfort, Kentucky 40622
502-564-3500

General Decision Number: KY190107 01/04/2019 KY107

Superseded General Decision Number: KY20180187

State: Kentucky

Construction Type: Highway

Counties: Adair, Barren, Bell, Breathitt, Casey, Clay, Clinton, Cumberland, Estill, Floyd, Garrard, Green, Harlan, Hart, Jackson, Johnson, Knott, Knox, Laurel, Lawrence, Lee, Leslie, Letcher, Lincoln, Magoffin, Martin, McCreary, Menifee, Metcalfe, Monroe, Morgan, Owsley, Perry, Pike, Powell, Pulaski, Rockcastle, Russell, Taylor, Wayne, Whitley and Wolfe Counties in Kentucky.

HIGHWAY CONSTRUCTION PROJECTS

Note: Under Executive Order (EO) 13658, an hourly minimum wage of \$10.60 for calendar year 2019 applies to all contracts subject to the Davis-Bacon Act for which the contract is awarded (and any solicitation was issued) on or after January 1, 2015. If this contract is covered by the EO, the contractor must pay all workers in any classification listed on this wage determination at least \$10.60 per hour (or the applicable wage rate listed on this wage determination, if it is higher) for all hours spent performing on the contract in calendar year 2019. If this contract is covered by the EO and a classification considered necessary for performance of work on the contract does not appear on this wage determination, the contractor must pay workers in that classification at least the wage rate determined through the conformance process set forth in 29 CFR 5.5(a)(1)(ii) (or the EO minimum wage rate, if it is higher than the conformed wage rate). The EO minimum wage rate will be adjusted annually. Please note that this EO applies to the above-mentioned types of contracts entered into by the federal government that are subject to the Davis-Bacon Act itself, but it does not apply to contracts subject only to the Davis-Bacon Related Acts, including those set forth at 29 CFR 5.1(a)(2)-(60). Additional information on contractor requirements and worker protections under the EO is available at www.dol.gov/whd/govcontracts.

Modification Number	Publication Date
0	01/04/2019

SUKY2015-047 10/20/2015

	Rates	Fringes
BOILERMAKER.....	\$ 24.65	12.94
BRICKLAYER		
Bricklayer.....	\$ 22.90	8.50

Stone Mason.....	\$ 21.50	8.50
CARPENTER		
Carpenter.....	\$ 24.90	14.50
Piledriver.....	\$ 24.55	14.50

CEMENT MASON.....	\$ 21.25	8.50
-------------------	----------	------

ELECTRICIAN

Electrician.....	\$ 29.36	10.55
Equipment Operator.....	\$ 26.90	10.31
Groundsman.....	\$ 17.79	8.51
Lineman.....	\$ 30.09	10.94

When workmen are required to work from bosum chairs, trusses, stacks, tanks, scaffolds, catwalks, radio and T.V. towers, structural steel (open, unprotected, unfloored raw steel), and bridges or similar hazardous locations where workmen are subject to fall, except where using JLG's and bucket trucks up to 75 feet: Add 25% to workman's base rate for 50 to 75 feet, and add 50% to workman's base rate for over 75 feet.

IRONWORKER.....	\$ 27.56	20.57
-----------------	----------	-------

LABORER

Group 1.....	\$ 21.80	12.36
Group 2.....	\$ 22.05	12.36
Group 3.....	\$ 22.10	12.36
Group 4.....	\$ 22.70	12.36

GROUP 1: Aging and Curing of Concrete (Any Mode or Method), Asbestos Abatement Worker, Asphalt Plant Laborers, Asphalt Laborers, Batch Truck Dumpers, Carpenter Tenders, Cement Mason Tenders, Cleaning of Machines, Concrete Laborers, Demolition Laborers, Dredging Laborers, Drill Tender, Environmental Laborer - Nuclear, Radiation, Toxic and Hazardous Waste - Level D, Flagmen, Grade Checkers, All Hand Digging and Hand Back Filling, Highway Marker Placers, Landscaping Laborers, Mesh Handlers and Placers, Puddler, Railroad Laborers, Rip-rap and Grouters, Right of Way Laborers, Sign, Guard Rail and Fence Installers (All Types), Signalmen, Sound Barrier Installer, Storm and Sanitary Sewer Laborers, Swampers, Truck Spotters and Dumpers, Wrecking of Concrete Forms, General Cleanup

GROUP 2: Batter Board Men (Sanitary and Storm Sewer), Brickmason Tenders, Mortar Mixer Operator, Scaffold Builders, Burner and Welder, Bushammers, Chain Saw Operator, Concrete Saw Operators, Deckhand Scow Man, Dry Cement Handlers, Environmental Laborers - Nuclear, Radiation, Toxic and Hazardous Waste - Level C, Forklift Operators for Masonry, Form Setters, Green Concrete Cutting, Hand Operated Grouter and Grinder Machine Operator, Jack Hammers, Lead Paint Abatement, Pavement Breakers, Paving Joint Machine, Pipe Layers - Laser Operators (Non-metallic), Plastic Pipe Fusion, Power Driven Georgia Buggy and Wheel Barrow, Power Post Hole Diggers, Precast Manhole Setters, Walk-behind Tampers, Walk-behind Trenchers, Sand Blasters, Concrete Chippers, Surface Grinders, Vibrator Operators, Wagon Drillers

GROUP 3: Air Track Driller (All Types), Asphalt Luteman and Rakers, Gunnite Nozzleman, Gunnite Operators and Mixers, Grout

Pump Operator, Powderman and Blaster, Side Rail Setters, Rail Paved Ditches, Screw Operators, Tunnel Laborers (Free Air), Water Blasters

GROUP 4: Caisson Workers (Free Air), Cement Finishers, Environmental Laborer - Nuclear, Radiation, Toxic and Hazardous Waste - Level A and B, miners and Drillers (Free Air), Tunnel Blasters, and Tunnel Mockers (Free Air), Directional and Horizontal Boring, Air Track Drillers (All Types), Powder Man and Blasters, Troxler and Concrete Tester if Laborer is Utilized

PAINTER

All Excluding Bridges.....	\$ 19.92	9.57
Bridges.....	\$ 23.92	10.07

PLUMBER.....\$ 22.52 7.80

POWER EQUIPMENT OPERATOR:

Group 1.....	\$ 29.95	14.40
Group 2.....	\$ 29.95	14.40
Group 3.....	\$ 27.26	14.40
Group 4.....	\$ 26.96	14.40

GROUP 1: Auto Patrol, Batch Plant, Bituminous Paver, Cable-Way, Clamshell, Concrete Mixer (21 cu ft or over), Concrete Pump, Crane, Crusher Plant, Derrick, Derrick Boat, Ditching and Trenching Machine, Dragline, Dredge Engineer, Elevator (regardless of ownership when used for hoisting any building material), Elevating Grader and all types of Loaders, Hoe-type Machine, Hoisting Engine, Locomotive, LeTourneau or Carry-all Scoop, Bulldozer, Mechanic, Orangepeel Bucket, Piledriver, Power Blade, Roller (Bituminous), Roller (Earth), Roller (Rock), Scarifier, Shovel, Tractor Shovel, Truck Crane, Well Point, Winch Truck, Push Dozer, Grout Pump, High Lift, Fork Lift (regardless of lift height), all types of Boom Cats, Multiple Operator, Core Drill, Tow or Push Boat, A-Frame Winch Truck, Concrete Paver, Grade-All, Hoist, Hyster, Material Pump, Pumpcrete, Ross Carrier, Sheepfoot, Sideboom, Throttle-Valve Man, Rotary Drill, Power Generator, Mucking Machine, Rock Spreader attached to Equipment, Scoopmobile, KeCal Loader, Tower Cranes, (French, German and other types), Hydrocrane, Tugger, Backfiller Gurries, Self-propelled Compactor, Self-Contained Hydraulic Percussion Drill

GROUP 2: All Air Compressors (200 cu ft/min or greater), Bituminous Mixer, Concrete Mixer (21 cu. ft. or over), Welding Machine, Form Grader, Tractor (50 hp and over), Bull Float, Finish Machine, Outboard Motor Boat, Brakeman, Mechanic Tender, Whirly Oiler, Tract-air, Road Widening Trencher, Articulating Trucks

GROUP 3: Greaser on Grease Facilities servicing Heavy Equipment

GROUP 4: Bituminous Distributor, Cement Gun, Conveyor, Mud Jack, Paving Joint Machine, Pump, Tamping Machine, Tractor (under 50 hp), Vibrator, Oiler, Air Compressor (under 200 cu ft per minute), Concrete Saw, Burlap and Curing Machine, Hydro Seeder, Power Form Handling Equipment, Deckhand Oiler, Hydraulic Post Driver

SHEET METAL WORKER.....	\$ 20.40	7.80
TRUCK DRIVER		
Driver (3 Tons and Over), Driver (Truck Mounted Rotary Drill).....	\$ 23.74	14.50
Driver (3 Tons and Under), Tire Changer and Truck Mechanic Tender.....	\$ 23.53	14.50
Driver (Semi-Trailer or Pole Trailer), Driver (Dump Truck, Tandem Axle), Driver of Distributor.....	\$ 23.40	14.50
Driver on Mixer Trucks (All Types).....	\$ 23.45	14.50
Driver on Pavement Breakers.	\$ 23.55	14.50
Driver, Euclid and Other Heavy Earth Moving Equipment and Low Boy.....	\$ 24.31	14.50
Driver, Winch Truck and A- Frame when used in Transporting Materials.....	\$ 23.30	14.50
Greaser on Greasing Facilities.....	\$ 24.40	14.50
Truck Mechanic.....	\$ 23.50	14.50
Truck Tender and Warehouseman.....	\$ 23.20	14.50

WELDERS - Receive rate prescribed for craft performing
operation to which welding is incidental.

=====
Note: Executive Order (EO) 13706, Establishing Paid Sick Leave
for Federal Contractors applies to all contracts subject to the
Davis-Bacon Act for which the contract is awarded (and any
solicitation was issued) on or after January 1, 2017. If this
contract is covered by the EO, the contractor must provide
employees with 1 hour of paid sick leave for every 30 hours
they work, up to 56 hours of paid sick leave each year.
Employees must be permitted to use paid sick leave for their
own illness, injury or other health-related needs, including
preventive care; to assist a family member (or person who is
like family to the employee) who is ill, injured, or has other
health-related needs, including preventive care; or for reasons
resulting from, or to assist a family member (or person who is
like family to the employee) who is a victim of, domestic
violence, sexual assault, or stalking. Additional information
on contractor requirements and worker protections under the EO
is available at www.dol.gov/whd/govcontracts.

Unlisted classifications needed for work not included within
the scope of the classifications listed may be added after
award only as provided in the labor standards contract clauses
(29CFR 5.5 (a) (1) (ii)).

The body of each wage determination lists the classification and wage rates that have been found to be prevailing for the cited type(s) of construction in the area covered by the wage determination. The classifications are listed in alphabetical order of "identifiers" that indicate whether the particular rate is a union rate (current union negotiated rate for local), a survey rate (weighted average rate) or a union average rate (weighted union average rate).

Union Rate Identifiers

A four letter classification abbreviation identifier enclosed in dotted lines beginning with characters other than "SU" or "UAVG" denotes that the union classification and rate were prevailing for that classification in the survey. Example: PLUM0198-005 07/01/2014. PLUM is an abbreviation identifier of the union which prevailed in the survey for this classification, which in this example would be Plumbers. 0198 indicates the local union number or district council number where applicable, i.e., Plumbers Local 0198. The next number, 005 in the example, is an internal number used in processing the wage determination. 07/01/2014 is the effective date of the most current negotiated rate, which in this example is July 1, 2014.

Union prevailing wage rates are updated to reflect all rate changes in the collective bargaining agreement (CBA) governing this classification and rate.

Survey Rate Identifiers

Classifications listed under the "SU" identifier indicate that no one rate prevailed for this classification in the survey and the published rate is derived by computing a weighted average rate based on all the rates reported in the survey for that classification. As this weighted average rate includes all rates reported in the survey, it may include both union and non-union rates. Example: SULA2012-007 5/13/2014. SU indicates the rates are survey rates based on a weighted average calculation of rates and are not majority rates. LA indicates the State of Louisiana. 2012 is the year of survey on which these classifications and rates are based. The next number, 007 in the example, is an internal number used in producing the wage determination. 5/13/2014 indicates the survey completion date for the classifications and rates under that identifier.

Survey wage rates are not updated and remain in effect until a new survey is conducted.

Union Average Rate Identifiers

Classification(s) listed under the UAVG identifier indicate that no single majority rate prevailed for those classifications; however, 100% of the data reported for the classifications was union data. EXAMPLE: UAVG-OH-0010 08/29/2014. UAVG indicates that the rate is a weighted union average rate. OH indicates the state. The next number, 0010 in the example, is an internal number used in producing the wage

determination. 08/29/2014 indicates the survey completion date for the classifications and rates under that identifier.

A UAVG rate will be updated once a year, usually in January of each year, to reflect a weighted average of the current negotiated/CBA rate of the union locals from which the rate is based.

WAGE DETERMINATION APPEALS PROCESS

1.) Has there been an initial decision in the matter? This can be:

- * an existing published wage determination
- * a survey underlying a wage determination
- * a Wage and Hour Division letter setting forth a position on a wage determination matter
- * a conformance (additional classification and rate) ruling

On survey related matters, initial contact, including requests for summaries of surveys, should be with the Wage and Hour Regional Office for the area in which the survey was conducted because those Regional Offices have responsibility for the Davis-Bacon survey program. If the response from this initial contact is not satisfactory, then the process described in 2.) and 3.) should be followed.

With regard to any other matter not yet ripe for the formal process described here, initial contact should be with the Branch of Construction Wage Determinations. Write to:

Branch of Construction Wage Determinations
Wage and Hour Division
U.S. Department of Labor
200 Constitution Avenue, N.W.
Washington, DC 20210

2.) If the answer to the question in 1.) is yes, then an interested party (those affected by the action) can request review and reconsideration from the Wage and Hour Administrator (See 29 CFR Part 1.8 and 29 CFR Part 7). Write to:

Wage and Hour Administrator
U.S. Department of Labor
200 Constitution Avenue, N.W.
Washington, DC 20210

The request should be accompanied by a full statement of the interested party's position and by any information (wage payment data, project description, area practice material, etc.) that the requestor considers relevant to the issue.

3.) If the decision of the Administrator is not favorable, an interested party may appeal directly to the Administrative Review Board (formerly the Wage Appeals Board). Write to:

Administrative Review Board
U.S. Department of Labor
200 Constitution Avenue, N.W.
Washington, DC 20210

4.) All decisions by the Administrative Review Board are final.

=====
END OF GENERAL DECISION

Fringe benefit amounts are applicable for all hours worked except when otherwise noted.

No laborer, workman or mechanic shall be paid at a rate less than that of a Journeyman except those classified as bona fide apprentices.

Apprentices or trainees shall be permitted to work as such subject to Administrative Regulations adopted by the Commissioner of Workplace Standards. Copies of these regulations will be furnished upon request from any interested person.

Before using apprentices on the job the contractor shall present to the Contracting Officer written evidence of registration of such employees in a program of a State apprenticeship and training agency approved and recognized by the U. S. Bureau of Apprenticeship and Training. In the absence of such a State agency, the contractor shall submit evidence of approval and registration by the U. S. Bureau of Apprenticeship and Training.

The contractor shall submit to the Contracting Officer, written evidence of the established apprenticeship-journeyman ratios and wage rates in the project area, which will be the basis for establishing such ratios and rates for the project under the applicable contract provisions.

TO: EMPLOYERS/EMPLOYEES

PREVAILING WAGE SCHEDULE:

The wages indicated on this wage schedule are the least permitted to be paid for the occupations indicated. When an employee works in more than one classification, the employer must record the number of hours worked in each classification at the prescribed hourly base rate.

OVERTIME:

Overtime is to be paid to an employee at a rate not less than one and one-half times the basic rate of pay for all hours worked in excess of forty (40) hours in such workweek. Wage violations or questions should be directed to the designated Engineer or the undersigned.

Director
Division of Construction Procurement
Frankfort, Kentucky 40622
502-564-3500

**NOTICE OF REQUIREMENT FOR AFFIRMATIVE ACTION
TO ENSURE EQUAL EMPLOYMENT OPPORTUNITY
(Executive Order 11246)**

1. The Offeror's or Bidder's attention is called to the "Equal Opportunity Clause" and the "Standard Federal Equal Employment Specifications" set forth herein.
2. The goals and timetables for minority and female participation, expressed in percentage terms for the Contractor's aggregate work force in each trade on all construction work in the covered area, are as follows:

GOALS FOR MINORITY PARTICIPATION IN EACH TRADE	GOALS FOR FEMALE PARTICIPATION IN EACH TRADE
12.0%	6.9%

These goals are applicable to all the Contractor's construction work (whether or not it is Federal or federally-assisted) performed in the covered area. If the contractor performs construction work in a geographical area located outside of the covered area, it shall apply the goals established for such geographical area where the work is actually performed. With regard to this second area, the contractor also is subject to the goals for both its federally involved and non-federally involved construction.

The Contractor's compliance with the Executive Order and the regulations in CFR Part 60-4 shall be based on its implementation of the Equal Opportunity Clause, specific affirmative action obligations required by the specifications set forth in 41 CFR 60-4, 3(a), and its efforts to meet the goals. The hours of minority and female employment and training must be substantially uniform throughout the length of the contract, and in each trade, and the contractor shall make a good faith effort to employ minorities and women evenly on each of its projects. The transfer of minority or female employees or trainees from Contractor to Contractor or from project to project for the sole purpose of meeting the Contractor's goals shall be a violation of the contract, the Executive Order and the regulations in 41 CFR Part 60-4. Compliance with the goals will be measured against the total work hours performed.

3. The Contractor shall provide written notification to the Director of the Office of Federal Contract Compliance Programs within ten (10) working days of award of any construction subcontract in excess of \$10,000.00 at any tier for construction work under the contract resulting from this solicitation. The notification shall list the name, address and telephone number of the subcontractor; employer identification number of the subcontractor; estimated dollar amount of the subcontract; estimated starting and completion dates of the subcontract; and the geographical area in which the subcontract is to be performed. The notification shall be mailed to:

**Evelyn Teague, Regional Director
Office of Federal Contract Compliance Programs
61 Forsyth Street, SW, Suite 7B75
Atlanta, Georgia 30303-8609**

4. As used in this Notice, and in the contract resulting from this solicitation, the "**covered area**" is Allen County.

**NOTICE OF REQUIREMENT FOR AFFIRMATIVE ACTION
TO ENSURE EQUAL EMPLOYMENT OPPORTUNITY
(Executive Order 11246)**

1. The Offeror's or Bidder's attention is called to the "Equal Opportunity Clause" and the "Standard Federal Equal Employment Specifications" set forth herein.
2. The goals and timetables for minority and female participation, expressed in percentage terms for the Contractor's aggregate work force in each trade on all construction work in the covered area, are as follows:

GOALS FOR MINORITY PARTICIPATION IN EACH TRADE	GOALS FOR FEMALE PARTICIPATION IN EACH TRADE
12.0%	6.9%

These goals are applicable to all the Contractor's construction work (whether or not it is Federal or federally-assisted) performed in the covered area. If the contractor performs construction work in a geographical area located outside of the covered area, it shall apply the goals established for such geographical area where the work is actually performed. With regard to this second area, the contractor also is subject to the goals for both its federally involved and non-federally involved construction.

The Contractor's compliance with the Executive Order and the regulations in CFR Part 60-4 shall be based on its implementation of the Equal Opportunity Clause, specific affirmative action obligations required by the specifications set forth in 41 CFR 60-4, 3(a), and its efforts to meet the goals. The hours of minority and female employment and training must be substantially uniform throughout the length of the contract, and in each trade, and the contractor shall make a good faith effort to employ minorities and women evenly on each of its projects. The transfer of minority or female employees or trainees from Contractor to Contractor or from project to project for the sole purpose of meeting the Contractor's goals shall be a violation of the contract, the Executive Order and the regulations in 41 CFR Part 60-4. Compliance with the goals will be measured against the total work hours performed.

3. The Contractor shall provide written notification to the Director of the Office of Federal Contract Compliance Programs within ten (10) working days of award of any construction subcontract in excess of \$10,000.00 at any tier for construction work under the contract resulting from this solicitation. The notification shall list the name, address and telephone number of the subcontractor; employer identification number of the subcontractor; estimated dollar amount of the subcontract; estimated starting and completion dates of the subcontract; and the geographical area in which the subcontract is to be performed. The notification shall be mailed to:

**Evelyn Teague, Regional Director
Office of Federal Contract Compliance Programs
61 Forsyth Street, SW, Suite 7B75
Atlanta, Georgia 30303-8609**

4. As used in this Notice, and in the contract resulting from this solicitation, the "**covered area**" is Barren County.

**NOTICE OF REQUIREMENT FOR AFFIRMATIVE ACTION
TO ENSURE EQUAL EMPLOYMENT OPPORTUNITY
(Executive Order 11246)**

1. The Offeror's or Bidder's attention is called to the "Equal Opportunity Clause" and the "Standard Federal Equal Employment Specifications" set forth herein.
2. The goals and timetables for minority and female participation, expressed in percentage terms for the Contractor's aggregate work force in each trade on all construction work in the covered area, are as follows:

GOALS FOR MINORITY PARTICIPATION IN EACH TRADE	GOALS FOR FEMALE PARTICIPATION IN EACH TRADE
4.7%	6.9%

These goals are applicable to all the Contractor's construction work (whether or not it is Federal or federally-assisted) performed in the covered area. If the contractor performs construction work in a geographical area located outside of the covered area, it shall apply the goals established for such geographical area where the work is actually performed. With regard to this second area, the contractor also is subject to the goals for both its federally involved and non-federally involved construction.

The Contractor's compliance with the Executive Order and the regulations in CFR Part 60-4 shall be based on its implementation of the Equal Opportunity Clause, specific affirmative action obligations required by the specifications set forth in 41 CFR 60-4, 3(a), and its efforts to meet the goals. The hours of minority and female employment and training must be substantially uniform throughout the length of the contract, and in each trade, and the contractor shall make a good faith effort to employ minorities and women evenly on each of its projects. The transfer of minority or female employees or trainees from Contractor to Contractor or from project to project for the sole purpose of meeting the Contractor's goals shall be a violation of the contract, the Executive Order and the regulations in 41 CFR Part 60-4. Compliance with the goals will be measured against the total work hours performed.

3. The Contractor shall provide written notification to the Director of the Office of Federal Contract Compliance Programs within ten (10) working days of award of any construction subcontract in excess of \$10,000.00 at any tier for construction work under the contract resulting from this solicitation. The notification shall list the name, address and telephone number of the subcontractor; employer identification number of the subcontractor; estimated dollar amount of the subcontract; estimated starting and completion dates of the subcontract; and the geographical area in which the subcontract is to be performed. The notification shall be mailed to:

**Evelyn Teague, Regional Director
Office of Federal Contract Compliance Programs
61 Forsyth Street, SW, Suite 7B75
Atlanta, Georgia 30303-8609**

4. As used in this Notice, and in the contract resulting from this solicitation, the "**covered area**" is Daviess County.

**NOTICE OF REQUIREMENT FOR AFFIRMATIVE ACTION
TO ENSURE EQUAL EMPLOYMENT OPPORTUNITY
(Executive Order 11246)**

1. The Offeror's or Bidder's attention is called to the "Equal Opportunity Clause" and the "Standard Federal Equal Employment Specifications" set forth herein.
2. The goals and timetables for minority and female participation, expressed in percentage terms for the Contractor's aggregate work force in each trade on all construction work in the covered area, are as follows:

GOALS FOR MINORITY PARTICIPATION IN EACH TRADE	GOALS FOR FEMALE PARTICIPATION IN EACH TRADE
12.0%	6.9%

These goals are applicable to all the Contractor's construction work (whether or not it is Federal or federally-assisted) performed in the covered area. If the contractor performs construction work in a geographical area located outside of the covered area, it shall apply the goals established for such geographical area where the work is actually performed. With regard to this second area, the contractor also is subject to the goals for both its federally involved and non-federally involved construction.

The Contractor's compliance with the Executive Order and the regulations in CFR Part 60-4 shall be based on its implementation of the Equal Opportunity Clause, specific affirmative action obligations required by the specifications set forth in 41 CFR 60-4, 3(a), and its efforts to meet the goals. The hours of minority and female employment and training must be substantially uniform throughout the length of the contract, and in each trade, and the contractor shall make a good faith effort to employ minorities and women evenly on each of its projects. The transfer of minority or female employees or trainees from Contractor to Contractor or from project to project for the sole purpose of meeting the Contractor's goals shall be a violation of the contract, the Executive Order and the regulations in 41 CFR Part 60-4. Compliance with the goals will be measured against the total work hours performed.

3. The Contractor shall provide written notification to the Director of the Office of Federal Contract Compliance Programs within ten (10) working days of award of any construction subcontract in excess of \$10,000.00 at any tier for construction work under the contract resulting from this solicitation. The notification shall list the name, address and telephone number of the subcontractor; employer identification number of the subcontractor; estimated dollar amount of the subcontract; estimated starting and completion dates of the subcontract; and the geographical area in which the subcontract is to be performed. The notification shall be mailed to:

**Evelyn Teague, Regional Director
Office of Federal Contract Compliance Programs
61 Forsyth Street, SW, Suite 7B75
Atlanta, Georgia 30303-8609**

4. As used in this Notice, and in the contract resulting from this solicitation, the "**covered area**" is Logan County.

**NOTICE OF REQUIREMENT FOR AFFIRMATIVE ACTION
TO ENSURE EQUAL EMPLOYMENT OPPORTUNITY
(Executive Order 11246)**

1. The Offeror's or Bidder's attention is called to the "Equal Opportunity Clause" and the "Standard Federal Equal Employment Specifications" set forth herein.
2. The goals and timetables for minority and female participation, expressed in percentage terms for the Contractor's aggregate work force in each trade on all construction work in the covered area, are as follows:

GOALS FOR MINORITY PARTICIPATION IN EACH TRADE	GOALS FOR FEMALE PARTICIPATION IN EACH TRADE
3.5%	6.9%

These goals are applicable to all the Contractor's construction work (whether or not it is Federal or federally-assisted) performed in the covered area. If the contractor performs construction work in a geographical area located outside of the covered area, it shall apply the goals established for such geographical area where the work is actually performed. With regard to this second area, the contractor also is subject to the goals for both its federally involved and non-federally involved construction.

The Contractor's compliance with the Executive Order and the regulations in CFR Part 60-4 shall be based on its implementation of the Equal Opportunity Clause, specific affirmative action obligations required by the specifications set forth in 41 CFR 60-4, 3(a), and its efforts to meet the goals. The hours of minority and female employment and training must be substantially uniform throughout the length of the contract, and in each trade, and the contractor shall make a good faith effort to employ minorities and women evenly on each of its projects. The transfer of minority or female employees or trainees from Contractor to Contractor or from project to project for the sole purpose of meeting the Contractor's goals shall be a violation of the contract, the Executive Order and the regulations in 41 CFR Part 60-4. Compliance with the goals will be measured against the total work hours performed.

3. The Contractor shall provide written notification to the Director of the Office of Federal Contract Compliance Programs within ten (10) working days of award of any construction subcontract in excess of \$10,000.00 at any tier for construction work under the contract resulting from this solicitation. The notification shall list the name, address and telephone number of the subcontractor; employer identification number of the subcontractor; estimated dollar amount of the subcontract; estimated starting and completion dates of the subcontract; and the geographical area in which the subcontract is to be performed. The notification shall be mailed to:

**Evelyn Teague, Regional Director
Office of Federal Contract Compliance Programs
61 Forsyth Street, SW, Suite 7B75
Atlanta, Georgia 30303-8609**

4. As used in this Notice, and in the contract resulting from this solicitation, the "**covered area**" is McLean County.

**NOTICE OF REQUIREMENT FOR AFFIRMATIVE ACTION
TO ENSURE EQUAL EMPLOYMENT OPPORTUNITY
(Executive Order 11246)**

1. The Offeror's or Bidder's attention is called to the "Equal Opportunity Clause" and the "Standard Federal Equal Employment Specifications" set forth herein.
2. The goals and timetables for minority and female participation, expressed in percentage terms for the Contractor's aggregate work force in each trade on all construction work in the covered area, are as follows:

GOALS FOR MINORITY PARTICIPATION IN EACH TRADE	GOALS FOR FEMALE PARTICIPATION IN EACH TRADE
12.0%	6.9%

These goals are applicable to all the Contractor's construction work (whether or not it is Federal or federally-assisted) performed in the covered area. If the contractor performs construction work in a geographical area located outside of the covered area, it shall apply the goals established for such geographical area where the work is actually performed. With regard to this second area, the contractor also is subject to the goals for both its federally involved and non-federally involved construction.

The Contractor's compliance with the Executive Order and the regulations in CFR Part 60-4 shall be based on its implementation of the Equal Opportunity Clause, specific affirmative action obligations required by the specifications set forth in 41 CFR 60-4, 3(a), and its efforts to meet the goals. The hours of minority and female employment and training must be substantially uniform throughout the length of the contract, and in each trade, and the contractor shall make a good faith effort to employ minorities and women evenly on each of its projects. The transfer of minority or female employees or trainees from Contractor to Contractor or from project to project for the sole purpose of meeting the Contractor's goals shall be a violation of the contract, the Executive Order and the regulations in 41 CFR Part 60-4. Compliance with the goals will be measured against the total work hours performed.

3. The Contractor shall provide written notification to the Director of the Office of Federal Contract Compliance Programs within ten (10) working days of award of any construction subcontract in excess of \$10,000.00 at any tier for construction work under the contract resulting from this solicitation. The notification shall list the name, address and telephone number of the subcontractor; employer identification number of the subcontractor; estimated dollar amount of the subcontract; estimated starting and completion dates of the subcontract; and the geographical area in which the subcontract is to be performed. The notification shall be mailed to:

**Evelyn Teague, Regional Director
Office of Federal Contract Compliance Programs
61 Forsyth Street, SW, Suite 7B75
Atlanta, Georgia 30303-8609**

4. As used in this Notice, and in the contract resulting from this solicitation, the "**covered area**" is Metcalfe County.

**NOTICE OF REQUIREMENT FOR AFFIRMATIVE ACTION
TO ENSURE EQUAL EMPLOYMENT OPPORTUNITY
(Executive Order 11246)**

1. The Offeror's or Bidder's attention is called to the "Equal Opportunity Clause" and the "Standard Federal Equal Employment Specifications" set forth herein.
2. The goals and timetables for minority and female participation, expressed in percentage terms for the Contractor's aggregate work force in each trade on all construction work in the covered area, are as follows:

GOALS FOR MINORITY PARTICIPATION IN EACH TRADE	GOALS FOR FEMALE PARTICIPATION IN EACH TRADE
3.5%	6.9%

These goals are applicable to all the Contractor's construction work (whether or not it is Federal or federally-assisted) performed in the covered area. If the contractor performs construction work in a geographical area located outside of the covered area, it shall apply the goals established for such geographical area where the work is actually performed. With regard to this second area, the contractor also is subject to the goals for both its federally involved and non-federally involved construction.

The Contractor's compliance with the Executive Order and the regulations in CFR Part 60-4 shall be based on its implementation of the Equal Opportunity Clause, specific affirmative action obligations required by the specifications set forth in 41 CFR 60-4, 3(a), and its efforts to meet the goals. The hours of minority and female employment and training must be substantially uniform throughout the length of the contract, and in each trade, and the contractor shall make a good faith effort to employ minorities and women evenly on each of its projects. The transfer of minority or female employees or trainees from Contractor to Contractor or from project to project for the sole purpose of meeting the Contractor's goals shall be a violation of the contract, the Executive Order and the regulations in 41 CFR Part 60-4. Compliance with the goals will be measured against the total work hours performed.

3. The Contractor shall provide written notification to the Director of the Office of Federal Contract Compliance Programs within ten (10) working days of award of any construction subcontract in excess of \$10,000.00 at any tier for construction work under the contract resulting from this solicitation. The notification shall list the name, address and telephone number of the subcontractor; employer identification number of the subcontractor; estimated dollar amount of the subcontract; estimated starting and completion dates of the subcontract; and the geographical area in which the subcontract is to be performed. The notification shall be mailed to:

**Evelyn Teague, Regional Director
Office of Federal Contract Compliance Programs
61 Forsyth Street, SW, Suite 7B75
Atlanta, Georgia 30303-8609**

4. As used in this Notice, and in the contract resulting from this solicitation, the "**covered area**" is Muhlenberg County.

PART IV
INSURANCE

Refer to
Kentucky Standard Specifications for Road and Bridge Construction,
current edition

PART V
BID ITEMS

PROPOSAL BID ITEMS

194117

Page 1 of 1

Report Date 7/2/19

Section: 0001 - ROADWAY

LINE	BID CODE	ALT	DESCRIPTION	QUANTITY	UNIT	UNIT PRIC	FP	AMOUNT
0010	02650		MAINTAIN & CONTROL TRAFFIC DISTRICT 2	1.00	LS		\$	
0020	02650		MAINTAIN & CONTROL TRAFFIC DISTRICT 3	1.00	LS		\$	
0030	06556		PAVE STRIPING-DUR TY 1-6 IN W	18,178.00	LF		\$	
0040	06557		PAVE STRIPING-DUR TY 1-6 IN Y	18,273.00	LF		\$	
0050	24995EC		PAVE STRIPING-SPRAY THERMO-6 IN W	1,152,275.00	LF		\$	
0060	24996EC		PAVE STRIPING-SPRAY THERMO-6 IN Y	1,118,521.00	LF		\$	

Section: 0002 - DEMOBILIZATION

LINE	BID CODE	ALT	DESCRIPTION	QUANTITY	UNIT	UNIT PRIC	FP	AMOUNT
0070	02569		DEMOBILIZATION	1.00	LS		\$	