



CALL NO. 110

CONTRACT ID. 201021

LIVINGSTON COUNTY

FED/STATE PROJECT NUMBER STP BRO 0601 (196)

DESCRIPTION US-60

WORK TYPE BRIDGE WITH GRADE, DRAIN & SURFACE

PRIMARY COMPLETION DATE 12/1/2023

LETTING DATE: April 24,2020

Sealed Bids will be received electronically through the Bid Express bidding service until 10:00 am EASTERN DAYLIGHT TIME April 24,2020. Bids will be publicly announced at 10:00 am EASTERN DAYLIGHT TIME.

PLANS AVAILABLE FOR THIS PROJECT.

DBE CERTIFICATION REQUIRED - 6.50%

REQUIRED BID PROPOSAL GUARANTY: Not less than 5% of the total bid.

TABLE OF CONTENTS

PART I	SCOPE OF WORK
	<ul style="list-style-type: none">• PROJECT(S), COMPLETION DATE(S), & LIQUIDATED DAMAGES• CONTRACT NOTES• FEDERAL CONTRACT NOTES• TRAINEES• ASPHALT MIXTURE• INCIDENTAL SURFACING• FUEL AND ASPHALT PAY ADJUSTMENT• ASPHALT PAVEMENT RIDE QUALITY CAT A• COMPACTION OPTION A• MATERIAL TRANSFER VEHICLE (MTV)• SPECIAL NOTE(S) APPLICABLE TO PROJECT• TREE REMOVAL• CONCRETE SLURRY• SPECIAL NOTE FOR PIPELINE INSPECTION• BRIDGE DEMOLITION, RENOVATION• ASBESTOS ABATEMENT REPORT• RIGHT OF WAY NOTES• UTILITY IMPACT & RAIL CERTIFICATION NOTES• KPDES STORM WATER PERMIT, BMP AND ENOI• GUARDRAIL DELIVERY VERIFICATION SHEET
PART II	SPECIFICATIONS AND STANDARD DRAWINGS
	<ul style="list-style-type: none">• SPECIFICATIONS REFERENCE• SUPPLEMENTAL SPECIFICATION• [SN-1I] PORTABLE CHANGEABLE SIGNS• [SN-11M] BARCODE LABEL ON PERMANENT SIGNS• [SN-11N] LONGITUDINAL PAVEMENT JOINT ADHESIVE• [SP-69] EMBANKMENT AT BRIDGE END BENT STRUCTURES
PART III	EMPLOYMENT, WAGE AND RECORD REQUIREMENTS
	<ul style="list-style-type: none">• FEDERAL-AID CONSTRUCTION CONTRACTS - FHWA 1273• NONDISCRIMINATION OF EMPLOYEES• EXECUTIVE BRANCH CODE OF ETHICS• TRAINING SPECIAL PROVISIONS• PROJECT WAGE RATES LOCALITY 1 / FEDERAL• PROJECT WAGE RATES (HEAVY)• NOTICE OF REQUIREMENT FOR AFFIRMATIVE ACTION TO ENSURE EEO LIVINGSTON
PART IV	INSURANCE
PART V	BID ITEMS

PART I
SCOPE OF WORK

ADMINISTRATIVE DISTRICT - 01

CONTRACT ID - 201021

STP BRO 0601 (196)

COUNTY - LIVINGSTON

PCN - DE07000602021

STP BRO 0601 (196)

US-60 (MP 12.524) ADDRESS DEFICIENCIES OF BRIDGE ON US-60 OVER THE CUMBERLAND RIVER 0.27 MILES NORTH OF KY-70 (MP 12.868), A DISTANCE OF 0.81 MILES. BRIDGE WITH GRADE, DRAIN & SURFACE SYP NO. 01-01142.00.

GEOGRAPHIC COORDINATES LATITUDE 37:08:55.00 LONGITUDE 88:23:58.00

COMPLETION DATE(S):

COMPLETED BY 12/01/2023

APPLIES TO ENTIRE CONTRACT

APPLIES TO EXISTING BRIDGE

COMPLETED BY 09/01/2020

REPAIRS

CONTRACT NOTES

PROPOSAL ADDENDA

All addenda to this proposal must be applied when calculating bid and certified in the bid packet submitted to the Kentucky Department of Highways. Failure to use the correct and most recent addenda may result in the bid being rejected.

BID SUBMITTAL

Bidder must use the Department's electronic bidding software. The Bidder must download the bid file located on the Bid Express website (www.bidx.com) to prepare a bid packet for submission to the Department. The bidder must submit electronically using Bid Express.

JOINT VENTURE BIDDING

Joint venture bidding is permissible. All companies in the joint venture must be prequalified in one of the work types in the Qualifications for Bidders for the project. The bidders must get a vendor ID for the joint venture from the Division of Construction Procurement and register the joint venture as a bidder on the project. Also, the joint venture must obtain a digital ID from Bid Express to submit a bid. A joint bid bond of 5% may be submitted for both companies or each company may submit a separate bond of 5%.

UNDERGROUND FACILITY DAMAGE PROTECTION

The contractor shall make every effort to protect underground facilities from damage as prescribed in the Underground Facility Damage Protection Act of 1994, Kentucky Revised Statute KRS 367.4901 to 367.4917. It is the contractor's responsibility to determine and take steps necessary to be in compliance with federal and state damage prevention directives. When prescribed in said directives, the contractor shall submit Excavation Locate Requests to the Kentucky Contact Center (KY811) via web ticket entry. The submission of this request does not relieve the contractor from the responsibility of contacting non-member facility owners, whom shall be contacted through their individual Protection Notification Center. Non-compliance with these directives can result in the enforcement of penalties.

REGISTRATION WITH THE SECRETARY OF STATE BY A FOREIGN ENTITY

Pursuant to KRS 176.085(1)(b), an agency, department, office, or political subdivision of the Commonwealth of Kentucky shall not award a state contract to a person that is a foreign entity required by [KRS 14A.9-010](#) to obtain a certificate of authority to transact business in the Commonwealth ("certificate") from the Secretary of State under [KRS 14A.9-030](#) unless the person produces the certificate within fourteen (14) days of the bid or proposal opening. If the foreign entity is not required to obtain a certificate as provided in [KRS 14A.9-010](#), the foreign entity should identify the applicable exception. Foreign entity is defined within [KRS 14A.1-070](#).

For all foreign entities required to obtain a certificate of authority to transact business in the Commonwealth, if a copy of the certificate is not received by the contracting agency within the time frame identified above, the foreign entity's solicitation response shall be deemed non-responsive or the awarded contract shall be cancelled.

Businesses can register with the Secretary of State at <https://secure.kentucky.gov/sos/ftbr/welcome.aspx>.

SPECIAL NOTE FOR PROJECT QUESTIONS DURING ADVERTISEMENT

Questions about projects during the advertisement should be submitted in writing to the Division of Construction Procurement. This may be done by fax (502) 564-7299 or email to kytc.projectquestions@ky.gov. The Department will attempt to answer all submitted questions. The Department reserves the right not to answer if the question is not pertinent or does not aid in clarifying the project intent.

The deadline for posting answers will be 3:00 pm Eastern Daylight Time, the day preceding the Letting. Questions may be submitted until this deadline with the understanding that the later a question is submitted, the less likely an answer will be able to be provided.

The questions and answers will be posted for each Letting under the heading "Questions & Answers" on the Construction Procurement website (www.transportation.ky.gov/contract). The answers provided shall be considered part of this Special Note and, in case of a discrepancy, will govern over all other bidding documents.

HARDWOOD REMOVAL RESTRICTIONS

The US Department of Agriculture has imposed a quarantine in Kentucky and several surrounding states, to prevent the spread of an invasive insect, the emerald ash borer. Hardwood cut in conjunction with the project may not be removed from the state. Chipping or burning on site is the preferred method of disposal.

INSTRUCTIONS FOR EXCESS MATERIAL SITES AND BORROW SITES

Identification of excess material sites and borrow sites shall be the responsibility of the Contractor. The Contractor shall be responsible for compliance with all applicable state and federal laws and may wish to consult with the US Fish and Wildlife Service to seek protection under Section 10 of the Endangered Species Act for these activities.

ACCESS TO RECORDS

The contractor, as defined in KRS 45A.030 (9) agrees that the contracting agency, the Finance and Administration Cabinet, the Auditor of Public Accounts, and the Legislative Research Commission, or their duly authorized representatives, shall have access to any books, documents, papers, records, or other evidence, which are directly pertinent to this contract for the purpose of financial audit or program review. Records and other prequalification information confidentially

disclosed as part of the bid process shall not be deemed as directly pertinent to the contract and shall be exempt from disclosure as provided in KRS 61.878(1)(c). The contractor also recognizes that any books, documents, papers, records, or other evidence, received during a financial audit or program review shall be subject to the Kentucky Open Records Act, KRS 61.870 to 61.884.

In the event of a dispute between the contractor and the contracting agency, Attorney General, or the Auditor of Public Accounts over documents that are eligible for production and review, the Finance and Administration Cabinet shall review the dispute and issue a determination, in accordance with Secretary's Order 11-004.

April 30, 2018

FEDERAL CONTRACT NOTES

The Kentucky Department of Highways, in accordance with the Regulations of the United States Department of Transportation 23 CFR 635.112 (h), hereby notifies all bidders that failure by a bidder to comply with all applicable sections of the current Kentucky Standard Specifications, including, but not limited to the following, may result in a bid not being considered responsive and thus not eligible to be considered for award:

- | | |
|--------------------------------|--|
| 102.02 Current Rating | 102.08 Preparation and Delivery of Proposals |
| 102.13 Irregular Bid Proposals | 102.14 Disqualification of Bidders |
| 102.09 Proposal Guaranty | |

CIVIL RIGHTS ACT OF 1964

The Kentucky Department of Highways, in accordance with the provisions of Title VI of the Civil Rights Act of 1964 (78 Stat. 252) and the Regulations of the Federal Department of Transportation (49 C.F.R., Part 21), issued pursuant to such Act, hereby notifies all bidders that it will affirmatively insure that the contract entered into pursuant to this advertisement will be awarded to the lowest responsible bidder without discrimination on the ground of race, color, or national origin.

NOTICE TO ALL BIDDERS

To report bid rigging activities call: 1-800-424-9071.

The U.S. Department of Transportation (DOT) operates the above toll-free "hotline" Monday through Friday, 8:00 a.m. to 5:00 p.m. eastern time. Anyone with knowledge of possible bid rigging, bidder collusion, or other fraudulent activities should use the "hotline" to report such activities.

The "hotline" is part of the DOT's continuing effort to identify and investigate highway construction contract fraud and abuse and is operated under the direction of the DOT Inspector General. All information will be treated confidentially and caller anonymity will be respected.

SECOND TIER SUBCONTRACTS

Second Tier subcontracts on federally assisted projects shall be permitted. However, in the case of DBE's, second tier subcontracts will only be permitted where the other subcontractor is also a DBE. All second tier subcontracts shall have the consent of both the Contractor and the Engineer.

DISADVANTAGED BUSINESS ENTERPRISE PROGRAM

It is the policy of the Kentucky Transportation Cabinet (“the Cabinet”) that Disadvantaged Business Enterprises (“DBE”) shall have the opportunity to participate in the performance of highway construction projects financed in whole or in part by Federal Funds in order to create a level playing field for all businesses who wish to contract with the Cabinet. To that end, the Cabinet will comply with the regulations found in 49 CFR Part 26, and the definitions and requirements contained therein shall be adopted as if set out verbatim herein.

The Cabinet, contractors, subcontractors, and sub-recipients shall not discriminate on the basis of race, color, national origin, or sex in the performance of work performed pursuant to Cabinet contracts. The contractor shall carry out applicable requirements of 49 CFR 26 in the award and administration of federally assisted highway construction projects. The contractor will include this provision in all its subcontracts and supply agreements pertaining to contracts with the Cabinet.

Failure by the contractor to carry out these requirements is a material breach of its contract with the Cabinet, which may result in the termination of the contract or such other remedy as the Cabinet deems necessary.

DBE GOAL

The Disadvantaged Business Enterprise (DBE) goal established for this contract, as listed on the front page of the proposal, is the percentage of the total value of the contract.

The contractor shall exercise all necessary and reasonable steps to ensure that Disadvantaged Business Enterprises participate in a least the percent of the contract as set forth above as goals for this contract.

OBLIGATION OF CONTRACTORS

Each contractor prequalified to perform work on Cabinet projects shall designate and make known to the Cabinet a liaison officer who is assigned the responsibility of effectively administering and promoting an active program for utilization of DBEs.

If a formal goal has not been designated for the contract, all contractors are encouraged to consider DBEs for subcontract work as well as for the supply of material and services needed to perform this work.

Contractors are encouraged to use the services of banks owned and controlled by minorities and women.

CERTIFICATION OF CONTRACT GOAL

Contractors shall include the following certification in bids for projects for which a DBE goal has been established. BIDS SUBMITTED WHICH DO NOT INCLUDE CERTIFICATION OF DBE PARTICIPATION WILL NOT BE ACCEPTED. These bids will not be considered for award by the Cabinet and they will be returned to the bidder.

“The bidder certifies that it has secured participation by Disadvantaged Business Enterprises (“DBE”) in the amount of _____ percent of the total value of this contract and that the DBE participation is in compliance with the requirements of 49 CFR 26 and the policies of the Kentucky Transportation Cabinet pertaining to the DBE Program.”

The certification statement is located in the electronic bid file. All contractors must certify their DBE participation on that page. DBEs utilized in achieving the DBE goal must be certified and prequalified for the work items at the time the bid is submitted.

DBE PARTICIPATION PLAN

Lowest responsive bidders must submit the *DBE Plan/ Subcontractor Request*, form TC 14-35 DBE, within **5** days of the letting. This is necessary before the Awards Committee will review and make a recommendation. **The project will not be considered for award prior to submission and approval of the apparent low bidder’s DBE Plan/Subcontractor Request.**

The DBE Participation Plan shall include the following:

1. Name and address of DBE Subcontractor(s) and/or supplier(s) intended to be used in the proposed project;
2. Description of the work each is to perform including the work item, unit, quantity, unit price and total amount of the work to be performed by the individual DBE. The Proposal Line Number, Category Number, and the Project Line Number can be found in the “material listing” on the Construction Procurement website under the specific letting;
3. The dollar value of each proposed DBE subcontract and the percentage of total project contract value this represents. DBE participation may be counted as follows:
 - a. If DBE suppliers and manufactures assume actual and contractual responsibility, the dollar value of materials to be furnished will be counted toward the goal as follows:
 - The entire expenditure paid to a DBE manufacturer;
 - 60 percent of expenditures to DBE suppliers that are not manufacturers provided the supplier is a regular dealer in the product involved. A regular dealer must be engaged in, as its principal business and in its own name, the sale of products to the public, maintain an inventory and own and operate distribution equipment; and
 - The amount of fees or commissions charged by the DBE firms for a bona fide service, such as professional, technical, consultant, or managerial services and assistance in the procurement of essential personnel, facilities, equipment, materials, supplies, delivery of materials and supplies or for furnishing bonds, or insurance, providing such fees or commissions are determined to be reasonable and customary.

- b) The dollar value of services provided by DBEs such as quality control testing, equipment repair and maintenance, engineering, staking, etc.;
- c) The dollar value of joint ventures. DBE credit for joint ventures will be limited to the dollar amount of the work actually performed by the DBE in the joint venture;
- 4. Written and signed documentation of the bidder's commitment to use a DBE contractor whose participation is being utilized to meet the DBE goal; and
- 5. Written and signed confirmation from the DBE that it is participating in the contract as provided in the prime contractor's commitment.

UPON AWARD AND BEFORE A WORK ORDER WILL BE ISSUED

Contractors must submit the signed subcontract between the contractor and the DBE contractor, along with the DBE's certificate of insurance. If the DBE is a supplier of materials for the project, a signed purchase order must be submitted to the Division of Construction Procurement.

Changes to DBE Participation Plans must be approved by the Cabinet. The Cabinet may consider extenuating circumstances including, but not limited to, changes in the nature or scope of the project, the inability or unwillingness of a DBE to perform the work in accordance with the bid, and/or other circumstances beyond the control of the prime contractor.

CONSIDERATION OF GOOD FAITH EFFORTS REQUESTS

If the DBE participation submitted in the bid by the apparent lowest responsive bidder does not meet or exceed the DBE contract goal, the apparent lowest responsive bidder must submit a Good Faith Effort Package to satisfy the Cabinet that sufficient good faith efforts were made to meet the contract goals prior to submission of the bid. Efforts to increase the goal after bid submission will not be considered in justifying the good faith effort, unless the contractor can show that the proposed DBE was solicited prior to the letting date. DBEs utilized in achieving the DBE goal must be certified and prequalified for the work items at the time the bid is submitted. One complete set (hard copy along with an electronic copy) of this information must be received in the Division of Contract Procurement no later than 12:00 noon of the tenth calendar day after receipt of notification that they are the apparent low bidder.

Where the information submitted includes repetitious solicitation letters it will be acceptable to submit a sample representative letter along with a distribution list of the firms solicited. Documentation of DBE quotations shall be a part of the good faith effort submittal as necessary to demonstrate compliance with the factors listed below which the Cabinet considers in judging good faith efforts. This documentation may include written subcontractors' quotations, telephone log notations of verbal quotations, or other types of quotation documentation.

The Good Faith Effort Package shall include, but may not be limited to information showing evidence of the following:

1. Whether the bidder attended any pre-bid meetings that were scheduled by the Cabinet to inform DBEs of subcontracting opportunities;
2. Whether the bidder provided solicitations through all reasonable and available means;
3. Whether the bidder provided written notice to all DBEs listed in the DBE directory at the time of the letting who are prequalified in the areas of work that the bidder will be subcontracting;
4. Whether the bidder followed up initial solicitations of interest by contacting DBEs to determine with certainty whether they were interested. If a reasonable amount of DBEs within the targeted districts do not provide an intent to quote or no DBEs are prequalified in the subcontracted areas, the bidder must notify the Disadvantaged Enterprise Business Liaison Officer (DEBLO) in the Office of Civil Rights and Small Business Development to give notification of the bidder's inability to get DBE quotes;
5. Whether the bidder selected portions of the work to be performed by DBEs in order to increase the likelihood of meeting the contract goals. This includes, where appropriate, breaking out contract work items into economically feasible units to facilitate DBE participation, even when the prime contractor might otherwise perform these work items with its own forces;
6. Whether the bidder provided interested DBEs with adequate and timely information about the plans, specifications, and requirements of the contract;
7. Whether the bidder negotiated in good faith with interested DBEs not rejecting them as unqualified without sound reasons based on a thorough investigation of their capabilities. Any rejection should be so noted in writing with a description as to why an agreement could not be reached;
8. Whether quotations were received from interested DBE firms but were rejected as unacceptable without sound reasons why the quotations were considered unacceptable. The fact that the DBE firm's quotation for the work is not the lowest quotation received will not in itself be considered as a sound reason for rejecting the quotation as unacceptable. The fact that the bidder has the ability and/or desire to perform the contract work with its own forces will not be considered a sound reason for rejecting a DBE quote. Nothing in this provision shall be construed to require the bidder to accept unreasonable quotes in order to satisfy DBE goals;
9. Whether the bidder specifically negotiated with subcontractors to assume part of the responsibility to meet the contract DBE goal when the work to be subcontracted includes potential DBE participation;
10. Whether the bidder made any efforts and/or offered assistance to interested DBEs in obtaining the necessary equipment, supplies, materials, insurance and/or bonding to satisfy the work requirements of the bid proposal; and
11. Any other evidence that the bidder submits which may show that the bidder has made reasonable good faith efforts to include DBE participation.

FAILURE TO MEET GOOD FAITH REQUIREMENT

Where the apparent lowest responsive bidder fails to submit sufficient participation by DBE firms to meet the contract goal and upon a determination by the Good Faith Committee based upon the information submitted that the apparent lowest responsive bidder failed to make sufficient reasonable efforts to meet the contract goal, the bidder will be offered the opportunity to meet in person for administrative reconsideration. The bidder will be notified of the Committee's decision within 24 hours of its decision. The bidder will have 24 hours to request reconsideration of the Committee's decision. The reconsideration meeting will be held within two days of the receipt of a request by the bidder for reconsideration.

The request for reconsideration will be heard by the Office of the Secretary. The bidder will have the opportunity to present written documentation or argument concerning the issue of whether it met the goal or made an adequate good faith effort. The bidder will receive a written decision on the reconsideration explaining the basis for the finding that the bidder did or did not meet the goal or made adequate Good Faith efforts to do so.

The result of the reconsideration process is not administratively appealable to the Cabinet or to the United States Department of Transportation.

The Cabinet reserves the right to award the contract to the next lowest responsive bidder or to rebid the contract in the event that the contract is not awarded to the low bidder as the result of a failure to meet the good faith requirement.

SANCTIONS FOR FAILURE TO MEET DBE REQUIREMENTS OF THE PROJECT

Failure by the prime contractor to fulfill the DBE requirements of a project under contract or to demonstrate good faith efforts to meet the goal constitutes a breach of contract. When this occurs, the Cabinet will hold the prime contractor accountable, as would be the case with all other contract provisions. Therefore, the contractor's failure to carry out the DBE contract requirements shall constitute a breach of contract and as such the Cabinet reserves the right to exercise all administrative remedies at its disposal including, but not limited to the following:

- Disallow credit toward the DBE goal;
- Withholding progress payments;
- Withholding payment to the prime in an amount equal to the unmet portion of the contract goal; and/or
- Termination of the contract.

PROMPT PAYMENT

The prime contractor will be required to pay the DBE within seven (7) working days after he or she has received payment from the Kentucky Transportation Cabinet for work performed or materials furnished.

CONTRACTOR REPORTING

All contractors must keep detailed records and provide reports to the Cabinet on their progress in meeting the DBE requirement on any highway contract. These records may include, but shall not be limited to payroll, lease agreements, cancelled payroll checks, executed subcontracting agreements, etc. Prime contractors will be required to complete and submit a **signed and notarized** Affidavit of Subcontractor Payment (TC 18-7) and copies of checks for any monies paid to each DBE subcontractor or supplier utilized to meet a DBE goal. These documents must be completed and signed within 7 days of being paid by the Cabinet.

Payment information that needs to be reported includes date the payment is sent to the DBE, check number, Contract ID, amount of payment and the check date. Before Final Payment is made on this contract, the Prime Contractor will certify that all payments were made to the DBE subcontractor and/or DBE suppliers.

******* IMPORTANT *******

Please mail the original, signed and completed TC (18-7) Affidavit of Subcontractor Payment form and all copies of checks for payments listed above to the following address:

Office of Civil Rights and Small Business Development
6th Floor West 200 Mero Street
Frankfort, KY 40622

The prime contractor should notify the KYTC Office of Civil Rights and Small Business Development seven (7) days prior to DBE contractors commencing work on the project. The contact in this office is Mr. Melvin Bynes. Mr. Bynes' current contact information is email address – melvin.bynes2@ky.gov and the telephone number is (502) 564-3601.

DEFAULT OR DECERTIFICATION OF THE DBE

If the DBE subcontractor or supplier is decertified or defaults in the performance of its work, and the overall goal cannot be credited for the uncompleted work, the prime contractor may utilize a substitute DBE or elect to fulfill the DBE goal with another DBE on a different work item. If after exerting good faith effort in accordance with the Cabinet's Good Faith Effort policies and procedures, the prime contractor is unable to replace the DBE, then the unmet portion of the goal may be waived at the discretion of the Cabinet.

7/19/2019

LEGAL REQUIREMENTS AND RESPONSIBILITY TO THE PUBLIC – CARGO PREFERENCE ACT (CPA).

(REV 12-17-15) (1-16)

SECTION 7 is expanded by the following new Article:

102.10 **Cargo Preference Act – Use of United States-flag vessels.**

Pursuant to Title 46CFR Part 381, the Contractor agrees

- To utilize privately owned United States-flag commercial vessels to ship at least 50 percent of the gross tonnage (computed separately for dry bulk carriers, dry cargo liners, and tankers) involved, whenever shipping any equipment, material, or commodities pursuant to this contract, to the extent such vessels are available at fair and reasonable rates for United States-flag commercial vessels.

- To furnish within 20 days following the date of loading for shipments originating within the United States or within 30 working days following the date of loading for shipments originating outside the United States, a legible copy of a rated, 'on-board' commercial ocean bill-of-lading in English for each shipment of cargo described in paragraph 1 of this section to both the Contracting Officer (through the prime contractor in the case of subcontractor bills-of-lading) and to the Division of National Cargo, Office of Market Development, Maritime Administration, Washington, DC 20590.

- To insert the substance of the provisions of this clause in all subcontracts issued pursuant to this contract.

TRAINEES

In Compliance with the "TRAINING SPECIAL PROVISION" included in Part III of the Proposal, the Contractor will be required to employ a trainee(s) for this contract.

ASPHALT MIXTURE

Unless otherwise noted, the Department estimates the rate of application for all asphalt mixtures to be 110 lbs/sy per inch of depth.

INCIDENTAL SURFACING

The Department has included in the quantities of asphalt mixtures established in the proposal estimated quantities required for resurfacing or surfacing mailbox turnouts, farm field entrances, residential and commercial entrances, curve widening, ramp gores and tapers, and road and street approaches, as applicable. Pave these areas to the limits as shown on Standard Drawing RPM-110-06 or as directed by the Engineer. In the event signal detectors are present in the intersecting streets or roads, pave the crossroads to the right of way limit or back of the signal detector, whichever is the farthest back of the mainline. Surface or resurface these areas as directed by the Engineer. The Department will not measure placing and compacting for separate payment but shall be incidental to the Contract unit price for the asphalt mixtures.

FUEL AND ASPHALT PAY ADJUSTMENT

The Department has included the Contract items Asphalt Adjustment and Fuel Adjustment for possible future payments at an established Contract unit price of \$1.00. The Department will calculate actual adjustment quantities after work is completed. If existing Contract amount is insufficient to pay all items on the contract with the adjustments, the Department will establish additional monies with a change order.

ASPHALT PAVEMENT RIDE QUALITY CATEGORY A

The Department will apply Pavement Rideability Requirements on this project in accordance with Section 410, Category A.

OPTION A

Be advised that the Department will accept compaction of asphalt mixtures furnished for driving lanes and ramps, at 1 inch (25mm) or greater, on this project according to OPTION A in accordance with Section 402 and Section 403 of the current Standard Specifications. The Department will require joint cores as described in Section 402.03.02 for surface mixtures only. The Department will accept compaction of all other asphalt mixtures according to OPTION B.

MATERIAL TRANSFER VEHICLE (MTV)

Provide and use a MTV in accordance with Sections 403.02.10 and 403.03.05.

US-60 over CUMBERLAND RIVER - EXISTING BRIDGE REPAIRS
PROPOSAL BID ITEMS

Line	Bid Code	Description	Quantity	Unit
001	22146EN	CONCRETE PATCHING REPAIR	400	SF
002	25015EC	FRP WRAP	2234	SF
003	23853EC	BEARING REPAIRS	6	EA
004	02671	PORTABLE CHANGEABLE MESSAGE SIGN	2	EA
005	02650	MAINTAIN AND CONTROL TRAFFIC	1	LS

**SPECIAL NOTE FOR MILESTONE COMPLETION DATE
AND LIQUIDATED DAMAGES ON EXISTING BRIDGE
REPAIRS**

- I. COMPLETION DATE.** All work described in the existing bridge repair notes and details is to be completed by September 1, 2020. The Contractor must notify the Department seven (14) calendar days before contract work begins on the existing bridge repairs.

- II. LIQUIDATED DAMAGES.** Liquidated damages will be assessed on the Contractor in accordance with the Transportation Cabinet, Department of Highway's 2019 Standard Specifications for Road and Bridge Construction, Section 108.09, at a rate of \$2,500 per calendar day, when the September 1, 2020 date is exceeded.

All construction must be completed in accordance with the weather limitations specified in Section 606 and/or Section 601 as applicable. No extension of Contract time will be granted due to inclement weather or temperature limitations.

SPECIAL NOTE FOR TRAFFIC CONTROL ON BRIDGE REPAIR CONTRACTS

I. TRAFFIC CONTROL GENERAL

Except as provided herein, traffic shall be maintained in accordance with the current standard specifications, section 112. The contractor will be responsible for developing and implementing the maintenance of traffic details with guidance through standard drawings and the MUTCD current editions. The developed traffic control plan must be approved by the Engineer prior to implementation. The contractor is expected to provide at a minimum the items listed in this note, however this note does not relieve the contractor of other items that may be necessary to comply with current standards. Except for the roadway and traffic control bid items listed, all items of work necessary to maintain and control traffic will be paid at the lump sum bid price to "Maintain and Control Traffic".

Contrary to section 106.01, traffic control devices used on this project may be new or used in new condition, at the beginning of the work and maintained in like new condition until completion of the work.

The contractor must notify the engineer and public information officer at least 14 calendar days prior to the beginning work. Please see the Special Note for Existing Bridge Repairs Completion Date for additional information.

II. TRAFFIC COORDINATOR

Furnish a traffic coordinator as per section 112. The traffic coordinator shall inspect the project maintenance of traffic, at least three times daily, or as directed by the engineer, during the contractor's operations and at any time a bi-directional lane closure or road closure is in place. The personnel shall have access on the project to a radio or telephone to be used in case of emergencies or accidents. The traffic coordinator shall report all incidents throughout the work zone to the engineer on the project. The contractor shall furnish the name and telephone number where the traffic coordinator can be contacted at all times.

III. SIGNS

The contractor is responsible for all signage during construction. The contractor shall adhere to the standard drawings and manual on uniform traffic control devices (MUTCD) for guidance. If, at any time, the engineer requests a change in the maintenance of traffic signage, the contractor shall implement the change within 8 hours. Failure to implement these changes within the required eight hours will result in liquidated damages of \$5,000 per day.

The department will not measure installation, maintenance, or removal for payment of any detour signage or standard construction signage, and will consider these incidental to “Maintain and Control Traffic”

Closure signs, detour signs, and bi-directional lane closure signs should be placed no sooner than two weeks prior to the closing of the bridge (when applicable) or placing lane closures.

IV. Lane Closure

Full Closure of the bridge shall not be permitted. The Contractor may utilize bi-directional lane closures if deemed necessary provided that a minimum 10-foot driving lane is maintained.

V. PROJECT PHASING & CONSTRUCTION PROCEDURES

Project phasing shall be as directed by the plans, special notes, and the approved Traffic Control Plan prepared by the contractor. Maintain traffic over the bridge as long as possible. Once work on the structure begins that impacts traffic, ensure work progresses to minimize the effected time to the public.

VI. VARIABLE MESSAGE SIGNS AND TEMPORARY TRAFFIC SIGNALS

At the direction of the Engineer, the contractor is expected to provide up to two (2) message boards for use at locations determined by the Engineer. These message boards are expected to be in place one week prior to any lane closures and remain in place for the duration of the closure. The message boards will be paid for as per the standard specifications.

For projects that involve the use of lane closures, all lane closures shall be bi-directional. The contractor shall provide temporary traffic signals and all labor, materials, and incidentals needed to maintain bi-directional traffic for the project. For short term bi-directional lane closures, the use of flaggers in lieu of temporary traffic signals may be acceptable if approved by the Engineer.

VIII. PAYMENT

Unless listed as a bid item in the contract documents, payment will only be made for the following items:

1. Portable Changeable Message Boards - Each
2. Maintain and Control Traffic - Lump Sum

All other items needed to maintain traffic in accordance with these contract documents and the approved traffic control plan shall be considered incidental to Maintain and Control Traffic. These items include but are not limited to traffic signals, signs, barrier wall, crash cushions, temporary guardrail, temporary and permanent pavement striping, cones, barrels, flaggers, etc.

SPECIAL NOTE FOR CONCRETE PATCHING REPAIR

These Notes or designated portions thereof, apply where so indicated on the plans, proposals or bidding instruction.

I. DESCRIPTION.

Perform all work in accordance with the Department's current Standard Specifications for Roads and Bridges, and applicable Supplemental Specifications, the attached sketches, and these Notes. Section references are to the Standard Specifications.

This work consists of: (1) Furnish all labor, materials, tools, and equipment; (2) Remove existing spalled/delaminated concrete; (3) Prepare the existing surface for concrete patching; (4) Place hook fasteners and welded wire fabric over surfaces to be repaired (where applicable); (5) Apply concrete patching as specified by this note and as shown on the attached detail drawings; (6) Finish and cure the new Concrete Patches; (7) Maintain & control traffic; and, (8) Any other work specified as part of this contract.

II. MATERIALS.

- A. **Self-Consolidating Concrete.** Refer to list of approved materials or Kentucky Product Evaluation List.
- B. **Vertical and Overhead Patch Material.** From approved KYTC Division of Materials List.
- C. **Steel Reinforcement.** Use Grade 60. See Section 602
- D. **Welded Steel Wire Fabric (WWF).** Conform to Section 811
- E. **Hook Fasteners.** Use commercial grade galvanized hook fasteners. Minimum 3/16" diameter.

III. CONSTRUCTION.

- A. **Concrete Removal and Preparation.** The Contractor, as directed by the Engineer shall locate and remove all loose, spalled, deteriorated and delaminated concrete. Sounding shall be used to locate delaminated areas. Care shall be exercised not to damage areas of sound concrete or reinforcing steel during concrete removal operations. Concrete removal shall be in accordance with a sequence approved by the Engineer.

Concrete removal shall be accomplished by chipping with hand picks, chisels or light duty pneumatic or electric chipping hammers (not to exceed 15 lbs.). Remove all deteriorated loose concrete a minimum depth of 3/4" behind bar, and at least 1/4" greater than the largest size of aggregate in the repair mix., Care shall be taken to not damage bond to adjacent non-exposed reinforcing steel during concrete

removal processes. Unless specifically *directed by the Engineer*, depth of removal shall not exceed 6 inches. The outer edges of all chipped areas shall be saw cut to a minimum depth of 1 inch to prevent featheredging unless otherwise approved by the Engineer.

The perimeter of all areas where concrete is removed shall be sawcut at a 90° angle.

After all deteriorated concrete has been removed; the repair surface to receive concrete patching shall be prepared by abrasive blast cleaning or water blast cleaning (greater than 5,000 psi). Abrasive blast cleaning shall remove all fractured surface concrete and all traces of any unsound material or contaminants such as oil, grease, dirt, slurry, or any materials which could interfere with the bond of freshly placed concrete. The abrasive blast cleaning shall produce a Concrete Surface Profile (CSP) of a 6 or greater as per the current guidelines established by the International Concrete Repair Institute (ICRI), Technical Guideline 310.2R-2013.

The Contractor shall dispose all removed material in an approved site.

- B. Steel Reinforcement.** All corroded reinforcing steel exposed during concrete removal shall have corrosion products removed by abrasive grit blasting or wire brush whichever is more appropriate. Furnish for replacement, as directed by the Engineer, additional linear feet of steel reinforcing bars ½” diameter by 20-foot lengths. Place these bars in areas deemed by the Engineer to require additional reinforcement. Field cutting and bending is permitted. Deliver unused bars to the nearest County Maintenance Barn.

Reinforcing steel displaying deep pitting or loss of more than 20 percent of cross-sectional area shall be removed and replaced. Reinforcement shall be placed such that the minimum spacing around each bar is three times the maximum aggregate size to allow for proper encapsulation with concrete patching.

Intersecting reinforcing bars shall be tightly secured to each other using tie wire and adequately supported to minimize movement during concrete placement.

- C. Concrete Repairs.** Place and finish the new concrete for the patching area in accordance with the manufacturer’s recommendations, as shown on the attached detail drawings, and as directed by the Engineer. For repairs greater than 1 square foot in surface area, the contractor must use self-consolidating repairs and use a form-and-pour technique (hand application is not allowed). Vertical and Overhead Patching material may be applied by hand troweling for repairs less than one square foot. The Engineer shall approve the Contractor’s method of placing and consolidating the concrete prior to the beginning of this operation.

- D. Curing.** On completion of finishing operation, patching concrete shall immediately be prevented from drying out and cracking by fogging, wetting, and/or any appropriate method approved by the Engineer. Curing shall continue for the duration recommended by the product manufacturer.

- F. Quality Control/Testing.** After completion of the curing, tensile bond testing shall be performed. The testing shall be in accordance with ICRI Technical Guideline 210.3R and ASTM C1583/C1583M. Up to one location per substructure unit and one location per span shall be performed, as directed by the Engineer. Repair of the test areas is to follow the guidance in this note. No additional payment will be made for testing or for the repair of testing locations.

Each Contractor submitting a bid for this work shall make a thorough inspection of the site prior to submitting his bid and shall thoroughly familiarize himself with existing conditions so that the work can be expeditiously performed after a contract is awarded. Submission of a bid will be considered evidence of this inspection having been made. Any claims resulting from site conditions will not be honored by the Department. Quantities given are approximate. The quantity for "Concrete Patching Repair" shall be bid with the contingency that quantities may be increased, decreased, or eliminated by the Engineer. Dispose of all removed material entirely away from the job site as approved by the Engineer. This work is incidental to the contract unit price for "Concrete Patching Repair".

IV. MEASUREMENT

- A. Concrete Patching Repair.** The Department will measure the quantity per square feet of each area restored. Double payment will not be made on both faces of corner repairs.

- B. Steel Reinforcement.** See Section 602. Steel reinforcement will not be measured for payment but shall be considered incidental to "Concrete Patching Repair".

V. PAYMENT

- A. Concrete Patching Repair.** Payment at the contract unit price per square feet is full compensation for the following: (1) Furnish all labor, materials, tools, equipment; (2) preparation of specified areas including removing and disposing of specified existing materials; (3) place, finish and cure new concrete patches; and (4) all incidentals necessary to complete the work as specified by this note and as shown on the attached detail drawings.
- B. Steel Reinforcement.** See Section 602.

The Department will consider payment as full compensation for all work required by these notes and detail drawings.

SPECIAL NOTE FOR STRUCTURES WITH FIBER REINFORCED POLYMER WRAP

I. DESCRIPTION

Perform all work in accordance with the Department's current Standard Specifications for Roads and Bridges, and applicable Supplemental Specifications, the attached sketches, and these Notes. Section references are to the Standard Specifications.

This work consists of the following:

1. Furnish all labor, materials, tools, equipment, and incidental items necessary to complete the work.
2. Provide safe access to the bridge, in accordance with Section 107.01.01, for the Engineer to sound possible repair areas and for workers to complete the construction.
3. Repair cracks on pier strut as applicable in accordance with the Special Note for Epoxy Injection Crack Repair.
4. Repair delaminated or spalled areas of pier strut as applicable in accordance with the Special Note for Concrete Patching.
5. Design and install a carbon fiber reinforced polymer (CFRP) strengthening and protection system.
6. Any other work as specified as part of this contract.

II. MATERIALS

One manufacturer shall supply all materials required for the CFRP system. The manufacturer shall be one of the two listed below.

CatStrong
Department of Civil Engineering and Kentucky Transportation Center
University of Kentucky
176 Raymond Building
Lexington, KY 40506

QuakeWrap
6840 S Tucson Blvd
Tucson, AZ 85756

Polyester or other resins will not be allowed as a substitute to epoxy resins.

III. CONSTRUCTION

A. Design CFRP System. The CFRP system shall be designed for the resistance(s) shown in the attached detail drawings and according to AASHTO FRPS-1 and ACI 440. Design calculations and details must be sealed by a Professional Engineer licensed in

- the State of Kentucky and must be submitted and approved by the Engineer prior to installation. Submittal information shall include:
- a. Manufacturer's product data sheets and material test data.
 - b. Installation and maintenance instructions.
 - c. Drawings detailing the type, locations, dimensions, number of layers, and orientations of all FRP materials to be installed.
 - d. Calculations to determine the layout of the FRP materials to be installed.
 - e. Quality control plan.
- B. Surface Preparation – Pier Strut.** Concrete sealer is to be removed from the existing surfaces to the installer's satisfaction prior to the concrete cleaning and spall repair. Any deteriorated concrete located on the pier strut is to be patched per the Special Note for Concrete Patching, then cleaned and prepared to the installer's satisfaction prior to the installation of the CFRP system. The repaired concrete surfaces shall be allowed to cure a minimum of 14 days. The surfaces shall be clean and free of fins, depressions, or other conditions that may affect the intended performance of the CFRP system. Corners perpendicular to the strong fiber direction shall be rounded to a minimum radius of 3/4". The certified and experienced installer responsible shall verify that all required surface preparation has been completed properly and that the CFRP system is cleared for installation.
- C. Surface Preparation – Pier Column.** Concrete sealer is to be removed from the existing surfaces to the installer's satisfaction prior to the concrete cleaning. The surfaces shall be clean and free of fins, depressions, or other conditions that may affect the intended performance of the CFRP system. Corners perpendicular to the strong fiber direction shall be rounded to a minimum radius of 3/4". The certified and experienced installer responsible shall verify that all required surface preparation has been completed properly and that the CFRP system is cleared for installation.
- D. Composite Application.** The CFRP system shall only be installed by individuals certified in writing by the Manufacturer. The manufacturer shall be required to provide training to the crew that does the actual installation as well as construction oversight throughout the duration of the CFRP installations to ensure the materials are applied according to their design and specific material requirements.

Temperatures of the substrate to receive the composite, ambient temperatures, and the temperature of the CFRP materials shall be between 50°F and 95°F at the time of mixing of epoxy. The CFRP system shall be applied when the relative humidity is less than 85% and the substrate temperature is more than 5°F above the dew point. Applications of the CFRP shall begin within one hour of the mixing of epoxies.

The manufacturer shall designate the proper mixing procedure for the epoxy resins. Apply a primer coating of epoxy to surfaces of the substrate to receive the CFRP system. Saturate the carbon fiber in a documented successful manner that ensures full saturation of the carbon fiber prior to the installation of the CFRP. Saturation of the carbon fiber in place is not allowed. Apply the CFRP to the prepared and primed substrate using methods that proved a uniform tensile force over the width of the saturated carbon fabric. Strong fibers shall not deviate from the intended fiber direction more than 1/2" per 12" length of composite. Inspection of the installed composite shall be completed prior to the curing of the CFRP to ensure that all edges, seams, and other

areas are properly adhered. During this inspection process, releasing of entrapped air and other identified deficiencies shall be addressed.

After the CFRP system has been installed, use thickened epoxy to detail all edges and seams to provide a smooth finish. Apply a final layer of thickened epoxy to the installed CFRP system for protection.

E. Coating System Application. After the epoxy sets, yet prior to the application of the urethane top coat, all defects (including bubbles, delaminations, and fabric tears) more than 1 square inch of the surface area, or as specified by the Engineer, shall be repaired as such:

- a. Small defects (on the order of 6” diameter) shall be injected or back filled with epoxy.
- b. Bubbles less than 12” in diameter shall be repaired by injecting the epoxy. Two holes shall be drilled into the bubble to allow injection of the epoxy and escape of the entrapped air.
- c. Bubbles, delaminations, and fabric tears greater than 12” in diameter shall be repaired by removing and reapplying the required number of layers of the composite and the required finish coatings. All repairs shall be approved by the Engineer.

The urethane top coat shall then be applied to the final epoxy coat, as determined by manufacturer.

F. Quality Control. Installer must follow the quality control manual for the installation of the CFRP Systems, produced by the manufacturer.

IV. MEASUREMENT

The Department will measure the quantity by square footage covered. The number of layers will not be counted.

V. PAYMENT

Payment at the contract unit price per square feet is full compensation for CFRP design, materials and installation, and all incidental items necessary to complete the work in accordance with this Special Note and as shown on the attached detail drawing(s).

<u>Code</u>	<u>Pay Item</u>	<u>Pay Unit</u>
25015EC	FRP Wrap	Square Feet

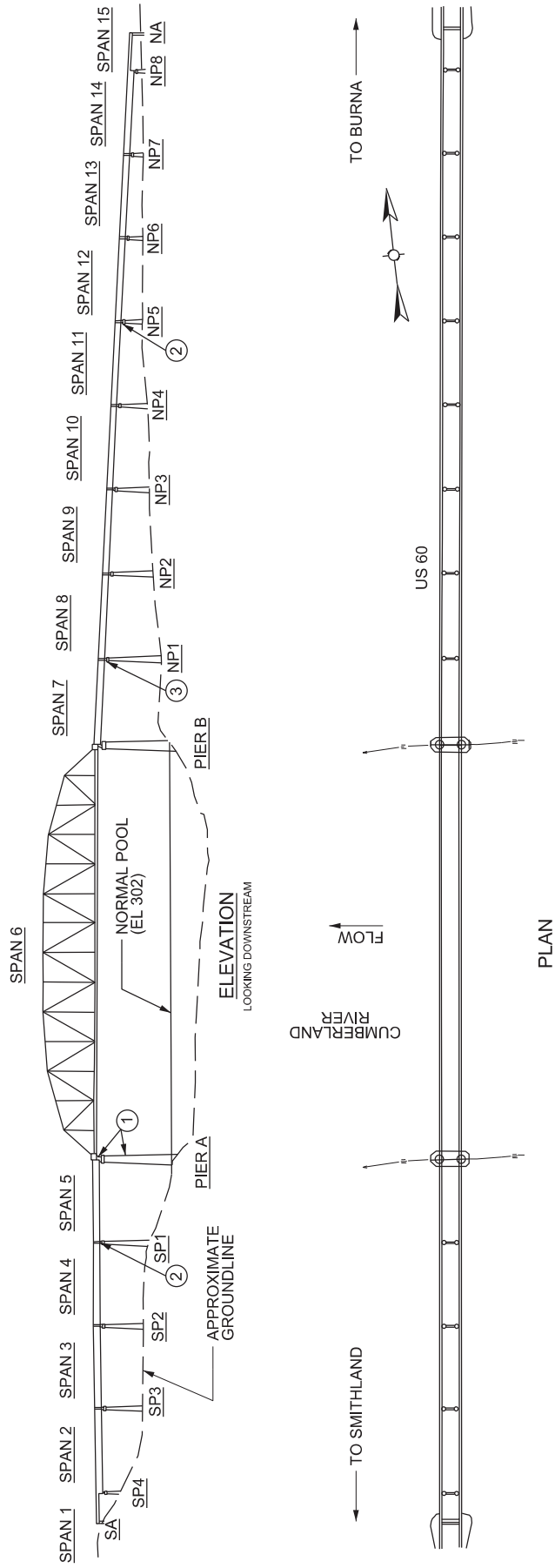

- REPAIR LOCATIONS:
- ① PIER A CAP, COLUMN & STRUT REPAIRS
 - ② SUPPORT FRAME AT PIERS SP1 & NP5
 - ③ SUPPORT BOLSTER AT PIER NP1

- GENERAL NOTES:
1. SEE DWG 07646 AND DWG 18180 FOR ANY ADDITIONAL DIMENSIONS AND DETAILS.
 2. ALL NEW STEEL TO BE A709, GRADE 50.
 3. ALL BOLTS TO BE 7/8" DIAMETER F3125 GRADE A325 IN 15/16" DIAMETER HOLES WITH DTI'S, NUTS AND WASHERS.
 4. PAINT ALL STEEL TO MATCH THE EXISTING STEEL.
 5. PERFORM ALL WORK IN ACCORDANCE WITH THE KENTUCKY TRANSPORTATION CABINET, DEPARTMENT OF HIGHWAY'S STANDARD SPECIFICATIONS FOR ROAD AND BRIDGE CONSTRUCTION, CURRENT EDITION.

SHEET 1

COUNTY: LIVINGSTON	BRIDGE NO: 070B00017N
ROUTE: US-60	DESIGNER: B. BENFIELD
CROSSING: CUMBERLAND RIVER	DATE: JANUARY, 2020

BRIDGE REPAIRS - PLAN AND ELEVATION



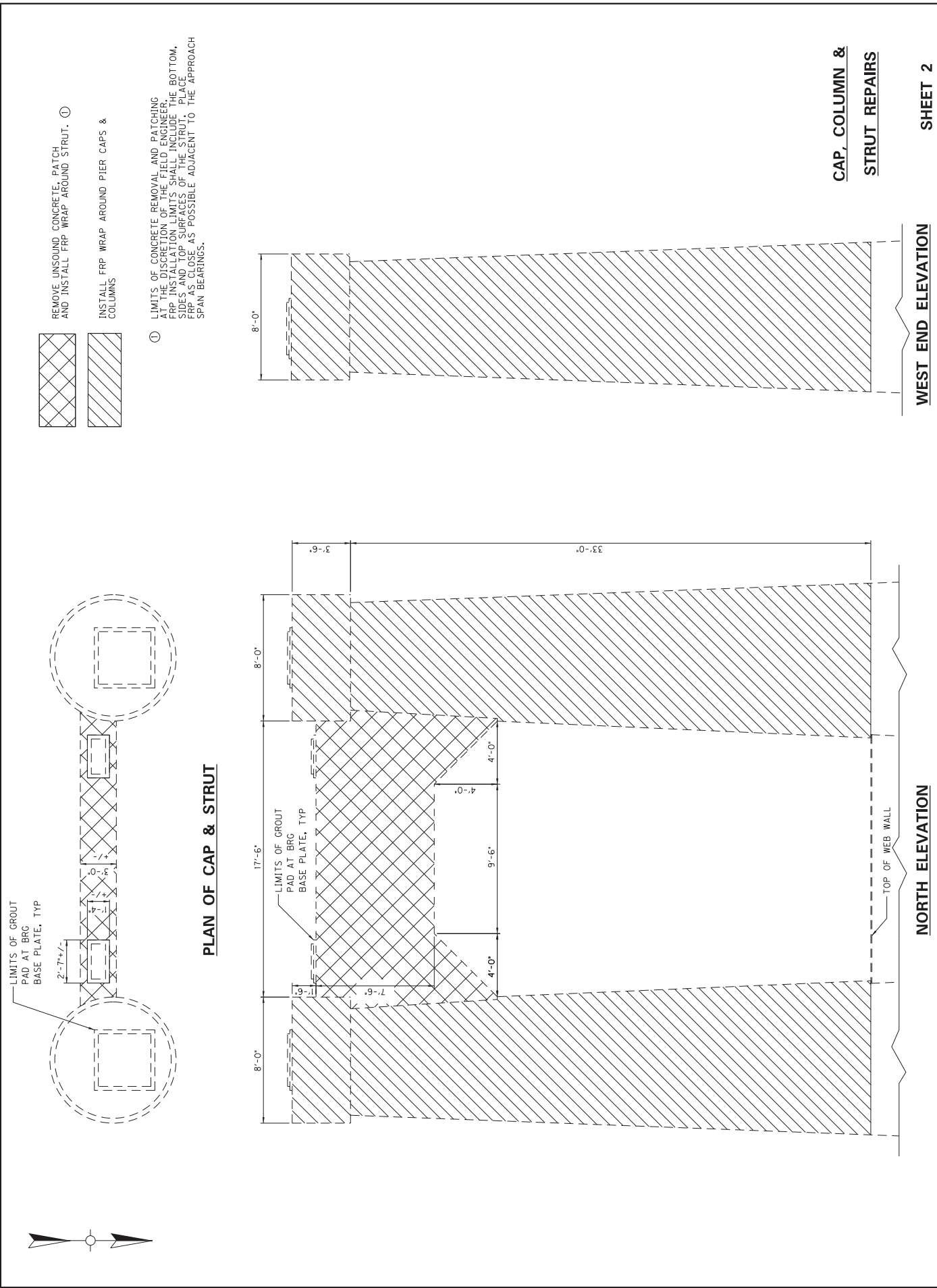

	BRIDGE REPAIRS - PIER A		SHEET 2
	COUNTY: LIVINGSTON	BRIDGE NO: 070B00017N	
	ROUTE: US-60	DESIGNER: B. BENIFIELD	
	CROSSING: CUMBERLAND RIVER	DATE: JANUARY, 2020	

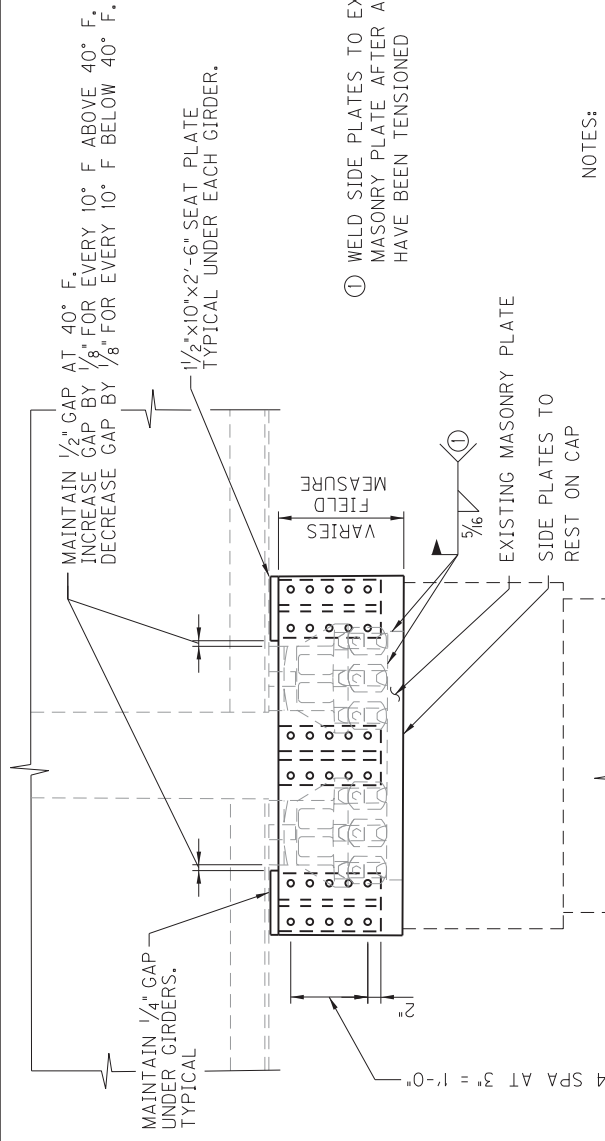

ELEVATION

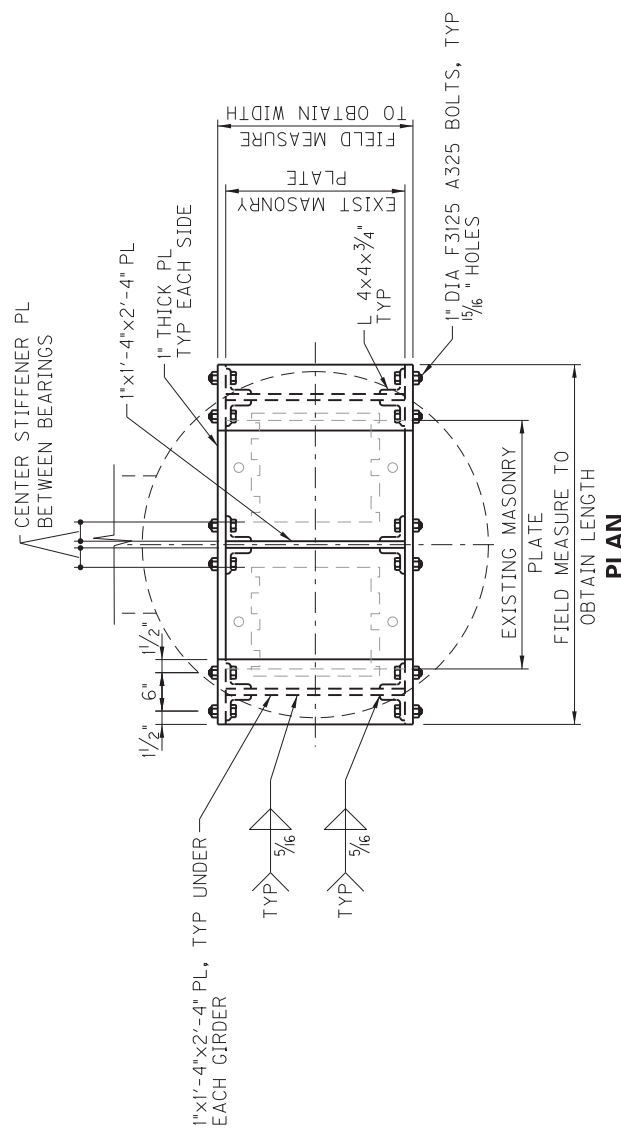

PLAN

NOTES:

- 1 THE CONTRACTOR SHALL VERIFY ALL DIMENSIONS, INCLUDING THICKNESS OF PARTS, WITH FIELD MEASUREMENTS PRIOR TO ORDERING MATERIALS OR FABRICATING STEEL.
- 2 ALL WELDING AND WELDING MATERIALS SHALL CONFORM TO JOINT SPECIFICATIONS ANSI/AASHTO/AWS D1.5M-D1.5-2008 BRIDGE WELDING CODE*. MODIFICATIONS AND ADDITIONS AS STATED ON THE PLANS OR SPECIAL NOTE FOR WELDING STEEL BRIDGES SHALL SUPERSEDE THE ANSI/AASHTO/AWS SPECIFICATION. NONDESTRUCTIVE TESTING BY THE CONTRACTOR (QC) WILL NOT BE REQUIRED. WELDING PROCEDURES SHALL BE SUBMITTED TO THE ENGINEER AND APPROVED PRIOR TO THE START OF FABRICATION AND RETROFIT.
- 3 CLEAN AND PAINT NEW AND EXISTING STEEL SURFACES IN ACCORDANCE WITH SECTION 607.03.23, SECTION 614.
- 4 REPAIR OF THE BEARING AT SPI AND NP5 SHALL BE INCLUDED IN THE UNIT BID PRICE 'EACH' FOR BEARING REPAIR. THE UNIT BID PRICE SHALL INCLUDE ANY AND ALL LABOR, MATERIALS, MANUFACTURED ASSEMBLIES, REMOVING EXISTING MATERIAL, SURFACE PREPARATION FOR PAINT, PAINT, AND ALL INCIDENTAL ITEMS NECESSARY TO COMPLETE THE WORK IN ACCORDANCE WITH THE PLANS AND SPECIFICATIONS. PROVIDED FOR INFORMATIONAL PURPOSES, THE TOTAL WEIGHT OF STRUCTURAL STEEL REQUIRED FOR THE BEARING REPAIRS AT SPI AND NP5 IS 5,385 LBS.

① WELD SIDE PLATES TO EXISTING MASONRY PLATE AFTER ALL BOLTS HAVE BEEN TENSIONED

SUPPORT FRAME

BRIDGE REPAIRS - PIERS SPI & NP5

SHEET 3

COUNTY: LIVINGSTON	BRIDGE NO: 07080017N
ROUTE: US-60	DESIGNER: B. BENFIELD
CROSSING: CUMBERLAND RIVER	DATE: JANUARY, 2020



NOTES:

- 1 THE CONTRACTOR SHALL VERIFY ALL DIMENSIONS, INCLUDING THICKNESS OF PARTS, WITH FIELD MEASUREMENTS PRIOR TO ORDERING MATERIALS OR FABRICATING STEEL.
- 2 ALL WELDING AND WELDING MATERIALS SHALL CONFORM TO JOINT SPECIFICATIONS ANSI/AASHTO/AWS D1.5M-D1.5-2008 BRIDGE WELDING CODE*. MODIFICATIONS AND ADDITIONS AS STATED ON THE PLANS OR SPECIAL NOTE FOR WELDING STEEL BRIDGES SHALL SUPERSEDE THE ANSI/AASHTO/AWS SPECIFICATION. NONDESTRUCTIVE TESTING BY THE CONTRACTOR (QC) WILL NOT BE REQUIRED. WELDING PROCEDURES SHALL BE SUBMITTED TO THE ENGINEER AND APPROVED PRIOR TO THE START OF FABRICATION AND RETROFIT.
- 3 CLEAN AND PAINT NEW AND EXISTING STEEL SURFACES IN ACCORDANCE WITH SECTION 607.03.23, SECTION 614.
- 4 REPAIR OF THE BEARINGS AT NP1 SHALL BE INCLUDED IN THE UNIT PRICE 'EACH' FOR BEARING REPAIR. THE UNIT BID PRICE SHALL INCLUDE ANY AND ALL LABOR, MATERIALS, MANUFACTURED ASSEMBLIES, REMOVING EXISTING MATERIAL, SURFACE PREPARATION FOR PAINT, PAINT, AND ALL INCIDENTAL ITEMS NECESSARY TO COMPLETE THE WORK IN ACCORDANCE WITH THE PLANS AND SPECIFICATIONS. PROVIDED FOR INFORMATION PURPOSES, THE TOTAL WEIGHT OF STRUCTURAL STEEL REQUIRED FOR THE BEARING REPAIRS AT NP1 IS 324 LBS.

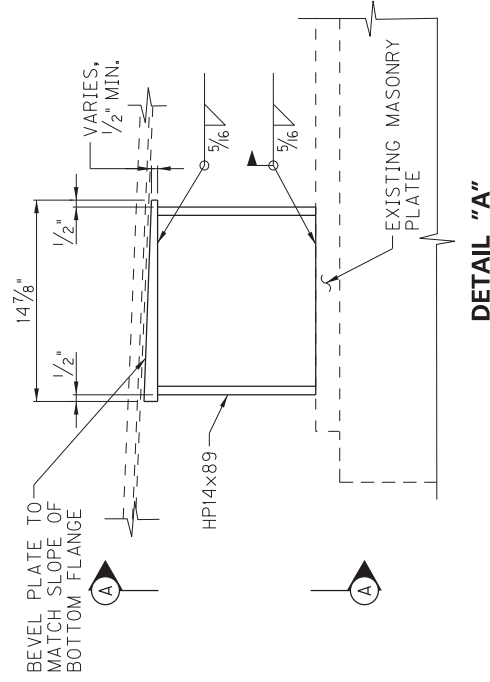

DETAIL "A"

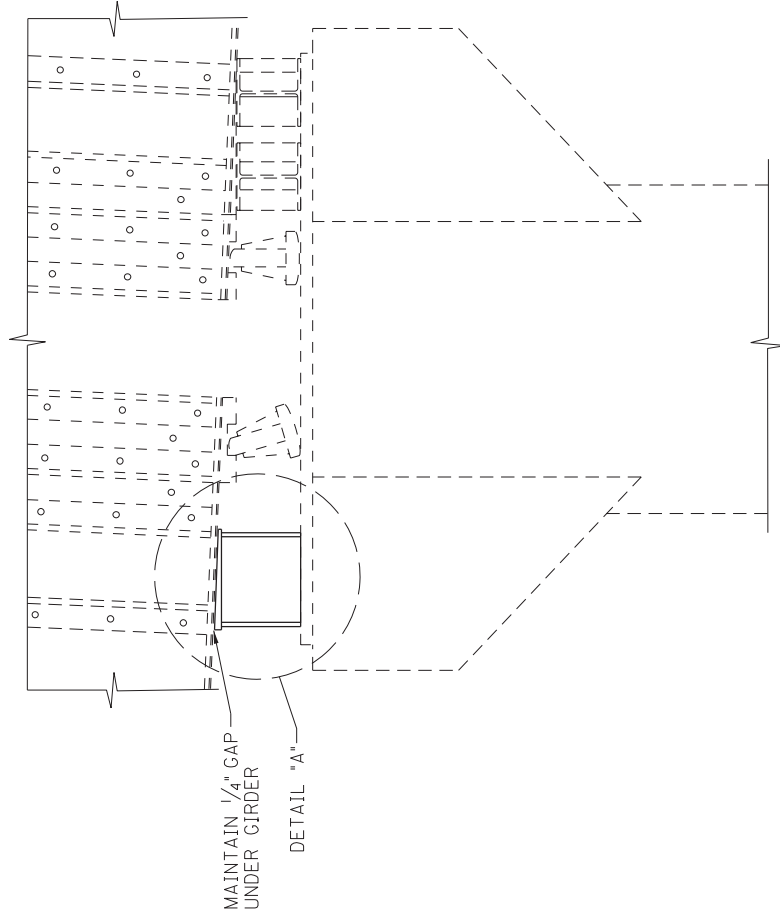

EAST ELEVATION

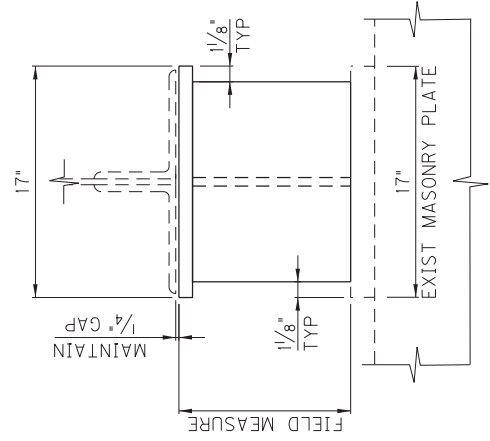

VIEW "A-A"

SUPPORT BOLSTER

SHEET 4



BRIDGE REPAIRS - PIER NP1

COUNTY: LIVINGSTON BRIDGE NO: 070B00017N
ROUTE: US-60 DESIGNER: B. BENFIELD
CROSSING: CUMBERLAND RIVER DATE: JANUARY, 2020

SPECIAL NOTE

For Construction Activities

**Livingston County
US 60 Smithland Bridge Replacement
Item No. 01-1142**

STANDARD GRAY BAT EROSION CONTROL IS TO BE FOLLOWED.

**If there are any questions regarding this note, please contact Danny Peake, Director,
Division of Environmental Analysis, 200 Mero Street, Frankfort, KY 40601; Phone:
(502) 564-7250.**

SPECIAL NOTE FOR CONE PENETRATION TEST DATA

Livingston County – US 60 Bridge over the Cumberland River Item No. 1-1142.0

Cone Penetration Testing (CPT) was performed on the project. This special note includes the following:

- Cone Penetration Test Summary and Standard Cone Penetration Test Plots
- Seismic Cone Penetration Test Plots
- Pore Pressure Dissipation Summary and Pore Pressure Dissipation Plots

A report entitled “Presentation of Site Investigation Results”, prepared by ConeTec Inc., contains a comprehensive report of the cone penetration testing performed for this project and is included in an Appendix of the Geotechnical Engineering Report prepared by Stantec Consulting Services, Inc. The geotechnical report is or will be available to bidders.

CPT Sounding No. on Subsurface Data Sheets	Sounding ID in ConeTec Report	Station (ft.)	Offset (ft.)	Final Depth (ft.)
CPT-2	CPT19-02	116+13	CL	5.58
CPT-2A	CPT19-02A	116+13	2 Lt.	7.05
CPT-2B	CPT19-02B	116+13	3 Rt.	14.60
CPT-3	SCPT19-03	117+37	CL	26.25
CPT-4	SCPT19-04	118+50	CL	50.03
CPT-5	SCPT19-05	125+70	CL	100.89
CPT-6	SCPT19-06	127+00	CL	94.82
CPT-7	SCPT19-07	128+40	CL	109.74
CPT-8	SCPT19-08	129+00	CL	116.14
CPT-9	SCPT19-09	131+50	CL	79.56
CPT-10	SCPT19-10	132+60	CL	126.80
CPT-11	SCPT19-11	134+00	CL	93.50

Cone Penetration Test Summary and Standard Cone Penetration Test Plots





Job No: 19-61032
 Client: Stantec
 Project: US60 Bridge, Livingston County, KY
 Start Date: 20-Aug-2019
 End Date: 23-Aug-2019

CONE PENETRATION TEST SUMMARY

Sounding ID	File Name	Date	Cone	Assumed Phreatic Surface ¹ (ft)	Final Depth (ft)	Shear Wave Velocity Tests	Northing ² (m)	Easting ² (m)	Refer to Notation Number
CPT19-02	19-61032_CP02	22-Aug-2019	513:T1500F15U500	31.0	5.58		4112078	375659	4
CPT19-02A	19-61032_CP02A	22-Aug-2019	513:T1500F15U500	31.0	7.05		4112078	375656	4
CPT19-02B	19-61032_CP02B	22-Aug-2019	513:T1500F15U500	31.0	14.60		4112078	375661	4
SCPT19-03	19-61032_SP03	23-Aug-2019	513:T1500F15U500	31.0	26.25	2	4112118	375665	4
SCPT19-04	19-61032_SP04	23-Aug-2019	513:T1500F15U500	31.0	50.03	4	4112156	375670	
SCPT19-05	19-61032_SP05	20-Aug-2019	513:T1500F15U500	13.8	100.89	7	4112378	375709	3
SCPT19-06	19-61032_SP06	20-Aug-2019	513:T1500F15U500	8.2	94.82	7	4112426	375716	
SCPT19-07	19-61032_SP07	21-Aug-2019	513:T1500F15U500	3.7	109.74	8	4112461	375709	3
SCPT19-08	19-61032_SP08	21-Aug-2019	513:T1500F15U500	9.3	116.14	8	4112444	375723	
SCPT19-09	19-61032_SP09	21-Aug-2019	513:T1500F15U500	9.6	79.56	6	4112545	375744	
SCPT19-10	19-61032_SP10	21-Aug-2019	513:T1500F15U500	13.5	126.80	9	4112576	375747	3
SCPT19-11	19-61032_SP11	22-Aug-2019	513:T1500F15U500	14.5	93.50	7	4112619	375756	
Totals	12 soundings				824.96	58			

1. The assumed phreatic surface was based on pore pressure dissipation tests. Equilibrium pore pressure profiles were assumed for the calculated parameters.
2. Coordinates were acquired using a MR-350 GlobalSat GPS Receiver in datum: WGS84 / UTM Zone 16 North.
3. Assumed phreatic surface depth was based on a single static pore pressure dissipation test.
4. No phreatic surface detected



Stantec

Job No: 19-61032
Date: 2019-08-22 16:47
Site: US60 Bridge, Livingston County, KY

Sounding: CPT19-02

Cone: 513:T1500F15U500

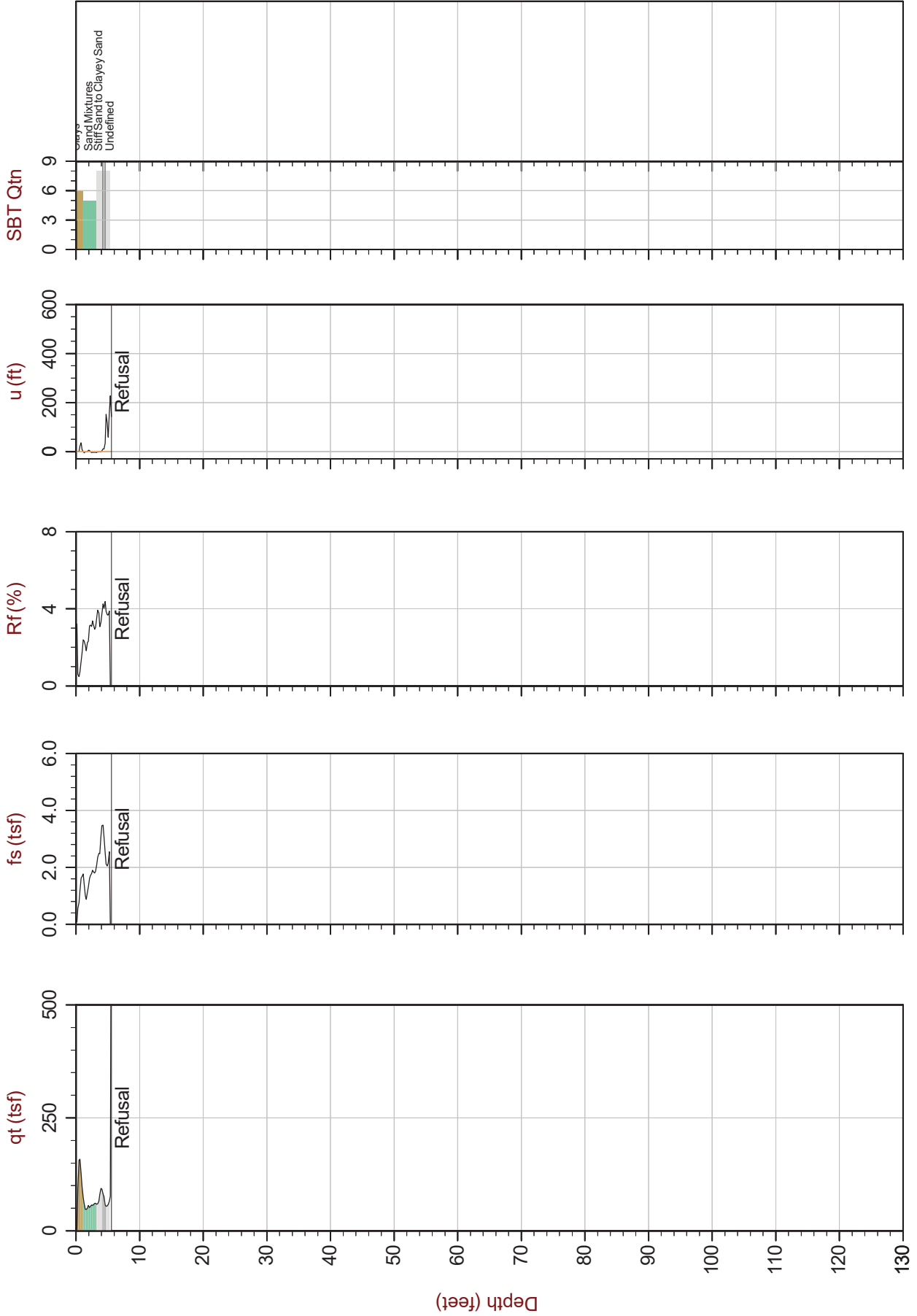

Max Depth: 1.700 m / 5.58 ft
Depth Inc: 0.050 m / 0.164 ft
Avg Int: Every Point

File: 19-61032_CP02.COR
Unit Wt: SBTQtn (PKR2009)

SBT: Robertson, 2009 and 2010
Coords: UTM Zone 16N N: 4112078 E: 3756659

Hydrostatic Line ● Ueq ● Assumed Ueq ◀ PPD, Ueq achieved ◀ PPD, Ueq not achieved

The reported coordinates were acquired from consumer-grade GPS equipment and are only approximate locations. The coordinates should not be used for design purposes.



Stantec

Job No: 19-61032
Date: 2019-08-22 17:07
Site: US60 Bridge, Livingston County, KY

Sounding: CPT19-02A

Cone: 513:T1500F15U500

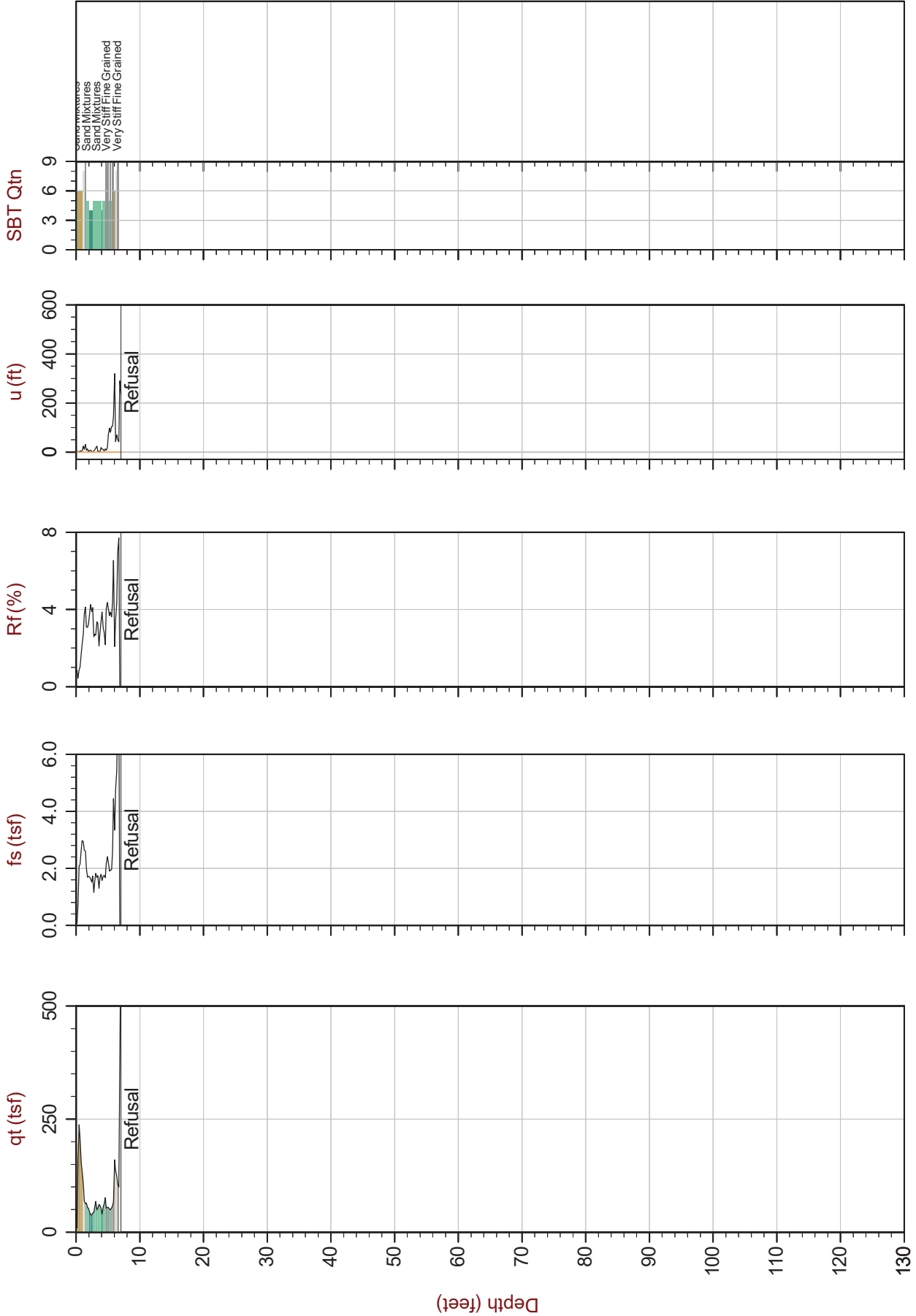

Max Depth: 2.150 m / 7.05 ft
Depth Inc: 0.050 m / 0.164 ft
Avg Int: Every Point

File: 19-61032_CP02A.COR
Unit Wt: SBTQtn (PKR2009)

SBT: Robertson, 2009 and 2010
Coords: UTM Zone 16N N: 4112078 E: 375656

Hydrostatic Line ● Ueq ● Assumed Ueq ◀ PPD, Ueq achieved ◀ PPD, Ueq not achieved

The reported coordinates were acquired from consumer-grade GPS equipment and are only approximate locations. The coordinates should not be used for design purposes.



Stantec

Job No: 19-61032
Date: 2019-08-22 17:31
Site: US60 Bridge, Livingston County, KY

Sounding: CPT19-02B

Cone: 513:T1500F15U500

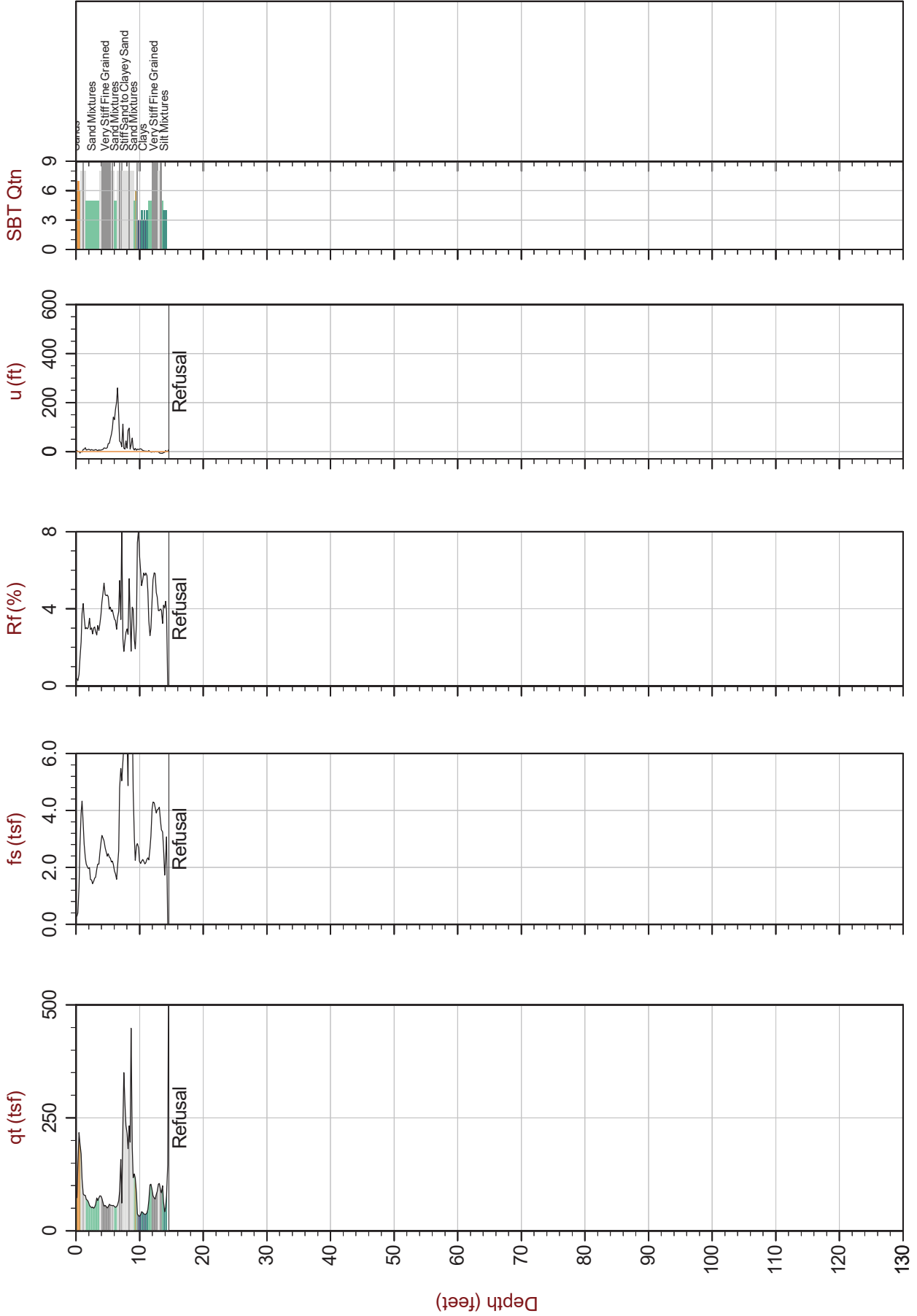

SBT: Robertson, 2009 and 2010
Coords: UTM Zone 16N N: 4112078 E: 375661

File: 19-61032_CP02B.COR
Unit Wt: SBTQtn (PKR2009)

Max Depth: 4.450 m / 14.60 ft
Depth Inc: 0.050 m / 0.164 ft
Avg Int: Every Point

Hydrostatic Line ● Ueq ● Assumed Ueq ▼ PPD, Ueq achieved ▼ PPD, Ueq not achieved

The reported coordinates were acquired from consumer-grade GPS equipment and are only approximate locations. The coordinates should not be used for design purposes.



Stantec

Job No: 19-61032
Date: 2019-08-23 08:28
Site: US60 Bridge, Livingston County, KY

Sounding: SCPT19-03

Cone: 513:T1500F15U500

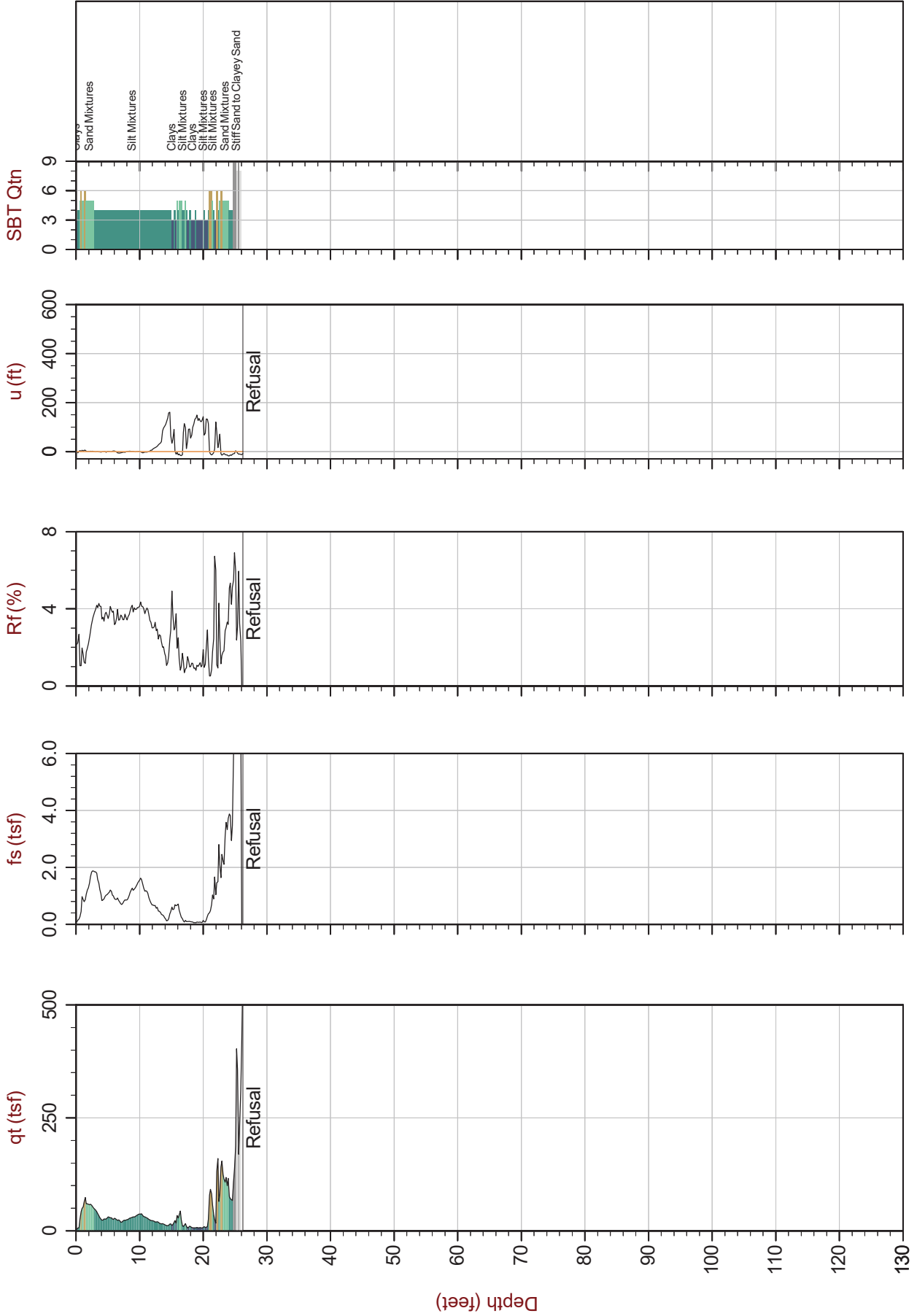

Max Depth: 8.000 m / 26.25 ft
Depth Inc: 0.050 m / 0.164 ft
Avg Int: Every Point

File: 19-61032_SP03.COR
Unit Wt: SBTQtn (PKR2009)

SBT: Robertson, 2009 and 2010
Coords: UTM Zone 16N N: 4112118 E: 3756665

Hydrostatic Line ● Ueq ● Assumed Ueq ▼ PPD, Ueq achieved ▼ PPD, Ueq not achieved

The reported coordinates were acquired from consumer-grade GPS equipment and are only approximate locations. The coordinates should not be used for design purposes.



Stantec

Job No: 19-61032
Date: 2019-08-23 09:16
Site: US60 Bridge, Livingston County, KY

Sounding: SCPT19-04

Cone: 513:T1500F15U500

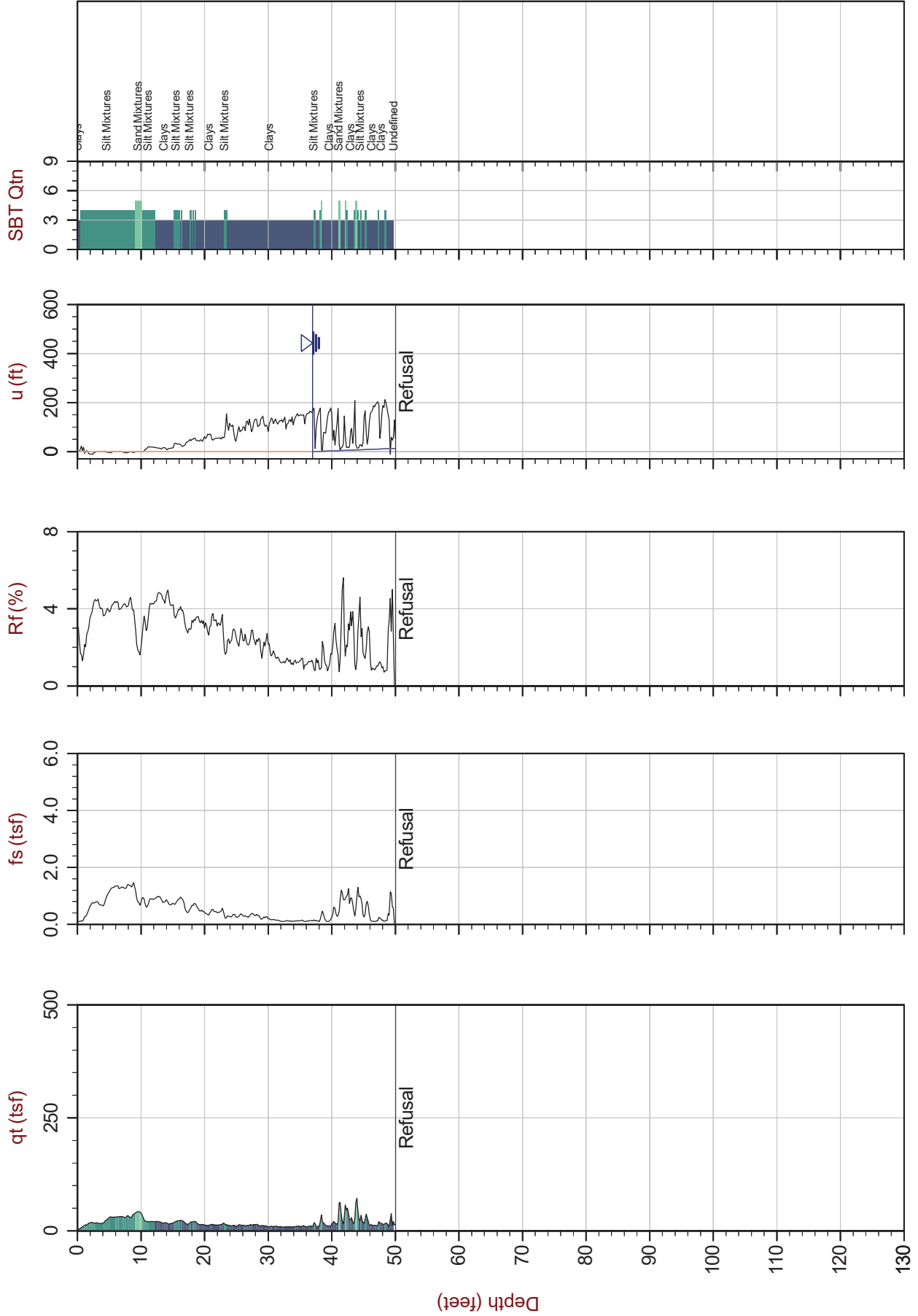

SBT: Robertson, 2009 and 2010
Coords: N: 4112156.000 E: 375670.000

File: 19-61032_SP04.COR
Unit Wt: SBTQtn (PKR2009)

Max Depth: 15.250 m / 50.03 ft
Depth Inc: 0.050 m / 0.164 ft
Avg Int: Every Point

Hydrostatic Line ● Ueq ● Assumed Ueq ▼ PPD, Ueq achieved ▼ PPD, Ueq not achieved

The reported coordinates were acquired from consumer-grade GPS equipment and are only approximate locations. The coordinates should not be used for design purposes.



Stantec

Job No: 19-61032
Date: 2019-08-20 14:15
Site: US60 Bridge, Livingston County, KY

Sounding: SCPT19-06

Cone: 513:T1500F15U500

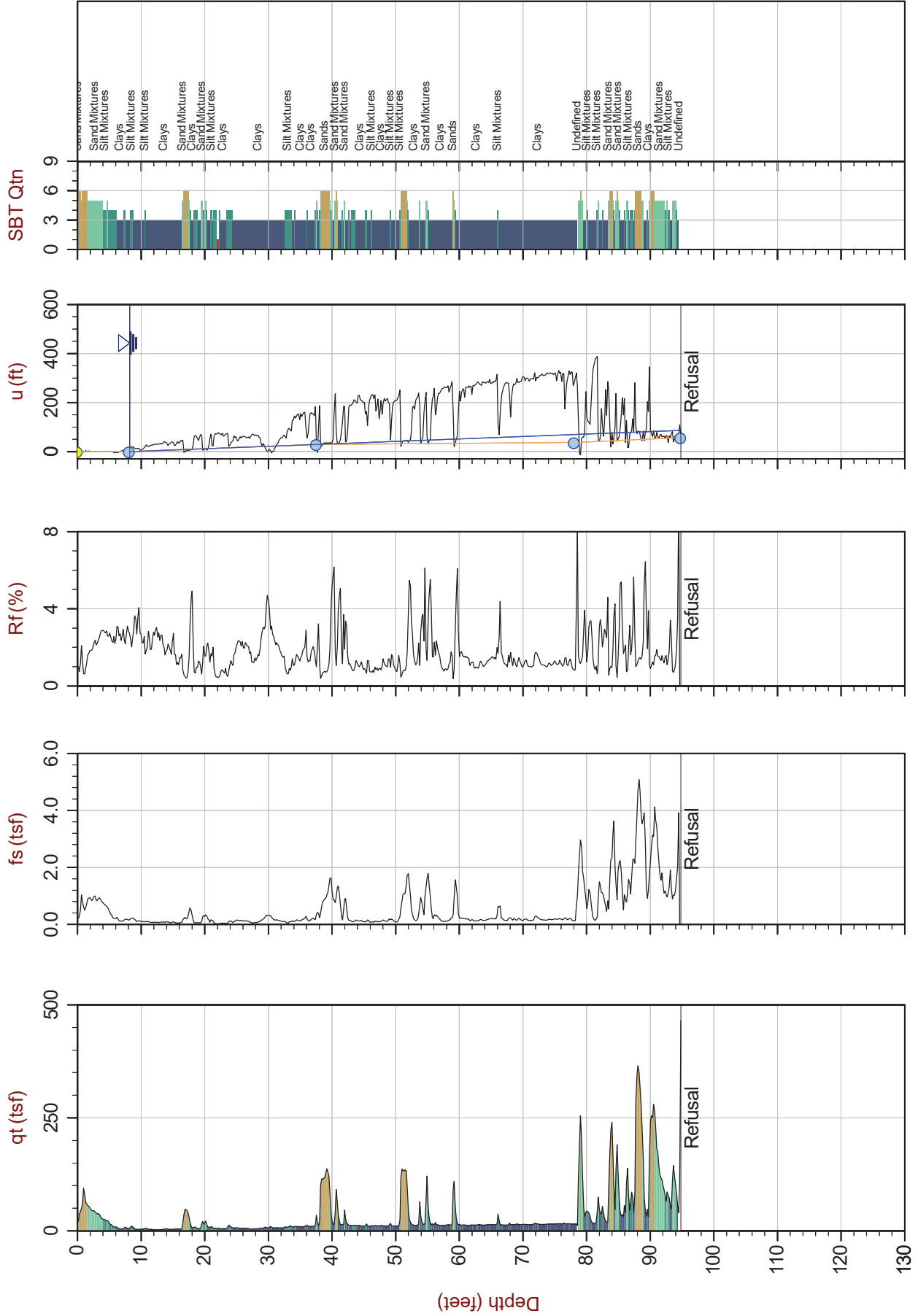

SBT: Robertson, 2009 and 2010
Coords: UTM Zone 16N N: 4112426 E: 375716

File: 19-61032_SP06.COR
Unit Wt: SBTQtn (PKR2009)

Max Depth: 28.900 m / 94.82 ft
Depth Inc: 0.050 m / 0.164 ft
Avg Int: Every Point

Hydrostatic Line ● Ueq ● Assumed Ueq ▼ PPD, Ueq achieved ▼ PPD, Ueq not achieved

The reported coordinates were acquired from consumer-grade GPS equipment and are only approximate locations. The coordinates should not be used for design purposes.



Stantec

Job No: 19-61032
Date: 2019-08-21 08:35
Site: US60 Bridge, Livingston County, KY

Sounding: SCPT19-07

Cone: 513:T1500F15U500

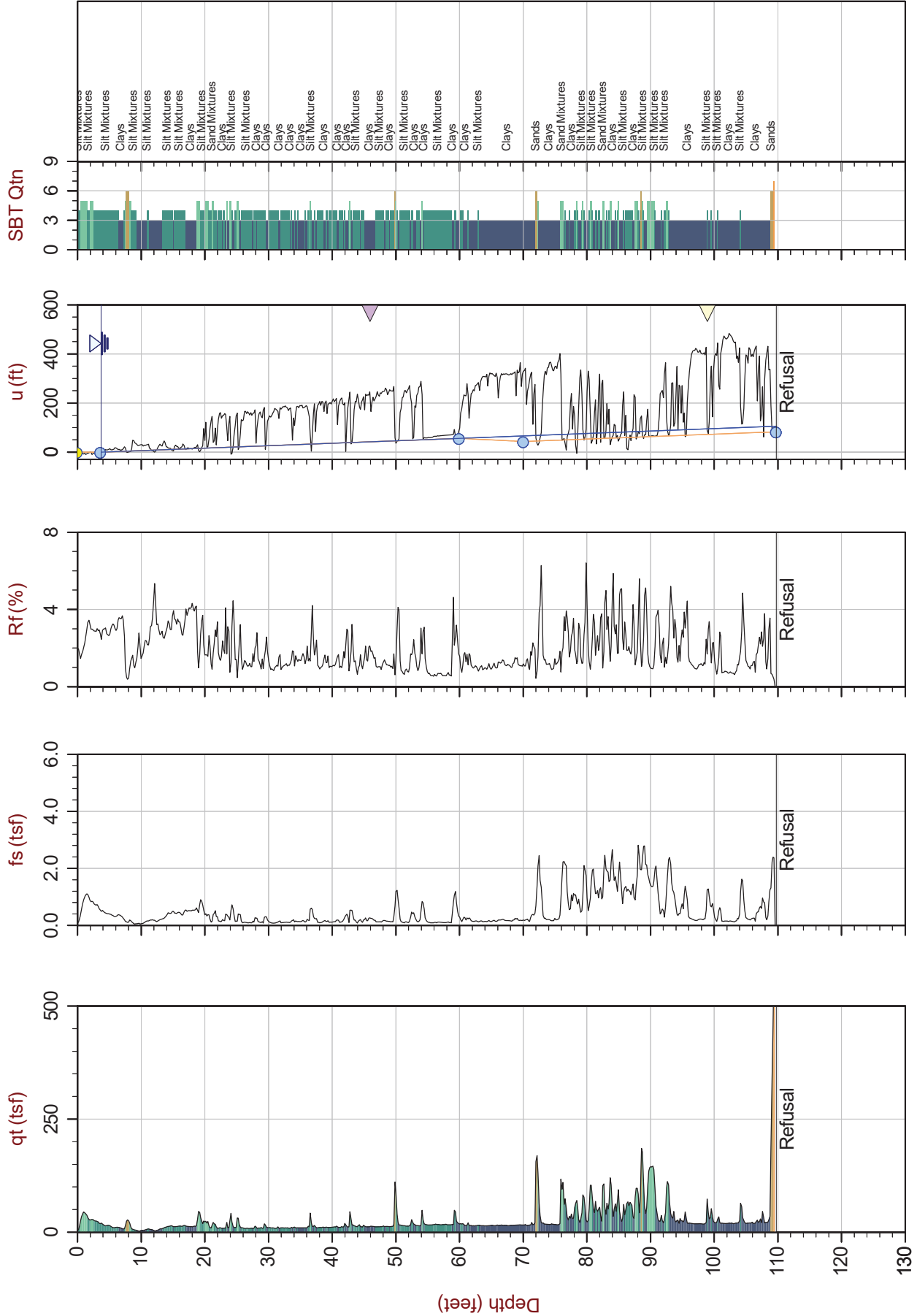

SBT: Robertson, 2009 and 2010
Coords: UTM Zone 16N N: 4112461 E: 375709

File: 19-61032_SP07.COR
Unit Wt: SBTQtn (PKR2009)

Max Depth: 33.450 m / 109.74 ft
Depth Inc: 0.050 m / 0.164 ft
Avg Int: Every Point

Hydrostatic Line ● Ueq ● Assumed Ueq ▲ PPD, Ueq achieved ▼ PPD, Ueq not achieved
The reported coordinates were acquired from consumer-grade GPS equipment and are only approximate locations. The coordinates should not be used for design purposes.



Stantec

Job No: 19-61032
Date: 2019-08-21 13:39
Site: US60 Bridge, Livingston County, KY

Sounding: SCPT19-09
Cone: 513:T1500F15U500

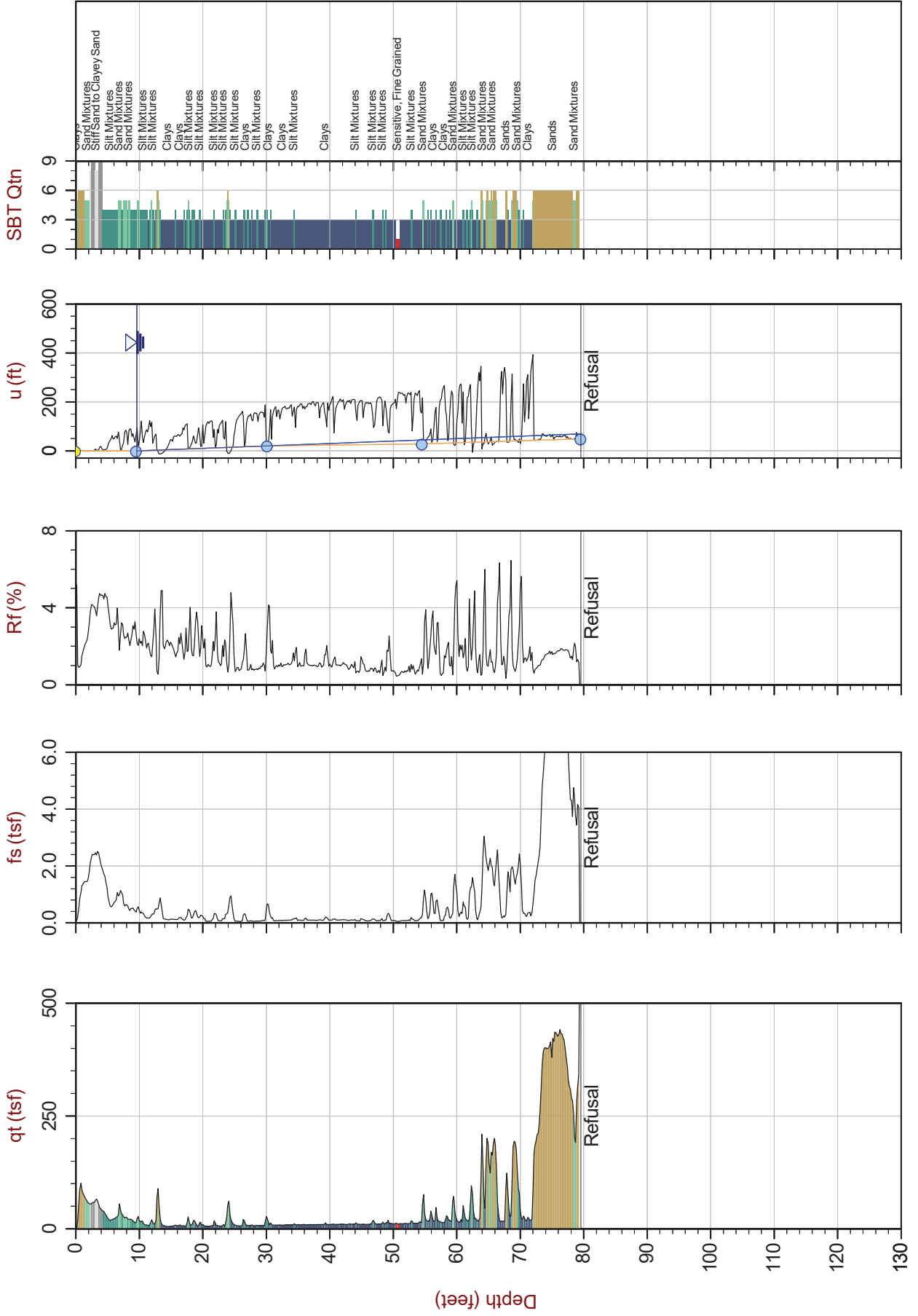

Max Depth: 24.250 m / 79.56 ft
Depth Inc: 0.050 m / 0.164 ft
Avg Int: Every Point

File: 19-61032_SP09.COR
Unit Wt: SBTQtn (PKR2009)

SBT: Robertson, 2009 and 2010
Coords: UTM Zone 16N N: 4112545 E: 375744

Hydrostatic Line ● Ueq ● Assumed Ueq ◀ PPD, Ueq achieved ◀ PPD, Ueq not achieved

The reported coordinates were acquired from consumer-grade GPS equipment and are only approximate locations. The coordinates should not be used for design purposes.



Stantec

Job No: 19-61032
Date: 2019-08-21 15:43
Site: US60 Bridge, Livingston County, KY

Sounding: SCPT19-10
Cone: 513:T1500F15U500

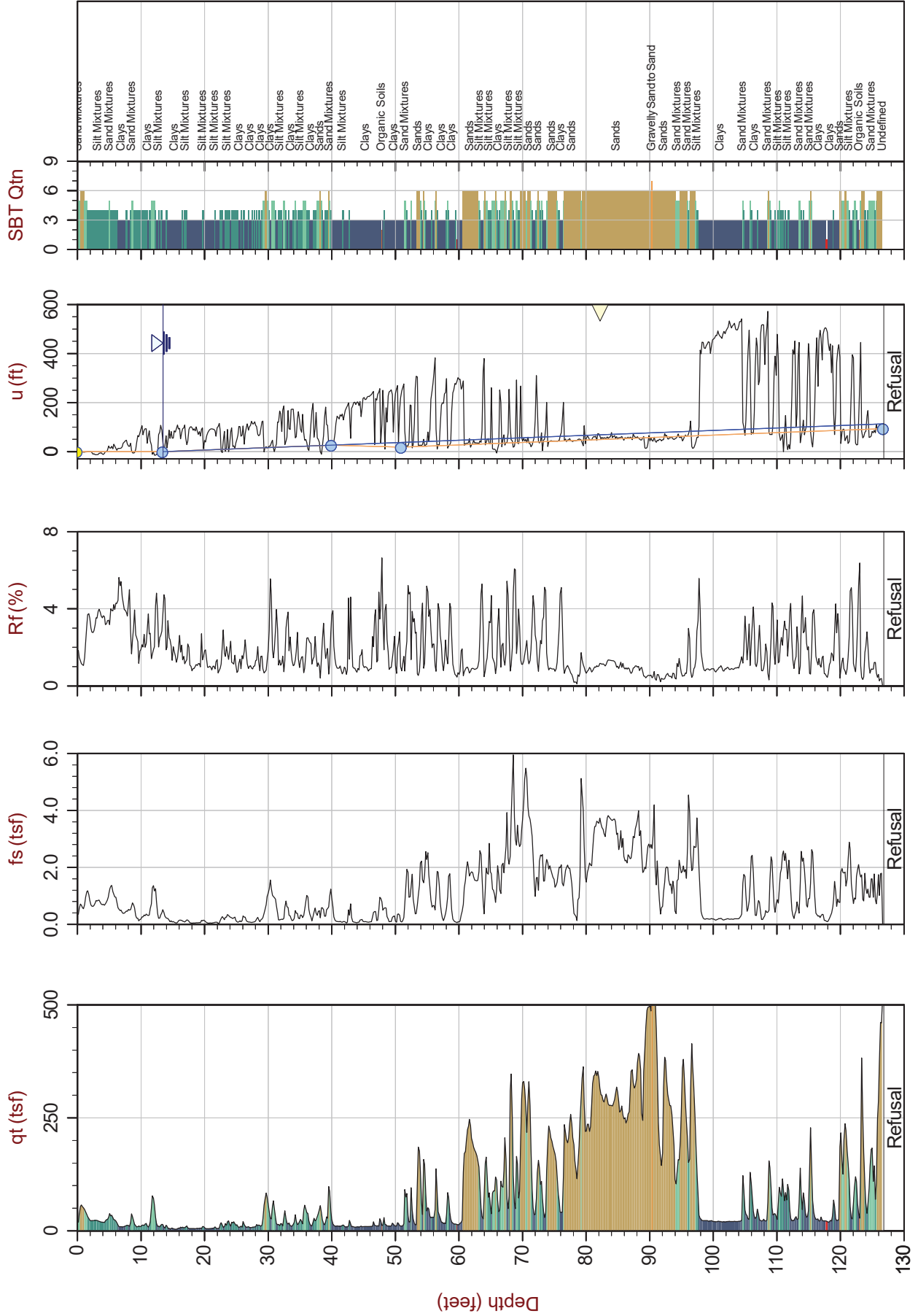

SBT: Robertson, 2009 and 2010
Coords: UTM Zone 16N N: 4112576 E: 375747

File: 19-61032_SP10.COR
Unit Wt: SBTQtn (PKR2009)

Max Depth: 38.650 m / 126.80 ft
Depth Inc: 0.050 m / 0.164 ft
Avg Int: Every Point

Hydrostatic Line Ueq Assumed Ueq PPD, Ueq not achieved Ueq not achieved
The reported coordinates were acquired from consumer-grade GPS equipment and are only approximate locations. The coordinates should not be used for design purposes.



Stantec

Job No: 19-61032

Date: 2019-08-22 10:33

Site: US60 Bridge, Livingston County, KY

Sounding: SCPT19-11

Cone: 513:T1500F15U500

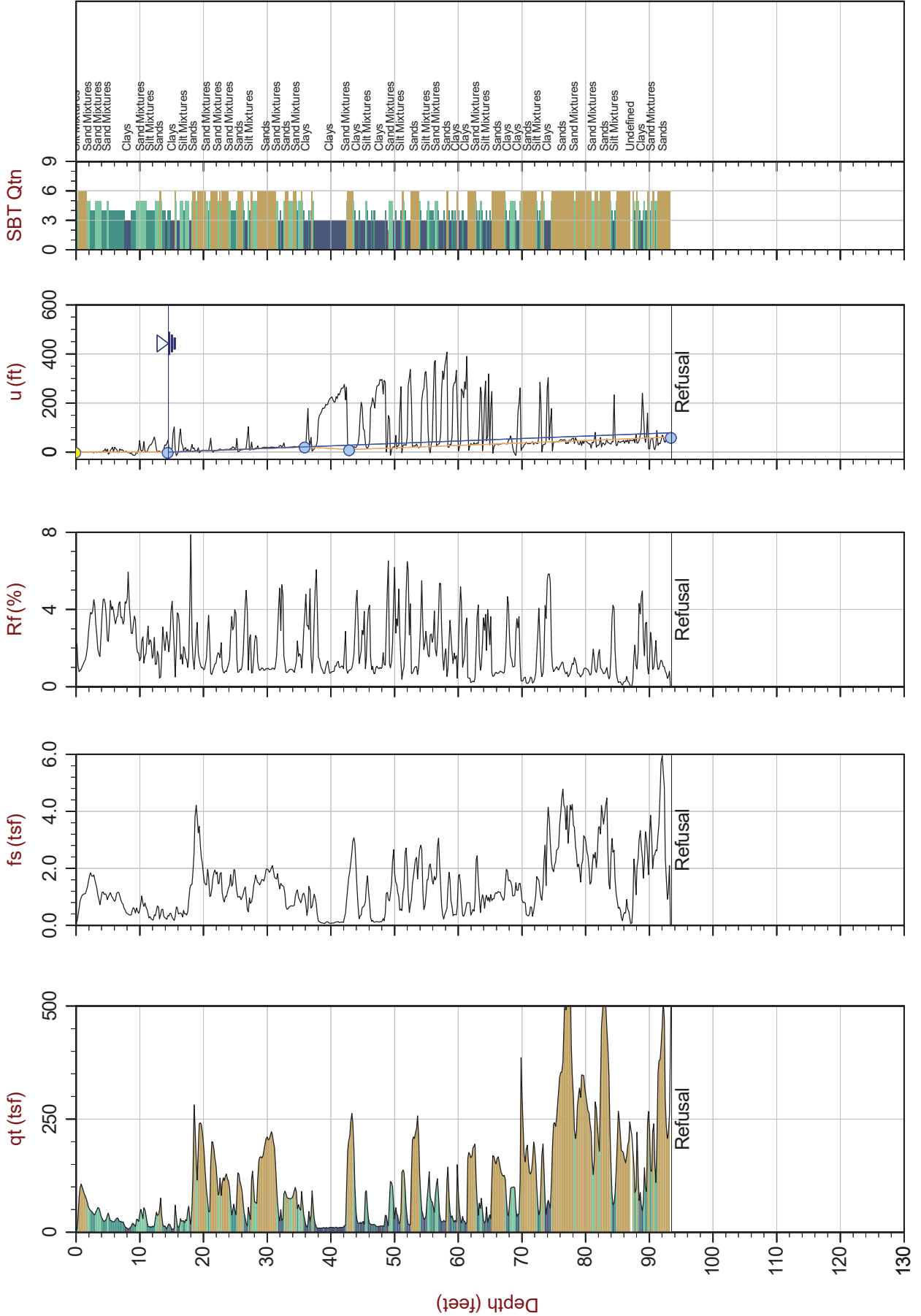

Max Depth: 28.500 m / 93.50 ft
Depth Inc: 0.050 m / 0.164 ft
Avg Int: Every Point

File: 19-61032_SP11.COR
Unit Wt: SBTQtn (PKR2009)

SBT: Robertson, 2009 and 2010
Coords: UTM Zone 16N N: 4112619 E: 375756

Hydrostatic Line — Ueq ● Assumed Ueq ◀ PPD, Ueq achieved ◀ PPD, Ueq not achieved

The reported coordinates were acquired from consumer-grade GPS equipment and are only approximate locations. The coordinates should not be used for design purposes.

Seismic Cone Penetration Test Plots





Stantec

Job No: 19-61032
Date: 2019-08-23 08:28
Site: US60 Bridge, Livingston County, KY

Sounding: SCPT19-03
Cone: 513:T1500F15U500

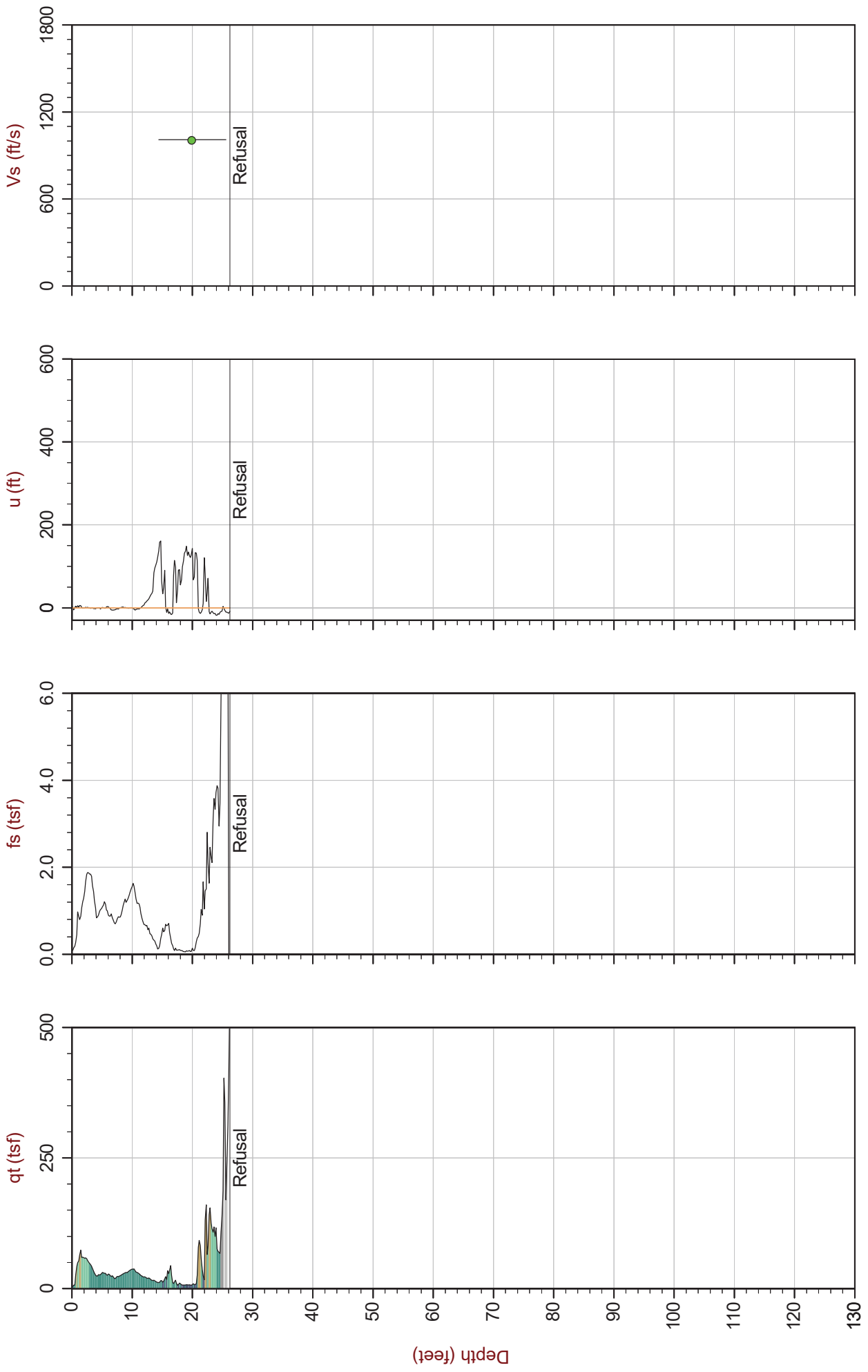

Max Depth: 8.000 m / 26.25 ft
 Depth Inc: 0.050 m / 0.164 ft
 Avg Int: Every Point

File: 19-61032_SP03.COR
 Unit Wt: SBTQin (PKR2009)

SBT: Robertson, 2009 and 2010
 Coords: UTM Zone 16N N: 4112118 E: 375665

Hydrostatic Line — Ueq ● Assumed Ueq ▼ PPD, Ueq achieved ▼ PPD, Ueq not achieved

The reported coordinates were acquired from consumer-grade GPS equipment and are only approximate locations. The coordinates should not be used for design purposes.



Stantec

Job No: 19-61032
Date: 2019-08-23 09:16
Site: US60 Bridge, Livingston County, KY

Sounding: SCPT19-04
Cone: 513:T1500F15U500

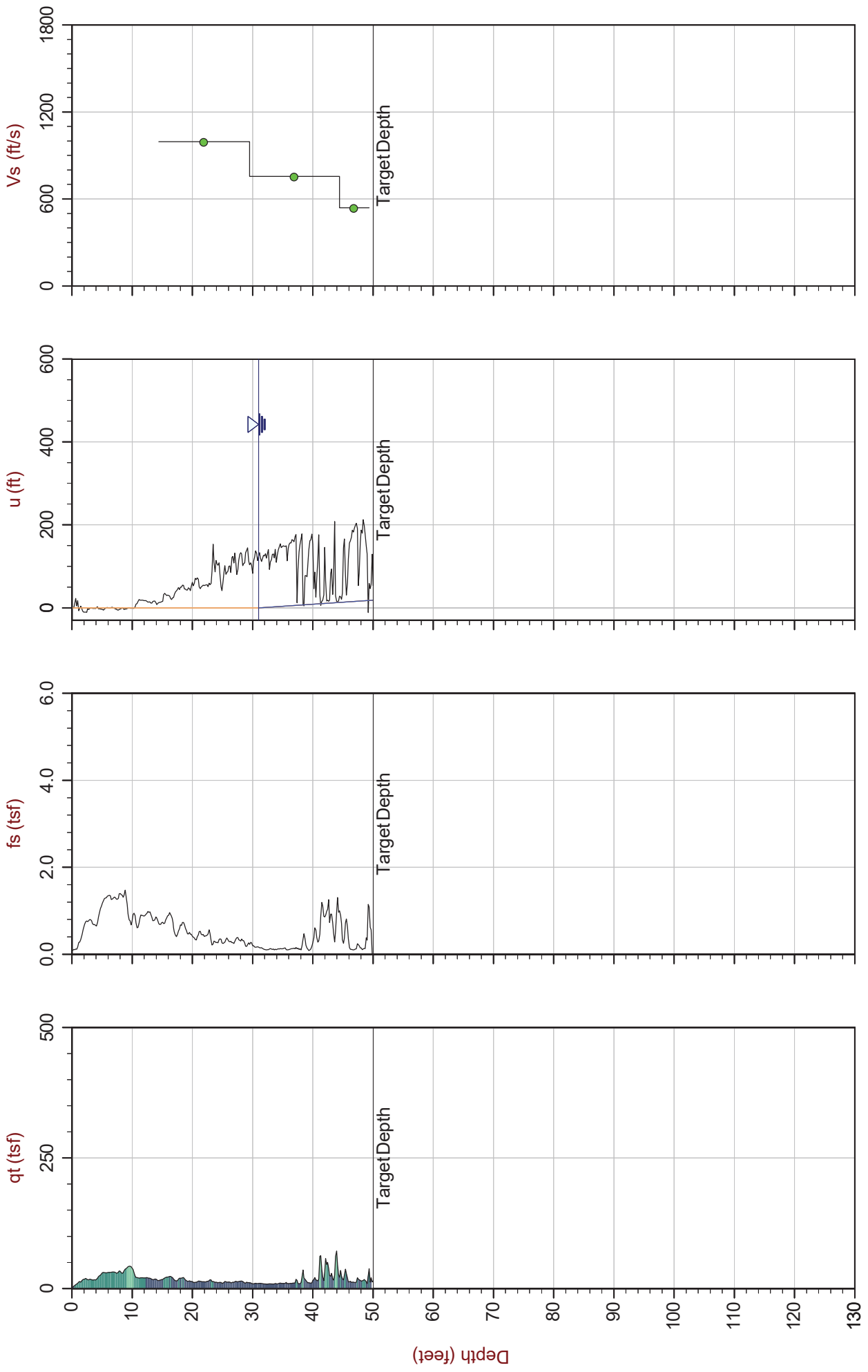

Max Depth: 15.250 m / 50.03 ft
Depth Inc: 0.050 m / 0.164 ft
Avg Int: Every Point

File: 19-61032_SP04.COR
Unit Wt: SBTQin (PKR2009)

SBT: Robertson, 2009 and 2010
Coords: UTM Zone 16N N: 4112156 E: 375670

Hydrostatic Line — Ueq ● Assumed Ueq ▲ PPD, Ueq achieved ▼ PPD, Ueq not achieved

The reported coordinates were acquired from consumer-grade GPS equipment and are only approximate locations. The coordinates should not be used for design purposes.



Stantec

Job No: 19-61032
Date: 2019-08-20 09:56
Site: US60 Bridge, Livingston County, KY

Sounding: SCPT19-05
Cone: 513:T1500F15U500

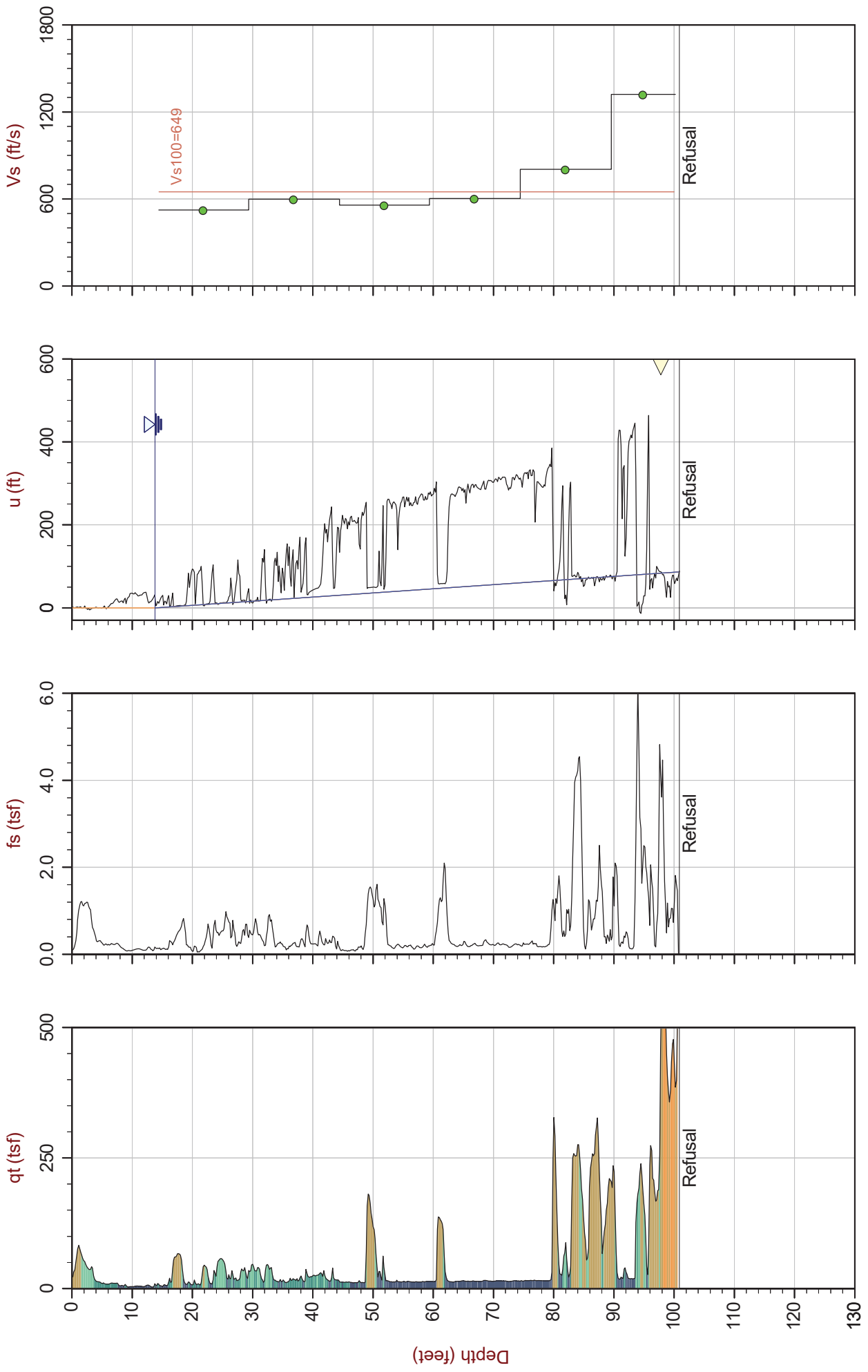

Max Depth: 30.750 m / 100.88 ft
Depth Inc: 0.050 m / 0.164 ft
Avg Int: Every Point

File: 19-61032_SP05.COR
Unit Wt: SBTQin (PKR2009)

SBT: Robertson, 2009 and 2010
Coords: UTM Zone 16N N: 4112378 E: 375709

Hydrostatic Line — Ueq ● Assumed Ueq ▲ PPD, Ueq achieved ▼ PPD, Ueq not achieved

The reported coordinates were acquired from consumer-grade GPS equipment and are only approximate locations. The coordinates should not be used for design purposes.



Stantec

Job No: 19-61032
Date: 2019-08-20 14:15
Site: US60 Bridge, Livingston County, KY

Sounding: SCPT19-06
Cone: 513:T1500F15U500

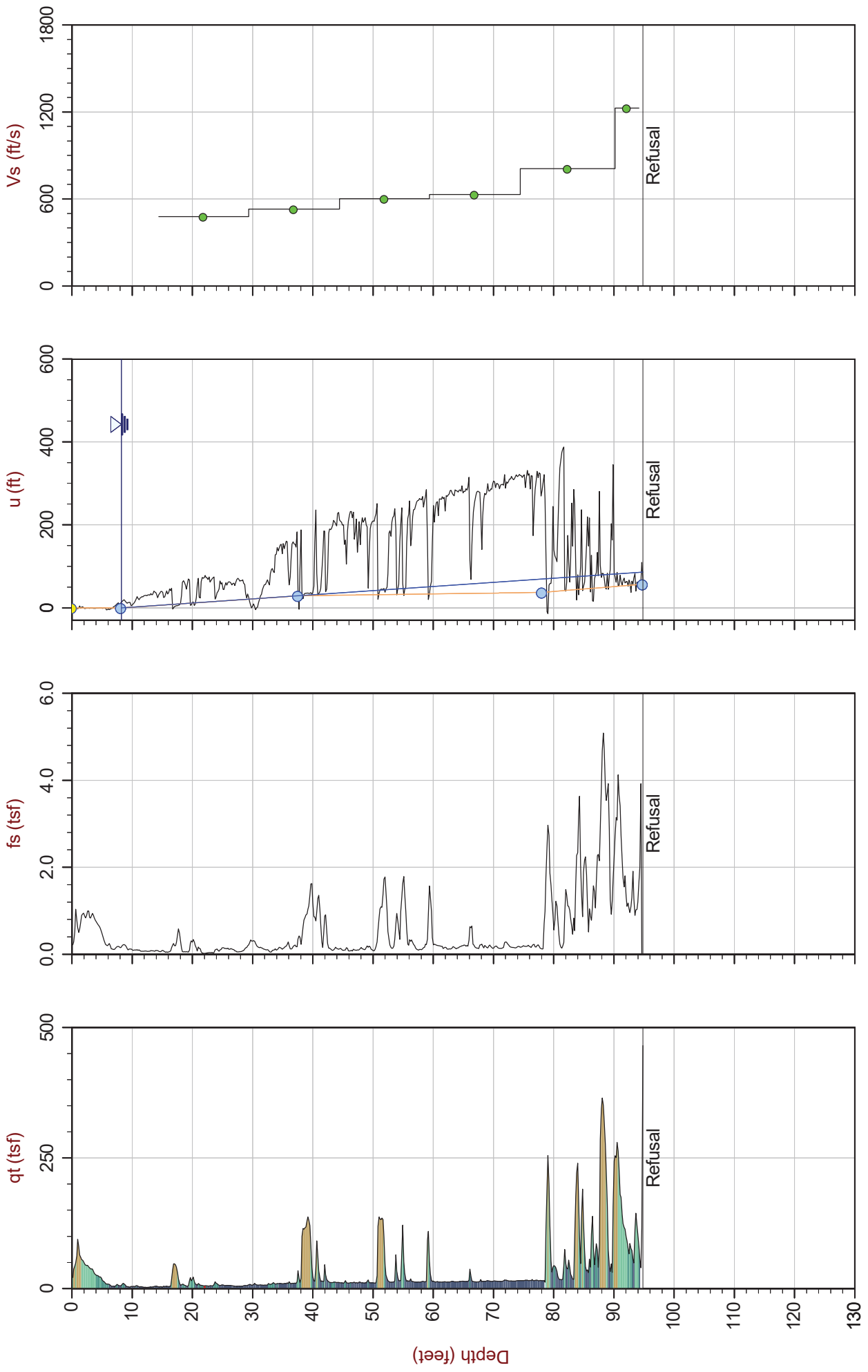

Max Depth: 28.900 m / 94.82 ft
Depth Inc: 0.050 m / 0.164 ft
Avg Int: Every Point

File: 19-61032_SP06.COR
Unit Wt: SBTQin (PKR2009)

SBT: Robertson, 2009 and 2010
Coords: UTM Zone 16N N: 4112426 E: 375716

Hydrostatic Line — Ueq ● Assumed Ueq ▲ PPD, Ueq achieved ▼ PPD, Ueq not achieved

The reported coordinates were acquired from consumer-grade GPS equipment and are only approximate locations. The coordinates should not be used for design purposes.



Stantec

Job No: 19-61032
Date: 2019-08-21 08:35
Site: US60 Bridge, Livingston County, KY

Sounding: SCPT19-07

Cone: 513:T1500F15U500

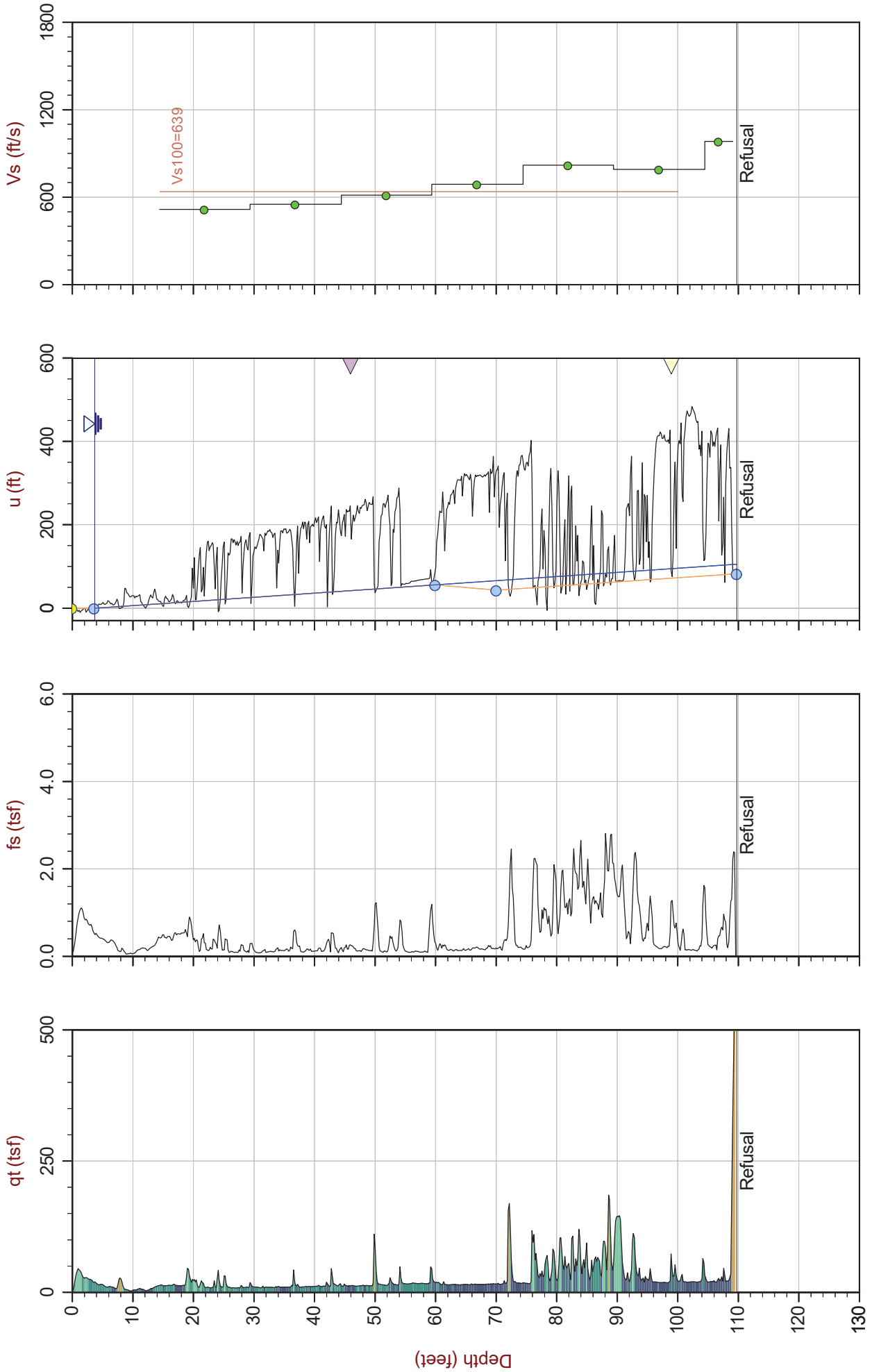

SBT: Robertson, 2009 and 2010
Coords: UTM Zone 16N N: 4112461 E: 375709

File: 19-61032_SP07.COR
Unit Wt: SBTQin (PKR2009)

Max Depth: 33.450 m / 109.74 ft
Depth Inc: 0.050 m / 0.164 ft
Avg Int: Every Point

Hydrostatic Line — Ueq ● Ueq achieved ▼ PPD, Ueq not achieved ▼ PPD, Ueq not achieved

The reported coordinates were acquired from consumer-grade GPS equipment and are only approximate locations. The coordinates should not be used for design purposes.



Stantec

Job No: 19-61032
Date: 2019-08-21 11:15
Site: US60 Bridge, Livingston County, KY

Sounding: SCPT19-08
Cone: 513:T1500F15U500

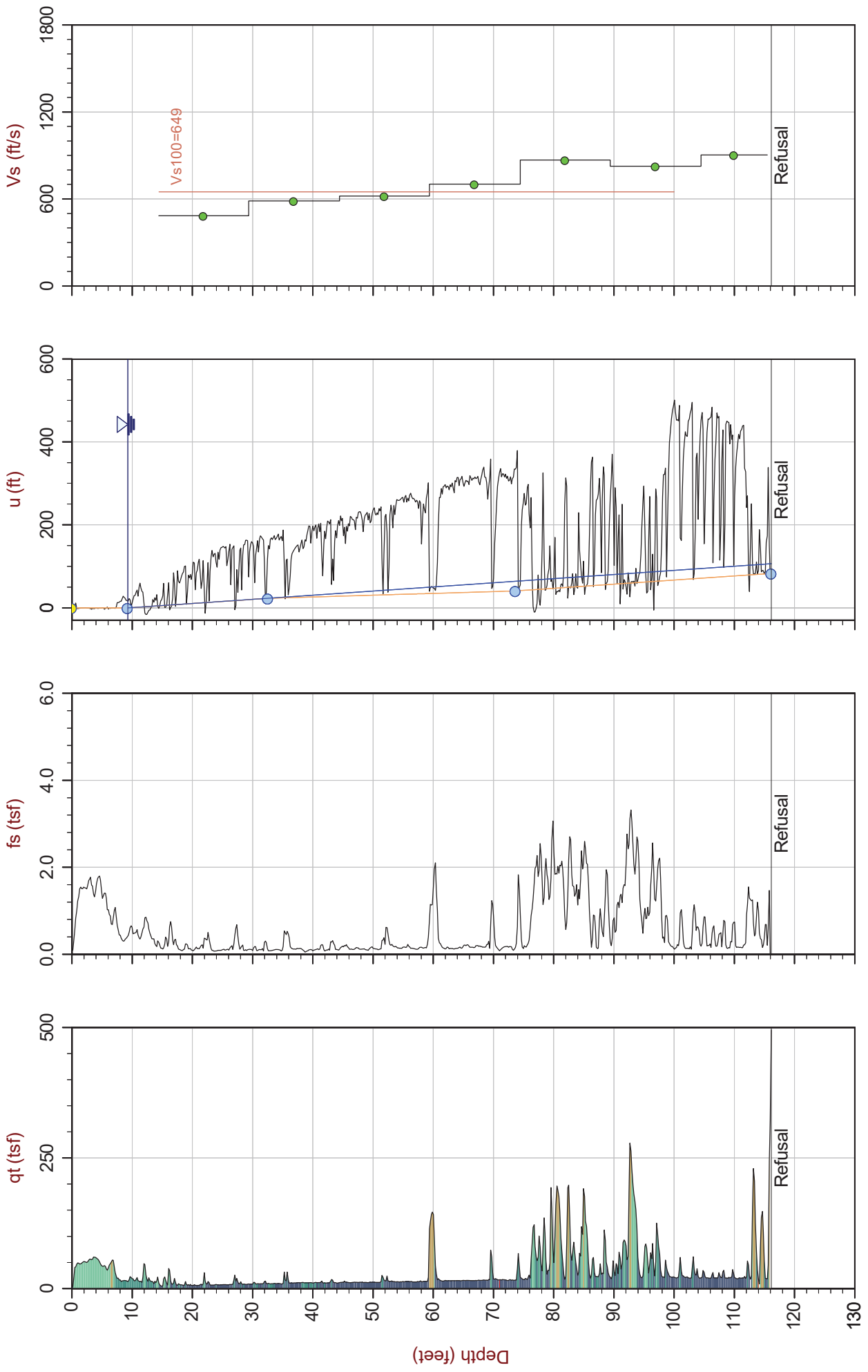

Max Depth: 35.400 m / 116.14 ft
Depth Inc: 0.050 m / 0.164 ft
Avg Int: Every Point

File: 19-61032_SP08.COR
Unit Wt: SBTQin (PKR2009)

SBT: Robertson, 2009 and 2010
Coords: UTM Zone 16N N: 4112444 E: 375723

Hydrostatic Line — Ueq ● Assumed Ueq ▼ PPD, Ueq achieved ▲ PPD, Ueq not achieved
The reported coordinates were acquired from consumer-grade GPS equipment and are only approximate locations. The coordinates should not be used for design purposes.



Stantec

Job No: 19-61032
Date: 2019-08-21 13:39
Site: US60 Bridge, Livingston County, KY

Sounding: SCPT19-09
Cone: 513:T1500F15U500

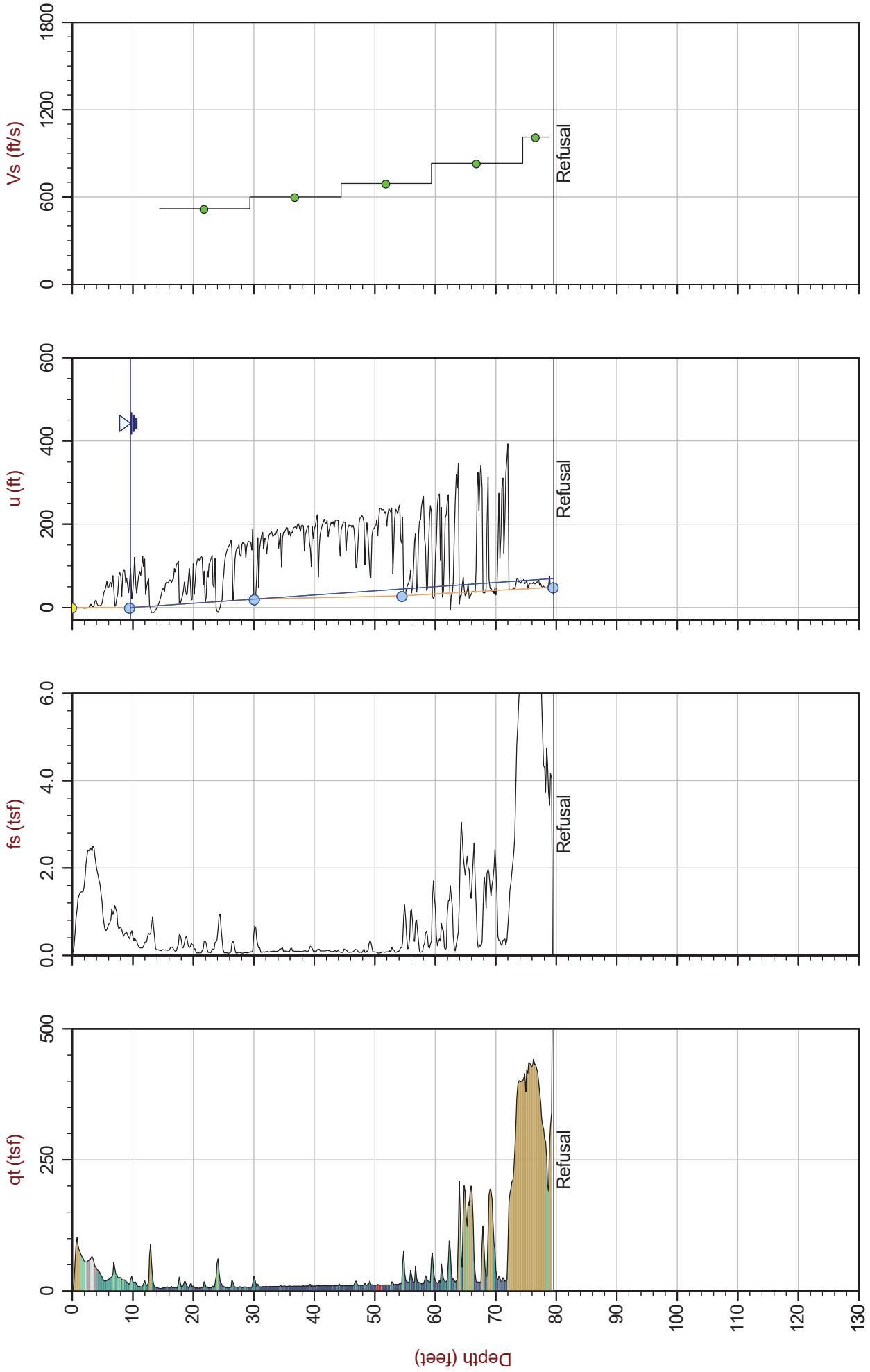

Max Depth: 24.250 m / 79.56 ft
Depth Inc: 0.050 m / 0.164 ft
Avg Int: Every Point

File: 19-61032_SP09.COR
Unit Wt: SBTQin (PKR2009)

SBT: Robertson, 2009 and 2010
Coords: UTM Zone 16N N: 4112545 E: 375744

Hydrostatic Line — Ueq ● Assumed Ueq ▼ PPD, Ueq achieved ▲ PPD, Ueq not achieved
The reported coordinates were acquired from consumer-grade GPS equipment and are only approximate locations. The coordinates should not be used for design purposes.



Stantec

Job No: 19-61032
Date: 2019-08-21 15:43
Site: US60 Bridge, Livingston County, KY

Sounding: SCPT19-10
Cone: 513:T1500F15U500

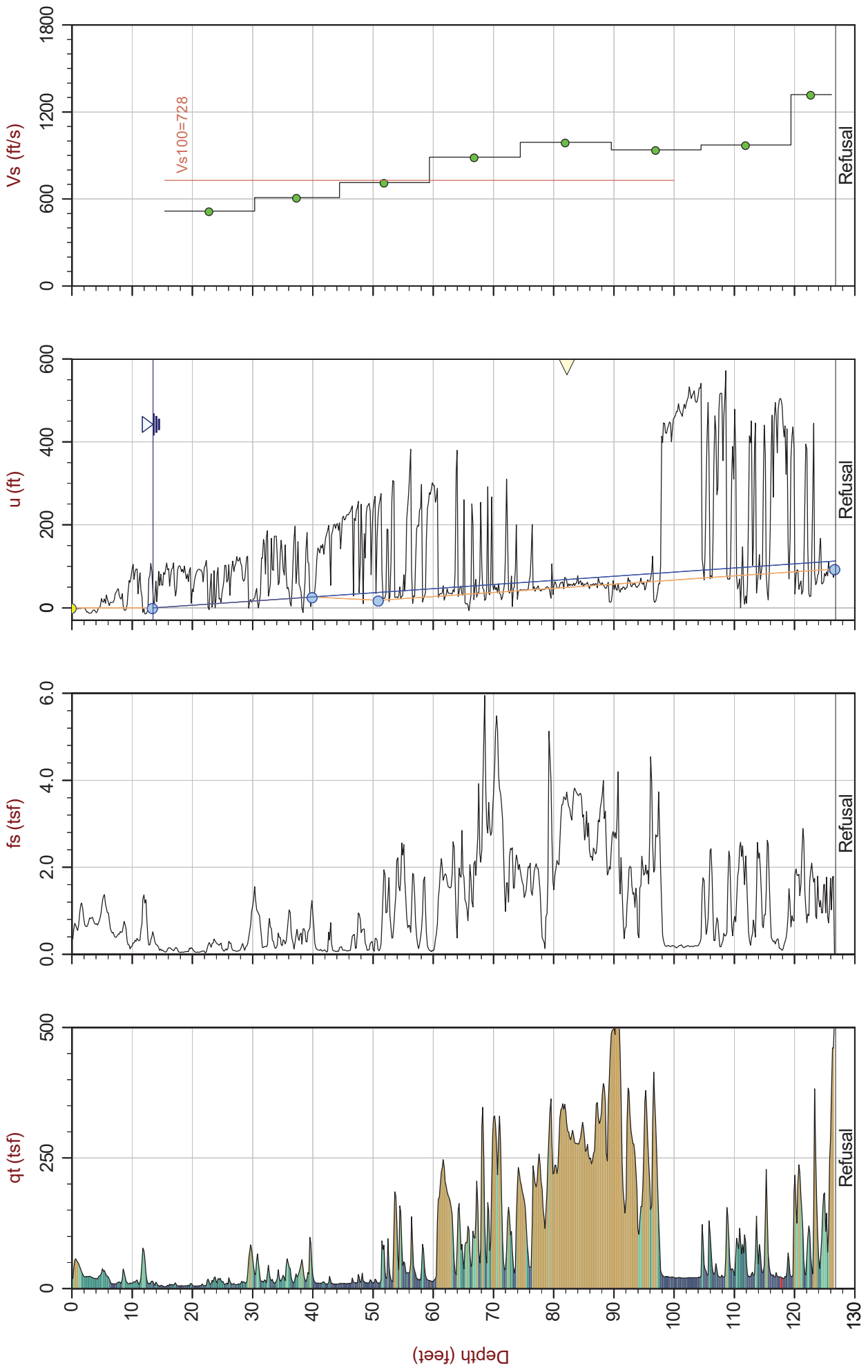

Max Depth: 38.650 m / 126.80 ft
Depth Inc: 0.050 m / 0.164 ft
Avg Int: Every Point

File: 19-61032_SP10.COR
Unit Wt: SBTQin (PKR2009)

SBT: Robertson, 2009 and 2010
Coords: UTM Zone 16N N: 4112576 E: 375747

Hydrostatic Line — Ueq ● Assumed Ueq ▼ PPD, Ueq achieved ▲ PPD, Ueq not achieved
The reported coordinates were acquired from consumer-grade GPS equipment and are only approximate locations. The coordinates should not be used for design purposes.



Stantec

Job No: 19-61032

Date: 2019-08-22 10:33

Site: US60 Bridge, Livingston County, KY

Sounding: SCPT19-11

Cone: 513:T1500F15U500

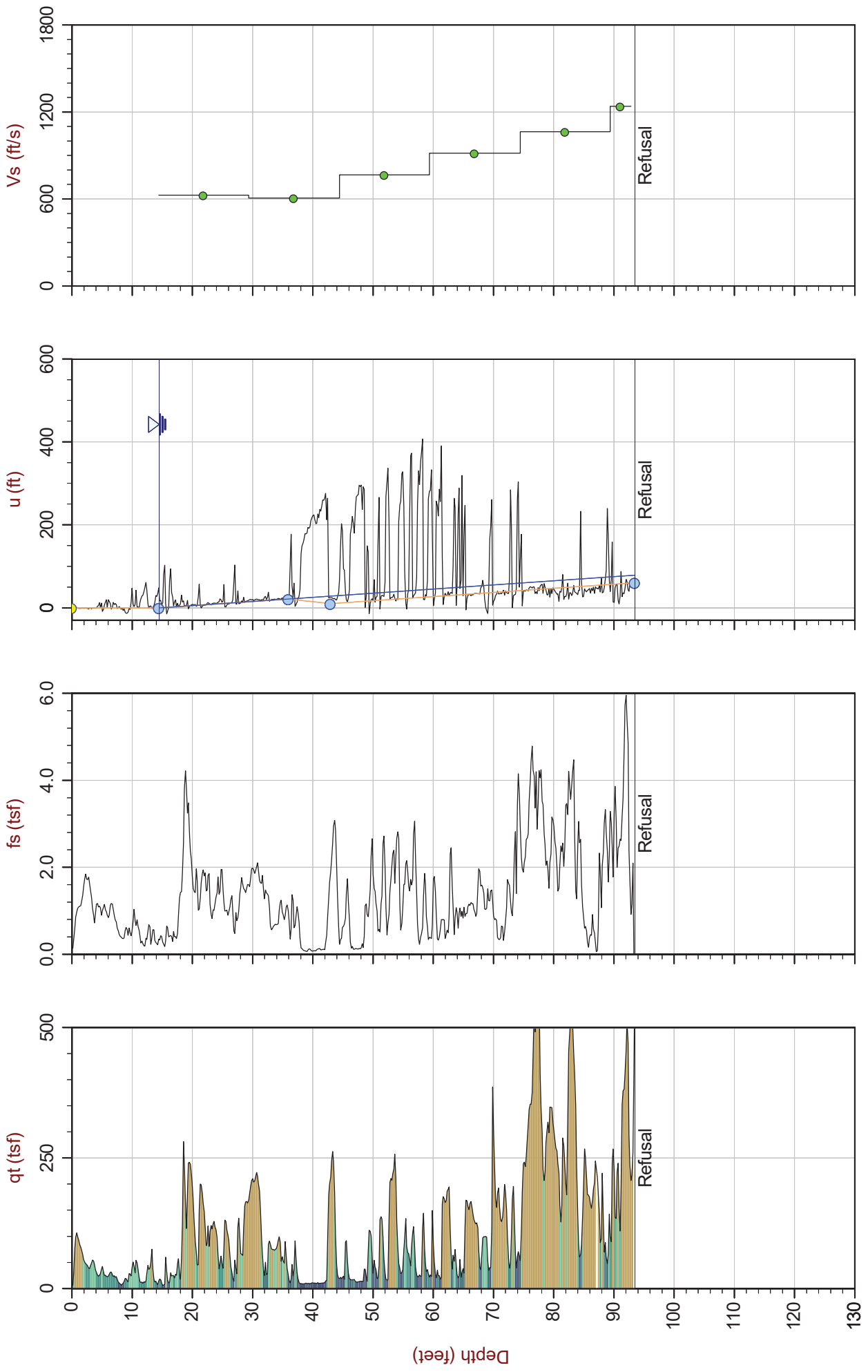

Max Depth: 28.500 m / 93.50 ft
 Depth Inc: 0.050 m / 0.164 ft
 Avg Int: Every Point

SBT: Robertson, 2009 and 2010
 Coords: UTM Zone 16N N: 4112619 E: 375756

Hydrostatic Line — Ueq ● Assumed Ueq ▼ PPD, Ueq achieved ▲ PPD, Ueq not achieved

The reported coordinates were acquired from consumer-grade GPS equipment and are only approximate locations. The coordinates should not be used for design purposes.

Pore Pressure Dissipation Summary and Pore Pressure Dissipation Plots





Job No: 19-61032
 Client: Stantec
 Project: US60 Bridge, Livingston County, KY
 Start Date: 20-Aug-2019
 End Date: 23-Aug-2019

CPTu PORE PRESSURE DISSIPATION SUMMARY

Sounding ID	File Name	Cone Area (cm ²)	Duration (s)	Test Depth (ft)	Estimated Equilibrium Pore Pressure U _{eq} (ft)	Calculated Phreatic Surface (ft)	Estimated Phreatic Surface (ft)	t ₅₀ ^a (s)	Assumed Rigidity Index (I _r)	c _h ^b (cm ² /min)
SCPT19-05	19-61032_SP05.PPD	15	160	97.77	83.9	13.8				
SCPT19-07	19-61032_SP07.PPD	15	1515	45.93	42.3		3.6	904	100	0.8
SCPT19-07	19-61032_SP07.PPD	15	180	98.92	75.4	23.5				
SCPT19-10	19-61032_SP10.PPD	15	300	82.18	49.7	32.5				
Total Duration			35.9 min							

a. Time is relative to where u_{max} occurred.

b. Houslsby and Teh, 1991.



Stantec

Job No: 19-61032
Date: 20-Aug-2019 09:56:23
Site: US60 Bridge, Livingston County, KY
Sounding: SCPT19-05
Cone: AD513 Area=15 cm²

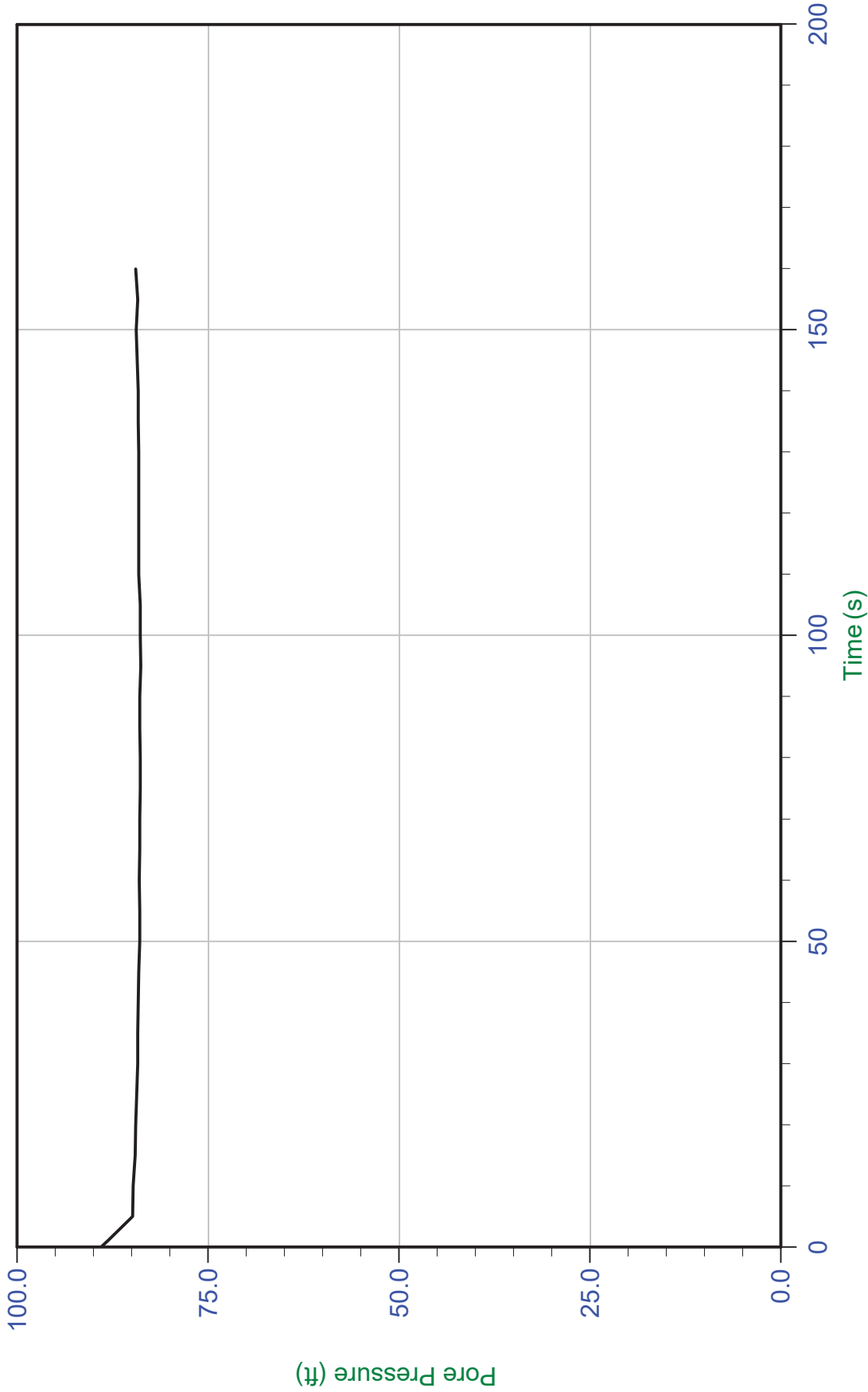

Trace Summary: Filename: 19-61032_SP05.PPD
Depth: 29.800 m / 97.768 ft
Duration: 160.0 s
U Min: 83.9 ft
U Max: 89.0 ft
WT: 4.219 m / 13.842 ft
Ueq: 83.9 ft



Stantec

Job No: 19-61032
Date: 21-Aug-2019 08:35:20
Site: US60 Bridge, Livingston County, KY
Sounding: SCPT19-07
Cone: AD513 Area=15 cm²

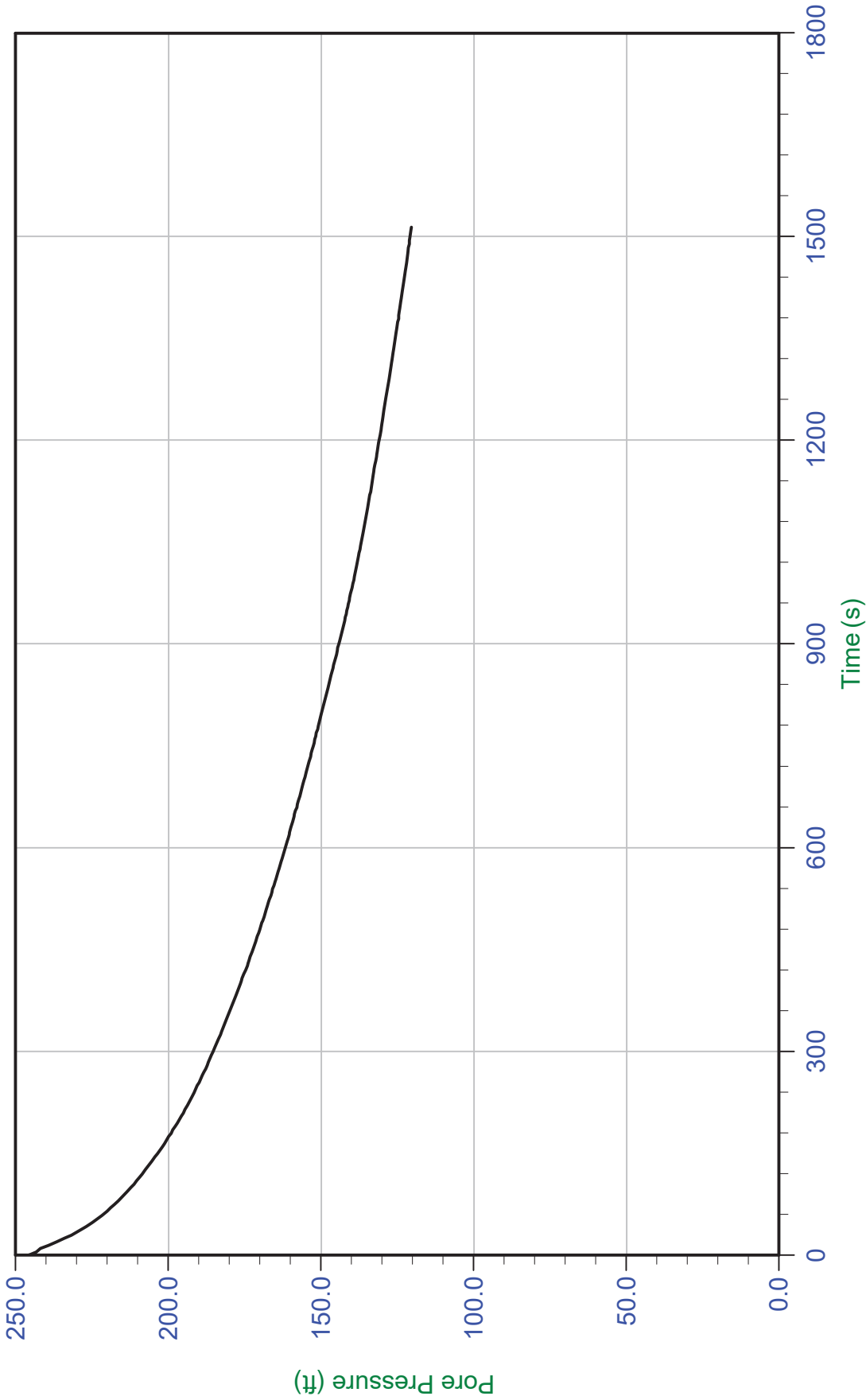

Trace Summary: Filename: 19-61032_SP07.PPD
Depth: 14.000 m / 45.931 ft
Duration: 1515.0 s
WT: 1.097 m / 3.599 ft
U Min: 120.4 ft
U Max: 245.7 ft
U(50): 144.00 ft
Ueq: 42.3 ft
T(50): 903.6 s
Ir: 100
Ch: 0.8 cm²/min



Stantec

Job No: 19-61032
Date: 21-Aug-2019 08:35:20
Site: US60 Bridge, Livingston County, KY
Sounding: SCPT19-07
Cone: AD513 Area=15 cm²

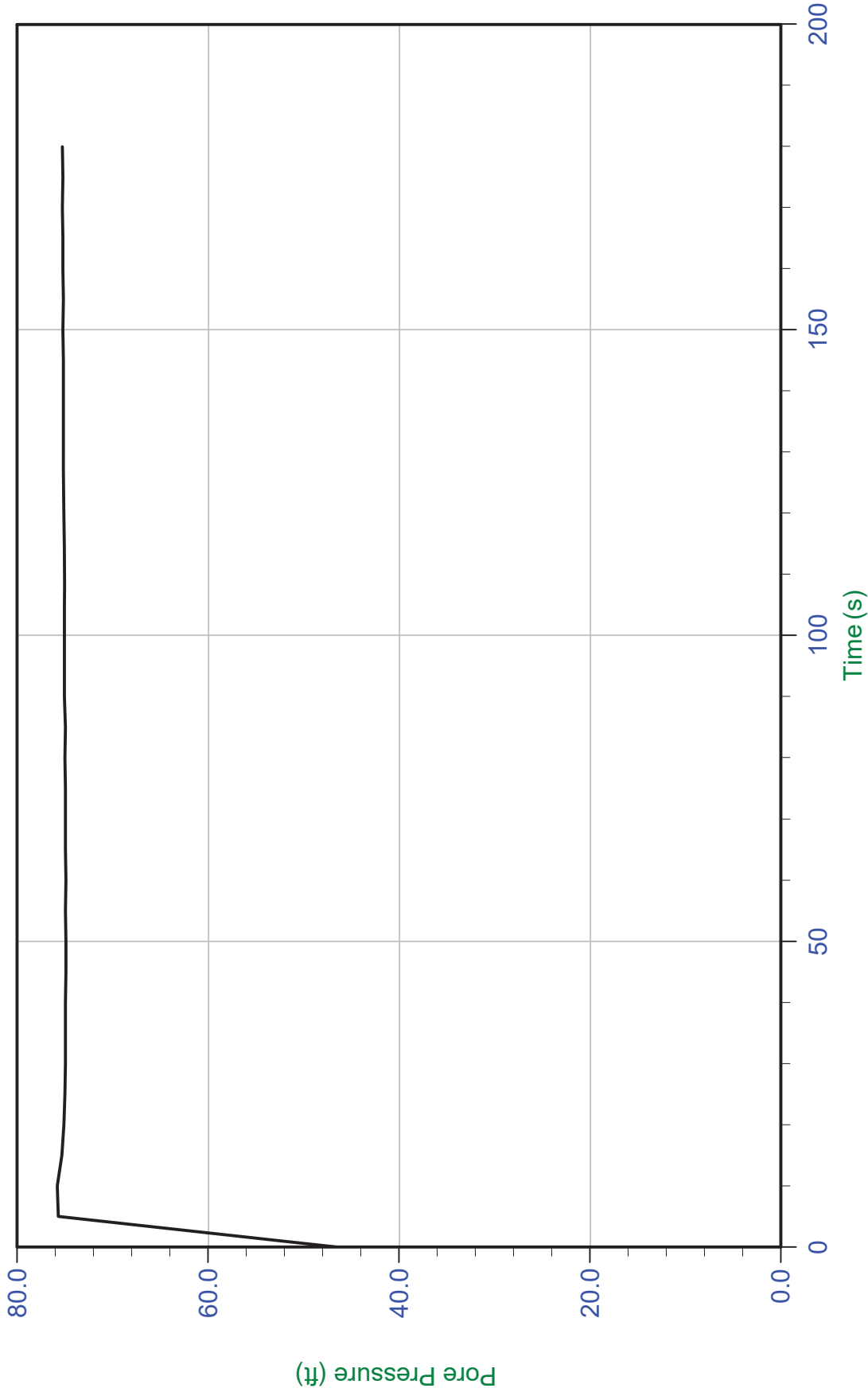

Trace Summary: Filename: 19-61032_SP07.PPD
Depth: 30.150 m / 98.916 ft
Duration: 180.0 s
U Min: 46.6 ft
U Max: 75.8 ft
WT: 7.159 m / 23.487 ft
Ueq: 75.4 ft



Stantec

Job No: 19-61032
Date: 21-Aug-2019 15:43:06
Site: US60 Bridge, Livingston County, KY
Sounding: SCPT19-10
Cone: AD513 Area=15 cm²

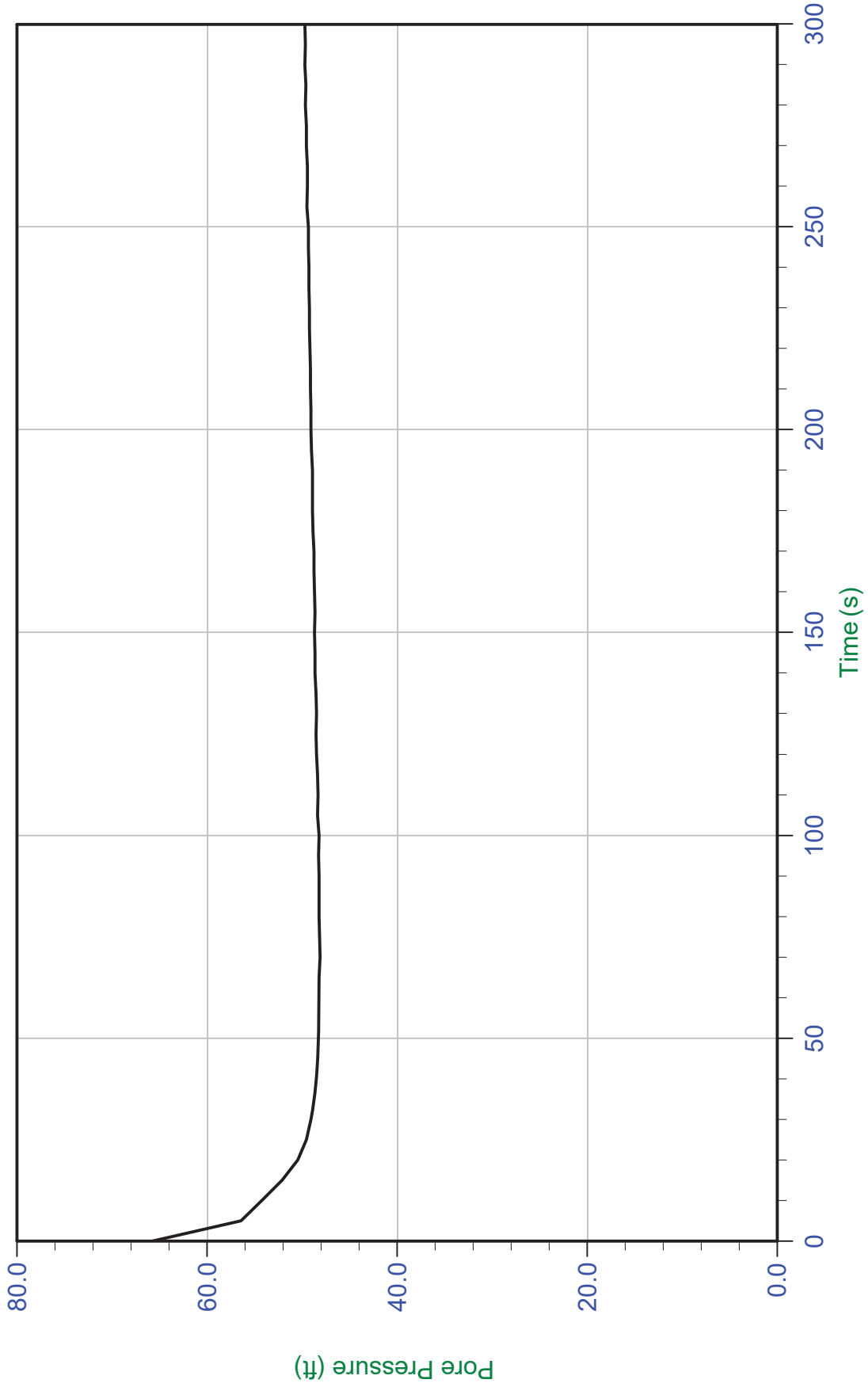

Trace Summary: Filename: 19-61032_SP10.PPD
Depth: 25.050 m / 82.184 ft
Duration: 300.0 s
U Min: 48.1 ft
U Max: 65.8 ft
WT: 9.897 m / 32.470 ft
Ueq: 49.7 ft

SPECIAL NOTE FOR NON-DESTRUCTIVE TESTING OF DRILLED SHAFTS

Livingston County – US 60 Bridge over the Cumberland River Item No. 1-1142.0

The following sections provide the requirements for non-destructive testing (Sonar Caliper, Crosshole Sonic Logging and Thermal Integrity Profiling) of the drilled shaft foundations, schedule requirements for submittals, reporting requirements and Contractor/Testing Subcontractor/Department responsibilities. The purpose of the non-destructive testing is to evaluate the integrity of the drilled shafts, to potentially detect voids or sloughed off or highly fractured zones of shale or sandstone or other discontinuities within and along the perimeter of the drilled shafts and to evaluate whether the shafts are within the specified geometrical tolerances.

References to the “Department” refer to the Kentucky Department of Highways and/or consultants acting on behalf of the Department.

In all cases, the Department reserves the right to request raw data, field notes and/or other available information that may be necessary to evaluate the results of testing specified in this Special Note. Upon request, provide any available information at no additional cost to the Department.

In all cases, the Department reserves the right to perform testing to obtain independent results of testing specified in this Special Note. Upon request, provide any assistance required for Department personnel to perform such testing at no additional cost to the Department.

At the request of the Engineer, personnel representing the Contractor (including testing subcontractors) and the Department may be required to attend a pre-test meeting to discuss procedures related to testing, reports, reviews, etc. This meeting will be at no additional cost to the Department.

Unless noted otherwise, the Department will respond to the Contractor regarding acceptability of submittals referenced in this Special Note within ten (10) business days. A “Business Day” is defined as any day except Saturdays, Sundays and Holidays, as defined in Section 101.03 of the Standard Specifications.

Livingston County Item No. 1-1142.0
 US 60 over Cumberland River

1.0 Sonar Caliper Testing of Drilled Shafts

1.1 Description

Acoustic measuring or Sonar Caliper (SC) devices provide an effective method for evaluating shaft verticality, volume and diameter in-situ by profiling the excavated surfaces of wet drilled shafts prior to reinforcement or concrete placement. The Contractor will be responsible for obtaining the services of an SC firm experienced with SC testing and equipment allowed by the Engineer. The Contractor will be responsible for scheduling and coordinating the testing, and submittal of the data to the Department. Perform SC testing using a device such as a SONICaliper™ Testing System (SCTS), Shaft Area Profile Evaluator (SHAPE) or other similar system allowed by the Department.

The caliper system will use one or more radial-spaced ultrasonic transceivers to transmit and receive acoustic signals between the tool and the borehole wall.

As directed by the Engineer, perform SC Testing after rock excavation is completed to the shaft tip elevation. If voids or sloughed off or highly fractured zones of shale or sandstone or other features are detected, additional SC testing may be directed by the Engineer.

Acceptance of a testing firm and/or sonar caliper system to perform and continue to perform SC testing on this project are subject to completing Submittal No. 1 in Table 1 below to the satisfaction of the Department and satisfactory performance.

1.2 SC Testing and Evaluation of Test Results

Make submittals in accordance with the Project requirements for submittals. See Table 1 below.

Table 1 – Schedule of SC Submittals			
Submittal Number	Submittal Item	Deadline	Event
1	Technical Proposal with SC Testing Firm Qualifications	45 business days before	Start of Drilled Shaft Construction
2	SC Preliminary Testing Reports	12 HOURS after	Completion of testing on an individual drilled shaft
3	SC Final Testing Reports	5 business days after	Completion of testing on an individual drilled shaft

Provide all submittals and reports in .pdf format

Livingston County Item No. 1-1142.0
US 60 over Cumberland River

1.2.1 Technical Proposal (Including Example Reports)

Submit a technical proposal prepared by the SC Testing Firm that addresses the testing procedures and required qualifications and experience of the testing firm (Submittal No. 1 in Table 1.) Include sufficient documentation to show that the firm and person overseeing the work meet the requirement of having SC testing and data interpretation experience on at least three (3) similar deep foundation projects [or two (2) deep foundation projects supplemented by at least two (2) other projects where similar sonar imaging was performed].

With the technical proposal, include examples of field data report presentation and SC test reports prepared in accordance with the reporting requirements below. Include any costs associated with the examples in the applicable unit bid prices for SC testing. If the initial example submittal does not meet the specified requirements the Department will require additional submittals until the testing firm demonstrates that they can generate a report that meets the specified requirements. The purposes of these reports are for the SC testing firm to demonstrate their understanding of the reporting requirements and capability to meet them and to ensure that Department personnel are familiar with and understand the testing firm's reporting format and style. The ultimate objective of this requirement is to facilitate timely reviews of production test reports and reduce the potential for delays in allowing drilled shaft construction to proceed. Timely evaluation of sonar caliper reports (including field data reports) is critical, so the importance of these example reports cannot be overstated. Failure of a proposed testing firm to take this requirement seriously and/or submit acceptable example reports may result in disqualification of the testing firm.

Additionally, include the following

- confirmation that the SC testing firm understands and can meet the specified reporting deadlines in Section 1.2.2 including the requirement to provide a field data report within 60 minutes after completing testing
- confirmation that the SC testing firm understands that the SC test results will be used to evaluate whether the shaft meets the specified as-built shaft tolerances
- plans for set up of the sonar system including drawings, sketches, etc.
- protocol for coordinating with the project surveyor as defined in Section 1.2.3 below, including confirmation that the SC testing firm has discussed and agreed upon the protocol with the Contractor and lead surveyor
- proposal for how and where to perform the dry run test described in Section 1.2.4 below including confirmation that the SC testing firm has discussed and agreed upon the details of the dry run test with the Contractor
- discussion of anticipated effects of drilling slurry on the SC results, if applicable, including the possible need for flocculent to facilitate the testing
- discussion of procedures to ensure and/or verify that the lowering and raising of the sonar device will be vertical and/or how to account for any lateral movement of the sonar device
- discussion of measurement frequency, accuracy, and thus volume reporting

Livingston County Item No. 1-1142.0
US 60 over Cumberland River

1.2.2 Testing

Perform the SC Testing as described below:

- The Contractor is responsible for providing the testing firm access to the top of the shaft enabling one person to centralize and lower the sonar caliper device into the test shaft or affix it to the shaft drill rig kelly bar as applicable. Provide a surrounding work area clear and free of debris. Provide such assistance, equipment (including a power source if required by the SC testing firm) or necessary materials to the testing firm as required to facilitate the Sonar Caliper process.
- The Contractor is responsible for providing flocculent, if necessary to facilitate performing the SC testing.
- Coordinate with the project surveyor prior to every test as described in Section 1.2.3 below.
- Perform Sonar Caliper testing to evaluate verticality, diameter and volume on all finished excavated shafts (unless directed otherwise by the Engineer) in accordance with generally accepted Sonar Caliper testing methods and transmitting 50 to 400 measurement data points at each elevation. To acquire verticality information, affix the caliper head to a guide cable that is weighted near the bottom of the shaft or on the kelly bar as applicable and position it plumb. If the device is affixed to the kelly bar, use a carpenter's level to assess the verticality of the kelly bar throughout the duration of the test; conform to applicable OSHA and other safety protocol requirements. Refer to the requirement in Section 1.2.1 to include a verticality discussion in the technical proposal.
- At a minimum, take caliper readings using 10 feet increments in the casing, 6-inch increments in rock strata, 12 inch increments within 5 ft. of the transition from casing to rock socket and 12 inch increments within 5 ft. above and below any transitions in casing diameter (due to telescoping casing, etc.). During sonar caliper, measure a 360-degree profile measuring all angles relative to the survey ahead station direction.
- Provide a field data report (either a hard copy or emailed .pdf file) that includes analyses of shaft verticality, diameter or radius, and volume to the Engineer on site within 60 minutes after completion of testing. If it appears that the specified verticality tolerances have not been met, the Engineer may require adjustments to the casing. If a feature, which in the opinion of the Engineer could affect the integrity of the uncased shaft is identified in the field on the visual display, the Engineer may reduce the testing interval as necessary to improve the definition of the feature. Provide these additional readings at no additional cost to the Department. If it appears that the shaft is acceptable based on evaluation of the field data report, the Engineer will allow the Contractor to proceed with reinforcing steel installation and concrete placement.

1.2.3 Surveying Requirements

In order to evaluate shaft tolerances it is necessary to tie the sonar test results to project station, offset and elevation. Therefore, coordination between the sonar caliper test personnel and the Contractor's project surveyor will be required. Ensure that the project surveyor is available to perform the tasks below prior to the beginning of each test:

Livingston County Item No. 1-1142.0
US 60 over Cumberland River

1. Survey the elevation of the top of permanent casing and the station and offset of a point on the top and interior of the permanent casing at the most ahead station point.
2. Survey the location of the sonar caliper device in the hole as necessary to tie the sonar test results to the station and offset.
3. Survey the test reference elevation (i.e. zero depth elevation for the test) if the reference elevation is something other than the top of permanent casing.
4. Provide a mark on the casing or other fixed object which clearly indicates the ahead station direction so that the SC testing personnel can reference angles relative to the ahead station direction.
5. Provide any other information or services needed by the SC testing firm to meet the specified SC test requirements.
6. Provide all referenced information to the SC testing firm immediately.

Include any costs associated with providing these surveying services in the applicable unit bid price for Sonar Caliper testing.

1.2.4 Dry Run Test

At least 10 calendar days prior to the anticipated starting date of rock socket excavation at each pier location, perform a "dry run" or practice sonar caliper test at a specific location proposed by the Contractor and accepted by the Engineer. The purpose of this dry run test is for the Contractor and SC Testing Firm to demonstrate their capability to successfully coordinate and perform sonar caliper testing and produce required reports within the specified time frame. Additionally, the purpose is for the Department personnel to observe the testing and ensure that they can interpret the data in the format presented in order to evaluate whether shafts meet the applicable criteria. The intent of requiring the dry run tests is not to delay the project but rather to accelerate the review and acceptance process.

It will be acceptable to perform these tests in either a permanent or temporary casing either at a shaft location or out of position using a minimum 30 ft. test length. Rock socket caliper testing will not be required for the dry run test. The Department will not make direct payment for any soil excavation required to perform the dry run test. Pending successful performance and considering the similarities of proposed testing procedures and anticipated conditions between the two pier locations, the Department will consider waiving the requirement to perform a dry run test at both pier locations.

Perform the dry run test according to the procedures described in Section 1.2.2 above except that readings are required every 12 inches over at least the bottom 10 ft. and every five (5) feet over the remainder of the tested length. Submit preliminary and final reports in accordance with Section 1.2.5 below.

If the specified requirements for a dry run test are not met the Engineer may require additional dry run testing at no cost to the Department. Failure of a proposed SC testing firm to take this

Livingston County Item No. 1-1142.0
US 60 over Cumberland River

requirement seriously and/or submit acceptable reports (including providing a field data report) within the specified times may result in disqualification of the testing firm. Begin rock socket excavation in the first production shaft at each pier location only after receiving notification from the Engineer that the presentation of field data report and preliminary SC test report for the dry run test at that pier location is acceptable. As previously stated, the intent of requiring the dry run tests is not to delay the project but rather to accelerate the review and acceptance process.

The Department will pay for each dry run test as a regular production test according to the applicable unit bid price for Sonar Caliper testing associated with the pier location at which the dry run test is being performed.

1.2.5 Test Reports

Field Data Report - Within 60 minutes after completion of testing, provide a field data report (either a hard copy or emailed .pdf file) that includes analyses of shaft verticality, diameter or radius, and volume to the Engineer.

Preliminary Report - Within 12 hours after completing the SC Testing, perform all required filtering and analyses to submit a preliminary report (Submittal No. 2 in Table 1) in .pdf format. Include the following:

1. Test date and times of beginning and end of test
2. Shaft No. and reference elevation
3. Graphical representation such as wire frame plots of the permanent casing interior and rock socket from multiple viewpoints to facilitate visual evaluation of casing abnormalities, geological features in the rock socket and casing to rock socket transition
4. Plot of shaft volume vs. depth
5. Brief descriptions of any geologic features that the device is capable of detecting such as cavities, crevices or voids in the rock socket wall, including a general description with approximate depths and elevations
6. Verticality analysis including plots as needed to facilitate evaluation of the station and offset of the geometric center (based on coordination with the surveyor as described in Section 1.2.3 above) of shaft along the length of the permanent casing and rock socket from the plan top of shaft to as close to the shaft tip as possible including the items below:
 - Clear indication of the ahead station direction in drawings, sketches, plots, etc.
 - Station and offset of the geometric center of the top of permanent casing and plan top of shaft (if different from top of casing at the time of testing)
 - Sufficient data and/or plots to readily evaluate the change in station and offset of the geometric center of permanent casing from the top to the bottom of casing
 - Sufficient data and/or plots to readily evaluate the change in station and offset of the geometric center of the rock socket from the top to bottom of the rock socket (when the rock socket is profiled)

Livingston County Item No. 1-1142.0
US 60 over Cumberland River

- The changes in station and offset of the geometric center of the rock socket relative to the geometric center of the casing at the transition between the casing and the rock socket (when the rock socket is profiled)
- Any other information requested by the Department if necessary to evaluate the shaft tolerances specified in the Special Note for Project Specific Drilled Shaft Requirements.

Ensure that the SC testing firm is prepared to devote sufficient personnel and/or work overnight to meet the submittal time requirement and be available to answer questions via emails and/or phone calls at any time while the Department is reviewing the preliminary report.

Final Report - Within five (5) business days after completion of each test, submit a .pdf copy of the final report to the Department (Submittal No. 3 in Table 1), including, as a minimum, the following:

1. Contents of the preliminary report with any modifications as required for final report quality presentation
2. A narrative which explains all aspects of the test, results and analyses
3. Description of any shaft wall encroachment
4. One or more photographs of the test setup including orientation sonar device and clear indication of the ahead station direction
5. Written documentation of information received from the project surveyor
6. Resolution of any outstanding issues based on the preliminary report or any subsequent communication

1.2.6 Evaluation of SC Test Results

Allow direct communication between the SC Testing Firm and the Department. If the SC Testing Firm is different than other testing firms on the project, allow direct contact between the SC and other testing firms.

The Engineer will review the data collected by the SC Testing Firm in the field data report as described in Section 1.2.2 above and will allow the Contractor to proceed if the shaft appears to be acceptable.

The Department will review the submitted preliminary report to perform a more rigorous evaluation of whether the construction tolerances have been met and respond to the Contractor within 48 hours after receiving the preliminary report. If, based on review of a preliminary report, it is found that construction tolerances have not been met then modifications to the footing and/or other shafts may be required at no cost to the Department.

The Department will review the submitted final report to ensure conformance with the final report requirements of Section 1.2.5.

Livingston County Item No. 1-1142.0
US 60 over Cumberland River

2.0 Crosshole Sonic Logging

2.1 Description

Crosshole Sonic Logging (CSL) is a nondestructive method to test the integrity of drilled shafts in accordance with ASTM D6760. It is the responsibility of the Contractor to supply all equipment and materials necessary to perform this testing and for obtaining the services of a CSL Testing Firm, which is experienced with CSL testing in accordance with Section 2.4.1 of this note and approved by the Department, to perform the testing.

The Contractor will be responsible for providing:

1. access tubes to be used for CSL testing of the drilled shafts;
2. watertight shoes, watertight caps, and non-shrink grout;
3. suitable working space and access to every shaft;
4. any other equipment, materials, or assistance necessary to accomplish the testing.

2.2 Materials

2.2.1 Access Tubes

1. Provide access tubes meeting the requirements below:
 - a. 2 inch ID schedule 40 steel pipe conforming to ASTM A 53, Grade A or B, Type E, F, or S;
 - b. contains round, regular internal diameters free of defects or obstructions, including any at pipe joints;
 - c. capable of permitting the free, unobstructed passage of a 1.5-inch-diameter source and receiver probes; and
 - d. watertight and free from corrosion with clean internal and external faces to ensure passage of the probes and a good bond between the concrete and the tubes.
2. Provide watertight shoes on the bottom and removable watertight caps on the top of the tubes.
3. The Engineer will accept access tubes based on visual inspection and certification that the steel pipe meets the requirements above.

2.2.2 Grout

Provide non-shrink grout to fill the access tubes and any cored holes at the completion of the CSL tests. Use grout conforming to Section 601.03.03 of the Standard Specifications.

Livingston County Item No. 1-1142.0
US 60 over Cumberland River

2.3 Execution

2.3.1 Access Tube Installation

1. Install access tubes generally evenly-spaced and as shown below:
 - Pier 3 8 tubes
 - Pier 4 8 tubes
2. Securely attach the CSL tubes that are along the inside periphery to the spiral reinforcement. Wire-tie the tubes a minimum of every 3 ft. so they will stay in position during placement of reinforcement and concrete. Place the tubes so they will be parallel with each other and as near to vertical as possible in the finished shaft. Even moderate bending of the tubes will result in large regional variations in the data.
3. Place the tubes approximately 3 to 6 inches above the shaft tip ~~to~~ and at least 3 ft. above the top of rebar cage, at least 3 ft. above the free water level (if above the ground surface), at least 1 ft. above the top of concrete, and at least 3 ft. above the top of casing. Under no circumstances may the tubes be allowed to come to rest on the bottom of the excavation.
4. Ensure that any joints in the tubes are watertight and no residual putty is remaining on the outside of the couplers.
5. Tubes may be extended with mechanical couplings. Do not use duct tape or other wrapping material to seal the joints. Welding of joints is prohibited.
6. During placement of the reinforcement cage, exercise care so that the tubes will not be damaged to the extent that would prevent a 1.5 inch diameter probe from passing through them.
7. After placing the reinforcing cage and before beginning concrete placement, **fill the tubes with clean potable water** and cap or seal the tube tops to keep debris out of the tubes. Replace the watertight caps immediately after filling the tubes with water.
8. Immediately before placing concrete, use a weighted tape to investigate all tubes to make sure that there are no bends, crimps, obstructions or other impediments to the free passage of the testing probes. Additionally, check to ensure there are no water leaks.
9. During removal of the caps from the tubes, exercise care so as not to apply excess torque, hammering, or other stresses which could break the bond between the tubes and concrete.
10. Immediately after concrete placement, recheck each access tube to ensure that the water level is at the top of the tube. (This is due to the potential for air bubbles entrapped in the tube to rise during the pour and lower the water level in the tube.)
11. After concrete placement and before the beginning of CSL testing, inspect the access tubes and report any access tubes that the 1.5 inch diameter test probe cannot pass through to the Engineer. The Engineer will evaluate whether the CSL testing can be successfully performed without the impacted tube(s); the Engineer may require the Contractor to, at its own expense, replace one or more tubes with 2-inch-diameter holes cored through the concrete for the entire length of the shaft, excluding the bottom 6 inches. Unless directed otherwise by the Engineer, locate core holes approximately 6 inches inside the reinforcement such that it does not damage the reinforcement. For each core hole drilled, record a log with descriptions of inclusions and voids in the cored

Livingston County Item No. 1-1142.0
US 60 over Cumberland River

holes and submit a copy of the log and photographs to the Engineer. Preserve the cores, identify as to location and make available for inspection by the Engineer.

2.3.2 Grouting

After completion of the CSL and Thermal Integrity Profile (TIP) testing, evaluation of results and upon being directed by the Engineer, remove the water from the access tubes and any cored holes, completely fill the tubes and holes with approved grout using the tremie method. After grouting, cut the tubes flush with the tops of the drilled shafts.

2.4 CSL Testing and Evaluation of Test Results

Make submittals in accordance with the Project requirements for submittals. See Table 2 below.

Table 2 – Schedule of CSL Submittals			
Submittal Number	Submittal Item	Deadline	Event
1	Technical Proposal with CSL Testing Firm qualifications	45 business days before	Start of Drilled Shaft Construction
2	CSL Testing Reports	5 business days after	Completion of testing on an individual drilled shaft
Provide all submittals and reports in .pdf format			

2.4.1 Technical Proposal (Including Example Report)

Submit a technical proposal prepared by the CSL Testing Firm that addresses the testing procedures and required qualifications and experience of the testing firm. Include sufficient documentation to show that the firm and the person overseeing the work on this project meet the requirement of having CSL testing, data interpretation and reporting experience on at least three (3) similar deep foundation projects.

With the technical proposal, include an example CSL test report prepared in accordance with the reporting requirements below. Include any costs associated with the example report in the applicable unit bid prices for CSL testing. If deviations from the specified reporting requirements are noted during review, the Department may (depending on the extent of the deviations) elect to require the testing to confirm that they can meet the requirements in production test reports rather than resubmit the example report. The purposes of this report are for the CSL testing firm to demonstrate their understanding of the reporting requirements and capability to meet them and to ensure that Department personnel are familiar with and understand the testing firm's reporting format and style. The ultimate objective of this requirement is to facilitate timely

Livingston County Item No. 1-1142.0
 US 60 over Cumberland River

reviews of production test reports and reduce the potential for delays in shaft acceptance. Failure to submit an acceptable example report may result in disqualification of the testing firm.

2.4.2 Testing

1. Provide access to the top of the shaft for testing personnel and equipment.
2. Perform CSL testing in accordance with ASTM D 6760.
3. Perform CSL testing on all completed shafts, including a second test when directed by the Engineer. Perform the first test after the shaft concrete has cured a minimum of 72 hours and no more than 10 days (unless directed otherwise by the Engineer) and has obtained a minimum strength of 3000 psi. Perform the second test after the shaft concrete has cured at least 28 days and obtained a minimum strength of 4000 psi. (Based on prior experience with similar shaft diameters, numerous flaws and defects were encountered on shafts tested at about 14 days and significant improvement was noted upon retesting at about 30 to 40 days.) The Department may waive the 28 day CSL testing on some shafts if acceptance can be granted based on the 72-hour to 10-day test results after evaluating the improvement noted between the 72-hour to 10-day and 28-day tests on previously-tested shafts and considering TIP test results in conjunction with CSL test results. The intent is to perform 28 day testing on the earlier shafts constructed at each pier and eliminate 28 day testing on the later shafts constructed at each pier.
4. Obtain logs as shown below unless directed otherwise by the Engineer.

Substructure Unit	Tubes	Perimeter Logs	Major Diagonal Logs	Minor Diagonal Logs
Pier 3	8	8	4	16
Pier 4	8	8	4	16

5. If during testing, it is apparent that tube debonding has occurred, the Contractor may consider flooding the top of the shaft and retesting immediately; it is possible that water may flow into gaps between the tubes and concrete and provide continuity for the sonic waves.
6. If the CSL testing firm or Contractor believes that additional testing is required (such as CSL retesting, Angled CSL, Crosshole Tomography Analysis, or Sonic Echo/Impulse Response, etc.), contact the Engineer immediately. The Department will review the test report(s) to evaluate whether additional testing is required. If the additional testing indicates that any drilled shaft on which additional testing was required is acceptable, the Department will pay for the direct cost of additional testing by change order. If the additional testing or evaluation of cores indicates that the concrete for any drilled shaft concrete is unacceptable, the additional testing will be at the expense of the Contractor. The Department will not pay for additional testing performed at the discretion of the Contractor or testing firm that is not directed and/or agreed upon by the Department.

Livingston County Item No. 1-1142.0
US 60 over Cumberland River

2.4.3 Test Reports

1. Submit a test report prepared by the CSL Testing Firm within 5 business days of completion of testing which, as a minimum, contains:
 - a. Date of test;
 - b. Plan Shaft No. and Reference Elevation (i.e. zero depth elevation) and notation of water level in the tubes at the time of testing;
 - c. Schematic showing a plan view of the access tube locations;
 - d. CSL logs with reference elevations;
 - e. CSL logs presented for each tube pair tested with any discontinuity zones indicated on the logs and discussed in the report as appropriate;
 - f. Analyses of **both** pulse first arrival time (FAT) versus depth **and** wave speed versus depth;
 - g. Include nested signal peak (i.e. "waterfall") diagrams as a function of time plotted vs. depth. Clearly indicate the FAT picks used to obtain wave speed vs. depth.
 - h. Analyses of pulse energy/amplitude versus depth.
 - i. Tables which indicate tube pairs, vertical extents, and magnitude (FAT % delay and/or energy decrease) of flaw and defect zones, as defined in Section 2.4.5 of this Special Note.
 - j. A narrative portion of the report will be used to present items a thru i.
2. Plot data to a scale that will allow adequate evaluation of data variations. The Department reserves the right to request scale adjustments.
3. Complete all reports using English units.

2.4.4. Evaluation of CSL Test Results

1. Allow direct communication between the CSL Testing Firm and the Department. If the CSL Testing Firm is different than other testing firms on the project, allow direct communication between the CSL and other testing firms.
2. The Department will review the CSL test results in the test report to evaluate whether or not the drilled shaft integrity is acceptable. Within 10 business days after receiving a test report, the Engineer will report to the Contractor whether the construction is acceptable or additional analyses are needed. The Department will also use the results of other non-destructive and materials testing, construction records, etc. to evaluate the condition of the shafts.
3. Continue with construction of the structure above the drilled shafts only after receiving written approval from the Engineer to do so, based on evaluation of the CSL and TIP test results and other applicable test results, construction records, etc.
4. If the CSL and/or TIP records are inconclusive (e.g. records do not clearly indicate discontinuity, good conditions or missing data), the Department may require additional testing, such as CSL retesting, Angled CSL, Crosshole Tomography

Livingston County Item No. 1-1142.0
US 60 over Cumberland River

Analysis or concrete cores to sample the concrete in question to verify shaft conditions. After completing report reviews, the Department will discuss options for additional testing with the Contractor and/or testing firm(s) and/or complete evaluation of all test results prior to directing the Contractor to obtain concrete cores. The Department will not pay for additional testing performed at the discretion of the Contractor or testing firm that is not directed and/or agreed upon by the Department. If core samples are needed, obtain cores with a minimum diameter of 2 inches using a double tube core barrel at a minimum of 4 locations selected by the Department, unless directed otherwise by the Engineer. Unless directed otherwise by the Engineer, locate core holes approximately 6 inches inside the reinforcement such that they do not damage the reinforcement. For each core hole drilled, record a log with descriptions of inclusions and voids in the cored holes and submit a copy of the log to the Engineer. Place the cores in core boxes as shown in Exhibit 10 of the KYTC Geotechnical Guidance Manual properly marked showing the shaft depth at each interval of core recovery. Transport the cores and logs to the Geotechnical Branch in Frankfort for inspection and testing unless directed otherwise by the Engineer. Only after being directed by the Engineer grout the core holes in accordance with Section 2.3.2 above.

5. If the additional testing or evaluation of cores indicate that concrete for any drilled shaft on which additional testing or coring was required is acceptable, the Department will pay for the direct cost of additional testing and concrete coring and grouting by change order. If the additional testing or evaluation of cores indicates that the concrete for any drilled shaft concrete is unacceptable, the additional testing and concrete coring and grouting will be at the expense of the Contractor.
6. If discontinuities are found, an independent structural and/or geotechnical consultant hired by the Contractor will perform structural and/or geotechnical evaluation at the expense of the Contractor. Use consultants who are prequalified by KYTC in applicable areas. Alternatively, the Engineer may require the Department's designer to perform the referenced evaluations and the Department may require the cost of these evaluations to be borne by the Contractor. Based on the design criteria established for the structure and the evaluation, the Engineer will assess the effects of the defects on the structural performance of the drilled shaft. If the results of the analyses indicate that there is conclusive evidence that the discontinuity will result in inadequate or unsafe performance under the design loads, as defined by the design criteria for the structure, the Engineer will reject the shaft.
7. If any shaft is rejected, provide a plan for remedial action to the Department for approval. Any modifications to the foundation shafts and/or other substructure elements caused by the remedial action will require calculations and working drawings by consultant(s) hired by the Contractor (or the Department's designer), at the expense of the Contractor, which will be subject to review by the Department. Begin remediation operations only after receiving approval from the Engineer for the proposed remediation. All remedial action will be at no cost to the Department and with no extension of contract time.

Livingston County Item No. 1-1142.0
 US 60 over Cumberland River

2.4.5. Evaluation Criteria

The Department will generally use the criteria below for evaluation of the shafts but may vary the criteria based on other available information (e.g. TIP results, construction records, etc.)

Satisfactory	Good (G)	FAT increase 0 to 10%
Anomaly	Questionable (Q)	FAT increase 11 to 20%
Flaw	Poor/Flaw (P/F)	FAT increase 21 to 30%
Defect	Poor/Defect (P/D)	FAT increase >31%
<p>The Department will consider energy reductions in conjunction with FAT increases and reserves the right to vary the anomaly, flaw and defect criteria based on energy reductions.</p>		

- Flaws must be addressed if they affect more than 50% of the profiles.
- Defects must be addressed if they affect more than one profile (i.e. the result of complete investigation from bottom to top between two tubes) at the same depth.
- “Addressing” a Flaw or Defect may include an evaluation by tomography if the concern is localized (e.g. not across the full section), and/or, depending on the depth to the concern, additional measures like core drilling, repair or replacement, repeat tests after a longer waiting time or testing by other methods (gamma-gamma, low strain, high strain).
- Flaws or Defects covering the entire cross section define a full layer concern requiring repair.
- Anomalies will require evaluation and may need to be addressed based on the results of the evaluation.

Continue with placement of reinforcement and concrete above the top of shaft only after receiving written approval from the Engineer to do so, based on evaluation of the CSL and other applicable test results.

Livingston County Item No. 1-1142.0
US 60 over Cumberland River

3.0 Thermal Integrity Profiling

3.1 Description

Thermal Integrity Profiling (TIP) will be used as part of the program to test the integrity of drilled shafts. The Contractor will be responsible for supplying all equipment and materials necessary to perform this testing, and obtaining the services of a TIP Testing Firm, experienced with TIP testing and approved by the Engineer, to perform the testing using embedded thermal sensors in accordance with ASTM D7949 (Method B).

Installation of sensors/instrumentation to the reinforcing cage is incidental to the applicable contract unit bid price for Drilled Shaft, Common or Drilled Shaft, Solid Rock. Ensuring that the TIP instrumentation is operational and provides the required information is the responsibility of the TIP Testing Firm. Overseeing the installation of the TIP testing instrumentation and properly training the Contractor in the installation of the TIP testing instrumentation is the responsibility of the TIP Testing Firm and is incidental to applicable unit bid price for TIP Testing.

The Contractor will be responsible for providing:

1. suitable working space and access to every shaft;
2. other equipment, materials, or assistance necessary to accomplish the testing.

3.2 Materials

Provide materials in accordance with ASTM D7949 (Method B).

3.3 Execution

3.3.1 Cloud Enabled Data Collection

The TIP testing firm is encouraged but not required to use a Cloud Enabled Data Collection system to collect and transmit the TIP data. The use of such a system would allow the testing firm to monitor data in real time and notify the Contractor of apparent problems with the data and/or shaft integrity. This would reduce the potential for data being lost in shipment of data boxes. Additionally, it could potentially make the contractor aware of problems in time to make adjustments to construction procedures for subsequent shafts. The use of this technology could also result in faster submittal of TIP test reports and potentially result in shafts being accepted sooner.

Livingston County Item No. 1-1142.0
US 60 over Cumberland River

3.3.2 Training of Contractor Personnel

A TIP Testing Firm representative meeting the specified experience requirements will be required to be on site during installation of instrumentation, the shaft pour, and at least through the first 24 hours of data collection for the first shaft constructed. (This does not mean that it is necessary for the representative to be on site continuously during the first 24 hours of data collection after completion of concrete placement. However, the representative must visit the site to ensure that the instrumentation is functional and properly acquiring data 24 hours after completion of concrete placement before departing the project vicinity.) If the testing firm uses Cloud Enabled Data Collection the Department will consider waiving the requirement for the representative to remain in the project vicinity during the first 24 hours of data collection. Unsatisfactory performance by Contractor personnel may result in the Engineer requiring the TIP Testing Firm representative to be on site for additional shafts. Additionally, this representative will be required to train applicable Contractor supervisory and/or engineering personnel with regard to instrumentation installation, data collection, and other applicable tasks as deemed necessary by the Tip Testing Firm and/or the Engineer. Department personnel may also participate in this training at the discretion of the Engineer. Submit written documentation prepared by the Tip Testing Firm representative which documents the training and includes the names of all personnel who have been trained. If the Contractor's personnel changes it will be necessary for the representative to train new personnel.

3.3.3 Embedded Thermal Sensor Installation

Install embedded thermal sensor cable in accordance with ASTM D7949 (Method B), the manufacturer's recommendations, and procedures outlined by the TIP Testing Firm representative at plan view access locations which are approximately evenly-spaced and as shown below:

- Pier 3 8 embedded thermal sensor access locations per shaft
- Pier 4 8 embedded thermal sensor access locations per shaft

Attach the embedded thermal sensor cables to the longitudinal reinforcement of the shaft in accordance with procedures outlined by the TIP Testing Firm representative. Securely attach the cables to the reinforcement at a location on the reinforcement that is 90° to the line connecting the reinforcement to the center of the shaft approximately halfway between nodes, working from the bottom of the cage to the top before tightening cable ties. Attach each cable to a recording apparatus securely suspended (on a protruding rebar, casing, template, etc.) well above the top of the concrete. If the cable is routed with a bend at any location, take extra precautions on securing the cable on either side of each such node. If reinforcement cage splicing is necessary, take extra precautions to ensure that the sensor cables are properly spliced.

Livingston County Item No. 1-1142.0
US 60 over Cumberland River

3.4 TIP Testing and Evaluation of Test Results

Make submittals in accordance with the Project requirements for submittals. See Table 3 below.

Table 3 – Schedule of TIP Submittals			
Submittal Number	Submittal Item	Deadline	Event
1	Technical Proposal with TIP Testing Firm qualifications	45 business days before	Start of Drilled Shaft Construction
2	TIP Testing Reports	5 business days after	Completion of testing on an individual drilled shaft

Provide all submittals and reports in .pdf format

3.4.1 Technical Proposal (Including Example Report)

Submit a technical proposal prepared by the TIP Testing Firm that addresses the testing procedures and required qualifications and experience of the testing firm. It is acceptable for the TIP and CSL Testing Firm to be the same firm, provided they meet requirements for both TIP (this Section) and CSL (Section 2.4.1) Testing Firms. Include sufficient documentation to show that the firm and the person overseeing the work on this project meet the requirement of having TIP testing, data interpretation and reporting experience on at least three (3) similar deep foundation projects, including at least one (1) project involving embedded thermal sensors in accordance with ASTM D7949 (Method B).

The Department will allow substitution as defined below for one of the three referenced projects:

- documented participation in the development of ASTM Standard Test Method D7949-14 and/or documented participation in applicable research, OR
- experience on at least two (2) similar projects using other forms of deep foundation integrity testing (e.g. Crosshole Sonic Logging, Sonic Echo, Impulse Response, Gamma-Gamma, etc.). If used, integrity testing experience on other projects must be different projects than used to satisfy the actual TIP Testing project experience.

The Department will not waive the requirement for experience on at least one (1) project involving TIP testing using embedded thermal sensors in accordance with ASTM D7949 (Method B).

With the technical proposal, include an example TIP test report prepared in accordance with the reporting requirements below. Include any costs associated with the example report in the applicable unit bid prices for TIP testing. If deviations from the specified reporting requirements are noted during review, the Department may (depending on the extent of the deviations) elect to require the testing to confirm that they can meet the requirements in production test reports

Livingston County Item No. 1-1142.0
US 60 over Cumberland River

rather than resubmit the example report. The purposes of this report are for the TIP testing firm to demonstrate their understanding of the reporting requirements and capability to meet them and to ensure that Department personnel are familiar with and understand the testing firm's reporting format and style. The ultimate objective of this requirement is to facilitate timely reviews of production test reports and reduce the potential for delays in shaft acceptance. Failure to submit an acceptable example report may result in disqualification of the testing firm.

Include a proposed protocol to perform confirmatory TIP testing [such as using a thermal probe in accordance with ASTM D7949 (Method A)] in the event that thermal sensor damage/defects (to the extent that a complete analysis of the shaft cannot be performed using the data from the embedded thermal sensors) are detected after concrete placement has been completed. Such testing would be at no additional cost to the Department.

3.4.2 Testing

1. Provide access to the top of the shaft for testing personnel and equipment.
2. Perform TIP testing in accordance with generally accepted TIP testing methods and in accordance with ASTM D7949.
3. Perform TIP testing on all completed shafts, unless directed otherwise by the Engineer. As a minimum, obtain data in 15 minute increments for a duration of 48 hours after completion of concrete placement or three (3) hours after the peak average shaft temperature has been reached, whichever is longer. The Department will consider reducing the 48 hour minimum for subsequent shafts at a given pier location if the Contractor submits a written request prepared by the TIP testing consultant with adequate justification for doing so.
4. Perform TIP testing using the embedded thermal sensor array, and in accordance with the ASTM Test Method D7949 (Method B).
5. Immediately report potential local discontinuities indicated by locally low temperatures relative to the average temperature at that depth, or average temperatures significantly lower than the average temperatures at other depths to the Department.
6. If thermal sensor damage/defects (to the extent that a complete analysis of the shaft cannot be performed using the data from the embedded thermal sensors) are detected after concrete placement has been completed, perform any confirmatory TIP testing as proposed according to Section 3.4.1 of this Special Note and accepted by the Department. Perform this testing at no additional cost to the Department. At the request of the Department, propose corrective methods to prevent repetitive occurrences of such damage/defects.

3.4.3 Test Reports

1. Submit a test report prepared by the TIP Testing Firm within five (5) business days of completion of testing which, as a minimum, contains:
 - a. Date of test;
 - b. Plan Shaft No. and Reference Elevation (i.e. zero depth elevation);

Livingston County Item No. 1-1142.0
US 60 over Cumberland River

- c. Schematic showing a plan view of the embedded thermal sensor cable locations;
 - d. The overall average temperature plotted as a function of time over the entire data collection period, with a clear indication of the selected time of peak temperature. The "overall average temperature" averages all embedded thermal sensor cables and the entire length of the shaft (resulting in only one temperature value plotted at any given time). This temperature is proportional to the average radius computed from the actual total concrete volume installed (assuming a consistent concrete mix throughout). Radius at any point can then be evaluated from the temperature at that point compared to the overall average temperature;
 - e. Graphical displays of temperature measurements (including each individual cable and the average of the cables) versus depth at 12, 24, 36, and 48 hours after completion of concrete placement, and at least one plot within the last six (6) hours of the data collection period. Upon request, provide these graphical displays at other times;
 - f. At both the time associated with peak temperature and one-half the time to peak temperature, provide graphical displays of temperature (including each individual cable and the average of the cables) vs. depth, radius vs. depth, 3-D interpretations of temperature and radius, and at least one shaft slice at representative depths corresponding to water, overburden and rock socket, as applicable. Upon request, provide any of these graphical figures at other times and/or depths at no additional cost to the Department;
 - g. Indication of unusual temperatures, particularly significantly cooler local deviations of the average at any depth from the overall average over the entire length;
 - h. Variations in temperature between sensors (at each depth) which may correspond to variations in cage alignment (where concrete volume is known, the cage alignment or offset from center should be noted);
 - i. Where shaft specific construction information is available (e.g. elevations of the top of shaft, bottom of casing, bottom of shaft, etc.), these values should be noted on all pertinent graphical displays;
 - j. Drilled shaft radius calculations and the shaft quality, based upon the collected data, as well other available data, such as, as shaft alignment and wall profile from the SC Testing, top/bottom shaft/concrete elevations and concrete volume records collected during construction of the drilled shaft; and
 - k. A narrative portion of the report which addresses items a through j above.
2. When drastic changes in boundary conditions exist (air to water, water to soil, varying soil strata, varying temperatures in the water column, etc.) a single temperature to radius relationship may not accurately estimate the shaft radius. In such cases, apply algorithms in the software to account for these changes in boundary conditions, normalize temperatures, and remove fluctuations not caused by changes in cross section.
 3. Plot data to a scale that will allow adequate evaluation of data variations. The Department reserves the right to request scale adjustments.
 4. Complete all reports using English units.

Livingston County Item No. 1-1142.0
US 60 over Cumberland River

3.4.4 Evaluation of TIP Test Results

1. Allow direct communication between the TIP Testing Firm and the Department. If the TIP Testing Firm is different than other testing firms on the project, allow direct contact between the TIP and other testing firms
2. The Department will review the TIP test results in the test report to evaluate whether or not the drilled shaft integrity is acceptable. Within 10 business days after receiving a test report, the Engineer will report to the Contractor whether the construction is acceptable or additional more detailed analyses are needed. The Department will also use the results of other non-destructive and materials testing, construction records, etc. to evaluate the condition of the shafts.
3. Continue with construction of the structure above the drilled shafts only after receiving written approval from the Engineer to do so, based on evaluation of the TIP and CSL test results and other applicable test results, construction records, etc.
4. If the TIP and/or CSL records are inconclusive (e.g. records do not clearly indicate discontinuity, good conditions or missing data), the Department may require additional testing, such as CSL retesting, Angled CSL, Crosshole Tomography Analysis or concrete cores to sample the concrete in question to verify shaft conditions. After completing report reviews, the Department will discuss options for additional testing with the Contractor and/or testing firm(s) and/or complete evaluation of all test results prior to directing the Contractor to obtain concrete cores. The Department will not pay for additional testing performed at the discretion of the Contractor or testing firm that is not directed and/or agreed upon by the Department. If core samples are needed, obtain cores with a minimum diameter of 2 inches, double tube core barrel at a minimum of four locations specified by the Department, unless directed otherwise by the Engineer. Unless directed otherwise by the Engineer, locate core holes approximately 6 inches inside the reinforcement such that they do not damage the reinforcement. For each core hole drilled, record a log with descriptions of inclusions and voids in the cored holes and submit a copy of the log to the Engineer. Place the cores in crates properly marked showing the shaft depth at each interval of core recovery. Transport the cores and logs to the Geotechnical Branch in Frankfort for inspection and testing unless directed otherwise by the Engineer. Grout the core holes in accordance with Section 2.3.2 above.
5. If the additional testing or evaluation of cores indicate that concrete for any drilled shaft on which additional testing or coring was required is acceptable, the Department will pay for the direct cost of additional testing and concrete coring and grouting by change order. If the additional testing or if evaluation of cores indicate that the concrete for any drilled shaft concrete is unacceptable, the additional testing and concrete coring and grouting will be at the expense of the Contractor.
6. If discontinuities are found, an independent structural and/or geotechnical consultant hired by the Contractor may be required to perform structural and/or geotechnical evaluation at the expense of the Contractor. Use consultants who are prequalified by KYTC in applicable areas. Alternatively, the Engineer may require the Department's designer to perform the referenced evaluations and the cost of these evaluations may be borne by the Contractor. Based on the design criteria established for the

Livingston County Item No. 1-1142.0
US 60 over Cumberland River

- structure and the evaluation, the Department will assess the effects of the defects on the structural performance of the drilled shaft. If the results of the analyses indicate that there is conclusive evidence that the discontinuity will result in inadequate or unsafe performance under the design loads, as defined by the design criteria for the structure, the Engineer will reject the shaft.
7. If any shaft is rejected, provide a plan for remedial action to the Department for approval. Any modifications to the foundation shafts and/or other substructure elements caused by the remedial action will require calculations and working drawings by independent consultant(s) hired by the Contractor, at the expense of the Contractor. The calculations and working drawings will be reviewed by the Engineer and/or the Department's designer. Begin remediation operations only after receiving acceptance from the Engineer for the proposed remediation. All remedial action will be at no cost to the Department and with no extension of contract time.

Continue with placement of reinforcement and concrete above the top of shaft only after receiving written approval from the Engineer to do so, based on evaluation of the TIP and other applicable test results.

Livingston County Item No. 1-1142.0
US 60 over Cumberland River

4.0 Measurement and Payment

4.1 Method of Measurement Sonar Calipering

The Department will pay for the authorized and accepted quantities of "Sonar Calipering" at the contract unit price per test for production shafts and dry run tests. This will constitute full compensation for all costs associated with providing access for testing personnel and equipment, performing the SC Testing, and reporting the results to the Engineer. Payment for the SC Testing will be at the contract unit price per SC Test. Payment for each test required by the Engineer will be the same regardless of whether the testing is performed after casing installation and overburden excavation or after rock excavation. Any additional testing required to verify verticality after casing adjustments (to meet specified verticality tolerances) will be at the expense of the Contractor. The Department will pay 50% of the unit price upon successful completion of the required testing and the remainder upon final acceptance of all required reports.

4.2 Method of Measurement CSL Testing

The Department will pay for the authorized and accepted quantities of "CSL Testing" at the contract unit price per each shaft tested. This will constitute full compensation for all costs associated with providing access for testing personnel and equipment, performing the CSL Testing in a single shaft, and reporting the results to the Engineer. The Department will pay 50% of the unit price upon successful completion of the required testing and the remainder upon final acceptance of all required reports.

Installation of CSL Access Tubing is incidental to the applicable contract unit bid price for Drilled Shaft, Common, and Drilled Shaft, Solid Rock. This will constitute all costs and delays associated with installing the CSL Access Tubing in a single shaft, including but not limited to providing and installing access tubing, providing and installing all required bracing for access tubes, providing and placing grout in access tubes.

The Department will pay for the direct cost of additional testing and concrete coring, authorized by the Engineer, required to investigate shafts with inconclusive CSL records if evaluation of the additional testing or cores indicates that concrete for that drilled shaft is acceptable using a change order. This will constitute full compensation for all costs and delays associated with performing additional tests, obtaining and delivering concrete cores to the Geotechnical Branch, and grouting core holes.

Livingston County Item No. 1-1142.0
US 60 over Cumberland River

4.3 Method of Measurement TIP Testing

The Department will pay for the authorized and accepted quantities of "TIP Testing" at the contract unit price per each shaft tested. This will constitute full compensation for all costs associated with providing access for testing personnel and equipment, performing the TIP Testing in a single shaft, and reporting the results to the Engineer. The Department will pay 50% of the unit price upon successful completion of the required testing and the remainder upon final acceptance of all required reports.

Installation of embedded thermal sensors is incidental to the applicable contract unit bid price for Drilled Shaft, Common, and Drilled Shaft, Solid Rock. This will constitute all costs and delays associated with installing the embedded thermal sensors.

The Department will pay for the cost of additional testing and concrete coring, authorized by the Engineer, required to investigate shafts with complex or inconclusive TIP records if evaluation of the additional testing or cores indicates that concrete for that drilled shaft is acceptable using a change order. This will constitute full compensation for all costs and delays associated with performing additional tests, obtaining and delivering concrete cores to the Geotechnical Branch.

4.4 Payment

The Department will pay for the completed and accepted quantities under the following. The Pay Unit of "Each" refers to each individual test.

Code	Pay Item	Pay Unit
24741EC	Sonar Caliper Testing - Pier 3	Each
24741EC	Sonar Caliper Testing - Pier 4	Each
24875EC	CSL Testing (8 tubes) - Pier 3	Each
24875EC	CSL Testing (8 tubes) - Pier 4	Each
24874EC	TIP Testing - Pier 3	Each
24874EC	TIP Testing - Pier 4	Each

The Department will consider payment as full compensation for all work required herein.

SPECIAL NOTE FOR PILE DYNAMIC TESTING

Livingston County – US 60 Bridge over the Cumberland River Item No. 1-1142.0

1.0 GENERAL

1.1 Scope of Work The scope of work includes furnishing all labor, equipment and analyses associated with dynamic testing of driven piles as specified in this Special Note and in general accordance with ASTM D 4945, “High-Strain Dynamic Testing of Piles”. Dynamic testing involves attaching at least two strain transducers and two accelerometers to the pile near the pile head during initial driving. A cable or wireless transmission connects the sensors near the pile head with the Pile Driving Monitoring Hardware located a safe distance from the pile, but not more than 330 ft from the pile. The piles that are to be tested must be of sufficient extra length to ensure that sensors are not driven into the ground.

Dynamic pile testing generally applies only to the designated test piles at Piers 5 – 9 (open-ended pipe piles). However, the Engineer reserves the right to require dynamic pile testing on production piles at Piers 5 – 9 and any piles at Pier 2 and Abutment 2 (H-piles) if questions arise regarding the resistance or integrity of those piles.

The Department reserves the right to increase or decrease the quantity of dynamic pile tests and/or require dynamic pile testing on production piles if deemed necessary by the Engineer. Restrike testing is not required unless directed otherwise by the Engineer. If requested, the Department will pay for restrike tests at the unit bid price for Dynamic Pile Testing.

At Piers 5 – 9 the Contractor may drive any pile to a tip elevation of 217 ft. at any time prior to hammer acceptance, performance of dynamic testing or acceptance of dynamic pile test reports. If it appears that bedrock has been encountered at a higher elevation stop driving immediately until driving criteria for refusal on bedrock have been provided.

1.2 Personnel Qualifications Perform dynamic pile testing utilizing the services of an independent Dynamic Pile Testing Consultant with qualified personnel as described below.

- Pile Driving Field Monitoring - An engineer with a minimum of 3 years of dynamic pile testing and analysis experience or who has achieved Basic or better certification under the High-Strain Dynamic Pile Testing Examination and Certification process of the Pile Driving Contractors Association or Foundation QA.
- Wave Equation Analyses, Signal Matching Analyses and Report Responsibility - A licensed professional engineer with a minimum of 5 years of dynamic pile testing and analysis experience or who has achieved Advanced or better certification under the High-Strain Dynamic Pile Testing Examination and Certification process of the Pile Driving Contractors Association or Foundation QA.

Livingston County Item No. 1-1142.0
 US 60 over Cumberland River

1.3 Equipment Supply equipment such as sensors, cables or wireless transmitters, etc. conforming to ASTM D 4945, “High-Strain Dynamic Testing of Piles” and furnished by the dynamic testing consultant. Prior to beginning work, submit the product name and manufacturer of the hardware and software components below for acceptance by the Engineer. If requested by the Engineer, submit additional information including technical specifications, etc.

- Pile Driving Modeling - Wave Equation Software
- Pile Driving Monitoring - Hardware & Software
- Pile Driving Analysis - Signal Matching Software

To prepare the pile for sensor attachment, provide a drill (and bit) of sufficient power, operated by either a DC battery (preferred) or a generator.

1.4 Submittals and General Testing & Analysis Requirements See Tables 1 and 2 herein. The Engineer will respond to the Contractor regarding acceptability of Submittals 1 – 3 within 10 business days and Submittal 4 reports within three (3) business days. A “Business Day” is defined as any day except Saturdays, Sundays and Holidays, as defined in Section 101.03 of the Standard Specifications.

Table 1 - Schedule of Dynamic Pile Testing Submittals			
Submittal Number	Submittal Item	Calendar Days	Event
1	Proposed independent dynamic pile testing consultant, and a listing of assigned personnel and their experience and qualifications.	45 Before	Start of Pile Driving Monitoring
2	Details of the hardware and software components, method of testing, and materials to be used.	45 Before	Start of Pile Driving Monitoring
3	Completed <i>Pile and Driving Equipment Data Form</i> (Figure 1 of this Special Note) and the results of wave equations analyses.	21 Before	Start of Pile Driving Monitoring
4	Reports as defined in Section 3.0 of this Special Note.	48 HOURS After	Completion of Each Field Test
Provide all submittals and reports in .pdf format.			

Livingston County Item No. 1-1142.0
 US 60 over Cumberland River

Table 2 - General Testing and Analysis Requirements	
Item	Requirement
Wave Equation Analysis	Minimum of 1 and sufficient additional analyses as needed to define performance for all combinations of piles, driving systems and subsurface conditions anticipated.
Dynamic Testing Pile Resistance (i.e. Capacity)	Required Nominal Pile Resistance (i.e. Ultimate Pile Capacity) as shown in this special note and/or as directed by the Engineer.
Pile Driving Analyses using Signal Matching Techniques and Refined Wave Equation Analyses	For each Test
<p>Perform testing and analyses in accordance with this table and ASTM D 4945, “<i>High-Strain Dynamic Testing of Piles</i>”.</p>	

Livingston County Item No. 1-1142.0
US 60 over Cumberland River

2.0 TESTING AND ANALYSES

The primary objectives of this testing related to the open-ended piles are to:

- ensure that a properly-sized hammer is used to seat the piles into bedrock and verify the required nominal pile resistances
- evaluate the potential for excessive driving stresses and/or pile damage

The goal is to evaluate whether the Case I practical refusal criteria in Section 604.03.07 (C) of the 2019 Standard Specifications (Table 3 below) are applicable to the open-ended pipe piles for the required nominal resistances in Table 4 below and if not to develop modified criteria.

Table 3 - Case I Practical Refusal Criteria (from Section 604.03.07 (C) of the 2019 Standard Specifications)		
Case	Rock Type	Maximum Set
I	Hard Bedrock	¼ inch in 5 consecutive blows ¼ inch for 5 additional consecutive blows

Table 4 - Required Nominal Toe Resistance Values				
Pier	Required Nominal Toe Resistance (tons)	Required Nominal Toe Resistance (kips)	Stress at Factored Design Load (ksi)	Percentage of Yield Stress
5	697	1394	20 ksi	44%
6	806	1612	23 ksi	51%
7	883	1766	26 ksi	58%
8	811.5	1623	24 ksi	53%
9	771.5	1543	22 ksi	49%

- The Preconstruction Wave Equation Analyses and initial testing will require the highest nominal resistance (1766 kips). Details are included below.
- The required nominal resistance values are based on factored extreme event earthquake loads with a load factor of 1.0 and include post seismic event down drag. As a result, side resistance must be neglected and only toe resistance may be considered.
- Stress values are based on a cross sectional area of 69 inch² and a yield stress of 45 ksi.

Livingston County Item No. 1-1142.0
US 60 over Cumberland River

2.1 Preconstruction Wave Equation Analyses At least 21 calendar days before beginning pile driving monitoring submit to the Engineer the completed Pile and Driving Equipment Data Form (Figure 1 of this Special Note) and preconstruction wave equation analyses performed by the Dynamic Pile Testing Consultant in accordance with Table 2 herein and a summary report of the results. The required nominal resistance (i.e. ultimate capacity) is provided in the plans and/or elsewhere in the contract documents. Upon request, the Geotechnical Report for the structure can be provided.

Perform Preconstruction Wave Equation Analyses using the highest required nominal resistance (1766 kips) in Table 4 above. First evaluate the Case I practical refusal criteria from Section 604.03.07 (C) of the 2019 Standard Specifications (Table 3 herein). If the analyses show that acceptable results are anticipated, provide the anticipated acceptable range of hammer strokes. If the analyses show that acceptable results are not achieved using the practical refusal criteria, revise the analyses to obtain the driving criteria required to achieve acceptable results for a nominal resistance (i.e. ultimate capacity) of 1766 kips. However, in all cases submit the analyses associated with the Case I practical refusal for the Department's information.

The purpose of the wave equation analyses is to assess the ability of all proposed pile driving systems to install piles to the required nominal resistance (i.e. ultimate capacity) and the desired penetration depth within allowable driving stresses. Acceptability of the wave equation report and the adequacy of analyses will be determined by the Engineer. In the Wave Equation Summary Report, include:

- a. drivability graph relating pile resistance (i.e. capacity), blow count and driving stresses to depth;
- b. bearing graph relating the pile resistance (i.e. capacity) to the pile driving resistance which indicates blow count versus resistance (i.e. capacity) and stroke; and
- c. constant resistance (i.e. capacity) analysis or inspectors chart to assist the Engineer in determining the required driving resistance at other field-observed strokes.

2.1.1 Acceptance by the Engineer of the proposed pile driving system will be based upon the wave equation analyses indicating that the proposed system can develop the specified pile resistance (i.e. capacity) at a pile driving rate of 20 blows per inch (240 blows/ft.) at the end of driving and driving stresses of at least 55% of yield stress but not greater than 90% of yield stress at the end of driving. The contractor may propose to modify the blow count and/or driving stress criteria if it appears that it is impractical to meet them. Provide preliminary pile driving criteria based on wave equation analyses and any anticipated resistance (i.e. capacity) changes after driving, set-up or relaxation, subject to revision based upon dynamic pile testing field measurements.

2.1.2 If any changes or modifications are made to the accepted pile driving system, additional wave equation analyses in accordance with Section 2.1 of this Special Note will be required.

2.2 High-Strain Dynamic Pile Testing

Regardless of pier location use a target nominal resistance of 1766 kips during the driving of the first test pile. For subsequent test piles use the required nominal resistance in Table 3 herein unless directed otherwise by the Engineer.

Livingston County Item No. 1-1142.0
US 60 over Cumberland River

2.2.1 Perform dynamic pile testing at the locations and frequency required in accordance with Table 2 in this Special Note.

2.2.2 Dynamic pile testing involves monitoring the response of a pile subjected to heavy impact applied by the pile hammer at the pile head. The testing will provide information on the driving stresses, pile resistance (i.e. capacity), structural integrity, and hammer efficiency.

2.2.3 Engage an independent dynamic pile testing consultant and qualified personnel in accordance with Section 1.2 of this Special Note. Prior to testing, the Engineer will review and accept the proposed independent dynamic pile testing consultant, the experience and qualifications of assigned personnel, details of the method of testing, a list of equipment, and the method of analysis of test results.

2.2.4 Perform all field testing and measurements in the presence of the Engineer or authorized representative.

2.2.5 **Remote Dynamic Pile Testing** where data is collected in the field and sent to the office of the Dynamic Pile Testing Consultant **will not be allowed** on this project. The testing consultant is required to have at least one person meeting the requirements for "Pile Driving Monitoring" as defined in Section 1.2 of the Special Note for Dynamic Pile Testing in the field during all dynamic pile testing. However, "wireless" technology that eliminates cables from the test pile to the data acquisition equipment will be allowed.

2.3 Field Testing

2.3.1 Equipment Perform dynamic pile testing field measurements using equipment, software and recording equipment accepted in accordance with Section 1.3 of this Special Note. Analyze the data collected at the end of initial driving using accepted signal matching techniques and software.

2.3.2 Monitoring During Driving During pile driving, instrument the piles and monitor them with testing equipment satisfying the requirements of Section 2.0 of this Special Note. Prior to lifting the pile to be dynamically tested, provide a minimum of 3 ft. of clear access to 180 degree opposite faces of the pile for pile preparation then drill and prepare holes for sensor attachment. Sensors are usually attached near the pile top.

2.3.2.1 Install two sets of strain transducers and accelerometers near the top of each pile to be tested, and use a compatible measuring and recording system to record the data during driving.

2.3.2.2 Appropriately position and fix the equipment required to be attached to the pile to the satisfaction of the Engineer.

2.3.2.3 Use a pile driving hammer and other equipment capable of delivering an impact force sufficient to mobilize the specified pile resistance (i.e. capacity) indicated in the structure plans without damaging the pile.

Livingston County Item No. 1-1142.0
US 60 over Cumberland River

2.3.2.4 Use the testing equipment to monitor pile stresses during driving to prevent pile damage and ensure pile integrity and resistance (i.e. capacity). If the testing equipment indicates overstressing or damage to the pile, immediately discontinue driving and notify the Engineer and propose a new pile driving system, modifications to existing system, or new pile installation procedures. Acceptance by the Engineer of any proposed changes to the pile driving system or pile installation procedures will be based upon the results of additional wave equation analyses in accordance with Section 2.1 of this Special Note.

2.3.3 Preparation of the Pile Head The preparation of the pile head for the application of dynamic test load may involve, where appropriate, trimming the head, cleaning, and building up the pile using materials that, at the time of testing, safely withstand the impact stresses. Provide an impact surface that is flat and at right angles to the pile axis.

2.3.4 Dynamic Measurement and Analysis Begin monitoring of pile driving when the pile tip is approximately 5 feet above the anticipated bedrock elevation. Record and process the data immediately in the field by the pile driving monitoring equipment and software. Unless monitoring indicates that additional driving will damage the pile, continue pile driving and monitoring until both the specified pile tip elevation and the specified pile resistance (i.e. capacity) are reached. When the level of the sensors is within 1 foot of any obstruction endangering the survival of sensors or cables, halt driving to remove the sensors from the pile. If additional driving is required, remove the obstruction or splice the pile and reattach the sensors to the head of the next pile segment prior to resuming driving. For each pile tested, perform pile driving analysis using signal matching techniques for a selected blow at the end of driving (EOD) to determine the relative capacities from end bearing and skin friction along the pile.

Make any required adjustments to the fuel and/or power setting of the hammer if necessary to verify the resistance at a pile driving rate of 20 blows per inch (240 blows/ft.) at the end of driving and driving stresses of at least 55% of the yield stress but not greater than 90% of yield stress at the end of driving or to meet other applicable testing objectives. The contractor may propose to modify the blow count and/or driving stress criteria if it appears that it is impractical to meet them and/or if pile damage is occurring or it appears that there is the potential for pile damage to occur.

2.3.4.1 The Engineer may request use of pile driving monitoring equipment and software on additional piles if inconclusive results are obtained or unusual driving conditions are encountered.

2.3.4.2 Evaluate pile resistance and integrity based on industry standards.

Livingston County Item No. 1-1142.0
US 60 over Cumberland River

3.0 DYNAMIC PILE TEST REPORTS

Within 24 hours after the completion of testing, submit test report for each pile tested for review by the Engineer. In the reports, include tabular as well as graphical presentation of the dynamic test results versus depth and proposed pile driving criteria for the additional piles to be installed at the substructure unit of the pile tested. Also include the following:

- a. Identification of the structure, including: County, Route, Crossing, and Drawing Number.
- b. Date of testing and date of pile installation.
- c. Pile identification number and location.
- d. All information given in preliminary reports as follows:
 1. Length of pile below the surface.
 2. Total length of pile, including projection above the surface at time of test.
 3. Length of pile from instrumentation position to tip.
- e. The maximum force applied to the pile head.
- f. The maximum energy imparted to the pile.
- g. The assumed soil damping factor and wave speed.
- h. Static resistance (i.e. capacity) estimate.
- i. The maximum compressive and tensile forces in the pile.
- j. Pile integrity.
- k. Blows per inch.
- l. Stroke
- m. Hammer type, drop, and other relevant details.
- n. Blow(s) selected for signal matching analysis.
- o. Maximum compressive and tensile stresses, stroke, and resistance (i.e. capacity) versus penetration depth.
- p. Pile integrity and location of damage, if any.
- q. Force/velocity versus time trace.
- r. Force/velocity match curve.
- s. Resistance distribution along the pile.
- t. Detailed graphical and tabular results from up to three selected blows analyzed using signal matching techniques and software.
- u. Results of refined wave equation analyses based upon dynamic testing signal matching analysis. Include tabular and graphical inspector's charts at EOD for the required pile resistance values for each specific substructure and any additional information that may be needed by field inspectors.

If possible, use the above-referenced practical refusal criteria and provide the required range of hammer strokes. If changes to the practical refusal criteria are required use the same driving criteria for all piers if possible.

The Engineer will use the results of the preliminary reports to provide pile driving criteria for production piles to the Contractor.

Livingston County Item No. 1-1142.0
US 60 over Cumberland River

4.0 INCIDENTAL EQUIPMENT

Prior to the beginning of dynamic testing, provide one electronic device to aid in recording pile hammer blows, stroke, and energy such as an "E-Saximeter" or accepted equivalent meeting the specifications in the Appendix to this Special Note. This device will immediately become property of the Department for use by project inspectors. The Contractor and Dynamic Pile Testing Consultant are advised to agree upon who will purchase the device.

Provide field training by someone proficient in the use of the device to ensure that approximately 3 to 5 employees of the Department are competent in the use of the device. This training may be performed by a representative of the independent Dynamic Pile Testing Consultant who is proficient in the use of the device or a manufacturer's representative. The required training time is anticipated to be no more than one day.

The cost of furnishing this device and providing the training is incidental to the contract price for "Dynamic Pile Testing" and no separate payment will be made.

5.0 METHOD OF MEASUREMENT AND BASIS OF PAYMENT

Dynamic pile testing will be measured per each. Payment for each test will include pile driving monitoring and pile driving analysis performed. Payment for the above described work, including all material, equipment, tools, labor and any other incidental work necessary to complete this item.

The Department will make payment under:

Code	Pay Item	Pay Unit
23233EC	Dynamic Pile Testing	Each

The Department will consider payment as full compensation for all work required herein.

Contract No.: _____		Structure Name and/or No.: _____	
Project: _____		Pile Driving Contractor or Subcontractor: _____	
County: _____		(Piles driven by)	

Hammer Components

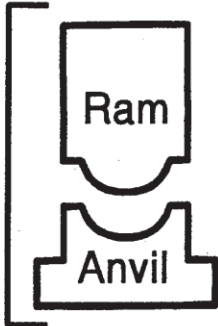

Hammer

Manufacturer: _____ Model No.: _____
 Hammer Type: _____ Serial No.: _____
 Manufacturers Maximum Rated Energy: _____ (ft. - lb.)
 Stroke at Maximum Rated Energy: _____ (ft.)
 Range in Operating Energy: _____ to _____ (ft. - lb.)
 Range in Operating Stroke: _____ to _____ (ft.)
 Ram Weight: _____ (lb.)
 Modifications: _____

Striker Plate

Weight: _____ (lb.) Diameter: _____ (in.)
 Thickness: _____ (in.)

Material #1 _____ Material #2 _____
 (for Composite Cushion)

Name: _____ Name: _____
 Area: _____ (in.²) Area: _____ (in.²)
 Thickness/Plate: _____ (in.) Thickness/Plate: _____ (in.)
 No. of Plates: _____ No. of Plates: _____
 Total Thickness of Hammer Cushion: _____

Helmet (Drive Head)

Weight: _____ (lb.)

Pile Cushion

Material: _____
 Area: _____ (in.²) Thickness/Sheet: _____ (in.)
 No. of Sheets: _____
 Total Thickness of Pile Cushion: _____ (in.)

Pile

Pile Type: _____
 Wall Thickness: _____ (in.) Taper: _____
 Cross Sectional Area: _____ (in.²) Weight/Foot : _____
 Ordered Length: _____ (ft.)
 Design Load: _____ (kips)
 Ultimate Pile Capacity: _____ (kips)

Description of Splice: _____

Driving Shoe/Closure Plate Description: _____

Submitted By: _____ Date: _____
 Telephone No.: _____ Fax No.: _____

Figure 1
Pile and Driving Equipment Data Form (From FHWA-HI-097-014)

Livingston County Item No. 1-1142.0
US 60 over Cumberland River

Appendix

Physical:

Size: 100mm X 190mm X 50mm (4 inches X 7.5 inches X 2 inches)
Weight: 0.7 kg (1.5 lb.)
Temperature range: -10 to 50°C (14 to 104°F) operating
Power: built-in rechargeable battery w/ 8 hour min duration
Display: LCD, 4 Lines x 16 characters, viewing area 62 mm by 26 mm (2.5 inches
by 1 inch)
Keypad: Large key (1.27 mm²), non tactile

Electronic:

32 bit microcontroller up to 20.97 MHz
12 bit digital to analog converter 8 bit 4 channel analog to digital converter
Internal microphone 70 to 115 dB
RS232 connector for data transfer
4 MB internal memory

Functional and Other:

Maximum blow detection rate: 68 bpm for open end diesel hammers; 300 bpm for all others
Furnished with SAXLINK program for data transfer in text format
Operates in English or SI units
Full one year warranty
Technical manual included

SPECIAL NOTE FOR INSTRUMENTATION ON EXISTING BRIDGE

Livingston County – US 60 Bridge over the Cumberland River Item No. 1-1142.0

The content of this special note is the same as was included in Addendum # 1 of CID-20-1015, except for removal of annotation regarding changes made in Addendum # 1.

Construction activities (including but not limited to pile driving, drilled shaft construction, blasting, excavation, or operation of other heavy construction equipment) which could potentially damage the existing bridge will be required during bridge construction activities. The Contractor is advised that the existing bridge structure is located close to the proposed work and that construction activities are to be conducted so as to preclude damage to the existing bridge. Any damage caused by construction activities on this contract is the responsibility of the Contractor. The instrumentation program will begin when foundation construction activities at proposed Piers 2 - 9 are started and conclude when traffic is moved to the new bridge.

1.0 DESCRIPTION

This work consists of furnishing all instrumentation, tools, materials, and labor necessary to install and monitor bridge instrumentation and perform surveys of the pre-foundation construction and post-foundation construction (proposed Piers 2 – 9) condition of the existing Cumberland River Bridge located adjacent to the new bridge, and performing tiltmeter and crackmeter monitoring during the construction activities as specified in this Special Note to evaluate whether construction activities are impacting the existing bridge piers. Provide access and traffic control as required for personnel to conduct the condition surveys and instrumentation work. Schedule and coordinate activities that will impact traffic with the Engineer in accordance with project protocols including required advance notifications to the traveling public. Instrument and monitor the piers on the existing Cumberland River Bridge identified in Table 1 below.

Table 1 – Schedule of Piers on Existing Bridge to be Instrumented	
Pier	Primary Reason(s) for Instrumenting
SP3	Location of an emergency bearing retrofit performed in 2019
SP1	Location of bearing retrofit to be performed as part of this project Location of scour repair project performed in 2013
A	Main truss pier founded on spread footings
B	Main truss pier founded on spread footings Issues with rotation soon after construction forcing a retrofit
NP1	Location of bearing retrofit to be performed Issues with rotation soon after construction forcing a retrofit
NP2	Founded on soil bearing footing
NP5	Location of bearing retrofit to be performed as part of this project
NP7	Location with a noted rocking of the bearings

Livingston County Item No. 1-1142.0
US 60 over Cumberland River

Establish specific recommended monitoring locations in the Pre-Construction Condition Survey and Instrumentation Plan. During the course of construction, the Contractor and/or its consultant(s) will be responsible for taking tiltmeter and crackmeter readings and providing website access of data to Department personnel. Any monitoring data that indicates excessive structure deflections, the potential for unstable conditions, or damage to adjacent facilities, as determined by the Engineer, is cause for preventative measures to be taken in the affected area until the causes are identified and resolved to the satisfaction of the Engineer. Provide equipment for tiltmeter and crackmeter monitoring as outlined in Section 6 below.

Carry out the monitoring program in two phases as indicated below:

- Phase 1 - foundation construction activities at Piers 2 – 9. Depending on the project schedule, the Contractor may propose to break Phase 1 into Phases 1a and 1b to separate foundation construction on each side of the river.
- Phase 2 - remainder of construction until traffic is moved to the new bridge

2.0 PERSONNEL QUALIFICATIONS

Perform the services described below using the services of qualified personnel assigned to this project as described below. Personnel who meet the requirements for both descriptions below may perform the duties of both positions. Note that at least two people are required for both positions described below.

2.1 Pre-Construction and Post-Foundation Construction Surveys

Use licensed Professional Engineers to conduct pre-construction and post-foundation construction condition surveys who meet the requirements below.

- Documented completion of at least one of the instructor-led National Highway Institute (NHI) courses below within the last five (5) years:
 - FHWA-NHI-130053 - “Bridge Inspection Refresher Training”
 - FHWA-NHI-130053A - “Bridge Inspection Refresher Training”
 - FHWA-NHI-130055 - “Safety Inspection of In-Service Bridges”
 - FHWA-NHI-130056 - “Safety Inspection of In-Service Bridges for Professional Engineers”
- At least three (3) years of experience conducting pre- and/or post-construction condition surveys on structures and/or conventional bridge maintenance inspections
- Experience on a minimum of three (3) projects which include structural pre- and/or post-construction condition surveys and/or conventional bridge maintenance inspections

Include one primary person and at least one backup who meets the same requirements.

Livingston County Item No. 1-1142.0
US 60 over Cumberland River

2.2 Tiltmeter Instrumentation Installation and Monitoring

Use qualified Instrumentation Engineer or Specialists who are licensed Professional Engineers and meet the requirements below to supervise the Contractor's tiltmeter monitoring program.

- At least three (3) years of experience in the installation and use of instrumentation to monitor deformations of structures and/or slopes
- Experience on a minimum of three (3) projects using tiltmeters to monitor deformations of structures

Include one primary person and at least one backup who meets the same requirements.

3.0 SUBMITTALS AND REPORTS

Make submittals in accordance with applicable Project requirements for submittals. See Table 2 for a list and schedule of required Submittals and Reports. The Department will respond to the Contractor regarding acceptability of Submittals and Reports within 10 business days. A "Business Day" is defined as any day except Saturdays, Sundays and Holidays, as defined in Section 101.03 of the Standard Specifications.

Livingston County Item No. 1-1142.0
US 60 over Cumberland River

Table 2 – Schedule of Submittals and Reports

Submittal Number	Submittal Item	Deadline (Calendar Days)	Event
1	Proposed personnel as defined in Section 2.0. Also include a listing of other assigned personnel and their experience and qualifications.	30 After	Notice to Begin Work
2	Pre-Construction Condition Survey Report as defined in Section 4.0 of this Special Note	60 Before	Anticipated Start of Foundation Construction (Prop. Piers 2 - 9)
3	Instrumentation Monitoring Plan	7 After	Submittal of Pre-Construction Condition Survey Report
4	Tiltmeter and Crackmeter Monitoring Monthly* Reports as defined in Section 7. * The frequency may be reduced to bi-monthly during Phase 2.	30 After	Start of Foundation Construction (Prop. Piers 2 - 9)
5	Post-Foundation Construction Condition Survey Report as defined in Section 4.0 of this Special Note	30 After	Completion of Foundation Construction (Prop. Piers 2 - 9)
6	Phase 1 Instrumentation Monitoring Summary Report	15 After	Completion of Foundation Construction (Prop. Piers 2 - 9)
7	Phase 2 Instrumentation Monitoring Summary Report	15 After	Traffic is Moved to New Bridge

Provide all submittals and reports in .pdf format

4.0 CONDITION SURVEYS

Conduct Pre-Construction and Post-Foundation Installation (proposed Piers 2 - 9) Condition Surveys on the piers identified in Table 1 prior to the commencement and after the completion of foundation construction activities at the referenced piers. Include documentation of the substructure and bearings. Detail (by engineering sketches, video, photographs, and/or notes) any existing structural or cosmetic damage.

Submit Pre-Construction and Post-Foundation (proposed Piers 2 - 9) Condition Survey reports for the piers identified in Table 1 that summarizes the pre- and post-construction conditions of the referenced pier substructures and identifies areas of concern, including potential personnel hazards (falling debris) and structural elements that may require support or repair such as, but not limited to, existing visible cracks. Submit full reports in digital form condensed to a .pdf file. If higher resolution photographs or other records resulting in larger file sizes are required for detail, submit higher resolution versions CD, USB-drive media or internet uploads.

Livingston County Item No. 1-1142.0
US 60 over Cumberland River

5.0 INSTRUMENTATION MONITORING PLAN

Based on observations from the Pre-Construction Condition Survey, submit a written Instrumentation Monitoring Plan to the Engineer, which includes, but is not necessarily limited to the following:

- planned monitoring activities
- proposed monitoring equipment with supporting documentation that it meets the requirements specified in Section 6 below
- proposed specific locations of tiltmeters and crackmeters including drawings, sketches, photographs, etc.
- discussion of anticipated effects of temperature on monitoring data including possible methods to reduce notifications that may occur as the result of thermal expansion and contraction.
- examples of format for reporting the data via electronically-submitted written reports and a website accessible to Department and Contractor personnel
- proposed communications protocols with Contractor and Department personnel for the levels defined below
- tilt values (degrees) associated with deformations at the top of the piers identified in Table 1 as defined below

Level	Deformation at Top of Pier (Longitudinal and Transverse)
Alert	0.125 inch (1/8")
Threshold	0.188 inch (3/16")
Limiting	0.250 inch (1/4")

- proposed crack gage criteria for alert, threshold and limiting criteria based on the pre-construction condition survey

Livingston County Item No. 1-1142.0
US 60 over Cumberland River

6.0 EQUIPMENT AND INSTALLATION

All instrumentation equipment including associated ancillaries referenced in Sections 6.1 and 6.2 below will immediately become property of the Department after use on this project.

6.1 Tiltmeters

Provide and install new instrumentation designed, fabricated, and assembled in proper operating condition and in full conformity with the manufacturer's requirements and this Special Note. Furnish items complete with all components specified herein, all accessories required for proper operation, and all additional materials required by the design of the system.

Provide new tiltmeter monitoring equipment with an instrumentation system expressly designed for the purpose of measuring tilt on structural elements that meets the following requirements:

- tiltmeters capable of measuring both longitudinal and transverse tilt as well as temperature
- tiltmeters with a range of up to +/-10 degrees from the vertical, with a minimum resolution of approximately 0.001 degrees in a temperature range of 0 to 150 degrees Fahrenheit
- includes data loggers, cabling, solar panels to recharge the data logger batteries, a cellular modem and is capable of:
 - capturing, storing and downloading time-stamped tiltmeter readings in retrievable memory
 - collecting, storing and transmitting data via cellular modem
 - uploading data in real time to a website accessible by Department and Contractor personnel and available for "near real time" review at any time

Install tiltmeters with data loggers and solar panels in accordance with the manufacturer's specifications, one set each on the west side of the piers identified in Table 1 of the existing bridge on or near the pier caps. In all cases, provide equipment conforming to the requirements herein.

Position the transverse axis of each tiltmeter so that a tilt to the west (toward the new bridge alignment) is in the "positive" direction. Similarly, position the longitudinal axis of each tiltmeter so that tilt to the north (toward End Bent 2) is in the "positive" direction. Set the tiltmeter data loggers to send alerts when the change in tilt exceeds the value associated with the levels defined in Section 5.0 above. Send alerts to applicable personnel according to agreed-upon protocols.

Install the tiltmeters on Piers SP3, SP1 and A of the existing bridge a minimum of 30 calendar days prior to beginning foundation construction activities at proposed Piers 2 & 3. Install the tiltmeters on Piers B, NP1, NP2, NP5 and NP7 of the existing bridge a minimum of 30 calendar days prior to beginning foundation construction activities at proposed Piers 4 - 9. On each side of the river, perform any trouble shooting so that a minimum of 21 days of baseline data is obtained prior to the beginning of foundation construction.

Livingston County Item No. 1-1142.0
US 60 over Cumberland River

6.2 Crackmeters

Provide and install remote sensing crack displacement monitoring gages on the piers identified in Table 1 of the existing bridge across any significant existing cracks as defined by the Pre-Construction Condition Survey Engineer to help verify any additional structure distress if it should develop. The location, number, and type of gages will be established by the Contractor and the Department based on the pre-construction condition survey. Provide a minimum of three (3) crackmeters per pier monitored (average). If more than an average of three (3) crackmeters per pier monitored are deemed necessary, proposed and agreed upon by the Engineer, the Department will compensate the Contractor for the additional crackmeters via change order. An average of less than three (3) crackmeters per pier monitored may result in a deduction.

Provide new crackmeter instrumentation such as Durham Geo Slope Indicator (DGSi) VW, GEOKON VW Model 4420 or approved comparable devices that are designed, fabricated, and assembled in proper operating condition and in full conformity with the manufacturer's requirements and this Special Note. Furnish items complete with all components specified herein, all accessories required for proper operation, and all additional materials required by the design of the system.

Install the crackmeters a minimum of 30 calendar days prior to beginning proposed Piers 2 - 9 foundation construction activities and perform any trouble shooting so that a minimum of 21 days of baseline data is obtained prior to the beginning of foundation construction at proposed Piers 2 – 9.

7.0 MONITORING AND REPORTING

If requested by the Engineer, provide a minimum of one day of in-person on-site training (by the Instrumentation Specialist) to the Department's and Contractor's personnel in the use of the instrumentation system including all ancillary equipment and accessing data from the website. Coordinate the scheduling of this training with the Engineer.

Protect all instrumentation until it is removed and ensure that the system is functioning at all times. If the system is found not to be functioning take applicable action to ensure the capability to obtain data is restored as soon as possible. Replace or restore any defective or damaged instrumentation at no expense to the Department. Coordinate and cooperate as necessary with the Engineer.

7.1 Tiltmeters

Set each data logger to record tiltmeter readings on nominal 15-minute intervals. At night and/or when cloudy weather prevents solar recharging, the units may be switched to low power mode to collect data on nominal one-hour intervals. Provide an information guide relative to accessing the website to review the tiltmeter data.

Livingston County Item No. 1-1142.0
 US 60 over Cumberland River

Submit monthly reports including plots of tilt (in degrees) and corresponding deformations (inches) at the top of the pier in both the longitudinal, transverse directions and temperature vs. time and a log of construction activities prepared by the Contractor for the monthly period. Additionally, include separate plots of the same parameters for the cumulative time since installation. Include a brief summary with explanations of data anomalies, significant construction activities or other events and any other observations. In the first monthly report include photographs of the installed tiltmeters and verification that the tiltmeters were installed according to the accepted Instrumentation Monitoring Plan or explanations for any deviations.

As provided in Section 5.0 above, the Department has established the criteria below. The Department reserves the right to modify the deformation values based on baseline readings and/or field observations, bridge inspections, etc. If the criteria are modified provide tilt values (degrees) associated with the modified deformations.

Level	Deformation at Top of Pier (Either Longitudinal or Transverse)
Alert	0.125 inch (1/8")
Threshold	0.188 inch (3/16")
Limiting	0.250 inch (1/4")

If the Alert level is reached perform the actions below unless modifications are agreed upon by the Department.

1. Review the data to see if the value seems reasonable or if there may be an explanation for the observed tilt.
2. Notify the Engineer and other applicable Department personnel.

If a Threshold Value is reached, perform the actions below unless modifications are agreed upon by the Department.

1. Review the data to see if the value seems reasonable or if there may be an explanation for the observed tilt.
2. Notify the Engineer and other applicable Department personnel (The Section Engineer will notify the District Bridge Maintenance Engineer to request an inspection.)
3. Meet with the Section Engineer and District Bridge Maintenance Engineer to discuss the need for response action(s).
4. If directed by the Engineer, implement response action(s) within 24 hours of submitting a detailed specific plan of action to reduce the potential for exceeding the Limiting Value.

If a Limiting Value is reached, perform the actions below unless modifications are agreed upon by the Department.

1. Suspend construction activities in the affected area.
2. Immediately notify the Engineer and other applicable Department personnel and close the bridge to traffic, unless directed otherwise by the Engineer. (The Section Engineer will notify the District Bridge Maintenance Engineer to request an immediate inspection.)

Livingston County Item No. 1-1142.0
US 60 over Cumberland River

3. Review the data to see if the value seems reasonable or if there may be an explanation for the observed tilt.
4. Meet with the Section Engineer and District Bridge Maintenance Engineer to discuss the need for response action(s).
5. If directed by the Engineer, implement response action(s) within 24 hours of submitting a detailed specific plan of action as required to re-open the bridge.

Notifications are not required prior to the commencement of foundation construction activities when baseline readings are being obtained.

7.2 Crackmeters

Remotely monitor the crackmeters and provide an information guide relative to accessing the website to review the tiltmeter data. Notify the Department of any significant movement detected by the crackmeters according to the criteria in the accepted instrumentation monitoring plan. Based on the proposed and accepted criteria for alert, threshold and limiting values, perform the actions described for tiltmeters in Section 7.1 unless modifications are agreed upon by the Department.

Submit monthly reports which include plots of remote crackmeter data and documentation of the crack widths. Include these reports with the monthly tiltmeter report submittals. Additionally, include separate plots of the same parameters for the cumulative time since installation. Include a brief summary with explanations of data anomalies, significant construction activities or other events and any other observations. In the first monthly report include photographs of the installed crackmeters and verification that the crackmeters were installed according to the accepted Instrumentation Monitoring Plan or explanations for any deviations.

7.3 Summary Reports

Submit Phase 1 and Phase 2 Monitoring Summary Reports which summarizes the data collected in each phase. As a minimum include the following sections: Introduction, Tiltmeter and Crackmeter Monitoring Description, Findings, General Comments and Appendix that includes installation records including drawings/sketches, photographs, plots, equipment manufacturer's specifications.

Interpret the data collected, including making correlations between tiltmeter data and specific construction activities. Evaluate the data to determine whether the measured deformations can be reasonably attributed to construction activities. Include these evaluations in the final report.

Include all tiltmeter and crack gage records such as daily event logs and associated construction activity data in the final report, submitted to the Engineer, in a format allowed by the Engineer. Submit a full report in digital form condensed to a .pdf file. If higher resolution photographs or other records resulting in larger file sizes are required for detail, submit higher

Livingston County Item No. 1-1142.0
 US 60 over Cumberland River

resolution versions using a CD, USB-drive media, or uploaded to an online site accessible by applicable Department personnel.

8.0 INSTRUMENTATION REMOVAL

Upon completion of tiltmeter monitoring and prior to demolition remove the instrumentation systems and all ancillary equipment under the direction of the Instrumentation Specialist. Exercise caution so that all equipment remains in working order for the Department’s use on subsequent projects. The Department will immediately take custody of these items.

9.0 METHOD OF MEASUREMENT

Payment for instrumenting the existing bridge is for all work and equipment described in this special note including but not necessarily limited to furnishing and installing instrumentation, condition surveys, monitoring, and providing access and traffic control as required to install, monitor and remove the instrumentation. The Department will make partial payments according to the schedule below.

SCHEDULE OF LUMP SUM PARTIAL PAYMENTS	
Milestone	Cumulative %
Acceptance of Pre-Foundation Construction (proposed Piers 2 – 9) Condition Survey Report & Instrumentation Monitoring Plan	15
Installation of Tiltmeters & Crackmeters with Confirmation that all Instrumentation is Functional	*
Completion of Phase 1 Monitoring & Acceptance of all Monthly Reports	*
Acceptance of Post-Foundation Construction (proposed Piers 2 – 9) Condition Survey Report	*
Acceptance of Phase 1 Instrumentation Monitoring Summary Report	*
Completion of Phase 2 Monitoring Program and Acceptance of all Bi-Monthly Reports	95
Acceptance of Phase 2 Instrumentation Monitoring Summary Report & Transfer of Entire Instrumentation System to the Department	100
* Cumulative percentages will be based on documentation of expenditures.	

10.0 PAYMENT

The Department will pay for the completed and accepted work under the following:

Code	Pay Item	Pay Unit
20610NC	Instrumentation	Lump Sum

The Department will consider payment as full compensation for all work required herein.

SECTION 312000 - EARTH MOVING

PART 1 - GENERAL

1.1 SUMMARY

- A. Section Includes:
 - 1. Excavating and backfilling for utility trenches.

1.2 DEFINITIONS

- A. Backfill: Soil material used to fill an excavation.
 - 1. Initial Backfill: Backfill placed beside and over pipe in a trench, including haunches to support sides of pipe.
 - 2. Final Backfill: Backfill placed over initial backfill to fill a trench.
- B. Excavation: Removal of material encountered above subgrade elevations and to lines and dimensions indicated.
 - 1. Authorized Additional Excavation: Excavation below subgrade elevations or beyond indicated lines and dimensions as directed by Architect. Authorized additional excavation and replacement material will be paid for according to Contract provisions for changes in the Work.
 - 2. Unauthorized Excavation: Excavation below subgrade elevations or beyond indicated lines and dimensions without direction by Architect. Unauthorized excavation, as well as remedial work directed by Architect, shall be without additional compensation.
- C. Utilities: On-site underground pipes, conduits, ducts, and cables, as well as underground services within buildings.

1.3 QUALITY ASSURANCE

- A. Pre-excavation Conference: Conduct conference at Project site.

1.4 PROJECT CONDITIONS

- A. Utility Locator Service: Notify utility locator service for area where Project is located before beginning earth moving operations.

PART 2 - PRODUCTS

2.1 SOIL MATERIALS

- A. General: Provide borrow soil materials when sufficient satisfactory soil materials are not available from excavations.
- B. Satisfactory Soils: Soil Classification Groups GC, SC, CL, ML, GW, GP, GM, SW, SP, and SM according to ASTM D 2487, or a combination of these groups; free of rock or gravel larger than 3 inches in any dimension, debris, waste, frozen materials, vegetation, and other deleterious matter.
 - 1. Plasticity Index: 30 (beneath Structures and Pavements).
 - 2. Minimum Unit Weight: 100 lbs/cubic foot
- C. Unsatisfactory Soils: Soil Classification Groups OL, CH, MH, OH, and PT according to ASTM D 2487, or a combination of these groups.
 - 1. Unsatisfactory soils also include satisfactory soils not maintained within 3 percent of optimum moisture content at time of compaction.
- D. Bedding Course: Naturally or artificially graded mixture of natural or crushed gravel, crushed stone, and natural or crushed sand; ASTM D 2940; except with 100 percent passing a 1-inch sieve and not more than 8 percent passing a No. 200 sieve.

PART 3 - EXECUTION

3.1 PREPARATION

- A. Protect structures, utilities, sidewalks, pavements, and other facilities from damage caused by settlement, lateral movement, undermining, washout, and other hazards created by earth moving operations.
- B. Protect and maintain erosion and sedimentation controls during earth moving operations.
- C. Protect subgrades and foundation soils from freezing temperatures and frost. Remove temporary protection before placing subsequent materials.

3.2 EXCAVATION, GENERAL

- A. Unclassified Excavation: Excavate to subgrade elevations regardless of the character of surface and subsurface conditions encountered. Unclassified excavated materials may include rock, soil materials, and obstructions. No changes in the Contract Sum or the Contract Time will be authorized for rock excavation or removal of obstructions.
 - 1. If excavated materials intended for fill and backfill include unsatisfactory soil materials and rock, replace with satisfactory soil materials.

3.3 EXCAVATION FOR UTILITY TRENCHES

- A. Excavate trenches to indicated gradients, lines, depths, and elevations.
- B. Excavate trenches to uniform widths to provide the following clearance on each side of pipe or conduit. Excavate trench walls vertically from trench bottom to 12 inches higher than top of pipe or conduit unless otherwise indicated.
 - 1. Clearance: 8 inches each side of pipe or conduit.
- C. Trench Bottoms: Excavate and shape trench bottoms to provide uniform bearing and support of pipes and conduit. Shape subgrade to provide continuous support for bells, joints, and barrels of pipes and for joints, fittings, and bodies of conduits. Remove projecting stones and sharp objects along trench subgrade.
 - 1. Excavate trenches 6 inches deeper than elevation required in rock or other unyielding bearing material, 4 inches deeper elsewhere, to allow for bedding course.
- D. Trenches in Tree- and Plant-Protection Zones:
 - 1. Hand-excavate to indicated lines, cross sections, elevations, and subgrades. Use narrow-tine spading forks to comb soil and expose roots. Do not break, tear, or chop exposed roots. Do not use mechanical equipment that rips, tears, or pulls roots.
 - 2. Do not cut main lateral roots or taproots; cut only smaller roots that interfere with installation of utilities.
 - 3. Cut and protect roots according to requirements in Section 015639 "Temporary Tree and Plant Protection."

3.4 UNAUTHORIZED EXCAVATION

- A. Fill unauthorized excavation under foundations or wall footings by extending bottom elevation of concrete foundation or footing to excavation bottom, without altering top elevation. Lean concrete fill, with 28-day compressive strength of 2500 psi, may be used when approved by Architect.
 - 1. Fill unauthorized excavations under other construction, pipe, or conduit as directed by Architect.

3.5 STORAGE OF SOIL MATERIALS

- A. Stockpile borrow soil materials and excavated satisfactory soil materials without intermixing. Place, grade, and shape stockpiles to drain surface water. Cover to prevent windblown dust.
 - 1. Stockpile soil materials away from edge of excavations. Do not store within drip line of remaining trees.

3.6 UTILITY TRENCH BACKFILL

- A. Place backfill on subgrades free of mud, frost, snow, or ice.
- B. Place and compact bedding course on trench bottoms and where indicated. Shape bedding course to provide continuous support for bells, joints, and barrels of pipes and for joints, fittings, and bodies of conduits.
- C. Trenches under Footings: Backfill trenches excavated under footings and within 18 inches of bottom of footings with satisfactory soil; fill with concrete to elevation of bottom of footings.
- D. Trenches under Roadways: Provide 4-inch- thick, concrete-base slab support for piping or conduit less than 30 inches below surface of roadways. After installing and testing, completely encase piping or conduit in a minimum of 4 inches of concrete before backfilling or placing roadway subbase course.
- E. Place and compact initial backfill of subbase material, free of particles larger than 1 inch in any dimension, to a height of 12 inches over the pipe or conduit.
 - 1. Carefully compact initial backfill under pipe haunches and compact evenly up on both sides and along the full length of piping or conduit to avoid damage or displacement of piping or conduit. Coordinate backfilling with utilities testing.
- F. Place and compact final backfill of satisfactory soil to final subgrade elevation.
- G. Install warning tape directly above utilities, 12 inches below finished grade, except 6 inches below subgrade under pavements and slabs.

3.7 SOIL FILL

- A. Plow, scarify, bench, or break up sloped surfaces steeper than 1 vertical to 4 horizontal so fill material will bond with existing material.
- B. Place and compact fill material in layers to required elevations as follows:
 - 1. Under grass and planted areas, use satisfactory soil material.
 - 2. Under walks and pavements, use satisfactory soil material.
 - 3. Under steps and ramps, use satisfactory soil material or engineered fill.
 - 4. Under building slabs, use satisfactory soil material or engineered fill.
 - 5. Under footings and foundations, use engineered fill.

3.8 SOIL MOISTURE CONTROL

- A. Uniformly moisten or aerate subgrade and each subsequent fill or backfill soil layer before compaction to within 3 percent of optimum moisture content.
 - 1. Do not place backfill or fill soil material on surfaces that are muddy, frozen, or contain frost or ice.

2. Remove and replace, or scarify and air dry, otherwise satisfactory soil material that exceeds optimum moisture content by 3 percent and is too wet to compact to specified dry unit weight.

3.9 COMPACTION OF SOIL BACKFILLS AND FILLS

- A. Place backfill and fill soil materials in layers not more than 8 inches in loose depth for material compacted by heavy compaction equipment, and not more than 4 inches in loose depth for material compacted by hand-operated tampers.
- B. Place backfill and fill soil materials evenly on all sides of structures to required elevations, and uniformly along the full length of each structure.
- C. Compact soil materials to not less than the following percentages of maximum dry unit weight according to ASTM D 698:
 1. Under structures, building slabs, steps, and pavements, scarify and recompact top 12 inches of existing subgrade and each layer of backfill or fill soil material at 98 percent.
 2. Under walkways, scarify and recompact top 6 inches below subgrade and compact each layer of backfill or fill soil material at 5 percent.
 3. Under turf or unpaved areas, scarify and recompact top 6 inches below subgrade and compact each layer of backfill or fill soil material at 92 percent.
 4. For utility trenches, compact each layer of initial and final backfill soil material at 92 percent.

3.10 GRADING

- A. General: Uniformly grade areas to a smooth surface, free of irregular surface changes. Comply with compaction requirements and grade to cross sections, lines, and elevations indicated.
- B. Site Rough Grading: Slope grades to direct water away from buildings and to prevent ponding. Finish subgrades to required elevations within the following tolerances:
 1. Turf or Unpaved Areas: Plus or minus 1 inch.
 2. Walks: Plus or minus 1 inch.
 3. Pavements: Plus or minus 1/2 inch.

3.11 FIELD QUALITY CONTROL

- A. Testing Agency: Owner will engage a qualified geotechnical engineering testing agency to perform tests and inspections.
- B. Allow testing agency to inspect and test subgrades and each fill or backfill layer. Proceed with subsequent earth moving only after test results for previously completed work comply with requirements.

- C. Footing Subgrade: At footing subgrades, at least one test of each soil stratum will be performed to verify design bearing capacities. Subsequent verification and approval of other footing subgrades may be based on a visual comparison of subgrade with tested subgrade when approved by Architect.
- D. When testing agency reports that subgrades, fills, or backfills have not achieved degree of compaction specified, scarify and moisten or aerate, or remove and replace soil materials to depth required; recompact and retest until specified compaction is obtained.
- E. Density testing shall be performed at a rate of at least one test per 10,000 square feet per lift and with a minimum of 3 tests per lift.

3.12 PROTECTION

- A. Protecting Graded Areas: Protect newly graded areas from traffic, freezing, and erosion. Keep free of trash and debris.
- B. Repair and reestablish grades to specified tolerances where completed or partially completed surfaces become eroded, rutted, settled, or where they lose compaction due to subsequent construction operations or weather conditions.
- C. Where settling occurs before Project correction period elapses, remove finished surfacing, backfill with additional soil material, compact, and reconstruct surfacing.
 - 1. Restore appearance, quality, and condition of finished surfacing to match adjacent work, and eliminate evidence of restoration to greatest extent possible.

3.13 DISPOSAL OF SURPLUS AND WASTE MATERIALS

- A. Remove surplus satisfactory soil and waste materials, including unsatisfactory soil, trash, and debris, and legally dispose of them off Owner's property.

END OF SECTION 312000

SECTION 331113- MUNICIPAL WATER DISTRIBUTION

PART 1 - GENERAL

1.1 SUMMARY

- A. This Section includes water-distribution piping and related components for water distribution piping to be turned over to municipal water district or company for public water supply.

1.2 SUBMITTALS

- A. Product Data: For each type of product indicated.
- B. Shop Drawings: Detail precast concrete vault assemblies and indicate dimensions, method of field assembly, and components.
- C. Field quality-control test reports.
- D. Operation and maintenance data.

1.3 QUALITY ASSURANCE

- A. Regulatory Requirements:
 - 1. Comply with requirements of utility company supplying water. Include tapping of water mains and backflow prevention.
 - 2. Comply with standards of authorities having jurisdiction for potable-water-service piping, including materials, installation, testing, and disinfection.
 - 3. Comply with standards of authorities having jurisdiction for fire-suppression water-service piping, including materials, hose threads, installation, and testing.
- B. Piping materials shall bear label, stamp, or other markings of specified testing agency.
- C. Comply with ASTM F 645 for selection, design, and installation of thermoplastic water piping.
- D. NSF Compliance:
 - 1. Comply with NSF 61 for materials for water-service piping and specialties for domestic water.

1.4 PROJECT CONDITIONS

- A. Interruption of Existing Water-Distribution Service: Do not interrupt service to facilities occupied by Owner or others unless permitted under the following conditions and then

only after arranging to provide temporary water-distribution service according to requirements indicated:

1. Notify Engineer and Distribution Owner no fewer than two days in advance of proposed interruption of service.
2. Do not proceed with interruption of water-distribution service without Engineer and Distribution Owner written permission.

1.5 COORDINATION

Coordinate connection to water main with utility company Provide fees for main line taps, distribution system owner shall make all taps to existing mains.

PART 2 - PRODUCTS

2.1 PIPE AND FITTINGS

A. Ductile Iron Pipe Class 51 and Pressure Class 350

All ductile iron pipe shall be designed in accordance with AWWA/ANSI C151/A21.51. Ductile iron pipe class 51 shall be manufactured with thickness, diameter, and weight in accordance with AWWA C151, Table 3 and Table 4. All ductile iron pipe shall have a rating of not less than 300 psi. Ductile iron pipe exterior surface shall have an asphaltic coating, minimum thickness of 1 mil., in accordance with AWWA C151. Ductile iron pipe shall be cement lined in accordance with AWWA/ANSI C104/A21.4. Cement lining shall be standard thickness with a thickness tolerance of plus 1.8 inch. The pressure rating, metal thickness class, net weight of pipe without lining of pipe, and name of manufacturer shall be clearly marked on each length of pipe. Joints shall be Fastite, Bell-Tite, or Tyton as specified. Where restrained joint is specified, it shall be Tyton joint pipe with Tyton-Loc gasket by U.S. Pipe & Foundry Company, Inc., or approved equal. All joints, 4 inch through 12 inch, shall be adaptable for locking gaskets. All ductile iron pipe shall be manufactured in the United States unless otherwise approved by PW.

- B. Plastic Pipe and Fittings: Plastic pipe shall be rigid unplasticized polyvinyl chloride (PVC) conforming to the requirements of ASTM D 1784 and ASTM D 2241. Pipe shall have a minimum standard dimension ratio (SDR) of 21 and a pressure rating of 200 complying with ASTM D2241. The PVC compound used in the manufacture of this pipe shall meet or exceed the requirements for class 12454-A or 12454-B as defined by ASTM D1784. Plastic pipe joint shall be of the push-on type with a continuous elastomeric ring gasket compressed into the annular space between bell and spigot end of pipe complying with ASTM D 3139. All piping shall be SDR 21 PVC 200 psi rating.

D. Fittings

1. Fittings for PVC and ductile iron water mains shall be ductile iron fittings in accordance with AWWA C110-77 (ANSI A21.10) and shall conform to the details and dimensions shown therein. Fittings shall have mechanical joints meeting the requirements of AWWA C111-80 (ANSI A21.11). Fittings shall have interior cement-mortar lining as specified for the pipe.
2. Plugs, where required, shall be ductile iron mechanical joint dished or flat plugs in accordance with AWWA C110-77. Joints for plugs shall be restrained with the use of ductile iron mechanical joint retainer glands.

2.2 VALVES

A. Gate Valves

1. All gate valves shall be of the resilient seat type, iron body, non-rising stem, fully bronze mounted and suitable for water working pressures of 200 psi. Valves shall be of standard manufacturer and of the highest quality both as to materials and workmanship.
2. All gate valves shall be furnished with mechanical joint and connections, unless otherwise shown on the Drawings or specified hereinafter.
3. All gate valves shall have the name or monogram of the manufacturer, the year the valve casting was made, the size of the valve, and the working water pressure cast on the body of the valve.
4. Each gate valve shall be installed in a vertical position with a valve box. Gate valves set with valve boxes shall be provided with a 2-inch square operating nut and shall be opened by turning to the left (counter-clockwise).
5. All valves shall conform with the latest revision of "AWWA Standard for Gate Valves - 3 inch through 48 inch - For Water and Other Liquids", AWWA C509. Valves shall be as manufactured by Mueller, M & H, American Valve and Hydrant, U.S. Pipe, Kennedy or equal.

B. Tapping Valves

Tapping valves shall be iron body and iron rubber encapsulated, with an iron gate. They shall be AWWA resilient seated gate valves, conforming to AWWA Standard C509 and be UL listed - FM approved. They shall have a non-rising bronze stem with two (2) inch square wrench nut and "O" ring packing. The inside and outside of the body and bonnet shall be coated with an epoxy coating to meet the AWWA C550 Standard. The internal design shall provide for the passing of full size cutters and tapping machine bits. The valve connection shall be Class 125, flanged for tapping sleeve, opening left. They shall have a mechanical joint for branch pipe connection,

complete with bolts, nuts, and gaskets. Tapping valves shall be Mueller valve, or approved equal.

C. Stainless Steel Tapping Sleeves

This specification covers tapping sleeves of all stainless steel construction. All metal parts of the tapping sleeve shall be of 304 stainless steel, and the gaskets shall be of virgin SBR rubber compound for water service. The gasket shall have a full circumferential seal. The shell and neck of the sleeve shall be of 304 stainless steel. The neck shall be mig welded to the shell to form a strong permanent fusion with the shell. The welded areas then shall be fully passivated. Passivation shall mean the weld areas of the sleeve shall be chemically treated and the residue removed so as to return the welded stainless steel to its original state and produce a highly corrosion resistant coating. The sleeve shall have heavy hex nuts, and the bolts shall be rolled national course thread of 304 stainless steel and shall be Teflon coated. It shall have a plastic lubricating washer. The armors shall be heavy gauge 304 stainless steel with a lip curve to hold position while tightening. The flange shall be 304 stainless steel with standard square head for pressure testing before tapping pipe. The tapping sleeve shall be of the SST style as manufactured by Romac Industries, Inc., or approved equal.

D. Valve Boxes

Valve boxes shall be constructed of cast iron in two-piece sections with heavy duty lids. Valve boxes shall be of the screw type, adjustable, and with a five and one-quarter (5 ¼) inch shaft. The lengths of the boxes shall be specified in the Bidder's Proposal. Valve boxes shall be as manufactured by the Tyler/Union Corporation or approved equal.

2.3 HYDRANTS

A. Fire Hydrants

1. The Contractor shall furnish and install fire hydrants where shown on the Drawings. Hydrants shall conform in all respects to the requirements of AWWA C502-80. Hydrant barrel shall have safety breakage feature above the ground line. All hydrants shall have 6-inch mechanical joint shoe connection, two (2) 2-1/2-inch discharge nozzles and one (1) 5-1/4 inch pumper nozzle with caps fitted with cap chains. Connection threads shall conform to local standards. Main valve shall have 5-1/4-inch full opening and be of the compression type opening against water pressure so that valve remains should barrel be broken off.
2. Hydrants shall be fully bronze mounted. Main valve shall have a threaded bronze seat ring assembly of such design that it is easily removable by unscrewing from a threaded bronze drain ring. Bronze drain ring shall have multiple ports providing positive automatic drainage as the main valve is opened or closed. Drainage waterways shall be completely bronze to prevent rust and corrosion.

3. Operating stem shall be equipped with anti-friction thrust bearing to reduce operating torque and assure easy opening. Stop shall be provided to limit stem travel. Stem threads shall be enclosed in a permanently sealed lubricant reservoir protected from weather and the waterway with O-ring seals.
4. Hydrants shall be designed for 250 psi working pressure and shop tested to 300 psi pressure with main valve both opened and closed. Under test the valve shall not leak, the automatic drain shall function and there shall be no leakage into the bonnet.
5. Hydrants shall be set plumb with not less than two (2) cubic feet of crushed stone and backed with at least one (1) cubic foot of Class "C" concrete or equivalent. Set hydrants so that centerline of pumper nozzle is minimum 18 inches above finished grade. An operating wrench and traffic damage repair kit shall be provided with every 15 hydrants. Provide one (1) set where quantity of hydrants is less than 15.
6. Hydrants shall be M&H model 129 Fire Hydrant – 3 way, 5-1/4" AWWA with National Hydrant threads, 3.5' minimum bury length, open left or approved equal.

2.4 Service Meter Sets

A. Meter Sets

1. Service meter sets shall include main line service tap, saddle and corporation stop, meter setter with dual check valve backflow preventer, meter, meter pit, frame and cover and reconnection to the service line to the structure.
 - a. Corporation Stops:
 - 1) Comply with ASTM B62.
 - 2) Body: Brass or red brass alloy.
 - 3) Inlet End: Threaded for tapping according to AWWA C800.
 - 4) Outlet End: Suitable for service pipe specified.
 - b. Service Saddles:
 - 1) Type: Double strap.
 - 2) Designed to hold pressures in excess of pipe working pressure.
 - c. Polyethylene Pipe:
 - 1) 1" nominal diameter. Comply with ASTM D3035, 200 **psig** pressure rating.
 - 2) Fittings: Comply with AWWA C901, molded or fabricated.
Joints: Compression or Butt fusion.
 - d. Meter Yokes:
 - 1) Material: Copper.
 - 2) Inlets and Outlets: Horizontal setting, with matching couplings, fittings, and stops.
 - e. Double Check Valve Assemblies:
 - 1) Comply with ASSE 1012.
 - 2) Materials:
 - a) Body: Bronze.
 - b) Internal Parts: Corrosion resistant.
 - c) Springs: Stainless steel.
 - 3) Check Valves:

- a) Quantity: Two, operating independently.
- b) Intermediate atmospheric vent
- f. Water Meters
 - 1) Master Meter or approved equal.
Size 5/8".
- g. Water Meter Boxes
 - 1) Description: Cast-iron body and cover for disc-type water meter, with lettering "WATER METER" in cover; and with slotted, open-bottom base section of length to fit over service piping.
 - a) Option: Base section may be cast-iron, PVC, or other pipe.
 - 2) Description: Cast-iron body and double cover for disc-type water meter, with lettering "WATER METER" in top cover; and with separate inner cover; air space between covers; and slotted, open-bottom base section of length to fit over service piping.
- h. Reconnect new meter to existing service line to structure.
 - 1) Description: Cast-iron body and cover for disc-type water meter, with lettering "WATER METER" in cover; and with slotted, open-bottom base section of length to fit over service piping.
 - a) Option: Base section may be cast-iron, PVC, or other pipe.
 - 2) Description: Cast-iron body and double cover for disc-type water meter, with lettering "WATER METER" in top cover; and with separate inner cover; air space between covers; and slotted, open-bottom base section of length to fit over service piping.
- i. Reconnect new meter to existing service line to structure.

E. EXECUTION

A. EARTHWORK

1. Refer to Division 31 Section "Earth Moving" for excavating, trenching, and backfilling.

B. PIPING APPLICATIONS

1. Piping is arbitrarily limited to NPS 6 (DN 150) for water service, NPS 8 (DN 200) for fire-service mains, and NPS 10 (DN 250) for combined water service and fire-service mains.
2. Select piping applications from this Article. Coordinate with materials specified in Part 2.
3. General: Use pipe, fittings, and joining methods for piping systems according to the following applications.
4. Transition couplings and special fittings with pressure ratings at least equal to piping pressure rating may be used, unless otherwise indicated.
5. Do not use flanges or unions for underground piping.
6. Flanges, unions, and special fittings may be used, instead of joints indicated, on aboveground piping and piping in vaults.
7. Retain "any of" option in first paragraph below to allow Contractor to select piping materials from those retained.
8. Retain one or more of three subparagraphs below.
9. Retain "any of" option in first paragraph below to allow Contractor to select piping materials from those retained.

C. VALVE APPLICATIONS

1. General Application: Use mechanical-joint-end valves for NPS 3 and larger underground installation. Use threaded- or flanged-end valves for installation in vaults. Use UL/FMG, nonrising-stem gate valves for installation with indicator posts.
2. Drawings indicate valve types to be used. Where specific valve types are not indicated, the following requirements apply:
 - a. underground Valves, NPS 3 (DN 80) and Larger: AWWA, cast-iron, nonrising-stem, resilient-seated gate valves with valve box.
 - b. Use the following for valves in vaults and aboveground:
 - c. Gate Valves, NPS 3 (DN 80) and Larger: AWWA, cast iron, OS&Y rising stem, resilient seated.

D. PIPING INSTALLATION

1. Water-Main Connection: Contractor verify for tap of size and in location indicated in water main.
2. Water-Main Connection: Tap water main according to requirements of water utility company and of size and in location indicated.
3. Make connections larger than NPS 2 with tapping machine according to the following:
4. Install tapping sleeve and tapping valve according to MSS SP-60.
5. Install tapping sleeve on pipe to be tapped. Position flanged outlet for gate valve.
6. Use tapping machine compatible with valve and tapping sleeve; cut hole in main. Remove tapping machine and connect water-service piping.
7. Install gate valve onto tapping sleeve. Comply with MSS SP-60. Install valve with stem pointing up and with valve box.
8. Install ductile-iron, water-service piping according to AWWA C600, AWWA M41 and Paducah Water Works Standards.
9. Bury piping with depth of cover over top at least 42 inches, with top at least 12 inches below level of maximum frost penetration.
10. Install underground piping with restrained joints at horizontal and vertical changes in direction. Use restrained-joint piping, thrust blocks, anchors, tie-rods and clamps, and other supports.

E. JOINT CONSTRUCTION

1. Make pipe joints according to the following:
2. Ductile-Iron Piping, Gasketed Joints for Water-Service Piping: AWWA C600 and AWWA M41.
3. Ductile-Iron Piping, Gasketed Joints for Fire-Service-Main Piping: UL 194.
4. Ductile-Iron Piping, Grooved Joints: Cut-groove pipe. Assemble joints with grooved-end, ductile-iron-piping couplings, gaskets, lubricant, and bolts according to coupling manufacturer's written instructions.
5. Dissimilar Materials Piping Joints: Use adapters compatible with both piping materials, with OD, and with system working pressure. Refer to Paducah Water Works "Standard Specifications and Procedures" for joining piping of dissimilar metals.

F. ANCHORAGE INSTALLATION

1. Anchorage, General: Install water-distribution piping with restrained joints. Anchorages and restrained-joint types that may be used include the following:
 - a. Concrete thrust blocks.

- b. Locking mechanical joints.
 - c. Set-screw mechanical retainer glands.
 - d. Bolted flanged joints.
 - e. Pipe clamps and tie rods.
 2. Install anchorages for tees, plugs and caps, bends, crosses, valves, and hydrant branches. Include anchorages for the following piping systems:
 - a. Gasketed-Joint, Ductile-Iron, Water-Service Piping: According to AWWA C600.
 - b. Apply full coat of asphalt or other acceptable corrosion-resistant material to surfaces of installed ferrous anchorage devices.
- G. VALVE INSTALLATION
 1. AWWA Gate Valves: Comply with AWWA C600 and AWWA M44. Install each underground valve with stem pointing up and with valve box.
- H. FIRE HYDRANT INSTALLATION
 1. General: Install each fire hydrant with separate gate valve in supply pipe, anchor with restrained joints or thrust blocks, and support in upright position.
 2. Wet-Barrel Fire Hydrants: Install with valve below frost line. Provide for drainage.
 3. AWWA Fire Hydrants: Comply with AWWA M17.
- I. CONNECTIONS
 1. Connect water-distribution piping to existing water main. Use tapping sleeve and tapping valve.
- J. FIELD QUALITY CONTROL
 1. No pressure testing shall begin after 1:30 p.m. or on Friday.
 2. Piping Tests: Conduct piping tests before joints are covered and after concrete thrust blocks have hardened sufficiently. Fill pipeline 24 hours before testing and apply test pressure to stabilize system. Use only potable water.
 3. Hydrostatic Tests: Test at not less than one-and-one-half times working pressure for two hours.
 - a. Increase pressure in 50-psig increments to a minimum of 150 psig. Hold at test pressure for not less than 2 hours.
 - b. Contractors shall pressure test all new mains prior to chlorination sampling.
 - c. Prepare reports of testing activities.
- K. IDENTIFICATION
 1. Install continuous underground Tracer Wire during backfilling of trench for underground water-distribution piping. Locate below finished grade, directly over piping.
- L. CLEANING
 1. Clean and disinfect water-distribution piping as follows:
 - a. Purge new water-distribution piping systems and parts of existing systems that have been altered, extended, or repaired before use.
 - b. Retain subparagraph below for fire-protection-water piping not connected to potable-water supply.
 - c. Use purging and disinfecting procedure prescribed by authorities having jurisdiction or, if method is not prescribed by authorities having jurisdiction,

use procedure described in NFPA 24 for flushing of piping. Flush piping system with clean, potable water until dirty water does not appear at points of outlet.

- d. Use purging and disinfecting procedure prescribed by Union County Water District or, if method is not prescribed by authorities having jurisdiction, use procedure described in AWWA C651 or do as follows:
 - 1) Fill system or part of system with water/chlorine solution containing at least 50 ppm of chlorine; isolate and allow to stand for 24 hours.
 - 2) Retain last subparagraph above or first subparagraph below.
 - 3) Drain system or part of system of previous solution and refill with water/chlorine solution containing at least 200 ppm of chlorine; isolate and allow to stand for 3 hours.
 - 4) After standing time, flush system with clean, potable water until no chlorine remains in water coming from system.
 - 5) Submit water samples in sterile bottles to authorities having jurisdiction. Repeat procedure if biological examination shows evidence of contamination.
- e. Prepare reports of purging and disinfecting activities.

END OF SECTION 221113

SECTION 331313 - MUNICIPAL SANITARY SEWERS

PART 1 - GENERAL

1.1 SUMMARY

- A. This Section includes gravity-flow, nonpressure sanitary sewerage outside the building, with the following components:
 - 1. Cleanouts.
 - 2. Precast concrete manholes.
 - 3. PVC sewer pipe

1.2 PERFORMANCE REQUIREMENTS

- A. Gravity-Flow, Nonpressure, Drainage-Piping Pressure Rating: Minimum of SDR 35

1.3 SUBMITTALS

- A. Shop Drawings: For manholes. Include plans, elevations, sections, details, and frames and covers.
- B. Coordination Drawings: Show pipe sizes, locations, and elevations.
- C. Field quality-control test reports.

PART 2 - PRODUCTS

2.1 MANUFACTURERS

- A. In other Part 2 articles where titles below introduce lists, the following requirements apply to product selection:
 - 1. Available Manufacturers: Subject to compliance with requirements, manufacturers offering products that may be incorporated into the Work include, but are not limited to, manufacturers specified.

2.2 PIPING MATERIALS

- A. Refer to Part 3 "Piping Applications" Article for applications of pipe, fitting, and joining materials.

2.3 DUCTILE-IRON, GRAVITY SEWER PIPE AND FITTINGS

- A. Pipe: ASTM A 746, for push-on joints.
- B. Standard Fittings: AWWA C110, ductile or gray iron, for push-on joints.
- C. Gaskets: AWWA C111, rubber.

2.4 PVC PIPE AND FITTINGS

- A. PVC Sewer Pipe and Fittings, NPS 15 and Smaller: ASTM D 3034, SDR 35, with bell-and-spigot ends for gasketed joints with ASTM F 477, elastomeric seals.

2.5 CLEANOUTS

- A. Gray-Iron Cleanouts: ASME A112.36.2M, round, gray-iron housing with clamping device and round, secured, scoriated, gray-iron cover. Include gray-iron ferrule with inside calk or spigot connection and countersunk, tapered-thread, brass closure plug.
 - 1. Available Manufacturers:
 - a. Josam Company.
 - b. MIFAB Manufacturing Inc.
 - c. Smith, Jay R. Mfg. Co.
 - d. Wade Div.; Tyler Pipe.
 - e. Watts Industries, Inc.
 - f. Watts Industries, Inc.; Enpoco, Inc. Div.
 - g. Zurn Specification Drainage Operation; Zurn Plumbing Products Group.
 - 2. Top-Loading Classification: Medium and Heavy duty.
 - 3. Sewer Pipe Fitting and Riser to Cleanout: ASTM A 74, Service class, cast-iron soil pipe and fittings.

2.6 MANHOLES

- A. Standard Precast Concrete Manholes: ASTM C 478, precast, reinforced concrete, of depth indicated, with provision for sealant joints.
 - 1. Diameter: 48 inches minimum, unless otherwise indicated.
 - 2. Ballast: Increase thickness of precast concrete sections or add concrete to base section, as required to prevent flotation.
 - 3. Base Section: 6-inch minimum thickness for floor slab and 4-inch minimum thickness for walls and base riser section, and having separate base slab or base section with integral floor.
 - 4. Riser Sections: 4-inch minimum thickness, and of length to provide depth indicated.
 - 5. Top Section: Eccentric-cone type, unless concentric-cone or flat-slab-top type is indicated. Top of cone of size that matches grade rings.
 - 6. Joint Sealant: ASTM C 990, bitumen or butyl rubber.

7. Resilient Pipe Connectors: ASTM C 923, cast or fitted into manhole walls, for each pipe connection.
8. Steps: Individual FRP steps, wide enough to allow worker to place both feet on 1 step and designed to prevent lateral slippage off of step. Cast or anchor steps into sidewalls at 12- to 16-inch intervals. Omit steps if total depth from floor of manhole to finished grade is less than 48 inches.
9. Adjusting Rings: Interlocking rings with level or sloped edge in thickness and diameter matching manhole frame and cover. Include sealant recommended by ring manufacturer.
10. Grade Rings: Reinforced-concrete rings, 6- to 9-inch total thickness, to match diameter of manhole frame and cover.
11. Manhole Frames and Covers: Ferrous; 24-inch ID by 7- to 9-inch riser with 4-inch- minimum width flange and 26-inch- diameter cover. Include indented top design with lettering cast into cover, using wording equivalent to "SANITARY SEWER."
 - a. Material: ASTM A 536, Grade 60-40-18 ductile iron, unless otherwise indicated.

2.7 CONCRETE

- A. General: Cast-in-place concrete according to ACI 318/318R, ACI 350R, and the following:
 1. Cement: ASTM C 150, Type II.
 2. Fine Aggregate: ASTM C 33, sand.
 3. Coarse Aggregate: ASTM C 33, crushed gravel.
 4. Water: Potable.
- B. Portland Cement Design Mix: 4000 psi minimum, with 0.45 maximum water/cementitious materials ratio.
 1. Reinforcement Fabric: ASTM A 185, steel, welded wire fabric, plain.
 2. Reinforcement Bars: ASTM A 615/A 615M, Grade 60, deformed steel.
- C. Manhole Channels and Benches: Factory or field formed from concrete. Portland cement design mix, 4000 psi minimum, with 0.45 maximum water/cementitious materials ratio. Include channels and benches in manholes.
 1. Channels: Concrete invert, formed to same width as connected piping, with height of vertical sides to three-fourths of pipe diameter. Form curved channels with smooth, uniform radius and slope.
 - a. Invert Slope: 2 percent through manhole.
 2. Benches: Concrete, sloped to drain into channel.
 - a. Slope: 8 percent.

- D. Ballast and Pipe Supports: Portland cement design mix, 3000 psi minimum, with 0.58 maximum water/cementitious materials ratio.
 - 1. Reinforcement Fabric: ASTM A 185, steel, welded wire fabric, plain.
 - 2. Reinforcement Bars: ASTM A 615/A 615M, Grade 60, deformed steel.

PART 3 - EXECUTION

3.1 PIPING APPLICATIONS

- A. Pipe couplings and fittings with pressure ratings at least equal to piping rating may be used in applications below, unless otherwise indicated.
 - 1. Use pressure-type Ductile Iron mechanical joint solid sleeve type joints where required to join gravity-flow, nonpressure sewer piping, unless otherwise indicated.
- B. Gravity-Flow, Nonpressure Sewer Piping: Use the following pipe materials for each size range:
 - 1. NPS 3 and NPS 4: NPS 6 ductile-iron, gravity sewer pipe; ductile-iron standard fittings; gaskets; and gasketed joints.
 - 2. NPS 3 and NPS 4: NPS 4 PVC sewer pipe and fittings, gaskets, and gasketed joints.
 - 3. NPS 5 and NPS 6: NPS 6 ductile-iron, gravity sewer pipe; ductile-iron standard fittings; gaskets; and gasketed joints.
 - 4. NPS 5 and NPS 6: NPS 6 PVC sewer pipe and fittings, gaskets, and gasketed joints.
 - 5. NPS 8 and NPS 10: Ductile-iron, gravity sewer pipe; ductile-iron standard fittings; gaskets; and gasketed joints.
 - 6. NPS 8 and NPS 10: PVC sewer pipe and fittings, gaskets, and gasketed joints.
 - 7. NPS 12 to NPS 16: Ductile-iron, gravity sewer pipe; ductile-iron standard fittings; gaskets; and gasketed joints.
 - 8. NPS 12 and NPS 15: PVC sewer pipe and fittings, gaskets, and gasketed joints.

3.2 PIPING INSTALLATION

- A. General Locations and Arrangements: Drawing plans and details indicate general location and arrangement of underground sanitary sewerage piping. Location and arrangement of piping layout take design considerations into account. Install piping as indicated, to extent practical. Where specific installation is not indicated, follow piping manufacturer's written instructions.
- B. Install piping beginning at low point, true to grades and alignment indicated with unbroken continuity of invert. Place bell ends of piping facing upstream. Install gaskets, seals, sleeves, and couplings according to manufacturer's written instructions for using lubricants, cements, and other installation requirements.

- C. Install manholes for changes in direction, unless fittings are indicated. Use fittings for branch connections, unless direct tap into existing sewer is indicated.
- D. Install proper size increasers, reducers, and couplings where different sizes or materials of pipes and fittings are connected. Reducing size of piping in direction of flow is prohibited.
- E. Install gravity-flow, nonpressure, drainage piping according to the following:
 - 1. Install piping pitched down in direction of flow, at minimum slope of 1% for pipe under 8" in diameter 0.4% for 8 in pipe, 0.28% for 10 inch pipe and 0.22% for 12" pipe, unless otherwise indicated.
 - 2. Install piping NPS 6 and larger with restrained joints at tee fittings and at changes in direction. Use corrosion-resistant rods, pipe or fitting manufacturer's proprietary restraint system, or cast-in-place-concrete supports or anchors.
 - 3. Install piping with 36-inch minimum cover.
 - 4. Install piping below frost line.
 - 5. Install hub-and-spigot, cast-iron soil piping according to CISPI's "Cast Iron Soil Pipe and Fittings Handbook."
 - 6. Install PVC sewer piping according to ASTM D 2321 and ASTM F 1668.
- F. Clear interior of piping and manholes of dirt and superfluous material as work progresses. Maintain swab or drag in piping, and pull past each joint as it is completed. Place plug in end of incomplete piping at end of day and when work stops.

3.3 PIPE JOINT CONSTRUCTION

- A. Basic piping joint construction is specified in Division 22 Section "Common Work Results for Plumbing." Where specific joint construction is not indicated, follow piping manufacturer's written instructions.
- B. Join gravity-flow, nonpressure, drainage piping according to the following:
 - 1. Join ductile-iron, gravity sewer piping according to AWWA C600 for push-on joints.
 - 2. Join PVC sewer piping according to ASTM D 2321 and ASTM D 3034 for elastomeric-gasket joints.
 - 3. Join dissimilar pipe materials with pressure-type mechanical joint solid sleeve type couplings.

3.4 MANHOLE INSTALLATION

- A. General: Install manholes complete with appurtenances and accessories indicated.
- B. Install precast concrete manhole sections with sealants according to ASTM C 891.
- C. Form continuous concrete channels and benches between inlets and outlet.

- D. Set tops of frames and covers flush with finished surface of manholes that occur in pavements. Set tops 3 inches above finished surface elsewhere, unless otherwise indicated.

3.5 CLEANOUT INSTALLATION

- A. Install cleanouts and riser extensions from sewer pipes to cleanouts at grade. Use cast-iron soil pipe fittings in sewer pipes at branches for cleanouts and cast-iron soil pipe for riser extensions to cleanouts. Install piping so cleanouts open in direction of flow in sewer pipe.
 - 1. Use medium-duty, top-loading classification cleanouts in unpaved areas.
 - 2. Use heavy-duty, top-loading classification cleanouts in vehicle-traffic service areas.
- B. Set cleanout frames and covers in earth in cast-in-place-concrete block, 18 by 18 by 12 inches deep. Set with tops 1 inch above surrounding grade.
- C. Set cleanout frames and covers in concrete pavement with tops flush with pavement surface.

3.6 CONNECTIONS

- A. Connect nonpressure, gravity-flow drainage piping to building's sanitary building drains specified in Division 22 Section "Sanitary Waste and Vent Piping."
- B. Make connections to existing piping and underground manholes.
 - 1. Use commercially manufactured wye fittings for piping branch connections. Remove section of existing pipe; install wye fitting into existing piping; and encase entire wye fitting, plus 6-inch overlap, with not less than 6 inches of concrete with 28-day compressive strength of 3000 psi.

3.7 FIELD QUALITY CONTROL

- A. Inspect interior of piping to determine whether line displacement or other damage has occurred. Inspect after approximately 24 inches of backfill is in place, and again at completion of Project.
 - 1. Submit separate report for each system inspection.
 - 2. Defects requiring correction include the following:
 - a. Alignment: Less than full diameter of inside of pipe is visible between structures.
 - b. Deflection: Flexible piping with deflection that prevents passage of ball or cylinder of size not less than 92.5 percent of piping diameter.
 - c. Crushed, broken, cracked, or otherwise damaged piping.
 - d. Infiltration: Water leakage into piping.
 - e. Exfiltration: Water leakage from or around piping.

3. Replace defective piping using new materials, and repeat inspections until defects are within allowances specified.
 4. Reinspect and repeat procedure until results are satisfactory.
- B. Test new piping systems, and parts of existing systems that have been altered, extended, or repaired, for leaks and defects.
1. Do not enclose, cover, or put into service before inspection and approval.
 2. Test completed piping systems according to requirements of authorities having jurisdiction.
 3. Schedule tests and inspections by authorities having jurisdiction with at least 24 hours' advance notice.
 4. Submit separate report for each test.
 5. Hydrostatic Tests: Test sanitary sewerage according to requirements of authorities having jurisdiction and the following:
 - a. Allowable leakage is maximum of 30 gal./inch of nominal pipe size per mile of pipe, during 24-hour period.
 - b. Close openings in system and fill with water.
 - c. Purge air and refill with water.
 - d. Disconnect water supply.
 - e. Test and inspect joints for leaks.
 - f. Option: Test ductile-iron piping according to AWWA C600, "Hydrostatic Testing" Section. Use test pressure of at least 10 psig.
 6. Air Tests: Test sanitary sewerage according to requirements of authorities having jurisdiction, UNI-B-6, and the following:
 - a. Option: Test plastic gravity sewer piping according to ASTM F 1417.
 - b. Option: Test concrete gravity sewer piping according to ASTM C 924.
- C. Leaks and loss in test pressure constitute defects that must be repaired.
- D. Replace leaking piping using new materials, and repeat testing until leakage is within allowances specified.

END OF SECTION 221313

SPECIAL NOTE FOR AN AUTOMATED GATE

1. **DESCRIPTION:**

Furnish and erect an automated gate of the height and type to go with the Chain Link Fence specified in the Plans. Furnish and install Automated Gate.

2. **MATERIALS:**

30' Slide Gate For 8-Foot-High Gate With 3 Strands Barbed Wire. Conform to Section 817.
"V" Barbed wire Arms W/Three Additional Strands. Conform to Section 816.04.
Automated Sliding Gate Operator

3. **CONSTRUCTION**

30' Slide Gate For 8-Foot-High Gate With 3 Strands Barbed Wire.

Gate frame shall be hot dipped galvanized steel. Top member shall be steel structural channel/tube extrusion weight not less than 3.0. Frame shall be keyed to interlock with the keyed track member. Vertical members at the ends of the opening portion of the frame shall be "P" shaped in cross section with a nominal base dimension of no less than 2"x2" and weight not less than 1.6 LB. The spacing for the vertical intermediates shall be less than 50% of the gate frame height. The track member to be located on each side of the top primary. When interlocked with and welded to the "Keyed" top member, it forms a composite structure with the top of the gate framed. Welds placed alternately along the top and side of the track at 9" centers with welds being a minimum of 2". All welds on the gate frame shall conform to welding procedures. Gate frame is to be supported from the track by two (2) or four (4) swivel type, self-aligning, sealed lubricant, ball bearing truck assemblies with stainless steel races according to size of gate. Each track is to be attached to a hot dipped, galvanized steel hanger bracket which in turn is to be attached to a 4" O.D. support post. Bottom of each support post is to be equipped with a pair of 3" guide wheel. Diagonal "x" bracing of 3/16" minimum diameter stainless steel cable shall be installed to brace the gate panels. The gate shall be completed by installation of approved filler. The gate filler will be chain link and the gate filler shall extend the entire length of the gate and shall be secured at each end of the gate frame by standard fence industry tension bars and ties. Price should include installation if double support posts is needed, shall be minimum 4" O.D. round or square galvanized steel if ground work and concrete is needed, it should be included with Bid.

"V" Barbed wire Arms W/Three Additional Strands.

Barbed Wire: Three (3) Strand of Barbed Wired of the same description used for fencing, shall be placed above top frame. Barbed wire shall extend to one foot (1'-0") above the gate frame and shall be tack weld secured.

AUTOMATIC SLIDING GATE OPERATOR.

Materials for automatic sliding gate operator. One Hy-Security Model DC15 slide smart gate operator with battery backup. One 6' x 16' reversing detector loop. One 6' x 16' free egress/reversing detector loop. Two Reno B-4 loop detectors with wiring harnesses. One door king stainless, lighted standalone key pad. One black steel 42" flanged gooseneck pedestal. One edco surge suppressor for power. Two concrete pads, 1' square(pedestal) 2' square(gate

operator). All cables, conduit & connectors needed. Power to the unit is to be provided by others(110v - 20amp circuit) Line CL Description Delivery Days Quantity Unit Issue Unit Price

4.0 MEASUREMENT

30' Slide Gate: The Department will measure the quantity by each individual unit.

"V" Barbed Wire Arms: The Department will measure the quantity by linear feet.

Automated Sliding Gate Operator: The Department will measure the quantity by each individual unit.

5.0 PAYMENT. The Department will make payment for the completed and accepted quantities under the following:

<u>Code</u>	<u>Pay Item Pay</u>	<u>Unit</u>
XXXXX	30' Slide Gate For 8-Foot-High Gate With 3 Strands Barbed Wire	(EA)
XXXXX	"V" Barbed Wire Arms W/Three Additional Strands	(FT)
XXXXX	Automated Sliding Gate Operator	(EA)

SPECIAL NOTE FOR CLASS 1A GEOTEXTILE FABRICS USED IN STRUCTURAL PAVEMENT DESIGNS

1. **DESCRIPTION.** This special note covers requirements for Class 1A geotextile fabrics to be used for subgrade stabilization that is a part of a structural pavement design. Section references herein are to the current edition of the Department's Standard Specifications for Road and Bridge Construction, including Supplemental Specifications, unless otherwise noted.

2. **GEOTEXTILE FABRIC.** Use a woven or non-woven fabric meeting the requirements of AASHTO M 288 for Class 1A fabric and Section 3 of this special note.

Conform to the general requirements for GEOTEXTILE FABRIC in Section 843. This includes participation in the National Transportation Product Evaluation Program (NTPEP) for Geotextiles and Geosynthetics and the product data must be posted in NTPEP DataMine.

2.1 PACKING, SHIPMENT AND STORAGE. Conform to Section 7 of AASHTO M 288, current edition for Identification, Shipment, and Storage. Conform to the requirements for PACKAGING in Section 843.

2.2 ACCEPTANCE. Obtain the Department's approval for all material before incorporating it into the project, as required by Section 843.

3. CONSTRUCTION.

Prepare the surface according to Sections 207 or 302.

Place Fabric-Geotextile Class 1A at the proper elevation and locations in continuous strips to minimize the amount of joints and wrinkles during placement. Place fabric according to requirements for CONSTRUCTION in Section 214, **expect that the high-strength fabric shall be temporarily secured in place to maintain tension during aggregate placement.** This may be done with staples, pins, sand bags or backfill as required by fill properties, fill placement procedures, or weather conditions as the Engineer directs.

Fabric overlaps shall be 2 feet, contrary to Section 214, unless a larger overlap or seaming is required by the project plan notes. Longitudinal overlaps (parallel to roadway) should not be placed within traffic wheel paths, but should be placed approximately at the centerline or the shoulder. Overlaps for the ends of fabric rolls should be shingled in the

direction of aggregate/fabric construction (i.e. place the start of the new roll beneath the end of the previous roll).

Any ruts that form during aggregate placement or compaction shall be filled with aggregate to maintain adequate cover over the fabric. Ruts should never be bladed down, as this would decrease aggregate cover over the fabric.

4. **FASTENER PINS.** Comply with the requirements of Section 843 for fastener pins used for Subgrade and Embankment Stabilization, and the fabric Manufacturer's recommendations.

5. **MEASUREMENT.** The Department will measure the Class 1A Fabric in accordance with Section 214.

6. **PAYMENT.** The Department will make payment for the completed and accepted quantities under the following:

<u>Code</u>	<u>Pay Item</u>	<u>Pay Unit</u>
02604	FABRIC-GEOTEXTILE CLASS 1A	Square Yard

SPECIAL NOTE FOR COMPLETION DATE

Livingston County Item No. 1-1142 US 60 Bridge over Cumberland River

I. COMPLETION DATE. All work required as part of the Contract shall be completed by December 1, 2023. The contract completion date includes 244 calendar days of lost time due to High Water Impact. The elevation of High-Water Impact has been selected as a water surface elevation of EL. 320.0 (NAVD88). Figure 1 illustrates a water surface elevation of EL. 320.0 (NAVD88) relative to the profile of the bridge. The estimated number of high-water days is derived from extrapolating water surface elevation data at the Gage site noted below between the years 2008-2019.

An adjustment of contract completion date may be considered if the number of days, in the period from Contract execution to December 1, 2023, that the water surface elevation exceeds EL. 320.0 (NAVD88), as recorded at the tailwater of the Smithland Lock and Dam (USGS Site 03399800), is greater than 244. The Contractor shall provide, in any request for time extension, an analysis detailing the number and timing of high-water days and material impacts to the critical path schedule. Any adjustment of the contract completion date will be at the discretion of the Engineer.

The gauge data for USGS Site 03399800 at the tailwater of the Smithland Lock and Dam can be accessed at the following URL: https://waterdata.usgs.gov/nwis/uv/?site_no=03399800&agency_cd=USGS. Note that water surface data is presented as gauge height with a tailwater gauge datum of EL. 289.08 (NAVD88); therefore, EL. 320.0 (NAVD88) corresponds to a gauge height of 30.9 ft.

Costs associated with reasonably anticipated high-water days should be included in the Contractor's bid price to complete the work. Additional costs due to excessive high-water days beyond those anticipated herein may be considered for reimbursement at the discretion of the Engineer. The Contractor shall provide detailed justification and proof of cost to be considered for any such compensation.

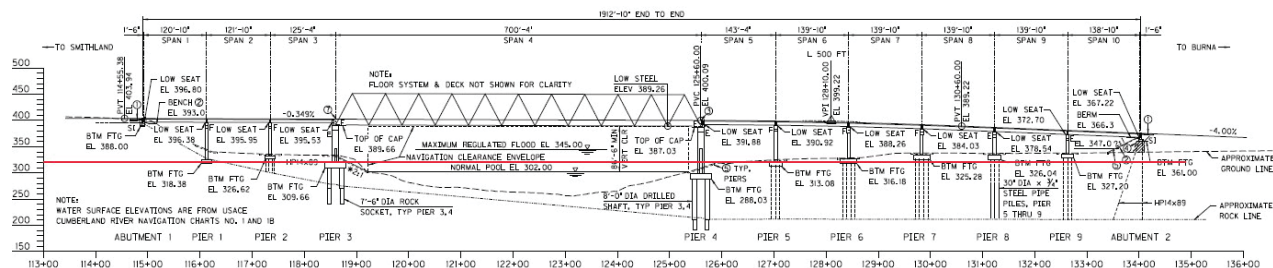

Figure 1 – Bridge Profile Showing Water Surface Elevation EL. 320.0

II. LIQUIDATED DAMAGES. Liquidated damages will be assessed on the Contractor in accordance with the Transportation Cabinet, Department of Highway's 2019 Standard Specifications for Road and Bridge Construction, Section 108.09, at a rate of \$4,750 per calendar day, when the Contract completion date is exceeded.

SPECIAL NOTE FOR CPM SCHEDULING

Livingston County Item No. 1-1142 US 60 Bridge over Cumberland River

1.0 GENERAL

Standard Specifications Section 108.07.04 notwithstanding, contract time extensions will not be given unless the Engineer deems the critical path of the project has been adversely affected. Any contract time extensions will be solely at the discretion of the Engineer. Create the progress schedule required for this project using the critical path method (CPM.) The Contractor shall designate a Schedule Representative who will be responsible for coordinating with the Engineer during the preparation and maintenance of the schedule. The contractor shall submit an interim schedule followed by a baseline schedule, or only a baseline schedule, depending on when the contractor starts work as described below. All references to "days" within this special note are to be construed as calendar days. The Contractor shall hold Monthly progress meetings to discuss status of the project and updates to the schedule.

2.0 INTERIM SCHEDULE

Prior to beginning critical activities, material procurement or site work within the first 28 days after the Start Project Milestone, the Contractor shall submit an interim schedule. The interim schedule must be in CPM schedule format. The interim schedule shall include detailed activities for the work to be accomplished during the first 30 days of the Contract and summary activities for the balance of the work. No work shall begin without the submission of an interim schedule.

3.0 BASELINE SCHEDULE

The Contractor shall submit a baseline schedule as outlined in the submission requirements section (3.2) within 28 days after the Start Project Milestone, which corresponds to the date that the contract is executed and signed by the Department. The baseline schedule is to represent the project as envisioned at the time of bid. No pay estimates will be processed after 28 days without the submission of the baseline schedule. The baseline schedule must be in CPM schedule format and as described below. The Engineer will review the baseline schedule and will indicate the review disposition as "accepted", "accepted as noted" or "rejected" within 14 days of receipt.

For baseline schedules that are "accepted as noted", the Contractor shall make the necessary revisions and resubmit the revised schedule within 14 days. The Engineer will "reject" baseline schedules that are not in compliance with contract requirements. For baseline schedules that are "rejected", the Engineer will indicate in writing portions of the schedule that are not in compliance with the contract requirements. The Project Engineer will conduct a mandatory meeting with the Contractor and the Contractor's Schedule Representative within 7 days of the Engineer's written notice. The purpose of this meeting is to resolve disputes with the baseline schedule so that it may be resubmitted.

The Contractor shall submit the revised Baseline Schedule to the Engineer within 14 days of this meeting for review and acceptance.

No pay estimates will be generated until the baseline schedule is "accepted" or "accepted as noted." In the event the baseline schedule is not "accepted" within 90 days of the Start Project Milestone, all work shall cease on the project until the baseline schedule is "accepted." The incurred delays from the "cease work order" will be the Contractor's responsibility and will not be considered for time extension. Any claims associated with time impacts from work performed or due to delay experienced prior to the baseline schedule being "accepted" or "accepted as noted" will be evaluated at the sole discretion of the Engineer. Acceptance by the Engineer will not relieve the Contractor of responsibility for compliance with specifications and contract requirements or for the accuracy or feasibility of the schedule.

Acceptance of the baseline schedule does not revise the Contract Documents. The baseline schedule must be "accepted" or "accepted as noted" by the Engineer prior to the Engineer evaluating any Contractor claims associated with time impacts.

The Engineer's review of the baseline schedule will be for compliance with the specifications and contract requirements. Acceptance by the Engineer will not relieve the Contractor of responsibility for the accuracy or feasibility of the schedule.

3.1 SCHEDULE REQUIREMENTS

Generate and submit an electronic copy of the baseline schedule using latest version of Primavera P6 by Primavera Systems Inc., or equivalent electronically transferable software. The Contractor's costs associated with these provisions should be incorporated into the bid item for the progress schedule. Provide and maintain current, two licenses of the software for the Engineer's use for the duration of the contract.

Provide a calendar day schedule that shows the various activities of work in sufficient detail to demonstrate a reasonable and workable plan to complete the Project by the Original Contract Completion Date. Include calendar days, not activities, to represent non-work periods due to adverse temperatures or calendar date restrictions. Show the order and interdependence of activities and the sequence for accomplishing the work. Describe all activities in sufficient detail so that the Engineer can readily identify the scope of work and measure the progress of each activity. The baseline schedule must reflect the scope of work, required phasing, maintenance of traffic requirements, interim completion dates, the Original Contract Completion Date, and other project milestones established in the Contract Documents. Only contractually specified constraints (i.e., milestones) are allowed in the schedule. Include all specified project milestones. Use only project calendars as opposed to global calendars. Do not include commas in activity descriptions because Primavera P6 exports data as comma-separated values. Include activities for submittals, working drawings, shop drawing preparation, submittal review time by the Department for shop drawings, material procurement and fabrication, delivery of materials, plans, and equipment, and other similar activities.

The Contractor shall ensure all work, including that by subcontractors, is included in the

schedule. The Contractor shall ensure that all work sequences are logical and that the schedule indicates a coordinated plan.

Failure by the Contractor to include any element of work required for performance of the Contract will not excuse the Contractor from completing all work within the required time. Omissions and errors will be corrected as described in Sections 6.0 or 8.0 of this note and will not affect contract time.

The Baseline Schedule shall include, as a minimum, the following:

a) Administrative Identifier Information

- | | |
|-------------------|-------------------------------------|
| 1. Project Number | 7. Date of Notice to Begin Work |
| 2. County | 8. Completion Date |
| 3. Route Number | 9. Contractor's Name |
| 4. Item Number | 10. Contractor's Dated Signature |
| 5. CID Number | 11. KYTC's Dated Accepted Signature |
| 6. Award Date | |

b) Project Activities

- i. **Activity Identification (ID):** Assign each activity a unique identification number. Activity ID length shall not exceed 10 characters. Assign baseline Activity IDs in sequences of 10 (e.g. A1000, A1010, A1020). This will allow modifications and additional items to be placed into the Identification scheme easily. Once accepted, the Activity ID shall be used for the duration of the project.
- ii. **Activity Description:** Each activity shall have a narrative description consisting of a verb or work function (e.g. form, pour, excavate, pier #2) and an object (e.g. slab, footing, underdrain).
- iii. **Activity Original Duration:** Assign planned duration in calendar days for each activity. Do not exceed a duration of 20 calendar days for any construction activity unless approved by the Engineer. Do not represent the maintenance of traffic, erosion control, and other similar items as single activities extending to the Completion Date. Break these Contract Items into component activities in order to meet the duration requirements of this paragraph.
- iv. **Activity Relationships:**
 - All activities, except the first activity, shall have a predecessor(s). All activities, except the final activity, shall have a successor(s).
 - Use finish-to-start relationships with no leads or lags to link activities or use start-to-start relationships with lags no greater than the predecessor duration to link activities.
 - Use of finish-to-finish relationship is permitted when both activities are already linked with a start-to-start relationship.
 - At least 90% of the relationships must be finish-to-start with no

leads or lags.

c) Project Milestones

- i. Start Project: The Contractor shall include "Start Project" as the first milestone in the schedule. The date used for this milestone is the date the contract is executed and signed by the Department.
- ii. End Project Milestone: The Contractor shall include "End Project" as the last activity in the project schedule. The date used for this milestone is considered the project completion date.
- iii. Start Phase Milestone: The Contractor shall include "Start Phase X" as the first activity for a project phase, where "X" identifies the phase of work.
- iv. End Phase Milestone: The Contractor shall include "End Phase X" as the last activity in a project phase, where "X" identifies the phase of work.

The Contractor may include additional milestones but, at a minimum, must include all contractual milestones.

d) Schedule Options

The schedule may only be calculated using retained logic. Show open ends as non-critical. Schedule durations are to be contiguous. The project calendar will be based on the Contractor's plan for completing the project. However, the scheduling increment (hours or days) will be stipulated during the Preconstruction Conference. All days must remain active unless the Contractor is instructed not to work by contract documents. Total float shall be calculated as finish float.

3.2 SUBMISSION REQUIREMENTS

Submit all schedules within the timeframes specified. Submit the schedule and information in electronic file format via email, and compact disc (CD) compatible with the Engineer's computer. Submit the following information along with the electronic baseline schedule:

- a) A baseline schedule in bar chart format including the Administrative Identifier Information discussed in Section 3.1.a on the first page of the schedule. For each activity on the chart, indicate the Activity ID, Activity Description, Original Duration, Remaining Duration, Total Float, Early Start Date, Early Finish Date, and Percent Complete. Use arrows to show the relationships among activities.
- b) A baseline schedule in bar chart format, on paper. Identify the critical path of the project on the bar chart in red. The critical path is defined as the longest path of activities in the project that determines the project completion date. The activities that make-up the critical path are the "Critical Activities."

3.3 SUBMITTAL COVER MEMO

All submittals shall be accompanied with a brief cover memo containing:

- Identification of the submission as the Baseline Schedule
- Administrative Identifier Information (see section 3.1.a)
- Any critical notes as determined by the Contractor

4.0 FLOAT

Use of float suppression techniques, such as preferential sequencing (arranging critical path through activities more susceptible to Department caused delay), lag logic restraints, unrealistic activity durations, zero total or free float constraints, extending activity times, or imposing constraint dates other than as required by the contract, shall be cause for rejection of the project schedule or its updates. Schedules with negative float will also not be accepted.

4.1 DEFINITION OF FLOAT

Total Float is the length of time along a given network path that the actual start and finish of activity(s) can be delayed without delaying the project completion date. Project Float is the length of time between the End Project Milestone and the Contract Completion Date.

4.2 OWNERSHIP OF FLOAT

Float available in the schedule at any time shall not be considered for the exclusive use of either the Department or the Contractor. During the course of contract execution, any float generated due to the efficiencies of either party is not for the sole use of the party generating the float; rather, it is a shared commodity to be reasonably used by either party. Efficiencies gained as a result of favorable weather within a Monthly period, where the number of days of normally anticipated weather is less than expected, will also contribute to the Project Float. A schedule showing work completing in less time than the contract time, and accepted by the Department, will be considered to have Project Float. Project Float will be a resource available to both the Department and the Contractor. No time extensions will be considered or granted nor delay damages paid unless a delay occurs which impacts the project's critical path, consumes all available float and extends the work beyond the Contract Completion Date.

4.3 NEGATIVE FLOAT

Negative float is not allowed. Schedules with negative float will not be accepted. Negative float will not be a basis for requesting time extensions. Any extension of time will be addressed in accordance with the Section 6.0. Scheduled completion date(s) that extend beyond the contract (or phase) completion date(s) may be used in computations for assessment of liquidated damages. The use of this computation is not to be construed as an order by the Department to accelerate the project.

5.0 MONTHLY UPDATE SCHEDULE

A Monthly update schedule is a schedule in which only progress is updated from the prior data date to the current data date. Work added and/or excusable delays encountered since the prior data date must be represented as a schedule revision as described in Section 5.0.

5.1 Update Requirements

Monthly on a date set at the Preconstruction Conference and until Formal Acceptance, submit an updated schedule and all required information with a data date of the last day of

the preceding Monthly submittal. The date for submission and data date may be adjusted to accommodate regularly scheduled progress meetings. Submit the Monthly updated bar chart on paper and a copy of the updated schedule in electronic format in Section 3.2. The Engineer shall "accept" or "reject" the schedule update within 14 days of receipt of the updated CPM schedule. The Engineer may withhold estimates if the updated schedule is not submitted as required by this section. For each updated schedule, identify the actual start and finish dates for all completed activities and the actual start date and remaining duration for all activities in progress. Provide a written narrative that identifies any changes or shifts in the critical path and submit reasons for the changes or shifts in the critical path.

Submit the following with each updated schedule:

- a) CPM Schedule in Bar Chart Format
- b) Electronic files (formatted as described above)

5.2 SUBMITTAL COVER MEMO

All update submittals shall be accompanied with a brief cover memo containing all the information require in the Baseline Submittal Cover Memo per section 3.3 with the addition of:

- Baseline Report
 - Narrative of baseline expectations
 - Project completion status per baseline expectations of Logic Report
 - Logic Modification Report per Section 6.0
 - Narrative of all logic changes and reasoning
 - Two separate CPM submissions; one reflecting the schedule without changes in logic, the other reflecting the proposed logic and the effects.
 - Description of fragnet required per section 6.0
- Progress Report
 - Narrative of all schedule changes since last update
 - Details of each change including impact of change on the schedule, float consumption or addition, and reason causing change when float is consumed

6.0 REVISIONS

The Work may require and/or the Contractor may revise the CPM schedule. Addition of new activities (fragnets required) or new calendars or changes to existing activities, calendars, original durations or logic constitute a revision. All revisions must be reported in a Logic Modification Report. The Logic Modification Report is a separate CPM update which includes all the changes recommended by the Contractor within the current Monthly update schedule. It shall include a Narrative explanation of the necessary changes accompanying the Monthly update schedule. Any revision which modifies the critical path or impacts an interim date or project completion date is considered a Logic Modification. A fragnet is defined as the sequence of new activities that are proposed to be added to the existing schedule. The fragnet shall identify the predecessors to the new activities and demonstrate the impacts to successor activities. If submitted as a fragnet, the Contractor shall compute two Finish Dates. The first Finish Date shall be computed without consideration of any impact by the fragnet. The second Finish Date shall be computed with consideration of any impact by the fragnet. The Contractor shall also submit a written

narrative stating the reason for the proposed revisions. The Engineer shall "accept" or "reject" proposed revisions within 14 days of receipt of appropriate schedules and narrative. All approved revisions will be incorporated into the Monthly Update Schedule which will become the Revised Monthly Update Schedule.

7.0 TIME EXTENSIONS

The Work may require and/or the Contractor may request an extension of the Completion Date. Perform the following analysis to compute the duration of the time extension. Submit two paper copies and two electronic copies of each analysis performed.

- a) Determine project progress prior to circumstance(s) necessitating the time extension. Unless the Engineer requests an interim schedule updated to the date of the circumstance alleging to have caused delay, the previous accepted Monthly update shall be used to display the prior progress of the project. This schedule is referred to as the Un-impacted Schedule. Unless otherwise agreed in advance by the Department and the Contractor, the impact will be based upon when the work is to be performed as opposed to authorized. Time extensions based on estimated impacts will be the Contractor's risk.
- b) Prepare a fragmentary network (fragnet) depicting the circumstance that is believed to have delayed the project. Estimate duration of impact as accurately as possible. The time extension will be based upon actual durations as described below.
- c) Insert the fragnet into the Un-impacted Schedule, run the schedule calculations and determine the finish date. This schedule is referred to as the Impacted Schedule.
- d) Compare the Impacted Schedule finish date with the Un-impacted Schedule finish date in order to determine the estimated duration of any warranted time extension.
- e) Within 14 days of the termination of the impact, submit a schedule update which includes the actual dates of the impact, and the resulting impact to the project milestones.

Submit the impacted schedule with the request for time extension. Include a narrative report describing the effects of new activities and relationships to interim and contract completion dates. All time extensions approved by the Engineer will be incorporated into the Monthly update with the fragnet used to determine impacts incorporated into the schedule.

8.0 RECOVERY SCHEDULE

If the Monthly Update Schedule or Revised Monthly Update Schedule projects a finish date for the Project more than 14 calendar days later than the Contract Completion Date, submit a recovery schedule showing a plan to finish by the current Completion Date. The acceptance of any schedule projecting a completion date for the Project beyond the Current Contract Completion Date does not constitute approval of a time extension or an order to accelerate. All changes to completion dates and orders to accelerate must be made via Change Order. The Department will withhold Estimates until the Engineer "accepts" the recovery schedule. The Engineer will use the schedule to evaluate time extensions and associated costs requested by the Contractor. In the event the current Completion Date is in dispute, the recovery schedule will need to be submitted once the dispute has been resolved.

9.0 PAYMENT

The Department will make partial payments according to Section 109.05 of the standard specifications and as modified by the following schedule:

- a) The Department will release 50 percent of the lump sum amount bid for Project CPM Schedule to the Contractor with the first regular payable after the Engineer has accepted" the CPM Baseline schedule submission and the Department has received the scheduling software.
- b) The Department will release an additional 25 percent of the lump sum amount bid for Project CPM Schedule to the Contractor with the first regular estimate payable after 50 percent of the original contract amount is complete.
- c) The Department will release the remaining 25 percent of the lump sum amount bid for Project CPM Schedule to the Contractor with the first regular estimate payable after project completion.

The Department will pay for the accepted quantities at the contract price as follows:

<u>Bid Item Code</u>	<u>Pay Item</u>	<u>Pay Unit</u>
02570	Project CPM Schedule	Lump Sum

The Department will consider payment as full compensation for all work required in this provision.

SPECIAL NOTE FOR DISC BEARINGS

Livingston County
Item No. 1-1142
US 60 Bridge over Cumberland River – Drawing No. 27458

1.0 DESCRIPTION AND SCOPE OF WORK

- 1.1** This work shall consist of designing, furnishing, testing, and installing Multi-Rotational, High Load Disc Bearings and Assemblies at the locations shown on the plans in accordance with this special note and the following specifications:
- KYTC Standard Specification for Road and Bridge Construction
 - AASHTO LRFD Bridge Design Specifications
 - AASHTO LRFD Bridge Construction Specifications
 - AASHTO/AWS D1.5 Bridge Welding Code
- 1.2** Disc bearings shall consist of a polyether urethane structural element (disc) confined by upper and lower steel bearing plates. The bearing shall be equipped with a shear resisting mechanism, and/or positive location device to prevent lateral movement of the disc. Bearings shall adequately provide for the thermal expansion and contraction, rotation, camber changes, and creep and shrinkage of structural members, where applicable. Assemblies shall also include all other plates and fasteners designated in the plans as part of the “Bearing Assembly”.
- 1.3** Disc bearing supplier shall demonstrate a minimum of five (5) years’ experience in the design and fabrication of disc bearings and a minimum of ten (10) bridge installations. Documentation of the supplier’s experience and installations shall be provided to the engineer for approval.
- 1.4** Shop Drawings - The contractor shall submit drawings and calculations to the engineer for approval, and shall have received said approval, prior to the fabrication of the disc bearing assemblies. The shop drawings and design calculations shall be sealed by a Professional Engineer with at least five (5) years of documented history of disc bearing design experience. These drawings shall include, but not be limited to, the following information:
- Plan and elevation of each disc bearing
 - Complete details and sections showing all materials (with ASTM or other designations) incorporated in the disc bearings.
 - Vertical and horizontal load capacities.
 - All bearing connection details and weld procedures.
 - Temporary support details for handling, transporting, storing, field adjustment, and installation.
 - Design calculations verifying compliance with AASHTO LRFD standards and with the design loadings, movements, and other specified requirements.

2.0 MATERIALS

2.1 Materials shall conform to the following standards:

- Steel Plate: AASHTO M270 (ASTM A709) Grade 50W. All steel surfaces in contact with PTFE, or other steel surfaces, shall be finished to a smoothness of 125 micro- inches (rms) or better.
- Stainless Steel: ASTM A240, Type 304, with a minimum No. 8 mirror finish. The minimum thickness of stainless steel sheet shall be 12 gage.
- Polytetrafluoroethylene (PTFE): PTFE sheet shall be manufactured from pure virgin unfilled PTFE resin conforming to the requirements of AASHTO LRFD Bridge Construction Specification, Section 18.8.

2.2 All materials shall be new and unused, with no reclaimed material incorporated in the finished bearing.

2.3 Unless otherwise noted herein, all materials for the disc bearing assemblies shall be as specified in the plans and in accordance with Section 18 of the AASHTO LRFD Bridge Construction Specifications.

2.4 Material test certificates shall be provided for all materials used in the bearing assemblies.

3.0 DESIGN REQUIREMENTS

3.1 Bearings shall be designed based on the current AASHTO LRFD Bridge Design Specification using the loads, rotations and movements given on the project plans. Designs shall assume that vertical and horizontal loads occur simultaneously. The design of the bearings shall meet the additional requirements listed herein.

3.2 The bearing assembly shall be removable and replaceable by raising the bridge superstructure 3/8 inch maximum. This requires the fabrication of a minimum of a four plate system including a masonry plate, lower load plate, upper load plate and sole plate. The design plans show a feasible bearing replacement connection detail. Approval of alternative connection details proposed by the Contractor shall be at the sole discretion of the Engineer.

3.3 The sole and masonry plates shall be designed to distribute the bearing loads into the surrounding substructure and/or superstructure. Service or installation considerations specified by the design engineer, such as weldability and bearing height, may require thicker masonry and sole plates than are required due to strength considerations alone.

3.4 When necessary, guide bars shall be welded to the slide plates or integrally machined into a larger plate. Guide bars shall be designed for the specified horizontal loads, but not less than 10% of the vertical capacity of the bearing. Guided members must have their contact area within the guide bars in all operating positions. The total clearance between guide bars and the guided member shall be 1/16 inch, $\pm 1/32$ inch.

3.5 The shear restriction mechanism shall be designed to allow free rotation and withstand the specified horizontal forces. The mechanism shall be designed to withstand the design forces on the bearing without exceeding the allowable shear, bending and bearing capacities. Shear resistance of the urethane disc shall not be included.

4.0 FABRICATION

- 4.1 The contractor shall provide the engineer with written notification prior to the start of bearing fabrication.
- 4.2 Unless otherwise noted herein, fabrication of the disc bearing, including tolerances, shall be in accordance with Section 18 of the AASHTO LRFD Bridge Construction Specifications.
- 4.4 All welding shall conform to, and all welders shall be qualified in accordance with, the requirements of the American Welding Society (AWS).
- 4.5 After assembly, including sole plates and masonry plates as applicable, bearing components shall be held together with steel strapping or other means to prevent disassembly until the time of installation.
- 4.6 Each bearing shall be stamped with the manufacturer's name, bearing type or model number, bearing number and the installed location. The stamp shall be on a surface visible after installation.
- 4.7 All steel surfaces exposed to the atmosphere, except stainless steel surfaces and metal surfaces to be welded, shall be shop painted. Prior to painting, the exposed steel surfaces shall be cleaned in accordance with the recommendations of the paint manufacturer. All surfaces covered by stainless steel or PTFE sheet are not painted. Painting shall be completed in accordance with the paint manufacturer's recommendations and the KYTC Construction Specifications.

5.0 TESTING

- 5.1 Production bearing sampling and testing shall be performed in accordance with AASHTO LRFD Bridge Construction Specifications, Section 18.3.4. For sampling, the two guided bearings at Pier 4 shall be considered one lot, and the two fixed bearings at Pier 3 shall be considered another lot.
- 5.2 All testing shall be performed in the presence of a representative from KYTC or its designated inspection agency in accordance with Section 18.1.5 of the AASHTO LRFD Bridge Construction Specification.
- 5.3 The following test shall be performed on all disc bearing types (fixed and guided):
 - Material certification testing – Refer to AASHTO Section 18.3.4.4.1
 - Dimensional check – Refer to AASHTO Section 18.1.5.2.4.
 - Clearance test – Refer to AASHTO Section 18.1.5.2.5.
 - Proof load test - Load the bearing to 150 percent of the design service compressive load at a rotation of 0.02 rad for a duration of one hour. Refer to AASHTO Section 18.3.4.4.4.
 - The horizontal load carrying capacity shall be tested per AASHTO 18.1.5.2.8.
- 5.4 The sliding coefficient of friction shall be measured for guided bearings per AASHTO 18.3.4.4.5.
- 5.5 Each bearing shall be visually examined both during and after testing. Any resultant defects, such as bond failure, physical destruction or cold flow of PTFE to the point of debonding, shall be cause for rejection. Defects such as permanently extruded or severely deformed elastomer or cracked steel shall also be cause for rejection.

6.0 INSTALLATION

- 6.1** Bearings shall be installed in strict accordance with the manufacturer's instructions. The Contractor shall submit an installation procedure to the Engineer for review and acceptance prior to bearing installation, containing at a minimum:
- Installation sequence of the bearings in accordance with the accepted bridge superstructure erection sequence.
 - Measures to prevent disturbances to the grout during its initial setting and early strength gain.
 - Methods to support and shim the bearing assemblies.
 - Methods for field setting and adjustments as required to compensate for installation temperatures and erection conditions in order to achieve the installation tolerances specified in Section 18 of the AASHTO LRDF Bridge Construction Specifications.
 - Procedure for grouting operations including measures to ensure no voids in the grouted area.
- 6.2** A technical representative from the bearing manufacturer shall be present on-site to supervise the installation of the bearing assemblies.
- 6.3** Bearings delivered to the bridge site shall be stored under cover on a platform above the ground surface. Bearings shall be protected at all times from damage. When placed, bearings shall be dry, clean, and free from dirt, oil, grease, or other foreign substances.
- 6.4** Bearing devices shall not be disassembled unless otherwise permitted by the engineer or manufacturer.
- 6.5** Bearings assemblies shall be handled by their bottom surfaces only, unless specially designed lifting brackets are used. Do not lift bearings by their tops, sides and/or shipping bands. Lifting brackets shall be approved by the bearing supplier prior to use.
- 6.6** Upon final installation of the bearings, the Engineer shall inspect the bearing components to assure that they are level and parallel to within ± 0.005 radians. Any deviations in excess of the allowed tolerances shall be corrected.
- 6.7** Caution shall be taken to ensure that the steel temperature directly adjacent to the polyether urethane rotational element does not exceed 225°F. The polyether urethane disc must not be exposed to direct flame or sparks. In addition, no weld current shall pass between bearing plates on either side of the urethane disc.

7.0 GROUT AND GROUTING OPERATION

- 7.1** Grout for bearing assemblies shall be a non-shrink, non-metallic and cementitious grout containing no chloride conforming to Section 601 of the KYTC Standard Specifications. The grout shall have a minimum compressive strength of 7,000 psi at 28 days as tested in accordance with ASTM C109. The grout shall have appropriate early setting and strength gain properties as required to minimize the duration during which the grout is susceptible to disturbances from superstructure movement or other causes.
- 7.2** Surface preparations, installation temperatures ranges, mixing methods, equipment, application methods, and curing conditions and times shall be in strict accordance with the grout manufacturer's written specifications.
- 7.3** The Contractor shall submit the manufacturer's product data sheets for review and

acceptance prior to ordering the grout material.

- 7.4 Grouting operations shall not commence until the grouting procedure has been reviewed and accepted by the Engineer.
- 7.5 Load transfer to the grouted bearing assemblies will be permitted only after the grout has reached the minimum strength specified.

8.0 CERTIFICATION

- 8.1 After installation of all bearing assemblies and prior to acceptance by KYTC, the bearing manufacturer shall provide a written certification that the bearing assemblies have been fabricated, tested, and installed in accordance with the project requirements and manufacturer's requirements.

9.0 MEASUREMENT AND PAYMENT

- 9.1 The Department will pay for the "Disc Expansion Bearing" and "Disc Fixed Bearing" at the contract unit price per each bearing assembly. This will constitute full compensation for all costs associated with preparing concrete surfaces; installation of anchor bolts; grouting; design, fabrication, testing, and installation of the bearing assemblies (including all steel plates and fasteners below the sole plate).

The Department will pay for the completed and accepted quantities under the following:

<u>Pay Item</u>	<u>Pay Unit</u>
Disc Expansion Bearing	Each
Disc Fixed Bearing	Each

SPECIAL NOTE FOR MAINTAINING EXISTING BRIDGE

Livingston County Item No. 1-1142 US 60 Bridge over Cumberland River

1.0 SCOPE OF WORK

In addition to the Contractor's responsibility described in specification 105.11, the Contractor shall be responsible for the maintenance of the existing Lucy Jefferson Lewis Memorial bridge deck, curb, railing, joints, and any other component item on the structure that is identified by the Engineer for maintenance. The period of responsibility for maintenance will start when the contractor begins mobilization to the site, continues throughout construction and until public traffic has been shifted onto the new bridge and is no longer required on the existing bridge. No extension of time will be granted for maintaining the existing Lucy Jefferson Lewis Memorial Bridge.

2.0 PAYMENT

The Department has established an allowance within the project budget to perform anticipated bridge maintenance activities as directed by the Engineer. The maintenance performed will be paid as Force Account Work in accordance with specification 109.04.02. Provide justification and documentation to support payment for all work performed. Maintain cost records reconciled daily conforming to specification 109.04.02.E. This item does not include repairs to be performed on the bearings at piers SP1, NP1, and NP5 or the repairs to the cap and column of Pier A. The Department will make payment for authorized work to maintain the existing bridge per the following:

<u>Bid Item Code</u>	<u>Pay Item</u>	<u>Pay Unit</u>
24755EC	Maintain Existing Bridge	DOLL

SPECIAL NOTE FOR MITIGATION OF IMPACTS TO OSPREY

Livingston County Item No. 1-1142 US 60 Bridge over Cumberland River

Osprey nests on the existing US 60 bridge shall not be removed or disturbed. Construction activities shall not be permitted within a 150-foot buffer of any Osprey nest during the nesting season from March 1 to August 31, the work buffer is not required outside of these dates. During this period, construction equipment shall not be placed between the existing and new bridge and equipment, including concrete trucks, shall not be allowed to work from the existing bridge. The buffer zone may be reduced to a minimum of 75-ft pending tests to evaluate the Ospreys' tolerance to certain construction activities. Tests shall be conducted on warm, dry days in the presence of a trained biologist designated by the KYTC. The Biologist shall have authority to specify a new buffer distance as well as shut down construction activities. The Biologist shall record all observations and report them to the KYTC as well as the KDFWR. The buffer requirement may be ended before August 31, if the biologist observes that young ospreys have fledged from a nest and left the area. The Contractor should note that the most crucial time for the nesting Osprey occurs between April and July, during this time there is an increased likelihood that nesting Osprey will be present and greater potential for the birds to be disturbed by construction activities. Consequently, demolition of the existing bridge shall not occur between the months of April and July.

SPECIAL NOTE FOR MITIGATION OF IMPACTS TO THE CUMBERLAND RIVER IN ACCORDANCE WITH THE BIOLOGICAL OPINION CONCERNING FAT POCKETBOOK MUSSELS

Livingston County Item No. 1-1142 US 60 Bridge over Cumberland River

1. KYTC is bound by the tenets of Kentucky Pollution Discharge System (KPDES), permit number KYR10, to reduce erosion and sedimentation effects from projects involving soil disturbance. As required under Section 213 of the KYTC Standard Specifications, a site-specific Erosion Control Plan, including Best Management Practices (BMP), will be developed prior to on-site activities to ensure continuous erosion control throughout the construction and post-construction period. The plan will identify individual Disturbed Drainage Areas (DDA) where stormwater from the construction area will be discharged off site or into waters of the Commonwealth. This measure will reduce the amount of sediment and other contaminants introduced into the Action Area, minimizing impacts to mussels.
2. During demolition of the existing bridge, if the concrete deck is removed prior to demolition of the truss, the contractor will be responsible for assuring that decking debris falling into the river will be kept to a minimum.
3. Removal of the existing piers will be conducted as outlined in the U.S. Coast Guard permit dated January 28, 2020. To the maximum extent practicable, all material from the demolition of the existing piers will be removed from the river bed.
4. Once the new truss has been set and coffer cells/barge slips are no longer needed, any dredged areas along the riverbank and/or channel will be filled with natural stable material (not demolition debris), graded back to original contours, stabilized to prevent erosion, and re-vegetated.
5. All materials excavated from dredging or during truss removal will be stored at an upland site and precluded from re-entry into any aquatic resource. Sediment and erosion control measures should be installed at the upland site to prevent any material from entering the adjacent waterways.
6. The contractor will conduct daily turbidity monitoring 100-foot upstream of the existing US Highway 60 bridge, as well as 500-foot and 1,000-foot downstream at both the substrate level and mid-water column during riverbed/riverbank disturbance activities such as dredging, cofferdam installation/removal, as well as pre-and post truss demolition. Monitoring results will be provided to the KYTC inspector on site for inclusion in the daily KYTC work reports. Costs associated with turbidity monitoring will be incidental to the work.
7. Should the contractor propose alternate construction/demolition methodologies, a proposed plan will be submitted to the Department for coordination with the appropriate resource and permitting agencies.

SPECIAL NOTE FOR PROVISION OF COMPRESSION TESTING MACHINE

Livingston County Item No. 1-1142 US 60 Bridge over Cumberland River

1.0 SCOPE OF WORK

The Contractor shall supply, delivered and installed, to the Kentucky Transportation Cabinet (KYTC) Smithland Section Office a new and unused compression testing machine capable of testing concrete cylinders, beams, cubes, masonry, brick, rock samples and a variety of other samples. The machine must be installed and operational prior to the commencement of any construction activities on the new bridge or roadway approaches; upon installation, the machine will become property of the KYTC. The machine shall meet the minimum specification detailed in this Special Note.

2.0 PRODUCT SPECIFICATIONS

The compressive testing machine shall be a Forney F-325EX equipped with automatic control systems or an approved equivalent. The minimum specifications are as follows:

DESCRIPTION: Compression testing machine capable of testing concrete cylinders, beams, cubes, masonry, brick, and rock samples.

CAPACITY: 325,000 lbf compression

RANGE: 3,250 to 325,000 lbf

SYSTEM DESIGN: Single-unit, self-contained design. The load readout, hydraulic pump and control valve directly connected to the compression unit.

COMPRESSION UNIT CONSTRUCTION: Load frame manufactured from structural steel with top and bottom crossheads of 3.5" thick solid steel plate. Hydraulic cylinder assembly mounted to the bottom crosshead, with force being applied in upward direction and debris protection by metal shroud.

INSIDE DIMENSIONS: Vertical daylight opening of 19.25" for the compression area of the load frame, and a 9.5" horizontal dimension for the horizontal opening. Dimensions are without upper platen installed.

OUTSIDE DIMENSIONS: Outside dimensions are 57" vertical x 35" wide x 17" deep, including electrically operated hydraulic pump.

COMPRESSION PLATEN: Lower platen of 1" thick by 6.5" in diameter and chrome plated for wear and rust resistance. Concentric circles shall be inscribed into the platen for centering of test specimens.

HYDRAULIC RAM ASSEMBLY: Testing pressure applied by a 6.75" diameter power piston. Stability length of 6" for the piston and a working stroke of 2.5". The piston shall

be precision ground and polished to an 8 RMS finish, piston to be mounted in a polished solid steel cylinder with a non-frictional “0” ring and Teflon back-up ring for sealing.

HYDRAULIC PUMPING SYSTEM: Hydraulic pressure is to be supplied to the power piston assembly by a special two-stage pump. Power pump shall feature a first stage which provides low-pressure, high-volume deliver for rapid advance of the ram to the specimen. Once system pressure exceeds 100 psi, a second stage pump shall take over to deliver high-pressure, low-volume flow to machine capacity. Pump shall be directly connected to the electric motor shaft and be immersed in oil for maintenance free service.

HYDRAULIC CONTROL SYSTEM: Shall feature a single automatic control valve with multiple loading and unloading functions as outlined below:

METERED ADVANCE: Maintains stress loading adjustable from 2,000 pounds to 200,000 pounds per minute. Rate of loading automatically maintained by the pressure compensating valve until it is either readjusted, or the test specimen reaches its yield point.

FULL ADVANCE: Rapid traverse lever used to position the platen at the rate of 2.5” travel per minute.

HOLD: Pressure advance stopped and held to inspect the alignment of the test sample or interrupt the test cycle.

RETRACT: Release of pressure and return of the compression platen to the start position or total retract.

STAND: Shall position the machine to a convenient working height.

ELECTRICAL SPECIFICATIONS: hydraulic pump motor rated at – 110/220 volts, 12.0/6.0 full load amps, single phase, 50/60 Hz current, ¾ horsepower.

SAFETY: Protective mechanical limit switch installed to protect the machine against piston over extension.

ACCESSORY SYSTEM: Accessories held in the compression unit by means of a holding stem system. Holding stem to be inserted into the hydraulic piston and held by a locking setscrew.

SHIPPING: Machine shall be shipped in an upright position, bolted to a wooden skid and crated.

AUTOMATIC CONTROL SYSTEM: Shall provide fully automatic “one touch” testing and be configurable for 2x4 cylinders, 4x8 cylinders, 6x12 cylinders, beams, cubes, and proppant cylinder fixtures. The system shall automatically gather all test parameters and test data and compile the results into a database format along with printed results including load vs time graph. The detailed individual test data shall be stored on the machine via encrypted CSV files with the capability to unencrypt and move to a user-defined location using the machine software.

OPERATOR INTERFACE: Shall include the following:

- Human machine interface incorporating “touchscreen” technology facilitating all setup, data logging, calibration, and password protection. Manual pushbuttons limited to those necessary for safety precautions (emergency stop).

- Equipped with
 - Intel E3845, 1.91 GHz Quad Core CPU
 - 10” Wide Super Video Graphic Array, 1024x600 px
 - 8GB Ram, 64GB Hard Drive
 - 802.11 WIFI
 - RS-232, (2) Dual Intel 82574L Gigabit Ethernet ports, (4) USB ports
 - Fanless, VESA Compliance
 - Windows 10 LoT Enterprise 64-bit
- Ability, at the operator’s discretion, to print hard copy printout of individual test data including the following:
 - Machine make, model, and capacity
 - Machine serial number
 - Calibration date
 - Manufacturer name, address and contact information
 - Test Operator’s name, business address and contact information
 - Test ID
 - Date
 - Time
 - Test type
 - Specimen dimensions
 - Correction factor
 - Ramp rate
 - Load at break
 - Stress at break
 - Break type
 - Graph of load versus time, or stress versus strain
- Option of printing test data from a previous test with the information listed above.
- System prints to a manufacturer-specified printer via USB or Wi-Fi.
- Ability to transfer summary or test data to a portable “flash” drive storage device, or a shared network file.
- Capability for remote troubleshooting and the addition of factory supported system updates.

ELECTRICAL REQUIREMENT: 110VAC, 60Hz, 5Amps at full load

ACCURACY: 1.0% over calibrated range (from 1% of full scale to full scale)

COMPLIANCE: The system shall be in compliance with ASTM C39, C78, C109, C293, C469, A370, and E-4 ASTM specifications.

3.0 PAYMENT

All cost, including material and labor, associated with the provision of the compressive testing machine shall be considered incidental to the unit bid price for Class 'A' Concrete.

SPECIAL NOTE FOR STEEL ERECTION

Livingston County Item No. 1-1142 US 60 Bridge over Cumberland River – Drawing No. 27458

1.0 DESCRIPTION

This work shall consist of fabricating, furnishing and installing the truss span superstructure, including truss main members, connections, floor beams, stringers and bracing.

Materials and workmanship shall be in accordance with the KYTC Standard Specifications for Road and Bridge Construction, 2019 Edition (KYTC); AASHTO/AWS D1.5M/D1.5 "Bridge Welding Code"; AWS D1.1/D1.1M "Structural Welding Code - Steel"; the Contract Drawings; and this Special Note.

Where a conflict exists between this Special Note and KYTC Section 607, the provisions herein shall govern.

2.0 MATERIALS

Materials shall conform to the Contract Drawings and KYTC Section 607.

3.0 ERECTION ANALYSIS AND STABILITY

3.1 Steel Erection Responsibility. The stability of the structure during erection, and the final geometry of the structure, is the responsibility of the Contractor. The Contractor shall retain an erection engineer for the purpose of evaluating the stability, state of stress and geometry of the structure during and after erection. The erection engineer shall evaluate and propose wind loads during construction which are appropriate for the proposed erection scheme chosen. The Contractor shall erect the bridge in a safe manner without overstressing the structural components during erection and shall leave the structure in a state of stress compatible with the design.

Structural steel shall be in conformance with KYTC Section 607. Steel erection shall be in conformance with the AASHTO/NSBA "Steel Bridge Erection Guide Specification," S10.1-2014.

3.2 Conceptual Erection Sequence. The assumed erection sequence, as described in the Contract Drawings, is that a portion of the truss and floor system is constructed on blocking in the "no-load condition." This would require floating in of the fully completed steel superstructure for placement on top of the constructed piers. The Contractor may choose and develop any sequence that can safely erect the bridge without overstress or damage to

the structural steel subject to approval by the Engineer and United States Coast Guard (USCG). The design of any necessary shoring / falsework and its foundations is the responsibility of the contractor.

- 3.3 Truss Erection and Camber.** In addition to full analysis of the completed structure, load capacity and stability of the truss structure has been verified by the Engineer of Record for the completely erected steel superstructure, prior to deck placement. The Contract Drawings details the assumed erection and deck pour sequence that is consistent with the camber shown on the Contract Drawings and the load capacity of the fully-erected structure. No provision in either the camber or structural capacity of the members has been included for erection stresses.

The load capacity and stability verification of a partially completed truss span in the various stages of erection prior to installation of all steel members is the responsibility of the Contractor. The Contractor shall evaluate the partially completed structure in accordance with the same design provisions used for the permanent structure except as indicated herein. Wind loads for the final structure are given on the Contract Drawings. The erection engineer shall evaluate wind loads during construction which are appropriate for the proposed erection scheme chosen.

No uplift at bearings shall be allowed in any construction phase.

- 3.4 Changes to the Structure.** Any changes to the structural steel system shown in the Contract Plans require reanalysis for load capacity and stability for both construction and permanent load conditions, including seismic. Diaphragm action of the stay-in-place forms shall be neglected in all analyses.

Dead load deflection, camber and stringer haunch thickness are based on the erection and slab pouring sequences as shown in the plans. Any deviation from this sequence will need to be evaluated by the Contractor's engineer to determine the effect on camber, dead load deflection and structural member stresses. This evaluation must be submitted to the Engineer for review and approval by the Engineer of Record.

4.0 QUALIFICATIONS AND SUBMITTALS

- 4.1 Erector Qualifications.** Structural steel shall be erected by a qualified, competent erection contractor. To establish qualification the erection contractor shall submit to the Department proof of their experience on previous projects of equivalent complexity which, at a minimum, include the following:

- A. Any one lift using two or more cranes/derricks/poles,
- B. Steel truss spans over water,
- C. Erection with floating equipment,
- D. Field splicing primary members while held in place by erection equipment.

The Department shall determine whether the submitted evidence is satisfactory to establish qualification and competency.

4.2 Erection Procedure. The Contractor shall submit a detailed erection procedure to the Engineer, prepared and sealed by a professional engineer licensed in Kentucky. The professional engineer who prepares the erection procedure and calculations shall have experience in steel erection of similar size, complexity, and scope. The procedure shall address all requirements for erection of the structural steel into the final designed configuration and satisfy all written comments from the Engineer of Record and the Department or its agents prior to the start of erection. The procedure, as a minimum, shall include the following information:

Drawings.

- A. Plan of the work area showing permanent support structures (piers and abutments), roads, waterways (including navigational channel), overhead and underground utilities, and other information pertinent to erection.
- B. Erection sequence for all members noting any temporary support conditions, such as holding crane positions, temporary supports, falsework, etc. Member reference marks, when reflected on the erection plans, should be the same as used on shop detail drawings.
- C. Primary member delivery location and orientation.
- D. Location of each crane for each primary member pick, showing radius and crane support (barges, mats, etc.).
- E. Capacity chart for each crane configuration and boom length used in the work.
- F. Center of gravity locations for primary members.
- G. Detail, weight, capacity, and arrangement of all rigging for primary member picks.
- H. Lifting weight of primary member picks, including all rigging and pre-attached elements.
- I. Details of any temporary lifting devices to be bolted or welded to permanent members, including: method and place (shop or field) of attachment; capacity; and method, time and crew responsible for removal.
- J. Bolted splice assembly requirements.
- K. Lifting/handling procedure for any primary member that has a lifted length-to-width ratio (l/b) greater than 85.
- L. Blocking details for bridge bearings.

Calculations.

- A. Design calculations indicating the load capacity and verifying the stability of temporary supports for structure and crane(s) for each pick and release.

- B. Calculations to substantiate structural adequacy and stability of all steel members for each step of bridge assembly, including documentation of the wind loads and other construction loads assumed to be applied.
- C. Calculations to verify adequate capacity of contractor-fabricated rigging such as lift beams, welded lugs, spreader beams, beam clamps, etc. Submit manufacturers' certification or catalog cuts for pre-engineered devices.
- D. Geometrical information that will be used to monitor the structure during erection to ensure that the final geometry of the structure is as indicated on the plans.

Coordination Items.

- A. Review / approval by other agencies as required (e.g., US Coast Guard, US Army Corp of Engineers, etc.).
- B. Construction activities that occur concurrently with steel erection, such as setting forms or concrete deck pours.

4.3 Shop Drawings. Shop drawings for truss and components shall conform to KYTC Section 607. The following replaces Subsection 607.03.01 of the Department's 2012 Standard Specifications for Road and Bridge Construction in its entirety.

607.03.01 Shop Drawings and Welding Procedures. Submit detailed shop drawings and welding procedures to the Division of Structural Design or their designated representative ("Reviewer"). The Department will furnish plans showing sufficient details for the Contractor to prepare detailed shop drawings. Include welding procedures and details, when required, as part of the shop drawings. The Department will not consider the shop drawing submittal process to be complete without the submittal of welding procedures.

Submit a shop drawing submittal schedule (Schedule) for review and approval no later than thirty calendar days prior to the first submittal. List all anticipated shop drawing packages for the project by component and superstructure unit, span or pier, and show the estimated submittal dates for each package. Update the Schedule and resubmit to the Engineer, for review but not approval, on the first day of each calendar month until all required shop drawing submittals have been approved.

Submit shop drawings in substantial conformance with the latest Schedule submitted to the Engineer and include all relevant drawings and construction procedures necessary for a thorough review. Allow sufficient lead time to permit a complete review.

Submit shop drawings in electronic format. Make all drawing submittals in a 22 inch by 36 inch Portable Document Format (PDF) that will produce clear prints and sharp lines on both 11 inch by 17 inch prints and 22 inch by 36 inch prints ("PDF Prints"). The Department reserves the right to require hard copy prints on a case-by-case basis.

Submission of two or three-dimensional computer modeling data will not by itself constitute a complete shop drawing submittal. The use of two- or three-dimensional computer modeling techniques to facilitate fabrication will not relieve the fabricator from providing detailed shop drawings of all bridge members and components for the Department's records.

Submit to the Reviewer PDF Print Files of the detailed shop drawings and welding

procedures. Electronically stamp all shop drawings and procedures with the Contractor's stamp as an acknowledgment that the Contractor has reviewed the submittal for completeness and appropriateness. Each sheet will be electronically stamped by the Reviewer. The Reviewer will return one PDF file of reviewed shop drawings with all required corrections noted. When corrections and resubmittal are required, submit PDF Print Files of the corrected drawings. After the final review, when additional resubmittal is unnecessary, the Reviewer will forward the reviewed shop drawing PDF Print files with the Reviewer's Stamp indicating approval (or conditional approval) and any final comments to the DOSD Shop Plan Coordinator for distribution. Only plans submitted directly to the Shop Plan Coordinator by the Reviewer will be distributed, and only plans electronically stamped "distributed by the Division of Structural Design" are to be used for fabrication.

After fabrication is complete and the Engineer has approved the structural steel for shipment, furnish to the Engineer one electronic set of the as-built shop drawings, including the welding procedures, as PDF Prints.

Review cycles will begin the first Business Day after a submittal is received ("logged"), or the next Business Day after the submittal date indicated on the most recently submitted Schedule, whichever occurs later. Submittals received after 2:00 PM Eastern Time will be logged as the next Business Day following receipt of the submission. 'Business Days' are weekdays, Monday through Friday except official Department holidays.

The Reviewer will determine if all relevant drawings and construction procedures have been submitted. If a submission is incomplete or otherwise requires additional information or data to properly complete the review, the review cycle for the submission will be reset and the cycle will begin as specified in the previous paragraph once all required information is received (logged.)

Review cycle durations for shop drawing submittal packages deemed complete by the Reviewer are as follows:

- Allow at minimum 30 Business Days for review of shop drawing submissions of welded plate girders or rolled steel sections.
- Allow at minimum 30 Business Days for review of shop drawing submissions for disc bearings, truss members, lateral bracing, floor beams, and their respective connections.
- Allow at minimum 15 Business Days for review of other shop drawing packages.

No claims for delay will be considered for shop drawing reviews when the Engineer has indicated that relevant drawings or construction procedures are insufficient for a thorough review. No claims for delay will be considered for shop drawing reviews when information relevant to the submittal review is still in the process of being developed. Additional time to review requested changes to any relevant drawings and construction procedures will not be considered cause for delay claims.

Do not make changes to any drawing after the Engineer has reviewed it without the Engineer's written approval or written direction.

Only make substitutions of sections different from those shown on the drawings when the Engineer approves in writing.

Although the drawings may have been reviewed, take responsibility for the correctness of the drawings and for shop fits and field connections.

Take responsibility for any material ordered or work done before the Engineer reviews the drawings and welding procedures.

When design drawings differ from the shop drawings, the design drawings govern. When the requirements of this section differ from the shop drawings, the requirements of this section govern.

When the design drawings differ from the requirements of this section, the design drawings govern.

5.0 TRANSPORTATION, HANDLING AND SUPPORT

5.1 Transportation.

Responsibility. The Contractor is responsible for coordinating delivery from the fabricator to the jobsite and for providing adequate site access.

Shipping plan. The Contractor is responsible for preparing a shipping plan indicating support, lateral bracing, and tie-down points for primary members during transportation to the jobsite.

Handling. Ship primary members upright, unless otherwise approved by the Department. Load, support, and unload primary members in a manner that will not damage, excessively stress or permanently deform the steel or cause repeated stress reversals in the members.

5.2 Lifting and Assembly.

General. Lift, position and assemble all members in accordance with the approved erection procedures. The proposed crane location(s) and member delivery location(s) may require modification in the field to suit changing jobsite conditions. However, cranes and material must be located such that the lift is safe and within the crane manufacturer's rated capacity for all required positions.

Lifting device. Install lifting devices, including bolted assemblies using existing bolt holes (splices, cross frame connection plates, etc.), using Department-approved details. Welded lugs are not permitted without approval of the Engineer.

Erection stability. All structural members shall be stabilized with falsework, temporary bracing and/or holding cranes until the structure is complete and has the necessary lateral stability to make the structure self-supporting.

Falsework and temporary supports. Falsework and temporary supports shall be detailed to ensure that the temporary elevation of supported steel accommodates the deflections expected to occur as the structure is completed.

Pins. Pins are normally used to align holes for bolted field connections. Field reaming to facilitate fit-up will only be allowed with the Department's prior approval. Any abnormal distortion of the member or of the holes during the alignment process shall be immediately reported to the Engineer.

Connections. For splice connections of primary members, fill at least 50 percent of the holes prior to crane release. The 50 percent may be either erection bolts in a snug tight condition or full-size erection pins. At least half (25 percent of all holes) shall be filled with bolts, and sufficient pins shall be used near outside corners of splice plates and at member ends near splice plate edges to ensure alignment. Uniformly distribute the filled holes.

The 50 percent requirement may be waived if a reduced percentage is calculated as sufficient and shown on the approved erection procedure. Permanent bolts may be used as erection bolts, provided they are installed in accordance with the specifications.

Primary member splice connections that are assembled on the ground (prior to erection) shall be 100 percent complete, in the no-load condition, prior to any lifting operation.

Abnormalities. Any abnormal member deformation or brace deflection after crane release or temporary support removal shall be immediately reported to the Engineer for swift resolution. Further work affecting the area, except for restoring support or adding bracing, shall be stopped until the deformation/deflection is resolved.

6.0 REPAIR

- 6.1 **Documentation.** The Contractor is responsible for documenting damage due to handling, removal of erection aids, aligning members and other actions, uncorrected misfits at connections, and misalignments exceeding tolerances in erected members. As-received damage attributable to transport or fabrication shall also be documented.
- 6.2 **Implementation.** The Contractor shall propose a method of repair and basis for acceptance for the Department's review.
- 6.3 **Repair Procedures.** Submit repair procedures for damaged or misaligned steel in the form of sketches and/or written procedures as applicable and as requested by the Department. Information must provide sufficient detail for the Department to adequately review the repair application. After repairs are complete, the Contractor shall provide as-built detailed drawings, NDT results, and procedures/materials used to the Engineer for inclusion in the project file.
- 6.4 **Welds.** Field or shop welds that are unacceptable must be repaired in accordance with AWS D1.5. Responsibility for the cost of the repair and subsequent inspection shall be at the Contractor's expense.

7.0 CONSTRUCTION STAGING AREA

Beyond the limits of acquired Right-of-Way, the Cabinet has completed environmental clearance activities on a construction staging/erection area. This area, defined as *Potential Staging Area* in the Construction Plans (Sheet S87) along the southern bank of the Cumberland River immediately west of the bridge, is available for the Contractor's use without additional environmental clearance activities required. The Contractor should note that the Cabinet has not acquired an easement for

this area. Use of the *Potential Staging Area* will require a Right-of-Entry or Construction Easement agreement between the Contractor and Landowner, and any such agreements shall be provided to the Cabinet prior to any activity or disturbance.

The Potential Staging Area has received all necessary environmental clearances. If the Contractor elects to utilize or disturb any areas outside of the Right-of-Way or *Potential Staging Area* limits, the Contractor shall submit the proposed activity and limits to the Cabinet for review. The Contractor will be responsible for performing all field investigations for archaeological, historical, ecological, and other environmental clearances for the proposed area. The Contractor shall use KYTC pre-qualified firms for the work performed. The results of these investigations shall be provided to the Cabinet for coordination with the appropriate Agencies to evaluate and provide environmental clearance for the proposed area. Outside of the *Potential Staging Area*, it is the Contractor's responsibility to provide a staging/erection area that meets all environmental requirements and/or any commitments that result from clearance activities at no additional cost to the Cabinet.

8.0 NAVIGATION CONSIDERATIONS

The Contractor shall comply with all requirements of the US Coast Guard Bridge Permit and any subsequent Coast Guard requirements providing during approvals of Contractor submittals to the Coast Guard. These submittals may include, at a minimum, any Cofferdam Plans, Construction/Falsework Plans, and Demolition Plans.

While developing the work plans noted above, the Contractor is advised that the USCG will require a continuous helper boat during all activities that involve the Contractor utilizing construction equipment in the river. Thus, if the Contractor elects to perform construction activities for Piers 3 or 4, or utilize a truss erection scheme, that relies on a marine floating plant, a helper boat with pilot must be provided upon request by and at the discretion of the commercial barge pilots transiting under the bridge. The equivalent utility of an 1800 horsepower tow boat shall be provided. The helper boat may be used by the Contractor for other construction activities but shall be made available to assist tows when requested without delay to the needs of commercial navigation. The helper boat shall be moored or docked on-site, or within one mile of the project site, at all times. Additional requirements may be provided by KYTC or the USCG upon review of any plan that requires a helper boat.

The project limits are located in a tight S-curved section of the Cumberland River that can be challenging to navigation. Commercial navigation often utilizes most of the width of the river to traverse the project site. The Contractor may utilize temporary shoring or falsework to erect the truss. The Contractor is advised that the USCG will likely not allow falsework or shoring towers to be placed in a manner that reduces the current navigation clearance.

9.0 MEASUREMENT

The cost of fabricating, furnishing and installing the truss span superstructure, including truss main members, connections, floor beams, stringers, bracing, and truss disc bearing masonry plates and

masonry plate studs; and all material, labor, equipment, tools and incidentals necessary to complete the work as specified in the Contract Documents; shall be included in the lump sum unit price for Structural Steel. The cost of performing environmental clearance activities required for a staging/erection area outside of that previously cleared for the project shall be included in the lump sum unit price for Structural Steel. Impacts to the project schedule related to any additional environmental clearance coordination shall be the responsibility of the Contractor.

As noted on Sheet S87 and the SPECIAL NOTE FOR MITIGATION OF IMPACTS TO THE CUMBERLAND RIVER IN ACCORDANCE WITH THE BIOLOGICAL OPINION CONCERNING FAT POCKETBOOK MUSSELS, all work associated with meeting environmental commitments for any staging area shall be included in the lump sum unit price for Structural Steel. This includes backfilling excavated/dredged areas, grading backfilled areas to original ground conditions, and providing slope protection of backfilled areas.

10.0 PAYMENT

<u>Code</u>	<u>Pay Item</u>	<u>Pay Unit</u>
08160	STRUCTURAL STEEL	LS

SPECIAL NOTE FOR STEEL PAINT COLOR

Livingston County
Item No. 1-1142
US 60 Bridge over Cumberland River – Drawing No. 27458

Clean and paint the steel truss in accordance with the plans and specifications. The final color shall be “Kentucky Blue” (Federal Standard 595B Color X5095) and meet the requirements of Section 821 of the Standard Specification. The cost of painting the truss shall be included in the lump sum bid price for Structural Steel.

SPECIAL NOTE FOR STRUCTURE LIGHTNING PROTECTION

Livingston County Item No. 1-1142 US 60 Bridge over Cumberland River – Drawing No. 27458

1.0 DESCRIPTION AND SCOPE OF WORK

- 1.1 Perform all work in accordance with the Kentucky Transportation Cabinet, Department of Highway's 2019 Standard Specifications for Road and Bridge Construction and applicable Supplemental Specifications, the Standard Drawings, this Note, and the attached detail drawings. Section references are to the Standard Specifications.
- 1.2 This work shall include the design, furnishing and installation of a complete structure lightning protection system on the truss. At a minimum the following work is included:
 - 121 Design of a Lightning Protection System meeting the requirements of the Specifications, Plans and this Special Note.
 - 122 Preparation and submittal for approval of shop drawings for Structure Lightning Protection System.
 - 123 Furnishing all labor, materials, tools, and equipment necessary for installation of Structure Lightning Protection System.
 - 124 Any other work specified as part of this contract.

2.0 GENERAL

The Structure Lightning Protection for the truss bridge superstructure shall be in accordance with the latest edition of ANSI/NFPA 780 lightning protection installation standards, ANSI/UL 96 lightning protection components and UL96A installation requirements for lightning protection systems. Protection shall include, but not be limited to air terminals, bonding, interconnecting conductors, and grounding as required under the provisions of UL 96A, NFPA 780, and as specified in excess of the referenced standards herein.

3.0 DESIGN

- 3.1 The contractor shall design and prepare calculations and shop drawings for the Structure Lightning Protection System. All design documents shall be stamped by a Professional Engineer registered in the State of Kentucky. Design calculations and shop drawings shall be submitted to the engineer for review and approval. The contractor shall receive engineer's approval prior to purchasing any materials or equipment for the Structure Lightning Protection System.

- 3.2 The Lightning Protection System shall be designed to continue to function after the design seismic event. During this event the truss at Pier 4 can be anticipated to move 8.0 inches longitudinally relative to the Pier.
- 3.3 At a minimum, the structure shall be grounded at each of the main bearings at Pier3 and Pier 4. A grounding conductor shall run down through the pier columns and footing encased in the concrete. Separate ground connections shall be made at the base of the piers for each grounding conductor.
- 3.4 No welding will be allowed on any truss members or plates designated as fracture critical. All other welding must be approved by the engineer. Only welding as shown on the approved shop drawings will be allowed.

4.0 MATERIALS

- 4.1 All materials shall comply in weight, size and composition with the requirements of the Underwriters' Laboratories, Inc., the National Fire Protection Association Code and OSHA relating to the height of the structure.
- 4.2 All rods, cables, ground rods, and connectors used in the system shall carry an UL Label "A" & "B" and all lightning air terminals shall carry the Manufacturer's name.
 - 4.2.1 Conductors: Conductors shall consist of commercially pure copper cable, sized in accordance with NFPA Code.
 - 4.2.2 Conductor Fasteners: Conductor fasteners shall be an approved type of noncorrosive metal having ample strength to support conductor.

5.0 INSTALLATION

5.1 General

- 5.1.1 All ungrounded sizable metallic objects within 6' of the truss or metal connected to the trusses shall be bonded to the system with approved fittings and conductors.
- 5.1.2 Copper materials connecting to steel shall be lead-coated.
- 5.1.3 Connection between metals shall be made with approved exothermic welds.
- 5.1.4 All materials shall be fastened to eliminate any possibility of displacement and subsequent maintenance.

5.2 Air Terminals

- 5.2.1 Air terminals shall be approved type extending not less than 10 inches above the top chord of the truss and shall be securely anchored.
- 5.2.2 Air terminals shall not extend higher than 24 inches except with individual approval or as required by OSHA. Terminals 23 inches and less shall be spaced 20 feet apart.

5.2.3 Terminals 24 inches and higher shall be spaced 25 feet apart or as required by codes.

5.3 Conductors: Conductors shall be run concealed.

5.4 Conductor Fasteners: Space 3'-0" O.C. max.

5.5 Ground Connection

5.5.1 Lay out an extensive wire network on the surface of the rock surrounding the abutment and pier footings, consisting of ring, radial, and/or plate electrodes. Other grounding will be permitted, providing it will pass UL requirements.

6.0 MEASUREMENT

Structure Lightning Protection. Measurement will be lump sum and include the design, shop drawing preparation, and installation of the Structure Lightning Protection.

7.0 PAYMENT

Structure Lightning Protection. Payment at the contract unit price is full compensation for contractor to design, prepare shop drawings, and to provide all materials, labor, equipment, tools, and incidentals necessary to complete the work as specified by this note.

The Department will consider payment as full compensation for all work required by this note.

SPECIAL NOTE FOR WEB CAMERA CONST MONITORING SYSTEM

Livingston County Item No. 1-1142 US 60 Bridge over Cumberland River

1.0 GENERAL

1.1 RELATED DOCUMENTS

Drawings and general provisions of the Contract, including General and Supplementary Conditions and Division 1 Specification Sections, apply to this Section.

1.2 SUMMARY

Section includes an integrated, professional-grade, high resolution digital webcam system designed specifically for the construction industry as a turnkey package including camera(s) and related hardware, mounting equipment, software, wireless cellular data transmission service, website hosting, image hosting and storage, online interface for the system and technical support.

Related Sections:

1. Division 1 Section "Photographic Documentation" for periodic construction photographs.
2. Division 1 Section "Closeout Procedures" for submitting digital photographs as Project Record Documents at Project closeout.

1.3 DEFINITIONS

CCD: Charge-coupled device.

System Vendor: Provider of camera system hardware and software and host maintaining off-site server, data storage devices, and troubleshooting software and equipment. Contractor shall maintain an active contract for System Service for duration of Contract Time unless other term is agreed upon in writing by the Owner. Cost for System Service shall be included in the Contract Sum.

System Service: Host services provided by System Vendor including image acquisition, transfer, backup, periodic upgrades to the system, viewing access via a maintained interface on the Internet and on-line storage of images for duration of the Service Contract.

1.4 SUBMITTALS

1.4.1 SHOP DRAWINGS

Submit key plan of Project site with notation of vantage points marked for location and direction of each camera. Indicate camera mounting heights relative to ground or bridge deck elevation.

1.4.2 QUALITY ASSURANCE SUBMITTALS

Follow manufacturer's installation and testing instructions.

1.4.3 CLOSEOUT SUBMITTALS

Digital Images: Submit digital still images exactly as originally recorded in the digital camera, without alteration, manipulation, editing, or modifications using image-editing software. Include date and time in filename for each image. Submit a sortable/identifiable archive of all digital still images on an external hard drive or DVD format.

Time-Lapse "Movie": Compile select digital still images into a time-lapse movie of the construction period. Optimize images included and run-time length of movie to suit Owner's requirements.

1.5 QUALITY ASSURANCE

Electrical Components: Listed and labeled as defined in NFPA 70, by a qualified testing agency, and marked for intended location and application. Factory assemble camera system from components bearing UL Classification Marking indicating that materials have been produced under UL's Classification and Follow-Up Service.

Comply with NECA 1, "Standard Practices for Good Workmanship in Electrical Construction."

Comply with NFPA 70, "National Electrical Code."

Manufacturer Qualifications: Company specializing in manufacturing Products specified in this Section with minimum five years documented experience.

1.6 DELIVERY, STORAGE, AND HANDLING

Deliver materials in original packages and containers with seals unbroken and bearing manufacturer's labels.

Store materials to comply with manufacturer's directions to prevent deterioration from moisture, heat, cold, direct sunlight, or other causes.

1.7 PROJECT CONDITIONS

Environmental Conditions: Capable of withstanding the following environmental conditions without mechanical or electrical damage or degradation of operating capability:

- System components installed in location exposed to weather shall be rated for continuous operation in ambient temperatures of minus 10 to plus 120 deg F dry bulb and 20 to 90 percent relative humidity, condensing. Rate for continuous operation when exposed to rain as specified in NEMA 250, winds up to 85 mph. NEMA 250, Type 3R enclosures.

1.8 COORDINATION

Coordinate installation of cameras so that system is fully operational prior to commencement of construction operations.

Coordinate layout and installation of cameras to avoid interference from trees or other obstructions and to prevent sunlight and light from fixtures entering directly into the camera lens.

Coordinate layout and installation of cameras to avoid interference with construction operations.

1.9 WARRANTY

Special Warranty: Manufacturer's standard form in which manufacturer agrees to repair or replace components of cameras and equipment related to camera operation that fail in materials or workmanship within specified warranty period. Failures include, but are not limited to, the following:

- Failure of system to meet performance requirements.
- Faulty operation of hardware and software.
- Defects in other components of the work.

Warranty Period: Lifetime product warranty required

1.10 USAGE RIGHTS

Obtain and transfer copyright usage rights to Owner for unlimited reproduction of photographs and archives generated by the system.

Contractor shall understand that photographs and archives generated by the camera system become the mutual property of the Owner and System Vendor and cannot be used for advertisement or publicity reasons without the expressed written consent of the Owner and System Vendor.

1.11 MAINTENANCE

Maintenance Service: Provide service and maintenance of camera system for entire Construction period.

- Examine monthly; clean and adjust equipment.
- Provide remote emergency repair services by System Vendor 24 hours a day, seven days a week to ensure uninterrupted camera service. Provide personnel on-site to assist System Vendor as needed during working hours. Provide replacement parts and components due to system failure, damage, or theft within two business days.
- Maintenance service shall not be assigned or transferred to another agent or subcontractor without prior written consent of Owner.
- Require System Vendor to proactively monitor the system by means of service and maintenance contract. If no connection is made within a span of time not to exceed 24 hours during regular business days, require System Vendor to notify Contractor and commence troubleshooting. Provide necessary staff during troubleshooting to verify power availability, to remove and replace system, and to verify functioning phone lines or internet access for dialup and Ethernet based systems.

2.0 PRODUCTS

2.1 MANUFACTURERS

Manufacturers: Subject to compliance with requirements, provide products by the following:

- OxBlue, Inc., 888-849-2583, <http://www.OxBlue.com/>.
- EarthCam, Inc., 800-327-8422, <http://www.EarthCam.net>

Substitutions: As approved by the Owner

2.2 SYSTEM REQUIREMENTS

The indoor/outdoor camera system shall consist of a tamper and impact resistant, discreet, fixed pole or wall-mount enclosure with integrated fixed camera, lens and controller.

The cameras shall have the ability to take a high-resolution **8.0 Megapixel** digital still images of the construction site at a set time interval, every 15 minutes, and upload the still images over a wireless cellular modem to a secure, password-protected website.

2.3 EQUIPMENT

Camera: Integrated high definition camera and lens assembly consisting of a charge coupled device (CCD) camera with a remotely controlled focal length lens mounted

as a permanent module with the following features:

- Digital Still Image Resolution: Minimum sensor size of **8.0 megapixels**, and at an image resolution of not less than 3264 x 2448 pixels.
- Memory: Unlimited remote storage provided by the system vendor.
- Lens: System capable of optical zoom and production of wide angle images to provide sufficient coverage and detail of the construction site as required by the Owner.
- Focus Mode: iESP auto, Spot AF, Selective AF target, Manual.
- Metering Mode: Digital iESP multi-pattern auto TTL, Spot metering, Center Weighted metering.
- Data Connection: Provide one of the following:
 - In areas with cellular coverage, operate cameras via built-in cellular data connection provided and maintained by the system vendor.
 - In areas without cellular coverage, operate cameras via and RJ-45 Ethernet data connection over broadband or satellite internet access provided and maintained by the Contractor.
- Electrical Operation: 120 VAC at maximum 83 Watts.

Quantity of Cameras: Four (4)

Camera Enclosure: Construct tamper and impact resistant housing of extruded aluminum, die cast aluminum, and sheet aluminum body with factory-applied powder coated finish. Construct with forward opening, front hinged lid, allowing easy access to camera mounting sled. Provide rear link-lock latch, manufactured from stainless steel, suitable for use with pad lock. Equip with heater, blower and thermostat.

2.4 INTERFACE AND ONLINE ACCESS

Remote Access: Contractor's System Vendor shall provide an online interface system to allow viewing of all high-definition digital still images captured and stored during construction, from any location with internet access and with password protection. Maintain images on the System Vendor's website for reference available at all times during construction and for not less than 90 days after Final Completion.

Online Interface:

- The online interface system shall be accessible by an unlimited number of human users.
- System shall display Project name and Owner Logo.
- The system shall display online time-lapse videos and allow for videos to be downloaded by users.
- Navigation: Provide calendar based navigation system for selecting specific images.
- Zoom: Provide pan and zoom capability for zooming into high definition

images.

- User Screen Viewing Options:
 - Dynamic Calendar: Provide screen showing calendar in which each day displays an image for that day.
 - Project Dashboard: Provide screen allowing user to view multiple sites at one time.
 - Quad View: Provide screen showing four windows, allowing user to view last four days, weeks, or months on one screen.
 - Split Screen: Provide screen showing two discrete images side by side, from same camera or from two different cameras.
 - Overlay Mode: Provide screen showing two discrete images overlaid, allowing user to determine differences between the two.
 - Full-Screen: Provide screen maximizing view of images on users monitor.
- Email: Provide capability to email photos with comments from within the system.
- Slideshow: Provide capability to browse through images, moving forward and backward in time by individual image and by day.

3.0 EXECUTION

3.1 PREPARATION

Unpack camera system components and save packing materials (box and foam) for future shipment of camera system including associated appurtenances and mounting equipment to Owner or Manufacturer as required.

3.2 INSTALLATION

General:

- Install camera system in accordance with manufacturer's printed instructions, State and Municipality codes and requirements and approved submittals. The Owner shall have final approval of all camera locations.
- Install units plumb and at proper angle to provide maximum field of view of on-site operations.
- Securely and rigidly anchor products in place.
- Connect cameras to power.

Location: Cameras shall be located to provide coverage of full bridge site including staging areas without any "blind spots".

- One (1) camera shall be located at the south end of the new bridge to capture construction of the south approach spans.
- One (1) camera shall be located on the south end of the new truss to capture construction of the south approach spans, main span, and potential staging area.

- One (1) camera shall be located on the north end of the new truss to capture construction of the north approach spans and main span.
- One (1) camera shall be located at the north end of the new bridge to capture construction of the north approach spans.
- The Owner shall have final approval of all camera locations.

Relocate camera as directed by Owner during construction progress. Each camera may be relocated up to two (2) times prior to Final Completion. Camera positions may include attachment to existing construction, new construction and temporary facilities.

Position camera so that the field of view of each camera covers the intended area of the project site. Install camera at elevation that will provide uncompromised visual coverage. Install camera so that position of sun or man made light sources will not come into direct contact with field of view of camera at any time.

3.3 FIELD QUALITY CONTROL

Preinstallation Testing: Test camera on site at ground level prior to mounting unit in its intended elevated position. Test shall follow the following sequence:

- Contact System Vendor not less than 24 hours in advance of installation for testing.
- Connect unit.
- After 30 minutes contact System Vendor and require System Vendor to remotely confirm camera is operating properly.
- Install cameras in approved locations.

3.4 CLEANING

Clean installed items using methods and materials recommended in writing by manufacturer.

Clean camera system components, including camera-housing windows, lenses, and monitor screens.

3.5 INSTRUCTION

Engage a factory-authorized service representative by phone to instruct Contractors personnel in procedures to adjust and maintain camera equipment. Instruct personnel on procedures and schedules for troubleshooting and maintaining equipment. Explain methods of determining optimum alignment and adjustment of components.

3.6 OPERATION, TERMINATION, AND REMOVAL

Maintenance: Maintain camera equipment in good operating condition on a 24-hour basis until removal.

Termination and Removal: Remove camera system after Final Completion of the project and with approval from Owner. Complete or, if necessary, restore permanent construction that may have been delayed because of interference with camera system. Repair damaged Work, clean exposed surfaces, and replace construction that cannot be satisfactorily repaired. Camera system including associated appurtenances and mounting equipment are property of the Owner.

3.7 METHOD OF MEASUREMENT

When WEB CAMERA CONST MONITORING SYSTEM is included in the Bid Proposal as a separate bid item, the Department will measure the work performed as part of providing WEB CAMERA CONST MONITORING SYSTEM as a lump sum.

3.8 PAYMENT

The Department will pay for the quantities at the contract unit price. When WEB CAMERA CONST MONITORING SYSTEM is included in the Bid Proposal as a separate bid item the Department will make partial payments for WEB CAMERA CONST MONITORING SYSTEM in two (2) equal or approximately equal payments.

- 50 percent after the system is installed and fully operational.
- 50 percent after all Closeout Submittals have been submitted and accepted by the Department.

The Department will consider payment as full compensation for all work required under this section. Payment will be made under the following:

<u>Bid Item Code</u>	<u>Pay Item</u>	<u>Pay Unit</u>
23912EC	WEB CAMERA CONST MONITORING SYSTEM	LS

U.S. Department of
Homeland Security

UNITED STATES
COAST GUARD



28 JAN 2020

BRIDGE PERMIT

(4-19-8)

WHEREAS by Title V of an act of Congress approved August 2, 1946, entitled "General Bridge Act of 1946," as amended (33 U.S.C. 525-533), the consent of Congress was granted for the construction, maintenance and operation of bridges and approaches thereto over the navigable waters of the United States;

AND WHEREAS the Secretary of Homeland Security has delegated the authority of Section 502(b) of that act to the Commandant, U.S. Coast Guard by Department of Homeland Security Delegation Number: 0170.1;

AND WHEREAS before construction is commenced, the Commandant must approve the location and plans of any such bridge and may impose any specific conditions relating to the construction, maintenance and operation of the structure deemed necessary in the interest of public navigation, such conditions to have the force of law;

AND WHEREAS the Commandant of the Coast Guard has further delegated to the District Commanders, by Section 1.01-60(b) of Title 33, Code of Federal Regulations, authority to issue permits of the construction, reconstruction, or alteration of bridges across navigable waters of the United States.

AND WHEREAS the - **STATE OF KENTUCKY** - has submitted for approval the location and plans of a bridge to be constructed across the Cumberland River at Smithland, Livingston County, Kentucky;

NOW THEREFORE, This is to certify that the location and plan sheets 1, 2, 3 and 4 (of 4) dated October 25, 2019 are hereby approved by the Commander, Eighth Coast Guard District, subject to the following conditions:

1. No deviation from the approved plans may be made either before or after completion of the structure unless the modification of said plans has previously been submitted to and received the approval of the District Commander.

2. The construction of falsework, pilings, cofferdams or other obstructions, if required, shall be in accordance with plans submitted to and approved by the District Commander, prior to construction of the bridge. All work shall be so conducted that the free navigation of the waterway is not unreasonably interfered with and the present navigable depths are not impaired. Timely notice of any and all events that may affect navigation shall be given to the District Commander during construction of the bridge. The channel or channels through the structure shall be promptly cleared of all obstructions placed therein or caused by the construction of the bridge to the satisfaction of the District Commander, when in the judgment of the District Commander the construction work has reached a point where such action should be taken, but in no case

28 JAN 2020

Continuation Sheet

Bridge across the Cumberland River
at Smithland, Kentucky

BRIDGE PERMIT

P(4-19-8)

later than 90 days after the bridge has been opened to traffic.

3. Issuance of this permit does not relieve the permittee of the obligation or responsibility for compliance with the provisions of any other law or regulation as may be under the jurisdiction of any federal, state or local authority having cognizance of any aspect of the location, construction or maintenance of said bridge.

4. A bridge fendering system shall be installed and maintained in good condition by and at the expense of the owner of the bridge when so required by the District Commander. Said installation and maintenance shall be for the safety of navigation and be in accordance with plans submitted to and approved by the District Commander prior to its construction.

5. Clearance gauges shall be installed and maintained in a good and legible condition by and at the expense of the owner of the bridge when so required by the District Commander. The type of gauges and the location in which they are to be installed will be submitted to the District Commander for approval.

6. All parts of the existing to-be-replaced US 60 Highway Bridge across the Cumberland River, mile 2.8, not utilized in the new bridge, which are located within the waterway shall be removed down to five feet below grade or elevation 284.0 feet NAVD 88, whichever is lower. All other parts shall be removed down to two feet below the mudline or below the natural ground line. The waterway shall be cleared to the satisfaction of the District Commander. A period of 90 days subsequent to the opening to traffic of the new US 6- Highway Bridge, mile 2.8, will be allowed for such removal and clearance. The proposed method and schedule for removal of the existing bridge shall be submitted to the District Commander for approval prior to commencing such removal.

7. When the proposed bridge is no longer used for transportation purposes, it shall be removed to an elevation deemed appropriate by the District Commander and the waterway cleared to the satisfaction of the District Commander. Such removal and clearance shall be completed by and at the expense of the owner of the bridge upon due notice from the District Commander.

8. The approval hereby granted shall cease and be null and void unless construction of the bridge is commenced within three years and completed within five years after the date of this permit.



John P. Nadeau
Rear Admiral U.S. Coast Guard
Commander, Eighth Coast Guard District

ENCLOSURE (2)

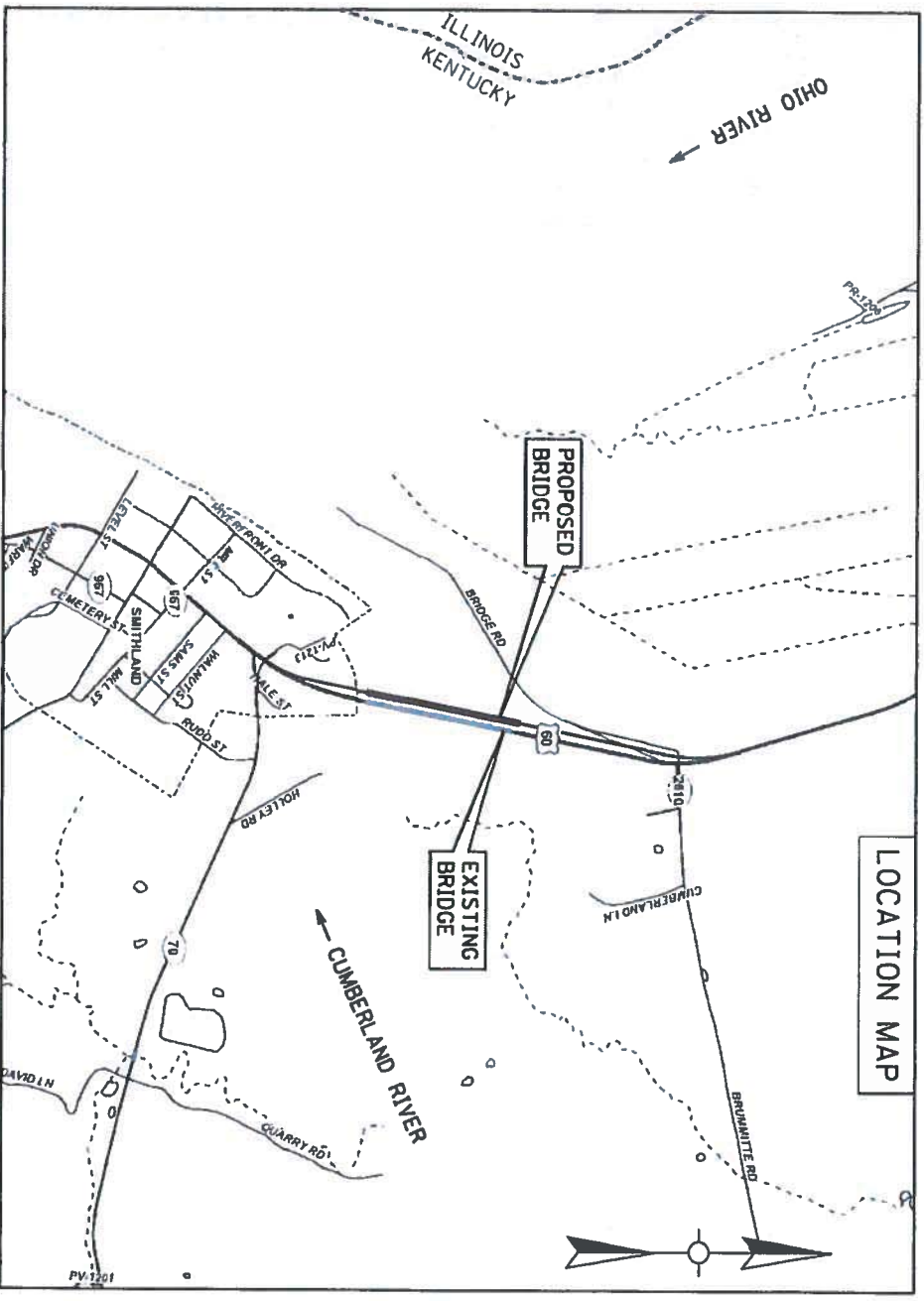
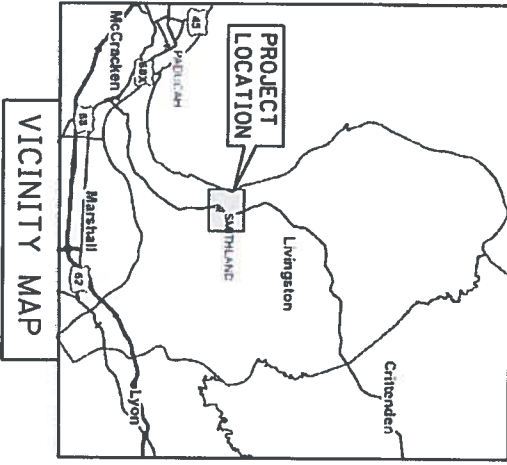
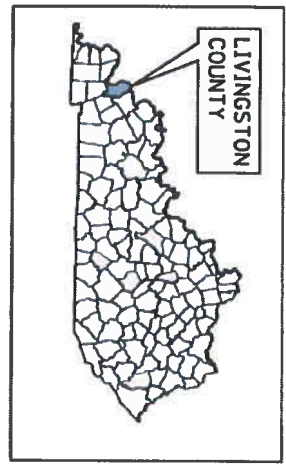

10/25/2019



NOTE: CONCEPTUAL PLANS UTILIZED TO OBTAIN COAST GUARD BRIDGE PERMIT

PROPOSED BRIDGE
US 60 OVER CUMBERLAND RIVER
AT SMITHLAND, LIVINGSTON COUNTY, KENTUCKY
RIVER MILE 2.8
APPLICANT/OWNER: KENTUCKY TRANSPORTATION CABINET
CONSULTANT/AGENT: STANTEC
DATE: OCT 25, 2019
SHEET 1 OF 4

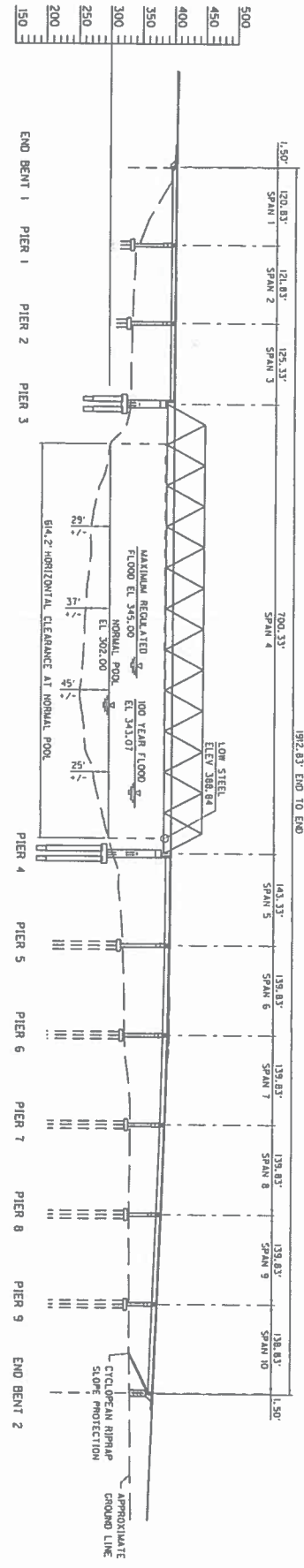
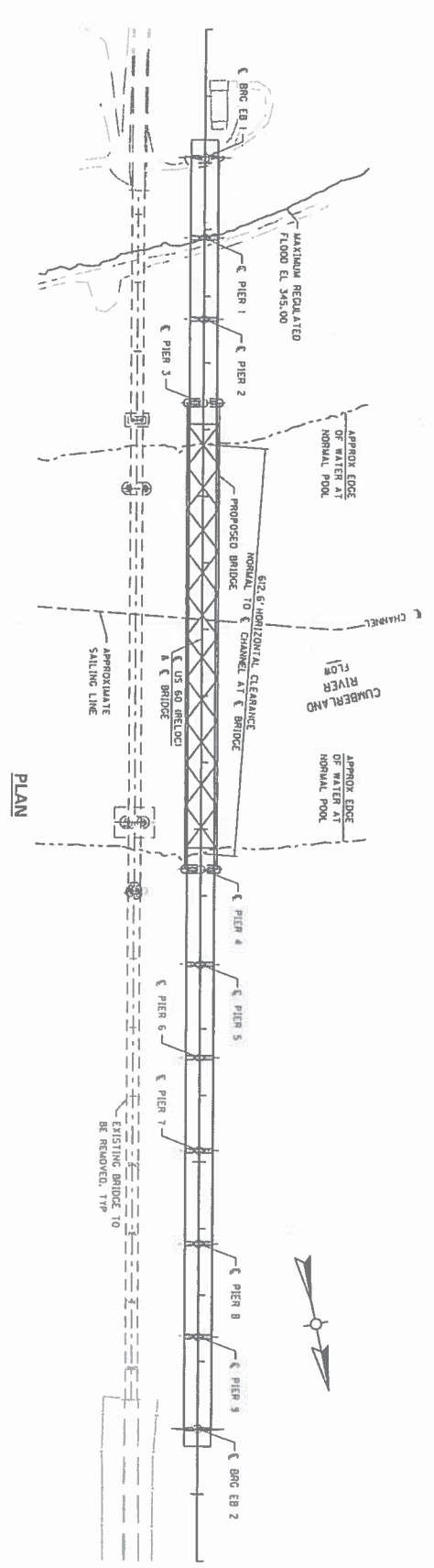

NOTE:
ALL ELEVATIONS ARE BASED ON NAVD 88 DATUM.

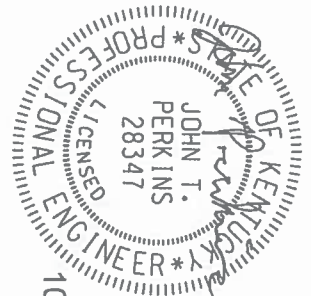

10/25/2019

PROPOSED BRIDGE
US 60 OVER CUMBERLAND RIVER
AT SMITHLAND, LIVINGSTON COUNTY, KENTUCKY
RIVER MILE 2.8

APPLICANT/OWNER: KENTUCKY TRANSPORTATION CABINET
CONSULTANT/AGENT: STANTEC

DATE: OCT 25, 2019

SHEET 2 OF 4

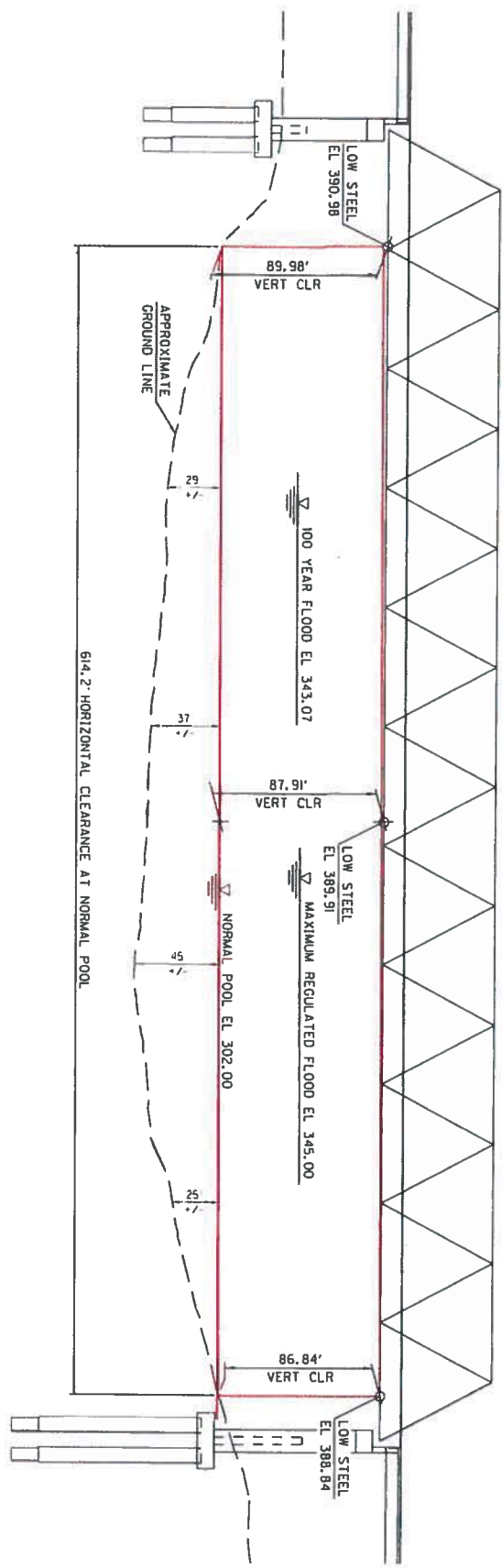

PIER 3

PIER 4

ELEVATION - NAVIGATION SPAN

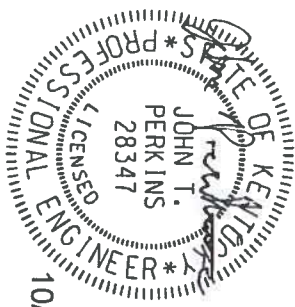

10/25/2019



NOTE:
ALL ELEVATIONS ARE BASED ON NAVD 88

PROPOSED BRIDGE
US 60 OVER CUMBERLAND RIVER
AT SMITHLAND, LIVINGSTON COUNTY, KENTUCKY
RIVER MILE 2.8
APPLICANT/OWNER: KENTUCKY TRANSPORTATION CABINET
CONSULTANT/AGENT: STANTEC
DATE: OCT 25, 2019
SHEET 3 OF 4

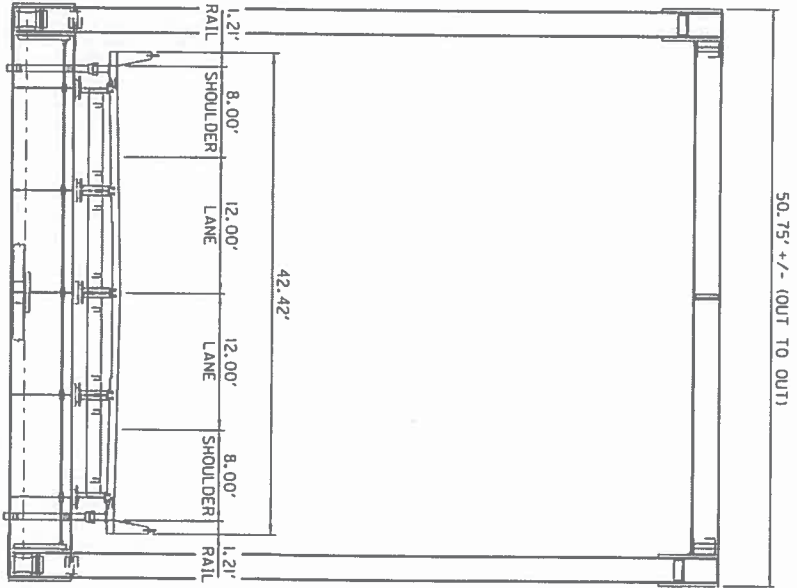

TYPICAL SECTION SPAN 4

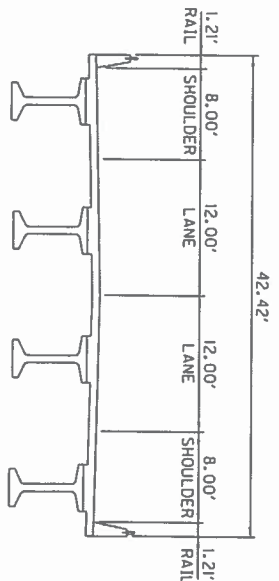

TYPICAL SECTION SPANS 1 THRU 3
AND 5 THRU 10

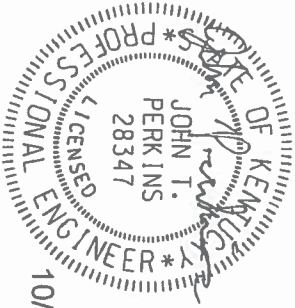

10/25/2019



PROPOSED BRIDGE
 US 60 OVER CUMBERLAND RIVER
 AT SMITHLAND, LIVINGSTON COUNTY, KENTUCKY
 RIVER MILE 2.8

APPLICANT/OWNER: KENTUCKY TRANSPORTATION CABINET
 CONSULTANT/AGENT: STANTEC

DATE: OCT 25, 2019

SHEET 4 OF 4

SPECIAL NOTE FOR PROJECT SPECIFIC DRILLED SHAFT REQUIREMENTS

Livingston County – US 60 Bridge over the Cumberland River Item No. 1-1142.0

1.0 DESCRIPTION

This special note is a supplement to the Standard Special Note for Drilled Shafts (11C), and includes drilled shaft requirements specific to Piers 3 & 4 on this project. In the case of conflicts with the standard Special Note for Drilled Shafts (11C), this Special Note for Project Specific Drilled Shaft Requirements will control.

2.0 DRILLED SHAFT CONSTRUCTION SEQUENCE

At Pier 3, begin rock construction (i.e. rock drilling through concrete placement) at one of the interior shafts (i.e. 3C, 3D, 3E or 3F). Likewise, at Pier 4 begin rock construction at one of the interior shafts (4C, 4D, 4E or 4F). The specified construction sequence does not apply to activities prior to rock drilling (e.g. casing installation and overburden excavation).

Construction of the first drilled shaft at each pier will be used to evaluate whether the methods and equipment used by the Contractor are sufficient to produce a completed drilled shaft meeting the requirements of the plans and specifications. The Department will evaluate the Contractor's ability to satisfactorily execute any necessary construction operations and meet required tolerances during construction of the first shaft at each pier. Revise the methods and equipment as necessary to satisfactorily construct the drilled shafts within tolerances.

Non-destructive testing reports, including Sonar Caliper (SC) Field Reports and SC Preliminary Reports (but not the SC Final Reports), Thermal Integrity Profiling (TIP) Test Reports and initial Crosshole Sonic Logging (CSL) Test Reports (but not 28-day CSL reports) for the first drilled shaft completed at each pier must be submitted and accepted before beginning rock drilling activities on any exterior drilled shafts at that pier (i.e. 3A, 3B, 3G & 3H or 4A, 4B, 4G & 4H as applicable). This includes completion and acceptance of any corrective items that are a result of failed materials tests, non-destructive testing results, or out-of-tolerance measurements. Account for delays to complete non-destructive testing, corrective work, and review time for acceptance in the schedule and bid prices. Proceed with rock construction on other interior shafts during evaluation of the first shaft at the same pier unless directed otherwise by the Engineer due to significant problems encountered during construction of the first shaft.

A post-construction meeting may be required after the successful completion of the first shaft at each pier and prior to the beginning of rock excavation of the second shaft. Once acceptance has been given to construct subsequent shafts in a pier (after complete evaluation of the first shaft at the same pier) no changes will be permitted in the methods or equipment used to construct the satisfactory shaft without written approval of the Engineer. Proceed with rock construction at exterior shafts only with written notification by the Engineer.

Livingston County Item No. 1-1142.0
US 60 over Cumberland River

3.0 SUPERVISOR'S DRILLED SHAFT CONSTRUCTION EXPERIENCE

Provide a drilled shaft superintendent or foreman in responsible charge of all drilled shaft operations with a minimum of 5 years' experience constructing drilled shaft foundations and experience with similar shaft lengths, shaft diameters, subsurface conditions, and construction techniques to be used on this project.

As part of the Drilled Shaft Installation Plan, submit documentation containing names and current phone numbers of owners' representatives who can verify the supervisor's successful participation in at least three (3) total drilled shaft projects, including two (2) projects in each of the categories below. Some or all of the experience may be with a previous employer. If necessary, more than one drilled shaft superintendent or foreman may be used to meet the requirements if all are actively involved in the project. However, one person must be designated as the contact for drilled shaft operations between the Contractor and the Department. It is not necessary that any one project satisfy both criteria below, but at least two (2) projects from each category are required.

1. Constructing rock socket drilled shafts with total depths of 40 feet or deeper, with rock socket diameters 5.0 feet or larger
2. Using polymer slurry in drilled shafts (required for supervisor of Pier 3 shafts, but not for Pier 4 shafts)

The Engineer may suspend drilled shaft construction if supervisory personnel meeting the requirements above are not present or performance is unsatisfactory. Any cost associated with the suspension of work will be at no expense to the Department and with no extension of contract time.

4.0 PRE-CONSTRUCTION SUBMITTALS

No later than 45 calendar days prior to beginning drilled shaft construction, submit a Drilled Shaft Installation Plan for review by the Department. Final acceptance will be subject to satisfactory performance in the field. Include detailed information such as the following:

- a) List and size of proposed equipment including cranes, drills, augers, bailing buckets, final cleaning equipment, desanding equipment, slurry pumps, core sampling equipment, tremies or concrete pumps, casings, etc.
- (b) Details of overall construction operation sequence and the sequence of shaft construction.
- (c) Details of shaft excavation methods and method that will be used to ensure that the rock socket is centered.
- (d) Details of casing to be used including calculations showing ability of casing to withstand anticipated hydraulic and earth pressures and to withstand stresses due to installation without undue deformation. These details shall include methods for casing handling, splicing, straightening, and out-of-round correction with any associated timetables.

Livingston County Item No. 1-1142.0
US 60 over Cumberland River

- (e) Details of slurry. See requirements for Slurry Submittals in Section 9.
- (f) Details of proposed methods to clean shaft and inside of casing after initial excavation.
- (g) Details of reinforcement handling, lifting, and placement including support and method to center in shaft, must include rebar cage support during concrete placement.
- (h) Details of concrete placement including proposed operational procedures for concrete tremie or pump including initial placement, raising during placement, and overfilling of the shaft to expel contaminated concrete.
- (i) Details of casing removal if contractor chooses to remove casing.
- (j) Required submittals including shop drawings and concrete design mixes.
- (k) Other information shown in the plans or requested by the Engineer.
- (n) Special considerations for wet construction.
- (o) Details of environmental control procedures to protect the environment from discharge of excavation spoil, dry polymer slurry and concrete overpour.
- (p) Method for measuring and determining vertical and horizontal alignment during construction.
- (q) How Disposal of excavated material.
- (r) Proposed method to provide inspectors access to the top of casing to inspect shafts.

Within 15 business days after receipt of the plan, the Department will notify the contractor of any additional information required and/or changes necessary to meet the contract requirements. A "Business Day" is defined as any day except Saturdays, Sundays and Holidays, as defined in Section 101.03 of the Standard Specifications. Any part of the plan that is unacceptable will be rejected and the Contractor will be required to submit changes agreed upon for reevaluation. The Department will notify the Contractor within five (5) business days after receipt of proposed changes of their acceptance or rejection. All procedural acceptance by the Department is subject to trial and satisfactory performance in the field and does not relieve the contractor of the responsibility to satisfactorily complete the work as detailed in the plans and specifications. Begin construction on any items affected by the Drilled Shaft Installation Plan only after the plan has been accepted by the Department. Delays due to resubmission of the Drilled Shaft Installation Plan will be at no additional cost to the Department and with no extension of contract time.

5.0 DRILLED SHAFT PRE-CONSTRUCTION MEETING

A pre-construction meeting to discuss drilled shaft construction will be required no later than 30 calendar days prior to the beginning of drilled shaft construction. The purpose of the meeting is to discuss construction procedures, personnel, and equipment to be used. The following are required to attend:

1. Representing the Contractor – Project Superintendent, Drilled Shaft Superintendent or Foreman, and Foreman in charge of the following operations (if different than the Drilled Shaft Superintendent or Foreman): placing casing, excavating shafts, mixing slurry, tying and setting steel reinforcement, and pumping and placing concrete.

Livingston County Item No. 1-1142.0
US 60 over Cumberland River

2. Representing the Department – Drilled Shaft Inspector(s), Section Engineer, Central Office Construction Engineer, Geotechnical Branch representative(s) and others as deemed appropriate by the Section Engineer.

If the Contractor's key personnel change or if the Contractor proposes a significant revision to drilled shaft construction procedures, an additional drilled shaft pre-construction meeting may be required at the discretion of the Engineer.

6.0 EQUIPMENT

Perform the excavations required for the shafts through materials encountered to the dimensions and elevations shown in the plans. Use methods and equipment suitable for the intended purpose and the materials encountered. Due to the potential for the need to lower shaft tip elevations, provide equipment capable of constructing shafts to a tip elevation of 220 ft. (approximately 20 ft. below plan tip elevation) at Pier 3 and tip elevation 182 ft. (approximately 10 ft. below plan tip elevation) at Pier 4.

7.0 CONSTRUCTION METHOD

Construct drilled shafts as indicated in the plans or described in this Special Note. Propose a construction method on the basis of its suitability to the site conditions and submit it in the Drilled Shaft Installation Plan for review and acceptance by the Engineer. Provide for casing from the top of the rock socket to at least 5 feet above the water level when the shaft is poured. Remove any temporary casing only after the concrete has achieved a minimum strength of 3000 psi.

8.0 TOP OF ROCK ELEVATIONS

The Department averaged the top of rock elevations encountered in the design-phase geotechnical investigation borings at each pier to estimate drilled shaft plan quantities. The Department will use the actual top of rock elevations encountered at each shaft location of the borings included in the construction contract for actual pay quantities.

Livingston County Item No. 1-1142.0
US 60 over Cumberland River

9.0 POLYMER SLURRY AT PIER 3

Shales at Pier 3 are subject to rapid degradation when exposed to water. Based on previous experience, the Department has found that using polymer slurry during rock drilling reduces the degradation of such shales.

Provide PHPA Dry Polymer Slurry to reduce degradation of shales. Provide a sufficient quantity of slurry mix meeting the material requirements, test the slurry in the tanks and in the shafts. Include all costs associated with polymer slurry in the unit bid price for "Pier 3 – Drilled Shaft – 96 inch (Common)" or "Pier 3 – Drilled Shaft – 90 inch (Solid Rock)", as applicable. Recycling of polymer slurry used during rock drilling is not permitted and the Contractor will be responsible for disposing of the slurry after use.

9.1 Slurry Submittals

As part of the Drilled Shaft Installation Plan, submit a Proposed Method of Slurry Use, including the following prepared by the Slurry Supplier:

1. a detailed slurry mix design, specific slurry properties, adequate time for hydration, and a discussion of suitability for the anticipated subsurface conditions
2. methods to mix, circulate, and desand the slurry
3. details of the proposed testing, test methods, sampling methods, and test equipment;
4. the name and current phone number of the supplier's representative for the project
5. any other information the slurry supplier deems necessary
6. a sample of the dry slurry (may be submitted separate from the Drilled Shaft Installation Plan)
7. proposed method and location to dispose of slurry

9.2 Slurry Supplier Technical Representative

Provide the services of a technical representative of the slurry supplier to be responsible for:

1. training project inspectors and contractor personnel regarding the slurry properties and proper testing procedures
2. being at the site during premixing prior to introduction of slurry into the first shaft and during the first 4 hours of rock socket drilling on the first shaft or until the mix shows consistent behavior, as determined by the Engineer
3. being available to provide technical assistance and consultation to the Contractor and/or the Department during construction of all Pier 3 shafts

Allow direct communication between the technical representative and the Department at all times.

Livingston County Item No. 1-1142.0
 US 60 over Cumberland River

9.3 Slurry Materials and Testing

Provide PHPA Dry Polymer and mix with water to form a slurry mix meeting the requirements in Table 1 below.

Table 1 – Polymer Slurry Material Requirements			
Property	Allowable Range	Units	Test Apparatus
Marsh Funnel Viscosity	> 65	sec/qt	Marsh Funnel
pH	7-10		pH paper or pH meter
Density	< 64	pcf	Density Balance
Sand Content	< 1	% by volume	API Sand Content Kit

The Contractor is responsible for providing quality control testing of the slurry to ensure conformance with the requirements specified above. Designate one person on each shift to be responsible for mixing and testing slurry. The Department’s inspection personnel may perform independent comparison testing at any time. Provide slurry testing equipment for the exclusive use project inspectors; include a carrying case which contains all equipment necessary to test the slurry properties in the table above. This testing equipment will immediately become property of the Department. Provide this testing equipment at no additional cost the Department.

A set of tests is defined as the tests included in Table 1 and performed on samples extracted from:

- one sample within 3 ft. of the shaft tip at the time of sampling
- one sample approximately midway between the bottom of casing and shaft tip at the time of sampling (unless this distance is less than 10 ft.) and
- two samples at approximate third points in the casing

At the discretion of the Engineer, sand content tests may be omitted on selected samples. Take samples using a sampling tool marked so the depth of the slurry sample can be evaluated.

Perform tests to establish a consistent working pattern taking into account the mixing process and blending of freshly mixed slurry with previously used slurry. Perform a set of tests every 2 hours during the first 8 hours of slurry use on the project. If the results show consistent behavior, as evaluated by the Engineer, after the first 8 hours, decrease the testing frequency to 1 set every 4 hours of slurry use, during drilling. Perform a set of tests immediately prior to and immediately after every drilling shift. Perform at least 2 test sets per day after drilling is complete and prior to concreting. Representatives of the Department may perform comparison tests as necessary.

Report all test results to the Engineer immediately and add additional slurry, meeting the material requirements, and/or remove slurry to adjust the mix in the shaft as needed to meet the specified requirements in Table 1. Furnish written reports of all tests required above, signed by

Livingston County Item No. 1-1142.0
US 60 over Cumberland River

an authorized representative of the Contractor, to the Engineer on completion of each drilled shaft. Include shaft number, sampling and test times and dates, sample depths and elevations, and all test results.

Sample the slurry in the tanks at a rate of at least 1 sample per 10,000 gallons (+/-10%) and perform control tests to evaluate the properties of the freshly mixed slurry as defined in Table 1. At the discretion of the Engineer, sand content tests may be omitted on selected samples. If any portion of slurry is not within the specified ranges, adjust the mix and retest at no additional cost to the Department.

9.4 Slurry Use

Prior to beginning rock excavation in any shaft, premix slurry in tanks using an approved water supply. Use water that does not have characteristics detrimental to the slurry, drilled shaft excavation, or concrete. Additives are not allowed unless approved in writing by the Engineer. Use air diaphragm pumps or other similar non-shearing mixing devices to mix the slurry and pump it into the shaft. Allow adequate time (as prescribed by the slurry supplier) for hydration prior to introduction into the shaft. Provide slurry tanks with adequate capacity for slurry mixing, circulation, storage, and treatment.

Perform a set of tests (as defined in the Slurry Materials and Testing Subsection) to determine the properties of the slurry mix in the shaft and report the values to the Engineer immediately. Add additional slurry to the shaft to adjust the mix if necessary to meet the specified requirements in Table 1.

Prior to beginning rock drilling, pump slurry meeting the material requirements into the shaft, as directed by the Engineer. Pump slurry to the bottom of the shaft through a hose or tremie pipe. Pump until the slurry is at least 4 ft. above the water surface level and maintain a minimum 4 ft. head of slurry above the water surface level at all times until concrete placement has been completed.

Begin rock drilling only if a minimum of 34,000 gallons of slurry meeting the specified material requirements is stored in the mixing tanks (i.e. in addition to the slurry in the casing). This is approximately 4600 cubic feet or about 130% of the theoretical volume of one shaft from the plan top of shaft to shaft tip elevation. The reason for this requirement is to ensure that sufficient a sufficient volume of slurry is available in case the slurry in the excavation falls out of the specified requirements.

After adding slurry, continuously premix additional slurry any time the supply of slurry mix meeting the material requirements in the tanks is less than 34,000 gallons. Ensure that a minimum of 34,000 gallons of slurry mix meeting the material requirements is available at the beginning of every drilling shift. Take all steps necessary to prevent the slurry from "setting up" in the shaft at no additional cost to the Department; such methods may include but are not limited to agitation and circulation.

Livingston County Item No. 1-1142.0
US 60 over Cumberland River

Prior to placing concrete in any shaft excavation, ensure that heavily contaminated slurry suspensions which could impair the free flow of concrete have not accumulated in the bottom of the shaft excavation. Settling time after the completion of drilling may be necessary to accomplish this. Perform a set of tests after completing shaft excavation and initial cleanout. At no additional cost to the Department, remove suspended solids until all values of density and sand content in a test set are less than 64 pcf and 1%, respectively. Perform final shaft bottom cleaning after suspended solids have settled from the slurry mix.

Take precautions to ensure that contaminated (i.e. used) slurry, especially within 15 to 20 ft. of the rising concrete head, does not mix with slurry to be used for subsequent shaft excavation. If the contaminated slurry is pumped into a mixing tank, use a separate tank. If this tank is to be for used for subsequent slurry mixing, clean the tank thoroughly after slurry disposal to ensure that concrete contamination has been removed. Verify that the tank has been sufficiently cleaned by filling it with water and performing a minimum of 3 pH tests. Continue cleaning the tank until the pH is below 9.

9.5 Slurry Disposal

Dispose of all slurry after use (including any slurry used at the Contractor's option). Dispose of slurry off site in areas approved by the Engineer at no additional cost to the Department and with no extension of contract time. Exercise care to ensure that slurry does not spill into the river.

10.0 EXCAVATIONS

The plans indicate the expected bottom of rock socket, top of rock socket, and top of shaft/bottom of footing elevations. Drilled shafts may be extended deeper when the Engineer determines that the material encountered while drilling the shaft excavation is unsuitable and/or is not the same as anticipated in the design of the drilled shaft. No two rock sockets at the same pier may be open at the same time. Do not excavate shafts that are in the same pier within 48 hours of the completion of another shaft at the same pier.

Maintain a construction method log during shaft excavation which includes but is not limited to the description and approximate top and bottom elevation of each soil or rock material, and remarks.

Provide the Department with the following records:

- (1) Drilled Shaft Excavation Log
- (2) Drilled Shaft Concrete Placement Log
- (3) Field and Theoretical Concreting Curves
- (4) Drilling Slurry

Livingston County Item No. 1-1142.0
US 60 over Cumberland River

Submit other records as required by the Engineer.

Dispose of excavated materials which are removed from the shaft in accordance with the Standard Specifications and requirements of other regulatory agencies.

Do not permit workmen to enter the shaft excavation for any reason unless both a suitable casing has been installed and adequate safety equipment and procedures have been provided to workmen entering the excavation. Recommended Procedures for the Entry of Drilled Shaft Foundation Excavations, prepared by ADSC: The International Association of Foundation Drilling, provides guideline recommendations for down-hole entry of drilled excavations.

At Pier 3, due to the susceptibility of the shale to rapid degradation, perform drilled shaft construction beginning with rock drilling using a "continuous operation" which, for this project, is defined according to the following criteria:

1. Perform drilled shaft solid rock excavation on consecutive full workdays, working on drilling operations in shifts of no less than 10 hours actual drilling time per day, with no breaks for weekends, holidays, etc. Time required to sample slurry and adjust the slurry mix in the shaft during a drilling shift will count toward the 10 hours of drilling time. Time required to sample slurry and adjust the slurry mix immediately prior to and immediately after every drilling shift will not count toward the 10 hours of drilling time. Time required for equipment maintenance will not count toward the required 10 hours of drilling time.
2. Ensure that a sufficient supply of slurry mix meeting the material requirements in Table 1 is available.
3. Begin concrete placement as soon as possible and no later than 12 hours after completing excavation to the shaft tip elevation. Perform shaft cleanout, sonar caliper, placing reinforcing steel, and all operations necessary to begin concrete placement within this 12 hour period.
4. Complete concrete placement in a nonstop operation.
5. If the above criteria are not met on a shaft, submit, in writing, a remedial plan to the Engineer. Until the plan is accepted by the Engineer, no additional drilled shaft rock excavations can be started on subsequent Pier 3 shafts. No additional compensation or contract extension will be allowed for any delays for work stoppage associated with non-compliance of the above criteria.

11.0 INSPECTION OF EXCAVATIONS

Provide safe access and equipment for checking the dimensions and alignment of each shaft and for conducting any required inspections. Use a safe device with handrails meeting all applicable OSHA requirements and allowed by the Engineer to provide access for project inspectors at the top of casing at the center and any plan location in the shaft. Evaluate the dimensions and alignment of the shaft under the observation and direction of the Engineer. Cooperate with the Department in the use of any inspection device.

Livingston County Item No. 1-1142.0
US 60 over Cumberland River

Using a Shaft Inspection Device (SID) or Mini-SID, verify that the shaft bottom has been adequately cleaned. Perform SID inspection once the accepted bottom of drilled shaft excavation has been achieved and the bottom cleaning of the shaft has been performed. Use SID's with a high-resolution camera mounted in a watertight chamber and fitted with a depth gauge(s) to indicate the thickness of the debris on the shaft bottom. Mini-SID devices meeting the specified requirements of this section will be considered for acceptance by the Department. Have a horizontal gage(s) fitted to the SID in the event any fractures or crevices are observed at the base of the shaft excavation. Furnish all equipment necessary to conduct the SID inspection. Provide nitrogen gas or other means to pump the water out of the interior of the chamber such that the bottom of the shaft is visible. Do a minimum of nine (9) drops as follows: north, northwest, northeast, south, southwest, southeast, east, west, and center to measure sediment at the bottom of the shaft. Operate the SID camera and supporting equipment in such a manner as to obtain optimum clarity from the equipment acceptable to the Engineer. Use television cameras and lighting equipment capable of operating in submerged conditions encountered during the inspection. Record the observations for the shaft bottom on a DVD or flash drive in .mov, .avi or other acceptable electronic format allowed by the Engineer to become the property of the Department upon completion of the project. Store DVD's or flash drives in proper containers with dust tight closures. Label DVD's or flash drives as to shaft number, project number, contract number, and contractor name. Furnish DVD's or flash drives to the Engineer or upload the files to a site accessible by applicable Department personnel upon completion of the SID inspection.

Estimate sediment thickness at the bottom of the shaft in terms of percent of view with sediment thicknesses greater than ½ inch and percent of view with sediment thickness greater than 1 ½ inch at each location. If the average percent of view of sediment thickness greater than ½ inch between all nine locations is greater than 50%, or if the sediment thickness at any point is greater than 1 ½ inch, the SID test will be considered failed. Perform additional bottom cleaning of the failed shaft using air lift methods. After the Contractor has completed final cleaning, repeat the SID test. Use of weighted tapes to measure sediment at the bottom of the shafts will not be accepted by the Department. Report results of bottom inspection to the Engineer. Continue cleaning until the Engineer is satisfied that the shaft bottom is adequately cleaned and the excavation is accepted.

During the SID inspection, report any fractures or crevices observed at the bottom of the shaft. Report any fractures or crevices to the Department. The Department will evaluate if any vertical crevice stabilization will be required.

Upon evaluation of the test data, the KYTC Geotechnical Branch may inspect the drilled shaft rock socket with a downhole camera; provide assistance as required for personnel and equipment.

The cost of inspection equipment and time, including SID inspection and any downhole camera inspections of the sidewalls of the rock sockets conducted by the Department, is incidental to the price per foot of shaft. Sonar Caliper (SC), Crosshole Sonic Logging (CSL) and Thermal

Livingston County Item No. 1-1142.0
US 60 over Cumberland River

Integrity Profiling (TIP), are separate pay items for production shafts as defined in the Special Note for Non-Destructive Testing of Drilled Shafts.

The Department will consider allowing the use of a Shaft Quantitative Inspection Device (SQUID) in lieu of a SID or Mini-SID. Include proposed acceptance criteria for bottom cleanliness comparable to those for the SID or Mini-SID with any proposal to use a SQUID. The referencing of this device in this special note does not constitute an endorsement and/or guarantee that the device will be permitted.

12.0 CONSTRUCTION TOLERANCES

The following construction tolerances apply to drilled shafts:

- a) Provide drilled shafts within 6 inches of plan position in the horizontal plane at the top of the shaft in both the longitudinal and transverse directions.
- b) Provide a vertical alignment, over the entire shaft length (plan top of shaft elevation to tip elevation), within 2% (2H:100V) of true vertical in both the longitudinal and transverse directions.
- c) Provide a vertical alignment, as measured from the plan top of shaft elevation to the top of rock socket, within 2% (2H:100V) of true vertical in the both the longitudinal and transverse directions.
- d) Provide a vertical alignment, as measured from the top of rock socket to the shaft tip, within 2% (2H:100V) of true vertical in the both the longitudinal and transverse directions.
- e) The Department will evaluate each of the criteria above when reviewing the Preliminary SC Test Reports.
- d) Place any additional steel reinforcement or concrete needed in the footings or caps due to the misalignment of the shafts at no additional cost to the Department.
- e) Extend the vertical reinforcement a minimum value into the footing, as shown on the plans. Extend the horizontal or spiral reinforcement above the top of permanent casing into the footing as shown in the plans.
- f) Drilled shaft diameters are shown on the plans. The contractor may provide a thicker-walled casing than shown in the plans at no additional cost to the Department, but do not increase the inside diameter of the casing shown on the plans unless approved by the Engineer. For out-of-round tolerance of steel casings before and after installation, the departure of any point on the periphery of the casing from the true circle, the maximum tolerable departure of any point is 1 inch measured radially.
- g) Design excavation equipment and methods so that the completed shaft excavation will have a planar bottom. Maintain the cutting edges of excavation equipment normal to the vertical axis of the equipment within a tolerance of +/- 3/8 inch per foot of diameter.
- h) Maintain the tip elevation of the shaft within +/- 6 inches from final shaft tip elevation unless otherwise specified in the plans.

Livingston County Item No. 1-1142.0
US 60 over Cumberland River

The Engineer will use the results of surveying and Sonar Calipering to evaluate the construction tolerances; refer to the Special Note for Non-Destructive Testing of Drilled Shafts. The Engineer will allow the contractor to proceed based on the Sonar Calipering Field Report if it appears that the tolerances have been met. However, since there may not sufficient information and/or time to rigorously evaluate all of the criteria, the Department will also review the Preliminary Sonar Calipering Reports and for any deficiencies and discuss options such as modifying other shafts, modifying the footing, etc. with the Contractor.

Correct all unacceptable shaft excavations and complete shafts to the satisfaction of the Engineer. Furnish materials and work necessary to complete corrections for out of tolerance drilled shaft excavations without either additional cost to the Department or an extension of the contract time. Engineering analysis and redesign for out of tolerance drilled shaft excavations shall be conducted by an independent structural and/or geotechnical consultant hired by and at the expense of the Contractor. Use consultants who are prequalified by KYTC in applicable areas. Alternatively, the Engineer may require the Department's designer to perform the referenced evaluations and the Department may require the cost of these evaluations to be borne by the Contractor. Based on the design criteria established for the structure and the evaluation, the Engineer will assess the effects of the defects on the structural performance of the drilled shaft. If the results of the analyses indicate that there is conclusive evidence that the discontinuity will result in inadequate or unsafe performance under the design loads, as defined by the design criteria for the structure, the Engineer will reject the shaft.

The contractor is responsible for proposing, developing, and after acceptance by the Engineer, implementing corrective work when a shaft excavation is completed with unacceptable tolerances. Typical corrective work includes:

- a) Over-drilling the shaft excavation to a larger diameter and/or depth to permit accurate placement of the reinforcing steel cage with the required minimum concrete cover.
- b) Increasing the number and/or size of the steel reinforcement bars.
- c) Removing the cage and drilling out the green concrete and reforming the hole.

The acceptance of correction procedures is dependent on analysis of the effect of misalignment and improper positioning. Submit redesigned drawings and computations that are signed by a Professional Engineer licensed in Kentucky.

SPECIAL NOTE

Pending U.S. Army Corps of Engineers 404 Permit

The contractor should be aware that for this project a Clean Water Act 404 permit has been submitted to the U.S. Army Corps of Engineers (USACE) and approval is currently pending. No work shall occur in a Water of the United States (stream or wetland) until the USACE 404 permit has been approved and secured. It is anticipated the permit will be secured by the time of award.



United States Department of the Interior

FISH AND WILDLIFE SERVICE

Kentucky Ecological Services Field Office
330 West Broadway, Suite 265
Frankfort, Kentucky 40601
(502) 695-0468



February 24, 2020

Ms. Bernadette Dupont
Acting System Performance Team Leader
Federal Highway Administration
330 West Broadway
Frankfort, Kentucky 40601

Re: FWS 2013-B-0280I; Biological Opinion on the Federal Highway Administration's
Proposed US Route 60 Smithland Bridge Replacement; Livingston County, Kentucky

Dear Ms. Dupont:

This letter transmits the enclosed biological opinion (BO) of the U.S. Fish and Wildlife Service (Service) for the Replacement of the US Highway 60 Smithland Bridge in Livingston County, Kentucky (Action). Acting on behalf of the Federal Highway Administration (FHWA), the Kentucky Transportation Cabinet will implement the Action. The Service received your letter requesting formal consultation for the in Action and the Biological Assessment (BA) on January 13, 2020. You determined that the Action is likely to adversely affect fat pocketbook (*Potamilus capax*).

The enclosed BO answers your request for formal consultation, and concludes that the Action is not likely to jeopardize the continued existence of the species listed above. This finding fulfills the requirements applicable to the Action for completing consultation under §7(a)(2) of the Endangered Species Act (ESA) of 1973, as amended.

The BA identified Conservation Measures to avoid and minimize effects on the fat pocketbook, including a voluntary contribution to the Kentucky Waterways Alliance to aid recovery efforts of the species. Incidental taking of listed species is exempted from the prohibitions against taking under the ESA, provided the Action is implemented consistent with the manner identified in the BO.

Reinitiating consultation is required if the KYTC retains discretionary involvement or control over the Action (or is authorized by law) when:

- a) the amount or extent of incidental take is exceeded;
- b) new information reveals that the Action may affect listed species or designated critical habitat in a manner or to an extent not considered in this BO;
- c) the Action is modified in a manner that causes effects to listed species or designated critical habitat not considered in this BO; or
- d) a new species is listed or critical habitat designated that the Action may affect.

A complete administrative record of this consultation is on file in our office at the letter-head address. If you have any questions about the BO, please contact Phil DeGarmo by phone at 502-695-0468 or by email at Phil_Degarmo@fws.gov.

Sincerely,

for Virgil Lee Andrews, Jr.
Field Supervisor

Enclosure

cc: Danny Peake, KYTC (electronic)
Doug Dawson, KDFWR (electronic)

Biological Opinion

Effects of Replacing the US Highway 60 Smithland Bridge in Livingston County, Kentucky on the Fat Pocketbook Mussel

FWS Log #: 04EK1000-2020-F-0622



Prepared by:

U.S. Fish and Wildlife Service
Kentucky Field Office
330 W. Broadway Street, Room 265
Frankfort, KY 40601

for Virgil Lee Andrews, Jr.
Field Supervisor

Date

TABLE OF CONTENTS

CONSULTATION HISTORY	3
BIOLOGICAL OPINION	4
1. INTRODUCTION	4
2. PROPOSED ACTION	5
2.1. <i>Action Area</i>	6
2.2. <i>Action Components</i>	8
2.3. <i>Conservation Measures</i>	9
2.4. <i>Interrelated and Interdependent Actions</i>	10
3. Status of the Species – Fat Pocketbook	10
3.1. <i>Species Description</i>	10
3.2. <i>Life History</i>	10
3.3. <i>Numbers, Reproduction, and Distribution</i>	11
3.4. <i>Threats</i>	11
4. Environmental Baseline	12
4.1. <i>Action Area Numbers and Reproduction</i>	12
4.2. <i>Factors Affecting the Species within the Action Area</i>	13
5. Effects of the Action	14
5.1. <i>Sediment Disturbance</i>	15
5.2. <i>Crushing or Striking</i>	16
5.3. <i>Summary of the Effects</i>	17
6. Cumulative Effects	17
7. Conclusion	17
8. INCIDENTAL TAKE STATEMENT	18
8.1. <i>Amount or Extent of Take</i>	19
8.2. <i>Reasonable and Prudent Measures</i>	19
8.3. <i>Terms and Conditions</i>	19
8.4. <i>Monitoring and Reporting Requirements</i>	19
9. CONSERVATION RECOMMENDATIONS	20
10. REINITIATION NOTICE	20
11. LITERATURE CITED	21

CONSULTATION HISTORY

This section lists key events and correspondence during the course of this consultation. A complete administrative record of this consultation is on file in the Service's Kentucky Field Office.

July 1, 2019	The Service received an initial request for formal consultation regarding the replacement of the Smithland Bridge on US Highway 60 in Livingston County, Kentucky. Subsequently, representatives of the Service and Federal Highway Administration (FHWA) met to discuss several deficiencies with the Biological Assessment (BA).
July 11, 2019	The Service was notified of the FHWA's intent to withdraw the request for formal consultation in order to address concerns with the BA.
July 12, 2019	The Service provided the FHWA comments regarding the BA.
November 13, 2019	The FHWA re-submitted the BA for review by the Service.
December 9, 2019	The Service notified FHWA of continued deficiencies with the BA and provided technical assistance regarding information needed to move forward with consultation.
December 19, 2019	The Service provided FHWA clarification regarding the request for additional information.
January 13, 2020	The Service received an updated BA from FHWA requesting initiation of formal consultation with the Service.
January 30, 2020	The Service responded to the FHWA request, initiating formal consultation the fat pocketbook mussel. The Service also provided concurrence with not likely to adversely affect determinations for several federally listed species.
February 6, 2020	The Kentucky Transportation Cabinet amended the description of the Action Area in e-mail correspondence.
February 11, 2020	The Service provides the FHWA with a concurrence regarding a not likely to adversely affect determination for the gray bat.
February 20, 2020	The Service provides the FHWA with a draft Biological Opinion.
February 24, 2020	The FHWA notified the Service that it had no comments on the draft Biological Opinion
February 24, 2020	The Service provides the FHWA with the Final Biological Opinion.

BIOLOGICAL OPINION

1. INTRODUCTION

A biological opinion (BO) is the document that states the opinion of the U.S. Fish and Wildlife Service (Service) under the Endangered Species Act of 1973, as amended (ESA), as to whether a Federal action is likely to:

- a) jeopardize the continued existence of species listed as endangered or threatened, or
- b) result in the destruction or adverse modification of designated critical habitat.

The proposed Federal Action addressed in this BO is the replacement of the US Highway 60 Smithland Bridge in Livingston County, Kentucky (Action). This BO considers the effects of the Action on the fat pocketbook mussel (*Potamilus capax*). Acting on behalf of the Federal Highway Administration (FHWA), the Kentucky Transportation Cabinet (KYTC) will implement the proposed Action. Critical habitat has not been designated for the fat pocketbook; therefore, this BO does not address critical habitat.

In a letter dated January 30, 2020, the Service concurred with the FHWA determination that the Action may affect, but is not likely to adversely affect (NLAA) the following species: catspaw (*Epioblasma obliquata*), rabbitsfoot mussel (*Theiladerma cylindrica*), interior least tern (*Sterna antillarum*), clubshell (*Pleurobema clava*), dromedary pearlymussel (*Dromus dromas*), fanshell (*Cyprogenia stegaria*), orangefoot pimpleback (*Plethobasus cooperianus*), pink mucket (*Lampsilis abrupta*), rough pigtoe (*Pleurobema plenum*), sheepnose (*Plethobasus cyphus*), spectaclecase (*Cumberlandia monodonta*), and Price's potato-bean (*Apios priceana*). Additionally, concurrence with a NLAA determination on the gray bat (*Myotis grisescens*) was provided to the FHWA on February 11, 2020. These species are not further addressed in this BO.

The FHWA determined that the proposed action may affect and is likely to adversely affect the Indiana bat (*Myotis sodalis*) and northern long-eared bat (*Myotis septentrionalis*) (NLEB). In the BA, the FHWA proposed to account for potential adverse effects to the Indiana bat and its habitat through the processes identified in the 2015 Interim Programmatic Agreement for Forest Dwelling bats between the Federal Highway Administration (FHWA), KYTC, and the Service's Kentucky Field Office. Regarding the NLEB, it was determined that there would be no effects beyond those previously evaluated in the Service's programmatic biological opinion for the NLEB final 4(d) rule dated January 5, 2016 (FWS Log# 03E00000-2016-F-0001). Any taking that may occur incidental to this project is not prohibited under the final 4(d) rule (50 CFR §17.40(o)). Therefore, responsibilities under ESA section 7(a)(2) relative to the NLEB for this project may be fulfilled by relying on the Service's programmatic biological opinion for the 4(d) rule. These species are not further addressed in this BO.

A BO evaluates the effects of a Federal action, along with those effects resulting from interrelated and interdependent actions and effects from non-federal actions unrelated to the proposed Action (cumulative effects), relative to the status of listed species and the status of designated critical habitat. A Service BO that concludes a proposed Federal action is *not* likely

to jeopardize species and is *not* likely to destroy or adversely modify critical habitat fulfills the Federal agency's responsibilities under §7(a)(2) of the ESA of 1973, as amended.

"Jeopardize the continued existence" means to engage in an action that reasonably would be expected, directly or indirectly, to reduce appreciably the likelihood of both the survival and recovery of a listed species in the wild by reducing the reproduction, numbers, or distribution of that species (50 CFR §402.02). *"Destruction or adverse modification"* means a direct or indirect alteration that appreciably diminishes the value of designated critical habitat for the conservation of a listed species. Such alterations may include, but are not limited to, those that alter the physical or biological features essential to the conservation of a species or that preclude or significantly delay development of such features (50 CFR §402.02).

Updates to the regulations governing interagency consultation (50 CFR part 402) were effective on October 28, 2019 [84 FR 44976]. This consultation was pending at that time, and we are applying the updated regulations to the consultation. As the preamble to the final rule adopting the regulations noted, "[t]his final rule does not lower or raise the bar on section 7 consultations, and it does not alter what is required or analyzed during a consultation. Instead, it improves clarity and consistency, streamlines consultations, and codifies existing practice." We have reviewed the information and analyses relied upon to complete this BO in light of the updated regulations and conclude the BO is fully consistent with the updated regulations.

2. PROPOSED ACTION

The KYTC proposes to replace the existing US Highway 60 Smithland Bridge over the Cumberland River in Livingston County, Kentucky (KYTC Item No. 1-1142.00). The existing bridge, originally constructed in 1931, is considered functionally obsolete due to narrow lane and shoulder widths and failing infrastructure. The centerline of the preferred build alternative is located approximately 100-feet downstream of the existing bridge. The new bridge will not result in the placement of any new permanent structures (*e.g.*, piers) in the Cumberland River. New approaches will be required on both the north and south sides of the river, with the southern approach tying in near State Route 70, and the northern approach near Brummitte Road. Although a definitive timeline has not been established, we expect it will take multiple years to complete the Action.

To facilitate construction, a staging area will be established west of the existing bridge on the south side of the Cumberland River. The contractor will mobilize on site and clear trees within the staging area and project right-of-way, downstream of the existing bridge. Construction of the roadway approach embankment on north side of the river will commence along with construction of new piers and erection of the truss within the staging area. Construction of the piers will require local excavations to the bottom of footing depth. The pier closest to the Cumberland River (Pier #4) on the north bank will likely require a cofferdam, but is located outside of the river channel. Within the staging area, two (2) large coffer cells will be dredged within the floodplain to accommodate two (2) deck barges. The truss steel will be erected on false-work supported by the deck barges in the staging area. Once erection of the truss is complete, the truss will be floated out of the staging area, lifted to the appropriate elevation, and set down on the supporting piers, thus clear-spanning the river. These piers will be the closest in proximity to the Cumberland River. Beams for the approach superstructure will be set in place

and the deck will be cast for the entire bridge. Cyclopean stone riprap will be placed over the footprints of each of the piers for scour protection. The coffer cells within the staging area will be filled and graded back to the original ground surface configuration and the entire area will be re-vegetated.

Once the new bridge is completed, traffic will be diverted off the existing structure and routed over the new bridge. The existing bridge will be deconstructed using a combination of conventional techniques. The concrete deck will be saw-cut and removed from above with no impacts to the river. Appropriate measures will be taken to eliminate any concrete pieces from entering the river during this process. Explosives will then be placed along the truss span and detonated, dropping the remaining superstructure into the Cumberland River where it will be retrieved and disposed of off-site. The existing piers will be removed just above the water line using mechanical equipment, then explosives will be used to reduce portions of the pier below the waterline to rubble that will be dredged from the river bottom.

2.1. Action Area

For purposes of consultation under ESA §7, the Action Area is defined as “all areas to be affected directly or indirectly by the Federal action and not merely the immediate area involved in the action” (50 CFR §402.02). The “Action Area” for this consultation encompasses the upland and aquatic environment within the disturbance limits of the preferred alternative (Figure 1). This includes approximately 61,066 m² of aquatic habitat directly surrounding and downstream of existing piers, directly below and downstream of the existing bridge deck, river's edge near the new pier locations, and adjacent to the staging area. (Logsdon 2020, pers. comm.)



Figure 1: Action Area

2.2. Action Components

The Service's evaluation of the proposed bridge replacement resulted in the identification of two activities that may result in negative impacts to the fat pocketbook: (1) construction of the new bridge, and (2) removal of the existing structure. Impacts to the fat pocketbook from the operation of the new bridge are not anticipated.

2.2.1. Construction of the New Bridge

During construction of the new bridge, no new piers will be placed in the river channel. However, piers will be placed near the river's edge. Pier #4, located on the north side of the river, will likely require a cofferdam. A staging area (approximately 900-foot by 15-foot) will be used on the southern shore of the Cumberland River. Within the staging area, two (2) large coffer cells will be dredged to accommodate two (2) deck barges. These activities are likely to result in the crushing and/or striking of mussels.

Tree and vegetation removal, utilization of cofferdams, coffer cell construction in the staging area, and utilization of barges will mobilize sediment and cause it to be transported downstream within the aquatic Action Area. This sediment disturbance is likely to take place during the entirety of the project's time line, but is not anticipated to continue after project completion.

Based on these factors, the Service has determined that the construction of the new bridge is expected to result in the following stressors that may affect the fat pocketbook: (1) crushing and/or striking of mussels, and (2) sediment disturbance. These stressors are further discussed in Section 5.

2.2.2. Removal of the Existing Bridge

Removal of the existing bridge will take place in multiple steps. First, the bridge deck will be cut and removed. Second, explosives will be used to drop the superstructure into the river. The superstructure will then be retrieved from the river bed. Third, the existing piers will be removed to just above the water line via mechanical means. The remainder of the pier (below the water line) will be broken apart via explosives, and the resulting pieces removed from the river bed. Removal of the existing bridge, will require heavy equipment to be operated in the river as necessary. Direct stream bed disturbance via demolition activities will mobilize the existing sediment and cause it to be transported within the Action Area. This sediment disturbance is likely to take place during the entirety of the Action, but is not expected to continue after project completion. These activities could also result in the crushing and/or striking of mussels.

The superstructure and existing pier material that will enter the river during deconstruction will be retrieved right away. However, these materials may cause a flash event of changes to the flow pattern, but will not remain in the river long enough to significantly alter flow. The staging area will be in place for the duration of the Action and may cause temporary alterations in flow along the southern river bank. Scouring may occur, as well as slightly narrowing the overall river channel. Removal of the existing bridge may result in short-term water quality degradation, changes to stream flow, and hydraulic shock. However, our review determined that these effects

would be insignificant to the fat pocketbook. Factors supporting this finding are consistent with KYTC's conclusions and are further discussed in Section 5.

Based on these factors, the Service has determined that the removal of the existing bridge is expected to result in the following stressors that may affect the fat pocketbook: (1) crushing and/or striking of mussels, and (2) sediment disturbance. These stressors are further discussed in Section 5.

2.3. Conservation Measures

The KYTC has indicated that the several conservation measures that will be implemented to minimize affects to the fat pocketbook.

1. KYTC is bound by the tenets of Kentucky Pollution Discharge System (KPDES), permit number KYR10, to reduce erosion and sedimentation effects from projects involving soil disturbance. As required under Section 213 of the KYTC Standard Specifications, a site-specific Erosion Control Plan, including Best Management Practices (BMP), will be developed prior to on-site activities to ensure continuous erosion control throughout the construction and post-construction period. The plan will identify individual Disturbed Drainage Areas (DDA) where stormwater from the construction area will be discharged off site or into waters of the Commonwealth. This measure will reduce the amount of sediment and other contaminants introduced into the Action Area, minimizing impacts to mussels.
2. During demolition of the existing bridge, the concrete deck will be removed without impacting the river. This will minimize the amount of falling debris when the truss is detonated and dropped into the Cumberland River, thus reducing the potential for striking and/or crushing of mussels.
3. Existing piers will be removed to just above the water line, thus reducing the quantity of debris entering the Cumberland River and the potential for crushing and/or striking mussels.
4. Removal of all materials from the riverbed resulting from construction/demolition activities will be dredged from the river, avoiding long-term changes to the substrate and hydrology. If necessary, the stream bed will be leveled to surrounding elevations with natural materials. This will be expedited to allow for more rapid mussel recolonization.
5. All materials excavated from dredging or during truss removal will be stored at an upland site and precluded from re-entry into any aquatic resource. Turbidity will be monitored 100-foot upstream of the existing US Highway 60 bridge, as well as 500-foot and 1,000-foot downstream at both the substrate level and mid-water column. This activity will allow the action agency to ensure that effects to water quality are consistent with those considered in this BO.
6. The KYTC has agreed to make a voluntary contribution to the Kentucky Waterways Alliance's (KWA) Kentucky Aquatic Resources Fund (KARF) to aid recovery efforts for the fat pocketbook mussel. Currently, it is estimated that \$750.00 is an appropriate contribution per individual fat pocketbook mussel. Based on the number of individuals estimated to be present within the Action Area (62), the KYTC has agreed to contribute a total of \$46,500.00 ($\$750.00 \text{ per individual} \times 62 \text{ individuals} = \$46,500.00 \text{ total contribution}$). These funds will be used in propagation, culture, and other recovery

efforts for the fat pocketbook. The total contribution will be made in one transaction with the KWA, prior to project implementation. The point of contact for the KWA is as follows: Mr. Ward Wilson, Executive Director, 120 Webster Street, Suite 217, Louisville, Kentucky 40206. The KWA's office telephone number is 502-589-8008. Mr. Wilson should be contacted to determine if the contribution will be made by mail, direct deposit, or a wire transfer.

2.4. Interrelated and Interdependent Actions

A BO evaluates the effects of a proposed Federal action. For purposes of consultation under ESA §7, the effects of a Federal action on listed species or critical habitat include the direct and indirect effects of the action, plus the effects of interrelated or interdependent actions. "Indirect effects are those that are caused by the proposed action and are later in time, but still are reasonably certain to occur. Interrelated actions are those that are part of a larger action and depend on the larger action for their justification. Interdependent actions are those that have no independent utility apart from the action under consideration" (50 CFR §402.02).

In its request for consultation, the KYTC did not describe, and the Service is not aware of, any interrelated or interdependent actions to the Action. Therefore, this BO does not further address the topic of interrelated or interdependent actions.

3. STATUS OF THE SPECIES - FAT POCKETBOOK

This section summarizes best available data about the biology and status of the fat pocketbook mussel (*Potamilus capax*) throughout its range that are relevant to formulating an opinion about the Action. The Service published its decision to list the fat pocketbook as endangered on June 14, 1976 (41 FR 24062-24067). A recovery plan was written in 1985 and then revised in 1989 (USFWS 1989).

3.1. Species Description

The fat pocketbook has a round to oblong shell that is greatly inflated and has a strong s-shaped hinge line. The beak cavity is very deep (NatureServe 2007, Cummings and Mayer 1992). The shell is thin to moderately thick and the color of the outer shell surface (periostracum) varies in color from light brown, yellow, or olive, and becoming dark brown in older individuals. The shell is typically rayless, smooth, and very shiny. Both anterior and posterior ends of the shell are rounded. Young fat pocketbook shells may have a few faint ridges on the umbo as well as have a small posterior wing present, but these characteristics are not necessarily visible in older individuals. The umbos are greatly inflated, elevated above the hinge line, and turned inward. The fat pocketbook is known to grow to a length of 5 inches. Internal morphology includes two pseudocardinal teeth in each valve, and both are thin, compressed, and elevated. There are two lateral teeth in the left valve and one in the right valve. Lateral teeth are thin and greatly curved in both valves. The color of the inner shell surface (nacre) is bluish white and often iridescent; however, it may include some pink or salmon color in some specimens (Cummings and Mayer 1992).

3.2. Life History

The fat pocketbook is a large-river species that is typically found in slow-flowing water with a mud (silt/clay), sand, or gravel substrate, at depths of a few inches to eight or more. It is a long-

term brooder, with females becoming gravid in the fall, retaining larvae (glochidia) over winter, and releasing the progeny during spring and summer. Although the fat pocketbook was historically widespread within much of its original range, populations of this species and its range have declined in the last 50 years. The main reason for decline of the species is channelization, impoundment, and dredging of rivers, but contributing factors include siltation and pollution, and possibly range reductions of fish hosts. The freshwater drum (*Aplodinotus grunniens*) is the primary host fish for the species (Barnhart 1997, Watters 2007).

3.3. Numbers, Reproduction, and Distribution

Little is known on the population dynamics of the fat pocketbook; however, relatively dense populations do occur in portions of the St. Francis River drainage in Arkansas and Missouri, and sporadically elsewhere, but extensive surveys have not been conducted. Surveys conducted within the last 5-10 years in the lower Ohio River that have recorded this species, are usually targeted at specific projects (e.g., fleeting areas, loading/unloading facilities, Corps dredging needs, and sand and gravel dredging operations), or records have been obtained from commercial mussel fishermen working that portion of the lower Ohio River near Paducah, Kentucky, and Metropolis, Illinois. Based on these more recent records, it appears the fat pocketbook may be somewhat more common than previously believed in this reach of river, but no quantitative assessment is available. Many of these records are of young individuals (i.e., <5 years), so it is apparent the species has been able to successfully recruit in recent years. Since only one (1) record is known from the lower Tennessee River, population size for the Tennessee River is unknown.

3.4. Threats

The primary causes for the decline of the fat pocketbook in its historic range are from navigation (e.g., maintenance dredging) and flood control activities on the rivers where it was once found (USFWS 1989). Channel dredging is a direct impact that physically removes fat pocketbooks from their habitat. Dredging activities can affect aquatic systems both physically (e.g., accelerated erosion, decreased habitat diversity, increased bedload, and increased habitat instability) and biologically (e.g., altered behavior of host fish from changing flow patterns, decreased biomass, and altered species composition and abundance) (USEPA 2007).

Construction of impoundments for flood control in the river basins in which fat pocketbook had been collected has caused a loss of fat pocketbook habitat from inundation, changes in flow distributions, and sedimentation. Reductions in water quality (metals, pesticides, and other pollutants) from point source discharges also have likely affected mussel populations. However, with the implementation of the U.S. Environmental Protection Agency's National Pollutant Discharge Elimination System in 1972, industrial discharges have been regulated, and point source pollutants have significantly declined in the large river systems in which the fat pocketbook is reported. Non-point source pollution (stormwater runoff that includes complex mixtures of pesticides, fecal coliform bacteria, metals, suspended solids, and pharmaceuticals) may also have had a negative impact on mussel populations downstream of agricultural and urban areas, although the possible effects have not been adequately researched.

Other causative factors in the decline of the fat pocketbook include competition of food and habitat resources with the invasive zebra mussel (*Dreissena polymorpha*) in some portions of their range (NPS 2006, Hunter et al. 1996, Schloesser et al. 1996). The zebra mussel, a relatively

new threat, is an exotic species that colonizes the shells of native mussels; this species is present in the Ohio River and has been observed attached to native mussels. It can restrict the ability of a mussel to move, feed, respire, and reproduce, especially if large numbers are present on the shell of the native mussel. Zebra mussels were found to be a contributing factor in the decline of unionids downstream of the Belleville Locks and Dam (EA 2005). An additional new potential threat is a molluscivore (mollusk predator) fish, the black carp (*Mylopharyngodon piceus*). It has recently been recorded in the Mississippi River near the mouth of the Ohio River, further upstream in the Mississippi River, and in Kentucky Lake on the Tennessee River.

4. ENVIRONMENTAL BASELINE

In accordance with 50 CFR 402.02, the environmental baseline refers to the condition of the listed species or its designated critical habitat in the action area, without the consequences to the listed species or designated critical habitat caused by the proposed action. The environmental baseline includes the past and present impacts of all Federal, State, or private actions and other human activities in the action area, the anticipated impacts of all proposed Federal projects in the action area that have already undergone formal or early section 7 consultation, and the impact of State or private actions which are contemporaneous with the consultation in process. The consequences to listed species or designated critical habitat from ongoing agency activities or existing agency facilities that are not within the agency's discretion to modify are part of the environmental baseline.

4.1. Action Area Numbers and Reproduction

A mussel survey was completed within the Action Area in October 2015. This survey resulted in the collection of five (5) federally endangered fat pocketbook mussels. Subsequently, an additional comprehensive survey was performed in August 2017. Like the 2015 survey, the 2017 survey implemented both semi-quantitative and qualitative searches to further characterize the mussel resource by documenting the native mussel community composition, distribution, density, and size/age structure; as well as general habitat conditions within the Action Area.

The 2017 survey included six (6) bank-to-bank semi-quantitative transects, six (6) 20m transects (for rabbitsfoot), and ten (10) qualitative samples. One (1) bank-to-bank transect was located upstream of the bridge, with two (2) others directly beneath the existing US Highway 60 bridge spaced approximately 15m apart. The remaining three (3) bank-to-bank transects were located between the 2015 downstream transect locations. The 20m transects (for rabbitsfoot) were dispersed throughout the survey area and extended from the bank, 20m into the channel.

Along each transect, divers collected all mussels (live and dead) within 1m wide by 10m long sections along one (1) side of the transect. Each 10m² area along the transects was exhaustively searched by the diver using visual and tactile search methods that included disturbing the top several inches of riverbed substrate by hand. A minimum of 5-minute search times was spent per sample to ensure thorough coverage; actual time spent per sample was recorded to facilitate catch per hour calculations in conjunction with estimates of mussel density.

Four (4) qualitative surveys were conducted for 20 minutes between each transect in the areas of highest mussel density encountered during the semi-quantitative bank-to-bank surveys. An additional four (4), 30-minute qualitative searches were conducted along the toe of the bank

(targeting the rabbitsfoot) between each of the 20m semi-quantitative rabbitsfoot transects. Finally, two (2) 20-minute qualitative searches were conducted around existing piers to further document the potential impacts of demolition and potential cofferdam construction.

A total of 140 live mussel specimens representing 13 species, including one (1) federally endangered fat pocketbook, were recorded during the 2017 mussel survey. Two (2) fresh dead juvenile shells were also collected, indicating reproduction of the fat pocketbook within or near the Action Area. Four (4) species – threeridge (*Amblema plicata*), washboard (*Megalonaias nervosa*), mapleleaf (*Quadrula quadrula*), and ebonyshell (*Fusconaia ebena*) – represented almost 75% of specimens collected during the survey. Densities were low throughout the survey area. Along the semi-quantitative transects, densities ranged from 0.0 mussels/m² to 1.8 mussels/m², with an average of 0.070 mussels/m². The rabbitsfoot transects resulted in no collection of mussels. The low abundance of live specimens collected during the survey is likely an indicator of a relatively poor mussel resource in the Action Area.

The density of fat pocketbook in the Action Area was calculated using the total m² within the quantitative portion of the survey (i.e. – transects), which was 2,130 m², and the total number of fat pocketbooks found during that portion of the survey. Of the six (6) total fat pocketbooks found during the surveys, two (2) were found on transects. Thus, two (2) fat pocketbooks/2,130 m² = 0.001 fat pocketbooks/m². Given the estimated density level of fat pocketbook (~0.001/m²) and the size of the Action Area (61,066 m²), we estimate that 62 individual fat pocketbooks (0.001/m² x 61,066 m² = 61.066 individuals) occupy the Action Area.

4.2. Factors Affecting the Species within the Action Area

Substrate Conditions

Substrates within the Action Area are predominately composed of mixtures of gravel and sand, followed by cobble, boulder, bedrock, clay, and silt. The 2017 mussel survey noted that silt was the least recorded substrate within the Action Area, generally observed as a dusting to an inch or more cover over other substrates. Although the substrate conditions are not optimal for fat pocketbook, the species does occur in depositional habitat within the Action Area.

Water Quality

Another factor potentially affecting the species' environment in the Action Area includes the makeup of water quality from upstream of the site, including possible contaminants from urban runoff, sewer outfalls, and industrial complexes located upstream of the site.

Dam

Lake Barkley Lock and Dam is a barrier on the Cumberland River that may impact host fish movement upstream and downstream, possibly limiting the amount of contact between fish and mussels at times when a gravid mussel is ready to release larvae. By preventing upstream movement, it is possible that the dam could cause a fish host to slow its movement upstream, and spend more time just downstream of the dam, thereby decreasing its contact time with a mussel.

Barge Traffic

Barge traffic moves both upstream and downstream of the project site. The Service is not aware of any large spills from barges in recent years (i.e., 15 years) that have impacted mussels in the Action Area.

Other activities

Private actions that may impact the Action Area are primarily urban runoff and point source releases from the city and industries and agriculture-related activities, such as row crop farming, that may increase sedimentation and turbidity. Private boating and commercial navigation activities also occur in the Cumberland River and are expected to continue. We are reasonably certain these activities will continue and do not expect these activities to change appreciably in the future from current conditions. Effects from urban and agricultural activities on mussels could include increased sediment deposition, turbidity, and herbicide/pesticide levels in localized portions of the Cumberland River. However, these effects, if they are occurring, are indeterminable.

5. EFFECTS OF THE ACTION

In accordance with 50 CFR 402.02, effects of the action are all consequences to listed species or critical habitat that are caused by the proposed action, including the consequences of other activities that are caused by the proposed action. A consequence is caused by the proposed action if it would not occur but for the proposed action and it is reasonably certain to occur. Effects of the action may occur later in time and may include consequences occurring outside the immediate area involved in the action (see § 402.17).

The Service established additional requirements for making the determination of reasonably certain to occur, which must be followed after October 28, 2019, the effective date of new regulations under 50 CFR 402. After determining that the “activity is reasonably certain to occur,” based on clear and substantial information³, using the best scientific and commercial data available, there must be another conclusion that the consequences of that activity (but not part of the proposed action or activities reviewed under cumulative effects) are reasonably certain to occur. In this context, conclusion of reasonably certain to occur must be based on clear and substantial information, using the best scientific and commercial data available after consideration of three factors in 402.17(b)(1-3).

There is no intent that the 2019 regulatory changes alter how we will analyze the effects of a proposed action or the scope of effects. We will continue to review all relevant effects of a proposed action as we have in past decades, but the Service determined it was not necessary to attach labels to various types of effects through regulatory text. That is, we intend to capture all of those effects (now “consequences”) previously listed in the regulatory definition of effects of the action— direct, indirect, and the effects from interrelated and interdependent activities—in the new definition. These effects are captured in the new regulatory definition by the term “all consequences” to listed species and critical habitat.

Based on the description of the Action and the species’ biology, we have identified two (2) stressors that are likely to adversely affect the fat pocketbook: crushing or striking that could cause shell damage to individuals, and sediment disturbance. Below, we discuss the best

available science relevant to each stressor. Then, we describe the Stressor-Exposure-Response pathways that identify the circumstances for an individual mussel’s exposure to the stressor (i.e., the overlap in time and space between the stressor and the federally listed mussel). Finally, we identify and consider how proposed conservation measures may reduce the severity of the stressor or the probability of an individual mussel’s exposure for each pathway.

Our review concludes that water quality degradation, changes to stream flow, and hydraulic shock will result in insignificant effects to the fat pocketbook. Factors supporting this finding are described below and are consistent with KYTC’s conclusions.

Construction equipment may be used in the stream for cofferdam installation/removal. While an accidental spill of fuel, oil, hydraulic fluid, or other contaminants could temporarily degrade water quality, we expect any exposure would be short-term, and would not occur at an appreciable level. Therefore, any affects to water quality are expected to be insignificant.

Given the previous scour near existing bridge piers, the utilization and placement of cofferdams, and the size of the staging area, any changes in flow pattern will be minimal and insignificant. The river will still flow readily through the Action Area with no changes in pool size, temperature, or oxygen levels anticipated.

The fat pocketbook's host fish, the freshwater drum, is susceptible to injury or death due to underwater blasting, which could result in decreased reproductive success of the fat pocketbook. However, given the short nature of the activity (limited to only the short-term deconstruction of the existing piers), and that freshwater drum is a common fish in the area, any potential reproductive loss to the fat pocketbook would be insignificant. Presumably, more freshwater drum would quickly reinhabit the area post stressor and be able to facilitate the necessary parasitic stage of the mussel’s life cycle.

5.1. Sediment Disturbance

Construction of the new bridge and removal of the existing bridge demolition will both likely result in sediment disturbance in the Cumberland River. Given the nature of these activities and the small characteristic class of the substrate, we expect sediment to mobilize, allowing transport within the Action Area. This sediment disturbance is likely to take place during the entirety of the Action, but is not expected to continue after project completion.

Effects Pathway #1 – Fat Pocketbook	
Activity: Construction of New Bridge and Removal of Existing Bridge	
Stressor: Sediment Disturbance	
<i>Exposure (time)</i>	Duration of Action
<i>Exposure (space)</i>	Within the Aquatic Action Area
<i>Resource affected</i>	Individuals (larvae, juveniles, adults)
<i>Individual response</i>	<ul style="list-style-type: none"> • Harm if sediment clogs gills or affects feeding. • Harm if sediment buries individuals, resulting in energy expenditure or smothering. • Reduced recruitment due to loss of interstitial spaces for juvenile development.

<i>Effect</i>	Adverse, Harm including mortality
<i>Conservation Measures</i>	<ul style="list-style-type: none"> • The new bridge will not require any new piers in the river. • Coffers will be limited to the staging area and the location of pier #4. • Cyclopean riprap will be placed over the footprints for each of the piers for scour protection. • The staging area will be re-vegetated after completion of the project.
<i>Interpretation</i>	<p>Sediment disturbance is likely to occur throughout all phases of the project (demolition of the existing bridge and new bridge construction). The substrate in the project area consists of small texture class particles and within areas of consolidated materials and unconsolidated materials. The likelihood of substrate material movement and disturbance is very high. The fat pocketbook is living and reproducing in the Action Area within these finer substrate materials and will most likely be adversely affected (via dislodging, smothering, and respiration interference). Although this mussel is resilient to such activities, the project will take multiple years to complete and will represent a relatively long-term disturbance within the Action Area. So, even if the fat pocketbook is able to withstand flashes of sediment disturbance fairly unharmed, and is able to feed, the long-term nature and severity of instream impacts may produce such a disturbance that it will be too much for individual mussels to overcome.</p>

5.2. Crushing or Striking

Construction activities associated with the installation of the new bridge and in-stream work involving pier and deck removal may result in injury or mortality of the fat pocketbook, if crushing and/or shell damage occurs.

Effects Pathway #2 – Fat Pocketbook	
Activity: Construction of New Bridge and Removal of Existing Bridge	
Stressor: Crushing or Striking	
<i>Exposure (time)</i>	Duration of Action
<i>Exposure (space)</i>	Areas directly surrounding and downstream of existing piers, directly below and downstream of the existing bridge deck, river's edge near new pier locations, and entire location of the staging area.
<i>Resource affected</i>	Individuals (larvae, juveniles, adults)
<i>Individual response</i>	<ul style="list-style-type: none"> • Individuals could be struck by falling debris (whether pier rubble or the existing bridge superstructure) which may result in damage or mortality. • Individuals may be crushed during usage of cofferdams, which could result in mortality. • Individuals may be struck by equipment in the staging area (e.g. – construction of coffer cells), which could result in damage or mortality.
<i>Effect</i>	Adverse, Harm including mortality
<i>Conservation Measures</i>	<ul style="list-style-type: none"> • The new bridge will not require any new piers in the river. • Cofferdams will be limited to the staging area and pier #4.

<i>Interpretation</i>	The existing bridge will be pieced apart with portions of the bridge dropped directly into the river. The new bridge will be constructed utilizing a staging area, but will not require new piers within the river channel. Given the known presence of fat pocketbook in the immediate project area and the deconstruction/construction measures, it is likely that individuals will be struck and harmed during these phases of the project. The fat pocketbook is a relatively thin to moderately thick-shelled mussel and would likely easily be crushed or cracked by any bridge debris or pier material that is anticipated to enter the river.
-----------------------	---

5.3. Summary of the Effects

The proposed actions could expose the fat pocketbook to the stressors evaluated above and summarized below. Given the location of the project, known presence of fat pocketbook, habitat characteristics of the Action Area, and project construction and deconstruction activities, it was determined that crushing/striking of fat pocketbook individuals and sediment disturbance are likely to adversely affect the species. While water quality degradation, changes to stream flow, and hydraulic shock were determined to be insignificant and are not likely to adversely affect the species.

Table 1: Summary of Effects of the Action on the Fat Pocketbook

Stressors	Activity	Form of Incidental Take
Sediment Disturbance	<ul style="list-style-type: none"> • Construction of New Bridge • Removal of Existing Bridge 	Harm
Crushing or Striking	<ul style="list-style-type: none"> • Construction of New Bridge • Removal of Existing Bridge 	Harm

6. CUMULATIVE EFFECTS

For purposes of consultation under ESA §7, cumulative effects are those caused by future state, tribal, local, or private actions that are reasonably certain to occur in the Action Area. Future federal actions that are unrelated to the proposed action are not considered, because they require separate consultation under §7 of the ESA. We are not aware of any other State, tribal or local actions to include under Cumulative effects.

7. CONCLUSION

“*Jeopardize the continued existence*” means to engage in an action that reasonably would be expected, directly or indirectly, to reduce appreciably the likelihood of both the survival and recovery of a listed species in the wild by reducing the reproduction, numbers, or distribution of that species (50 CFR §402.02). After reviewing the current status of the species, the environmental baseline for the Action Area, the effects of the Action and the cumulative effects,

it is the Service's biological opinion that the Action is not likely to jeopardize the continued existence of the fat pocketbook.

This determination is based on several factors: (a) The mussel survey results showed low numbers of individuals that could be adversely affected within the Action Area; (b) The fat pocketbook continues to persist in the Cumberland River and other portions of its range, often at higher population levels than those observed within the Action Area; and (c) The conservation measures will minimize the likelihood of mortality and other population effects by limiting the impact of construction activities. In addition, the contribution of funds to use for mussel propagation and culture will assist in the recovery of the fat pocketbook.

8. INCIDENTAL TAKE STATEMENT

ESA §9(a)(1) and regulations issued under §4(d) prohibit the take of endangered and threatened fish and wildlife species without special exemption. The term "take" in the ESA means "to harass, harm, pursue, hunt, shoot, wound, kill, trap, capture, or collect, or to attempt to engage in any such conduct" (ESA §3). In regulations at 50 CFR §17.3, the Service further defines:

- "harass" as "an intentional or negligent act or omission which creates the likelihood of injury to wildlife by annoying it to such an extent as to significantly disrupt normal behavioral patterns which include, but are not limited to, breeding, feeding, or sheltering;"
- "harm" as "an act which actually kills or injures wildlife. Such act may include significant habitat modification or degradation where it actually kills or injures wildlife by significantly impairing essential behavioral patterns, including breeding, feeding or sheltering;" and
- "incidental take" as "any taking otherwise prohibited, if such taking is incidental to, and not the purpose of, the carrying out of an otherwise lawful activity."

Under the terms of ESA §7(b)(4) and §7(o)(2), taking that is incidental to and not intended as part of the agency action is not considered prohibited, provided that such taking is in compliance with the terms and conditions of an incidental take statement (ITS).

For the exemption in ESA §7(o)(2) to apply to the Action considered in this BO, the KYTC must undertake the non-discretionary measures described in this ITS, and these measures must become binding conditions of any permit, contract, or grant issued for implementing the Action. The KYTC has a continuing duty to regulate the activity covered by this ITS. The protective coverage of §7(o)(2) may lapse if the KYTC fails to:

- (a) Assume and implement the terms and conditions; or
- (b) Require a permittee, contractor, or grantee to adhere to the terms and conditions of the ITS through enforceable terms that are added to the permit, contract, or grant document.

In order to monitor the impact of incidental take, the KYTC must report the progress of the Action and its impact on the species to the KFO as specified in this ITS.

8.1. Amount or Extent of Take

This section specifies the amount or extent of take of fat pocketbook that the Action is reasonably certain to cause, which we estimated in the “Effects of the Action” section(s) of this BO.

The Service expects that incidental take of the fat pocketbook will occur through the following:

1. Harm of individuals crushed or damaged by falling debris and/or struck by equipment;
2. Harm of individuals due to short-term increases in sediment that may affect respiration, reproduction, and feeding of mussels.

Anticipated Take

Species	Individuals	Form of Take
Fat Pocketbook	62	Harm

8.2. Reasonable and Prudent Measures

The Action includes conservation measures to avoid and minimize impacts to fat pocketbook mussels. The analysis of effects of the Action in this BO considers that the KYTC will authorize, fund, or carry out all activities under the Action in a manner that is consistent with the description of activities provided in BA, including all applicable conservation measures. Due to the aforementioned commitments, our review of the Action, and conservation measures, the Service believes that no reasonable and prudent measures are necessary or appropriate to minimize incidental take of the fat pocketbook caused by the Action.

8.3. Terms and Conditions

No reasonable and prudent measures to minimize incidental take caused by the Action are provided in this BO; therefore, no terms and conditions for carrying out such measures are necessary.

8.4. Monitoring and Reporting Requirements

In order to monitor the impacts of incidental take, the KYTC must report the progress of the Action and its impact on the species to the Service as specified in the ITS (50 CFR §402.14(i)(3)). This section provides the specific instructions for such monitoring and reporting. As necessary and appropriate to fulfill this responsibility, the KYTC must require any permittee, contractor, or grantee to accomplish the monitoring and reporting through enforceable terms that are added to the permit, contract, or grant document. Such enforceable terms must include a requirement to immediately notify the KFO if the amount or extent of incidental take specified in this ITS is exceeded during Action implementation.

The KYTC will (1) ensure that all of the identified Conservation Measures are implemented and (2) inform the KFO as soon as possible if the amount of take is exceeded or if any fat

pocketbook mussels are observed, injured, or crushed within the project area. The KYTC will report any results of monitoring, if done, to the KFO, as soon as possible.

9. CONSERVATION RECOMMENDATIONS

§7(a)(1) of the ESA directs Federal agencies to use their authorities to further the purposes of the ESA by conducting conservation programs for the benefit of endangered and threatened species. Conservation recommendations are discretionary activities that an action agency may undertake to avoid or minimize the adverse effects of a proposed action, implement recovery plans, or develop information that is useful for the conservation of listed species. The Service offers the following recommendation that is relevant to the listed species addressed in this BO.

- Provide financial assistance to the Kentucky Department of Fish and Wildlife Resources Center for Mollusk Conservation (CMC) to support programs that work to restore federally listed mussels and other native mussels. Such assistance could take the form of protecting or enhancing similar habitat and/or providing funding to the CMC facility to propagate federally listed mussels and other native mussels.

10. REINITIATION NOTICE

Formal consultation for the Action considered in this BO is concluded. Reinitiating consultation is required if the KYTC retains discretionary involvement or control over the Action (or is authorized by law) when:

- a. the amount or extent of incidental take is exceeded;
- b. new information reveals that the Action may affect listed species or designated critical habitat in a manner or to an extent not considered in this BO;
- c. the Action is modified in a manner that causes effects to listed species or designated critical habitat not considered in this BO; or
- d. a new species is listed or critical habitat designated that the Action may affect.

In instances where the amount or extent of incidental take is exceeded, the KYTC is required to immediately request a reinitiation of formal consultation. Please note that the Service cannot exempt from the applicable ESA prohibitions any Action-caused take that exceeds the amount or extent specified in the ITS of this BO that may occur before the reinitiated consultation is concluded.

11. LITERATURE CITED

Barnhart, M.C. 1997. Reproduction and Fish Hosts of Unionid Species of Concern. Prepared for the Missouri Department of Conservation, Columbia, Missouri. 35 pp.

Cummings, K.S., and C.A. Mayer. 1992. Field Guide to Freshwater Mussels of the Midwest. Illinois Natural History Survey Manual 5. 194 pp.

EA Engineering, Science, and Technology. 2005. Ohio River Unionid Monitoring 10-Year Summary Report (RM 204.3 to 206.0). 20 pp + appendices. Prepared for Ohio Municipal Electric Generation Agency-Joint Venture No. 5.

Ecological Services, Inc. 2003. Osage hydroelectric project (FERC No. 459) naiad population assessment. AmerenUE, St. Louis, MO.

Hunter, R.D., S.A. Toxzyłowski, and M.G. Janech. 1996. Zebra mussels in a small river: Impact on unionids. In F. D'itri (ed). Zebra Mussels and Other Aquatic Nuisance Species. Boca Raton: Lewis Publishers. pp. 161-186.

Logsdon, A. 2020. Personal communication with Phil DeGarmo and Dustin Boles. February 6, 2020.

National Park Service (NPS). 2006. Annual Report: Quantitative Assessment of Zebra Mussels at Native Mussel Beds in the Lower St. Croix River – 2005. Prepared for U.S. Army Corps of Engineers, St. Paul District. 16 pp + appendices.



NatureServe. 2007. NatureServe Explorer: An online encyclopedia of life [web application]. Version 6.2. NatureServe, Arlington, Virginia. Available <http://www.natureserve.org/explorer>. (Accessed: November 14 and 15, 2007).

Schloesser, D. W., T.F. Nalepa, and G.L. Mackie. 1996. Zebra mussel infestation of unionid bivalves (Unionidae) in North America. Amer. Zool. 36:300-310

U.S. Environmental Protection Agency (USEPA). 2007. Risks of Atrazine Use to Three Federally Listed Endangered Freshwater Mussels: Fat Pocketbook Pearly Mussel (*Potamilus capax*), Purple Cat's Paw Pearly Mussel (*Epioblasma obliquata obliquata*), and Northern Riffleshell (*Epioblasma torulosa rangiana*). Office of Pesticide Programs, Washington, DC.

U.S. Fish and Wildlife Service (USFWS). 1989. A Recovery Plan for the Fat Pocketbook Pearly Mussel *Potamilus capax* (Green 1832). USFWS Southeast Region, Atlanta, Georgia. 22 pp.

Watters, G.T. 2007. Ohio State University Mussel Host Database. Available at: <http://128.146.250.235/MusselHost/> (accessed 2007)

Habitat Acreage Cost Calculator for Use of the Imperiled Bat CMOA (January 2018)											
Project Number:	County: Livingston		Road:		US560		USFWS WFO-determined price per acre:		Aerial map showing project footprint, habitat acreage, and coordinates MUST be attached to this form. Multiple maps may be necessary.		
1-1142	# of Acres (lower constant)	# of Acres (higher constant)	Project Cost Per Acreage Type between APR 1 - AUG 15 If using higher constant*	# of Acres (lower constant)	# of Acres (higher constant)	Project Cost Per Acreage Type between OCT 14 - NOV 14	# of Acres (lower constant)	# of Acres (higher constant)	Project Cost Per Acreage Type between OCT 15 - NOV 14	3,820.00	70,288.00
Table from Appendix B of the April 2015 USFWS-EIO Conveyance Strategy for Forest Dwelling Bats in the Commonwealth of Kentucky	NOV 15 - MAR 31 all habitats unoccupied	APR 1 - AUG 15 swarming unoccupied	AUG 16 - OCT 14 swarming occupied	OCT 15 - NOV 14 swarming unoccupied							
Summer 1 + Swarming 1	2.5	3.0(4.0) ^{A, **}	\$	3.5		\$	3.5		\$		
Summer 1 + Swarming 2	2.0	2.5(3.5) ^{A, **}	\$	3.0		\$	3.0		\$		
Summer 2 + Swarming 1	2.0	2.5(3.5) ^{A, **}	\$	3.0		\$	3.0		\$		
Summer 2 + Swarming 2	1.5	2.0(3.0) ^{A, **}	\$	2.5		\$	2.5		\$		
Swarming 1	1.5	2.0(3.0) ^{A, **}	\$	2.5		\$	2.5		\$		
Swarming 2	1.0	1.5(2.5) ^{A, **}	\$	2.0	9.20	\$	2.0		\$		
Summer 1	1.5	2.0(3.0) ^{A, **}	\$	1.5		\$	1.5		\$		
Summer 2	1.0	1.5(2.5) ^{A, **}	\$	1.0		\$	1.0		\$		
Potential	0.5	1.0(2.0) ^{A, **}	\$	1.0		\$	1.0		\$		
SUBTOTALS	9.00	0.00	\$	9.20	0.00	\$	70,288.00	0.00	\$	0.00	\$
<p>* Spring emergence occurs close to the hibernacula entrances in the early spring when females emerging in early to mid-April and males emerging in late April and May. Swarming 1 habitat within 1 mile of P1 and P2 Indiana bat hibernacula entrances and Swarming 2 habitat within 1/2 mile of Indiana bat P1 and P2 hibernacula entrances or any northern long-eared bat hibernacula entrances will be considered occupied between April 1 - May 31. Projects within these areas require project-specific evaluation by the Services. A limited amount of impact under the CMOA process is available for impacts during the non-volant season, however additional mitigation is required for higher mortality to compensate for the increased severity of the impacts. Projects may not exceed 20 acres. (see page 15 of guidance)</p> <p>** Projects impacting known or potential habitat that requires tree clearing to occur June 1 - July 31 require project specific evaluation by the Services. A limited amount of impact under the CMOA process is available for impacts during the non-volant season, however additional mitigation is required for higher mortality to compensate for the increased severity of the impacts. Projects may not exceed 20 acres. (see page 15 of guidance)</p>											
<p>Comments: KYTC proposes to clear 9.2 acres of Swarming 2 habitat for the Indiana bat with seasonal restrictions that require NO TREE CLEARING FROM JUNE 1 THROUGH JULY 31. No impacts to winter habitat. The effects determination for the Indiana bat is "may affect, likely to adversely affect". The project area is Swarming habitat for the northern long-eared bat. KYTC proposes to use the 4d strategy process to address this species. The effects determination for the northern long-eared bat is "may affect, likely to adversely affect". No adverse effects anticipated. Final costs may vary.</p>											
<p>The amount listed above has been determined in accordance with the EIO Participation in CMOA for the Indiana bat and/or Northern Long-eared bat. Biological Opinions issued by the US Fish and Wildlife Service April 21, 2015, and any subsequent amendments thereto.</p>											
<p>Cassandra Cruikshank  February 24, 2020 February 24, 2020</p>											
<p>Chris Kuntz  2-24-20</p>											
<p>TOTAL ACRES: 9.20</p>										<p>9.20</p>	

SPECIAL NOTE FOR ENGINEERING-RELATED CONSULTING SERVICES

Livingston County; Item No. 1-1142.0 US 60 Bridge over Cumberland River

Because of their ongoing involvement with this project as consultants to the Department; Stantec Consulting Services Inc.; American Engineers, Inc.; Bacon, Farmer, Workman Engineering & Testing, Inc.; Cultural Resource Analysts, Inc.; and Third Rock Consultants, LLC will not be permitted to perform any consulting services (including but not limited to geotechnical drilling and/or environmental services) for the Prime Contractor or Subcontractors on this project due to the potential for conflict of interest. Other firms who have previously performed consulting services for the Department on this project may perform such services, subject to meeting applicable pre-qualification, experience, and/or other requirements.

SPECIAL NOTE FOR AHEAD STATION EMBANKMENT CONSTRUCTION

Livingston County; Item No. 1-1142.0 US 60 Bridge over Cumberland River

Settlement analysis performed at Station 134+00 predicted approximately 16 inches of settlement with approximately 90% of the settlement predicted to occur in approximately 1000 days or about 33 months. The plot on page 2 of this Special Note represents a graphical summary of estimated settlement vs. time. It should be noted that this plot does not consider that some settlement will occur during embankment construction. Because of the estimated settlement magnitude and time, construct the ahead station embankment (Stations 133+50 to 142+00) as one of the first construction operations on the project. Complete embankment construction in this station interval (in accordance with the project roadway drawings and Division 200 of the Standard Specifications for Road and Bridge Construction) to final subgrade elevation by no later than December 31, 2020. Failure to meet this date may result in liquidated damages as defined in the Special Note for Completion Date if such failure is the controlling event that results in not meeting the specified completion date.

The referenced plot is only an estimate and the actual field results are likely to vary. Therefore, furnish and install a settlement platform at Sta. 134+50, 25 ft. left of centerline, prior to the placement of the embankment fill from Station 133+50 to 142+00. Install the settlement platform in accordance with Section 216 of Standard Specifications for Road and Bridge Construction, current edition, and Standard Drawing RGX-015. Replace any settlement monitoring equipment destroyed or damaged by the Contractor at no additional cost to the Department.

Perform paving operations including: chemical stabilization and placement of crushed stone base and asphalt only after being directed to do so by the Engineer based on evaluation of the settlement data in conjunction with the project schedule.

Pile installation at Abutment 2 will not be dependent on evaluation of the settlement data.

The Department will measure and pay for the settlement platform items in accordance with Section 216 of the Standard Specifications. The estimated quantities are in the table below. These quantities are not included in the roadway or bridge drawings.

Bid Item Code	02692	03340	03343
Bid Item	Settlement Platform	Steel Pipe, 2 1/2-inch	Steel Pipe, 4-inch
Unit	EACH	LINEAR FOOT	LINEAR FOOT
Bid Quantity	1	35	35

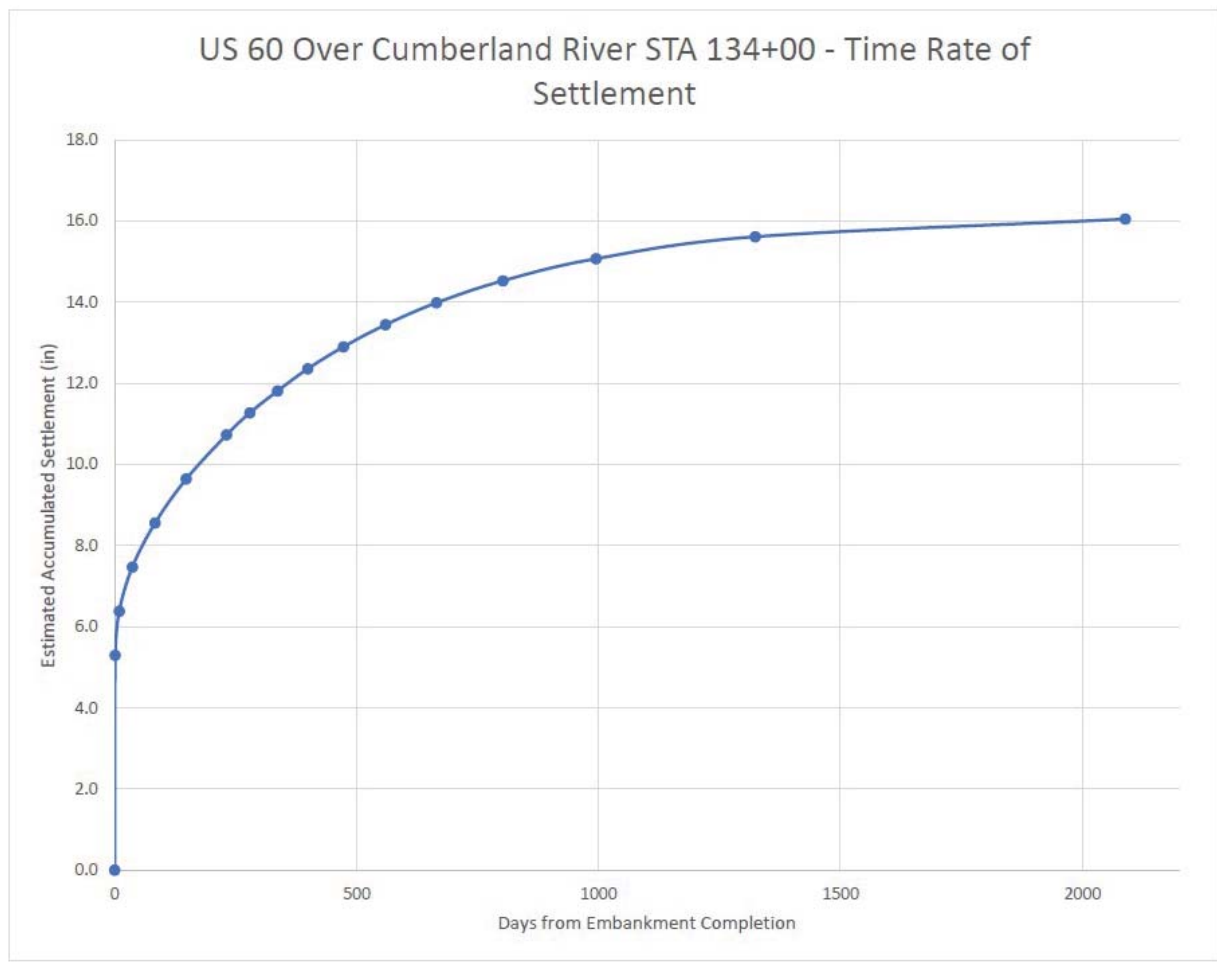

SPECIAL NOTE FOR ROCK CORE VIEWING

Livingston County – US 60 Bridge over the Cumberland River Item No. 1-1142.0

This special note has been revised since Addendum # 2 of CID-20-1015 was issued.

Contrary to Section 3.1.2 of the Special Note for Drilled Shafts, for this project, in light of the ongoing COVID-19 pandemic, viewing the sample photos posted in Project Related Information for “Livingston County STP BRO 0601 (196) US 60 Bridge over Cumberland River with Grade, Drain & Surface” on the Kentucky Transportation Cabinet’s Division of Construction Procurement website is equivalent to viewing the samples in person.

In order to satisfy the requirements of Section 3.1.2 of the Special Note for Drilled Shafts by viewing the photos of the available samples in lieu of an in person visit, submit an e-mail to Darrin Beckett (Darrin.Beckett@ky.gov) that states the following:

I have reviewed all of the supplied photos of the available rock core samples posted under project related information for “Livingston County STP BRO 0601 (196) US 60 Bridge over Cumberland River with Grade, Drain & Surface” and I do not require viewing the samples in person. I understand that if I have additional questions or concerns about the samples I have until 3:00 pm Eastern Daylight Time on Wednesday April 22, 2020 to submit a follow up question.

Contractors that have previously met the requirements for rock core viewing for this same project in the March 20, 2020 letting (CID 20-1015) will be considered to have met the requirements for the current project and are not required to submit an e-mail again in order to satisfy the conditions of this special note.

SPECIAL NOTE

For Tree Removal

**Livingston County
US 60 Smithland Bridge Replacement
Item No. 01-1142**

**NO CLEARING OF TREES 5 INCHES OR GREATER (DIAMETER BREAST
HEIGHT) FROM JUNE 1 THROUGH JULY 31.**

**If there are any questions regarding this note, please contact Danny Peake, Director,
Division of Environmental Analysis, 200 Mero Street, Frankfort, KY 40601, Phone:
(502) 564-7250.**

SPECIAL NOTE FOR CONCRETE SLURRY

If diamond grinding, grooving or any other process which produces slurry is required on roadways or bridges, the contractor shall ensure that all concrete slurry associated with these processes is collected, managed, and disposed of appropriately. The waste material shall be disposed of at a permitted disposal facility, in accordance with the Kentucky Standard Specifications for Road and Bridge Construction and the Environmental Performance Standards outlined in 401 KAR 47:030, or managed as a material for beneficial reuse. Any fines or remediation related to improper disposal shall be the sole responsibility of the contractor.

Disposal of concrete slurry will not be paid separately and shall be considered incidental to other bid items.

8/20/2019

SPECIAL NOTE FOR PIPELINE INSPECTION

1.0 DESCRIPTION. The Department will perform visual inspections on all pipe on the project. A video inspection will be required on projects having more than 250 linear feet of storm sewer and/or culvert pipe and on routes with an ADT of greater than 1,000 vehicles. Conduct video inspections on all pipe located under the roadway and 50 percent of the remaining pipe not under the roadway. Storm sewer runs and outfall pipes not under the roadway take precedence over rural entrance pipes. Contractors performing this item of work must be prequalified with the Department in the work type J51 (Video Pipe Inspection and Cleaning). Deflection testing shall be completed using a mandrel in accordance with the procedure outlined below or by physical measurement for pipes greater than 36 inches in diameter. Mandrel testing for deflection must be completed prior to the video inspection testing. Unless otherwise noted, Section references herein are to the Department's Standard Specifications for Road and Bridge Construction, current edition.

2.0 VIDEO INSPECTION. Ensure pipe is clear of water, debris or obstructions. Complete the video inspection and any necessary measurement prior to placing the final surface over any pipe. When paving will not be delayed, take measurements 30 days or more after the completion of earthwork to within 1 foot of the finished subgrade. Notify the Engineer a minimum of 24 hours in advance of inspection and notify the Engineer immediately if distresses or locations of improper installation are logged.

2.1 INSPECTION FOR DEFECTS AND DISTRESSES

A) Begin at the outlet end and proceed through to the inlet at a speed less than or equal to 30 ft/minute. Remove blockages that will prohibit a continuous operation.

B) Document locations of all observed defects and distresses including but not limited to: cracking, spalling, slabbing, exposed reinforcing steel, sags, joint offsets, joint separations, deflections, improper joints/connections, blockages, leaks, rips, tears, buckling, deviation from line and grade, damaged coatings/paved inverts, and other anomalies not consistent with a properly installed pipe.

C) During the video inspection provide a continuous 360 degree pan of every pipe joint.

D) Identify and measure all cracks greater than 0.1" and joint separations greater than 0.5".

E) Video Inspections are conducted from junction to junction which defines a pipe run. A junction is defined as a headwall, drop box inlet, curb box inlet, manhole, buried junction, or other structure that disturbs the continuity of the pipe. Multiple pipe inspections may be conducted from a single set up location, but each pipe run must be on a separate video file and all locations are to be referenced from nearest junction relative to that pipe run.

F) Record and submit all data on the TC 64-765 and TC 64-766 forms.

3.0 MANDREL TESTING. Mandrel testing will be used for deflection testing. For use on Corrugated Metal Pipe, High Density Polyethylene Pipe, and Polyvinyl Chloride Pipe, use a mandrel device with an odd number of legs (9 minimum) having a length not less than the outside diameter of the mandrel. The diameter of the mandrel at any point shall not be less than the diameter specified in Section 3.6. Mandrels can be a fixed size or a variable size.

3.1 Use a proving ring or other method recommended by the mandrel manufacturer to verify mandrel diameter prior to inspection. Provide verification documentation for each size mandrel to the Engineer.

3.2 All deflection measurements are to be based off of the AASHTO Nominal Diameters. Refer to the chart in section 3.6.

3.3 Begin by using a mandrel set to the 5.0% deflection limit. Place the mandrel in the inlet end of the pipe and pull through to the outlet end. If resistance is met prior to completing the entire run, record the maximum distance achieved from the inlet side, then remove the mandrel and continue the inspection from the outlet end of the pipe toward the inlet end. Record the maximum distance achieved from the outlet side.

3.4 If no resistance is met at 5.0% then the inspection is complete. If resistance occurred at 5.0% then repeat 3.1 and 3.2 with the mandrel set to the 10.0% deflection limit. If the deflection of entire pipe run cannot be verified with the mandrel then immediately notify the Engineer.

3.5 Care must be taken when using a mandrel in all pipe material types and lining/coating scenarios. Pipe damaged during the mandrel inspection will be video inspected to determine the extent of the damage. If the damaged pipe was video inspected prior to mandrel inspection then a new video inspection is warranted and supersedes the first video inspection. Immediately notify the Engineer of any damages incurred during the mandrel inspection and submit a revised video inspection report.

3.6 AASHTO Nominal Diameters and Maximum Deflection Limits.

Base Pipe Diameter (inches)	AASHTO Nominal Diameter (inches)	Max. Deflection Limit (inches)	
		5.0%	10.0%
15	14.76	14.02	13.28
18	17.72	16.83	15.95
24	23.62	22.44	21.26
30	29.53	28.05	26.58
36	35.43	33.66	31.89
42	41.34	39.27	37.21
48	47.24	44.88	42.52
54	53.15	50.49	47.84
60	59.06	56.11	53.15

4.0 PHYSICAL MEASUREMENT OF PIPE DEFLECTION. Alternate method for deflection testing when there is available access or the pipe is greater than 36 inches in diameter, as per 4.1. Use a contact or non-contact distance instrument. A leveling device is recommended for establishing or verifying vertical and horizontal control.

4.1 Physical measurements may be taken after installation and compared to the AASHTO Nominal Diameter of the pipe as per Section 3.6. When this method is used, determine the smallest interior diameter of the pipe as measured through the center point of the pipe (D2). All measurements are to be taken from the inside crest of the corrugation. Take the D2 measurements at the most deflected portion of the pipe run in question and at intervals no greater than ten (10) feet through the run. Calculate the deflection as follows:

$$\% \text{ Deflection} = [(AASHTO \text{ Nominal Diameter} - D2) / AASHTO \text{ Nominal Diameter}] \times 100\%$$

Note: The Engineer may require that preset monitoring points be established in the culvert prior to backfilling. For these points the pre-installation measured diameter (D1) is measured and recorded. Deflection may then be calculated from the following formula:

$$\% \text{ Deflection} = [(D1 - D2) / D1] (100\%)$$

4.2 Record and submit all data.

5.0 DEDUCTION SCHEDULE. All pipe deductions shall be handled in accordance with the tables shown below.

FLEXIBLE PIPE DEFLECTION	
Amount of Deflection (%)	Payment
0.0 to 5.0	100% of the Unit Bid Price
5.1 to 9.9	50% of the Unit Bid Price ⁽¹⁾
10 or greater	Remove and Replace ⁽²⁾

⁽¹⁾ Provide Structural Analysis for HDPE and metal pipe. Based on the structural analysis, pipe may be allowed to remain in place at the reduced unit price. ⁽²⁾ The Department may allow the pipe to remain in place with no pay to the Contractor in instances where it is in the best interest to the public and where the structural analysis demonstrates that the pipe should function adequately.

RIGID PIPE REMEDIATION TABLE PIPE	
Crack Width (inches)	Payment
≤ 0.1	100% of the Unit Bid Price
Greater than 0.1	Remediate or Replace ⁽¹⁾

(1) Provide the Department in writing a method for repairing the observed cracking. Do not begin work until the method has been approved.

6.0 PAYMENT. The Department will measure the quantity in linear feet of pipe to inspect. The Department will make payment for the completed and accepted quantities under the following:

<u>Code</u>	<u>Pay Item</u>	<u>Pay Unit</u>
24814EC	Pipeline Inspection	Linear Foot
10065NS	Pipe Deflection Deduction	Dollars

Special Note for Bridge Demolition, Renovation and Asbestos Abatement

If the project includes any bridge demolition or renovation, the successful bidder is required to notify Kentucky Division for Air Quality (KDAQ) via filing of form (DEP 7036) a minimum of 10 days prior to commencement of any bridge demolition or renovation work.

Any available information regarding possible asbestos containing materials (ACM) on or within bridges to be affected by the project has been included in the bid documents. These are to be included with the Contractor's notification filed with the KDAQ. If not included in the bid documents, the Department will provide that information to the successful bidder for inclusion in the KDAQ notice as soon as possible. If there are no documents stating otherwise, the bidders should assume there are no asbestos containing materials that will in any way affect the work.



Matthew G. Bevin
Governor

COMMONWEALTH OF KENTUCKY
TRANSPORTATION CABINET
Frankfort, Kentucky 40622
www.transportation.ky.gov/

Greg Thomas
Secretary

Asbestos Inspection Report

To: Brad Whybark

District: 1

Date: December 5, 2019

Conducted By: O'Dail Lawson

Report Prepared By: O'Dail Lawson

Project and Structure Identification

Project Number: Livingston 01-1142

Structure ID: 070B00017N

Structure Location: US 60 over the Cumberland Rviver

Sample Description: Any suspect materials collected were negative for asbestos.

Inspection Date: November 20th, 2019

Results and Recommendations

The results of the samples collected were negative for the presence of asbestos above 1%.
No abatement is required at this time.

It is recommended that this report accompany the 10-Day Notice of Intent for Demolition ([DEP7036 Form](#)) which is to be submitted to the Kentucky Division of Air Quality prior to abatement, demolition, or renovation of any building or structure in the Commonwealth.





Chain of Custody Record

Kentucky Transportation Cabinet

200 Metro Street, 5th Floor West
Frankfort, Kentucky 40622
(502) 564-7250 fax (502) 564-5655

O'Dail Lawson KYTC Client Information KY TRANS CABINET 070800017A

Address: 200 Metro Street Frankfort KY
Phone: 502-564-7250 Fax: 502-564-5655
Results Code: ND = None Detected
FTD = Filter Tampering or Damaged
N/A = Not Applicable

Project or Subject Reference: Livingston 01-1142
Samplers (signature): *Oliver Penn*

Sample ID	Sample Description	Collected		Analysis Requested	Grab/Comp.	No. of Cont.	Cont. Type	Preservative
		Date	Time					
L1	Joint Compang	11/20/19	13:30	Asbestos bulk	grey	MMSB		N/A
L2	Trawl and Sealant				brown	sealant		

Relinquished By: _____ Date/Time: _____

Received By: *Stephens Mandy* Date/Time: *11/24/19*

Relinquished By: _____ Date/Time: _____

Received at Lab By: _____ Date/Time: _____

ENVIRONMENTAL TRAINING CONCEPTS, INC
P.O. Box 99603 Louisville, KY 40269
(502)640-2951

Certification Number: ETC-AIR-041619-00415

O'Dail Lawson

has on 04-16-2019, attended and successfully completed the requirements and passed the examination with a score of 70% of better on the entitled course.

ASBESTOS INSPECTOR REFRESHER

Training was in accordance with 40 CFR Part 763 (AHERA) approved by the Commonwealth of Kentucky, the Indiana Department of Environmental Management and Tennessee Department of Environment & Conservation The above student received requisite training for Asbestos Accreditation under Title II of the Toxic Substance Act (TSCA).

Conducted at: 1520 Alliant Ave., Louisville, KY



Maine - Training Manager

Expiration Date: 04-16-2020



Name - Instructor

	KENTUCKY TRANSPORTATION CABINET Department of Highways DIVISION OF RIGHT OF WAY & UTILITIES RIGHT OF WAY CERTIFICATION	TC 62-226 Rev. 01/2016 Page 1 of 1
--	--	--

<input checked="" type="checkbox"/>	Original	<input type="checkbox"/>	Re-Certification	RIGHT OF WAY CERTIFICATION			
ITEM #		COUNTY		PROJECT # (STATE)		PROJECT # (FEDERAL)	
01-1142.00		LIVINGSTON		12F0 FD52 070 8684701R		STP BRO 0601 (193)	
PROJECT DESCRIPTION							
REPLACE BRIDGE ON US 60 OVER THE CUMBERLAND RIVER 0.27 MILE NORTH OF KY 70.							
<input type="checkbox"/> No Additional Right of Way Required							
Construction will be within the limits of the existing right of way. The right of way was acquired in accordance to FHWA regulations under the Uniform Relocation Assistance and Real Property Acquisitions Policy Act of 1970, as amended. No additional right of way or relocation assistance were required for this project.							
<input checked="" type="checkbox"/> Condition # 1 (Additional Right of Way Required and Cleared)							
All necessary right of way, including control of access rights when applicable, have been acquired including legal and physical possession. Trial or appeal of cases may be pending in court but legal possession has been obtained. There may be some improvements remaining on the right-of-way, but all occupants have vacated the lands and improvements, and KYTC has physical possession and the rights to remove, salvage, or demolish all improvements and enter on all land. Just Compensation has been paid or deposited with the court. All relocations have been relocated to decent, safe, and sanitary housing or that KYTC has made available to displaced persons adequate replacement housing in accordance with the provisions of the current FHWA directive.							
<input type="checkbox"/> Condition # 2 (Additional Right of Way Required with Exception)							
The right of way has not been fully acquired, the right to occupy and to use all rights-of-way required for the proper execution of the project has been acquired. Some parcels may be pending in court and on other parcels full legal possession has not been obtained, but right of entry has been obtained, the occupants of all lands and improvements have vacated, and KYTC has physical possession and right to remove, salvage, or demolish all improvements. Just Compensation has been paid or deposited with the court for most parcels. Just Compensation for all pending parcels will be paid or deposited with the court prior to AWARD of construction contract							
<input type="checkbox"/> Condition # 3 (Additional Right of Way Required with Exception)							
The acquisition or right of occupancy and use of a few remaining parcels are not complete and/or some parcels still have occupants. All remaining occupants have had replacement housing made available to them in accordance with 49 CFR 24.204. KYTC is hereby requesting authorization to advertise this project for bids and to proceed with bid letting even though the necessary right of way will not be fully acquired, and/or some occupants will not be relocated, and/or the just compensation will not be paid or deposited with the court for some parcels until after bid letting. KYTC will fully meet all the requirements outlined in 23 CFR 635.309(c)(3) and 49 CFR 24.102(j) and will expedite completion of all acquisitions, relocations, and full payments after bid letting and prior to AWARD of the construction contract or force account construction.							
Total Number of Parcels on Project		7		EXCEPTION (S) Parcel #		ANTICIPATED DATE OF POSSESSION WITH EXPLANATION	
Number of Parcels That Have Been Acquired							
Signed Deed		6					
Condemnation		1					
Signed ROE							
Notes/ Comments (Use Additional Sheet if necessary)							
Related to the (1) Condemnation Parcel: Parcel #31 had an IOJ date of 11/21/18 and Right Of Entry was obtained 11/21/18.							
LPA RW Project Manager				Right of Way Supervisor			
Printed Name				Printed Name		Greg L. Morgan	
Signature				Signature		Digitally signed by Greg L. Morgan Date: 2019.10.30 10:48:04	
Date				Date		-05'00'	
Right of Way Director				FHWA			
Printed Name				Printed Name			
Signature				Signature		No Signature Required as per FHWA-KYTC Current Stewardship Agreement	
Date		2019.11.04 09:56:13 -06'00'		Date			

UTILITIES AND RAIL CERTIFICATION NOTE

Livingston County
STPBRO0601196
FD52 070 8684701U
Mile point: 12.524 TO 12.868
ADDRESS DEFICIENCIES OF BRIDGE ON US 60 OVER THE CUMBERLAND RIVER 0.27 MILE N OF KY 70
070B00017N.
ITEM NUMBER: 01-1142.00

PROJECT NOTES ON UTILITIES

Please call KY 811 before any underground activity takes place, and contact utilities that do not participate in KY 811. KYTC expects the contractor to make every effort to protect all utilities from damage.

NOTE: DO NOT DISTURB THE FOLLOWING FACILITIES LOCATED WITHIN THE PROJECT DISTURB LIMITS

Crittenden-Livingston Water District - Water

Windstream dba Kentucky Data Link (KDL) - Communication

City of Smithland - Sewer

City of Smithland - Water

The Contractor is fully responsible for protection of all utilities listed above

THE FOLLOWING FACILITY OWNERS ARE RELOCATING/ADJUSTING THEIR FACILITIES WITHIN THE PROJECT LIMITS AND WILL BE COMPLETE PRIOR TO CONSTRUCTION

Jackson Purchase Energy Corp - Electric, Completion date: 04/30/2020. Will all be on the north side of the bridge, and will be relocating their lines to the east side of existing US 60

UTILITIES AND RAIL CERTIFICATION NOTE

<p>Livingston County STPBRO0601196 FD52 070 8684701U Mile point: 12.524 TO 12.868 ADDRESS DEFICIENCIES OF BRIDGE ON US 60 OVER THE CUMBERLAND RIVER 0.27 MILE N OF KY 70 070B00017N. ITEM NUMBER: 01-1142.00</p>

THE FOLLOWING FACILITY OWNERS HAVE FACILITIES TO BE RELOCATED/ADJUSTED BY THE OWNER OR THEIR SUBCONTRACTOR AND IS TO BE COORDINATED WITH THE ROAD CONTRACT

Windstream dba Kentucky Data Link (KDL) – Communication, will have relocations that cannot begin until the new conduit under the new bridge is in place. Please coordinate phasing with their relocation.

THE FOLLOWING FACILITY OWNERS HAVE FACILITIES TO BE RELOCATED/ADJUSTED BY THE ROAD CONTRACTOR AS INCLUDED IN THIS CONTRACT

Jackson Purchase Energy Corp – Electric, will have a 3” conduit installed in the barrier wall of the new bridge.

Windstream dba Kentucky Data Link (KDL) – Communication, Will have two (2) 4” conduits installed under the new bridge.

The City of Smithland will have Water and Sewer relocations included in the plans. (see plans)

Crittenden-Livingston Water District – Water will have a 6” water line relocated under KY 2610 (see plans)

RAIL COMPANIES HAVE FACILITIES IN CONJUNCTION WITH THIS PROJECT AS NOTED

No Rail Involvement Rail Involved Rail Adjacent

UTILITIES AND RAIL CERTIFICATION NOTE

Livingston County
STPBRO0601196
FD52 070 8684701U
Mile point: 12.524 TO 12.868
ADDRESS DEFICIENCIES OF BRIDGE ON US 60 OVER THE CUMBERLAND RIVER 0.27 MILE N OF KY 70
070B00017N.
ITEM NUMBER: 01-1142.00

AREA FACILITY OWNER CONTACT LIST

Facility Owner	Address	Contact Name	Phone	Email
City of Smithland - Sewer	310 Wilson Avenue Smithland KY 42081	Chuck Black	2709284890	scww1@windstream.net
City of Smithland - Water	310 Wilson Avenue Smithland KY 42081	Chuck Black	2709284890	scww1@windstream.net
Crittenden-Livingston Water District - Water	620 East Main Street Salem KY 42078	Ronny Sladen	2709882680	ajdossett@tds.net
Jackson Purchase Energy Corp - Electric	PO Box 4030 Paducah KY 42002	Scott Ribble	2704427321	scott.ribbon@JPEnergy.com
Windstream dba Kentucky Data Link (KDL) - Communication	3701 Communications Way Evansville IN 47715	Rick Cunico	8127606602	wci.maintenance.south@windstream.com

KyTC BMP Plan for Project CID 01 - 801



Kentucky Transportation Cabinet

Highway District 1

And

_____ **(2), Construction**

Kentucky Pollutant Discharge Elimination System

Permit KYR10

Best Management Practices (BMP) plan

Groundwater protection plan

For Highway Construction Activities

For

Replace Bridge and Approaches on US 60

Over Cumberland River

Livingston County, KY

Project: PCN ##-####

KPDES BMP Plan Page 1 of 14

Revised 3/4/2016

KyTC BMP Plan for Project CID 01 - 801

Project information

Note – (1) = Design (2) = Construction (3) = Contractor

1. Owner – Kentucky Transportation Cabinet, District 1
2. Resident Engineer: (2)
3. Contractor name: (2)
Address: (2)

Phone number: (2)
Contact: (2)
Contractors agent responsible for compliance with the KPDES permit requirements (3):
4. Project Control Number (2)
5. Route (Address) US 60, Smithland KY 42081
6. Latitude/Longitude (project mid-point) 37^08'55"N, 88^23'58"W
7. County (project mid-point) - Livingston
8. Project start date (date work will begin): (2)
9. Projected completion date: (2)

KyTC BMP Plan for Project CID 01 - 801

A. Site description:

1. Nature of Construction Activity (from letting project description) – Replace bridge and approaches on US 60 over the Cumberland River, including demolition of existing bridge
2. Order of major soil disturbing activities (2) and (3)
3. Projected volume of material to be moved 67,588 CY
4. Estimate of total project area (acres) 24.65 acres
5. Estimate of area to be disturbed (acres) 24.65 acres
6. Post construction runoff coefficient will be included in the project drainage folder. Persons needing information pertaining to the runoff coefficient will contact the resident engineer to request this information.
7. Data describing existing soil condition - The geologic mapping indicates that alluvial soils consisting of sand, silt, sandy gravel, and cherty rubble are present at the site.
8. Data describing existing discharge water quality (if any) (1) & (2)
9. Receiving water name – Cumberland River
10. TMDLs and Pollutants of Concern in Receiving Waters: (1 DEA)
11. Site map – Project layout sheet plus the erosion control sheets in the project plans that depict Disturbed Drainage Areas (DDAs) and related information. These sheets depict the existing project conditions with areas delineated by DDA (drainage area bounded by watershed breaks and right of way limits), the storm water discharge locations (either as a point discharge or as overland flow) and the areas that drain to each discharge point. These plans define the limits of areas to be disturbed and the location of control measures. Controls will be either site specific as designated by the designer or will be annotated by the contractor and resident engineer before disturbance commences. The project layout sheet shows the surface waters and wetlands.
12. Potential sources of pollutants:

KyTC BMP Plan for Project CID 01 - 801

The primary source of pollutants is solids that are mobilized during storm events. Other sources of pollutants include oil/fuel/grease from servicing and operating construction equipment, concrete washout water, sanitary wastes and trash/debris. (3)

B. Sediment and Erosion Control Measures:

1. Plans for highway construction projects will include erosion control sheets that depict Disturbed Drainage Areas (DDAs) and related information. These plan sheets will show the existing project conditions with areas delineated by DDA within the right of way limits, the discharge points and the areas that drain to each discharge point. Project managers and designers will analyze the DDAs and identify Best Management Practices (BMPs) that are site specific. The balance of the BMPs for the project will be listed in the bid documents for selection and use by the contractor on the project with approval by the resident engineer.

Projects that do not have DDAs annotated on the erosion control sheets will employ the same concepts for development and managing BMP plans.

2. Following award of the contract, the contractor and resident engineer will annotate the erosion control sheets showing location and type of BMPs for each of the DDAs that will be disturbed at the outset of the project. This annotation will be accompanied by an order of work that reflects the order or sequence of major soil moving activities. The remaining DDAs are to be designated as "Do Not Disturb" until the contractor and resident engineer prepare the plan for BMPs to be employed. The initial BMP's shall be for the first phase (generally Clearing and Grubbing) and shall be modified as needed as the project changes phases. The BMP Plan will be modified to reflect disturbance in additional DDA's as the work progresses. All DDA's will have adequate BMP's in place before being disturbed.
3. As DDAs are prepared for construction, the following will be addressed for the project as a whole or for each DDA as appropriate:
 - Construction Access – This is the first land-disturbing activity. As soon as construction begins, bare areas will be stabilized with gravel and temporary mulch and/or vegetation.
 - At the beginning of the project, all DDAs for the project will be inspected for areas that are a source of storm water pollutants.

KyTC BMP Plan for Project CID 01 - 801

Areas that are a source of pollutants will receive appropriate cover or BMPs to arrest the introduction of pollutants into storm water. Areas that have not been opened by the contractor will be inspected periodically (once per month) to determine if there is a need to employ BMPs to keep pollutants from entering storm water.

- Clearing and Grubbing – The following BMP's will be considered and used where appropriate.
 - Leaving areas undisturbed when possible.
 - Silt basins to provide silt volume for large areas.
 - Silt Traps Type A for small areas.
 - Silt Traps Type C in front of existing and drop inlets which are to be saved
 - Diversion ditches to catch sheet runoff and carry it to basins or traps or to divert it around areas to be disturbed.
 - Brush and/or other barriers to slow and/or divert runoff.
 - Silt fences to catch sheet runoff on short slopes. For longer slopes, multiple rows of silt fence may be considered.
 - Temporary Mulch for areas which are not feasible for the fore mentioned types of protections.
 - Non-standard or innovative methods.
- Cut & Fill and placement of drainage structures - The BMP Plan will be modified to show additional BMP's such as:
 - Silt Traps Type B in ditches and/or drainways as they are completed
 - Silt Traps Type C in front of pipes after they are placed
 - Channel Lining
 - Erosion Control Blanket
 - Temporary mulch and/or seeding for areas where construction activities will be ceased for 21 days or more.
 - Non-standard or innovative methods
- Profile and X-Section in place – The BMP Plan will be modified to show elimination of BMP's which had to be removed and the addition of new BMP's as the roadway was shaped. Probably changes include:
 - Silt Trap Type A, Brush and/or other barriers, Temporary Mulch, and any other BMP which had to be removed for final grading to take place.
 - Additional Silt Traps Type B and Type C to be placed as final drainage patterns are put in place.
 - Additional Channel Lining and/or Erosion Control Blanket.
 - Temporary Mulch for areas where Permanent Seeding and Protection cannot be done within 21 days.
 - Special BMP's such as Karst Policy

KyTC BMP Plan for Project CID 01 - 801

- Finish Work (Paving, Seeding, Protect, etc.) – A final BMP Plan will result from modifications during this phase of construction. Probably changes include:
 - Removal of Silt Traps Type B from ditches and drainways if they are protected with other BMP's which are sufficient to control erosion, i.e. Erosion Control Blanket or Permanent Seeding and Protection on moderate grades.
 - Permanent Seeding and Protection
 - Placing Sod
 - Planting trees and/or shrubs where they are included in the project
- BMP's including Storm Water Management Devices such as velocity dissipation devices and Karst policy BMP's to be installed during construction to control the pollutants in storm water discharges that will occur after construction has been completed are : Channel Lining

C. Other Control Measures

1. No solid materials, including building materials, shall be discharged to waters of the commonwealth, except as authorized by a Section 404 permit.
2. Waste Materials

All waste materials that may leach pollutants (paint and paint containers, caulk tubes, oil/grease containers, liquids of any kind, soluble materials, etc.) will be collected and stored in appropriate covered waste containers. Waste containers shall be removed from the project site on a sufficiently frequent basis as to not allow wastes to become a source of pollution. All personnel will be instructed regarding the correct procedure for waste disposal. Wastes will be disposed in accordance with appropriate regulations. Notices stating these practices will be posted in the office.

3. Hazardous Waste

All hazardous waste materials will be managed and disposed of in the manner specified by local or state regulation. The contractor shall notify the Section Engineer if there any hazardous wastes being generated at the project site and how these wastes are being managed. Site personnel will be instructed with regard to proper storage and handling of hazardous wastes when required. The Transportation Cabinet will file for generator, registration when appropriate, with the Division of Waste Management and advise the contractor regarding waste management requirements.

KyTC BMP Plan for Project CID 01 - 801

4. Spill Prevention

The following material management practices will be used to reduce the risk of spills or other exposure of materials and substances to the weather and/or runoff.

➤ **Good Housekeeping:**

The following good housekeeping practices will be followed onsite during the construction project.

- An effort will be made to store only enough product required to do the job
- All materials stored onsite will be stored in a neat, orderly manner in their appropriate containers and, if possible, under a roof or other enclosure
- Products will be kept in their original containers with the original manufacturer's label
- Substances will not be mixed with one another unless recommended by the manufacturer
- Whenever possible, all of the product will be used up before disposing of the container
- Manufacturers' recommendations for proper use and disposal will be followed
- The site contractor will inspect daily to ensure proper use and disposal of materials onsite

➤ **Hazardous Products:**

These practices will be used to reduce the risks associated with any and all hazardous materials.

- Products will be kept in original containers unless they are not resealable
- Original labels and material safety data sheets (MSDS) will be reviewed and retained
- Contractor will follow procedures recommended by the manufacturer when handling hazardous materials
- If surplus product must be disposed of, manufacturers' or state/local recommended methods for proper disposal will be followed

The following product-specific practices will be followed onsite:

➤ **Petroleum Products:**

KyTC BMP Plan for Project CID 01 - 801

Vehicles and equipment that are fueled and maintained on site will be monitored for leaks, and receive regular preventative maintenance to reduce the chance of leakage. Petroleum products onsite will be stored in tightly sealed containers, which are clearly labeled and will be protected from exposure to weather.

The contractor shall prepare an Oil Pollution Spill Prevention Control and Countermeasure plan when the project that involves the storage of petroleum products in 55 gallon or larger containers with a total combined storage capacity of 1,320 gallons. This is a requirement of 40 CFR 112.

This project (will / will not) (3) have over 1,320 gallons of petroleum products with a total capacity, sum of all containers 55 gallon capacity and larger.

➤ **Fertilizers:**

Fertilizers will be applied at rates prescribed by the contract, standard specifications or as directed by the resident engineer. Once applied, fertilizer will be covered with mulch or blankets or worked into the soil to limit exposure to storm water. Storage will be in a covered shed. The contents of any partially used bags of fertilizer will be transferred to a sealable plastic bin to avoid spills.

➤ **Paints:**

All containers will be tightly sealed and stored indoors or under roof when not being used. Excess paint or paint wash water will not be discharged to the drainage or storm sewer system but will be properly disposed of according to manufacturers' instructions or state and local regulations.

➤ **Concrete Truck Washout:**

Concrete truck mixers and chutes will not be washed on pavement, near storm drain inlets, or within 75 feet of any ditch, stream, wetland, lake, or sinkhole. Where possible, excess concrete and wash water will be discharged to areas prepared for pouring new concrete, flat areas to be paved that are away from ditches or drainage system features, or other locations that will not drain off site. Where this approach is not possible, a shallow earthen wash basin will be excavated away from ditches to receive the wash water

➤ **Spill Control Practices**

In addition to the good housekeeping and material management practices discussed in the previous sections of this plan, the following practices will be followed for spill prevention and cleanup:

KyTC BMP Plan for Project CID 01 - 801

- Manufacturers' recommended methods for spill cleanup will be clearly posted. All personnel will be made aware of procedures and the location of the information and cleanup supplies.
- Materials and equipment necessary for spill cleanup will be kept in the material storage area. Equipment and materials will include as appropriate, brooms, dust pans, mops, rags, gloves, oil absorbents, sand, sawdust, and plastic and metal trash containers.
- All spills will be cleaned up immediately after discovery.
- The spill area will be kept well ventilated and personnel will wear appropriate protective clothing to prevent injury from contact with a hazardous substance.
- Spills of toxic or hazardous material will be reported to the appropriate state/local agency as required by KRS 224 and applicable federal law.
- The spill prevention plan will be adjusted as needed to prevent spills from reoccurring and improve spill response and cleanup.
- Spills of products will be cleaned up promptly. Wastes from spill clean up will be disposed in accordance with appropriate regulations.

D. Other State and Local Plans

This BMP plan shall include any requirements specified in sediment and erosion control plans, storm water management plans or permits that have been approved by other state or local officials. Upon submittal of the NOI, other requirements for surface water protection are incorporated by reference into and are enforceable under this permit (even if they are not specifically included in this BMP plan). This provision does not apply to master or comprehensive plans, non-enforceable guidelines or technical guidance documents that are not identified in a specific plan or permit issued for the construction site by state or local officials. (1)

E. Maintenance

1. The BMP plan shall include a clear description of the maintenance procedures necessary to keep the control measures in good and effective operating condition.
- Maintenance of BMPs during construction shall be a result of weekly and post rain event inspections with action being taken by the contractor to correct deficiencies.
 - Post Construction maintenance will be a function of normal highway maintenance operations. Following final project acceptance by the cabinet, district highway crews will be responsible for identification and correction of deficiencies regarding ground cover and cleaning of storm water BMPs. The project manager shall identify any BMPs that will be for

KyTC BMP Plan for Project CID 01 - 801

the purpose of post construction storm water management with specific guidance for any non-routine maintenance. (1)

F. Inspections

Inspection and maintenance practices that will be used to maintain erosion and sediment controls:

- All erosion prevention and sediment control measures will be inspected at least once each week and following any rain of one-half inch or more.
- Inspections will be conducted by individuals that have successfully completed the KEPSC-RI course as required by Section 213.02.02 of the Standard Specifications for Road and Bridge Construction, current edition.
- Inspection reports will be written, signed, dated, and kept on file.
- Areas at final grade will be seeded and mulched within 14 days.
- Areas that are not at final grade where construction has ceased for a period of 21 days or longer and soil stock piles shall receive temporary mulch no later than 14 days from the last construction activity in that area.
- All measures will be maintained in good working order; if a repair is necessary, it will be initiated within 24 hours of being reported.
- Built-up sediment will be removed from behind the silt fence before it has reached halfway up the height of the fence.
- Silt fences will be inspected for bypassing, overtopping, undercutting, depth of sediment, tears, and to ensure attachment to secure posts.
- Sediment basins will be inspected for depth of sediment, and built-up sediment will be removed when it reaches 50 percent of the design capacity and at the end of the job.
- Diversion dikes and berms will be inspected and any breaches promptly repaired. Areas that are eroding or scouring will be repaired and re-seeded / mulched as needed.
- Temporary and permanent seeding and mulching will be inspected for bare spots, washouts, and healthy growth. Bare or eroded areas will be repaired as needed.
- All material storage and equipment servicing areas that involve the management of bulk liquids, fuels, and bulk solids will be inspected weekly for conditions that represent a release or possible release of pollutants to the environment.

KyTC BMP Plan for Project CID 01 - 801

G. Non – Storm Water discharges

It is expected that non-storm water discharges may occur from the site during the construction period. Examples of non-storm water discharges include:

- Water from water line flushings.
- Water from cleaning concrete trucks and equipment.
- Pavement wash waters (where no spills or leaks of toxic or hazardous materials have occurred).
- Uncontaminated groundwater and rain water (from dewatering during excavation).

All non-storm water discharges will be directed to the sediment basin or to a filter fence enclosure in a flat vegetated infiltration area or be filtered via another approved commercial product.

H. Groundwater Protection Plan (3)

This plan serves as the groundwater protection plan as required by 401 KAR 5:037.

- Contractors statement: (3)

The following activities, as enumerated by 401 KAR 5:037 Section 2 that require the preparation and implementation of a groundwater protection plan, will or may be may be conducted as part of this construction project:

_____ 2. (e) land treatment or land disposal of a pollutant;

_____ 2. (f) Storing, ..., or related handling of hazardous waste, solid waste or special waste, ..., in tanks, drums, or other containers, or in piles, (This does not include wastes managed in a container placed for collection and removal of municipal solid waste for disposal off site);

_____ 2. (g) Handling of materials in bulk quantities (equal or greater than 55 gallons or 100 pounds net dry weight transported held in an individual container) that, if released to the environment, would be a pollutant;

_____ 2. (j) Storing or related handling of road oils, dust suppressants,, at a central location;

KyTC BMP Plan for Project CID 01 - 801

_____ 2. (k) Application or related handling of road oils, dust suppressants or deicing materials, (does not include use of chloride-based deicing materials applied to roads or parking lots);

_____ 2. (m) Installation, construction, operation, or abandonment of wells, bore holes, or core holes, (this does not include bore holes for the purpose of explosive demolition);

Or, check the following only if there are no qualifying activities

_____ There are no activities for this project as listed in 401 KAR 5:037 Section 2 that require the preparation and implementation of a groundwater protection plan.

The contractor is responsible for the preparation of a plan that addresses the

401 KAR 5:037 Section 3. (3) Elements of site specific groundwater protection plan:

- (a) General information about this project is covered in the Project information;
- (b) Activities that require a groundwater protection plan have been identified above;
- (c) Practices that will protect groundwater from pollution are addressed in section C. Other control measures.
- (d) Implementation schedule – all practices required to prevent pollution of groundwater are to be in place prior to conducting the activity;
- (e) Training is required as a part of the ground water protection plan. All employees of the contractor, sub-contractor and resident engineer personnel will be trained to understand the nature and requirements of this plan as they pertain to their job function(s). Training will be accomplished within one week of employment and annually thereafter. A record of training will be maintained by the contractor with a copy provide to the resident engineer.
- (f) Areas of the project and groundwater plan activities will be inspected as part of the weekly sediment and erosion control inspections
- (g) Certification (see signature page.)

SPECIAL NOTE

Filing of eNOI for KPDES Construction Stormwater Permit

County: Livingston

Route: US 60

Item No.: 1-1142.00

KDOW Submittal ID:

Project Description: Construct new bridge on US 60 over Cumberland River

A Notice of Intent for obtaining coverage under the Kentucky Pollutant Discharge Elimination System (KPDES) General Permit for Stormwater Discharges Associated with Construction Activities (KYR10) has been drafted, copy of which is attached. Upon award, the Contractor will be identified in Section III of the form as the “Building Contractor” and it will be submitted for approval to the Kentucky Division of Water. The Contractor shall be responsible for advancing the work in a manner that is compliant with all applicable and appropriate KYTC specifications for sediment and erosion control as well as meeting the requirements of the KYR10 permit and the KDOW.

If there are any questions regarding this note, please contact Danny Peake, Director, Division of Environmental Analysis, TCOB, 200 Mero Street, Frankfort, KY 40622, Phone: (502) 564-7250.

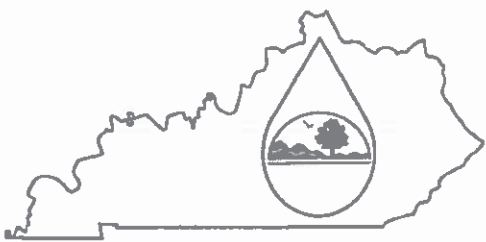
	<h2 style="margin:0;">KENTUCKY POLLUTION DISCHARGE ELIMINATION SYSTEM (KPDES)</h2> <p style="margin:0;">Notice of Intent (NOI) for coverage of Storm Water Discharge Associated with Construction Activities Under the KPDES Storm Water General Permit KYR100000</p> <p style="margin:0;">Click here for Instructions (Controls/KPDES_FormKYR10_Instructions.htm)</p> <p style="margin:0;">Click here to obtain information and a copy of the KPDES General Permit. (http://dep.ky.gov/formslibrary/Documents/KYR10PermitPage.pdf)</p> <p style="margin:0;">(*) Indicates a required field; (✓) Indicates a field may be required based on user input or is an optionally required field</p>
---	--

Reason for Submittal: (*) Application for New Permit Coverage ▾	Agency Interest ID: Agency Interest ID	Permit Number: (✓) KPDES Permit Number
--	---	---

If change to existing permit coverage is requested, describe the changes for which modification of coverage is being sought: (✓)

ELIGIBILITY:
Stormwater discharges associated with construction activities disturbing individually one (1) acre or more, including, in the case of a common plan of development, contiguous construction activities that cumulatively equal one (1) acre or more of disturbance.

EXCLUSIONS:
The following are excluded from coverage under this general permit:

- 1) Are conducted at or on properties that have obtained an individual KPDES permit for the discharge of other wastewaters which requires the development and implementation of a Best Management Practices (BMP) plan;
- 2) Any operation that the DOW determines an individual permit would better address the discharges from that operation;
- 3) Any project that discharges to an Impaired Water listed in the most recent Integrated Report, §305(b) as impaired for sediment and for which an approved TMDL has been developed.

SECTION I – FACILITY OPERATOR INFORMATION (PERMITTEE)

Company Name: (✓) KYTC	First Name (✓) Kyle	M.I.: M	Last Name: (✓) Poat
Mailing Address: (*) US 60 - Livingston County	City: (*) Smithland	State: (*) Kentucky ▾	Zip: (*) 42071
eMail Address (*) kyle.poat@ky.gov	Business Phone (*) 2708982431	Alternate Phone: 2702102398_	

SECTION II – GENERAL SITE LOCATION INFORMATION

Project Name (*) Smithland Bridge Replacement – SYP item#01-1142	Status of Owner/Operator (*) State Government ▾	SIC Code (*) 1622 Bridge, Tunnel, and Elevat: ▾
Company Name: (✓) KYTC	First Name: (✓) Kyle	M.I.: M
Last Name: (✓) Poat		
Site Physical Address (*) US 60		
City: (*) Smithland	State (*) Kentucky ▾	Zip (*) Zip
County: (*) Livingston ▾	Latitude(decimal degrees)(*)DMS to DD Converter (https://www.fcc.gov/media/radio/dms-decimal) 37.148611	Longitude(decimal degrees)(*) 88.399444

SECTION III – SPECIFIC SITE ACTIVITY INFORMATION [?](#)

Project Description (*)
Replacement and Road Approach for Lucy Jefferson Lewis Memorial Bridge over Cumberland River on US 60

a. For single projects provide the following information

Total Number of Acres in Project: (✓)	Total Number of Acres Disturbed (✓)
---------------------------------------	-------------------------------------

24.65	24.65
Anticipated Start Date:(✓) 5/1/2020	Anticipated Completion Date:(✓) 9/1/2023

b. For common plans of development provide the following information

Total Number of Acres in Project.(✓) # Acre(s)	Total Number of Acres Disturbed (✓) # Acre(s)
Number of individual lots in development, if applicable:(✓) # lot(s)	Number of lots in development:(✓) # lot(s)
Total acreage of lots intended to be developed (✓) Project Acres	Number of acres intended to be disturbed at any one time (✓) Disturbed Acres
Anticipated Start Date (✓)	Anticipated Completion Date (✓)

List Building Contractor(s) at the time of Application (*)

Company Name
+

SECTION IV -- IF THE PERMITTED SITE DISCHARGES TO A WATER BODY THE FOLLOWING INFORMATION IS REQUIRED (?)

Discharge Point(s):

Unnamed Tributary?	Latitude	Longitude	Receiving Water Name
+			

SECTION V -- IF THE PERMITTED SITE DISCHARGES TO A MS4 THE FOLLOWING INFORMATION IS REQUIRED (?)

Name of MS4:

Date of application/notification to the MS4 for construction site permit coverage:

Date	Discharge Point(s) (*)				
	<table border="1"> <thead> <tr> <th>Latitude</th> <th>Longitude</th> </tr> </thead> <tbody> <tr> <td>+</td> <td></td> </tr> </tbody> </table>	Latitude	Longitude	+	
Latitude	Longitude				
+					

SECTION VI -- WILL THE PROJECT REQUIRE CONSTRUCTION ACTIVITIES IN A WATER BODY OR THE RIPARIAN ZONE?

Will the project require construction activities in a water body or the riparian zone? (*)	Yes
If Yes, describe scope of activity: (✓)	Constructing of Piers and abulments to Cross Cumberland River
Is a Clean Water Act 404 permit required? (*)	
Is a Clean Water Act 401 Water Quality Certification required? (*)	

SECTION VII – NOI PREPARER INFORMATION				
First Name (*) Jason	M.I.: w	Last Name (*) Looper	Company Name: (*) KYTC	
Mailing Address (*) 5501 KY dam Road		City (*) Paducah	State (*) Kentucky	Zip (*) 42003
eMail Address (*) jason.looper@ky.gov		Business Phone (*) 2708982431	Alternate Phone: 2702102398	
SECTION VIII – ATTACHMENTS				
Facility Location Map (*)		Upload file		
Supplemental Information:		Upload file		
SECTION IX – CERTIFICATION				
I certify under penalty of law that this document and all attachments were prepared under my direction or supervision in accordance with a system designed to assure that qualified personnel properly gather and evaluate the information submitted. Based on my inquiry of the person or persons who manage the system, or those persons directly responsible for gathering the information submitted is, to the best of my knowledge and belief, true, accurate, and complete. I am aware that there are significant penalties for submitting false information, including the possibility of fine and imprisonment for knowing violations.				
Signature (*) Kyle Poat		Title (*) CDE		
First Name (*) Kyle	M.I.: M	Last Name (*) Poat		
eMail Address (*) kyle poat@ky.gov	Business Phone (*) 2708982431	Alternate Phone: Phone	Signature Date: (*) Date	
<div style="display: flex; justify-content: space-around; margin-top: 20px;"> Click to Save Values for Future Retrieval Click to Submit to EEC </div>				

GUARDRAIL DELIVERY VERIFICATION SHEET

Contract Id: _____

Contractor: _____

Section Engineer: _____

District & County: _____

<u>DESCRIPTION</u>	<u>UNIT</u>	<u>QTY LEAVING PROJECT</u>	<u>QTY RECEIVED@BB YARD</u>
GUARDRAIL (Includes End treatments & crash cushions)	LF	_____	_____
STEEL POSTS	EACH	_____	_____
STEEL BLOCKS	EACH	_____	_____
WOOD OFFSET BLOCKS	EACH	_____	_____
BACK UP PLATES	EACH	_____	_____
CRASH CUSHION	EACH	_____	_____
NUTS, BOLTS, WASHERS	BAG/BCKT	_____	_____
DAMAGED RAIL TO MAINT. FACILITY	LF	_____	_____
DAMAGED POSTS TO MAINT. FACILITY	EACH	_____	_____

***Required Signatures before Leaving Project Site**

Printed Section Engineer's Representative _____ & Date _____

Signature Section Engineer's Representative _____ & Date _____

Printed Contractor's Representative _____ & Date _____

Signature Contractor's Representative _____ & Date _____

***Required Signatures after Arrival at Bailey Bridge Yard (All material on truck must be counted & the quantity received column completed before signatures)**

Printed Bailey Bridge Yard Representative _____ & Date _____

Signature Bailey Bridge Yard Representative _____ & Date _____

Printed Contractor's Representative _____ & Date _____

Signature Contractor's Representative _____ & Date _____

**Payment for the bid item remove guardrail will be based upon the quantities shown in the Bailey Bridge Yard received column. Payment will not be made for guardrail removal until the guardrail verification sheets are electronically submitted to the Section Engineer by the Bailey Bridge Yard Representative.

Completed Form Submitted to Section Engineer Date: _____ By: _____

PART II
SPECIFICATIONS AND STANDARD DRAWINGS

SPECIFICATIONS REFERENCE

Any reference in the plans or proposal to previous editions of the *Standard Specifications for Road and Bridge Construction* and *Standard Drawings* are superseded by *Standard Specifications for Road and Bridge Construction, Edition of 2019* and *Standard Drawings, Edition of 2016*.

SUPPLEMENTAL SPECIFICATIONS

The contractor shall use the Supplemental Specifications that are effective at the time of letting.
The Supplemental Specifications can be found at the following link:

<http://transportation.ky.gov/Construction/Pages/Kentucky-Standard-Specifications.aspx>

SPECIAL NOTE FOR PORTABLE CHANGEABLE MESSAGE SIGNS

This Special Note will apply when indicated on the plans or in the proposal.

1.0 DESCRIPTION. Furnish, install, operate, and maintain variable message signs at the locations shown on the plans or designated by the Engineer. Remove and retain possession of variable message signs when they are no longer needed on the project.

2.0 MATERIALS.

2.1 General. Use LED Variable Message Signs Class I, II, or III, as appropriate, from the Department's List of Approved Materials.

Unclassified signs may be submitted for approval by the Engineer. The Engineer may require a daytime and nighttime demonstration. The Engineer will make a final decision within 30 days after all required information is received.

2.2 Sign and Controls. All signs must:

- 1) Provide 3-line messages with each line being 8 characters long and at least 18 inches tall. Each character comprises 35 pixels.
- 2) Provide at least 40 preprogrammed messages available for use at any time. Provide for quick and easy change of the displayed message; editing of the message; and additions of new messages.
- 3) Provide a controller consisting of:
 - a) Keyboard or keypad.
 - b) Readout that mimics the actual sign display. (When LCD or LCD type readout is used, include backlighting and heating or otherwise arrange for viewing in cold temperatures.)
 - c) Non-volatile memory or suitable memory with battery backup for storing pre-programmed messages.
 - d) Logic circuitry to control the sequence of messages and flash rate.
- 4) Provide a serial interface that is capable of supporting complete remote control ability through land line and cellular telephone operation. Include communication software capable of immediately updating the message, providing complete sign status, and allowing message library queries and updates.
- 5) Allow a single person easily to raise the sign to a satisfactory height above the pavement during use, and lower the sign during travel.
- 6) Be Highway Orange on all exterior surfaces of the trailer, supports, and controller cabinet.
- 7) Provide operation in ambient temperatures from -30 to + 120 degrees Fahrenheit during snow, rain and other inclement weather.
- 8) Provide the driver board as part of a module. All modules are interchangeable, and have plug and socket arrangements for disconnection and reconnection. Printed circuit boards associated with driver boards have a conformable coating to protect against moisture.
- 9) Provide a sign case sealed against rain, snow, dust, insects, etc. The lens is UV stabilized clear plastic (polycarbonate, acrylic, or other approved material) angled to prevent glare.
- 10) Provide a flat black UV protected coating on the sign hardware, character PCB, and appropriate lens areas.
- 11) Provide a photocell control to provide automatic dimming.

- 12) Allow an on-off flashing sequence at an adjustable rate.
- 13) Provide a sight to aim the message.
- 14) Provide a LED display color of approximately 590 nm amber.
- 15) Provide a controller that is password protected.
- 16) Provide a security device that prevents unauthorized individuals from accessing the controller.
- 17) Provide the following 3-line messages preprogrammed and available for use when the sign unit begins operation:

/KEEP/RIGHT/=>=>=>/	/MIN/SPEED/**MPH/
/KEEP/LEFT/<=<=</	/ICY/BRIDGE/AHEAD/ /ONE
/LOOSE/GRAVEL/AHEAD/	LANE/BRIDGE/AHEAD/
/RD WORK/NEXT/**MILES/	/ROUGH/ROAD/AHEAD/
/TWO WAY/TRAFFIC/AHEAD/	/MERGING/TRAFFIC/AHEAD/
/PAINT/CREW/AHEAD/	/NEXT/**/MILES/
/REDUCE/SPEED/**MPH/	/HEAVY/TRAFFIC/AHEAD/
/BRIDGE/WORK/**0 FT/	/SPEED/LIMIT/**MPH/
/MAX/SPEED/**MPH/	/BUMP/AHEAD/
/SURVEY/PARTY/AHEAD/	/TWO/WAY/TRAFFIC/

*Insert numerals as directed by the Engineer.
Add other messages during the project when required by the Engineer.

2.3 Power.

- 1) Design solar panels to yield 10 percent or greater additional charge than sign consumption. Provide direct wiring for operation of the sign or arrow board from an external power source to provide energy backup for 21 days without sunlight and an on-board system charger with the ability to recharge completely discharged batteries in 24 hours.

3.0 CONSTRUCTION. Furnish and operate the variable message signs as designated on the plans or by the Engineer. Ensure the bottom of the message panel is a minimum of 7 feet above the roadway in urban areas and 5 feet above in rural areas when operating. Use Class I, II, or III signs on roads with a speed limit less than 55 mph. Use Class I or II signs on roads with speed limits 55 mph or greater.

Maintain the sign in proper working order, including repair of any damage done by others, until completion of the project. When the sign becomes inoperative, immediately repair or replace the sign. Repetitive problems with the same unit will be cause for rejection and replacement.

Use only project related messages and messages directed by the Engineer, unnecessary messages lessen the impact of the sign. Ensure the message is displayed in either one or 2 phases with each phase having no more than 3 lines of text. When no message is needed, but it is necessary to know if the sign is operable, flash only a pixel.

When the sign is not needed, move it outside the clear zone or where the Engineer directs. Variable Message Signs are the property of the Contractor and shall be removed from the project when no longer needed. The Department will not assume ownership of these signs.

4.0 MEASUREMENT. The final quantity of Variable Message Sign will be

11

the actual number of individual signs acceptably furnished and operated during the project. The Department will not measure signs replaced due to damage or rejection.

5.0 PAYMENT. The Department will pay for the Variable Message Signs at the unit price each. The Department will not pay for signs replaced due to damage or rejection. Payment is full compensation for furnishing all materials, labor, equipment, and service necessary to, operate, move, repair, and maintain or replace the variable message signs. The Department will make payment for the completed and accepted quantities under the following:

<u>Code</u>	<u>Pay Item</u>	<u>Pay Unit</u>
02671	Portable Changeable Message Sign	Each

Effective June 15, 2012

SPECIAL NOTE FOR BARCODE LABEL ON PERMANENT SIGNS

1.0 DESCRIPTION. Install barcode label on sheeting signs. Section references herein are to the Department's Standard Specifications for Road and Bridge Construction, current edition.

2.0 MATERIALS. The Department will provide the Contractor with a 2 inch x 1 inch foil barcode label for each permanent sheeting sign. A unique number will be assigned to each barcode label.

The Contractor shall contact the Operations and Pavement Management Branch in the Division of Maintenance at (502) 564-4556 to obtain the barcode labels.

3.0 CONSTRUCTION. Apply foil barcode label in the lower right quadrant of the sign back. Signs where the bottom edge is not parallel to the ground, the lowest corner of the sign shall serve as the location to place the barcode label. The barcode label shall be placed no less than one-inch and no more than three inches from any edge of the sign. The barcode must be placed so that the sign post does not cover the barcode label.

Barcodes shall be applied in an indoor setting with a minimum air temperature of 50°F or higher. Prior to application of the barcode label, the back of the sign must be clean and free of dust, oil, etc. If the sign is not clean, an alcohol swab shall be used to clean the area. The area must be allowed to dry prior to placement of the barcode label.

Data for each sign shall include the barcode number, MUTCD reference number, sheeting manufacturer, sheeting type, manufacture date, color of primary reflective surface, installation date, latitude and longitude using the North American Datum of 1983 (NAD83) or the State Plane Coordinates using an x and y ordinate of the installed location.

Data should be provided electronically on the TC 71-229 Sign Details Information and TC 71-230 Sign Assembly Information forms. The Contractor may choose to present the data in a different format provided that the information submitted to the Department is equivalent to the information required on the Department TC forms. The forms must be submitted in electronic format regardless of which type of form is used. The Department will not accept PDF or handwritten forms. These completed forms must be submitted to the Department prior to final inspection of the signs. The Department will not issue formal acceptance for the project until the TC 71-229 and TC-230 electronic forms are completed for all signs and sign assemblies on the project.

4.0 MEASUREMENT. The Department will measure all work required for the installation of the barcode label and all work associated with completion and submission of the sign inventory data (TC 71-229 and TC 71-230).

The installation of the permanent sign will be measured in accordance to Section 715.

5.0 PAYMENT. The Department will make payment for the completed and accepted quantities under the following:

<u>Code</u>	<u>Pay Item</u>	<u>Pay Unit</u>
24631EC	Barcode Sign Inventory	Each

The Department will not make payment for this item until all barcodes are installed and sign inventory is complete on every permanent sign installed on the project. The Department will make payment for installation of the permanent sign in accordance to Section 715. The Department will consider payment as full compensation for all work required under this special note.

One Sign Post



↑
2" Wide Post

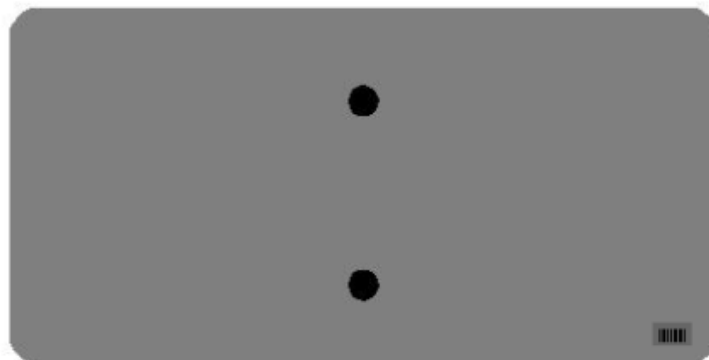
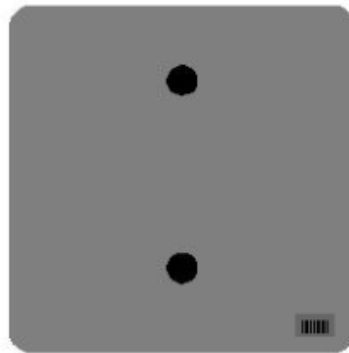

One Sign Post

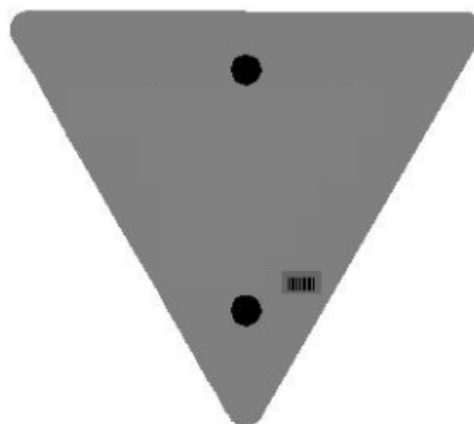
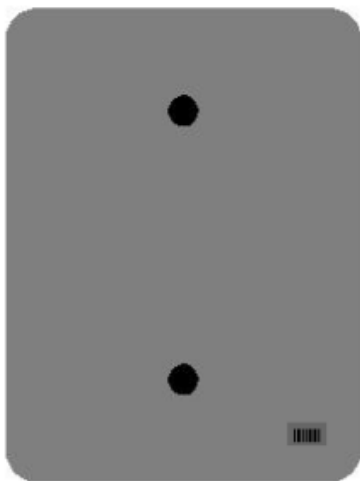
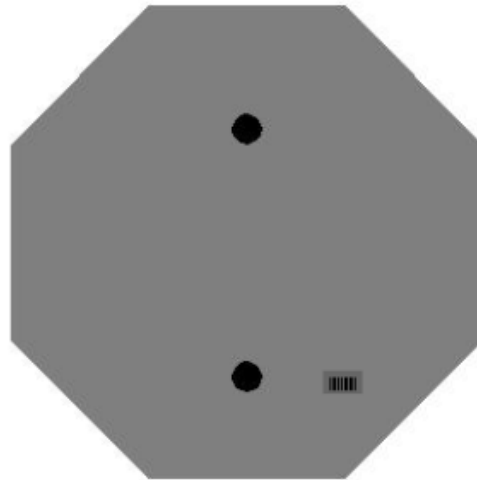
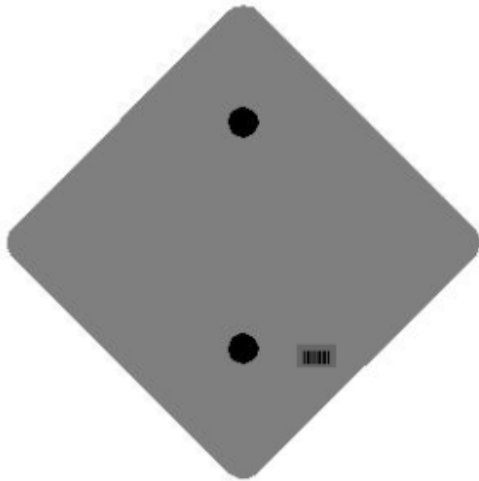

One Sign Post

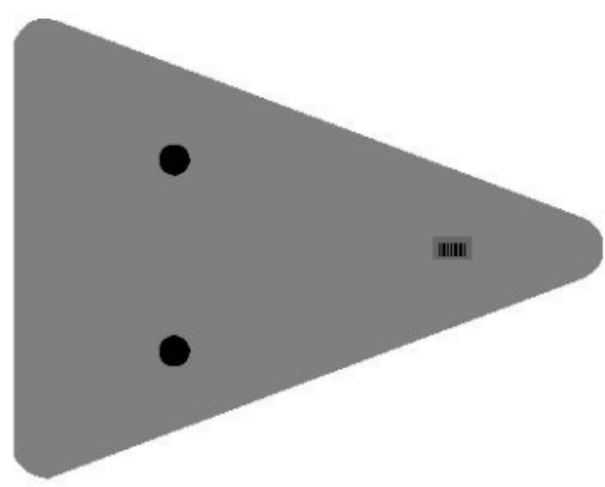
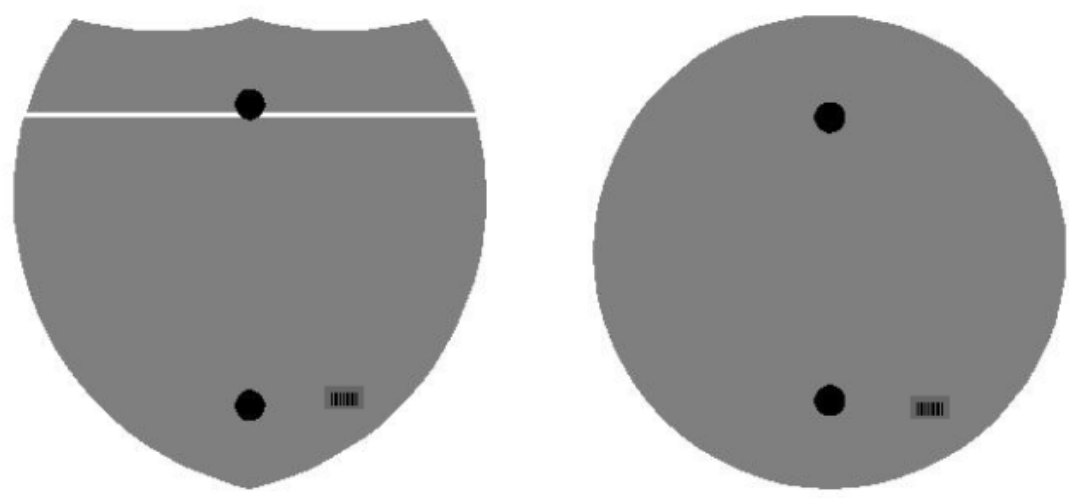

Double Sign Post

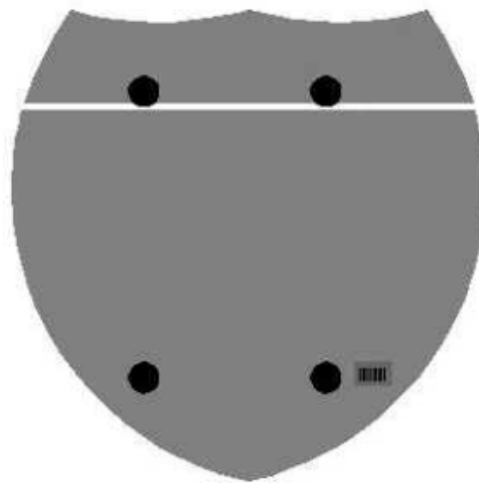

Interstate
Shield

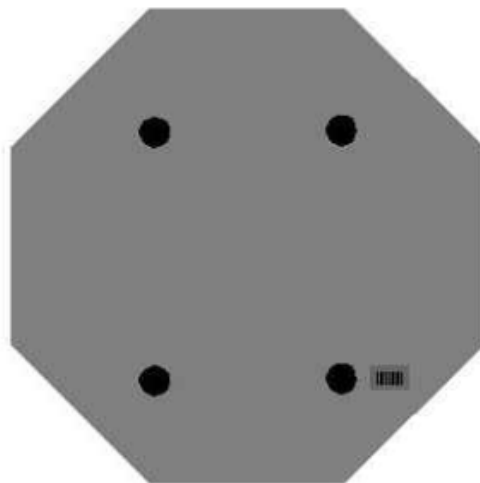

48" Stop

2 Post Signs



↑
2" Wide Post

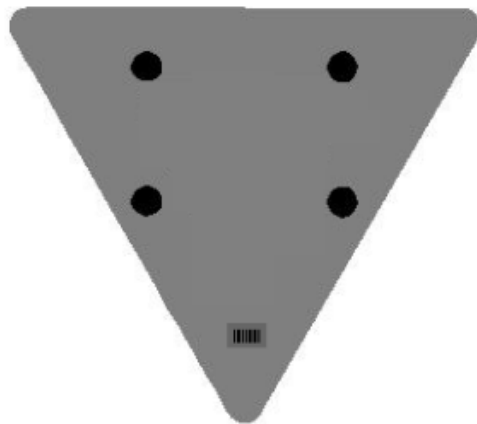

SPECIAL NOTE FOR LONGITUDINAL PAVEMENT JOINT ADHESIVE

1. DESCRIPTION. This specification covers the requirements and practices for applying an asphalt adhesive material to the longitudinal joint of the surface course of an asphalt pavement. Apply the adhesive to the face of longitudinal joint between driving lanes for the first lane paved. Then, place and compact the adjacent lane against the treated face to produce a strong, durable, waterproof longitudinal joint.
2. MATERIALS, EQUIPMENT, AND PERSONNEL.

2.1 Joint Adhesive. Provide material conforming to Subsection 2.1.1.

2.1.1 Provide an adhesive conforming to the following requirements:

Property	Specification	Test Procedure
Viscosity, 400 ° F (Pa·s)	4.0 – 10.0	ASTM D 4402
Cone Penetration, 77 ° F	60 – 100	ASTM D 5329
Flow, 140 ° F (mm)	5.0 max.	ASTM D 5329
Resilience, 77 ° F (%)	30 min.	ASTM D 5329
Ductility, 77 ° F (cm)	30.0 min.	ASTM D 113
Ductility, 39 ° F (cm)	30.0 min.	ASTM D 113
Tensile Adhesion, 77 ° F (%)	500 min.	ASTM D 5329, Type II
Softening Point, ° F	171 min.	AASHTO T 53
Asphalt Compatibility	Pass	ASTM D 5329

Ensure the temperature of the pavement joint adhesive is between 380 and 410 °F when the material is extruded in a 0.125-inch-thick band over the entire face of the longitudinal joint.

2.2. Equipment.

2.2.1 Melter Kettle. Provide an oil-jacketed, double-boiler, melter kettle equipped with any needed agitation and recirculating systems.

2.2.2 Applicator System. Provide a pressure-feed-wand applicator system with an applicator shoe attached.

2.3 Personnel. Ensure a technical representative from the manufacturer of the pavement joint adhesive is present during the initial construction activities and available upon the request of the Engineer.

3. CONSTRUCTION.

3.1 Surface Preparation. Prior to the application of the pavement joint adhesive, ensure the face of the longitudinal joint is thoroughly dry and free from dust or any other debris that would inhibit adhesion. Clean the joint face by the use of compressed air.

Ensure this preparation process occurs shortly before application to prevent the return of debris on the joint face.

3.2 Pavement Joint Adhesive Application. Ensure the ambient temperature is a minimum of 40 ° F during the application of the pavement joint adhesive. Prior to applying the adhesive, demonstrate competence in applying the adhesive according to this note to the satisfaction of the Engineer. Heat the adhesive in the melter kettle to the specified temperature range. Pump the adhesive from the melter kettle through the wand onto the vertical face of the cold joint. Apply the adhesive in a continuous band over the entire face of the longitudinal joint. Do not use excessive material in either thickness or location. Ensure the edge of the extruded adhesive material is flush with the surface of the pavement. Then, place and compact the adjacent lane against the joint face. Remove any excessive material extruded from the joint after compaction (a small line of material may remain).

3.3 Pavement Joint Adhesive Certification. Furnish the joint adhesive's certification to the Engineer stating the material conforms to all requirements herein prior to use.

3.4 Sampling and Testing. The Department will require a random sample of pavement joint adhesive from each manufacturer's lot of material. Extrude two 5 lb. samples of the heated material and forward the sample to the Division of Materials for testing. Reynolds oven bags, turkey size, placed inside small cardboard boxes or cement cylinder molds have been found suitable. Ensure the product temperature is 400°F or below at the time of sampling.

4. MEASUREMENT. The Department will measure the quantity of Pavement Joint Adhesive in linear feet. The Department will not measure for payment any extra materials, labor, methods, equipment, or construction techniques used to satisfy the requirements of this note. The Department will not measure for payment any trial applications of Pavement Joint Adhesive, the cleaning of the joint face, or furnishing and placing the adhesive. The Department will consider all such items incidental to the Pavement Joint Adhesive.
5. PAYMENT. The Department will pay for the Pavement Joint Adhesive at the Contract unit bid price and apply an adjustment for each manufacturer's lot of material based on the degree of compliance as defined in the following schedule. When a sample fails on two or more tests, the Department may add the deductions, but the total deduction will not exceed 100 percent.

11N

Pavement Joint Adhesive Price Adjustment Schedule						
Test	Specification	100% Pay	90% Pay	80% Pay	50% Pay	0% Pay
Joint Adhesive Referenced in Subsection 2.1.1						
Viscosity, 400 ° F (Pa•s) ASTM D 3236	4.0-10.0	3.5-10.5	3.0-3.4 10.6-11.0	2.5-2.9 11.1-11.5	2.0-2.4 11.6-12.0	≤1.9 ≥ 12.1
Cone Penetration, 77 ° F ASTM D 5329	60-100	57-103	54-56 104-106	51-53 107-109	48-50 110-112	≤ 47 ≥ 113
Flow, 140 ° F (mm) ASTM D 5329	≤ 5.0	≤ 5.5	5.6-6.0	6.1-6.5	6.6-7.0	≥ 7.1
Resilience, 77 ° F (%) ASTM D 5329	≥ 30	≥ 28	26-27	24-25	22-23	≤ 21
Tensile Adhesion, 77 ° F (%) ASTM D 5329	≥ 500	≥ 490	480-489	470-479	460-469	≤ 459
Softening Point, ° F AASHTO T 53	≥ 171	≥ 169	166-168	163-165	160-162	≤ 159
Ductility, 77 ° F (cm) ASTM D 113	≥ 30.0	≥ 29.0	28.0-28.9	27.0-27.9	26.0-26.9	≤ 25.9
Ductility, 39 ° F (cm) ASTM D 113	≥ 30.0	≥ 29.0	28.0-28.9	27.0-27.9	26.0-26.9	≤ 25.9

Code
 20071EC

Pay Item
 Joint Adhesive

Pay Unit
 Linear Foot

May 7, 2014

SPECIAL PROVISION FOR EMBANKMENT AT BRIDGE END BENT STRUCTURES

This Special Provision will apply when indicated on the plans or in the proposal. Section references herein are to the Department's Standard Specifications for Road and Bridge Construction, Current Edition.

1.0 DESCRIPTION. Construct a soil, granular, or rock embankment with soil, granular or cohesive pile core and place structure granular backfill, as the Plans require. Construct the embankment according to the requirements of this Special Provision, the Plans, Standard Drawing RGX 100 and 105, and the Standard Specifications, Current Edition.

2.0 MATERIALS.

2.1 Granular Embankment. Conform to Subsection 805.10. When Granular Embankment materials are erodible or unstable according to Subsection 805.03.04, use the Special Construction Methods found in 3.2 of the Special Provision.

2.2 Rock Embankment. Provide durable rock from roadway excavation that consists principally of Unweathered Limestone, Durable Shale (SDI equal to or greater than 95 according to KM 64-513), or Durable Sandstone.

2.3 Pile Core. Provide a pile core in the area of the embankments where deep foundations are to be installed unless otherwise specified. The Pile Core is the zone indicated on Standard Drawings RGX 100 and 105 designated as Pile Core. Material control of the pile core area during embankment construction is always required. Proper Pile Core construction is required for installation of foundation elements such as drilled or driven piles or drilled shafts. The type of material used to construct the pile core is as directed in the plans or below. Typically, the pile core area will be constructed from the same material used to construct the surrounding embankment. Pile Core can be classified as one of three types:

A) Pile Core - Conform to Section 206 of the Standard Specifications. Provide pile core material consisting of the same material as the adjacent embankment except the material in the pile core area shall be free of boulders or particle sizes larger than 4 inches in any dimension or any other obstructions that may hinder pile driving operations. If the pile core material hinders pile driving operations, take the appropriate means necessary to reach the required pile tip elevation, at no expense to the Department.

B) Granular Pile Core. Granular pile core is required only when specified in the plans. Select a gradation of durable rock to facilitate pile driving that conforms to Subsection 805.11. If granular pile core material hinders pile driving operations, take appropriate means necessary to reach the required pile tip elevation, at no expense to the Department.

C) Cohesive Pile Core. Cohesive Pile Core is required only when specified in the plans. Conform to Section 206 of the Standard Specifications and use soil with at least 50 percent passing a No. 4 sieve having a minimum Plasticity Index (PI) of 10. In addition, keep the cohesive pile core free of boulders, larger than 4 inches in any dimension, or any other obstructions, which would interfere with drilling operations. If cohesive pile core material interferes with drilling operations, take appropriate means necessary to maintain

excavation stability, at no expense to the Department.

2.4 Structure Granular Backfill. Conform to Subsection 805.11

2.5 Geotextile Fabric. Conform to Type I or Type IV in Section 214 and 843.

3.0 CONSTRUCTION.

3.1 General. Construct roadway embankments at end bents according to Section 206 and in accordance with the Special Provision, the Plans, and Standard Drawings for the full embankment section. In some instances, granular or rock embankment will be required for embankment construction for stability purposes, but this special provision does not prevent the use of soil when appropriate. Refer to the plans for specific details regarding material requirements for embankment construction.

Place and compact the pile core and structure granular backfill according to the applicable density requirements for the project. If the embankment and pile core are dissimilar materials (i.e., a granular pile core is used with a soil embankment or a cohesive pile core is used with a granular embankment), a Geotextile Fabric, Type IV, will be required between the pile core and embankment in accordance with Sections 214 and 843 of the Standard Specifications.

When granular or rock embankment is required for embankment construction, conform to the general requirements of Subsection 206.03.02 B. In addition, place the material in no greater than 2-foot loose lifts and compact with a vibrating smooth wheel roller capable of producing a minimum centrifugal force of 15 tons. Apply these requirements to the full width of the embankment for a distance of half the embankment height or 50 feet, whichever is greater, as shown on Standard Drawing RGX-105.

When using granular pile core, install 8-inch perforated underdrain pipe at or near the elevation of the original ground in the approximate locations depicted on the standard drawing, and as the Engineer directs, to ensure positive drainage of the embankment. Wrap the perforated pipe with a fabric of a type recommended by the pipe manufacturer.

After constructing the embankment, excavate for the end bent cap, drive piling, install shafts or other foundation elements, place the mortar bed, construct the end bent, and complete the embankment to finish grade according to the construction sequence shown on the Plans or Standard Drawings and as specified hereinafter.

Certain projects may require widening of existing embankments and the removal of substructures. Construct embankment according to the plans. Substructure removal shall be completed according to the plans and Section 203. Excavation may be required at the existing embankment in order to place the structure granular backfill as shown in the Standard Drawings.

After piles are driven or shafts installed (see design drawings), slope the bottom of the excavation towards the ends of the trench as noted on the plans for drainage. Using a separate pour, place concrete mortar, or any class concrete, to provide a base for forming and placing the cap. Place side forms for the end bent after the mortar has set sufficiently to support workmen and forms without being disturbed.

Install 4-inch perforated pipe in accordance with the plans and Standard Drawings. In the event slope protection extends above the elevation of the perforated pipe, extend the pipe through the slope protection.

After placing the end bent cap and achieving required concrete cylinder strengths, remove adjacent forms and fill the excavation with compacted structure granular backfill material (maximum 1' loose lifts) to the level of the berm prior to placing beams for the bridge. Place Type IV geotextile fabric between embankment material and structure granular backfill. After completing the end bent backwall, or after completing the span end

wall, place the compacted structure granular backfill (maximum 1' loose lifts) to subgrade elevation. If the original excavation is enlarged, fill the entire volume with compacted structure granular backfill (maximum 1' loose lifts) at no expense to the Department. Do not place backfill before removing adjacent form work. Place structure granular backfill material in trench ditches at the ends of the excavation. Place Geotextile Fabric, Type IV over the surface of the compacted structure granular backfill prior to placing aggregate base course.

Tamp the backfill with hand tampers, pneumatic tampers, or other means approved by the Engineer. Thoroughly compact the backfill under the overhanging portions of the structure to ensure that the backfill is in intimate contact with the sides of the structure.

Do not apply seeding, sodding, or other vegetation to the exposed granular embankment.

3.2 Special Construction Methods. Erodible or unstable materials may erode even when protected by riprap or channel lining; use the special construction method described below when using these materials.

Use fine aggregates or friable sandstone granular embankment at "dry land" structures only. Do not use them at stream crossings or locations subject to flood waters.

For erodible or unstable materials having 50 percent or more passing the No. 4 sieve, protect with geotextile fabric. Extend the fabric from the original ground to the top of slope over the entire area of the embankment slopes on each side of, and in front of, the end bent. Cover the fabric with at least 12 inches of non-erodible material.

For erodible or unstable materials having less than 50 percent passing a No. 4 sieve, cover with at least 12 inches of non-erodible material.

Where erodible or unstable granular embankment will be protected by riprap or channel lining, place Type IV geotextile fabric between the embankment and the specified slope protection.

4.0 MEASUREMENT.

4.1 Granular Embankment. The Department will measure the quantity in cubic yards using the plan quantity, increased or decreased by authorized adjustments as specified in Section 204. The Department will not measure for payment any Granular Embankment that is not called for in the plans.

The Department will not measure for payment any special construction caused by using erodible or unstable materials and will consider it incidental to the Granular Embankment regardless of whether the erodible or unstable material was specified or permitted.

4.2 Rock Embankment. The Department will not measure for payment any rock embankment and will consider it incidental to roadway excavation or embankment in place, as applicable. Rock embankments will be constructed using granular embankment on projects where there is no available rock present within the excavation limits of the project.

4.3 Pile Core. Pile core will be measured and paid under roadway excavation or embankment in place, as applicable. The Department will not measure the pile core for separate payment. The Department will not measure for payment the 8-inch perforated underdrain pipe and will consider it incidental to the Pile Core.

4.4 Structure Granular Backfill. The Department will measure the quantity in cubic yards using the plan quantity, increased or decreased by authorized adjustments as specified in Section 204. The Department will not measure any additional material required for backfill outside the limits shown on the Plans and Standard Drawings for payment and will

consider it incidental to the work.

The Department will not measure for payment the 4-inch perforated underdrain pipe and will consider it incidental to the Structure Granular Backfill.

4.5 Geotextile Fabric. The Department will not measure the quantity of fabric used for separating dissimilar materials when constructing the embankment and pile core and will consider it incidental to embankment construction.

The Department will not measure for payment the Geotextile Fabric used to separate the Structure Granular Backfill from the embankment and aggregate base course and will consider it incidental to Structure Granular Backfill.

The Department will not measure for payment the Geotextile Fabric required for construction with erodible or unstable materials and will consider it incidental to embankment construction.

4.6 End Bent. The Department will measure the quantities according to the Contract. The Department will not measure furnishing and placing the 2-inch mortar or concrete bed for payment and will consider it incidental to the end bent construction.

4.7 Structure Excavation. The Department will not measure structure excavation on new embankments for payment and will consider it incidental to the Structure Granular Backfill or Concrete as applicable.

5.0 PAYMENT. The Department will make payment for the completed and accepted quantities under the following:

<u>Code</u>	<u>Pay Item</u>	<u>Pay Unit</u>
02223	Granular Embankment	Cubic Yards
02231	Structure Granular Backfill	Cubic Yards

The Department will consider payment as full compensation for all work required in this provision.

September 16, 2016

PART III

EMPLOYMENT, WAGE AND RECORD REQUIREMENTS

FHWA-1273 -- Revised May 1, 2012

REQUIRED CONTRACT PROVISIONS FEDERAL-AID CONSTRUCTION CONTRACTS

- I. General
- II. Nondiscrimination
- III. Nonsegregated Facilities
- IV. Davis-Bacon and Related Act Provisions
- V. Contract Work Hours and Safety Standards Act Provisions
- VI. Subletting or Assigning the Contract
- VII. Safety: Accident Prevention
- VIII. False Statements Concerning Highway Projects
- IX. Implementation of Clean Air Act and Federal Water Pollution Control Act
- X. Compliance with Governmentwide Suspension and Debarment Requirements
- XI. Certification Regarding Use of Contract Funds for Lobbying

ATTACHMENTS

A. Employment and Materials Preference for Appalachian Development Highway System or Appalachian Local Access Road Contracts (included in Appalachian contracts only)

I. GENERAL

1. Form FHWA-1273 must be physically incorporated in each construction contract funded under Title 23 (excluding emergency contracts solely intended for debris removal). The contractor (or subcontractor) must insert this form in each subcontract and further require its inclusion in all lower tier subcontracts (excluding purchase orders, rental agreements and other agreements for supplies or services).

The applicable requirements of Form FHWA-1273 are incorporated by reference for work done under any purchase order, rental agreement or agreement for other services. The prime contractor shall be responsible for compliance by any subcontractor, lower-tier subcontractor or service provider.

Form FHWA-1273 must be included in all Federal-aid design-build contracts, in all subcontracts and in lower tier subcontracts (excluding subcontracts for design services, purchase orders, rental agreements and other agreements for supplies or services). The design-builder shall be responsible for compliance by any subcontractor, lower-tier subcontractor or service provider.

Contracting agencies may reference Form FHWA-1273 in bid proposal or request for proposal documents, however, the Form FHWA-1273 must be physically incorporated (not referenced) in all contracts, subcontracts and lower-tier subcontracts (excluding purchase orders, rental agreements and other agreements for supplies or services related to a construction contract).

2. Subject to the applicability criteria noted in the following sections, these contract provisions shall apply to all work performed on the contract by the contractor's own organization and with the assistance of workers under the contractor's immediate superintendence and to all work performed on the contract by piecework, station work, or by subcontract.

3. A breach of any of the stipulations contained in these Required Contract Provisions may be sufficient grounds for withholding of progress payments, withholding of final payment, termination of the contract, suspension / debarment or any other action determined to be appropriate by the contracting agency and FHWA.

4. Selection of Labor: During the performance of this contract, the contractor shall not use convict labor for any purpose within the limits of a construction project on a Federal-aid highway unless it is labor performed by convicts who are on parole, supervised release, or probation. The term Federal-aid highway does not include roadways functionally classified as local roads or rural minor collectors.

II. NONDISCRIMINATION

The provisions of this section related to 23 CFR Part 230 are applicable to all Federal-aid construction contracts and to all related construction subcontracts of \$10,000 or more. The provisions of 23 CFR Part 230 are not applicable to material supply, engineering, or architectural service contracts.

In addition, the contractor and all subcontractors must comply with the following policies: Executive Order 11246, 41 CFR 60, 29 CFR 1625-1627, Title 23 USC Section 140, the Rehabilitation Act of 1973, as amended (29 USC 794), Title VI of the Civil Rights Act of 1964, as amended, and related regulations including 49 CFR Parts 21, 26 and 27; and 23 CFR Parts 200, 230, and 633.

The contractor and all subcontractors must comply with: the requirements of the Equal Opportunity Clause in 41 CFR 60-1.4(b) and, for all construction contracts exceeding \$10,000, the Standard Federal Equal Employment Opportunity Construction Contract Specifications in 41 CFR 60-4.3.

Note: The U.S. Department of Labor has exclusive authority to determine compliance with Executive Order 11246 and the policies of the Secretary of Labor including 41 CFR 60, and 29 CFR 1625-1627. The contracting agency and the FHWA have the authority and the responsibility to ensure compliance with Title 23 USC Section 140, the Rehabilitation Act of 1973, as amended (29 USC 794), and Title VI of the Civil Rights Act of 1964, as amended, and related regulations including 49 CFR Parts 21, 26 and 27; and 23 CFR Parts 200, 230, and 633.

The following provision is adopted from 23 CFR 230, Appendix A, with appropriate revisions to conform to the U.S. Department of Labor (US DOL) and FHWA requirements.

1. Equal Employment Opportunity: Equal employment opportunity (EEO) requirements not to discriminate and to take affirmative action to assure equal opportunity as set forth under laws, executive orders, rules, regulations (28 CFR 35, 29 CFR 1630, 29 CFR 1625-1627, 41 CFR 60 and 49 CFR 27) and orders of the Secretary of Labor as modified by the provisions prescribed herein, and imposed pursuant to 23 U.S.C. 140 shall constitute the EEO and specific affirmative action standards for the contractor's project activities under

this contract. The provisions of the Americans with Disabilities Act of 1990 (42 U.S.C. 12101 et seq.) set forth under 28 CFR 35 and 29 CFR 1630 are incorporated by reference in this contract. In the execution of this contract, the contractor agrees to comply with the following minimum specific requirement activities of EEO:

a. The contractor will work with the contracting agency and the Federal Government to ensure that it has made every good faith effort to provide equal opportunity with respect to all of its terms and conditions of employment and in their review of activities under the contract.

b. The contractor will accept as its operating policy the following statement:

"It is the policy of this Company to assure that applicants are employed, and that employees are treated during employment, without regard to their race, religion, sex, color, national origin, age or disability. Such action shall include: employment, upgrading, demotion, or transfer; recruitment or recruitment advertising; layoff or termination; rates of pay or other forms of compensation; and selection for training, including apprenticeship, pre-apprenticeship, and/or on-the-job training."

2. EEO Officer: The contractor will designate and make known to the contracting officers an EEO Officer who will have the responsibility for and must be capable of effectively administering and promoting an active EEO program and who must be assigned adequate authority and responsibility to do so.

3. Dissemination of Policy: All members of the contractor's staff who are authorized to hire, supervise, promote, and discharge employees, or who recommend such action, or who are substantially involved in such action, will be made fully cognizant of, and will implement, the contractor's EEO policy and contractual responsibilities to provide EEO in each grade and classification of employment. To ensure that the above agreement will be met, the following actions will be taken as a minimum:

a. Periodic meetings of supervisory and personnel office employees will be conducted before the start of work and then not less often than once every six months, at which time the contractor's EEO policy and its implementation will be reviewed and explained. The meetings will be conducted by the EEO Officer.

b. All new supervisory or personnel office employees will be given a thorough indoctrination by the EEO Officer, covering all major aspects of the contractor's EEO obligations within thirty days following their reporting for duty with the contractor.

c. All personnel who are engaged in direct recruitment for the project will be instructed by the EEO Officer in the contractor's procedures for locating and hiring minorities and women.

d. Notices and posters setting forth the contractor's EEO policy will be placed in areas readily accessible to employees, applicants for employment and potential employees.

e. The contractor's EEO policy and the procedures to implement such policy will be brought to the attention of employees by means of meetings, employee handbooks, or other appropriate means.

4. Recruitment: When advertising for employees, the contractor will include in all advertisements for employees the notation: "An Equal Opportunity Employer." All such advertisements will be placed in publications having a large circulation among minorities and women in the area from which the project work force would normally be derived.

a. The contractor will, unless precluded by a valid bargaining agreement, conduct systematic and direct recruitment through public and private employee referral sources likely to yield qualified minorities and women. To meet this requirement, the contractor will identify sources of potential minority group employees, and establish with such identified sources procedures whereby minority and women applicants may be referred to the contractor for employment consideration.

b. In the event the contractor has a valid bargaining agreement providing for exclusive hiring hall referrals, the contractor is expected to observe the provisions of that agreement to the extent that the system meets the contractor's compliance with EEO contract provisions. Where implementation of such an agreement has the effect of discriminating against minorities or women, or obligates the contractor to do the same, such implementation violates Federal nondiscrimination provisions.

c. The contractor will encourage its present employees to refer minorities and women as applicants for employment. Information and procedures with regard to referring such applicants will be discussed with employees.

5. Personnel Actions: Wages, working conditions, and employee benefits shall be established and administered, and personnel actions of every type, including hiring, upgrading, promotion, transfer, demotion, layoff, and termination, shall be taken without regard to race, color, religion, sex, national origin, age or disability. The following procedures shall be followed:

a. The contractor will conduct periodic inspections of project sites to insure that working conditions and employee facilities do not indicate discriminatory treatment of project site personnel.

b. The contractor will periodically evaluate the spread of wages paid within each classification to determine any evidence of discriminatory wage practices.

c. The contractor will periodically review selected personnel actions in depth to determine whether there is evidence of discrimination. Where evidence is found, the contractor will promptly take corrective action. If the review indicates that the discrimination may extend beyond the actions reviewed, such corrective action shall include all affected persons.

d. The contractor will promptly investigate all complaints of alleged discrimination made to the contractor in connection with its obligations under this contract, will attempt to resolve such complaints, and will take appropriate corrective action within a reasonable time. If the investigation indicates that the discrimination may affect persons other than the complainant, such corrective action shall include such other persons. Upon completion of each investigation, the contractor will inform every complainant of all of their avenues of appeal.

6. Training and Promotion:

a. The contractor will assist in locating, qualifying, and increasing the skills of minorities and women who are

applicants for employment or current employees. Such efforts should be aimed at developing full journey level status employees in the type of trade or job classification involved.

b. Consistent with the contractor's work force requirements and as permissible under Federal and State regulations, the contractor shall make full use of training programs, i.e., apprenticeship, and on-the-job training programs for the geographical area of contract performance. In the event a special provision for training is provided under this contract, this subparagraph will be superseded as indicated in the special provision. The contracting agency may reserve training positions for persons who receive welfare assistance in accordance with 23 U.S.C. 140(a).

c. The contractor will advise employees and applicants for employment of available training programs and entrance requirements for each.

d. The contractor will periodically review the training and promotion potential of employees who are minorities and women and will encourage eligible employees to apply for such training and promotion.

7. Unions: If the contractor relies in whole or in part upon unions as a source of employees, the contractor will use good faith efforts to obtain the cooperation of such unions to increase opportunities for minorities and women. Actions by the contractor, either directly or through a contractor's association acting as agent, will include the procedures set forth below:

a. The contractor will use good faith efforts to develop, in cooperation with the unions, joint training programs aimed toward qualifying more minorities and women for membership in the unions and increasing the skills of minorities and women so that they may qualify for higher paying employment.

b. The contractor will use good faith efforts to incorporate an EEO clause into each union agreement to the end that such union will be contractually bound to refer applicants without regard to their race, color, religion, sex, national origin, age or disability.

c. The contractor is to obtain information as to the referral practices and policies of the labor union except that to the extent such information is within the exclusive possession of the labor union and such labor union refuses to furnish such information to the contractor, the contractor shall so certify to the contracting agency and shall set forth what efforts have been made to obtain such information.

d. In the event the union is unable to provide the contractor with a reasonable flow of referrals within the time limit set forth in the collective bargaining agreement, the contractor will, through independent recruitment efforts, fill the employment vacancies without regard to race, color, religion, sex, national origin, age or disability; making full efforts to obtain qualified and/or qualifiable minorities and women. The failure of a union to provide sufficient referrals (even though it is obligated to provide exclusive referrals under the terms of a collective bargaining agreement) does not relieve the contractor from the requirements of this paragraph. In the event the union referral practice prevents the contractor from meeting the obligations pursuant to Executive Order 11246, as amended, and these special provisions, such contractor shall immediately notify the contracting agency.

8. Reasonable Accommodation for Applicants / Employees with Disabilities: The contractor must be familiar

with the requirements for and comply with the Americans with Disabilities Act and all rules and regulations established there under. Employers must provide reasonable accommodation in all employment activities unless to do so would cause an undue hardship.

9. Selection of Subcontractors, Procurement of Materials and Leasing of Equipment: The contractor shall not discriminate on the grounds of race, color, religion, sex, national origin, age or disability in the selection and retention of subcontractors, including procurement of materials and leases of equipment. The contractor shall take all necessary and reasonable steps to ensure nondiscrimination in the administration of this contract.

a. The contractor shall notify all potential subcontractors and suppliers and lessors of their EEO obligations under this contract.

b. The contractor will use good faith efforts to ensure subcontractor compliance with their EEO obligations.

10. Assurance Required by 49 CFR 26.13(b):

a. The requirements of 49 CFR Part 26 and the State DOT's U.S. DOT-approved DBE program are incorporated by reference.

b. The contractor or subcontractor shall not discriminate on the basis of race, color, national origin, or sex in the performance of this contract. The contractor shall carry out applicable requirements of 49 CFR Part 26 in the award and administration of DOT-assisted contracts. Failure by the contractor to carry out these requirements is a material breach of this contract, which may result in the termination of this contract or such other remedy as the contracting agency deems appropriate.

11. Records and Reports: The contractor shall keep such records as necessary to document compliance with the EEO requirements. Such records shall be retained for a period of three years following the date of the final payment to the contractor for all contract work and shall be available at reasonable times and places for inspection by authorized representatives of the contracting agency and the FHWA.

a. The records kept by the contractor shall document the following:

(1) The number and work hours of minority and non-minority group members and women employed in each work classification on the project;

(2) The progress and efforts being made in cooperation with unions, when applicable, to increase employment opportunities for minorities and women; and

(3) The progress and efforts being made in locating, hiring, training, qualifying, and upgrading minorities and women;

b. The contractors and subcontractors will submit an annual report to the contracting agency each July for the duration of the project, indicating the number of minority, women, and non-minority group employees currently engaged in each work classification required by the contract work. This information is to be reported on [Form FHWA-1391](#). The staffing data should represent the project work force on board in all or any part of the last payroll period preceding the end of July. If on-the-job training is being required by special provision, the contractor

will be required to collect and report training data. The employment data should reflect the work force on board during all or any part of the last payroll period preceding the end of July.

III. NONSEGREGATED FACILITIES

This provision is applicable to all Federal-aid construction contracts and to all related construction subcontracts of \$10,000 or more.

The contractor must ensure that facilities provided for employees are provided in such a manner that segregation on the basis of race, color, religion, sex, or national origin cannot result. The contractor may neither require such segregated use by written or oral policies nor tolerate such use by employee custom. The contractor's obligation extends further to ensure that its employees are not assigned to perform their services at any location, under the contractor's control, where the facilities are segregated. The term "facilities" includes waiting rooms, work areas, restaurants and other eating areas, time clocks, restrooms, washrooms, locker rooms, and other storage or dressing areas, parking lots, drinking fountains, recreation or entertainment areas, transportation, and housing provided for employees. The contractor shall provide separate or single-user restrooms and necessary dressing or sleeping areas to assure privacy between sexes.

IV. DAVIS-BACON AND RELATED ACT PROVISIONS

This section is applicable to all Federal-aid construction projects exceeding \$2,000 and to all related subcontracts and lower-tier subcontracts (regardless of subcontract size). The requirements apply to all projects located within the right-of-way of a roadway that is functionally classified as Federal-aid highway. This excludes roadways functionally classified as local roads or rural minor collectors, which are exempt. Contracting agencies may elect to apply these requirements to other projects.

The following provisions are from the U.S. Department of Labor regulations in 29 CFR 5.5 "Contract provisions and related matters" with minor revisions to conform to the FHWA-1273 format and FHWA program requirements.

1. Minimum wages

a. All laborers and mechanics employed or working upon the site of the work, will be paid unconditionally and not less often than once a week, and without subsequent deduction or rebate on any account (except such payroll deductions as are permitted by regulations issued by the Secretary of Labor under the Copeland Act (29 CFR part 3)), the full amount of wages and bona fide fringe benefits (or cash equivalents thereof) due at time of payment computed at rates not less than those contained in the wage determination of the Secretary of Labor which is attached hereto and made a part hereof, regardless of any contractual relationship which may be alleged to exist between the contractor and such laborers and mechanics.

Contributions made or costs reasonably anticipated for bona fide fringe benefits under section 1(b)(2) of the Davis-Bacon Act on behalf of laborers or mechanics are considered wages paid to such laborers or mechanics, subject to the provisions

of paragraph 1.d. of this section; also, regular contributions made or costs incurred for more than a weekly period (but not less often than quarterly) under plans, funds, or programs which cover the particular weekly period, are deemed to be constructively made or incurred during such weekly period. Such laborers and mechanics shall be paid the appropriate wage rate and fringe benefits on the wage determination for the classification of work actually performed, without regard to skill, except as provided in 29 CFR 5.5(a)(4). Laborers or mechanics performing work in more than one classification may be compensated at the rate specified for each classification for the time actually worked therein: Provided, That the employer's payroll records accurately set forth the time spent in each classification in which work is performed. The wage determination (including any additional classification and wage rates conformed under paragraph 1.b. of this section) and the Davis-Bacon poster (WH-1321) shall be posted at all times by the contractor and its subcontractors at the site of the work in a prominent and accessible place where it can be easily seen by the workers.

b.(1) The contracting officer shall require that any class of laborers or mechanics, including helpers, which is not listed in the wage determination and which is to be employed under the contract shall be classified in conformance with the wage determination. The contracting officer shall approve an additional classification and wage rate and fringe benefits therefore only when the following criteria have been met:

- (i) The work to be performed by the classification requested is not performed by a classification in the wage determination; and
- (ii) The classification is utilized in the area by the construction industry; and
- (iii) The proposed wage rate, including any bona fide fringe benefits, bears a reasonable relationship to the wage rates contained in the wage determination.

(2) If the contractor and the laborers and mechanics to be employed in the classification (if known), or their representatives, and the contracting officer agree on the classification and wage rate (including the amount designated for fringe benefits where appropriate), a report of the action taken shall be sent by the contracting officer to the Administrator of the Wage and Hour Division, Employment Standards Administration, U.S. Department of Labor, Washington, DC 20210. The Administrator, or an authorized representative, will approve, modify, or disapprove every additional classification action within 30 days of receipt and so advise the contracting officer or will notify the contracting officer within the 30-day period that additional time is necessary.

(3) In the event the contractor, the laborers or mechanics to be employed in the classification or their representatives, and the contracting officer do not agree on the proposed classification and wage rate (including the amount designated for fringe benefits, where appropriate), the contracting officer shall refer the questions, including the views of all interested parties and the recommendation of the contracting officer, to the Wage and Hour Administrator for determination. The Wage and Hour Administrator, or an authorized representative, will issue a determination within 30 days of receipt and so advise the contracting officer or

will notify the contracting officer within the 30-day period that additional time is necessary.

(4) The wage rate (including fringe benefits where appropriate) determined pursuant to paragraphs 1.b.(2) or 1.b.(3) of this section, shall be paid to all workers performing work in the classification under this contract from the first day on which work is performed in the classification.

c. Whenever the minimum wage rate prescribed in the contract for a class of laborers or mechanics includes a fringe benefit which is not expressed as an hourly rate, the contractor shall either pay the benefit as stated in the wage determination or shall pay another bona fide fringe benefit or an hourly cash equivalent thereof.

d. If the contractor does not make payments to a trustee or other third person, the contractor may consider as part of the wages of any laborer or mechanic the amount of any costs reasonably anticipated in providing bona fide fringe benefits under a plan or program. Provided, That the Secretary of Labor has found, upon the written request of the contractor, that the applicable standards of the Davis-Bacon Act have been met. The Secretary of Labor may require the contractor to set aside in a separate account assets for the meeting of obligations under the plan or program.

2. Withholding

The contracting agency shall upon its own action or upon written request of an authorized representative of the Department of Labor, withhold or cause to be withheld from the contractor under this contract, or any other Federal contract with the same prime contractor, or any other federally-assisted contract subject to Davis-Bacon prevailing wage requirements, which is held by the same prime contractor, so much of the accrued payments or advances as may be considered necessary to pay laborers and mechanics, including apprentices, trainees, and helpers, employed by the contractor or any subcontractor the full amount of wages required by the contract. In the event of failure to pay any laborer or mechanic, including any apprentice, trainee, or helper, employed or working on the site of the work, all or part of the wages required by the contract, the contracting agency may, after written notice to the contractor, take such action as may be necessary to cause the suspension of any further payment, advance, or guarantee of funds until such violations have ceased.

3. Payrolls and basic records

a. Payrolls and basic records relating thereto shall be maintained by the contractor during the course of the work and preserved for a period of three years thereafter for all laborers and mechanics working at the site of the work. Such records shall contain the name, address, and social security number of each such worker, his or her correct classification, hourly rates of wages paid (including rates of contributions or costs anticipated for bona fide fringe benefits or cash equivalents thereof of the types described in section 1(b)(2)(B) of the Davis-Bacon Act), daily and weekly number of hours worked, deductions made and actual wages paid. Whenever the Secretary of Labor has found under 29 CFR 5.5(a)(1)(iv) that the wages of any laborer or mechanic include the amount of any costs reasonably anticipated in providing benefits under a plan or program described in section 1(b)(2)(B) of the Davis-

Bacon Act, the contractor shall maintain records which show that the commitment to provide such benefits is enforceable, that the plan or program is financially responsible, and that the plan or program has been communicated in writing to the laborers or mechanics affected, and records which show the costs anticipated or the actual cost incurred in providing such benefits. Contractors employing apprentices or trainees under approved programs shall maintain written evidence of the registration of apprenticeship programs and certification of trainee programs, the registration of the apprentices and trainees, and the ratios and wage rates prescribed in the applicable programs.

b.(1) The contractor shall submit weekly for each week in which any contract work is performed a copy of all payrolls to the contracting agency. The payrolls submitted shall set out accurately and completely all of the information required to be maintained under 29 CFR 5.5(a)(3)(i), except that full social security numbers and home addresses shall not be included on weekly transmittals. Instead the payrolls shall only need to include an individually identifying number for each employee (e.g., the last four digits of the employee's social security number). The required weekly payroll information may be submitted in any form desired. Optional Form WH-347 is available for this purpose from the Wage and Hour Division Web site at <http://www.dol.gov/esa/whd/forms/wh347instr.htm> or its successor site. The prime contractor is responsible for the submission of copies of payrolls by all subcontractors. Contractors and subcontractors shall maintain the full social security number and current address of each covered worker, and shall provide them upon request to the contracting agency for transmission to the State DOT, the FHWA or the Wage and Hour Division of the Department of Labor for purposes of an investigation or audit of compliance with prevailing wage requirements. It is not a violation of this section for a prime contractor to require a subcontractor to provide addresses and social security numbers to the prime contractor for its own records, without weekly submission to the contracting agency..

(2) Each payroll submitted shall be accompanied by a "Statement of Compliance," signed by the contractor or subcontractor or his or her agent who pays or supervises the payment of the persons employed under the contract and shall certify the following:

(i) That the payroll for the payroll period contains the information required to be provided under §5.5 (a)(3)(ii) of Regulations, 29 CFR part 5, the appropriate information is being maintained under §5.5 (a)(3)(i) of Regulations, 29 CFR part 5, and that such information is correct and complete;

(ii) That each laborer or mechanic (including each helper, apprentice, and trainee) employed on the contract during the payroll period has been paid the full weekly wages earned, without rebate, either directly or indirectly, and that no deductions have been made either directly or indirectly from the full wages earned, other than permissible deductions as set forth in Regulations, 29 CFR part 3;

(iii) That each laborer or mechanic has been paid not less than the applicable wage rates and fringe benefits or cash equivalents for the classification of work performed, as specified in the applicable wage determination incorporated into the contract.

(3) The weekly submission of a properly executed certification set forth on the reverse side of Optional Form WH-347 shall satisfy the requirement for submission of the "Statement of Compliance" required by paragraph 3.b.(2) of this section.

(4) The falsification of any of the above certifications may subject the contractor or subcontractor to civil or criminal prosecution under section 1001 of title 18 and section 231 of title 31 of the United States Code.

c. The contractor or subcontractor shall make the records required under paragraph 3.a. of this section available for inspection, copying, or transcription by authorized representatives of the contracting agency, the State DOT, the FHWA, or the Department of Labor, and shall permit such representatives to interview employees during working hours on the job. If the contractor or subcontractor fails to submit the required records or to make them available, the FHWA may, after written notice to the contractor, the contracting agency or the State DOT, take such action as may be necessary to cause the suspension of any further payment, advance, or guarantee of funds. Furthermore, failure to submit the required records upon request or to make such records available may be grounds for debarment action pursuant to 29 CFR 5.12.

4. Apprentices and trainees

a. Apprentices (programs of the USDOL).

Apprentices will be permitted to work at less than the predetermined rate for the work they performed when they are employed pursuant to and individually registered in a bona fide apprenticeship program registered with the U.S. Department of Labor, Employment and Training Administration, Office of Apprenticeship Training, Employer and Labor Services, or with a State Apprenticeship Agency recognized by the Office, or if a person is employed in his or her first 90 days of probationary employment as an apprentice in such an apprenticeship program, who is not individually registered in the program, but who has been certified by the Office of Apprenticeship Training, Employer and Labor Services or a State Apprenticeship Agency (where appropriate) to be eligible for probationary employment as an apprentice.

The allowable ratio of apprentices to journeymen on the job site in any craft classification shall not be greater than the ratio permitted to the contractor as to the entire work force under the registered program. Any worker listed on a payroll at an apprentice wage rate, who is not registered or otherwise employed as stated above, shall be paid not less than the applicable wage rate on the wage determination for the classification of work actually performed. In addition, any apprentice performing work on the job site in excess of the ratio permitted under the registered program shall be paid not less than the applicable wage rate on the wage determination for the work actually performed. Where a contractor is performing construction on a project in a locality other than that in which its program is registered, the ratios and wage rates (expressed in percentages of the journeyman's hourly rate) specified in the contractor's or subcontractor's registered program shall be observed.

Every apprentice must be paid at not less than the rate specified in the registered program for the apprentice's level of progress, expressed as a percentage of the journeymen hourly

rate specified in the applicable wage determination. Apprentices shall be paid fringe benefits in accordance with the provisions of the apprenticeship program. If the apprenticeship program does not specify fringe benefits, apprentices must be paid the full amount of fringe benefits listed on the wage determination for the applicable classification. If the Administrator determines that a different practice prevails for the applicable apprentice classification, fringes shall be paid in accordance with that determination.

In the event the Office of Apprenticeship Training, Employer and Labor Services, or a State Apprenticeship Agency recognized by the Office, withdraws approval of an apprenticeship program, the contractor will no longer be permitted to utilize apprentices at less than the applicable predetermined rate for the work performed until an acceptable program is approved.

b. Trainees (programs of the USDOL).

Except as provided in 29 CFR 5.16, trainees will not be permitted to work at less than the predetermined rate for the work performed unless they are employed pursuant to and individually registered in a program which has received prior approval, evidenced by formal certification by the U.S. Department of Labor, Employment and Training Administration.

The ratio of trainees to journeymen on the job site shall not be greater than permitted under the plan approved by the Employment and Training Administration.

Every trainee must be paid at not less than the rate specified in the approved program for the trainee's level of progress, expressed as a percentage of the journeyman hourly rate specified in the applicable wage determination. Trainees shall be paid fringe benefits in accordance with the provisions of the trainee program. If the trainee program does not mention fringe benefits, trainees shall be paid the full amount of fringe benefits listed on the wage determination unless the Administrator of the Wage and Hour Division determines that there is an apprenticeship program associated with the corresponding journeyman wage rate on the wage determination which provides for less than full fringe benefits for apprentices. Any employee listed on the payroll at a trainee rate who is not registered and participating in a training plan approved by the Employment and Training Administration shall be paid not less than the applicable wage rate on the wage determination for the classification of work actually performed. In addition, any trainee performing work on the job site in excess of the ratio permitted under the registered program shall be paid not less than the applicable wage rate on the wage determination for the work actually performed.

In the event the Employment and Training Administration withdraws approval of a training program, the contractor will no longer be permitted to utilize trainees at less than the applicable predetermined rate for the work performed until an acceptable program is approved.

c. Equal employment opportunity. The utilization of apprentices, trainees and journeymen under this part shall be in conformity with the equal employment opportunity requirements of Executive Order 11246, as amended, and 29 CFR part 30.

d. Apprentices and Trainees (programs of the U.S. DOT).

Apprentices and trainees working under apprenticeship and skill training programs which have been certified by the Secretary of Transportation as promoting EEO in connection with Federal-aid highway construction programs are not subject to the requirements of paragraph 4 of this Section IV. The straight time hourly wage rates for apprentices and trainees under such programs will be established by the particular programs. The ratio of apprentices and trainees to journeymen shall not be greater than permitted by the terms of the particular program.

5. Compliance with Copeland Act requirements. The contractor shall comply with the requirements of 29 CFR part 3, which are incorporated by reference in this contract.

6. Subcontracts. The contractor or subcontractor shall insert Form FHWA-1273 in any subcontracts and also require the subcontractors to include Form FHWA-1273 in any lower tier subcontracts. The prime contractor shall be responsible for the compliance by any subcontractor or lower tier subcontractor with all the contract clauses in 29 CFR 5.5.

7. Contract termination: debarment. A breach of the contract clauses in 29 CFR 5.5 may be grounds for termination of the contract, and for debarment as a contractor and a subcontractor as provided in 29 CFR 5.12.

8. Compliance with Davis-Bacon and Related Act requirements. All rulings and interpretations of the Davis-Bacon and Related Acts contained in 29 CFR parts 1, 3, and 5 are herein incorporated by reference in this contract.

9. Disputes concerning labor standards. Disputes arising out of the labor standards provisions of this contract shall not be subject to the general disputes clause of this contract. Such disputes shall be resolved in accordance with the procedures of the Department of Labor set forth in 29 CFR parts 5, 6, and 7. Disputes within the meaning of this clause include disputes between the contractor (or any of its subcontractors) and the contracting agency, the U.S. Department of Labor, or the employees or their representatives.

10. Certification of eligibility.

a. By entering into this contract, the contractor certifies that neither it (nor he or she) nor any person or firm who has an interest in the contractor's firm is a person or firm ineligible to be awarded Government contracts by virtue of section 3(a) of the Davis-Bacon Act or 29 CFR 5.12(a)(1).

b. No part of this contract shall be subcontracted to any person or firm ineligible for award of a Government contract by virtue of section 3(a) of the Davis-Bacon Act or 29 CFR 5.12(a)(1).

c. The penalty for making false statements is prescribed in the U.S. Criminal Code, 18 U.S.C. 1001.

V. CONTRACT WORK HOURS AND SAFETY STANDARDS ACT

The following clauses apply to any Federal-aid construction contract in an amount in excess of \$100,000 and subject to the overtime provisions of the Contract Work Hours and Safety Standards Act. These clauses shall be inserted in addition to the clauses required by 29 CFR 5.5(a) or 29 CFR 4.6. As used in this paragraph, the terms laborers and mechanics include watchmen and guards.

1. Overtime requirements. No contractor or subcontractor contracting for any part of the contract work which may require or involve the employment of laborers or mechanics shall require or permit any such laborer or mechanic in any workweek in which he or she is employed on such work to work in excess of forty hours in such workweek unless such laborer or mechanic receives compensation at a rate not less than one and one-half times the basic rate of pay for all hours worked in excess of forty hours in such workweek.

2. Violation; liability for unpaid wages; liquidated damages. In the event of any violation of the clause set forth in paragraph (1.) of this section, the contractor and any subcontractor responsible therefor shall be liable for the unpaid wages. In addition, such contractor and subcontractor shall be liable to the United States (in the case of work done under contract for the District of Columbia or a territory, to such District or to such territory), for liquidated damages. Such liquidated damages shall be computed with respect to each individual laborer or mechanic, including watchmen and guards, employed in violation of the clause set forth in paragraph (1.) of this section, in the sum of \$10 for each calendar day on which such individual was required or permitted to work in excess of the standard workweek of forty hours without payment of the overtime wages required by the clause set forth in paragraph (1.) of this section.

3. Withholding for unpaid wages and liquidated damages. The FHWA or the contracting agency shall upon its own action or upon written request of an authorized representative of the Department of Labor withhold or cause to be withheld, from any moneys payable on account of work performed by the contractor or subcontractor under any such contract or any other Federal contract with the same prime contractor, or any other federally-assisted contract subject to the Contract Work Hours and Safety Standards Act, which is held by the same prime contractor, such sums as may be determined to be necessary to satisfy any liabilities of such contractor or subcontractor for unpaid wages and liquidated damages as provided in the clause set forth in paragraph (2.) of this section.

4. Subcontracts. The contractor or subcontractor shall insert in any subcontracts the clauses set forth in paragraph (1.) through (4.) of this section and also a clause requiring the subcontractors to include these clauses in any lower tier subcontracts. The prime contractor shall be responsible for compliance by any subcontractor or lower tier subcontractor with the clauses set forth in paragraphs (1.) through (4.) of this section.

VI. SUBLETTING OR ASSIGNING THE CONTRACT

This provision is applicable to all Federal-aid construction contracts on the National Highway System.

1. The contractor shall perform with its own organization contract work amounting to not less than 30 percent (or a greater percentage if specified elsewhere in the contract) of the total original contract price, excluding any specialty items designated by the contracting agency. Specialty items may be performed by subcontract and the amount of any such specialty items performed may be deducted from the total original contract price before computing the amount of work required to be performed by the contractor's own organization (23 CFR 635.116).

a. The term "perform work with its own organization" refers to workers employed or leased by the prime contractor, and equipment owned or rented by the prime contractor, with or without operators. Such term does not include employees or equipment of a subcontractor or lower tier subcontractor, agents of the prime contractor, or any other assignees. The term may include payments for the costs of hiring leased employees from an employee leasing firm meeting all relevant Federal and State regulatory requirements. Leased employees may only be included in this term if the prime contractor meets all of the following conditions:

(1) the prime contractor maintains control over the supervision of the day-to-day activities of the leased employees;

(2) the prime contractor remains responsible for the quality of the work of the leased employees;

(3) the prime contractor retains all power to accept or exclude individual employees from work on the project; and

(4) the prime contractor remains ultimately responsible for the payment of predetermined minimum wages, the submission of payrolls, statements of compliance and all other Federal regulatory requirements.

b. "Specialty Items" shall be construed to be limited to work that requires highly specialized knowledge, abilities, or equipment not ordinarily available in the type of contracting organizations qualified and expected to bid or propose on the contract as a whole and in general are to be limited to minor components of the overall contract.

2. The contract amount upon which the requirements set forth in paragraph (1) of Section VI is computed includes the cost of material and manufactured products which are to be purchased or produced by the contractor under the contract provisions.

3. The contractor shall furnish (a) a competent superintendent or supervisor who is employed by the firm, has full authority to direct performance of the work in accordance with the contract requirements, and is in charge of all construction operations (regardless of who performs the work) and (b) such other of its own organizational resources (supervision, management, and engineering services) as the contracting officer determines is necessary to assure the performance of the contract.

4. No portion of the contract shall be sublet, assigned or otherwise disposed of except with the written consent of the contracting officer, or authorized representative, and such consent when given shall not be construed to relieve the contractor of any responsibility for the fulfillment of the contract. Written consent will be given only after the contracting agency has assured that each subcontract is

evidenced in writing and that it contains all pertinent provisions and requirements of the prime contract.

5. The 30% self-performance requirement of paragraph (1) is not applicable to design-build contracts; however, contracting agencies may establish their own self-performance requirements.

VII. SAFETY: ACCIDENT PREVENTION

This provision is applicable to all Federal-aid construction contracts and to all related subcontracts.

1. In the performance of this contract the contractor shall comply with all applicable Federal, State, and local laws governing safety, health, and sanitation (23 CFR 635). The contractor shall provide all safeguards, safety devices and protective equipment and take any other needed actions as it determines, or as the contracting officer may determine, to be reasonably necessary to protect the life and health of employees on the job and the safety of the public and to protect property in connection with the performance of the work covered by the contract.

2. It is a condition of this contract, and shall be made a condition of each subcontract, which the contractor enters into pursuant to this contract, that the contractor and any subcontractor shall not permit any employee, in performance of the contract, to work in surroundings or under conditions which are unsanitary, hazardous or dangerous to his/her health or safety, as determined under construction safety and health standards (29 CFR 1926) promulgated by the Secretary of Labor, in accordance with Section 107 of the Contract Work Hours and Safety Standards Act (40 U.S.C. 3704).

3. Pursuant to 29 CFR 1926.3, it is a condition of this contract that the Secretary of Labor or authorized representative thereof, shall have right of entry to any site of contract performance to inspect or investigate the matter of compliance with the construction safety and health standards and to carry out the duties of the Secretary under Section 107 of the Contract Work Hours and Safety Standards Act (40 U.S.C.3704).

VIII. FALSE STATEMENTS CONCERNING HIGHWAY PROJECTS

This provision is applicable to all Federal-aid construction contracts and to all related subcontracts.

In order to assure high quality and durable construction in conformity with approved plans and specifications and a high degree of reliability on statements and representations made by engineers, contractors, suppliers, and workers on Federal-aid highway projects, it is essential that all persons concerned with the project perform their functions as carefully, thoroughly, and honestly as possible. Willful falsification, distortion, or misrepresentation with respect to any facts related to the project is a violation of Federal law. To prevent any misunderstanding regarding the seriousness of these and similar acts, Form FHWA-1022 shall be posted on each Federal-aid highway project (23 CFR 635) in one or more places where it is readily available to all persons concerned with the project:

18 U.S.C. 1020 reads as follows:

"Whoever, being an officer, agent, or employee of the United States, or of any State or Territory, or whoever, whether a person, association, firm, or corporation, knowingly makes any false statement, false representation, or false report as to the character, quality, quantity, or cost of the material used or to be used, or the quantity or quality of the work performed or to be performed, or the cost thereof in connection with the submission of plans, maps, specifications, contracts, or costs of construction on any highway or related project submitted for approval to the Secretary of Transportation; or

Whoever knowingly makes any false statement, false representation, false report or false claim with respect to the character, quality, quantity, or cost of any work performed or to be performed, or materials furnished or to be furnished, in connection with the construction of any highway or related project approved by the Secretary of Transportation; or

Whoever knowingly makes any false statement or false representation as to material fact in any statement, certificate, or report submitted pursuant to provisions of the Federal-aid Roads Act approved July 1, 1916, (39 Stat. 355), as amended and supplemented;

Shall be fined under this title or imprisoned not more than 5 years or both."

IX. IMPLEMENTATION OF CLEAN AIR ACT AND FEDERAL WATER POLLUTION CONTROL ACT

This provision is applicable to all Federal-aid construction contracts and to all related subcontracts.

By submission of this bid/proposal or the execution of this contract, or subcontract, as appropriate, the bidder, proposer, Federal-aid construction contractor, or subcontractor, as appropriate, will be deemed to have stipulated as follows:

1. That any person who is or will be utilized in the performance of this contract is not prohibited from receiving an award due to a violation of Section 508 of the Clean Water Act or Section 306 of the Clean Air Act.

2. That the contractor agrees to include or cause to be included the requirements of paragraph (1) of this Section X in every subcontract, and further agrees to take such action as the contracting agency may direct as a means of enforcing such requirements.

X. CERTIFICATION REGARDING DEBARMENT, SUSPENSION, INELIGIBILITY AND VOLUNTARY EXCLUSION

This provision is applicable to all Federal-aid construction contracts, design-build contracts, subcontracts, lower-tier subcontracts, purchase orders, lease agreements, consultant contracts or any other covered transaction requiring FHWA approval or that is estimated to cost \$25,000 or more – as defined in 2 CFR Parts 180 and 1200.

1. Instructions for Certification – First Tier Participants:

a. By signing and submitting this proposal, the prospective first tier participant is providing the certification set out below.

b. The inability of a person to provide the certification set out below will not necessarily result in denial of participation in this

covered transaction. The prospective first tier participant shall submit an explanation of why it cannot provide the certification set out below. The certification or explanation will be considered in connection with the department or agency's determination whether to enter into this transaction. However, failure of the prospective first tier participant to furnish a certification or an explanation shall disqualify such a person from participation in this transaction.

c. The certification in this clause is a material representation of fact upon which reliance was placed when the contracting agency determined to enter into this transaction. If it is later determined that the prospective participant knowingly rendered an erroneous certification, in addition to other remedies available to the Federal Government, the contracting agency may terminate this transaction for cause of default.

d. The prospective first tier participant shall provide immediate written notice to the contracting agency to whom this proposal is submitted if any time the prospective first tier participant learns that its certification was erroneous when submitted or has become erroneous by reason of changed circumstances.

e. The terms "covered transaction," "debarred," "suspended," "ineligible," "participant," "person," "principal," and "voluntarily excluded," as used in this clause, are defined in 2 CFR Parts 180 and 1200. "First Tier Covered Transactions" refers to any covered transaction between a grantee or subgrantee of Federal funds and a participant (such as the prime or general contract). "Lower Tier Covered Transactions" refers to any covered transaction under a First Tier Covered Transaction (such as subcontracts). "First Tier Participant" refers to the participant who has entered into a covered transaction with a grantee or subgrantee of Federal funds (such as the prime or general contractor). "Lower Tier Participant" refers any participant who has entered into a covered transaction with a First Tier Participant or other Lower Tier Participants (such as subcontractors and suppliers).

f. The prospective first tier participant agrees by submitting this proposal that, should the proposed covered transaction be entered into, it shall not knowingly enter into any lower tier covered transaction with a person who is debarred, suspended, declared ineligible, or voluntarily excluded from participation in this covered transaction, unless authorized by the department or agency entering into this transaction.

g. The prospective first tier participant further agrees by submitting this proposal that it will include the clause titled "Certification Regarding Debarment, Suspension, Ineligibility and Voluntary Exclusion-Lower Tier Covered Transactions," provided by the department or contracting agency, entering into this covered transaction, without modification, in all lower tier covered transactions and in all solicitations for lower tier covered transactions exceeding the \$25,000 threshold.

h. A participant in a covered transaction may rely upon a certification of a prospective participant in a lower tier covered transaction that is not debarred, suspended, ineligible, or voluntarily excluded from the covered transaction, unless it knows that the certification is erroneous. A participant is responsible for ensuring that its principals are not suspended, debarred, or otherwise ineligible to participate in covered transactions. To verify the eligibility of its principals, as well as the eligibility of any lower tier prospective participants, each participant may, but is not required to, check the Excluded Parties List System website (<https://www.epls.gov/>), which is compiled by the General Services Administration.

i. Nothing contained in the foregoing shall be construed to require the establishment of a system of records in order to render in good faith the certification required by this clause. The knowledge and information of the prospective participant is not required to exceed that which is normally possessed by a prudent person in the ordinary course of business dealings.

j. Except for transactions authorized under paragraph (f) of these instructions, if a participant in a covered transaction knowingly enters into a lower tier covered transaction with a person who is suspended, debarred, ineligible, or voluntarily excluded from participation in this transaction, in addition to other remedies available to the Federal Government, the department or agency may terminate this transaction for cause or default.

* * * * *

2. Certification Regarding Debarment, Suspension, Ineligibility and Voluntary Exclusion – First Tier Participants:

a. The prospective first tier participant certifies to the best of its knowledge and belief, that it and its principals:

- (1) Are not presently debarred, suspended, proposed for debarment, declared ineligible, or voluntarily excluded from participating in covered transactions by any Federal department or agency;
- (2) Have not within a three-year period preceding this proposal been convicted of or had a civil judgment rendered against them for commission of fraud or a criminal offense in connection with obtaining, attempting to obtain, or performing a public (Federal, State or local) transaction or contract under a public transaction; violation of Federal or State antitrust statutes or commission of embezzlement, theft, forgery, bribery, falsification or destruction of records, making false statements, or receiving stolen property;
- (3) Are not presently indicted for or otherwise criminally or civilly charged by a governmental entity (Federal, State or local) with commission of any of the offenses enumerated in paragraph (a)(2) of this certification; and
- (4) Have not within a three-year period preceding this application/proposal had one or more public transactions (Federal, State or local) terminated for cause or default.

b. Where the prospective participant is unable to certify to any of the statements in this certification, such prospective participant shall attach an explanation to this proposal.

2. Instructions for Certification - Lower Tier Participants:

(Applicable to all subcontracts, purchase orders and other lower tier transactions requiring prior FHWA approval or estimated to cost \$25,000 or more - 2 CFR Parts 180 and 1200)

a. By signing and submitting this proposal, the prospective lower tier is providing the certification set out below.

b. The certification in this clause is a material representation of fact upon which reliance was placed when this transaction was entered into. If it is later determined that the prospective lower tier participant knowingly rendered an erroneous certification, in addition to other remedies available to the Federal Government, the department, or agency with which

this transaction originated may pursue available remedies, including suspension and/or debarment.

c. The prospective lower tier participant shall provide immediate written notice to the person to which this proposal is submitted if at any time the prospective lower tier participant learns that its certification was erroneous by reason of changed circumstances.

d. The terms "covered transaction," "debarred," "suspended," "ineligible," "participant," "person," "principal," and "voluntarily excluded," as used in this clause, are defined in 2 CFR Parts 180 and 1200. You may contact the person to which this proposal is submitted for assistance in obtaining a copy of those regulations. "First Tier Covered Transactions" refers to any covered transaction between a grantee or subgrantee of Federal funds and a participant (such as the prime or general contract). "Lower Tier Covered Transactions" refers to any covered transaction under a First Tier Covered Transaction (such as subcontracts). "First Tier Participant" refers to the participant who has entered into a covered transaction with a grantee or subgrantee of Federal funds (such as the prime or general contractor). "Lower Tier Participant" refers any participant who has entered into a covered transaction with a First Tier Participant or other Lower Tier Participants (such as subcontractors and suppliers).

e. The prospective lower tier participant agrees by submitting this proposal that, should the proposed covered transaction be entered into, it shall not knowingly enter into any lower tier covered transaction with a person who is debarred, suspended, declared ineligible, or voluntarily excluded from participation in this covered transaction, unless authorized by the department or agency with which this transaction originated.

f. The prospective lower tier participant further agrees by submitting this proposal that it will include this clause titled "Certification Regarding Debarment, Suspension, Ineligibility and Voluntary Exclusion-Lower Tier Covered Transaction," without modification, in all lower tier covered transactions and in all solicitations for lower tier covered transactions exceeding the \$25,000 threshold.

g. A participant in a covered transaction may rely upon a certification of a prospective participant in a lower tier covered transaction that is not debarred, suspended, ineligible, or voluntarily excluded from the covered transaction, unless it knows that the certification is erroneous. A participant is responsible for ensuring that its principals are not suspended, debarred, or otherwise ineligible to participate in covered transactions. To verify the eligibility of its principals, as well as the eligibility of any lower tier prospective participants, each participant may, but is not required to, check the Excluded Parties List System website (<https://www.epls.gov/>), which is compiled by the General Services Administration.

h. Nothing contained in the foregoing shall be construed to require establishment of a system of records in order to render in good faith the certification required by this clause. The knowledge and information of participant is not required to exceed that which is normally possessed by a prudent person in the ordinary course of business dealings.

i. Except for transactions authorized under paragraph e of these instructions, if a participant in a covered transaction knowingly enters into a lower tier covered transaction with a person who is suspended, debarred, ineligible, or voluntarily excluded from participation in this transaction, in addition to other remedies available to the Federal Government, the

department or agency with which this transaction originated may pursue available remedies, including suspension and/or debarment.

* * * * *

Certification Regarding Debarment, Suspension, Ineligibility and Voluntary Exclusion--Lower Tier Participants:

1. The prospective lower tier participant certifies, by submission of this proposal, that neither it nor its principals is presently debarred, suspended, proposed for debarment, declared ineligible, or voluntarily excluded from participating in covered transactions by any Federal department or agency.

2. Where the prospective lower tier participant is unable to certify to any of the statements in this certification, such prospective participant shall attach an explanation to this proposal.

* * * * *

XI. CERTIFICATION REGARDING USE OF CONTRACT FUNDS FOR LOBBYING

This provision is applicable to all Federal-aid construction contracts and to all related subcontracts which exceed \$100,000 (49 CFR 20).

1. The prospective participant certifies, by signing and submitting this bid or proposal, to the best of his or her knowledge and belief, that:

a. No Federal appropriated funds have been paid or will be paid, by or on behalf of the undersigned, to any person for influencing or attempting to influence an officer or employee of any Federal agency, a Member of Congress, an officer or employee of Congress, or an employee of a Member of Congress in connection with the awarding of any Federal contract, the making of any Federal grant, the making of any Federal loan, the entering into of any cooperative agreement, and the extension, continuation, renewal, amendment, or modification of any Federal contract, grant, loan, or cooperative agreement.

b. If any funds other than Federal appropriated funds have been paid or will be paid to any person for influencing or attempting to influence an officer or employee of any Federal agency, a Member of Congress, an officer or employee of Congress, or an employee of a Member of Congress in connection with this Federal contract, grant, loan, or cooperative agreement, the undersigned shall complete and submit Standard Form-LLL, "Disclosure Form to Report Lobbying," in accordance with its instructions.

2. This certification is a material representation of fact upon which reliance was placed when this transaction was made or entered into. Submission of this certification is a prerequisite for making or entering into this transaction imposed by 31 U.S.C. 1352. Any person who fails to file the required certification shall be subject to a civil penalty of not less than \$10,000 and not more than \$100,000 for each such failure.

3. The prospective participant also agrees by submitting its bid or proposal that the participant shall require that the language of this certification be included in all lower tier subcontracts, which exceed \$100,000 and that all such recipients shall certify and disclose accordingly.

**ATTACHMENT A - EMPLOYMENT AND MATERIALS
PREFERENCE FOR APPALACHIAN DEVELOPMENT
HIGHWAY SYSTEM OR APPALACHIAN LOCAL ACCESS
ROAD CONTRACTS**

This provision is applicable to all Federal-aid projects funded under the Appalachian Regional Development Act of 1965.

1. During the performance of this contract, the contractor undertaking to do work which is, or reasonably may be, done as on-site work, shall give preference to qualified persons who regularly reside in the labor area as designated by the DOL wherein the contract work is situated, or the subregion, or the Appalachian counties of the State wherein the contract work is situated, except:

a. To the extent that qualified persons regularly residing in the area are not available.

b. For the reasonable needs of the contractor to employ supervisory or specially experienced personnel necessary to assure an efficient execution of the contract work.

c. For the obligation of the contractor to offer employment to present or former employees as the result of a lawful collective bargaining contract, provided that the number of nonresident persons employed under this subparagraph (1c) shall not exceed 20 percent of the total number of employees employed by the contractor on the contract work, except as provided in subparagraph (4) below.

2. The contractor shall place a job order with the State Employment Service indicating (a) the classifications of the laborers, mechanics and other employees required to perform the contract work, (b) the number of employees required in each classification, (c) the date on which the participant estimates such employees will be required, and (d) any other pertinent information required by the State Employment Service to complete the job order form. The job order may be placed with the State Employment Service in writing or by telephone. If during the course of the contract work, the information submitted by the contractor in the original job order is substantially modified, the participant shall promptly notify the State Employment Service.

3. The contractor shall give full consideration to all qualified job applicants referred to him by the State Employment Service. The contractor is not required to grant employment to any job applicants who, in his opinion, are not qualified to perform the classification of work required.

4. If, within one week following the placing of a job order by the contractor with the State Employment Service, the State Employment Service is unable to refer any qualified job applicants to the contractor, or less than the number requested, the State Employment Service will forward a certificate to the contractor indicating the unavailability of applicants. Such certificate shall be made a part of the contractor's permanent project records. Upon receipt of this certificate, the contractor may employ persons who do not normally reside in the labor area to fill positions covered by the certificate, notwithstanding the provisions of subparagraph (1c) above.

5. The provisions of 23 CFR 633.207(e) allow the contracting agency to provide a contractual preference for the use of mineral resource materials native to the Appalachian region.

6. The contractor shall include the provisions of Sections 1 through 4 of this Attachment A in every subcontract for work which is, or reasonably may be, done as on-site work.

**KENTUCKY TRANSPORTATION CABINET
DEPARTMENT OF HIGHWAYS**

**EMPLOYMENT REQUIREMENTS
RELATING TO
NONDISCRIMINATION OF EMPLOYEES
(APPLICABLE TO FEDERAL-AID SYSTEM CONTRACTS)**

**AN ACT OF THE KENTUCKY GENERAL ASSEMBLY
TO PREVENT DISCRIMINATION IN EMPLOYMENT**

**KRS CHAPTER 344
EFFECTIVE JUNE 16, 1972**

The contract on this project, in accordance with KRS Chapter 344, provides that during the performance of this contract, the contractor agrees as follows:

1. The contractor shall not fail or refuse to hire, or shall not discharge any individual, or otherwise discriminate against an individual with respect to his compensation, terms, conditions, or privileges of employment, because of such individual's race, color, religion, national origin, sex, disability or age (forty and above); or limit, segregate, or classify his employees in any way which would deprive or tend to deprive an individual of employment opportunities or otherwise adversely affect his status as an employee, because of such individual's race, color, religion, national origin, sex, disability or age forty (40) and over. The contractor agrees to post in conspicuous places, available to employees and applicants for employment, notices to be provided setting forth the provisions of this nondiscrimination clause.

2. The contractor shall not print or publish or cause to be printed or published a notice or advertisement relating to employment by such an employer or membership in or any classification or referral for employment by the employment agency, indicating any preference, limitation, specification, or discrimination, based on race, color, religion, national origin, sex, or age forty (40) and over, or because the person is a qualified individual with a disability, except that such a notice or advertisement may indicate a preference, limitation, or specification based on religion, national origin, sex, or age forty (40) and over, or because the person is a qualified individual with a disability, when religion, national origin, sex, or age forty (40) and over, or because the person is a qualified individual with a disability, is a bona fide occupational qualification for employment.

3. If the contractor is in control of apprenticeship or other training or retraining, including on-the-job training programs, he shall not discriminate against an individual because of his race, color, religion, national origin, sex, disability or age forty (40) and over, in admission to, or employment in any program established to provide apprenticeship or other training.

4. The contractor will send to each labor union or representative of workers with which he has a collective bargaining agreement or other contract or understanding, a notice to be provided advising the said labor union or workers' representative of the contractor's commitments under this section, and shall post copies of the notice in conspicuous places available to employees and applicants for employment. The contractor will take such action with respect to any subcontract or purchase order as the administering agency may direct as a means of enforcing such provisions, including sanctions for non-compliance.

Revised: January 25, 2017

Standard Title VI/Non-Discrimination Assurances

During the performance of this contract, the contractor, for itself, its assignees, and successors in interest (hereinafter referred to as the "contractor") agrees as follows:

1. **Compliance with Regulations:** The contractor (hereinafter includes consultants) will comply with the Acts and the Regulations relative to Non-discrimination in Federally-assisted programs of the U.S. Department of Transportation, **Federal Highway Administration**, as they may be amended from time to time, which are herein incorporated by reference and made a part of this contract.
2. **Non-discrimination:** The contractor, with regard to the work performed by it during the contract, will not discriminate on the grounds of race, color, or national origin in the selection and retention of subcontractors, including procurements of materials and leases of equipment. The contractor will not participate directly or indirectly in the discrimination prohibited by the Acts and the Regulations, including employment practices when the contract covers any activity, project, or program set forth in Appendix B of 49 CFR Part 21.
3. **Solicitations for Subcontracts, Including Procurements of Materials and Equipment:** In all solicitations, either by competitive bidding, or negotiation made by the contractor for work to be performed under a subcontract, including procurements of materials, or leases of equipment, each potential subcontractor or supplier will be notified by the contractor of the contractor's obligations under this contract and the Acts and the Regulations relative to Non-discrimination on the grounds of race, color, or national origin.
4. **Information and Reports:** The contractor will provide all information and reports required by the Acts, the Regulations, and directives issued pursuant thereto and will permit access to its books, records, accounts, other sources of information, and its facilities as may be determined by the Recipient or the **Federal Highway Administration** to be pertinent to ascertain compliance with such Acts, Regulations, and instructions. Where any information required of a contractor is in the exclusive possession of another who fails or refuses to furnish the information, the contractor will so certify to the Recipient or the **Federal Highway Administration**, as appropriate, and will set forth what efforts it has made to obtain the information.
5. **Sanctions for Noncompliance:** In the event of a contractor's noncompliance with the Non-discrimination provisions of this contract, the Recipient will impose such contract sanctions as it or the **Federal Highway Administration** may determine to be appropriate, including, but not limited to:
 - a. withholding payments to the contractor under the contract until the contractor complies; and/or
 - b. cancelling, terminating, or suspending a contract, in whole or in part.
6. **Incorporation of Provisions:** The contractor will include the provisions of paragraphs one through six in every subcontract, including procurements of materials and leases of equipment, unless exempt by the Acts, the Regulations and directives issued pursuant thereto. The contractor will take action with respect to any subcontract or procurement as the Recipient or the **Federal Highway Administration** may direct as a means of enforcing such provisions including sanctions for noncompliance. Provided, that if the contractor becomes involved in, or is threatened with litigation by a subcontractor, or supplier because of such direction, the contractor may request the Recipient to enter into any litigation to protect the interests of the Recipient. In addition, the contractor may request the United States to enter into the litigation to protect the interests of the United States.

Standard Title VI/Non-Discrimination Statutes and Authorities

During the performance of this contract, the contractor, for itself, its assignees, and successors in interest (hereinafter referred to as the “contractor”) agrees to comply with the following non-discrimination statutes and authorities; including but not limited to:

- Title VI of the Civil Rights Act of 1964 (42 U.S.C. § 2000d *et seq.*, 78 stat. 252), (prohibits discrimination on the basis of race, color, national origin); and 49 CFR Part 21;
- The Uniform Relocation Assistance and Real Property Acquisition Policies Act of 1970, (42 U.S.C. § 4601), (prohibits unfair treatment of persons displaced or whose property has been acquired because of Federal or Federal-aid programs and projects);
- Federal-Aid Highway Act of 1973, (23 U.S.C. § 324 *et seq.*), (prohibits discrimination on the basis of sex);
- Section 504 of the Rehabilitation Act of 1973, (29 U.S.C. § 794 *et seq.*), as amended, (prohibits discrimination on the basis of disability); and 49 CFR Part 27;
- The Age Discrimination Act of 1975, as amended, (42 U.S.C. § 6101 *et seq.*), (prohibits discrimination on the basis of age);
- Airport and Airway Improvement Act of 1982, (49 USC § 471, Section 47123), as amended, (prohibits discrimination based on race, creed, color, national origin, or sex);
- The Civil Rights Restoration Act of 1987, (PL 100-209), (Broadened the scope, coverage and applicability of Title VI of the Civil Rights Act of 1964, The Age Discrimination Act of 1975 and Section 504 of the Rehabilitation Act of 1973, by expanding the definition of the terms “programs or activities” to include all of the programs or activities of the Federal-aid recipients, sub-recipients and contractors, whether such programs or activities are Federally funded or not);
- Titles II and III of the Americans with Disabilities Act, which prohibit discrimination on the basis of disability in the operation of public entities, public and private transportation systems, places of public accommodation, and certain testing entities (42 U.S.C. §§ 12131 -- 12189) as implemented by Department of Transportation regulations at 49 C.F.R. parts 37 and 38;
- The Federal Aviation Administration’s Non-discrimination statute (49 U.S.C. § 47123) (prohibits discrimination on the basis of race, color, national origin, and sex);
- Executive Order 12898, Federal Actions to Address Environmental Justice in Minority Populations and Low-Income Populations, which ensures non-discrimination against minority populations by discouraging programs, policies, and activities with disproportionately high and adverse human health or environmental effects on minority and low-income populations;
- Executive Order 13166, Improving Access to Services for Persons with Limited English Proficiency, and resulting agency guidance, national origin discrimination includes discrimination because of limited English proficiency (LEP). To ensure compliance with Title VI, you must take reasonable steps to ensure that LEP persons have meaningful access to your programs (70 Fed. Reg. at 74087 to 74100);
- Title IX of the Education Amendments of 1972, as amended, which prohibits you from discriminating because of sex in education programs or activities (20 U.S.C. 1681 *et seq.*)

EXECUTIVE BRANCH CODE OF ETHICS

In the 1992 regular legislative session, the General Assembly passed and Governor Brereton Jones signed Senate Bill 63 (codified as KRS 11A), the Executive Branch Code of Ethics, which states, in part:

KRS 11A.040 (7) provides:

No present or former public servant shall, within six (6) months following termination of his office or employment, accept employment, compensation, or other economic benefit from any person or business that contracts or does business with, or is regulated by, the state in matters in which he was directly involved during the last thirty-six (36) months of his tenure. This provision shall not prohibit an individual from returning to the same business, firm, occupation, or profession in which he was involved prior to taking office or beginning his term of employment, or for which he received, prior to his state employment, a professional degree or license, provided that, for a period of six (6) months, he personally refrains from working on any matter in which he was directly involved during the last thirty-six (36) months of his tenure in state government. This subsection shall not prohibit the performance of ministerial functions, including but not limited to filing tax returns, filing applications for permits or licenses, or filing incorporation papers, nor shall it prohibit the former officer or public servant from receiving public funds disbursed through entitlement programs.

KRS 11A.040 (9) states:

A former public servant shall not represent a person or business before a state agency in a matter in which the former public servant was directly involved during the last thirty-six (36) months of his tenure, for a period of one (1) year after the latter of:

- a) The date of leaving office or termination of employment; or
- b) The date the term of office expires to which the public servant was elected.

This law is intended to promote public confidence in the integrity of state government and to declare as public policy the idea that state employees should view their work as a public trust and not as a way to obtain private benefits.

If you have worked for the executive branch of state government within the past six months, you may be subject to the law's prohibitions. The law's applicability may be different if you hold elected office or are contemplating representation of another before a state agency.

Also, if you are affiliated with a firm which does business with the state and which employs former state executive-branch employees, you should be aware that the law may apply to them.

In case of doubt, the law permits you to request an advisory opinion from the Executive Branch Ethics Commission, 3 Fountain Place, Frankfort, Kentucky 40601; telephone (502) 564-7954.

Revised: January 27, 2017

KENTUCKY TRANSPORTATION CABINET
DEPARTMENT OF HIGHWAYS
TRAINING SPECIAL PROVISIONS

This Training Special Provision supersedes subparagraph 7b of the Special Provision entitled "Specific Equal Employment Opportunity Responsibilities," (Attachment 1), and is in implementation of 23 U.S.C. 140(a).

As part of the contractor's equal employment opportunity affirmative action program training shall be provided as follows:

The contractor shall provide on-the-job training aimed at developing full journeymen in the type of trade or job classification involved.

The number of trainees to be trained under these special provisions and in this contract is shown in "Special Notes Applicable to Project" in the bid proposal.

In the event that a contractor subcontracts a portion of the contract work, he shall determine how many, if any, of the trainees are to be trained by the subcontractor, provided, however, that the contractor shall retain the primary responsibility for meeting the training requirements imposed by this special provision. The contractor shall also insure that this training special provision is made applicable to such subcontract. Where feasible, 25 percent of apprentices or trainees in each occupation shall be in their first year of apprenticeship or training.

The number of trainees shall be distributed among the work classifications on the basis of the contractor's needs and the availability of journeymen in the various classifications within a reasonable area of recruitment. Prior to commencing construction the contractor shall submit to the Kentucky Transportation Cabinet, Department of Highways for its approval, an acceptable training program on forms provided by the Cabinet indicating the number of trainees to be trained in each selected classification. Failure to provide the Cabinet with the proper documentation evidencing an acceptable training program prior to commencing construction shall cause the Cabinet to suspend the operations of the contractor with (if applicable) working days being charged as usual against the contract time or (if applicable), no additional contract time being granted for the suspension period. The Cabinet will not be liable for the payment of any work performed during the suspension period due to the failure of the contractor to provide an acceptable training program. Said suspension period shall be terminated when an acceptable training program is received by the Cabinet. Furthermore, the contractor shall specify the starting time for training in each of the classifications. The contractor will be credited for each trainee employed by him on the contract work who is currently enrolled or becomes enrolled in an approved program and will be reimbursed for such trainees as provided hereinafter.

Training and upgrading of minorities and women toward journeymen status is a primary objective of this Training Special Provision. Accordingly, the contractor shall make every effort to enroll minority trainees and women (e.g., by conducting systematic and direct recruitment through public and private sources likely to yield minority and women trainees) to the extent that such persons are available within a reasonable area of recruitment. The contractor will be responsible for demonstrating the steps that he has taken in pursuance thereof, prior to a determination as to whether the contractor is in compliance with this Training Special Provision. This training commitment is not intended, and shall not be used, to discriminate against any applicant for training, whether a member of a minority group or not.

No employee shall be employed as a trainee in any classification in which he has successfully completed a training course leading to journeyman status or in which he has been employed as a journeyman. The contractor should satisfy this requirement by including appropriate questions in the employee application or by other suitable means. Regardless of the method used the contractor's records should document the findings in each case. The minimum length and type of training for each classification will be as established in the training program selected by the contractor and approved by the Kentucky Transportation Cabinet, Department of Highways and the Federal Highway Administration shall approve a program if it is reasonably calculated to meet the equal employment opportunity obligations of the contractor and to qualify the average trainee for journeyman status in the classification concerned by the end of the training period. Furthermore, apprenticeship programs

registered with the U.S. Department of Labor, Bureau of Apprenticeship and Training, or with a State apprenticeship agency recognized by the Bureau and training programs approved but not necessarily sponsored by the U.S. Department of Labor, Manpower Administration, Bureau of Apprenticeship and Training shall also be considered acceptable provided it is being administered in a manner consistent with the equal employment obligations of Federal-aid highway construction contracts. Approval or acceptance of a training program shall be obtained from the State prior to commencing work on the classification covered by the program. It is the intention of these provisions that training is to be provided in the construction crafts rather than clerk-typists or secretarial-type positions. Training is permissible in lower level management positions such as office engineers, estimators, timekeepers, etc., where the training is oriented toward construction applications. Training in the laborer classification may be permitted provided that significant and meaningful training is provided and approved by the division office. Some offsite training is permissible as long as the training is an integral part of an approved training program and does not comprise a significant part of the overall training.

Except as otherwise noted below, the contractor will be reimbursed for each hour of training given an employee on this contract in accordance with an approved training program. As approved by the engineer, reimbursement will be made for training persons in excess of the number specified herein. This reimbursement will be made even though the contractor receives additional training program funds from other sources, provided such other source does not specifically prohibit the contractor from receiving other reimbursement. Reimbursement for offsite training indicated above may only be made to the contractor where he does one or more of the following and the trainees are concurrently employed on a Federal-aid project; contributes to the cost of the training, provides the instruction to the trainee or pays the trainee's wages during the offsite training period.

No payment shall be made to the contractor if either the failure to provide the required training, or the failure to hire the trainee as a journeyman, is caused by the contractor and evidences a lack of good faith on the part of the contractor in meeting the requirements of this Training Special Provision. It is normally expected that a trainee will begin his training on the project as soon as feasible after start of work utilizing the skill involved and remain on the project as long as training opportunities exist in his work classification or until he has completed his training program. It is not required that all trainees be on board for the entire length of the contract. A contractor will have fulfilled his responsibilities under this Training Special Provision if he has provided acceptable training to the number of trainees specified. The number trained shall be determined on the basis of the total number enrolled on the contract for a significant period.

Trainees will be paid at least 60 percent of the appropriate minimum journeyman's rate specified in the contract for the first half of the training period, 75 percent for the third quarter of the training period, and 90 percent for the last quarter of the training period, unless apprentices or trainees in an approved existing program are enrolled as trainees on this project. In that case, the appropriate rates approved by the Departments of Labor or Transportation in connection with the existing program shall apply to all trainees being trained for the same classification who are covered by this Training Special Provision.

The contractor shall furnish the trainee a copy of the program he will follow in providing the training. The contractor shall provide each trainee with a certification showing the type and length of training satisfactorily completed.

The contractor will provide for the maintenance of records and furnish periodic reports documenting his performance under this Training Special Provision.

"General Decision Number: KY20200040 01/31/2020

Superseded General Decision Number: KY20190040

State: Kentucky

Construction Type: Highway

Counties: Allen, Ballard, Butler, Caldwell, Calloway, Carlisle, Christian, Crittenden, Daviess, Edmonson, Fulton, Graves, Hancock, Henderson, Hickman, Hopkins, Livingston, Logan, Lyon, Marshall, McCracken, McLean, Muhlenberg, Ohio, Simpson, Todd, Trigg, Union, Warren and Webster Counties in Kentucky.

HIGHWAY CONSTRUCTION PROJECTS (excluding tunnels, building structures in rest area projects & railroad construction; bascule, suspension & spandrel arch bridges designed for commercial navigation, bridges involving marine construction; and other major bridges).

Note: Under Executive Order (EO) 13658, an hourly minimum wage of \$10.80 for calendar year 2020 applies to all contracts subject to the Davis-Bacon Act for which the contract is awarded (and any solicitation was issued) on or after January 1, 2015. If this contract is covered by the EO, the contractor must pay all workers in any classification listed on this wage determination at least \$10.80 per hour (or the applicable wage rate listed on this wage determination, if it is higher) for all hours spent performing on the contract in calendar year 2020. If this contract is covered by the EO and a classification considered necessary for performance of work on the contract does not appear on this wage determination, the contractor must pay workers in that classification at least the wage rate determined through the conformance process set forth in 29 CFR 5.5(a)(1)(ii) (or the EO minimum wage rate, if it is higher than the conformed wage rate). The EO minimum wage rate will be adjusted annually. Please note that this EO applies to the above-mentioned types of contracts entered into by the federal government that are subject to the Davis-Bacon Act itself, but it does not apply to contracts subject only to the Davis-Bacon Related Acts, including those set forth at 29 CFR 5.1(a)(2)-(60). Additional information on contractor requirements and worker protections under the EO is available at www.dol.gov/whd/govcontracts.

Modification Number	Publication Date
0	01/03/2020
1	01/10/2020
2	01/31/2020

BRIN0004-002 06/01/2017

BALLARD, BUTLER, CALDWELL, CARLISLE, CRITTENDEN, DAVIESS, EDMONSON, FULTON, GRAVES, HANCOCK, HENDERSON, HICKMAN, HOPKINS, LIVINGSTON, LYON, MARSHALL, MCCRACKEN, MCLEAN, MUHLENBERG, OHIO, UNION, and WEBSTER COUNTIES

Rates Fringes

BRICKLAYER

Ballard, Caldwell, Carlisle, Crittenden, Fulton, Graves, Hickman, Livingston, Lyon, Marshall, and McCracken Counties.....	\$ 30.50	15.16
Butler, Edmonson, Hopkins, Muhlenberg, and Ohio Counties.....	\$ 26.80	12.38
Daviess, Hancock, Henderson, McLean, Union, and Webster Counties.....	\$ 30.00	15.16

 BRTN0004-005 06/01/2017

ALLEN, CALLOWAY, CHRISTIAN, LOGAN, SIMPSON, TODD, TRIGG, and
 WARREN COUNTIES

	Rates	Fringes
BRICKLAYER.....	\$ 26.80	12.38

 CARP0357-002 04/01/2019

	Rates	Fringes
CARPENTER.....	\$ 29.25	19.23
Diver.....	\$ 44.25	19.23
PILEDRIVERMAN.....	\$ 29.50	19.23

 ELEC0369-006 05/28/2019

BUTLER, EDMONSON, LOGAN, TODD & WARREN COUNTIES:

	Rates	Fringes
ELECTRICIAN.....	\$ 32.44	17.22

 * ELEC0429-001 01/01/2020

ALLEN & SIMPSON COUNTIES:

	Rates	Fringes
ELECTRICIAN.....	\$ 27.72	13.48

 ELEC0816-002 01/01/2020

BALLARD, CALDWELL, CALLOWAY, CARLISLE, CHRISTIAN, CRITTENDEN,
 FULTON (Except a 5 mile radius of City Hall in Fulton), GRAVES,
 HICKMAN, LIVINGSTON, LYON, MARSHALL, MCCRACKEN & TRIGG COUNTIES:

	Rates	Fringes
ELECTRICIAN.....	\$ 33.58	25.5%+7.25

Cable spicers receive \$.25 per hour additional.

 ELEC1701-003 06/01/2018

DAVISS, HANCOCK, HENDERSON, HOPKINS, MCLEAN, MUHLENBERG, OHIO,
 UNION & WEBSTER COUNTIES:

	Rates	Fringes
ELECTRICIAN.....	\$ 31.04	15.74

Cable spicers receive \$.25 per hour additional.

 ELEC1925-002 01/01/2019

FULTON COUNTY (Up to a 5 mile radius of City Hall in Fulton):

	Rates	Fringes
CABLE SPLICER.....	\$ 25.80	12.16
ELECTRICIAN.....	\$ 25.20	13.74

 ENGI0181-017 07/01/2019

	Rates	Fringes
POWER EQUIPMENT OPERATOR		
GROUP 1.....	\$ 33.30	16.50
GROUP 2.....	\$ 30.44	16.50
GROUP 3.....	\$ 30.89	16.50
GROUP 4.....	\$ 30.12	16.50

OPERATING ENGINEER CLASSIFICATIONS

GROUP 1 - A-Frame Winch Truck; Auto Patrol; Backfiller; Batcher Plant; Bituminous Paver; Bituminous Transfer Machine; Boom Cat; Bulldozer; Mechanic; Cableway; Carry-All Scoop; Carry Deck Crane; Central Compressor Plant; Cherry Picker; Clamshell; Concrete Mixer (21 cu. ft. or Over); Concrete Paver; Truck-Mounted Concrete Pump; Core Drill; Crane; Crusher Plant; Derrick; Derrick Boat; Ditching & Trenching Machine; Dragline; Dredge Operator; Dredge Engineer; Elevating Grader & Loaders; Grade-All; Gurries; Heavy Equipment Robotics Operator/Mechanic; High Lift; Hoe-Type Machine; Hoist (Two or More Drums); Hoisting Engine (Two or More Drums); Horizontal Directional Drill Operator; Hydrocrane; Hyster; KeCal Loader; LeTourneau; Locomotive; Mechanic; Mechanically Operated Laser Screed; Mechanic Welder; Mucking Machine; Motor Scraper; Orangepeel Bucket; Overhead Crane; Piledriver; Power Blade; Pumpcrete; Push Dozer; Rock Spreader, attached to equipment; Rotary Drill; Roller (Bituminous); Rough Terrain Crane; Scarifier; Scoopmobile; Shovel; Side Boom; Subgrader; Tailboom; Telescoping Type Forklift; Tow or Push Boat; Tower Crane (French, German & other types); Tractor Shovel; Truck Crane; Tunnel Mining Machines, including Moles, Shields or similar types of Tunnel Mining Equipment

GROUP 2 - Air Compressor (Over 900 cu. ft. per min.); Bituminous Mixer; Boom Type Tamping Machine; Bull Float; Concrete Mixer (Under 21 cu. ft.); Dredge Engineer; Electric Vibrator; Compactor/Self-Propelled Compactor; Elevator (One Drum or Buck Hoist); Elevator (When used to Hoist Building Material); Finish Machine; Firemen & Hoist (One Drum); Flexplane; Forklift (Regardless of Lift Height); Form Grader; Joint Sealing Machine; Outboard Motor Boat; Power Sweeper (Riding Type); Roller (Rock); Ross Carrier; Skid Mounted or Trailer Mounted Concrete Pump; Skid Steer Machine with all Attachments; Switchman or Brakeman;

Throttle Valve Person; Tractair & Road Widening Trencher;
 Tractor (50 H.P. or Over); Truck Crane Oiler; Tugger;
 Welding Machine; Well Points;& Whirley Oiler

GROUP 3 -All Off Road Material Handling Equipment, including
 Articulating Dump Trucks; Greaser on Grease Facilities
 servicing Heavy Equipment

GROUP 4 - Bituminous Distributor; Burlap & Curing Machine;
 Cement Gun; Concrete Saw; Conveyor; Deckhand Oiler; Grout
 Pump; Hydraulic Post Driver; Hydro Seeder; Mud Jack; Oiler;
 Paving Joint Machine; Power Form Handling Equipment; Pump;
 Roller (Earth); Steerman; Tamping Machine; Tractor (Under
 50 H.P.); & Vibrator

CRANES - with booms 150 ft. & Over (Including JIB), and where
 the length of the boom in combination with the length of
 the piling equals or exceeds 150 ft. - \$1.00 above Group 1
 rate

EMPLOYEES ASSIGNED TO WORK BELOW GROUND LEVEL ARE TO BE PAID
 10% ABOVE BASIC WAGE RATE. THIS DOES NOT APPLY TO OPEN CUT
 WORK.

 IRON0070-005 06/01/2019

BUTLER COUNTY (Eastern eighth, including the Townships of
 Decker, Lee & Tilford);
 EDMONSON COUNTY (Northern three-fourths, including the
 Townships of Asphalt, Bee Spring, Brownsville, Grassland, Huff,
 Kyrock, Lindseyville, Mammoth Cave, Ollie, Prosperity, Rhoda,
 Sunfish & Sweden)

Rates Fringes

IRONWORKER

Structural; Ornamental;		
Reinforcing; Precast		
Concrete Erectors.....	\$ 29.68	22.75

 IRON0103-004 08/01/2018

DAVISS, HANCOCK, HENDERSON, HOPKINS, MCLEAN, OHIO, UNION &
 WEBSTER COUNTIES
 BUTLER COUNTY (Townships of Aberdeen, Bancock, Casey,
 Dexterville, Dunbar, Elfie, Gilstrap, Huntsville, Logansport,
 Monford, Morgantown, Provo, Rochester, South Hill & Welchs
 Creek);
 CALDWELL COUNTY (Northeastern third, including the Township of
 Creswell);
 CHRISTIAN COUNTY (Northern third, including the Townships of
 Apex, Crofton, Kelly, Mannington & Wynns);
 CRITTENDEN COUNTY (Northeastern half, including the Townships
 of Grove, Mattoon, Repton, Shady Grove & Tribune);
 MUHLENBERG COUNTY (Townships of Bavier, Beech Creek Junction,
 Benton, Brennen, Browder, Central City, Cleaton, Depoy,
 Drakesboro, Eunis, Graham, Hillside, Luzerne, Lynn City,
 Martwick, McNary, Millport, Moorman, Nelson, Paradise,
 Powderly, South Carrollton, Tarina & Weir)

Rates Fringes

Ironworkers:.....\$ 28.66 22.435

 IRON0492-003 05/01/2018

ALLEN, LOGAN, SIMPSON, TODD & WARREN COUNTIES
 BUTLER COUNTY (Southern third, including the Townships of
 Boston, Berrys Lick, Dimple, Jetson, Quality, Sharer, Sugar
 Grove & Woodbury);
 CHRISTIAN COUNTY (Eastern two-thirds, including the Townships
 of Bennettstown, Casky, Herndon, Hopkinsville, Howell,
 Masonville, Pembroke & Thompsonville);
 EDMONSON COUNTY (Southern fourth, including the Townships of
 Chalybeate & Rocky Hill);
 MUHLENBERG COUNTY (Southern eighth, including the Townships of
 Dunnior, Penrod & Rosewood)

Rates Fringes

Ironworkers:.....\$ 26.11 14.02

 IRON0782-006 05/01/2018

BALLARD, CALLOWAY, CARLISLE, FULTON, GRAVES, HICKMAN,
 LIVINGSTON, LYON, MARSHALL, MCCRACKEN & TRIGG COUNTIES
 CALDWELL COUNTY (Southwestern two-thirds, including the
 Townships of Cedar Bluff, Cider, Claxton, Cobb, Crowtown,
 Dulaney, Farmersville, Fredonia, McGowan, Otter Pond &
 Princeton);
 CHRISTIAN COUNTY (Western third, Excluding the Townships of
 Apex, Crofton, Kelly, Mannington, Wynns, Bennettstown, Casky,
 Herndon, Hopkinsville, Howell, Masonville, Pembroke &
 Thompsonville);
 CRITTENDEN COUNTY (Southwestern half, including the Townships
 of Crayne, Dycusburg, Frances, Marion, Mexico, Midway,
 Sheridan & Told)

Rates Fringes

Ironworkers:
 Projects with a total
 contract cost of
 \$20,000,000.00 or above.....\$ 28.79 24.17
 All Other Work.....\$ 27.20 22.75

 LABO0189-005 07/01/2018

BALLARD, CALLOWAY, CARLISLE, FULTON, GRAVES, HICKMAN,
 LIVINGSTON, LYON, MARSHALL & MCCRACKEN COUNTIES

Rates Fringes

Laborers:
 GROUP 1.....\$ 23.07 14.21
 GROUP 2.....\$ 23.32 14.21
 GROUP 3.....\$ 23.37 14.21
 GROUP 4.....\$ 23.97 14.21

LABORER CLASSIFICATIONS

GROUP 1 - Aging & Curing of Concrete; Asbestos Abatement

Worker; Asphalt Plant; Asphalt; Batch Truck Dump; Carpenter
Tender; Cement Mason Tender; Cleaning of Machines;
Concrete; Demolition; Dredging; Environmental - Nuclear,
Radiation, Toxic & Hazardous Waste - Level D; Flagperson;
Grade Checker; Hand Digging & Hand Back Filling; Highway
Marker Placer; Landscaping, Mesh Handler & Placer; Puddler;
Railroad; Rip-rap & Grouter; Right-of-Way; Sign, Guard Rail
& Fence Installer; Signal Person; Sound Barrier Installer;
Storm & Sanitary Sewer; Swamper; Truck Spotter & Dumper;
Wrecking of Concrete Forms; General Cleanup

GROUP 2 - Batter Board Man (Sanitary & Storm Sewer);
Brickmason Tender; Mortar Mixer Operator; Scaffold Builder;
Burner & Welder; Bushhammer; Chain Saw Operator; Concrete
Saw Operator; Deckhand Scow Man; Dry Cement Handler;
Environmental - Nuclear, Radiation, Toxic & Hazardous Waste
- Level C; Forklift Operator for Masonary; Form Setter;
Green Concrete Cutting; Hand Operated Grouter & Grinder
Machine Operator; Jackhammer; Pavement Breaker; Paving
Joint Machine; Pipelayer; Plastic Pipe Fusion; Power Driven
Georgia Buggy & Wheel Barrow; Power Post Hole Digger;
Precast Manhole Setter; Walk-Behind Tamper; Walk-Behind
Trencher; Sand Blaster; Concrete Chipper; Surface
Grinder; Vibrator Operator; Wagon Driller

GROUP 3 - Asphalt Luteman & Raker; Gunnite Nozzleman; Gunnite
Operator & Mixer; Grout Pump Operator; Blaster; Side Rail
Setter; Rail Paved Ditches; Screw Operator; Tunnel (Free
Air); Water Blaster

GROUP 4 - Caisson Worker (Free Air); Cement Finisher;
Environmental - Nuclear, Radiation, Toxic & Hazardous Waste
- Levels A & B; Miner & Driller (Free Air); Tunnel Blaster;
& Tunnel Mucker (Free Air); Directional & Horizontal
Boring; Air Track Drillers (All Types); Powdermen &
Blasters; Troxler & Concrete Tester if Laborer is Utilized

LABO0189-006 07/01/2018

ALLEN, BUTLER, CALDWELL, CHRISTIAN, DAVIESS, EDMONSON, HANCOCK,
HOPKINS, LOGAN, MCLEAN, MUHLENBERG, OHIO, SIMPSON, TODD, TRIGG
& WARREN COUNTIES

	Rates	Fringes
Laborers:		
GROUP 1.....	\$ 23.07	14.21
GROUP 2.....	\$ 23.32	14.21
GROUP 3.....	\$ 23.37	14.21
GROUP 4.....	\$ 23.97	14.21

LABORER CLASSIFICATIONS

GROUP 1 - Aging & Curing of Concrete; Asbestos Abatement
Worker; Asphalt Plant; Asphalt; Batch Truck Dump; Carpenter
Tender; Cement Mason Tender; Cleaning of Machines;
Concrete; Demolition; Dredging; Environmental - Nuclear,
Radiation, Toxic & Hazardous Waste - Level D; Flagperson;
Grade Checker; Hand Digging & Hand Back Filling; Highway
Marker Placer; Landscaping, Mesh Handler & Placer; Puddler;
Railroad; Rip-rap & Grouter; Right-of-Way; Sign, Guard Rail
& Fence Installer; Signal Person; Sound Barrier Installer;

Storm & Sanitary Sewer; Swamper; Truck Spotter & Dumper;
Wrecking of Concrete Forms; General Cleanup

GROUP 2 - Batter Board Man (Sanitary & Storm Sewer);
Brickmason Tender; Mortar Mixer Operator; Scaffold Builder;
Burner & Welder; Bushhammer; Chain Saw Operator; Concrete
Saw Operator; Deckhand Scow Man; Dry Cement Handler;
Environmental - Nuclear, Radiation, Toxic & Hazardous Waste
- Level C; Forklift Operator for Masonary; Form Setter;
Green Concrete Cutting; Hand Operated Grouter & Grinder
Machine Operator; Jackhammer; Pavement Breaker; Paving
Joint Machine; Pipelayer; Plastic Pipe Fusion; Power Driven
Georgia Buggy & Wheel Barrow; Power Post Hole Digger;
Precast Manhole Setter; Walk-Behind Tamper; Walk-Behind
Trencher; Sand Blaster; Concrete Chipper; Surface
Grinder; Vibrator Operator; Wagon Driller

GROUP 3 - Asphalt Luteman & Raker; Gunnite Nozzleman; Gunnite
Operator & Mixer; Grout Pump Operator; Blaster; Side Rail
Setter; Rail Paved Ditches; Screw Operator; Tunnel (Free
Air); Water Blaster

GROUP 4 - Caisson Worker (Free Air); Cement Finisher;
Environmental - Nuclear, Radiation, Toxic & Hazardous Waste
- Levels A & B; Miner & Driller (Free Air); Tunnel Blaster;
& Tunnel Mucker (Free Air); Directional & Horizontal
Boring; Air Track Drillers (All Types); Powdermen &
Blasters; Troxler & Concrete Tester if Laborer is Utilized

LABO0561-001 07/01/2018

CRITTENDEN, HENDERSON, UNION & WEBSTER COUNTIES

	Rates	Fringes
Laborers:		
GROUP 1.....	\$ 22.71	15.00
GROUP 2.....	\$ 22.96	15.00
GROUP 3.....	\$ 23.01	15.00
GROUP 4.....	\$ 23.61	15.00

LABORER CLASSIFICATIONS

GROUP 1 - Aging & Curing of Concrete; Asbestos Abatement
Worker; Asphalt Plant; Asphalt; Batch Truck Dump; Carpenter
Tender; Cement Mason Tender; Cleaning of Machines;
Concrete; Demolition; Dredging; Environmental - Nuclear,
Radiation, Toxic & Hazardous Waste - Level D; Flagperson;
Grade Checker; Hand Digging & Hand Back Filling; Highway
Marker Placer; Landscaping, Mesh Handler & Placer; Puddler;
Railroad; Rip-rap & Grouter; Right-of-Way; Sign, Guard Rail
& Fence Installer; Signal Person; Sound Barrier Installer;
Storm & Sanitary Sewer; Swamper; Truck Spotter & Dumper;
Wrecking of Concrete Forms; General Cleanup

GROUP 2 - Batter Board Man (Sanitary & Storm Sewer);
Brickmason Tender; Mortar Mixer Operator; Scaffold Builder;
Burner & Welder; Bushhammer; Chain Saw Operator; Concrete
Saw Operator; Deckhand Scow Man; Dry Cement Handler;
Environmental - Nuclear, Radiation, Toxic & Hazardous Waste
- Level C; Forklift Operator for Masonary; Form Setter;
Green Concrete Cutting; Hand Operated Grouter & Grinder
Machine Operator; Jackhammer; Pavement Breaker; Paving

Joint Machine; Pipelayer; Plastic Pipe Fusion; Power Driven Georgia Buggy & Wheel Barrow; Power Post Hole Digger; Precast Manhole Setter; Walk-Behind Tamper; Walk-Behind Trencher; Sand Blaster; Concrete Chipper; Surface Grinder; Vibrator Operator; Wagon Driller

GROUP 3 - Asphalt Luteman & Raker; Gunnite Nozzleman; Gunnite Operator & Mixer; Grout Pump Operator; Blaster; Side Rail Setter; Rail Paved Ditches; Screw Operator; Tunnel (Free Air); Water Blaster

GROUP 4 - Caisson Worker (Free Air); Cement Finisher; Environmental - Nuclear, Radiation, Toxic & Hazardous Waste - Levels A & B; Miner & Driller (Free Air); Tunnel Blaster; & Tunnel Mucker (Free Air); Directional & Horizontal Boring; Air Track Drillers (All Types); Powdermen & Blasters; Troxler & Concrete Tester if Laborer is Utilized

 PAIN0032-002 09/01/2018

BALLARD COUNTY

	Rates	Fringes
Painters:		
Bridges.....	\$ 33.56	16.13
All Other Work.....	\$ 31.86	16.13

Spray, Blast, Steam, High & Hazardous (Including Lead Abatement) and All Epoxy - \$1.00 Premium

 PAIN0118-003 06/01/2014

EDMONSON COUNTY:

	Rates	Fringes
Painters:		
Brush & Roller.....	\$ 18.50	11.97
Spray, Sandblast, Power Tools, Waterblast & Steam Cleaning.....	\$ 19.50	11.97

 PAIN0156-006 04/01/2015

DAVIESS, HANCOCK, HENDERSON, MCLEAN, OHIO, UNION & WEBSTER COUNTIES

	Rates	Fringes
Painters:		
BRIDGES		
GROUP 1.....	\$ 27.60	12.85
GROUP 2.....	\$ 27.85	12.85
GROUP 3.....	\$ 28.60	12.85
GROUP 4.....	\$ 29.60	12.85
ALL OTHER WORK:		
GROUP 1.....	\$ 26.45	12.85
GROUP 2.....	\$ 26.70	12.85
GROUP 3.....	\$ 27.45	12.85
GROUP 4.....	\$ 28.45	12.85

PAINTER CLASSIFICATIONS

GROUP 1 - Brush & Roller

GROUP 2 - Plasterers

GROUP 3 - Spray; Sandblast; Power Tools; Waterblast;
 Steamcleaning; Brush & Roller of Mastics, Creosotes, Kwinch
 Koate & Coal Tar Epoxy

GROUP 4 - Spray of Mastics, Creosotes, Kwinch Koate & Coal
 Tar Epoxy

 PAIN0500-002 06/01/2018

CALDWELL, CALLOWAY, CARLISLE, CHRISTIAN, CRITTENDEN, FULTON,
 GRAVES, HICKMAN, HOPKINS, LIVINGSTON, LYON, MARSHALL, MCCRACKEN
 & TRIGG COUNTIES:

	Rates	Fringes
Painters:		
Bridges.....	\$ 27.75	13.60
All Other Work.....	\$ 21.50	13.60

Waterblasting units with 3500 PSI and above - \$.50 premium
 Spraypainting and all abrasive blasting - \$1.00 premium
 Work 40 ft. and above ground level - \$1.00 premium

 PLUM0184-002 07/01/2018

BALLARD, CALDWELL, CALLOWAY, CARLISLE, CHRISTIAN, CRITTENDEN,
 FULTON, GRAVES, HICKMAN, LIVINGSTON, LYON, MARSHALL, MCCRACKEN
 and TRIGG COUNTIES

	Rates	Fringes
Plumber; Steamfitter.....	\$ 35.06	18.18

 PLUM0502-004 08/01/2019

ALLEN, BUTLER, EDMONSON, SIMPSON & WARREN

	Rates	Fringes
Plumber; Steamfitter.....	\$ 35.77	20.78

 PLUM0633-002 07/01/2017

DAVISS, HANCOCK, HENDERSON, HOPKINS, LOGAN, MCLEAN,
 MUHLENBERG, OHIO, TODD, UNION & WEBSTER COUNTIES:

	Rates	Fringes
PLUMBER/PIPEFITTER.....	\$ 31.47	16.80

 TEAM0089-003 04/01/2019

ALLEN, BUTLER, EDMONSON, LOGAN, SIMPSON & WARREN COUNTIES

	Rates	Fringes
Truck drivers:		
Zone 1:		
Group 1.....	\$ 20.82	21.96
Group 2.....	\$ 21.00	21.96
Group 3.....	\$ 21.08	21.96
Group 4.....	\$ 21.10	21.96

GROUP 1 - Greaser; Tire Changer

GROUP 2 - Truck Mechanic; Single Axle Dump; Flat Bed; All Terrain Vehicles when used to haul materials; Semi Trailer or Pole Trailer when used to pull building materials and equipment; Tandem Axle Dump; Driver of Distributors

GROUP 3 - Mixer All Types

GROUP 4 - Winch and A-Frame when used in transporting materials; Ross Carrier; Fork Lift when used to transport building materials; Driver on Pavement Breaker; Euclid and Other Heavy Earth Moving Equipment; Low Boy; Articulator Cat; Five Axle Vehicle

TEAM0215-003 04/01/2019

DAVIESS, HANCOCK, HENDERSON, HOPKINS, MCLEAN, MUHLENBERG, OHIO & WEBSTER COUNTIES

	Rates	Fringes
TRUCK DRIVER		
Group 1.....	\$ 22.45	21.96
Group 2.....	\$ 22.68	21.96
Group 3.....	\$ 22.75	21.96
Group 4.....	\$ 22.76	21.96

GROUP 1: Greaser, Tire Changer

GROUP 2: Truck Mechanic

GROUP 3: Single Axle Dump; Flat Bed; All Terrain Vehicle when used to haul materials; Semi Trailer or Pole Trailer when used to pull building materials and equipment; Tandem Axle Dump; Driver of Distributors; Mixer All Types

GROUP 4: Euclid and other heavy earth moving equipment; Low Boy; Articulator Cat; 5 Axle Vehicle; Winch and A- Frame when used in transporting materials; Ross Carrier; Fork Lift when used to transport building materials; Driver on Pavement Breaker

TEAM0236-001 04/01/2019

BALLARD, CALDWELL, CALLOWAY, CARLISLE, CHRISTIAN, CRITTENDEN, FULTON, GRAVES, HICKMAN, LIVINGSTON, LYON, MARSHALL, MCCRACKEN, TODD & TRIGG COUNTIES

	Rates	Fringes
TRUCK DRIVER		
Group 1.....	\$ 20.82	21.96
Group 2.....	\$ 21.00	21.96
Group 3.....	\$ 21.00	21.96
Group 4.....	\$ 20.10	21.96
Group 5.....	\$ 21.08	21.96

GROUP 1: Greaser, Tire Changer

GROUP 2: Truck Mechanic

GROUP 3: Single Axle Dump; Flat Bed; All Terrain Vehicle when used to haul materials; Semi Trailer or Pole Trailer when used to pull building materials and equipment; Tandem Axle Dump; Drivers of Distributors

GROUP 4: Euclid and other heavy earth moving equipment; Low Boy; Articulator Cat; Five Axle Vehicle; Winch and A-Frame when used in transporting materials; Ross Carrier

GROUP 5: Mixer All Types

WELDERS - Receive rate prescribed for craft performing operation to which welding is incidental.

=====

Note: Executive Order (EO) 13706, Establishing Paid Sick Leave for Federal Contractors applies to all contracts subject to the Davis-Bacon Act for which the contract is awarded (and any solicitation was issued) on or after January 1, 2017. If this contract is covered by the EO, the contractor must provide employees with 1 hour of paid sick leave for every 30 hours they work, up to 56 hours of paid sick leave each year. Employees must be permitted to use paid sick leave for their own illness, injury or other health-related needs, including preventive care; to assist a family member (or person who is like family to the employee) who is ill, injured, or has other health-related needs, including preventive care; or for reasons resulting from, or to assist a family member (or person who is like family to the employee) who is a victim of, domestic violence, sexual assault, or stalking. Additional information on contractor requirements and worker protections under the EO is available at www.dol.gov/whd/govcontracts.

Unlisted classifications needed for work not included within the scope of the classifications listed may be added after award only as provided in the labor standards contract clauses (29CFR 5.5 (a) (1) (ii)).

The body of each wage determination lists the classification and wage rates that have been found to be prevailing for the cited type(s) of construction in the area covered by the wage determination. The classifications are listed in alphabetical order of ""identifiers"" that indicate whether the particular rate is a union rate (current union negotiated rate for local),

a survey rate (weighted average rate) or a union average rate (weighted union average rate).

Union Rate Identifiers

A four letter classification abbreviation identifier enclosed in dotted lines beginning with characters other than ""SU"" or ""UAVG"" denotes that the union classification and rate were prevailing for that classification in the survey. Example: PLUM0198-005 07/01/2014. PLUM is an abbreviation identifier of the union which prevailed in the survey for this classification, which in this example would be Plumbers. 0198 indicates the local union number or district council number where applicable, i.e., Plumbers Local 0198. The next number, 005 in the example, is an internal number used in processing the wage determination. 07/01/2014 is the effective date of the most current negotiated rate, which in this example is July 1, 2014.

Union prevailing wage rates are updated to reflect all rate changes in the collective bargaining agreement (CBA) governing this classification and rate.

Survey Rate Identifiers

Classifications listed under the ""SU"" identifier indicate that no one rate prevailed for this classification in the survey and the published rate is derived by computing a weighted average rate based on all the rates reported in the survey for that classification. As this weighted average rate includes all rates reported in the survey, it may include both union and non-union rates. Example: SULA2012-007 5/13/2014. SU indicates the rates are survey rates based on a weighted average calculation of rates and are not majority rates. LA indicates the State of Louisiana. 2012 is the year of survey on which these classifications and rates are based. The next number, 007 in the example, is an internal number used in producing the wage determination. 5/13/2014 indicates the survey completion date for the classifications and rates under that identifier.

Survey wage rates are not updated and remain in effect until a new survey is conducted.

Union Average Rate Identifiers

Classification(s) listed under the UAVG identifier indicate that no single majority rate prevailed for those classifications; however, 100% of the data reported for the classifications was union data. EXAMPLE: UAVG-OH-0010 08/29/2014. UAVG indicates that the rate is a weighted union average rate. OH indicates the state. The next number, 0010 in the example, is an internal number used in producing the wage determination. 08/29/2014 indicates the survey completion date for the classifications and rates under that identifier.

A UAVG rate will be updated once a year, usually in January of each year, to reflect a weighted average of the current negotiated/CBA rate of the union locals from which the rate is based.

WAGE DETERMINATION APPEALS PROCESS

1.) Has there been an initial decision in the matter? This can be:

- * an existing published wage determination
- * a survey underlying a wage determination
- * a Wage and Hour Division letter setting forth a position on a wage determination matter
- * a conformance (additional classification and rate) ruling

On survey related matters, initial contact, including requests for summaries of surveys, should be with the Wage and Hour Regional Office for the area in which the survey was conducted because those Regional Offices have responsibility for the Davis-Bacon survey program. If the response from this initial contact is not satisfactory, then the process described in 2.) and 3.) should be followed.

With regard to any other matter not yet ripe for the formal process described here, initial contact should be with the Branch of Construction Wage Determinations. Write to:

Branch of Construction Wage Determinations
 Wage and Hour Division
 U.S. Department of Labor
 200 Constitution Avenue, N.W.
 Washington, DC 20210

2.) If the answer to the question in 1.) is yes, then an interested party (those affected by the action) can request review and reconsideration from the Wage and Hour Administrator (See 29 CFR Part 1.8 and 29 CFR Part 7). Write to:

Wage and Hour Administrator
 U.S. Department of Labor
 200 Constitution Avenue, N.W.
 Washington, DC 20210

The request should be accompanied by a full statement of the interested party's position and by any information (wage payment data, project description, area practice material, etc.) that the requestor considers relevant to the issue.

3.) If the decision of the Administrator is not favorable, an interested party may appeal directly to the Administrative Review Board (formerly the Wage Appeals Board). Write to:

Administrative Review Board
 U.S. Department of Labor
 200 Constitution Avenue, N.W.
 Washington, DC 20210

4.) All decisions by the Administrative Review Board are final.

=====
 END OF GENERAL DECISION"

Fringe benefit amounts are applicable for all hours worked except when otherwise noted.

No laborer, workman or mechanic shall be paid at a rate less than that of a Journeyman except those classified as bona fide apprentices.

Apprentices or trainees shall be permitted to work as such subject to Administrative Regulations adopted by the Commissioner of Workplace Standards. Copies of these regulations will be furnished upon request from any interested person.

Before using apprentices on the job the contractor shall present to the Contracting Officer written evidence of registration of such employees in a program of a State apprenticeship and training agency approved and recognized by the U. S. Bureau of Apprenticeship and Training. In the absence of such a State agency, the contractor shall submit evidence of approval and registration by the U. S. Bureau of Apprenticeship and Training.

The contractor shall submit to the Contracting Officer, written evidence of the established apprenticeship-journeyman ratios and wage rates in the project area, which will be the basis for establishing such ratios and rates for the project under the applicable contract provisions.

TO: EMPLOYERS/EMPLOYEES

PREVAILING WAGE SCHEDULE:

The wages indicated on this wage schedule are the least permitted to be paid for the occupations indicated. When an employee works in more than one classification, the employer must record the number of hours worked in each classification at the prescribed hourly base rate.

OVERTIME:

Overtime is to be paid to an employee at a rate not less than one and one-half times the basic rate of pay for all hours worked in excess of forty (40) hours in such workweek. Wage violations or questions should be directed to the designated Engineer or the undersigned.

Director
Division of Construction Procurement
Frankfort, Kentucky 40622
502-564-3500

"General Decision Number: KY20200061 01/03/2020

Superseded General Decision Number: KY20190061

State: Kentucky

Construction Type: Heavy

Counties: Breckinridge, Caldwell, Carlisle, Crittenden, Fulton, Grayson, Hickman, Hopkins, Livingston, Muhlenberg, Ohio and Todd Counties in Kentucky.

HEAVY CONSTRUCTION PROJECTS (including sewer/water construction).

Note: Under Executive Order (EO) 13658, an hourly minimum wage of \$10.80 for calendar year 2020 applies to all contracts subject to the Davis-Bacon Act for which the contract is awarded (and any solicitation was issued) on or after January 1, 2015. If this contract is covered by the EO, the contractor must pay all workers in any classification listed on this wage determination at least \$10.80 per hour (or the applicable wage rate listed on this wage determination, if it is higher) for all hours spent performing on the contract in calendar year 2020. If this contract is covered by the EO and a classification considered necessary for performance of work on the contract does not appear on this wage determination, the contractor must pay workers in that classification at least the wage rate determined through the conformance process set forth in 29 CFR 5.5(a)(1)(ii) (or the EO minimum wage rate, if it is higher than the conformed wage rate). The EO minimum wage rate will be adjusted annually. Please note that this EO applies to the above-mentioned types of contracts entered into by the federal government that are subject to the Davis-Bacon Act itself, but it does not apply to contracts subject only to the Davis-Bacon Related Acts, including those set forth at 29 CFR 5.1(a)(2)-(60). Additional information on contractor requirements and worker protections under the EO is available at www.dol.gov/whd/govcontracts.

Modification Number	Publication Date
0	01/03/2020

* ENGI0181-009 07/01/2019

	Rates	Fringes
POWER EQUIPMENT OPERATOR		
GROUP 1.....	\$ 33.30	16.50
GROUP 2.....	\$ 30.44	16.50
GROUP 3.....	\$ 30.89	16.50
GROUP 4.....	\$ 30.12	16.50

OPERATING ENGINEER CLASSIFICATIONS

GROUP 1 - Backhoe/Excavator/Trackhoe; Bulldozer; Crane; Drill; Grader/Blade; Loader; Mechanic; Scraper

GROUP 2 - Bobcat/Skid Steer/Skid Loader; Forklift; Tractor (50 H.P. or over)

GROUP 3 - Articulating Truck Operator

GROUP 4 - Oiler; Tractor (under 50 H.P.)

Operators on cranes with booms 150 feet and over (including jib) shall receive \$1.00 above Group 1 rate; 250 feet and over including jib shall receive \$1.50 above Class 1 rate. Combination Rate: All crane operators operating cranes, where the length of the boom in combination with the length of the piling leads equal or exceeds 150 feet, shall receive \$1.00 above the Group 1 rate.

Employees assigned to work below ground level are to be paid 10% above basic wage rate. This does not apply to open cut work.

IRON0782-010 05/01/2018		
	Rates	Fringes
IRONWORKER (Reinforcing & Structural)		
Projects over \$20,000,000.00.....	\$ 28.79	24.17
Projects under \$20,000,000.00.....	\$ 27.20	22.75

LABO0189-001 07/01/2018		
	Rates	Fringes
LABORER		
Concrete Saw (Hand Held/Walk Behind).....	\$ 23.32	14.21

LABO0561-003 07/01/2018		
	Rates	Fringes
LABORER		
Form Worker.....	\$ 22.71	15.00

LABO1214-001 07/01/2018		
	Rates	Fringes
LABORER		
Backfiller, Carpenter Tender, Common or General, Concrete Worker, Dumpman, Fence Erection.....	\$ 23.07	14.21
Pipelayer & Tamper (Hand Held/Walk Behind).....	\$ 23.32	14.21

* UAVG-KY-0001 01/01/2019		
	Rates	Fringes
LABORER: Grade Checker.....	\$ 23.78	13.63

SUKY2011-017 06/25/2014		

	Rates	Fringes
CEMENT MASON/CONCRETE FINISHER...	\$ 20.96	10.53
ELECTRICIAN.....	\$ 32.35	2.18
LABORER: Flagger.....	\$ 18.31	8.89
OPERATOR: Boring Machine.....	\$ 25.35	13.00

WELDERS - Receive rate prescribed for craft performing operation to which welding is incidental.
=====

Note: Executive Order (EO) 13706, Establishing Paid Sick Leave for Federal Contractors applies to all contracts subject to the Davis-Bacon Act for which the contract is awarded (and any solicitation was issued) on or after January 1, 2017. If this contract is covered by the EO, the contractor must provide employees with 1 hour of paid sick leave for every 30 hours they work, up to 56 hours of paid sick leave each year. Employees must be permitted to use paid sick leave for their own illness, injury or other health-related needs, including preventive care; to assist a family member (or person who is like family to the employee) who is ill, injured, or has other health-related needs, including preventive care; or for reasons resulting from, or to assist a family member (or person who is like family to the employee) who is a victim of, domestic violence, sexual assault, or stalking. Additional information on contractor requirements and worker protections under the EO is available at www.dol.gov/whd/govcontracts.

Unlisted classifications needed for work not included within the scope of the classifications listed may be added after award only as provided in the labor standards contract clauses (29CFR 5.5 (a) (1) (ii)).

The body of each wage determination lists the classification and wage rates that have been found to be prevailing for the cited type(s) of construction in the area covered by the wage determination. The classifications are listed in alphabetical order of ""identifiers"" that indicate whether the particular rate is a union rate (current union negotiated rate for local), a survey rate (weighted average rate) or a union average rate (weighted union average rate).

Union Rate Identifiers

A four letter classification abbreviation identifier enclosed in dotted lines beginning with characters other than ""SU"" or ""UAVG"" denotes that the union classification and rate were prevailing for that classification in the survey. Example: PLUM0198-005 07/01/2014. PLUM is an abbreviation identifier of the union which prevailed in the survey for this classification, which in this example would be Plumbers. 0198 indicates the local union number or district council number where applicable, i.e., Plumbers Local 0198. The next number, 005 in the example, is an internal number used in processing

the wage determination. 07/01/2014 is the effective date of the most current negotiated rate, which in this example is July 1, 2014.

Union prevailing wage rates are updated to reflect all rate changes in the collective bargaining agreement (CBA) governing this classification and rate.

Survey Rate Identifiers

Classifications listed under the ""SU"" identifier indicate that no one rate prevailed for this classification in the survey and the published rate is derived by computing a weighted average rate based on all the rates reported in the survey for that classification. As this weighted average rate includes all rates reported in the survey, it may include both union and non-union rates. Example: SULA2012-007 5/13/2014. SU indicates the rates are survey rates based on a weighted average calculation of rates and are not majority rates. LA indicates the State of Louisiana. 2012 is the year of survey on which these classifications and rates are based. The next number, 007 in the example, is an internal number used in producing the wage determination. 5/13/2014 indicates the survey completion date for the classifications and rates under that identifier.

Survey wage rates are not updated and remain in effect until a new survey is conducted.

Union Average Rate Identifiers

Classification(s) listed under the UAVG identifier indicate that no single majority rate prevailed for those classifications; however, 100% of the data reported for the classifications was union data. EXAMPLE: UAVG-OH-0010 08/29/2014. UAVG indicates that the rate is a weighted union average rate. OH indicates the state. The next number, 0010 in the example, is an internal number used in producing the wage determination. 08/29/2014 indicates the survey completion date for the classifications and rates under that identifier.

A UAVG rate will be updated once a year, usually in January of each year, to reflect a weighted average of the current negotiated/CBA rate of the union locals from which the rate is based.

WAGE DETERMINATION APPEALS PROCESS

1.) Has there been an initial decision in the matter? This can be:

- * an existing published wage determination
- * a survey underlying a wage determination
- * a Wage and Hour Division letter setting forth a position on a wage determination matter
- * a conformance (additional classification and rate) ruling

On survey related matters, initial contact, including requests for summaries of surveys, should be with the Wage and Hour Regional Office for the area in which the survey was conducted because those Regional Offices have responsibility for the

Davis-Bacon survey program. If the response from this initial contact is not satisfactory, then the process described in 2.) and 3.) should be followed.

With regard to any other matter not yet ripe for the formal process described here, initial contact should be with the Branch of Construction Wage Determinations. Write to:

Branch of Construction Wage Determinations
Wage and Hour Division
U.S. Department of Labor
200 Constitution Avenue, N.W.
Washington, DC 20210

2.) If the answer to the question in 1.) is yes, then an interested party (those affected by the action) can request review and reconsideration from the Wage and Hour Administrator (See 29 CFR Part 1.8 and 29 CFR Part 7). Write to:

Wage and Hour Administrator
U.S. Department of Labor
200 Constitution Avenue, N.W.
Washington, DC 20210

The request should be accompanied by a full statement of the interested party's position and by any information (wage payment data, project description, area practice material, etc.) that the requestor considers relevant to the issue.

3.) If the decision of the Administrator is not favorable, an interested party may appeal directly to the Administrative Review Board (formerly the Wage Appeals Board). Write to:

Administrative Review Board
U.S. Department of Labor
200 Constitution Avenue, N.W.
Washington, DC 20210

4.) All decisions by the Administrative Review Board are final.

=====

END OF GENERAL DECISION

"

**TRANSPORTATION CABINET
DIVISION OF CONSTRUCTION PROCUREMENT
PROJECT WAGE RATES**

LIVINGSTON COUNTY, STP BRO 0601 (196)

US60 Smithland Bridge over Cumberland River

Bridge with Grade, Drain and Surface

NOTICE:

There are two (2) sets of wage rates established for this project. The contractor shall use federal wage rate decision number KY20200061 when bridge work is performed on the US60 Smithland Bridge (070B00017N). Wage rate decision number KY20200040, shall apply for all other road work.

**NOTICE OF REQUIREMENT FOR AFFIRMATIVE ACTION
TO ENSURE EQUAL EMPLOYMENT OPPORTUNITY
(Executive Order 11246)**

1. The Offeror's or Bidder's attention is called to the "Equal Opportunity Clause" and the "Standard Federal Equal Employment Specifications" set forth herein.
2. The goals and timetables for minority and female participation, expressed in percentage terms for the Contractor's aggregate work force in each trade on all construction work in the covered area, are as follows:

GOALS FOR MINORITY PARTICIPATION IN EACH TRADE	GOALS FOR FEMALE PARTICIPATION IN EACH TRADE
5.2%	6.9%

These goals are applicable to all the Contractor's construction work (whether or not it is Federal or federally-assisted) performed in the covered area. If the contractor performs construction work in a geographical area located outside of the covered area, it shall apply the goals established for such geographical area where the work is actually performed. With regard to this second area, the contractor also is subject to the goals for both its federally involved and non-federally involved construction.

The Contractor's compliance with the Executive Order and the regulations in CFR Part 60-4 shall be based on its implementation of the Equal Opportunity Clause, specific affirmative action obligations required by the specifications set forth in 41 CFR 60-4, 3(a), and its efforts to meet the goals. The hours of minority and female employment and training must be substantially uniform throughout the length of the contract, and in each trade, and the contractor shall make a good faith effort to employ minorities and women evenly on each of its projects. The transfer of minority or female employees or trainees from Contractor to Contractor or from project to project for the sole purpose of meeting the Contractor's goals shall be a violation of the contract, the Executive Order and the regulations in 41 CFR Part 60-4. Compliance with the goals will be measured against the total work hours performed.

3. The Contractor shall provide written notification to the Director of the Office of Federal Contract Compliance Programs within ten (10) working days of award of any construction subcontract in excess of \$10,000.00 at any tier for construction work under the contract resulting from this solicitation. The notification shall list the name, address and telephone number of the subcontractor; employer identification number of the subcontractor; estimated dollar amount of the subcontract; estimated starting and completion dates of the subcontract; and the geographical area in which the subcontract is to be performed. The notification shall be mailed to:

**Evelyn Teague, Regional Director
Office of Federal Contract Compliance Programs
61 Forsyth Street, SW, Suite 7B75
Atlanta, Georgia 30303-8609**

4. As used in this Notice, and in the contract resulting from this solicitation, the "**covered area**" is Livingston County.

PART IV
INSURANCE

Refer to
Kentucky Standard Specifications for Road and Bridge Construction,
current edition

PART V
BID ITEMS

PROPOSAL BID ITEMS

201021

Page 1 of 6

Report Date 4/1/20

Section: 0001 - PAVING

LINE	BID CODE	ALT	DESCRIPTION	QUANTITY	UNIT	UNIT PRIC	FP	AMOUNT
0010	00003		CRUSHED STONE BASE	12,047.00	TON		\$	
0020	00008		CEMENT STABILIZED ROADBED	11,123.00	SQYD		\$	
0030	00078		CRUSHED AGGREGATE SIZE NO 2	4,626.00	TON		\$	
0040	00100		ASPHALT SEAL AGGREGATE	84.00	TON		\$	
0050	00103		ASPHALT SEAL COAT	10.10	TON		\$	
0060	00190		LEVELING & WEDGING PG64-22	1,030.00	TON		\$	
0070	00214		CL3 ASPH BASE 1.00D PG64-22	5,339.00	TON		\$	
0080	00324		CL3 ASPH SURF 0.50B PG64-22	2,084.00	TON		\$	
0090	00356		ASPHALT MATERIAL FOR TACK	14.30	TON		\$	
0100	00358		ASPHALT CURING SEAL	11.00	TON		\$	
0110	02223		GRANULAR EMBANKMENT	1,481.00	CUYD		\$	
0120	02542		CEMENT	223.00	TON		\$	
0130	02602		FABRIC-GEOTEXTILE CLASS 1	10,407.00	SQYD		\$	
0140	02604		FABRIC-GEOTEXTILE CLASS 1A	8,157.00	SQYD		\$	
0150	02677		ASPHALT PAVE MILLING & TEXTURING	100.00	TON		\$	
0160	02702		SAND FOR BLOTTER	28.00	TON		\$	
0170	20071EC		JOINT ADHESIVE	15,913.00	LF		\$	

Section: 0002 - ROADWAY

LINE	BID CODE	ALT	DESCRIPTION	QUANTITY	UNIT	UNIT PRIC	FP	AMOUNT
0180	01000		PERFORATED PIPE-4 IN	267.00	LF		\$	
0190	01010		NON-PERFORATED PIPE-4 IN	64.00	LF		\$	
0200	01020		PERF PIPE HEADWALL TY 1-4 IN	1.00	EACH		\$	
0210	01024		PERF PIPE HEADWALL TY 2-4 IN	2.00	EACH		\$	
0220	01028		PERF PIPE HEADWALL TY 3-4 IN	1.00	EACH		\$	
0230	01310		REMOVE PIPE	368.00	LF		\$	
0240	01740		CORED HOLE DRAINAGE BOX CON-4 IN	2.00	EACH		\$	
0250	01987		DELINEATOR FOR GUARDRAIL BI DIRECTIONAL WHITE	22.00	EACH		\$	
0260	02014		BARRICADE-TYPE III	4.00	EACH		\$	
0270	02091		REMOVE PAVEMENT	2,347.00	SQYD		\$	
0280	02159		TEMP DITCH	3,774.00	LF		\$	
0290	02160		CLEAN TEMP DITCH	1,887.00	LF		\$	
0300	02200		ROADWAY EXCAVATION	11,352.00	CUYD		\$	
0310	02230		EMBANKMENT IN PLACE	57,270.00	CUYD		\$	
0320	02242		WATER	250.00	MGAL		\$	
0330	02275		FENCE-8 FT CHAIN LINK	30.00	LF		\$	
0340	02287		DOUBLE VEHICULAR CHAIN LINK GATE	1.00	EACH		\$	
0350	02351		GUARDRAIL-STEEL W BEAM-S FACE	2,187.50	LF		\$	
0360	02360		GUARDRAIL TERMINAL SECTION NO 1	2.00	EACH		\$	
0370	02371		GUARDRAIL END TREATMENT TYPE 7	2.00	EACH		\$	
0380	02391		GUARDRAIL END TREATMENT TYPE 4A	2.00	EACH		\$	
0390	02429		RIGHT-OF-WAY MONUMENT TYPE 1	29.00	EACH		\$	
0400	02432		WITNESS POST	3.00	EACH		\$	
0410	02483		CHANNEL LINING CLASS II	81.00	TON		\$	

PROPOSAL BID ITEMS

201021

Page 2 of 6

Report Date 4/1/20

LINE	BID CODE	ALT	DESCRIPTION	QUANTITY	UNIT	UNIT PRIC	FP	AMOUNT
0420	02484		CHANNEL LINING CLASS III	9.00	TON		\$	
0430	02545		CLEARING AND GRUBBING APPROX. 25 ACRES	1.00	LS		\$	
0440	02555		CONCRETE-CLASS B	1.00	CUYD		\$	
0450	02562		TEMPORARY SIGNS	362.00	SQFT		\$	
0460	02570		PROJECT CPM SCHEDULE	1.00	LS		\$	
0470	02585		EDGE KEY	241.00	LF		\$	
0480	02650		MAINTAIN & CONTROL TRAFFIC	1.00	LS		\$	
0490	02671		PORTABLE CHANGEABLE MESSAGE SIGN	2.00	EACH		\$	
0500	02676		MOBILIZATION FOR MILL & TEXT	1.00	LS		\$	
0510	02690		SAFELOADING	17.00	CUYD		\$	
0520	02692		SETTLEMENT PLATFORM	1.00	EACH		\$	
0530	02696		SHOULDER RUMBLE STRIPS	5,434.00	LF		\$	
0540	02701		TEMP SILT FENCE	3,774.00	LF		\$	
0550	02703		SILT TRAP TYPE A	25.00	EACH		\$	
0560	02704		SILT TRAP TYPE B	25.00	EACH		\$	
0570	02705		SILT TRAP TYPE C	25.00	EACH		\$	
0580	02706		CLEAN SILT TRAP TYPE A	25.00	EACH		\$	
0590	02707		CLEAN SILT TRAP TYPE B	25.00	EACH		\$	
0600	02708		CLEAN SILT TRAP TYPE C	25.00	EACH		\$	
0610	02726		STAKING	1.00	LS		\$	
0620	02731		REMOVE STRUCTURE REMOVE EXISTING US60 BRIDGE OVER CUMBERLAND RIVER	1.00	LS		\$	
0630	02775		ARROW PANEL	2.00	EACH		\$	
0640	03340		STEEL PIPE-2 1/2 IN	35.00	LF		\$	
0650	03343		STEEL PIPE-4 IN	35.00	LF		\$	
0660	05950		EROSION CONTROL BLANKET	6,811.00	SQYD		\$	
0670	05952		TEMP MULCH	79,404.00	SQYD		\$	
0680	05953		TEMP SEEDING AND PROTECTION	59,553.00	SQYD		\$	
0690	05963		INITIAL FERTILIZER	17.00	TON		\$	
0700	05964		MAINTENANCE FERTILIZER	9.00	TON		\$	
0710	05985		SEEDING AND PROTECTION	83,727.00	SQYD		\$	
0720	05992		AGRICULTURAL LIMESTONE	74.00	TON		\$	
0730	06510		PAVE STRIPING-TEMP PAINT-4 IN	5,000.00	LF		\$	
0740	06542		PAVE STRIPING-THERMO-6 IN W	13,459.00	LF		\$	
0750	06543		PAVE STRIPING-THERMO-6 IN Y	15,344.00	LF		\$	
0760	06568		PAVE MARKING-THERMO STOP BAR-24IN	52.00	LF		\$	
0770	06574		PAVE MARKING-THERMO CURV ARROW	4.00	EACH		\$	
0780	10020NS		FUEL ADJUSTMENT	51,125.00	DOLL	\$1.00	\$	\$51,125.00
0790	10030NS		ASPHALT ADJUSTMENT	27,786.00	DOLL	\$1.00	\$	\$27,786.00
0800	20166ES810		TEMPORARY PIPE	129.00	LF		\$	
0810	20191ED		OBJECT MARKER TY 3	2.00	EACH		\$	
0820	21289ED		LONGITUDINAL EDGE KEY	2,870.00	LF		\$	
0830	23189EC		REMOVE GATE	1.00	EACH		\$	
0840	23912EC		WEB CAMERA CONST MONITORING SYSTEM	1.00	LS		\$	
0850	24605ED		RELOCATE RELOCATE EXISTING FLAGPOLE	1.00	EACH		\$	
0860	25078ED		THRIE BEAM GUARDRAIL TRANSITION TL-3 TL-3	4.00	EACH		\$	

PROPOSAL BID ITEMS

201021

Page 3 of 6

Report Date 4/1/20

LINE	BID CODE	ALT	DESCRIPTION	QUANTITY	UNIT	UNIT PRIC	FP	AMOUNT
0870	25086EC		AUTOMATED SLIDE GATE 30' SLIDE GATE FOR 8-FOOT-HIGH GATE WITH 3 STRANDS BARBED WIRE	1.00	EACH		\$	
0880	25087EC		V BARBED WIRE ARMS WITH THREE ADDITIONAL STRANDS	30.00	LF		\$	
0890	25088EC		AUTOMATED SLIDING GATE OPERATOR	1.00	EACH		\$	

Section: 0003 - DRAINAGE

LINE	BID CODE	ALT	DESCRIPTION	QUANTITY	UNIT	UNIT PRIC	FP	AMOUNT
0900	00440		ENTRANCE PIPE-15 IN	199.00	LF		\$	
0910	00462		CULVERT PIPE-18 IN	340.00	LF		\$	
0920	00521		STORM SEWER PIPE-15 IN	335.00	LF		\$	
0930	00522		STORM SEWER PIPE-18 IN	58.00	LF		\$	
0940	00524		STORM SEWER PIPE-24 IN	588.00	LF		\$	
0950	01450		S & F BOX INLET-OUTLET-18 IN	10.00	EACH		\$	
0960	01451		S & F BOX INLET-OUTLET-24 IN	1.00	EACH		\$	
0970	01496		DROP BOX INLET TYPE 3	8.00	EACH		\$	
0980	01691		FLUME INLET TYPE 2	2.00	EACH		\$	
0990	01761		MANHOLE TYPE B	2.00	EACH		\$	
1000	02607		FABRIC-GEOTEXTILE CLASS 2 FOR PIPE	2,368.00	SQYD	\$2.00	\$	\$4,736.00
1010	23952EC		DRAINAGE JUNCTION BOX TY B 18 IN	1.00	EACH		\$	
1020	24575ES610		HEADWALL 15 IN MITERED	8.00	EACH		\$	
1030	24575ES610		HEADWALL 18 IN MITERED	1.00	EACH		\$	
1040	24814EC		PIPELINE INSPECTION	1,027.00	LF		\$	

Section: 0004 - BRIDGE-EXISTING STRUCTURE REPAIR

LINE	BID CODE	ALT	DESCRIPTION	QUANTITY	UNIT	UNIT PRIC	FP	AMOUNT
1050	02650		MAINTAIN & CONTROL TRAFFIC	1.00	LS		\$	
1060	02671		PORTABLE CHANGEABLE MESSAGE SIGN	2.00	EACH		\$	
1070	22146EN		CONCRETE PATCHING REPAIR	400.00	SQFT		\$	
1080	23853EC		BEARING REPAIR	6.00	EACH		\$	
1090	25015EC		FRP WRAP	2,234.00	SQFT		\$	

Section: 0005 - BRIDGE-MAINTAIN EXISTING BRIDGE

LINE	BID CODE	ALT	DESCRIPTION	QUANTITY	UNIT	UNIT PRIC	FP	AMOUNT
1100	24755EC		MAINTAIN EXISTING BRIDGE	500,000.00	DOLL	\$1.00	\$	\$500,000.00

Section: 0006 - BRIDGE

LINE	BID CODE	ALT	DESCRIPTION	QUANTITY	UNIT	UNIT PRIC	FP	AMOUNT
------	----------	-----	-------------	----------	------	-----------	----	--------

PROPOSAL BID ITEMS

201021

Page 4 of 6

Report Date 4/1/20

LINE	BID CODE	ALT	DESCRIPTION	QUANTITY	UNIT	UNIT PRIC	FP	AMOUNT
1110	02231		STRUCTURE GRANULAR BACKFILL	500.00	CUYD		\$	
1120	02555		CONCRETE-CLASS B	75.00	CUYD		\$	
1130	02998		MASONRY COATING	11,557.00	SQYD		\$	
1140	03299		ARMORED EDGE FOR CONCRETE	80.00	LF		\$	
1150	04775		NAVIGATION LIGHT 360 DEG GREEN	2.00	EACH		\$	
1160	04776		NAVIGATION LIGHT 180 DEG RED	4.00	EACH		\$	
1170	04793		CONDUIT-1 1/4 IN	180.00	LF		\$	
1180	04797		CONDUIT-3 IN	4,022.00	LF		\$	
1190	04799		CONDUIT-4 IN	4,028.00	LF		\$	
1200	06406		SBM ALUM SHEET SIGNS .080 IN	16.00	SQFT		\$	
1210	08001		STRUCTURE EXCAVATION-COMMON	3,350.00	CUYD		\$	
1220	08002		STRUCTURE EXCAV-SOLID ROCK	310.00	CUYD		\$	
1230	08003		FOUNDATION PREPARATION	1.00	LS		\$	
1240	08019		CYCLOPEAN STONE RIP RAP	3,780.00	TON		\$	
1250	08020		CRUSHED AGGREGATE SLOPE PROT	220.00	TON		\$	
1260	08033		TEST PILES	809.00	LF		\$	
1270	08037		COFFERDAM	1.00	LS		\$	
1280	08051		PILES-STEEL HP14X89	3,826.00	LF		\$	
1290	08095		PILE POINTS-14 IN	42.00	EACH		\$	
1300	08100		CONCRETE-CLASS A	8,751.20	CUYD		\$	
1310	08104		CONCRETE-CLASS AA	2,540.00	CUYD		\$	
1320	08137		MECHANICAL REINF COUPLER #14	1,080.00	EACH		\$	
1330	08150		STEEL REINFORCEMENT	1,229,769.00	LB		\$	
1340	08151		STEEL REINFORCEMENT-EPOXY COATED	995,365.00	LB		\$	
1350	08160		STRUCTURAL STEEL 5,198,270 LBS	1.00	LS		\$	
1360	08170		SHEAR CONNECTORS 13,760 EACH	1.00	LS		\$	
1370	08470		EXPANSION DAM-2 IN NEOPRENE	40.00	LF		\$	
1380	08471		EXPANSION DAM-2.5 IN NEOPRENE	40.00	LF		\$	
1390	08500		APPROACH SLAB	224.00	SQYD		\$	
1400	08752		PAINT CLEARANCE GAUGES	1.00	LS		\$	
1410	20410ED		MAINTAIN LIGHTING	1.00	LS		\$	
1420	20610NC		INSTRUMENTATION	1.00	LS		\$	
1430	20745ED		ROCK SOUNDINGS	1,243.00	LF		\$	
1440	20746ED		ROCK CORINGS	810.00	LF		\$	
1450	23233EC		DYNAMIC PILE TESTING	5.00	EACH		\$	
1460	23365EC		LIGHTING-NAV MONITORING SYSTEM	1.00	LS		\$	
1470	23859EC		FINGER EXPANSION JOINT	40.00	LF		\$	
1480	23868EC		STRUCTURE LIGHTNING PROTECTION	1.00	LS		\$	
1490	24098EC		PPC I-BEAM TYPE HN 66-49	1,452.00	LF		\$	
1500	24534ED		PIPE PILE-30"	6,634.00	LF		\$	
1510	24537ED		OPEN END INSIDE FIT CUTTING SHOE-30"	65.00	EACH		\$	
1520	24614EC		DISC EXPANSION BEARING	2.00	EACH		\$	
1530	24741EC		SONAR CALIPER TESTING	18.00	EACH		\$	
1540	24804EC		PPC I-BEAM 4N 78 49	3,336.00	LF		\$	
1550	24838EC		SOLAR POWERED NAV LIGHTING SYSTEM	6.00	EACH		\$	
1560	24874EC		TIP TESTING PIER 3	8.00	EACH		\$	
1570	24874EC		TIP TESTING PIER 4	8.00	EACH		\$	

PROPOSAL BID ITEMS

201021

Page 5 of 6

Report Date 4/1/20

LINE	BID CODE	ALT	DESCRIPTION	QUANTITY	UNIT	UNIT PRIC	FP	AMOUNT
1580	24875EC		CSL TESTING (8 TUBES) PIER 3	16.00	EACH		\$	
1590	24875EC		CSL TESTING (8 TUBES) PIER 4	16.00	EACH		\$	
1600	25003EC		DRILLED SHAFT - 96 IN (COMMON) PIER 3	267.00	LF		\$	
1610	25003EC		DRILLED SHAFT - 96 IN (COMMON) PIER 4	603.00	LF		\$	
1620	25004EC		DRILLED SHAFT - 90 IN (SOLID ROCK) PIER 3	285.00	LF		\$	
1630	25004EC		DRILLED SHAFT - 90 IN (SOLID ROCK) PIER 4	165.00	LF		\$	
1640	25027ED		RAIL SYSTEM SINGLE SLOPE - 36 IN	3,826.00	LF		\$	
1650	25029ED		STEEL HANDRAIL	3,826.00	LF		\$	
1660	25046EC		DISC FIXED BEARING	2.00	EACH		\$	
1670	25085EC		STRIP SEAL EXPANSION JOINT - 5 INCH	40.00	LF		\$	

Section: 0007 - UTILITIES- WATER AND SEWER

LINE	BID CODE	ALT	DESCRIPTION	QUANTITY	UNIT	UNIT PRIC	FP	AMOUNT
1680	01314		PLUG PIPE	4.00	EACH		\$	
1690	02690		SAFELoading	16.00	CUYD		\$	
1700	05985		SEEDING AND PROTECTION	1,374.00	SQYD		\$	
1710	14000		W AIR RELEASE VALVE 1 INCH	2.00	EACH		\$	
1720	14008		W ENCASEMENT STEEL BORED RANGE 3	255.00	LF		\$	
1730	14019		W FIRE HYDRANT ASSEMBLY	3.00	EACH		\$	
1740	14021		W FIRE HYDRANT REMOVE	3.00	EACH		\$	
1750	14022		W FLUSH HYDRANT ASSEMBLY	2.00	EACH		\$	
1760	14025		W METER 1 INCH	10.00	EACH		\$	
1770	14058		W PIPE PVC 04 INCH	652.00	LF		\$	
1780	14059		W PIPE PVC 06 INCH	778.00	LF		\$	
1790	14074		W PLUG EXISTING MAIN	4.00	EACH		\$	
1800	14077		W SERV PE/PLST LONG SIDE 1 IN	2.00	EACH		\$	
1810	14082		W SERV PE/PLST SHORT SIDE 1 IN	8.00	EACH		\$	
1820	14089		W TAPPING SLEEVE AND VALVE SIZE 1	2.00	EACH		\$	
1830	14094		W TIE-IN 06 INCH	3.00	EACH		\$	
1840	14105		W VALVE 06 INCH	6.00	EACH		\$	
1850	14156		W METER REMOVE	7.00	EACH		\$	
1860	15000		S BYPASS PUMPING	1.00	EACH		\$	
1870	15017		S ENCASEMENT STEEL BORED RANGE 4	86.00	LF		\$	
1880	15023		S ENCASEMENT STEEL OPEN CUT RANGE 4	130.00	LF		\$	
1890	15090		S LATERAL SHORT SIDE 06 INCH	8.00	EACH		\$	
1900	15092		S MANHOLE	7.00	EACH		\$	
1910	15093		S MANHOLE ABANDON/REMOVE	4.00	EACH		\$	
1920	15094		S MANHOLE ADJUST TO GRADE	1.00	EACH		\$	
1930	15096		S MANHOLE CASTING WATERTIGHT	10.00	EACH		\$	
1940	15097		S MANHOLE RECONSTRUCT INVERT	1.00	EACH		\$	
1950	15099		S MANHOLE TAP EXISTING	2.00	EACH		\$	
1960	15101		S MANHOLE WITH DROP	1.00	EACH		\$	
1970	15112		S PIPE PVC 08 INCH	1,169.00	LF		\$	

PROPOSAL BID ITEMS

201021

Page 6 of 6

Report Date 4/1/20

LINE	BID CODE	ALT	DESCRIPTION	QUANTITY	UNIT	UNIT PRIC	FP	AMOUNT
1980	15136		S LATERAL LOCATE	8.00	EACH		\$	

Section: 0008 - TRAINEE

LINE	BID CODE	ALT	DESCRIPTION	QUANTITY	UNIT	UNIT PRIC	FP	AMOUNT
1990	02742		TRAINEE PAYMENT REIMBURSEMENT 1 - IRONWORKER	1,400.00	HOUR		\$	

Section: 0009 - DEMOBILIZATION &/OR MOBILIZATION

LINE	BID CODE	ALT	DESCRIPTION	QUANTITY	UNIT	UNIT PRIC	FP	AMOUNT
2000	02568		MOBILIZATION	1.00	LS		\$	
2010	02569		DEMOBILIZATION	1.00	LS		\$	