



**CALL NO. 103**

**CONTRACT ID. 191054**

**JEFFERSON COUNTY**

**FED/STATE PROJECT NUMBER NHPP 0311 (045)**

**DESCRIPTION US-31W**

**WORK TYPE JPC PAVEMENT REPAIRS**

**PRIMARY COMPLETION DATE 5/31/2020**

**LETTING DATE: September 20,2019**

Sealed Bids will be received electronically through the Bid Express bidding service until 10:00 AM EASTERN DAYLIGHT TIME September 20,2019. Bids will be publicly announced at 10:00 AM EASTERN DAYLIGHT TIME.

**NO PLANS ASSOCIATED WITH THIS PROJECT.**

**DBE CERTIFICATION REQUIRED - 14%**

**REQUIRED BID PROPOSAL GUARANTY:** Not less than 5% of the total bid.

## TABLE OF CONTENTS

PART I	SCOPE OF WORK
	<ul style="list-style-type: none"><li>• PROJECT(S), COMPLETION DATE(S), &amp; LIQUIDATED DAMAGES</li><li>• CONTRACT NOTES</li><li>• FEDERAL CONTRACT NOTES</li><li>• NATIONAL HIGHWAY</li><li>• SIGNIFICANT PROJECT -PROJECT TRAFFIC COORDINATOR</li><li>• DGA BASE</li><li>• DGA BASE FOR SHOULDERS</li><li>• SPECIAL NOTE(S) APPLICABLE TO PROJECT</li><li>• CONCRETE SLURRY</li><li>• RIGHT OF WAY NOTES</li><li>• UTILITY IMPACT &amp; RAIL CERTIFICATION NOTES</li></ul>
PART II	SPECIFICATIONS AND STANDARD DRAWINGS
	<ul style="list-style-type: none"><li>• SPECIFICATIONS REFERENCE</li><li>• SUPPLEMENTAL SPECIFICATION</li><li>• [SN-1I] PORTABLE CHANGEABLE SIGNS</li><li>• [SN-11J] FULL DEPTH CONCRETE PAVEMENT REPAIR</li></ul>
PART III	EMPLOYMENT, WAGE AND RECORD REQUIREMENTS
	<ul style="list-style-type: none"><li>• FEDERAL-AID CONSTRUCTION CONTRACTS - FHWA 1273</li><li>• NONDISCRIMINATION OF EMPLOYEES</li><li>• EXECUTIVE BRANCH CODE OF ETHICS</li><li>• PROJECT WAGE RATES / FEDERAL FUNDED (DBA-WAGE DETERMINATIONS)</li><li>• NOTICE OF REQUIREMENT FOR AFFIRMATIVE ACTION TO ENSURE EEO JEFFERSON</li></ul>
PART IV	INSURANCE
PART V	BID ITEMS

**PART I**  
**SCOPE OF WORK**

## ADMINISTRATIVE DISTRICT - 05

**CONTRACT ID - 191054**

**NHPP 0311 (045)**

**COUNTY - JEFFERSON**

**PCN - DE056031W1954**

**NHPP 0311 (045)**

US-31W (MP 14.511) ADDRESS CONDITION OF PCC PAVEMENT ON US-31W FROM MP 14.511 TO MP 14.999 IN JEFFERSON COUNTY (MP 14.999), A DISTANCE OF 0.49 MILES.JPC PAVEMENT REPAIRS SYP NO. 05-20032.00.  
GEOGRAPHIC COORDINATES LATITUDE 38:11:06.00 LONGITUDE 85:48:48.00

**COMPLETION DATE(S):**

COMPLETED BY 05/31/2020

APPLIES TO ENTIRE CONTRACT



## **CONTRACT NOTES**

### **PROPOSAL ADDENDA**

All addenda to this proposal must be applied when calculating bid and certified in the bid packet submitted to the Kentucky Department of Highways. Failure to use the correct and most recent addenda may result in the bid being rejected.

### **BID SUBMITTAL**

Bidder must use the Department's electronic bidding software. The Bidder must download the bid file located on the Bid Express website ([www.bidx.com](http://www.bidx.com)) to prepare a bid packet for submission to the Department. The bidder must submit electronically using Bid Express.

### **JOINT VENTURE BIDDING**

Joint venture bidding is permissible. All companies in the joint venture must be prequalified in one of the work types in the Qualifications for Bidders for the project. The bidders must get a vendor ID for the joint venture from the Division of Construction Procurement and register the joint venture as a bidder on the project. Also, the joint venture must obtain a digital ID from Bid Express to submit a bid. A joint bid bond of 5% may be submitted for both companies or each company may submit a separate bond of 5%.

### **UNDERGROUND FACILITY DAMAGE PROTECTION**

The contractor shall make every effort to protect underground facilities from damage as prescribed in the Underground Facility Damage Protection Act of 1994, Kentucky Revised Statute KRS 367.4901 to 367.4917. It is the contractor's responsibility to determine and take steps necessary to be in compliance with federal and state damage prevention directives. When prescribed in said directives, the contractor shall submit Excavation Locate Requests to the Kentucky Contact Center (KY811) via web ticket entry. The submission of this request does not relieve the contractor from the responsibility of contacting non-member facility owners, whom shall be contacted through their individual Protection Notification Center. Non-compliance with these directives can result in the enforcement of penalties.

### **REGISTRATION WITH THE SECRETARY OF STATE BY A FOREIGN ENTITY**

Pursuant to KRS 176.085(1)(b), an agency, department, office, or political subdivision of the Commonwealth of Kentucky shall not award a state contract to a person that is a foreign entity required by [KRS 14A.9-010](#) to obtain a certificate of authority to transact business in the Commonwealth ("certificate") from the Secretary of State under [KRS 14A.9-030](#) unless the person produces the certificate within fourteen (14) days of the bid or proposal opening. If the foreign entity is not required to obtain a certificate as provided in [KRS 14A.9-010](#), the foreign entity should identify the applicable exception. Foreign entity is defined within [KRS 14A.1-070](#).

**For all foreign entities required to obtain a certificate of authority to transact business in the Commonwealth, if a copy of the certificate is not received by the contracting agency within the time frame identified above, the foreign entity's solicitation response shall be deemed non-responsive or the awarded contract shall be cancelled.**

Businesses can register with the Secretary of State at <https://secure.kentucky.gov/sos/ftbr/welcome.aspx>.

### **SPECIAL NOTE FOR PROJECT QUESTIONS DURING ADVERTISEMENT**

Questions about projects during the advertisement should be submitted in writing to the Division of Construction Procurement. This may be done by fax (502) 564-7299 or email to [kytc.projectquestions@ky.gov](mailto:kytc.projectquestions@ky.gov). The Department will attempt to answer all submitted questions. The Department reserves the right not to answer if the question is not pertinent or does not aid in clarifying the project intent.

The deadline for posting answers will be 3:00 pm Eastern Daylight Time, the day preceding the Letting. Questions may be submitted until this deadline with the understanding that the later a question is submitted, the less likely an answer will be able to be provided.

The questions and answers will be posted for each Letting under the heading "Questions & Answers" on the Construction Procurement website ([www.transportation.ky.gov/contract](http://www.transportation.ky.gov/contract)). The answers provided shall be considered part of this Special Note and, in case of a discrepancy, will govern over all other bidding documents.

### **HARDWOOD REMOVAL RESTRICTIONS**

The US Department of Agriculture has imposed a quarantine in Kentucky and several surrounding states, to prevent the spread of an invasive insect, the emerald ash borer. Hardwood cut in conjunction with the project may not be removed from the state. Chipping or burning on site is the preferred method of disposal.

### **INSTRUCTIONS FOR EXCESS MATERIAL SITES AND BORROW SITES**

Identification of excess material sites and borrow sites shall be the responsibility of the Contractor. The Contractor shall be responsible for compliance with all applicable state and federal laws and may wish to consult with the US Fish and Wildlife Service to seek protection under Section 10 of the Endangered Species Act for these activities.

### **ACCESS TO RECORDS**

The contractor, as defined in KRS 45A.030 (9) agrees that the contracting agency, the Finance and Administration Cabinet, the Auditor of Public Accounts, and the Legislative Research Commission, or their duly authorized representatives, shall have access to any books, documents, papers, records, or other evidence, which are directly pertinent to this contract for the purpose of financial audit or program review. Records and other prequalification information confidentially

disclosed as part of the bid process shall not be deemed as directly pertinent to the contract and shall be exempt from disclosure as provided in KRS 61.878(1)(c). The contractor also recognizes that any books, documents, papers, records, or other evidence, received during a financial audit or program review shall be subject to the Kentucky Open Records Act, KRS 61.870 to 61.884.

In the event of a dispute between the contractor and the contracting agency, Attorney General, or the Auditor of Public Accounts over documents that are eligible for production and review, the Finance and Administration Cabinet shall review the dispute and issue a determination, in accordance with Secretary's Order 11-004.

April 30, 2018

### **FEDERAL CONTRACT NOTES**

The Kentucky Department of Highways, in accordance with the Regulations of the United States Department of Transportation 23 CFR 635.112 (h), hereby notifies all bidders that failure by a bidder to comply with all applicable sections of the current Kentucky Standard Specifications, including, but not limited to the following, may result in a bid not being considered responsive and thus not eligible to be considered for award:

- |                                |  |
|--------------------------------|--|
| 102.02 Current Rating          | 102.08 Preparation and Delivery of Proposals |
| 102.13 Irregular Bid Proposals | 102.14 Disqualification of Bidders           |
| 102.09 Proposal Guaranty       |  |

### **CIVIL RIGHTS ACT OF 1964**

The Kentucky Department of Highways, in accordance with the provisions of Title VI of the Civil Rights Act of 1964 (78 Stat. 252) and the Regulations of the Federal Department of Transportation (49 C.F.R., Part 21), issued pursuant to such Act, hereby notifies all bidders that it will affirmatively insure that the contract entered into pursuant to this advertisement will be awarded to the lowest responsible bidder without discrimination on the ground of race, color, or national origin.

### **NOTICE TO ALL BIDDERS**

To report bid rigging activities call: 1-800-424-9071.

The U.S. Department of Transportation (DOT) operates the above toll-free “hotline” Monday through Friday, 8:00 a.m. to 5:00 p.m. eastern time. Anyone with knowledge of possible bid rigging, bidder collusion, or other fraudulent activities should use the “hotline” to report such activities.

The “hotline” is part of the DOT’s continuing effort to identify and investigate highway construction contract fraud and abuse and is operated under the direction of the DOT Inspector General. All information will be treated confidentially and caller anonymity will be respected.

### **SECOND TIER SUBCONTRACTS**

Second Tier subcontracts on federally assisted projects shall be permitted. However, in the case of DBE’s, second tier subcontracts will only be permitted where the other subcontractor is also a DBE. All second tier subcontracts shall have the consent of both the Contractor and the Engineer.

### **DISADVANTAGED BUSINESS ENTERPRISE PROGRAM**

It is the policy of the Kentucky Transportation Cabinet (“the Cabinet”) that Disadvantaged Business Enterprises (“DBE”) shall have the opportunity to participate in the performance of highway construction projects financed in whole or in part by Federal Funds in order to create a level playing field for all businesses who wish to contract with the Cabinet. To that end, the Cabinet will comply with the regulations found in 49 CFR Part 26, and the definitions and requirements contained therein shall be adopted as if set out verbatim herein.

The Cabinet, contractors, subcontractors, and sub-recipients shall not discriminate on the basis of race, color, national origin, or sex in the performance of work performed pursuant to Cabinet contracts. The contractor shall carry out applicable requirements of 49 CFR 26 in the award and administration of federally assisted highway construction projects. The contractor will include this provision in all its subcontracts and supply agreements pertaining to contracts with the Cabinet.

Failure by the contractor to carry out these requirements is a material breach of its contract with the Cabinet, which may result in the termination of the contract or such other remedy as the Cabinet deems necessary.

### **DBE GOAL**

The Disadvantaged Business Enterprise (DBE) goal established for this contract, as listed on the front page of the proposal, is the percentage of the total value of the contract.

The contractor shall exercise all necessary and reasonable steps to ensure that Disadvantaged Business Enterprises participate in a least the percent of the contract as set forth above as goals for this contract.

### **OBLIGATION OF CONTRACTORS**

Each contractor prequalified to perform work on Cabinet projects shall designate and make known to the Cabinet a liaison officer who is assigned the responsibility of effectively administering and promoting an active program for utilization of DBEs.

If a formal goal has not been designated for the contract, all contractors are encouraged to consider DBEs for subcontract work as well as for the supply of material and services needed to perform this work.

Contractors are encouraged to use the services of banks owned and controlled by minorities and women.

### **CERTIFICATION OF CONTRACT GOAL**

Contractors shall include the following certification in bids for projects for which a DBE goal has been established. BIDS SUBMITTED WHICH DO NOT INCLUDE CERTIFICATION OF DBE PARTICIPATION WILL NOT BE ACCEPTED. These bids will not be considered for award by the Cabinet and they will be returned to the bidder.

“The bidder certifies that it has secured participation by Disadvantaged Business Enterprises (“DBE”) in the amount of \_\_\_\_\_ percent of the total value of this contract and that the DBE participation is in compliance with the requirements of 49 CFR 26 and the policies of the Kentucky Transportation Cabinet pertaining to the DBE Program.”

**The certification statement is located in the electronic bid file. All contractors must certify their DBE participation on that page. DBEs utilized in achieving the DBE goal must be certified and prequalified for the work items at the time the bid is submitted.**

### **DBE PARTICIPATION PLAN**

Lowest responsive bidders must submit the *DBE Plan/ Subcontractor Request*, form TC 14-35 DBE, within **5** days of the letting. This is necessary before the Awards Committee will review and make a recommendation. **The project will not be considered for award prior to submission and approval of the apparent low bidder’s DBE Plan/Subcontractor Request.**

The DBE Participation Plan shall include the following:

1. Name and address of DBE Subcontractor(s) and/or supplier(s) intended to be used in the proposed project;
2. Description of the work each is to perform including the work item, unit, quantity, unit price and total amount of the work to be performed by the individual DBE. The Proposal Line Number, Category Number, and the Project Line Number can be found in the “material listing” on the Construction Procurement website under the specific letting;
3. The dollar value of each proposed DBE subcontract and the percentage of total project contract value this represents. DBE participation may be counted as follows:
  - a. If DBE suppliers and manufactures assume actual and contractual responsibility, the dollar value of materials to be furnished will be counted toward the goal as follows:
    - The entire expenditure paid to a DBE manufacturer;
    - 60 percent of expenditures to DBE suppliers that are not manufacturers provided the supplier is a regular dealer in the product involved. A regular dealer must be engaged in, as its principal business and in its own name, the sale of products to the public, maintain an inventory and own and operate distribution equipment; and
    - The amount of fees or commissions charged by the DBE firms for a bona fide service, such as professional, technical, consultant, or managerial services and assistance in the procurement of essential personnel, facilities, equipment, materials, supplies, delivery of materials and supplies or for furnishing bonds, or insurance, providing such fees or commissions are determined to be reasonable and customary.

- b) The dollar value of services provided by DBEs such as quality control testing, equipment repair and maintenance, engineering, staking, etc.;
  - c) The dollar value of joint ventures. DBE credit for joint ventures will be limited to the dollar amount of the work actually performed by the DBE in the joint venture;
4. Written and signed documentation of the bidder's commitment to use a DBE contractor whose participation is being utilized to meet the DBE goal; and
  5. Written and signed confirmation from the DBE that it is participating in the contract as provided in the prime contractor's commitment.

#### **UPON AWARD AND BEFORE A WORK ORDER WILL BE ISSUED**

Contractors must submit the signed subcontract between the contractor and the DBE contractor, along with the DBE's certificate of insurance. If the DBE is a supplier of materials for the project, a signed purchase order must be submitted to the Division of Construction Procurement.

Changes to DBE Participation Plans must be approved by the Cabinet. The Cabinet may consider extenuating circumstances including, but not limited to, changes in the nature or scope of the project, the inability or unwillingness of a DBE to perform the work in accordance with the bid, and/or other circumstances beyond the control of the prime contractor.

#### **CONSIDERATION OF GOOD FAITH EFFORTS REQUESTS**

If the DBE participation submitted in the bid by the apparent lowest responsive bidder does not meet or exceed the DBE contract goal, the apparent lowest responsive bidder must submit a Good Faith Effort Package to satisfy the Cabinet that sufficient good faith efforts were made to meet the contract goals prior to submission of the bid. Efforts to increase the goal after bid submission will not be considered in justifying the good faith effort, unless the contractor can show that the proposed DBE was solicited prior to the letting date. DBEs utilized in achieving the DBE goal must be certified and prequalified for the work items at the time the bid is submitted. One complete set (hard copy along with an electronic copy) of this information must be received in the Division of Contract Procurement no later than 12:00 noon of the tenth calendar day after receipt of notification that they are the apparent low bidder.

Where the information submitted includes repetitious solicitation letters it will be acceptable to submit a sample representative letter along with a distribution list of the firms solicited. Documentation of DBE quotations shall be a part of the good faith effort submittal as necessary to demonstrate compliance with the factors listed below which the Cabinet considers in judging good faith efforts. This documentation may include written subcontractors' quotations, telephone log notations of verbal quotations, or other types of quotation documentation.

The Good Faith Effort Package shall include, but may not be limited to information showing evidence of the following:

1. Whether the bidder attended any pre-bid meetings that were scheduled by the Cabinet to inform DBEs of subcontracting opportunities;
2. Whether the bidder provided solicitations through all reasonable and available means;
3. Whether the bidder provided written notice to all DBEs listed in the DBE directory at the time of the letting who are prequalified in the areas of work that the bidder will be subcontracting;
4. Whether the bidder followed up initial solicitations of interest by contacting DBEs to determine with certainty whether they were interested. If a reasonable amount of DBEs within the targeted districts do not provide an intent to quote or no DBEs are prequalified in the subcontracted areas, the bidder must notify the Disadvantaged Enterprise Business Liaison Officer (DEBLO) in the Office of Civil Rights and Small Business Development to give notification of the bidder's inability to get DBE quotes;
5. Whether the bidder selected portions of the work to be performed by DBEs in order to increase the likelihood of meeting the contract goals. This includes, where appropriate, breaking out contract work items into economically feasible units to facilitate DBE participation, even when the prime contractor might otherwise perform these work items with its own forces;
6. Whether the bidder provided interested DBEs with adequate and timely information about the plans, specifications, and requirements of the contract;
7. Whether the bidder negotiated in good faith with interested DBEs not rejecting them as unqualified without sound reasons based on a thorough investigation of their capabilities. Any rejection should be so noted in writing with a description as to why an agreement could not be reached;
8. Whether quotations were received from interested DBE firms but were rejected as unacceptable without sound reasons why the quotations were considered unacceptable. The fact that the DBE firm's quotation for the work is not the lowest quotation received will not in itself be considered as a sound reason for rejecting the quotation as unacceptable. The fact that the bidder has the ability and/or desire to perform the contract work with its own forces will not be considered a sound reason for rejecting a DBE quote. Nothing in this provision shall be construed to require the bidder to accept unreasonable quotes in order to satisfy DBE goals;
9. Whether the bidder specifically negotiated with subcontractors to assume part of the responsibility to meet the contract DBE goal when the work to be subcontracted includes potential DBE participation;
10. Whether the bidder made any efforts and/or offered assistance to interested DBEs in obtaining the necessary equipment, supplies, materials, insurance and/or bonding to satisfy the work requirements of the bid proposal; and
11. Any other evidence that the bidder submits which may show that the bidder has made reasonable good faith efforts to include DBE participation.



### **FAILURE TO MEET GOOD FAITH REQUIREMENT**

Where the apparent lowest responsive bidder fails to submit sufficient participation by DBE firms to meet the contract goal and upon a determination by the Good Faith Committee based upon the information submitted that the apparent lowest responsive bidder failed to make sufficient reasonable efforts to meet the contract goal, the bidder will be offered the opportunity to meet in person for administrative reconsideration. The bidder will be notified of the Committee's decision within 24 hours of its decision. The bidder will have 24 hours to request reconsideration of the Committee's decision. The reconsideration meeting will be held within two days of the receipt of a request by the bidder for reconsideration.

The request for reconsideration will be heard by the Office of the Secretary. The bidder will have the opportunity to present written documentation or argument concerning the issue of whether it met the goal or made an adequate good faith effort. The bidder will receive a written decision on the reconsideration explaining the basis for the finding that the bidder did or did not meet the goal or made adequate Good Faith efforts to do so.

The result of the reconsideration process is not administratively appealable to the Cabinet or to the United States Department of Transportation.

The Cabinet reserves the right to award the contract to the next lowest responsive bidder or to rebid the contract in the event that the contract is not awarded to the low bidder as the result of a failure to meet the good faith requirement.

### **SANCTIONS FOR FAILURE TO MEET DBE REQUIREMENTS OF THE PROJECT**

Failure by the prime contractor to fulfill the DBE requirements of a project under contract or to demonstrate good faith efforts to meet the goal constitutes a breach of contract. When this occurs, the Cabinet will hold the prime contractor accountable, as would be the case with all other contract provisions. Therefore, the contractor's failure to carry out the DBE contract requirements shall constitute a breach of contract and as such the Cabinet reserves the right to exercise all administrative remedies at its disposal including, but not limited to the following:

- Disallow credit toward the DBE goal;
- Withholding progress payments;
- Withholding payment to the prime in an amount equal to the unmet portion of the contract goal; and/or
- Termination of the contract.

### **PROMPT PAYMENT**

The prime contractor will be required to pay the DBE within seven (7) working days after he or she has received payment from the Kentucky Transportation Cabinet for work performed or materials furnished.

### **CONTRACTOR REPORTING**

All contractors must keep detailed records and provide reports to the Cabinet on their progress in meeting the DBE requirement on any highway contract. These records may include, but shall not be limited to payroll, lease agreements, cancelled payroll checks, executed subcontracting agreements, etc. Prime contractors will be required to complete and submit a **signed and notarized** Affidavit of Subcontractor Payment (TC 18-7) and copies of checks for any monies paid to each DBE subcontractor or supplier utilized to meet a DBE goal. These documents must be completed and signed within 7 days of being paid by the Cabinet.

Payment information that needs to be reported includes date the payment is sent to the DBE, check number, Contract ID, amount of payment and the check date. Before Final Payment is made on this contract, the Prime Contractor will certify that all payments were made to the DBE subcontractor and/or DBE suppliers.

#### **\*\*\*\*\* IMPORTANT \*\*\*\*\***

**Please mail the original, signed and completed TC (18-7) Affidavit of Subcontractor Payment form and all copies of checks for payments listed above to the following address:**

Office of Civil Rights and Small Business Development  
6<sup>th</sup> Floor West 200 Mero Street  
Frankfort, KY 40622

The prime contractor should notify the KYTC Office of Civil Rights and Small Business Development seven (7) days prior to DBE contractors commencing work on the project. The contact in this office is Mr. Melvin Bynes. Mr. Bynes' current contact information is email address – [melvin.bynes2@ky.gov](mailto:melvin.bynes2@ky.gov) and the telephone number is (502) 564-3601.

### **DEFAULT OR DECERTIFICATION OF THE DBE**

If the DBE subcontractor or supplier is decertified or defaults in the performance of its work, and the overall goal cannot be credited for the uncompleted work, the prime contractor may utilize a substitute DBE or elect to fulfill the DBE goal with another DBE on a different work item. If after exerting good faith effort in accordance with the Cabinet's Good Faith Effort policies and procedures, the prime contractor is unable to replace the DBE, then the unmet portion of the goal may be waived at the discretion of the Cabinet.

7/19/2019

**LEGAL REQUIREMENTS AND RESPONSIBILITY TO THE PUBLIC – CARGO PREFERENCE ACT (CPA).**

**(REV 12-17-15) (1-16)**

SECTION 7 is expanded by the following new Article:

102.10 **Cargo Preference Act – Use of United States-flag vessels.**

Pursuant to Title 46CFR Part 381, the Contractor agrees

- To utilize privately owned United States-flag commercial vessels to ship at least 50 percent of the gross tonnage (computed separately for dry bulk carriers, dry cargo liners, and tankers) involved, whenever shipping any equipment, material, or commodities pursuant to this contract, to the extent such vessels are available at fair and reasonable rates for United States-flag commercial vessels.

- To furnish within 20 days following the date of loading for shipments originating within the United States or within 30 working days following the date of loading for shipments originating outside the United States, a legible copy of a rated, 'on-board' commercial ocean bill-of-lading in English for each shipment of cargo described in paragraph 1 of this section to both the Contracting Officer (through the prime contractor in the case of subcontractor bills-of-lading) and to the Division of National Cargo, Office of Market Development, Maritime Administration, Washington, DC 20590.

- To insert the substance of the provisions of this clause in all subcontracts issued pursuant to this contract.

**NATIONAL HIGHWAY**

Be advised this project is on the NATIONAL HIGHWAY SYSTEM.

**PROJECT TRAFFIC COORDINATOR (PTC)**

Be advised this project is a significant project pursuant to section 112.03.12.

**DGA BASE**

Unless otherwise noted, the Department estimates the rate of application for DGA Base to be 115 lbs/sy per inch of depth.

**DGA BASE FOR SHOULDERS**

Unless otherwise noted, the Department estimates the rate of application for DGA Base for Shoulders to be 115 lbs/sy per inch of depth. The Department will not measure necessary grading and/or shaping of existing shoulders prior to placing of DGA Base, but shall be incidental to the Contract unit price per ton for DGA Base.

Accept payment at the Contract unit price per ton as full compensation for all labor, materials, equipment, and incidentals for grading and/or shaping of existing shoulders and furnishing, placing, and compacting the DGA Base.

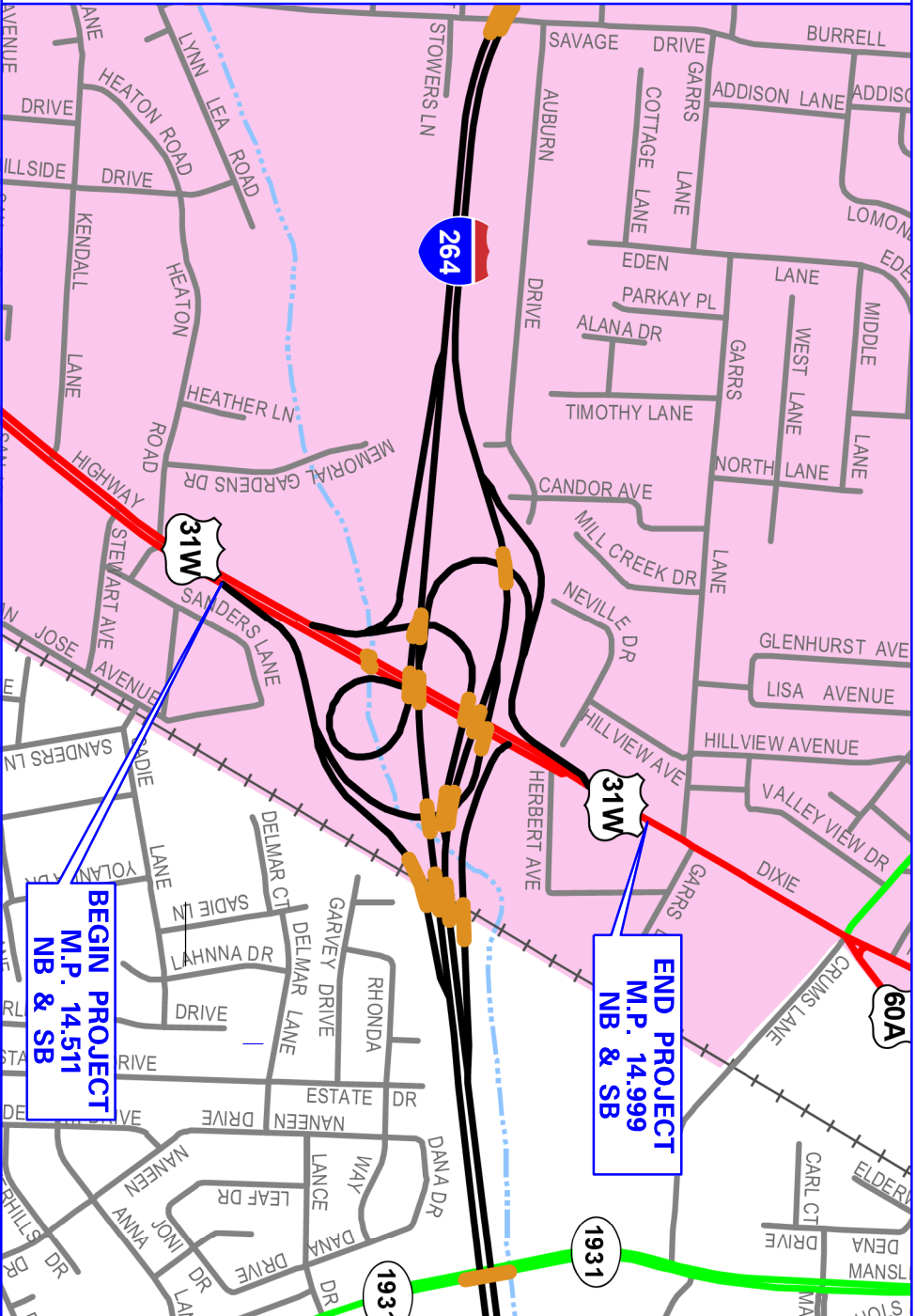
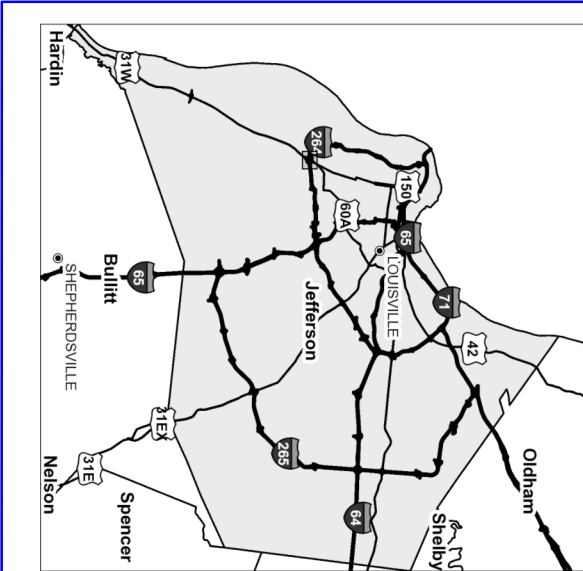
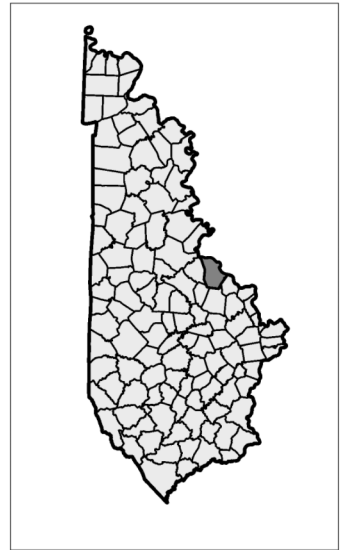

**PROJECT NUMBER:** NHPP 0311 (045), FD52 056 031W 014-015

**ITEM NUMBER:** 5-20032 **LETTING DATE:** SEPTEMBER 20, 2019

**RECOMMENDED BY:** ANDRE JOHANNES, P.E. **DATE:**

**PLAN APPROVED BY:** *Project Manager* **DATE:**

**FHWA APPROVED BY:** *State Highway Engineer* **DATE:**



3 HMB Circle, U.S. 460  
Frankfort, KY 40601  
502-695-9800



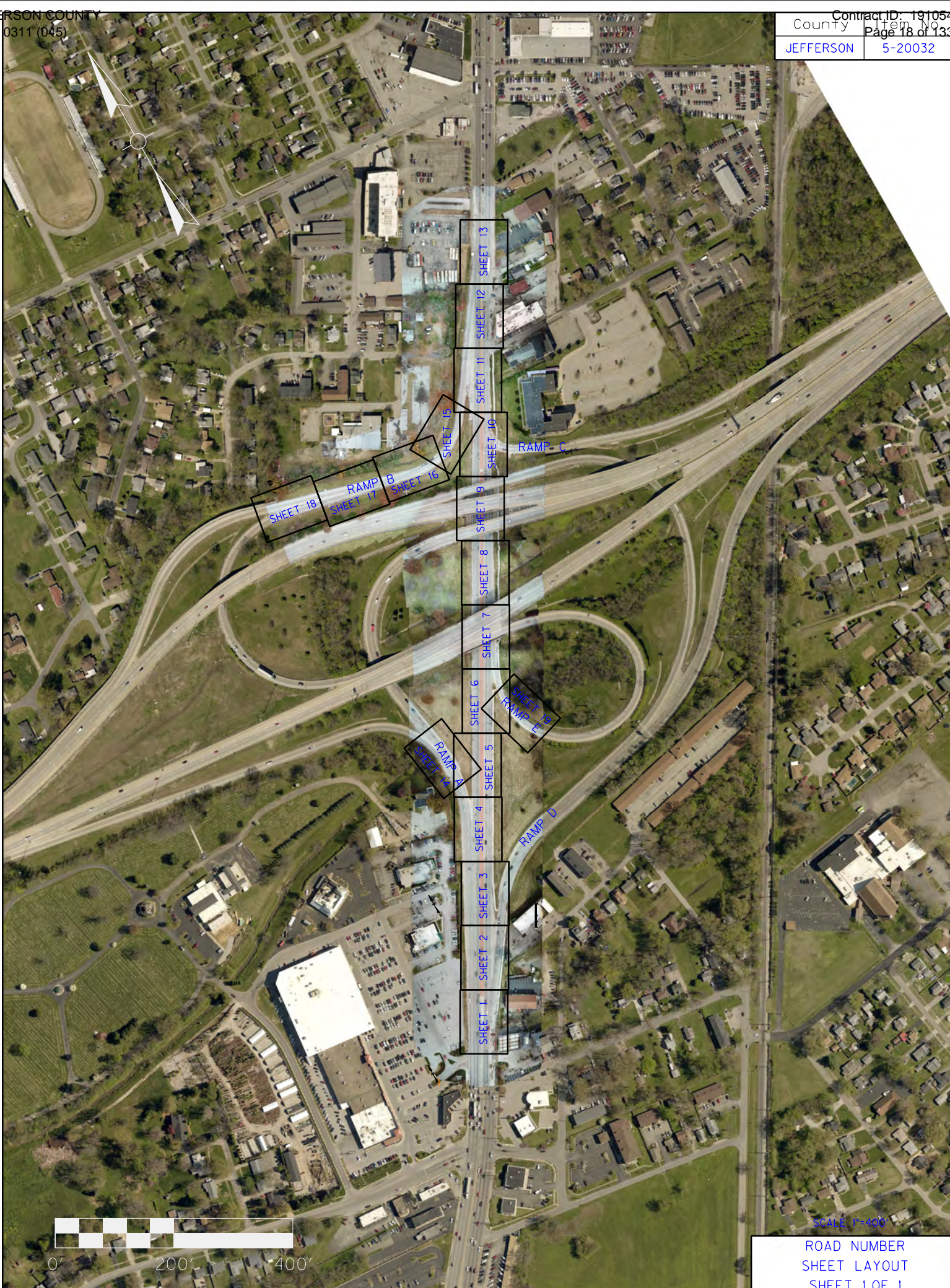

SCALE 1"=400'

ROAD NUMBER  
SHEET LAYOUT  
SHEET 1 OF 1



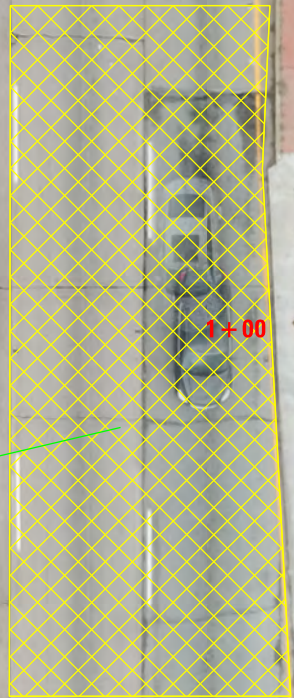
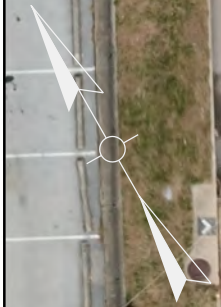

1+00

US 31W

US 31W

0+00

**BEGIN CONSTRUCTION  
MILEPOINT 14.511  
STATION 0+00**

**LEGEND**

-  FULL DEPTH CONCRETE PATCHING
-  CURB REPLACEMENT

MP 14.5

SCALE 1"=20'

US 31W  
DETAIL SHEETS  
SHEET 1 OF 19



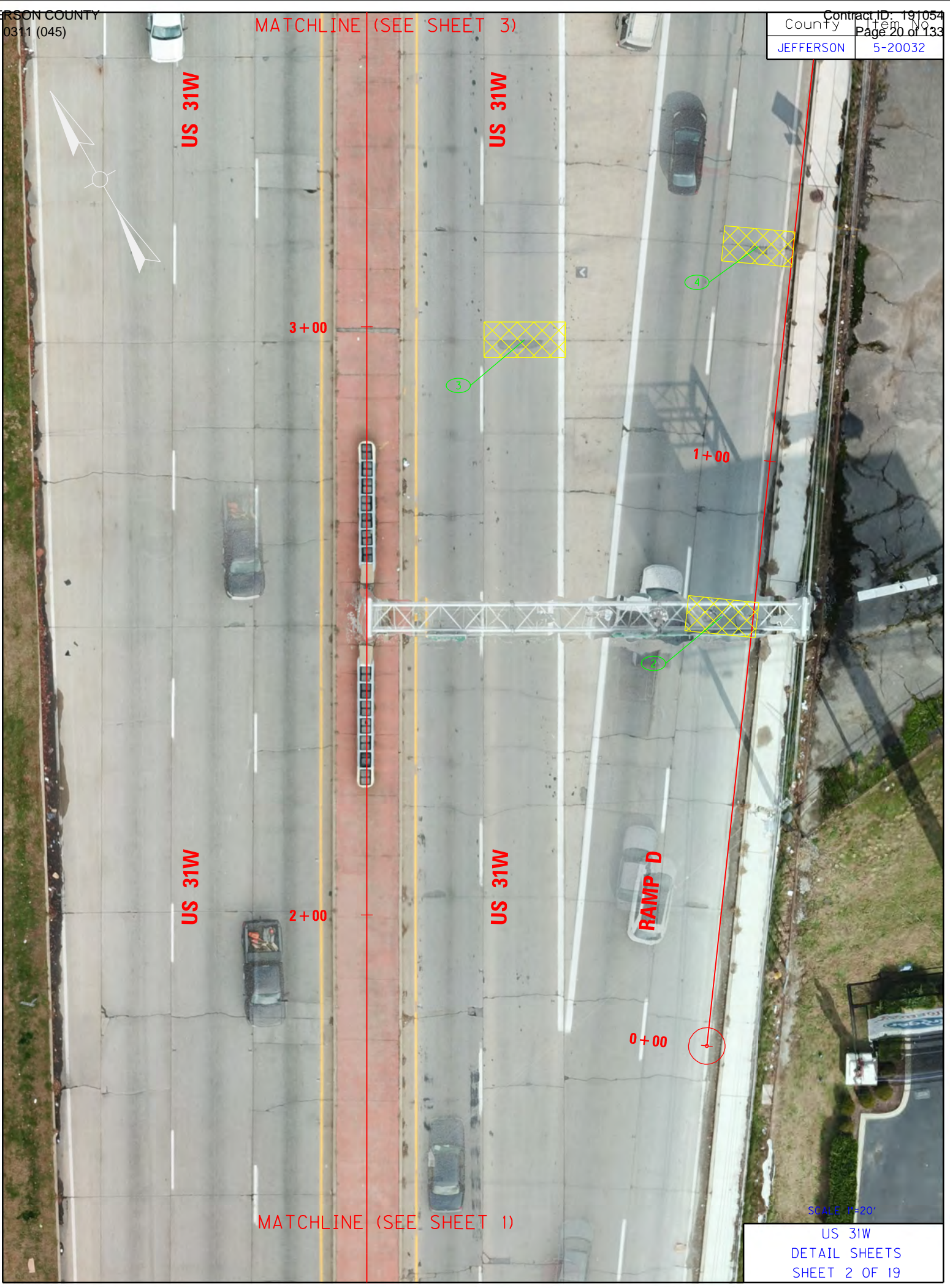



MP 14.6

US 31W

US 31W

5+00

4+00

END CONSTRUCTION  
RAMP D  
STATION 2+58

REPLACE INTEGRAL CURB

REPLACE INTEGRAL CURB

RAMP D

2+58

2+00

SCALE 1"=20'

MATCHLINE (SEE SHEET 2)

US 31W  
DETAIL SHEETS  
SHEET 3 OF 19



County	JEFFERSON
Item No	5-20032

MATCHLINE (SEE SHEET 5)

2+00

6

2+52

RAMP A

US 31W

7+00

US 31W

5

6+00

MATCHLINE (SEE SHEET 3)

SCALE 1"=20'

US 31W  
DETAIL SHEETS  
SHEET 4 OF 19

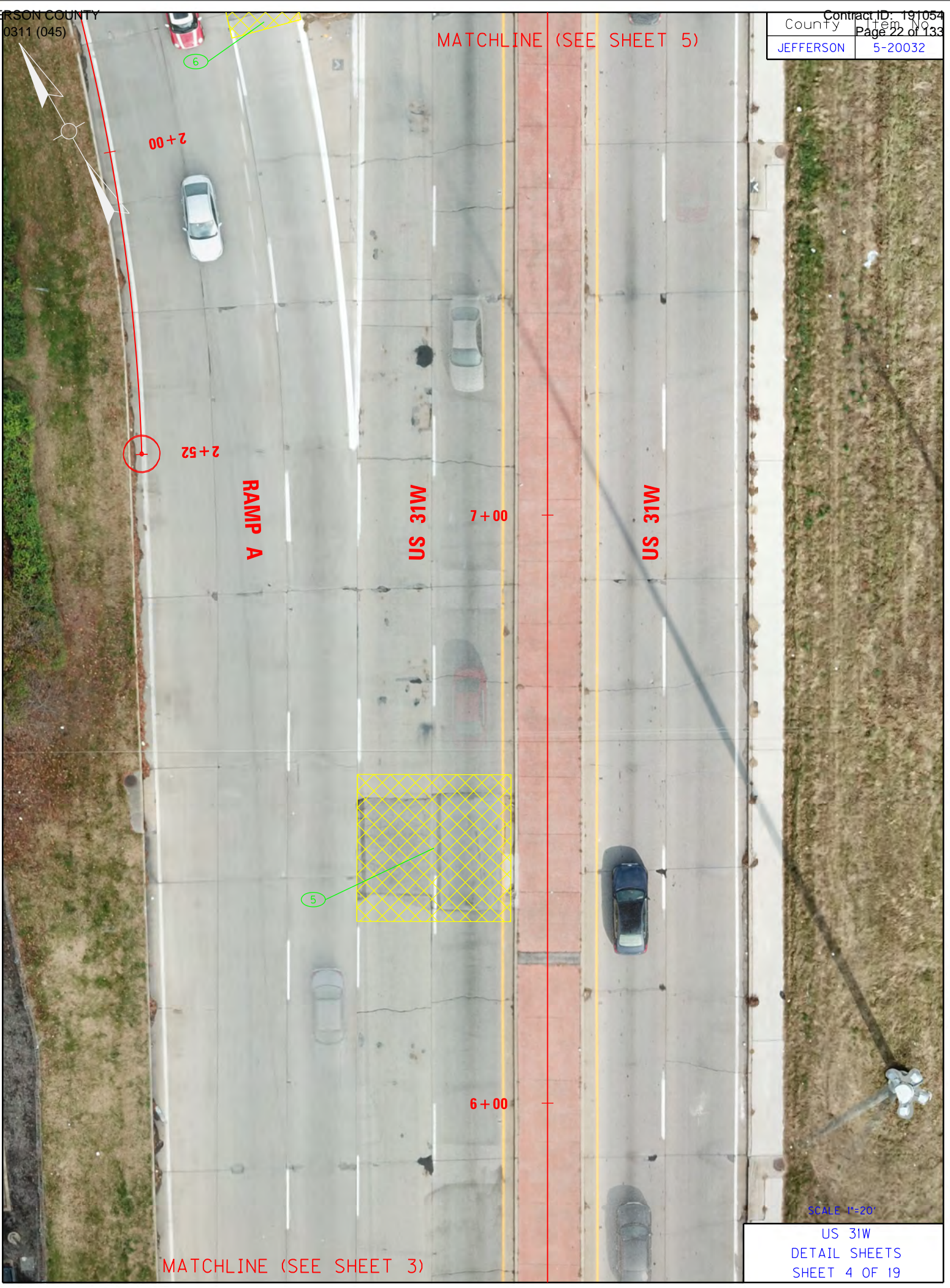



MP 14.7 MATCHLINE (SEE SHEET 6)

10+00

Contract ID: 191054
County Item No: 1933
JEFFERSON 5-20032



US 31W

US 31W

9+00

REPLACE INTEGRAL CURB

8

RAMP A

US 31W

US 31W

7

8+00

MATCHLINE (SEE SHEET 4)

SCALE 1"=20'

6

US 31W  
DETAIL SHEETS  
SHEET 5 OF 19



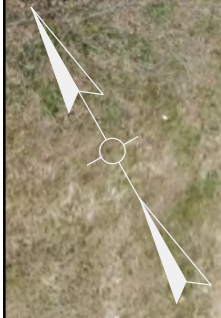

12+00

US 31W

US 31W

2+00

RAMP E

REPLACE INTEGRAL CURB

11+00

MATCHLINE  
(SEE SHEET 5)

SCALE 1"=20'

US 31W  
DETAIL SHEETS  
SHEET 6 OF 19

11

10

12



MATCHLINE (SEE SHEET 8)

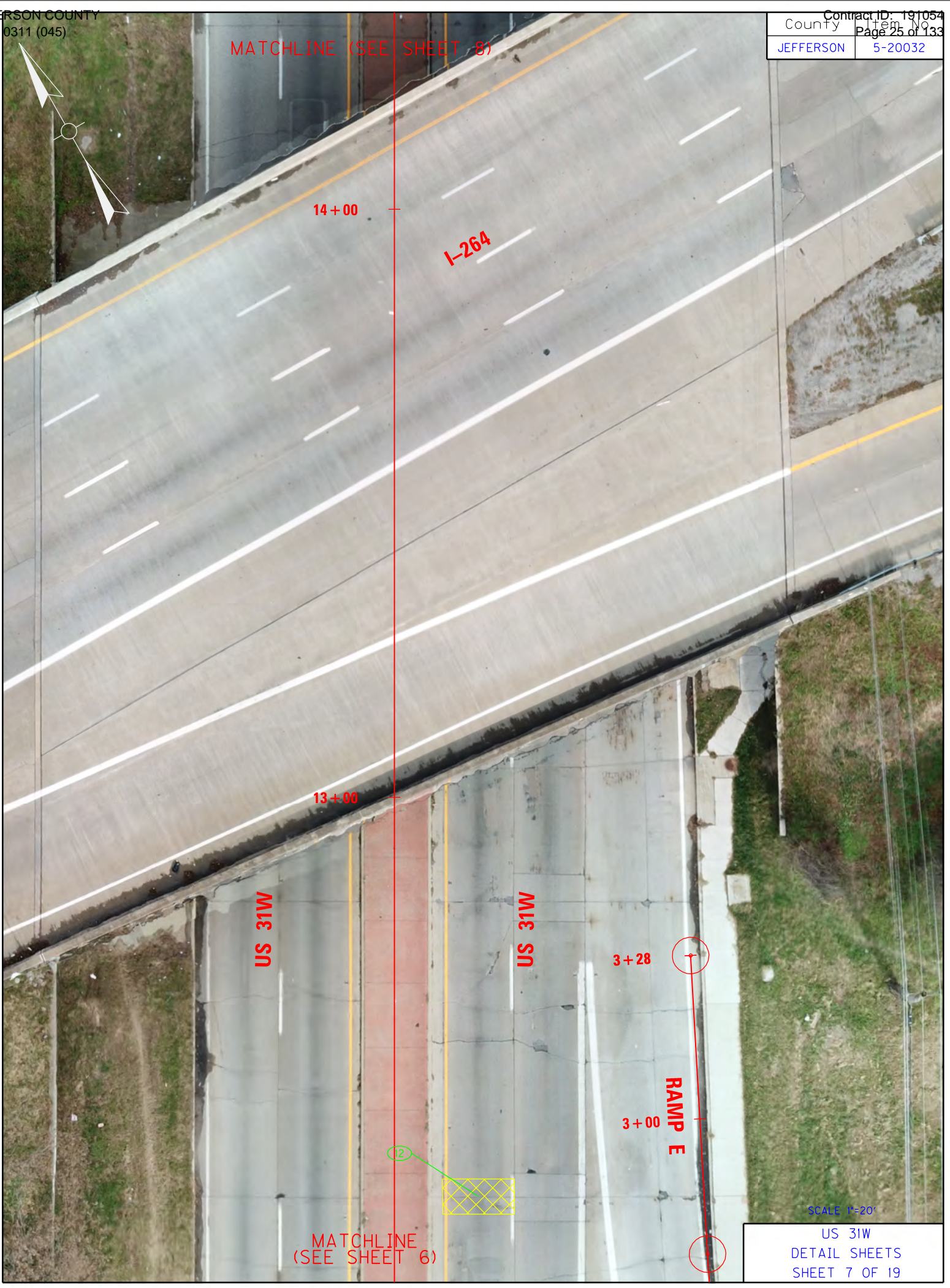

14+00

I-264

13+00

US 31W

US 31W

3+28

3+00

RAMP E

12

MATCHLINE  
(SEE SHEET 6)

SCALE 1"=20'

US 31W  
DETAIL SHEETS  
SHEET 7 OF 19



MATCHLINE (SEE SHEET 9)



MP 14.8

US 31W

US 31W

16+00

15+00

13

15

14

REPLACE INTEGRAL CURB

SCALE 1"=20'

US 31W  
DETAIL SHEETS  
SHEET 8 OF 19

MATCHLINE (SEE SHEET 7)



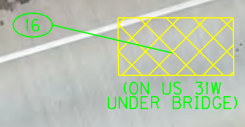

US 31W  
16+00

US 31W

I-264

17+00



RAMP B  
4+00

MP 14.9

US 31W  
20+00

US 31W

RAMP C

REPLACE INTEGRAL CURB

19+00

MATCHLINE (SEE SHEET 9)

SCALE 1"=20'

US 31W  
DETAIL SHEETS  
SHEET 10 OF 19



MATCHLINE (SEE SHEET 12)

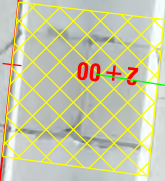
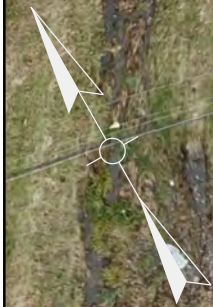

18

17

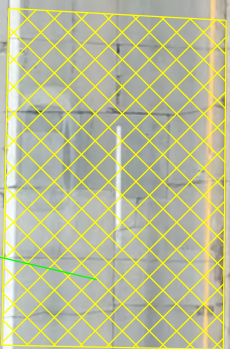

RAMP B

00+8

22+00

US 31W

US 31W

21+00

REPLACE INTEGRAL CURB

MATCHLINE (SEE SHEET 10)

SCALE 1"=20'

US 31W  
DETAIL SHEETS  
SHEET 11 OF 19





MATCHLINE  
(SEE SHEET 11)

SCALE 1"=20'

US 31W  
DETAIL SHEETS  
SHEET 12 OF 19





**END CONSTRUCTION  
MILEPOINT 14.999  
STATION 25+76**

**MP 15.0**

**25+76**

**MATCHLINE (SEE SHEET 12)**

SCALE 1"=20'

US 31W  
DETAIL SHEETS  
SHEET 13 OF 19





**BEGIN CONSTRUCTION  
RAMP A  
STATION 0+00**

SCALE 1"=20'





5+00

RAMP B

RAMP B

4+00

MP 14.9

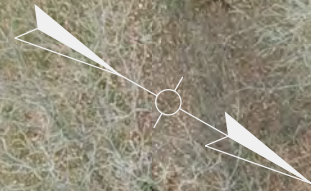

MATCHLINE  
(SEE SHEET 11)

SCALE 1"=20'

US 31W - RAMP B  
DETAIL SHEETS  
SHEET 15 OF 19



County	JEFFERSON
Item No	5-20032

MATCHLINE (SEE SHEET 17)



7+00

**RAMP B**

6+00

MATCHLINE (SEE SHEET 15)

SCALE 1"=20'

US 31W - RAMP B  
DETAIL SHEETS  
SHEET 16 OF 19





9+00



**RAMP B**

8+00

MATCHLINE  
(SEE SHEET 16)

SCALE: 1"=20'

US 31W - RAMP B  
DETAIL SHEETS  
SHEET 17 OF 19





**END CONSTRUCTION  
RAMP B  
STATION 11+36**

**MATCHLINE (SEE SHEET 17)**

SCALE 1"=20'

US 31W - RAMP B  
DETAIL SHEETS  
SHEET 18 OF 19





MATCHLINE  
(SEE SHEET 6)

RAMP E

1+00

RAMP E

0+00

**BEGIN CONSTRUCTION  
RAMP E  
STATION 0+43**



SCALE 1"=20'

US 31W - RAMP E  
DETAIL SHEETS  
SHEET 19 OF 19



# PROPOSED TYPICAL SECTIONS

## US 31W

County	Item No.	Sheet
JEFFERSON	5-20032.00	-

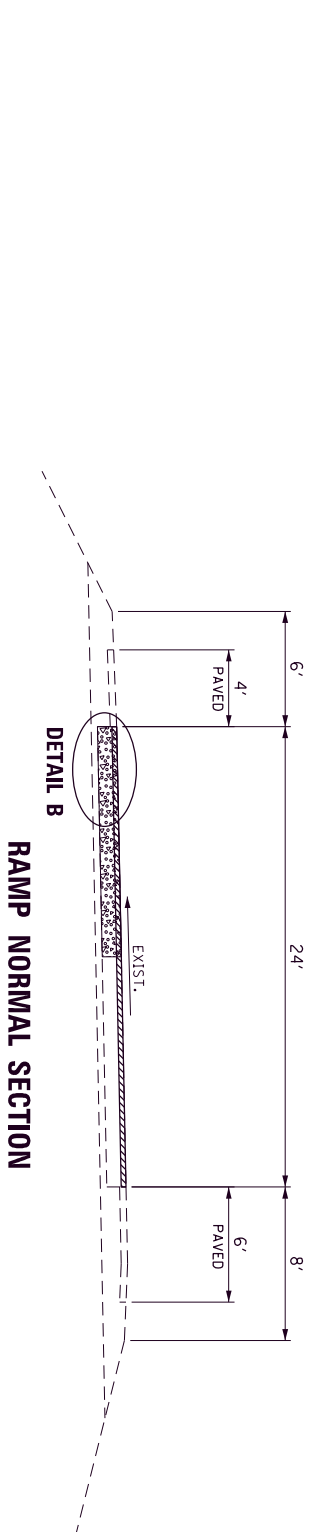
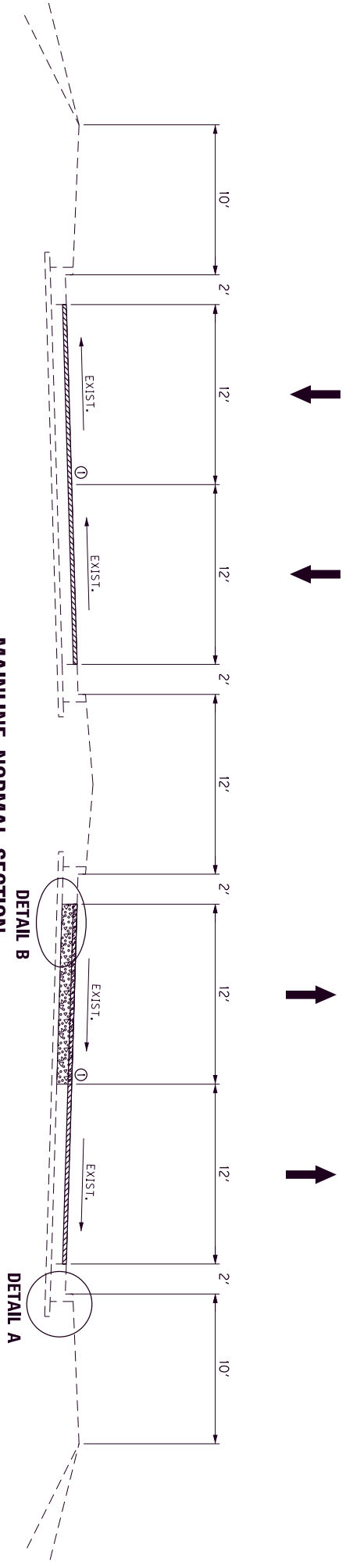

### SURFACING SCHEDULE

#### MAINLINE AND RAMP TRAFFIC LANES

POLYMER MODIFIED PARTIAL DEPTH PATCHING.....DEPTH VARIES ①  
OR JPC PAVEMENT-9 IN.....9" REM & REPLACE ②

POLYMER MODIFIED PARTIAL DEPTH PATCHING TO BE CONSTRUCTED AT LOCATIONS DIRECTED BY THE ENGINEER. SEE SPECIAL NOTE FOR POLYMER MODIFIED PARTIAL DEPTH PATCHING FOR INSTALLATION AND MATERIALS DETAILS. LOCATIONS TO BE DETERMINED IN THE FIELD BY THE ENGINEER. MINIMUM PATCHING DEPTH IS 2", MINIMUM PATCH WIDTH IS 8".

FULL DEPTH CONCRETE PAVEMENT REPAIR TO BE PERFORMED IN ACCORDANCE WITH SPECIAL NOTE III AT LOCATIONS LISTED OR AS DIRECTED BY THE ENGINEER. THE ENGINEER RESERVES THE RIGHT TO MODIFY REPAIR LOCATIONS SIZES, AND ADD OR REMOVE PROPOSED REPAIR LOCATIONS.

WARNING: THIS PAVEMENT CONTAINS STEEL REINFORCEMENT. THE CONTRACTOR WILL BE RESPONSIBLE FOR PROVIDING A METHOD OF REMOVAL OF THE EXISTING UNSOUND CONCRETE TO THE DEPTH REQUIRED REGARDLESS OF THE DEPTH OF REINFORCEMENT AND MAY REQUIRE REMOVAL OF THE REINFORCEMENT. SAW CUT AROUND THE PERIMETER OF A PATCHING TO THE DEPTH OF THE PROPOSED PATCH TO CUT ANY REINFORCEMENT THAT IS WITHIN THE DEPTH OF THE PATCH TO ENSURE THAT CONCRETE REMOVAL DOES NOT FULL REINFORCEMENT THROUGH THE CONCRETE OUTSIDE THE LIMITS OF THE PATCH.

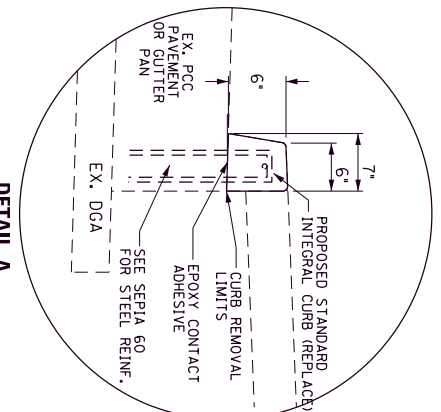
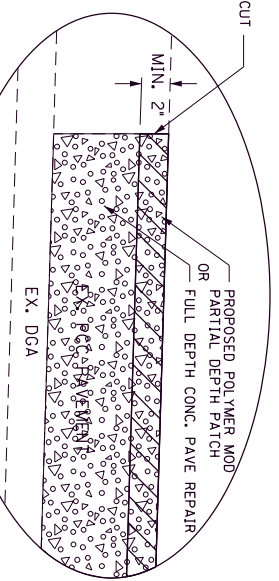

US 31W  
TYPICAL SECTIONS

**US 31W  
JEFFERSON COUNTY  
ITEM NO. 5-20032, PAVEMENT REHABILITATION  
MILEPOST 14.511 TO MILEPOST 14.999  
GENERAL SUMMARY**

ITEM NUMBER	ITEM	UNIT	QUANTITY
0001	DGA BASE ①	TONS	50
24997EC	PARTIAL DEPTH PATCHING-POLYMER MOD ①	CU FT	750
2073	JPC PAVEMENT-9 IN ①	SQ YD	1,632
2058	REMOVE PCC PAVEMENT ①	SQ YD	1,632
2115	SAW-CLEAN-RESEAL TVERSE JOINT ①	LIN FT	7,250
2116	SAW-CLEAN-RESEAL LONGIT JOINT ①	LIN FT	17,500
21173EC	SAW-CLEAN-RESEAL RANDOM CRACKS ①	LIN FT	2,700
190	LEVELING AND WEDGING PG64-22 ①	TONS	200
1830	STANDARD INTEGRAL CURB ②	LIN FT	82
1904	REMOVE CURB ②	LIN FT	82
2014	BARRICADE - TYPE III	EACH	12
2562	TEMPORARY SIGNS	SQ FT	1,000
2650	MAINTAIN AND CONTROL TRAFFIC	LP SUM	1
2654	TRUCK MOUNTED ATTENUATOR	EACH	2
2671	PORTABLE CHANGEABLE MESSAGE SIGN	EACH	4
2775	ARROW PANEL	EACH	2
6401	FLEXIBLE DELINEATOR POST-M/W	EACH	45
6404	FLEXIBLE DELINEATOR POST-M/Y	EACH	30
6511	PAVE STRIPING TEMP PAINT - 6 IN	LIN FT	4,070
6568	PAVE MARKING-THERMO STOP BAR-24IN	LIN FT	24
6589	PAVEMENT MARKER TYPE V-MW	EACH	25
6590	PAVEMENT MARKER TYPE V-MY	EACH	5
6600	REMOVE PAVEMENT MARKER TYPE V	EACH	30
6556	PAVE STRIPING-DUR TY1-6 IN W	LIN FT	12,650
6557	PAVE STRIPING-DUR TY1-6 IN Y	LIN FT	6,010
6560	PAVE STRIPING-DUR TY1-12 IN W	LIN FT	1,690
24679ED	PAVE MARKING THERMO CHEVRON	SQ FT	260
2726	STAKING	LP SUM	1
2569	DEMOBILIZATION	LP SUM	1

- ① CARRIED OVER FROM PAVING SUMMARY
- ② CARRIED OVER FROM CURB REMOVAL AND REPLACEMENT SUMMARY





US 31 W INTEGRAL CURB REMOVAL AND REPLACEMENT				
LOCATION	BEGINNING STATION	END STATION	LENGTH	REMARKS
Ramp D	2+46	2+57	11	
ML NB Median	4+68	4+73	5	
ML NB Rt	8+67	8+99	32	
ML NB Rt	11+66	11+68	14	Ramp E Entrance Gore
ML NB Rt	14+58	14+63	5	
ML NB Rt	21+47	21+53	6	
ML SB Median	19+38	19+47	9	
Total			82	

ITEMS TO BID:

1904 REMOVE CURB	82	LF
1830 STANDARD INTEGRAL CURB	82	LF

NOTE: Measurement and payment for this work will be based on the measured linear feet of "Remove Curb" and "Standard Integral Curb". All other required work including preparation and forming, epoxy contact adhesive, drilling and grouting and furnishing steel reinforcement, etc. will be considered incidental. Remove curb by methods to protect and reuse existing steel reinforcement if possible. Replace damaged steel by drilling and grouting by methods approved by the engineer, in accordance with Sepia 60 incidental to the item "Standard Integral Curb".

Restoration of the earth berm behind the curb, including seeding and protection, will be considered incidental to Standard Integral Curb. Do no disturb existing adjacent pavement or sidewalks.

The engineer reserves the right to modify lengths, modify locations, add, delete segments of curb removal and replacement.

# OVERHEAD SIGN CLEARANCE

US 31W  
SIGN TRUSS - EXIT RAMP  
M.P. 14.556

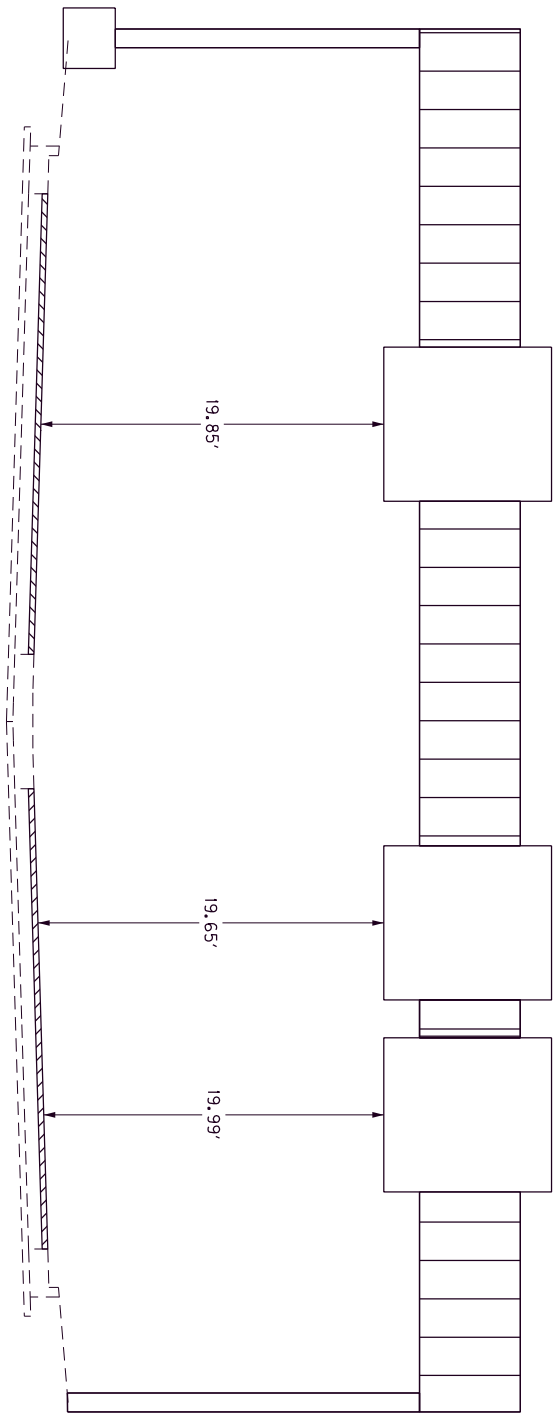

County	Item No.	Sheet
JEFFERSON	5-20032.00	-

US 31W  
BRIDGE CLEARANCE

# BRIDGE CLEARANCE

I-264 OVER US 31W  
EASTBOUND  
M.P. 14.768

County	Item No.	Sheet
JEFFERSON	5-20032.00	-

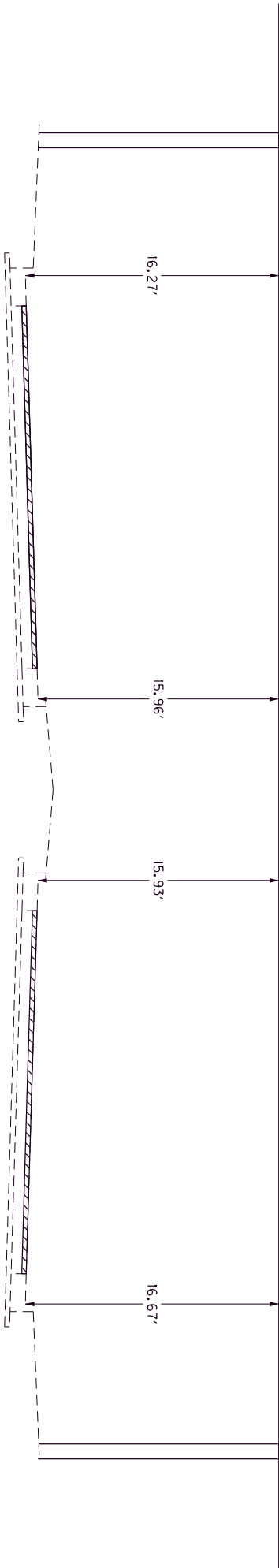

US 31W  
BRIDGE CLEARANCE



# BRIDGE CLEARANCE

I-264 OVER US 31W  
WESTBOUND TO SOUTHBOUND  
M.P. 14.831

County	Item No.	Sheet
JEFFERSON	5-20032.00	-

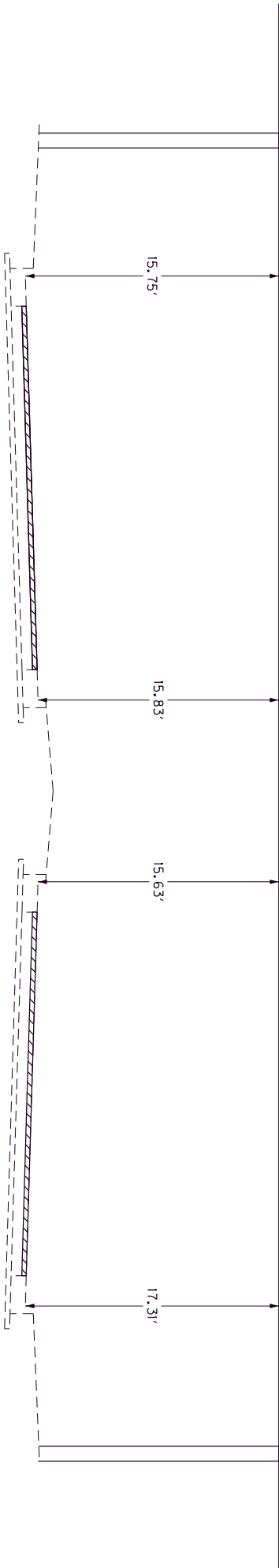

US 31W  
BRIDGE CLEARANCE

# BRIDGE CLEARANCE

I-264 OVER US 31W

I-264

M.P. 14.847

County	Item No.	Sheet
JEFFERSON	5-20032.00	-

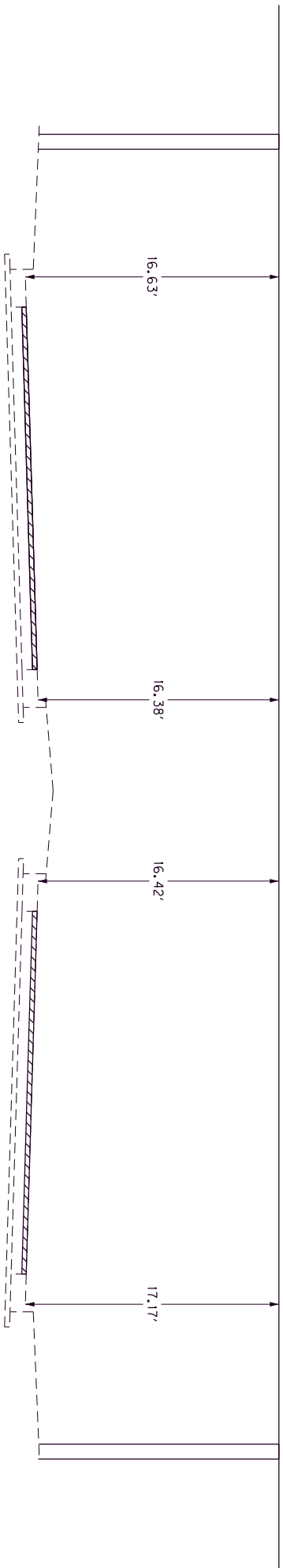

US 31W  
BRIDGE CLEARANCE

# BRIDGE CLEARANCE

I-264 OVER US 31W  
NORTHBOUND TO EASTBOUND  
M.P. 14.857

County	Item No.	Sheet
JEFFERSON	5-20032.00	-

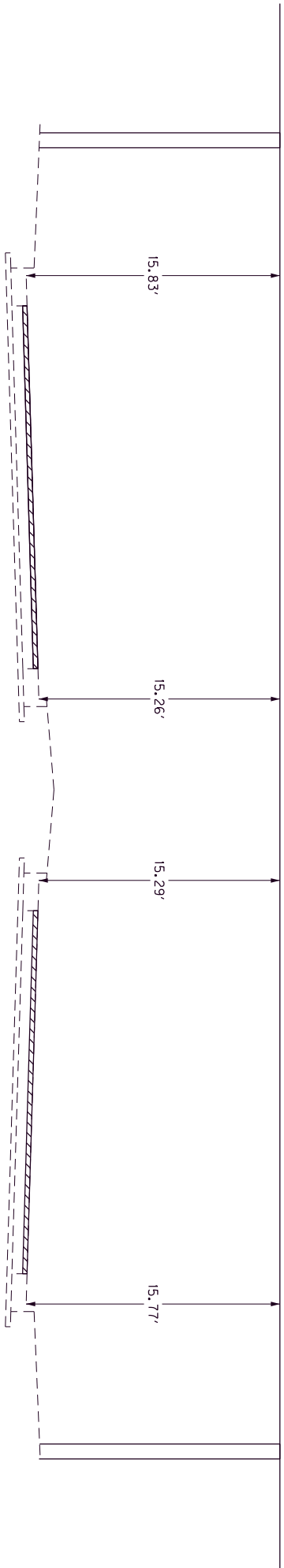

US 31W  
BRIDGE CLEARANCE

COUNTY OF	ITEM NO.	SHEET NO.
JEFFERSON	5-20032100	-

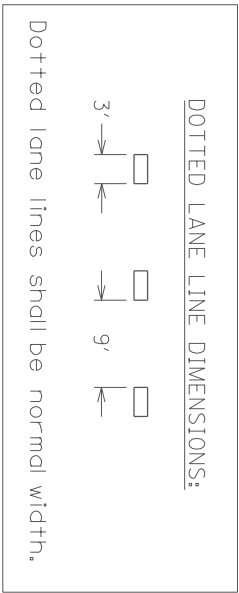
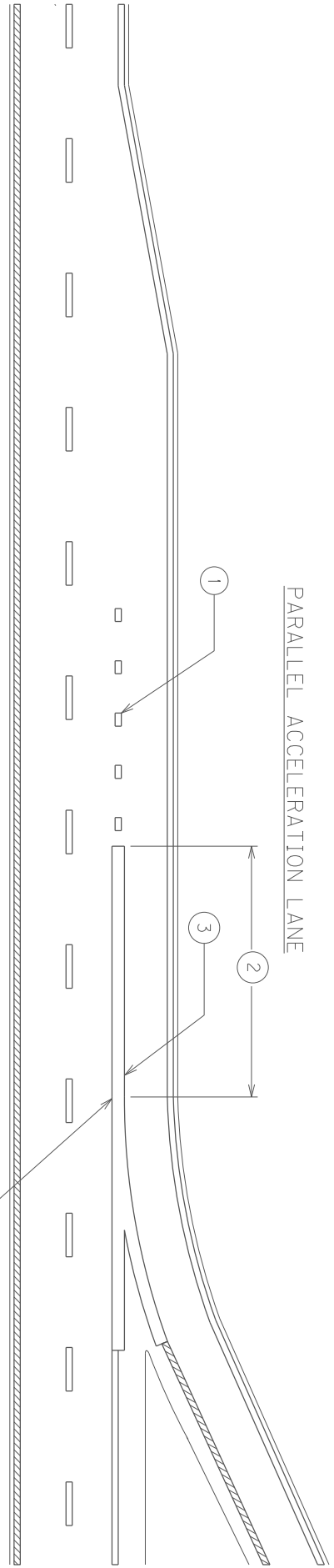

DOTTED LANE LINE DIMENSIONS:



Dotted lane lines shall be normal width.

- 1 IN A PARALLEL ACCELERATION LANE, DOTTED LANE LINES SHALL BE INSTALLED FOR AT LEAST HALF THE LENGTH OF THE FULL-WIDTH ACCELERATION LANE PLUS TAPER MEASURED FROM THE THEORETICAL GORE. DOTTED EXTENSIONS MAY BE INSTALLED THROUGH THE TAPER IF DESIRED.
- 2 WIDE SOLID LINE SHALL EXTEND DOWNSTREAM FROM THE THEORETICAL GORE FOR AT LEAST 1/4 THE LENGTH OF THE FULL-WIDTH ACCELERATION LANE PLUS TAPER.
- 3 12" WIDE SOLID WHITE CHANNELLIZATION LINES.
- 4 GORE AREA CHEVRON MARKINGS ARE OPTIONAL ON ENTRANCE RAMP. SEE SEP1A 008 FOR DETAILS ON CHEVRON MARKINGS.
- 5 IN A TAPERED ACCELERATION LANE, DOTTED EXTENSIONS MAY BE INSTALLED AS SHOWN.

LEGEND	
MARKINGS	WHITE
MARKINGS	YELLOW

DRAWING NOT TO SCALE

**KENTUCKY**  
**DEPARTMENT OF HIGHWAYS**

TYPICAL ENTRANCE RAMP MARKINGS FOR INTERSTATES AND PARKWAYS

SUBMITTED *R. Allen Wolfe* 8-23-18 DATE  
039

PARALLEL DECELERATION LANE

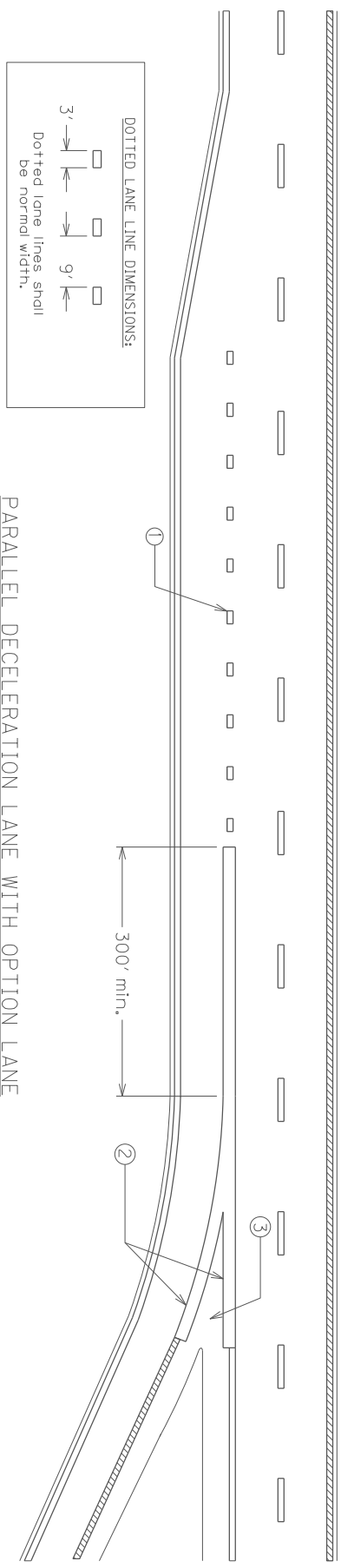

PARALLEL DECELERATION LANE WITH OPTION LANE

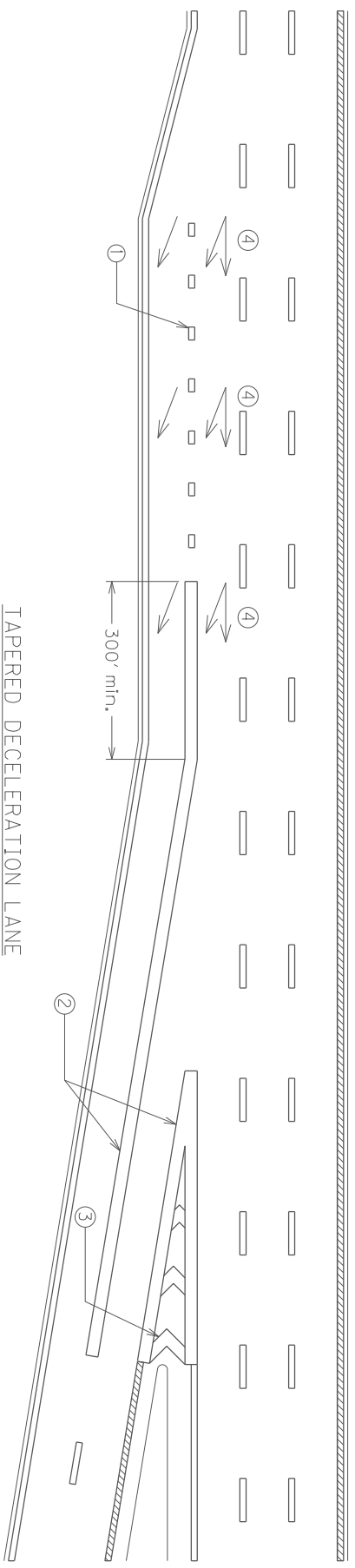

TAPERED DECELERATION LANE

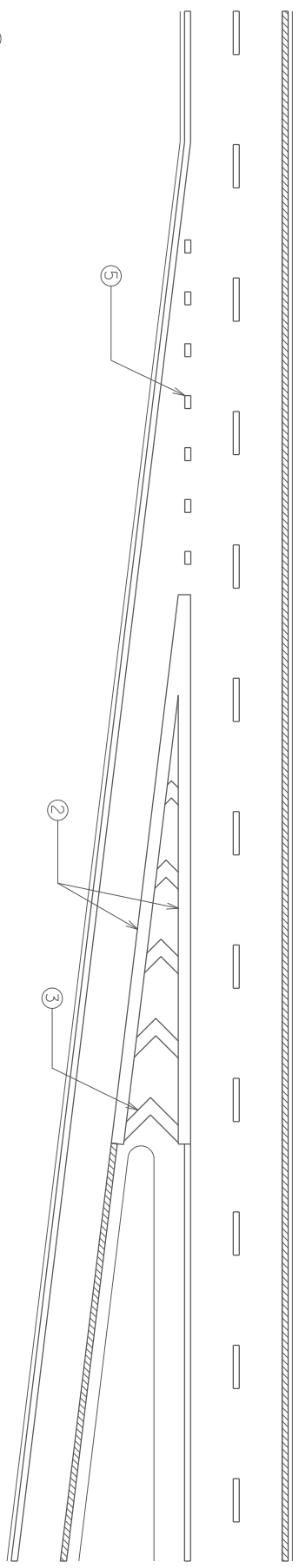

- ① NORMAL WIDTH DOTTED LANE LINES SHALL BE USED ALONG THE FULL-WIDTH SECTION OF A PARALLEL DECELERATION LANE. IF DESIRED, EXTENSION LINES MAY BE USED ALONG THE TAPER.
- ② 12" WIDE SOLID CHANNELIZATION LINE.
- ③ GORE AREA CHEVRON MARKINGS SHOULD BE USED IN ACCORDANCE WITH SEPIA 045.
- ④ LANE USE ARROWS MAY BE USED WHEN THERE IS AN OPTION LANE. IF USED, A MINIMUM OF THREE ARROWS PER LANE SHOULD BE PLACED AT APPROXIMATELY 1/4 MILE.
- ⑤ FOR TAPERED DECELERATION LANES, DOTTED EXTENSIONS MAY BE INSTALLED AS SHOWN.

DRAWING NOT TO SCALE

LEGEND	
	WHITE MARKINGS
	YELLOW MARKINGS

**KENTUCKY**  
**DEPARTMENT OF HIGHWAYS**  
TYPICAL EXIT RAMP MARKINGS FOR INTERSTATES AND PARKWAYS

SUBMITTED *R. Gillispie* 11-30-18  
Page 1 of 2 DATE 040



SINGLE-LANE LANE DROP

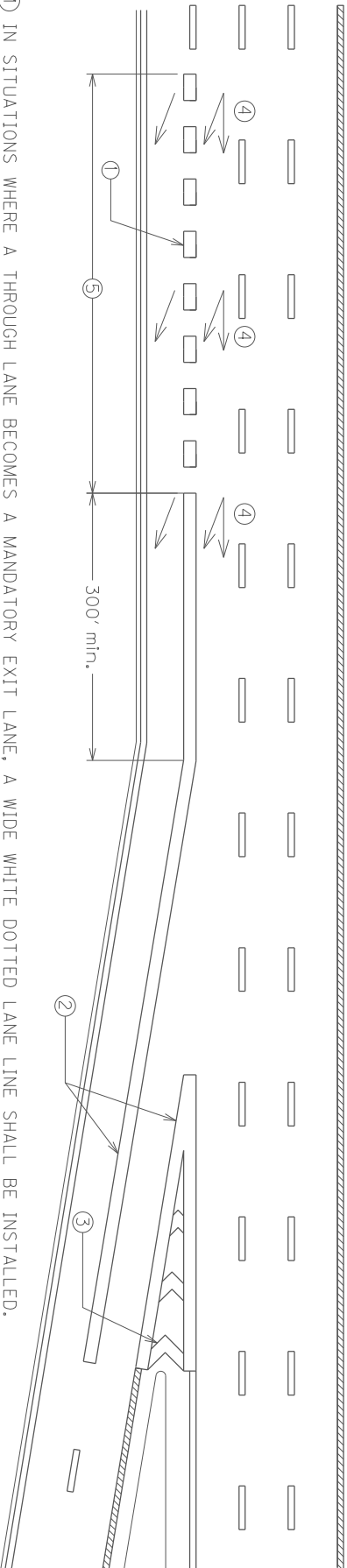
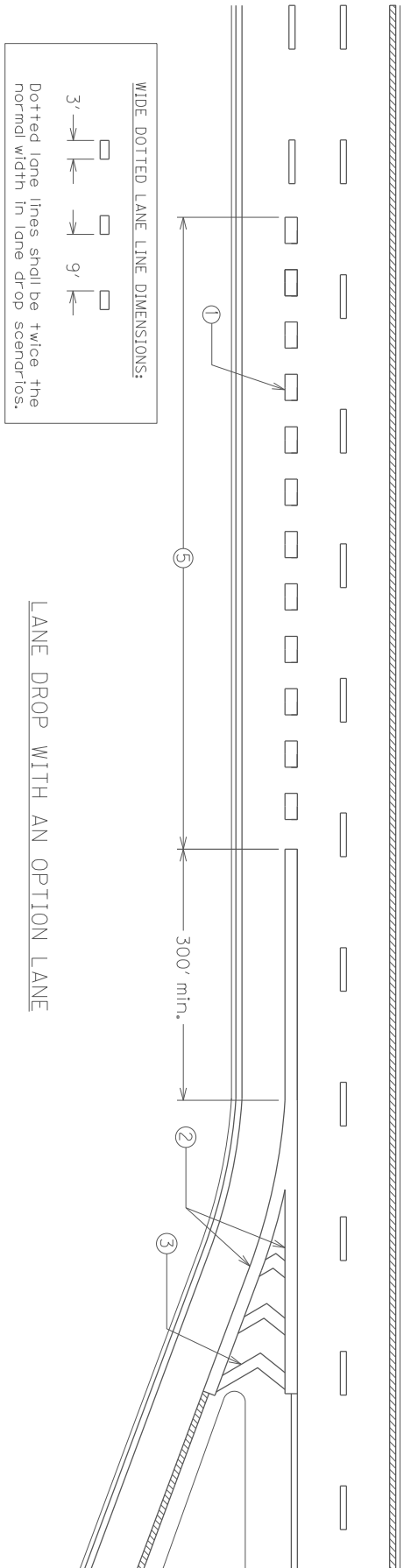

- ① IN SITUATIONS WHERE A THROUGH LANE BECOMES A MANDATORY EXIT LANE, A WIDE WHITE DOTTED LANE LINE SHALL BE INSTALLED.
- ② 12" WIDE SOLID CHANNELIZATION LINE.
- ③ GORE AREA CHEVRON MARKINGS SHALL BE USED IN LANE DROP SCENARIOS AND WHERE AN INTERSTATE OR PARKWAY SPLITS. SEE SEPIA 045 FOR DETAILS ON GORE AREA CHEVRON MARKINGS.
- ④ LANE USE ARROWS MAY BE USED WHEN THERE IS AN OPTION LANE. A MINIMUM OF THREE ARROWS PER LANE SHOULD BE PLACED AS SHOWN AND SPACED AT APPROXIMATELY 1/4 MILE.
- ⑤ DOTTED LANE LINES SHOULD EXTEND BACK AN APPROXIMATE DISTANCE OF 1/2 MILE FROM THE THEORETICAL GORE.

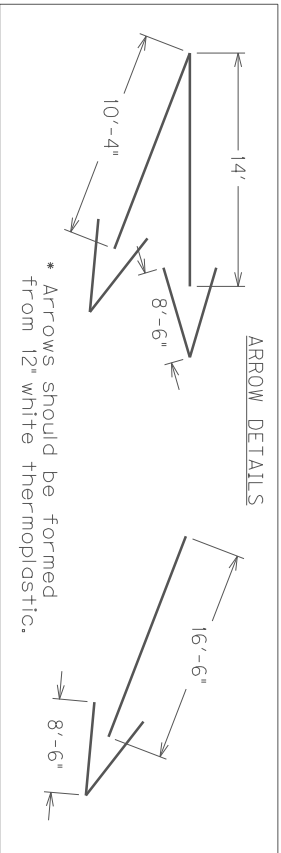

DRAWING NOT TO SCALE

LEGEND	
	WHITE
	YELLOW

**KENTUCKY**  
**DEPARTMENT OF HIGHWAYS**

TYPICAL EXIT RAMP MARKINGS FOR INTERSTATES AND PARKWAYS

7-9-18

Submitted: *R. Gifford* DATE: 11-30-18

Page 2 of 2 041

COUNTY OF	ITEM NO.	SHEET NO.
JEFFERSON	5-20032100	-

Single turn lane

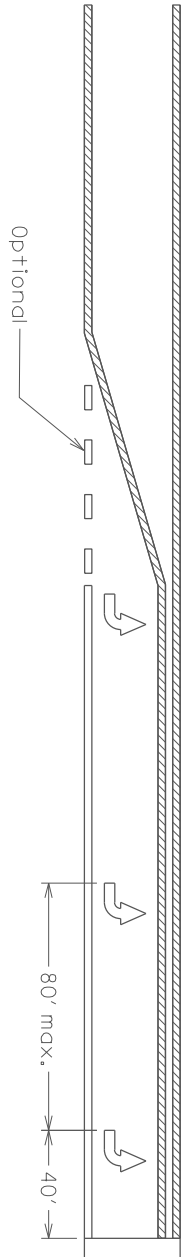

Dual turn lane

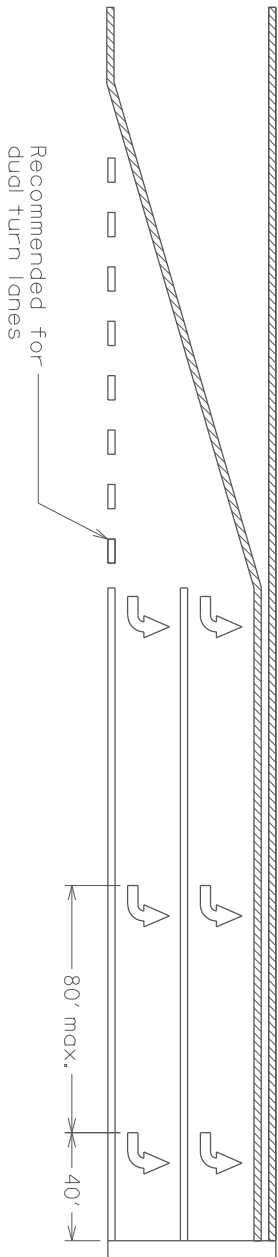

Offset turn lane

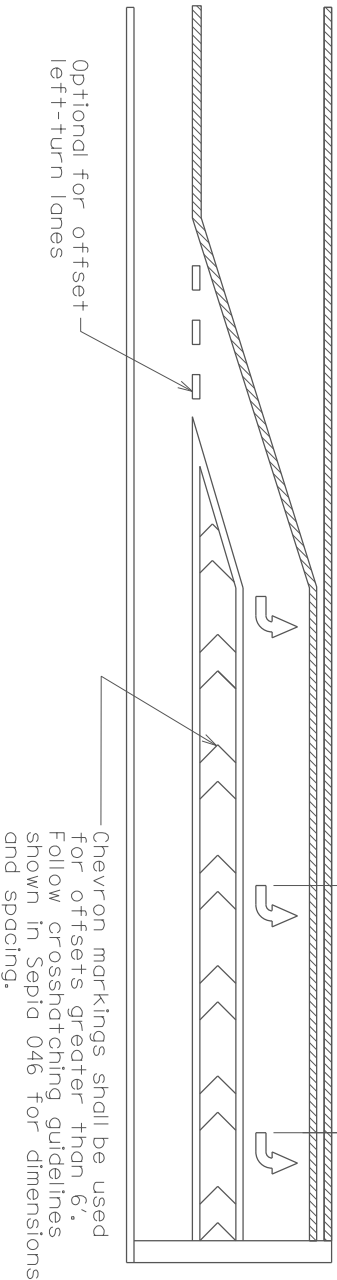

STRIPING NOTES:

- ARROWS SHALL BE USED IN ANY EXCLUSIVE TURN LANES.
- IN A SINGLE TURN LANE, DOTTED WHITE LANE LINE EXTENSIONS MAY BE USED THROUGH THE TAPER OF THE TURN LANE.
- IF USED, DOTTED WHITE LANE LINE EXTENSIONS SHALL BE NORMAL WIDTH, AND SHOULD BE 2' LONG, WITH A GAP OF 2-6' BETWEEN EACH LINE.
- IN DUAL TURN LANES, DOTTED WHITE LANE LINE EXTENSIONS SHOULD BE USED THROUGH THE TAPER OF THE TURN LANE. BOTH SOLID LINES FORMING THE TURN LANES SHALL BEGIN AT THE DOWNSTREAM END OF THE TAPER.

ARROW SPACING NOTES:

- IN SINGLE-DIRECTION TURN LANES, ARROWS SHOULD BE SPACED AS FOLLOWS:
- AT LEAST TWO ARROWS SHOULD BE USED IN EACH TURN LANE. HOWEVER, IF A TURN LANE IS LESS THAN 80' IN LENGTH, THE DOWNSTREAM ARROW MAY BE ELIMINATED.
- THE FIRST UPSTREAM ARROW SHALL BE PLACED AT THE BEGINNING OF THE SOLID LINE FOR THE TURN LANE.
- THE LAST DOWNSTREAM ARROW SHOULD BE PLACED 40' FROM THE STOP BAR.
- ANY ADDITIONAL ARROWS SHOULD BE EVENLY SPACED. SPACING SHOULD NOT EXCEED 80'.
- ARROW SPACING AND NUMBER OF ARROWS MAY VARY BASED ON SITE CONDITIONS.

DOTTED EXTENSION DIMENSIONS:



Dotted extensions shall be normal width.

DRAWING NOT TO SCALE

LEGEND	
	WHITE MARKINGS
	YELLOW MARKINGS

KENTUCKY  
DEPARTMENT OF HIGHWAYS  
TYPICAL MARKINGS  
FOR TURN LANES

SUBMITTED *R. Allen Wolfe* 11-30-18  
DATE

COUNTY OF	ITEM NO.	SHEET NO.
JEFFERSON	5-20032100	-



Lane drop scenario

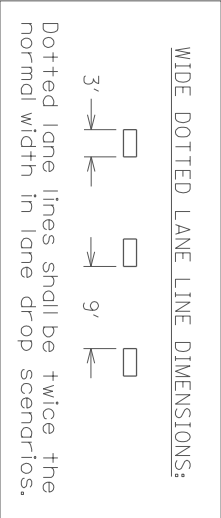
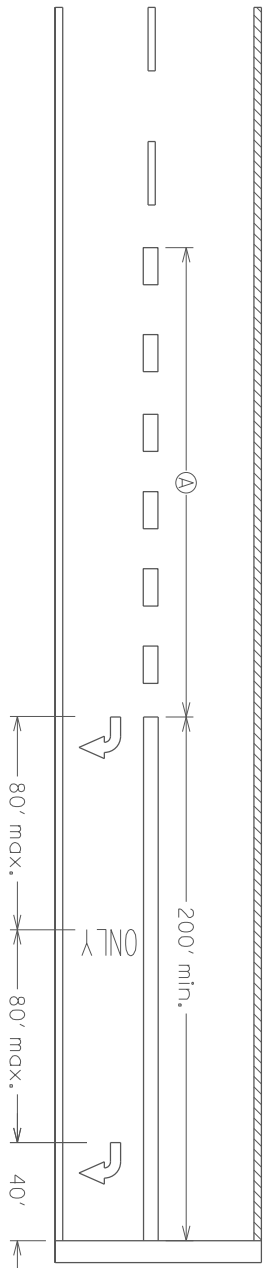

Speed Limit	(A)
25	125'
35	245'
45	540'
55	660'
65	780'

Two-way left-turn lane

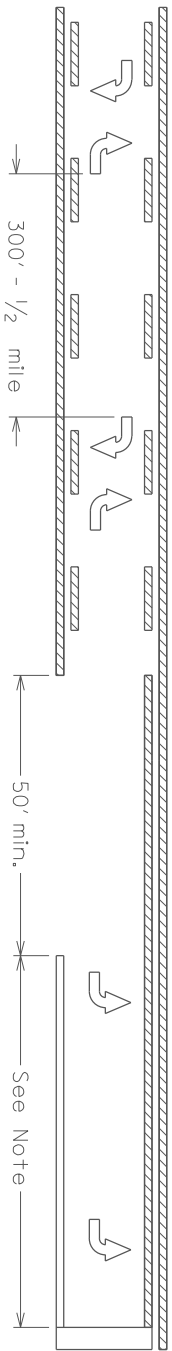

TWTL ARROW DETAILS:

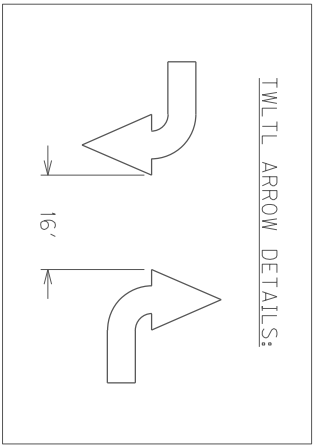

LANE DROP MARKINGS NOTES:

IN SITUATIONS WHERE A THROUGH LANE BECOMES A MANDATORY TURN LANE, THE FOLLOWING GUIDELINES APPLY:  
 - A WIDE SOLID LINE SHOULD EXTEND BACK A MINIMUM OF 200' FROM THE STOP BAR.  
 - A WIDE, DOTTED LINE SHALL EXTEND FROM THE END OF THE SOLID LINE BACK A MINIMUM OF THE DISTANCE SHOWN IN THE CHART (A). THESE LINES SHALL BE 3' LONG, WITH A SPACE OF 9' BETWEEN LINES.  
 - ALTERNATING ARROWS AND "ONLY" WORD MESSAGES SHALL BE USED, WITH THE FIRST AND LAST MARKING BEING AN ARROW.  
 - ALTERNATING ARROWS AND "ONLY" WORD MESSAGES SHOULD BE SPACED EVENLY, FOLLOWING GUIDELINES FOR ARROW SPACING. THESE SYMBOLS SHALL EXTEND BACK AT LEAST TO THE END OF THE SOLID STRIPE, BUT MAY BE EXTENDED BACK FARTHER IF ADDITIONAL GUIDANCE IS NEEDED.

TWO-WAY LEFT-TURN LANE NOTES:

IN A TWO-WAY LEFT-TURN LANE, THE FOLLOWING GUIDELINES APPLY:  
 - ONE SET OF ARROWS SHOULD BE PLACED AT OR NEAR THE BEGINNING OF THE TWO-WAY LEFT-TURN LANE.  
 - ADDITIONAL SETS OF ARROWS SHOULD BE PLACED THROUGHOUT THE TWO-WAY LEFT-TURN LANE IF LEFT TURN MOVEMENTS ARE EXPECTED. THEY SHOULD BE SPACED NO LESS THAN 300' AND NO MORE THAN 1/2 MILE.  
 - THE SPACING BETWEEN EACH ARROW IN A SINGLE ARROW SET SHOULD BE 16 FEET.  
 - TWO-WAY LEFT-TURN LANES SHALL TERMINATE IN A DEDICATED LEFT-TURN LANE AT A SIGNALIZED INTERSECTION. THEY MAY TERMINATE IN A DEDICATED LEFT-TURN LANE AT OTHER LOCATIONS IF DEEMED NECESSARY.  
 - CONTACT TRAFFIC ENGINEER FOR RECOMMENDED DISTANCE FOR LEFT TURN STORAGE AT INTERSECTIONS.  
 - REFER TO THE TRAFFIC OPERATIONS GUIDANCE MANUAL SECTION TO-504 FOR MORE GUIDANCE ON TWO-WAY LEFT-TURN LANES.

DRAWING NOT TO SCALE

**LEGEND**

	MARKINGS	WHITE
	MARKINGS	YELLOW

**KENTUCKY**  
**DEPARTMENT OF HIGHWAYS**  
 TYPICAL MARKINGS  
 FOR TURN LANES

STOP LINE NOTES

1. STOP LINES SHALL BE 24" WHITE AND SHALL EXTEND ACROSS ALL APPROACH LANES.
2. STOP LINES SHOULD BE PLACED A MINIMUM OF 4' IN ADVANCE OF THE NEAREST EDGE OF A MARKED CROSSWALK. IN THE ABSENCE OF A MARKED CROSSWALK, STOP LINES SHOULD BE PLACED NO MORE THAN 30' OR NO LESS THAN 4' FROM THE NEAREST EDGE OF THE INTERSECTING ROADWAY.
3. STOP LINES IN LEFT TURN LANES MAY BE PULLED BACK SO AS NOT TO INTERFERE WITH THE WHEEL PATH OF TURNING VEHICLES.



CROSSWALK DETAIL

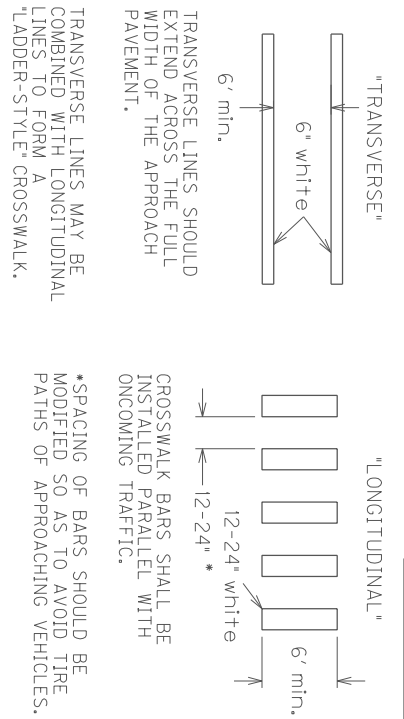

YIELD LINE DETAIL

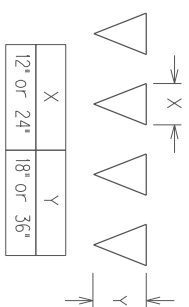

NOTE: SPACING BETWEEN TRIANGLES SHOULD BE 3-12"

DRAWING NOT TO SCALE

LEGEND

	WHITE
	YELLOW

1. ARROWS SHALL BE USED IN ALL DEDICATED TURN LANES AT SIGNALIZED INTERSECTIONS. REFER TO SEP1A 042 FOR GUIDANCE ON SPACING.
2. ARROWS, ALONG WITH THE WORD "ONLY", SHALL ONLY BE USED IN A LANE DROP SCENARIO. REFER TO SEP1A 043 FOR GUIDANCE ON SPACING.
3. ARROWS ARE OPTIONAL IN THROUGH LANES.
4. DOTTED LANE LINE EXTENSIONS SHALL BE USED WITH DUAL TURN LANES. THEY SHALL BE THE SAME COLOR OF THE LINES WHICH THEY EXTEND AND SHOULD BE 6" IN WIDTH, 2' IN LENGTH, WITH A GAP OF 2-6' BETWEEN LINES.
5. REFER TO SEP1A 046 FOR GUIDANCE ON, AND DIMENSIONS OF, CROSSHATCH AND CHEVRON MARKINGS.
6. REFER TO SEP1A 046 FOR GUIDANCE ON MEDIAN NOSES.
7. SOLID LINE SEPARATING THROUGH LANES SHOULD EXTEND BACK A MINIMUM OF 50' FROM THE STOP BAR.

\*NOTE: OTHER THAN LONGITUDINAL STRIPING, ALL MARKINGS SHOWN ON THIS DRAWING SHOULD BE THERMOPLASTIC.

**KENTUCKY**  
**DEPARTMENT OF HIGHWAYS**

TYPICAL MARKINGS  
AT SIGNALIZED  
INTERSECTIONS

SUBMITTED: *R. Gifford*  
DATE: 11-30-18  
044

TYPICAL EXIT RAMP GORE MARKINGS

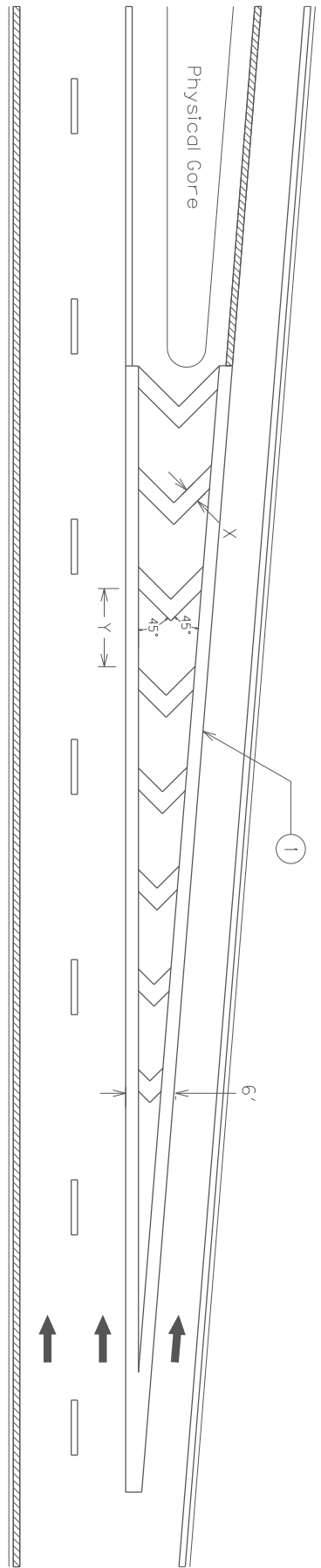

TYPICAL ENTRANCE RAMP GORE MARKINGS

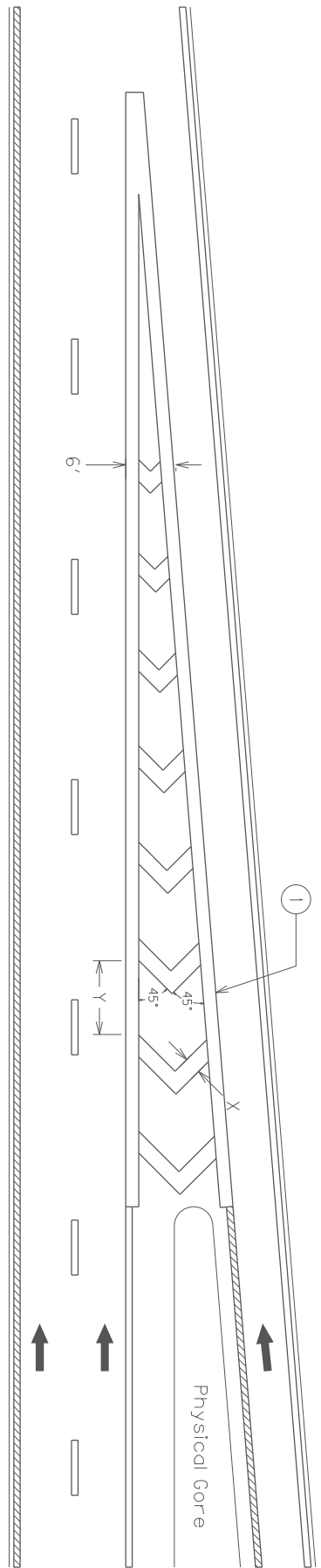

- 1 12" SOLID WHITE LINE TO BE INSTALLED AS SHOWN. THIS LINE SHOULD TERMINATE AT THE PHYSICAL GORE.
- 2 CHEVRON MARKINGS SHOULD BEGIN WHEN THE 12" WHITE CHANNELIZING LINES ARE APPROXIMATELY 6' APART.
- 3 A MINIMUM OF THREE CHEVRON MARKINGS SHOULD BE USED. IF AT LEAST THREE MARKINGS WILL NOT FIT INTO THE GORE AREA, NO CHEVRON MARKINGS SHOULD BE PLACED.
- 4 THE MINIMUM CHEVRON MARKING WIDTH (X) SHOULD BE 2'. THE MINIMUM SPACING BETWEEN CHEVRON MARKINGS (Y) SHOULD BE 20'. THESE DIMENSIONS MAY BE INCREASED. FOR EACH ADDITIONAL 1' OF WIDTH (X), INCREASE THE SPACING (Y) BY 10'.
- 5 GORE AREA CHEVRON MARKINGS SHALL BE THERMOPLASTIC.

DRAWING NOT TO SCALE

LEGEND	
	MARKINGS
	WHITE
	YELLOW

**KENTUCKY**  
**DEPARTMENT OF HIGHWAYS**

TYPICAL MARKINGS  
FOR GORE AREAS

SUBMITTED R. Allen Wolfe 11-30-18  
DATE

045

COUNTY OF	ITEM NO.	SHEET NO.
JEFFERSON	5-20032100	-



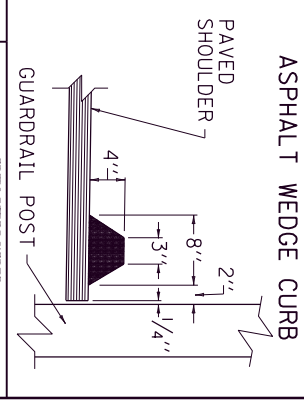
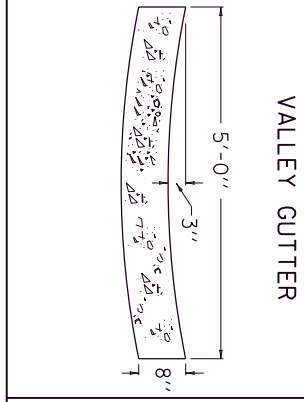
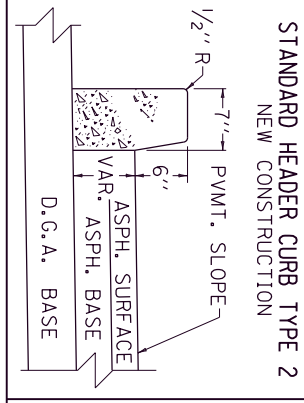
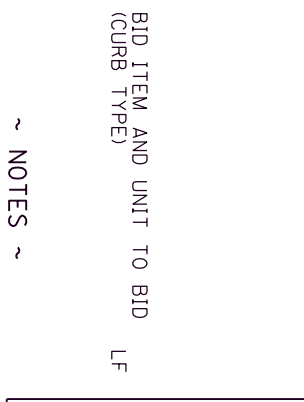
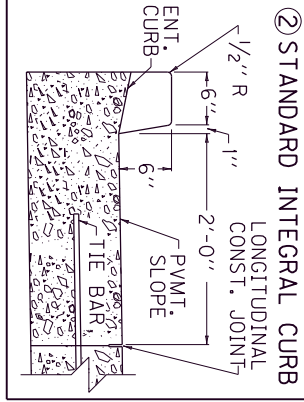
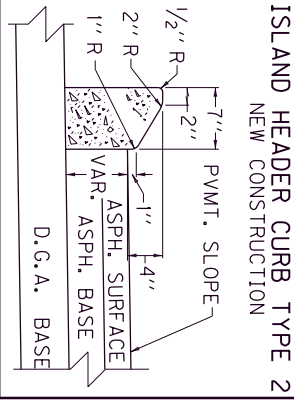
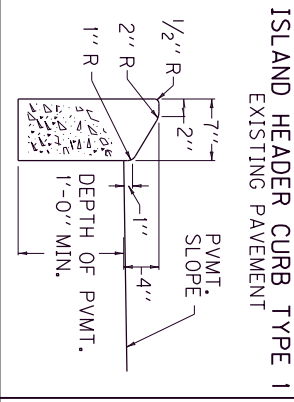
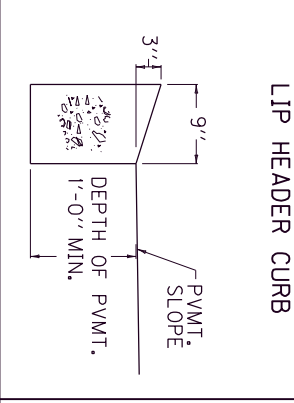
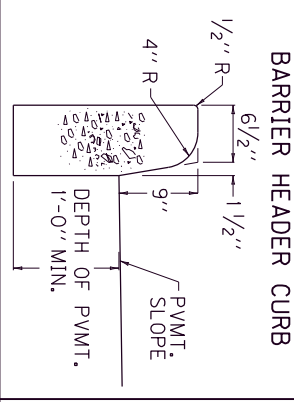
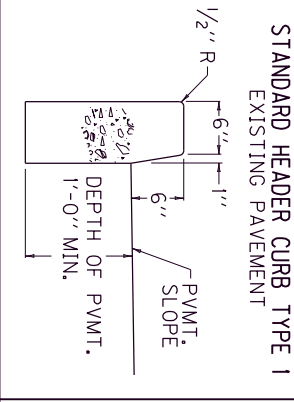
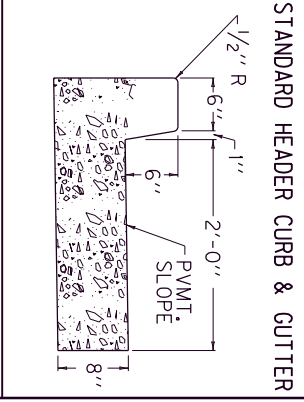
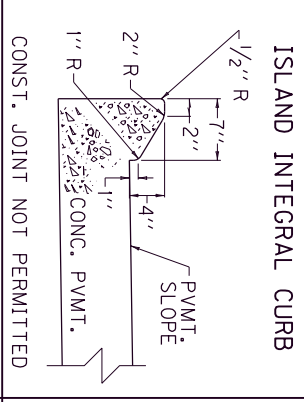
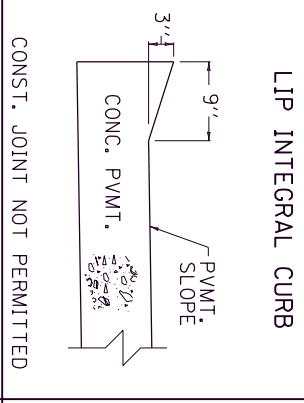
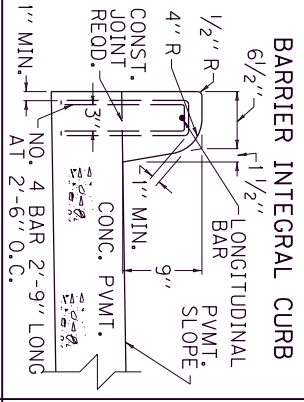
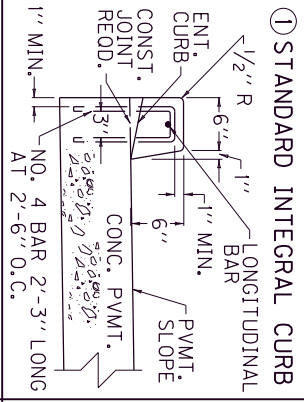
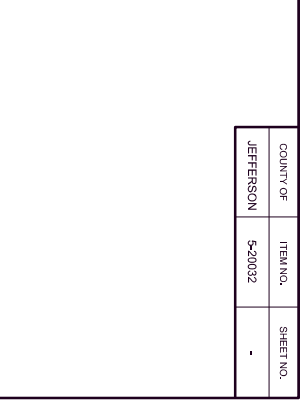
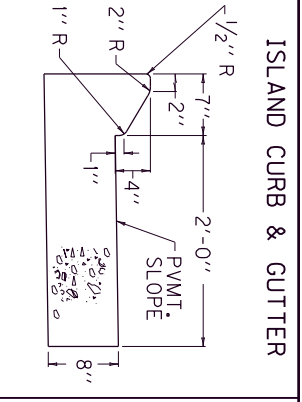
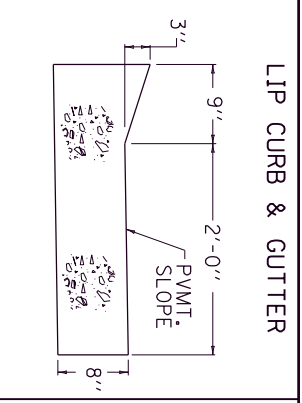
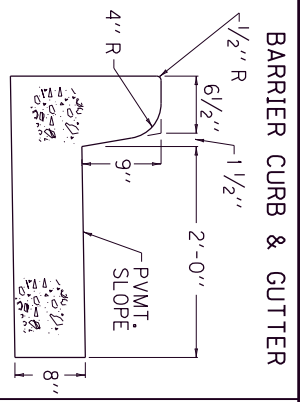
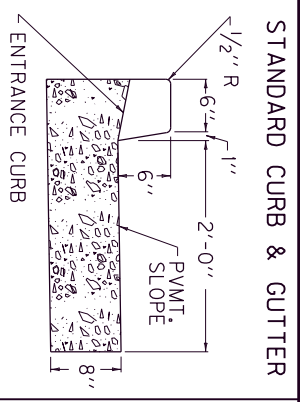

NOTES ~

BID ITEM AND UNIT TO BID (CURB TYPE) LF

- ALL INTEGRAL CURBS SHOWING REINFORCING STEEL SHALL BE CAST SEPARATELY FROM THE PAVEMENT AND THE REINFORCEMENT SHALL CONSIST SOLELY OF NO. 4 BARS AS DETAILED ON THIS DRAWING. ON CONSTRUCTION CARE SHOULD BE TAKEN SO THAT NO REINFORCEMENT BARS ARE CLOSER THAN 3" TO THE CENTER OF THE SAWED TRANSVERSE JOINT.
- THE CONTRACTOR HAS THE OPTION OF CONSTRUCTING THE STANDARD INTEGRAL CURB AS DETAILED IN EITHER ① OR ②. IF ② IS CHOSEN A LONGITUDINAL CONSTRUCTION JOINT SHALL BE REQUIRED AND THE REMAINING PAVEMENT AND ACCOMPANYING REINFORCING STEEL. MONOLITHIC WITHOUT A HORIZONTAL CONSTRUCTION JOINT AND ACCOMPANYING REINFORCING STEEL.

COUNTY OF	TITLE NO.	SHEET NO.
JEFFERSON	5-20032	-

KENTUCKY  
DEPARTMENT OF HIGHWAYS  
CURB AND GUTTER,  
CURBS AND  
VALLEY GUTTER

SUBMITTED: *[Signature]*  
DIRECTOR DIVISION OF DESIGN  
DATE 4-30-19  
060

**TRAFFIC CONTROL PLAN  
JEFFERSON COUNTY  
US 31W  
NHPP 0311 (045)  
FD52 056 031W 014-015  
Item No. 5-20032**

---

**THIS PROJECT IS A FULLY  
CONTROLLED ACCESS HIGHWAY**

**TRAFFIC CONTROL GENERAL**

Except as provided herein, "Maintain and Control Traffic" shall be in accordance with the 2019 Standard Specifications and the Standard Drawings, current editions and the Manual on Uniform Traffic Control Devices (MUTCD), current edition. Except for the roadway and traffic control bid items listed, all items of work necessary to maintain and control traffic will be paid at the lump sum bid price to "Maintain and Control Traffic". All lane closures used on the Project will be in compliance with the appropriate Standard Drawings. Do NOT use cones for lane closures or shoulder closures.

Contrary to Section 106.01, traffic control devices used on this project may be new, or used in like new condition at the beginning of the work and maintained in like new condition until completion of the work. Traffic control devices will conform to current MUTCD.

The posted speed limit is 35 MPH. No reduction in speed limit will be posted, however double work zone signage will be employed. At the beginning of the work zone, the "WARNING FINE DOUBLED IN WORK ZONE" signs will be dual mounted. At the end of the work zone, the "END DOUBLE FINE" signs will be dual mounted as well. Remove or cover the signs when the highway work zone does not have workers present for more than a two-hour period of time. Payment for the signs will be at the unit bid price for signs erected. Any relocation or covering of the signs will be incidental to "Maintain and Control Traffic", lump sum.

Obtain approval from the Engineer for the method of lighting for night work prior to its use.



## PROJECT PHASING & CONSTRUCTION PROCEDURES

Lane closures and reduction of ramp widths and ramp closures will be prohibited during the following days unless otherwise approved by the Engineer:

Thanksgiving Weekend	Nov 28 <sup>th</sup> , 2019 – Dec 1 <sup>st</sup> , 2019
Christmas Day	Dec 25 <sup>th</sup> , 2019
New Year's Day	Jan 1 <sup>st</sup> , 2020
Kentucky Derby Weekend	May 1 <sup>st</sup> , 2020 – May 3 <sup>rd</sup> , 2020
Memorial Day Weekend	May 22 <sup>nd</sup> , 2020 – May 25 <sup>th</sup> , 2020

Other times and dates for prohibited closures may be added at the engineer's discretion.

## ALLOWABLE TIMES OF REDUCTION OF TRAFFIC LANES

Traffic may be reduced to one lane on mainline and ramps during the following times, and traffic may be reduced to half width on one lane ramps during the following times only, except during prohibited days listed:

Sunday – Saturday (any day of week)	7:00 PM to 5:00 AM (Partial Depth repair)
Weekend Closures	Fri. 8 PM to Mon. 5 AM (Full Depth JPC)

Refer to the Special Note for Contract Time and Liquidated damages for failure to restore all lanes of traffic to the original configuration by the times and days required.

## RAMP CLOSURE (RAMP E ONLY)

Ramp E may be closed for one weekend only to complete all JPC Pavement replacement and to complete all partial depth repairs. Notify the engineer a minimum of 2 weeks in advance of the proposed ramp closure date. Install a Portable Changeable Message Sign (PCMS) approximately ½ mile in advance of Ramp E a minimum of one week to notify the public of the planned closure. Allowable ramp closure times are from Friday 8 PM to Mon 5 AM.

Refer to the Special Note for Contract Time and Liquidated damages for failure to restore all lanes of traffic to the original configuration by the times and days required.

## TRAFFIC PHASING OVERVIEW

Access to all interchange ramps on the project shall be maintained at all times unless otherwise directed by the Engineer or as described herein. All diversions to access ramps in areas of lane closures shall be approved by the Engineer prior to implementing each particular lane closure. The contractor must notify the Engineer at least seven (7) days prior to the beginning of each construction phase in either direction.

A minimum of one 10' lane per direction will be maintained on mainline and on two lane ramps at all times during construction except as specifically outlined herein. A minimum lane width of

8' will be maintained on one lane ramps. Lane closures may only be in place while workers are present and actively working except for curing of full depth patching. Traffic may be shifted partially and temporarily onto shoulders, where available, on one lane ramps in order to avoid stoppage of traffic on ramps. Traffic may be allowed to be stopped by use of flaggers on one lane ramps while performing operations near the center of lane for a period of no longer than 5 minutes. Allow traffic to clear completely from the ramp after stoppage prior to the next stoppage in traffic. Duration of stoppages may be adjusted by the engineer based on length of traffic cue. Use Portable Changeable Message Signs to warn of stopped traffic on ramp in advance of any potential stopped traffic situation on ramps. Duration of stoppage of traffic may not be allowed to cue up on I-264 exit ramps more than half the length of the ramp.

**Mainline** – Reduce traffic to one lane during allowable days and allowable times of lane closures, completing operations and restoring all lanes of traffic at the end of each work shift and within the times required.

**Temporary Roadways** - Ramp shoulders will be used on one lane ramps to allow passage of vehicles while workers are working near the center of roadway. Maintain an 8 feet wide travelled way on one lane ramps except in the immediate vicinity where workers are present. In the vicinity of the active work zone, temporarily shift traffic partially onto shoulders.

Prior to use of any shoulder for temporary maintenance of traffic, inspect and correct any damage to the shoulder by use of asphalt leveling and wedging material. Place leveling and wedging in potholes or rutted, sunken areas as necessary. Remove damaged asphalt prior to placement of leveling and wedging material if necessary. Any necessary removal of damaged asphalt by excavation or milling or other preparatory measures will be considered incidental to “Leveling and Wedging PG64-22”.

**Ramps** - Traffic may be allowed to be stopped by use of flaggers on one lane ramps, while performing operations near the center of lane (and no ramp shoulders are present), for a period of no longer than 5 minutes. Allow traffic to clear completely from the ramp after stoppage prior to the next stoppage in traffic. Duration of stoppages may be adjusted by the engineer based on length of traffic cue. Use Portable Changeable Message Signs to warn of stopped traffic on ramp in advance of any potential stopped traffic situation on ramps. Duration of stoppage of traffic may not be allowed to cue up on I-264 exit ramps more than half the length of the ramp.

## **SHOULDER PREPARATION AND RESTORATION**

Shoulders used as temporary roadways will be inspected by the Engineer and if deemed necessary by the Engineer, repaired with asphalt mixture for leveling & wedging as directed prior to opening to traffic. Perform any maintenance of the shoulder as deemed necessary by the Engineer in order to maintain traffic. Remove failed materials and perform additional patching as directed by the Engineer prior to using the shoulder as a travel lane. Remove any pavement on the shoulders damaged by application of traffic as directed by the Engineer and repair with asphalt mixture for leveling and wedging. Any necessary removal of damaged asphalt by excavation or milling or other preparatory measures will be considered incidental to “Leveling and Wedging PG64-22”.



## **Project Phasing:**

### **Phase I – Full Depth JPC Repairs**

Using alternating lane closures during allowable weekend times listed, complete all full depth JPC Pavement removal and replacement. Only remove the amount of existing PCC pavement that can be replaced daily. Replace all removed JPC Pavement daily, and prior to suspending daily operations, in order to limit exposure of traffic to a pavement edge drop-off. Remove all lane closures as soon as adequate curing and compressive strength of replaced slabs is achieved and prior to the conclusion of the time allowable for lane closures.

Complete Ramp B full depth JPC repairs half width by running traffic partially on shoulders. Shift traffic onto shoulders using drums on 20' spacing and line the outside of shoulder with drums on 20' spacing.

### **Phase IA – Partial Depth Patching and Full Depth JPC Repairs Ramp E**

Use PCMS signs to notify the public one week in advance of the proposed closure times. Install detour signs and PCMS signs in accordance with the Detour Plan. Use PCMS signs to advise that the northbound US31W ramp (Ramp E) is closed, and advise traffic to use the Taylor Blvd exit. Close the ramp and complete all concrete repairs, both full depth and partial depth, within the allowable times of ramp closures.

### **Phase II – Partial Depth Patching, Joint Sealing, and Curb Repairs**

Using alternating lane closures during allowable times and days of closure, complete curb repairs, partial depth patching of concrete pavement, and resealing of joints on mainline and two lane ramps.

Reduce lane widths on one lane ramps to half width, using a portion of the ramp shoulders to allow for passage of vehicles in areas that workers are present and working in the vicinity of the center of the ramp. Traffic may be stopped for short durations only where no shoulders exist in order to complete patching operations near the center of the one lane ramp.

Pursue partial depth removal and patching to complete each patching area in the work area and restore all lanes of traffic by the times required.

Remove existing pavement markers only where affected by patching operations.

Install temporary striping for any striping damaged over 5 feet in length by patching operation.

### **Phase III – Final Cleanup and Final Pavement Markings**

Complete any necessary final cleanup, dressing and seeding behind curbs, and complete placement of final pavement markings.

#### **WIDE LOADS**

Make provisions for wide loads up to 16 feet wide to pass when necessary. No wide load detour will be established.

#### **LANE CLOSURES**

Contrary to Section 112.04.17, Lane Closures, whether long term or short term, will not be measured for payment and will be incidental to the bid item “Maintain and Control Traffic”.

#### **MAINLINE LANE WIDTHS**

Maintain minimum 10’ lane widths at all times lane closures are in place on mainline or two lane ramps. Ramp traveled widths may be reduced to 8 feet for one lane ramps while work is in progress, and by partial use of ramp shoulders.

#### **SIGNS**

Traffic control signs in addition to normal lane closure signing detailed on the Standard Drawings may be required by the Engineer. Additional signs needed for lane closures may include, but are not limited to, dual mounted LEFT/RIGHT LANE CLOSED 1 MILE, LEFT/RIGHT LANE CLOSED 2 MILE, LEFT/RIGHT LANE CLOSED 3 MILE, SLOWED/STOPPED TRAFFIC AHEAD, KEEP LEFT/RIGHT. Signage for double fine work zones will be furnished, relocated, and maintained by the Contractor.

Contrary to section 112, individual signs will be measured only once for payment, regardless of how many times they are set, reset, removed and relocated during the duration of the project. Replacements for damaged signs or signs directed to be replaced by the Engineer due to poor legibility or reflectivity will not be measured for payment.

A quantity of signs has been included for “Roadwork Ahead” signs on entrance ramps, extra double fine signs, keep left/keep right and additional speed limit signs. These are to be paid for only once regardless of how many times they are moved or relocated.

PCMS should be used during daytime hours to announce future lane closure times. Use PCMS signs to provide additional or supplemental warning to motorists of lane closures, stopped traffic and delays as directed by the engineer.



## **FLASHING ARROWS**

Flashing arrows will be paid for once, regardless of how many times they are moved or relocated. The Department **WILL NOT** take possession of the flashing arrows upon completion of the work.

## **PORTABLE CHANGEABLE MESSAGE SIGNS**

Provide portable changeable message signs (PCMS) in advance of and within the project at locations to be determined by the Engineer. If work is in progress concurrently in both directions, or if more than one lane closure is in place in the same direction of travel, provide additional PCMS. Place PCMS one mile in advance of the anticipated queue at each lane closure. As the actual queue lengthens and/or shortens relocate or provide additional PCMS so that traffic has warning of slowed or stopped traffic at least one mile but not more than two miles before reaching the end of the actual queue. The locations designated may vary as the work progresses. The messages required to be provided will be designated by the Engineer. The PCMS will be in operation at all times. In the event of damage or mechanical/electrical failure, the contractor will repair or replace the PCMS immediately. PCMS will be paid for once, no matter how many times they are moved or relocated. The Department **WILL NOT** take possession of the signs upon completion of the work.

## **TRUCK MOUNTED ATTENUATORS**

Furnish and install MUTCD approved truck mounted attenuators (TMA) in advance of work areas when workers are present less than 12 feet from traffic. TMA's shall meet the requirements of section 112.02.11 of the specifications.

Location of TMA's are to be adjusted as necessary to provide the most effective protection of errant vehicles potentially entering the work zone where workers are present.

Multiple TMA's will be required for multiple work sites within the project.

If there is less than 500 feet between work sites, only a single TMA will be required at a location directed by the Engineer. Locate the TMAs at the individual work sites and move them as the work zone moves within the project limits. All details of the TMA installations shall be approved by the Engineer. The Department **WILL NOT** take possession of the TMAs upon completion of the work.

## **PAVEMENT MARKINGS**

Remove or cover the lenses of raised pavement markers that do not conform to the traffic control scheme in use, or as directed by the Engineer. Replace or uncover lenses before a closed lane is reopened to traffic. No direct payment will be made for removing or covering and uncovering the lenses, but will be incidental to "Maintain and Control Traffic," lump sum.

Place temporary and permanent striping in accordance with Section 112 for temporary striping, 713 and section 714 for Thermoplastic Markings, and Durable Type 1 Markings, except that:

1. Temporary and permanent striping will be 6" in width and gore area markings will be 12" in width. Gore area Chevrons will be 24" in width.
2. Existing, temporary, or permanent striping will be in place before a lane is opened to traffic.
3. Place new permanent striping on pavement within the project limits after completion of all other items of work on the project.
4. Striping removal will be performed by water blasting methods only in a non-destructive manner. The Contractor will be required to adjust his operations to ensure no damage results to ultimate pavement due to striping removal efforts.

Should the Contractor change the existing striping pattern, the Contractor is to restripe the roadway back to its original configuration if no work is anticipated for a period of time (i.e. Winter shutdown).

#### **PAVEMENT EDGE DROP-OFFS**

Pavement edge drop-offs will be protected by a lane or shoulder closure. Lane closures will be protected with plastic drums, vertical panels, or barricades as shown on the Standard Drawings.

Pavement edges that traffic is not expected to cross, less than 5' from edge of travelled way, except accidentally, shall be treated as follows:

Less than 2" – Protect with a lane closure.

2" to 4" – Protect with a lane closure. Place plastic drums, vertical panels, or barricades every 50 feet. Cones may not be used in place of plastic drums, panels, and barricades at any time.

Greater than 4" – For drop-offs less than 5' from the edge of roadway in areas of partial patching, resulting in a drop-off greater than 4" and less than 5' from the edge of traveled way, work should proceed continuously and pursued until the pavement is restored to existing grade and the drop-off eliminated prior to suspending operations. Barrel spacing should be 20 feet and appropriate lighting should be utilized to illuminate the area during nighttime operations. Place Type III barricades in the lane immediately in advance of each drop-off area until the drop-off is eliminated.

#### **TRAFFIC COORDINATOR**

Designate an employee to be traffic coordinator. The designated Traffic Coordinator must meet the requirements of section 112.03.12 of the Standard Specifications. The Traffic Coordinator will inspect the project maintenance of traffic once every two hours during the Contractor's operations and at any time a lane closure is in place. The Traffic Coordinator will report all incidents



throughout the work zone to the Engineer on the project. The Contractor will furnish the name and telephone number where the Traffic Coordinator can be contacted at all times.

During any period when a lane closure is in place, the Traffic Coordinator will arrange for personnel to be present on the project at all times to inspect the traffic control, maintain the signing and devices, and relocate portable changeable message boards as queue lengths change. The personnel will have access on the project to a radio or telephone to be used in case of emergencies or accidents.

### **COORDINATION OF WORK**

The Contractor is advised that other projects may be in progress within or in the near vicinity of this project. The traffic control of those projects may affect this project and the traffic control of this project may affect those projects. The Contractor will coordinate the work on this project with the work of the other contractors. In case of conflict, the Engineer will determine the relative priority to give to work phasing on the various projects.

### **CONTRACTOR'S AND CONTRACTOR'S EMPLOYEES' VEHICLES**

Contractor's vehicles will only travel in the same direction as mainline or ramp traffic and in no case will be allowed to travel against the flow of traffic. Conduct legal turn-arounds, no u-turns on US 31W and if entry to I-264 is required, then conduct turn-arounds at the next interchange to return to the project.

Contractor's equipment and vehicles shall be staged or stored at distances as far as practical from the traveling public. Equipment and vehicles shall not be parked adjacent or near adjacent traffic lanes when work is in progress unless specifically being used as part of the active work. Equipment, stockpiles, and other materials or vehicles shall be stored well outside the clear zone, behind guardrail or off site when work is not in progress.

### **EXISTING SIGNS**

The contractor will protect and avoid existing signs where possible. Remove existing signs that are in conflict with the proposed work, protect and store in a dry, closed environment, and reinstall either with the existing hardware and posts or provide new hardware and posts. Removal and reinstallation of any existing sign will be considered incidental to other items in the contract.

Cover existing signs if in conflict with the proposed traffic scheme. Use materials that will not damage retroreflective sheeting to cover both sheet signs and panel signs as approved by the engineer. Any damage to panel signs or sheeting signs resulting from construction activities, removal and replacement activities, and covering and uncovering will be corrected or the sign replaced at the contractor's expense.

# MAINTENANCE OF TRAFFIC

## US 31W

County	Item No.	Sheet
JEFFERSON	5-20032.00	-

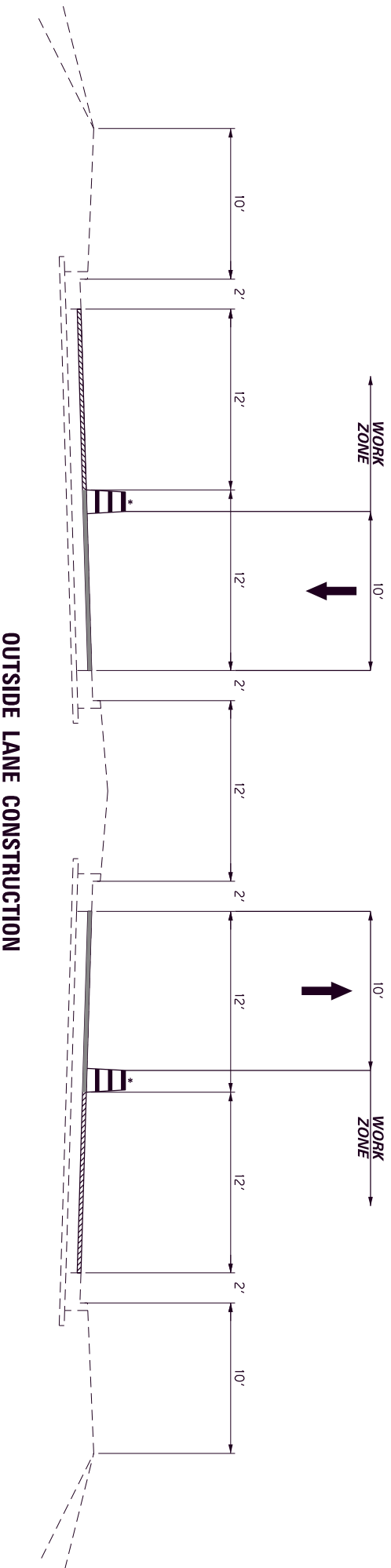
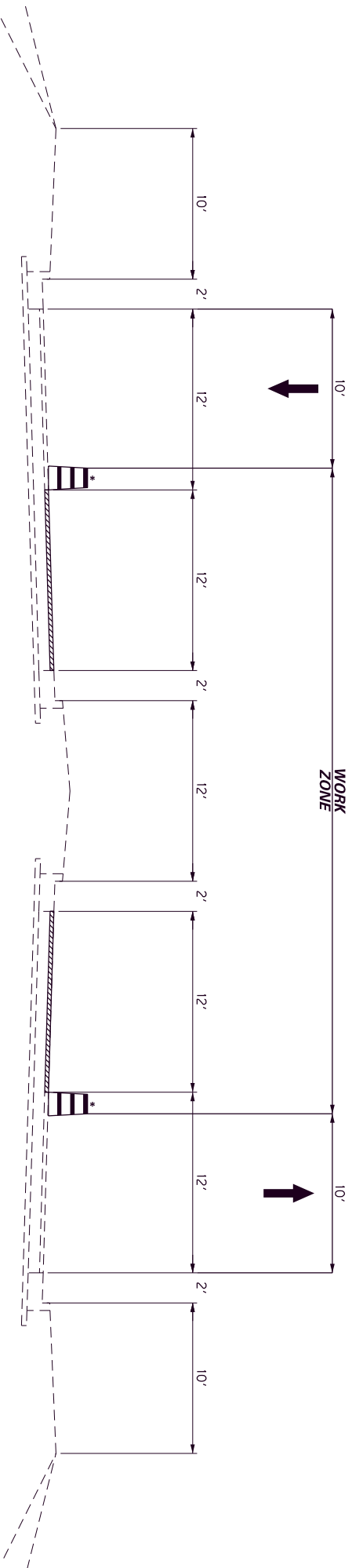

\*MOVE DRUM TEMPORARILY WHEN NECESSARY TO MAINTAIN WIDE EQUIPMENT PASS IMMEDIATELY WHEN DRUMS OUT OF ASPHALT AS SOON AS PRACTICAL TO RESTORE LANE WIDTHS.

**LEGEND**  
 PREVIOUSLY CONSTRUCTED -   
 CONSTRUCT THIS PHASE - 

US 31W  
 MAINTENANCE OF TRAFFIC  
 TYPICAL SECTIONS

# MAINTENANCE OF TRAFFIC

## TWO LANE RAMPS

County	Item No.	Sheet
JEFFERSON	5-20032.00	-

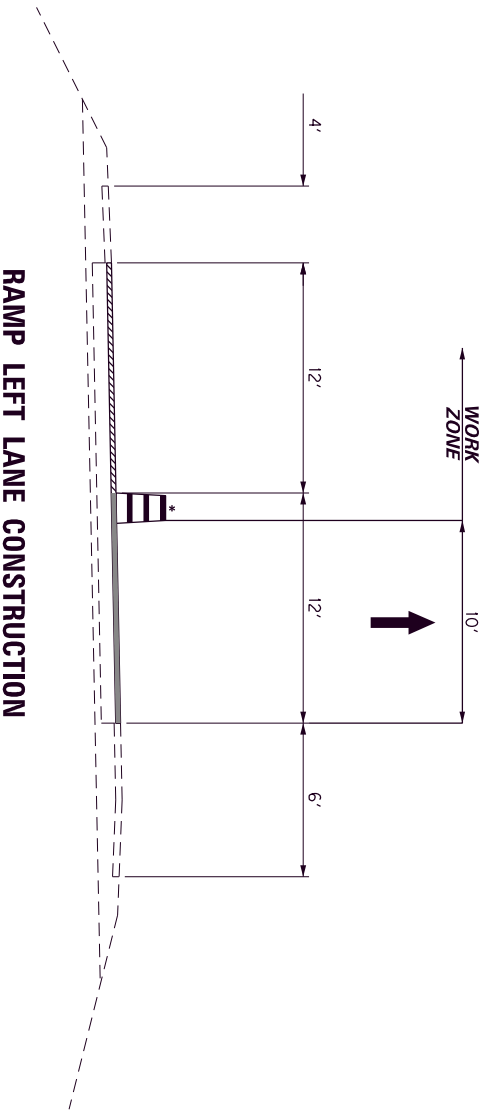
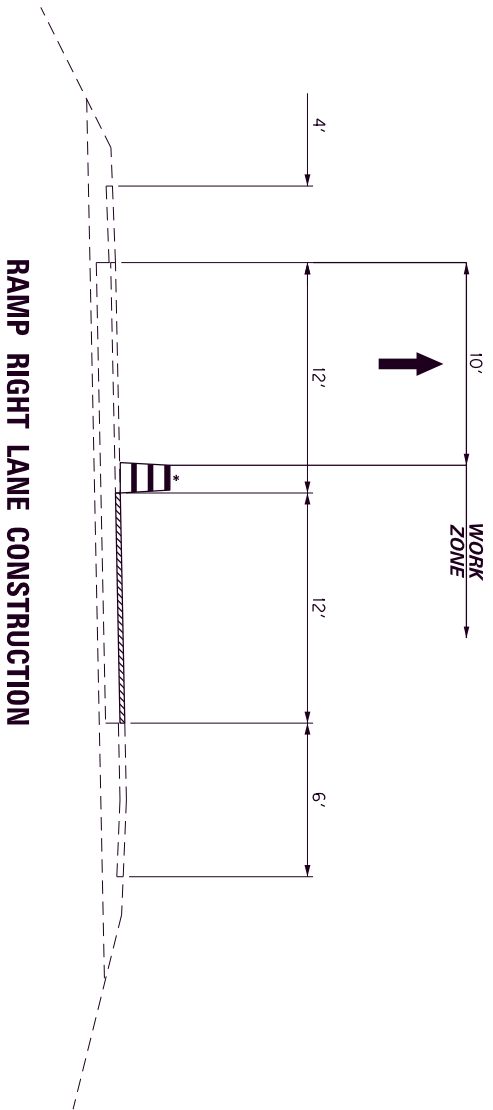

\*MOVE DRUM TEMPORARILY WHEN NECESSARY TO MAINTAIN ONE EQUIPMENT PASS IMMEDIATELY AND EQUIPMENT ONTO NEW ASPHALT AS SOON AS PRACTICAL TO RESTORE LANE WIDTHS.

**LEGEND**  
PREVIOUSLY CONSTRUCTED -   
CONSTRUCT THIS PHASE -

US 31W  
MAINTENANCE OF TRAFFIC  
TYPICAL SECTIONS



# MAINTENANCE OF TRAFFIC

## ONE LANE RAMPS (PARTIAL DEPTH PATCHING)

County	Item No.	Sheet
JEFFERSON	5-20032.00	-

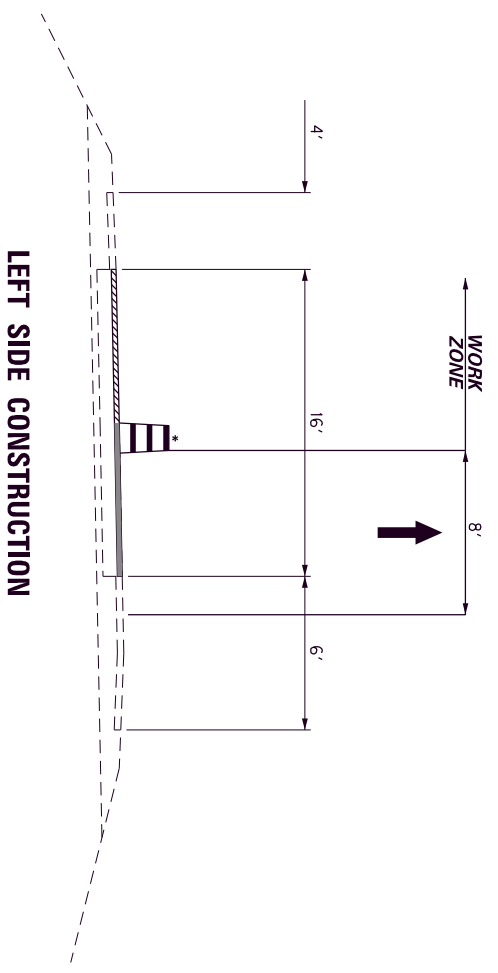
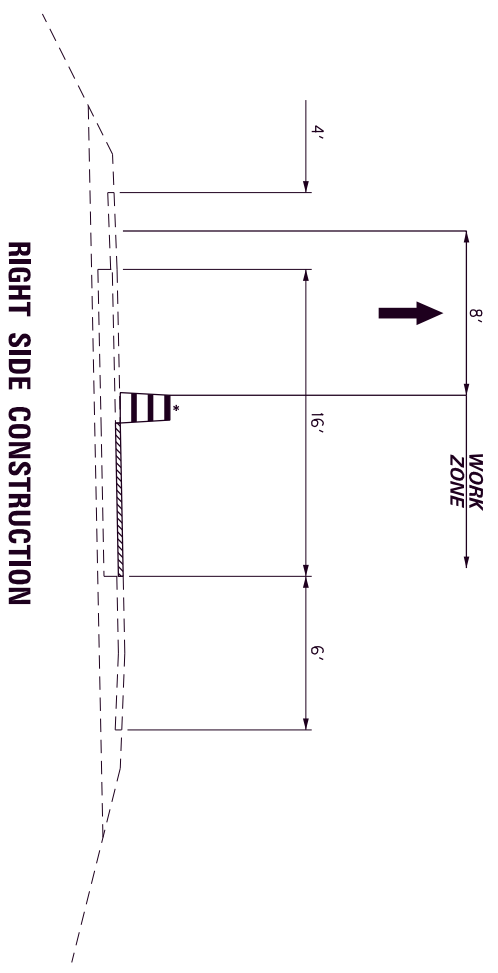

\*MOVE DRUM TEMPORARILY WHEN NECESSARY TO AVOID PLACING EQUIPMENT TO PASS IMMEDIATELY INTO NEW ASPHALT AS SOON AS PRACTICAL TO RESTORE LANE WIDTHS.

**LEGEND**  
 PREVIOUSLY CONSTRUCTED -   
 CONSTRUCT THIS PHASE -

US 31W  
 MAINTENANCE OF TRAFFIC  
 TYPICAL SECTIONS

MESSAGES:

- 1 US31W NB RAMP CLOSED
- 1 8 PM FRI TO 5 AM MON
- 1 31W NB RAMP CLOSED
- 1 USE TAYLOR BLVD RAMP CLOSED
- 2
- 3
- 4
- 5
- 6
- 7

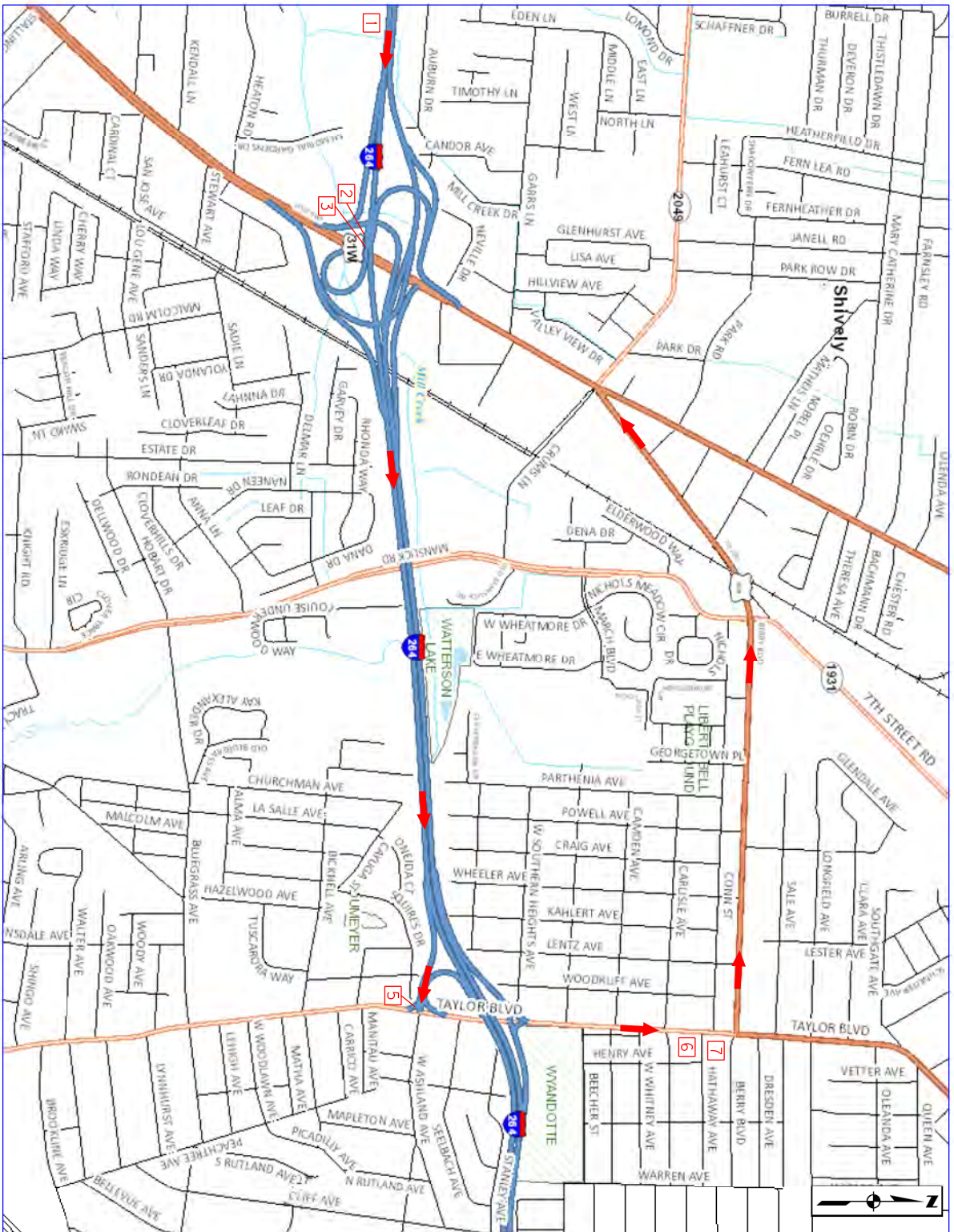
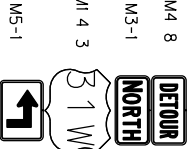
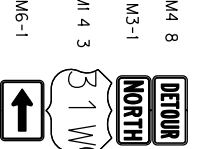
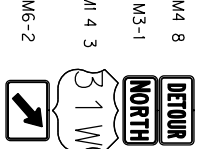
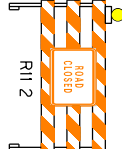

County	Item No.	Sheet
JEFFERSON	5-20032	-

NOTE: PLACE CONES 1/2 MILE IN ADVANCE OF EXIT FOR 7 DAYS TO PROVIDE PRIOR NOTICE OF RAMP CLOSURE. NOTIFY DISTRICT 2 WEEKS PRIOR TO RAMP CLOSURE. ALLOWABLE RAMP CLOSURE IS 8:00 PM FRIDAY TO 5:00 AM MONDAY (ONE WEEKEND).

US 31W  
MAINTENANCE OF TRAFFIC  
RAMP E DETOUR

**US 31 W  
JEFFERSON COUNTY  
NHPP 0311 (045) FD52  
056 031W 014-015 Item  
No. 5-20032**

**MP 14.511 to MP 14.999**

**THIS PROJECT IS A FULLY  
CONTROLLED ACCESS HIGHWAY**

**I. DESCRIPTION**

Perform all work in accordance with the Department's 2019 Standard Specifications, Supplemental Specifications, Applicable Special Provisions, and Applicable Standard and Sepia Drawings, except as hereafter specified. Article references are to the Standard Specifications. Furnish all materials, labor, equipment, and incidentals for the following work:

(1) Maintain and Control Traffic; (2) Curb Repairs; (3) Partial Depth Patching; (4) Full Depth Patching; (5) Joint Sealing; (6) Pavement markers and markings; and (7) All other work specified as part of this contract.

**II. MATERIALS**

Except as specified in these notes or on the drawings, all materials will be according to the Standard Specifications and applicable Special Provisions and Special Notes. The Department will sample and test all materials according to Department's Sampling Manual and the Contractor will have the materials available for sampling a sufficient time in advance of the use of the materials to allow for the necessary time for testing, unless otherwise specified in these notes.

- A. **Maintain and Control Traffic.** See Traffic Control Plan.
- B. **Pavement Markings -6 inch.** Use Durable Type I Tape for Permanent Striping.
- C. **Pavement Markings – 12 inch.** Use Durable Type I Tape 12 inches in width in gore areas and for island outlines.
- D. **Chevrons.** Use Thermoplastic markings 24 inches in width for gore area chevrons.
- E. **Joint Sealant.** Use only Hot Pour Elastic Joint Sealant for joints to be saw cleaned and sealed and joint sealing of full depth JPC Pavement repairs. See Special Note



for Concrete Pavement Joint and Random Crack Sealing.

- F. **Polymer Modified Partial Depth Patching.** See “Special Note for Polymer Modified Partial Depth Patching.”
- G. **Full Depth Concrete Pavement Repair.** See Special Note 11J. Provide a Class P concrete mix proportioned in accordance with Section 601.03.03, except modifications to the mix may be required to attain early compressive strength to meet early opening to traffic requirements in order to comply with allowable lane closure and allowable ramp closure times. Obtain prior approval for modifications to the mix.

### III. CONSTRUCTION METHODS

- A. **Maintain and Control Traffic.** See Traffic Control Plan. Use water blasting methods only for striping removal when necessary in lieu of abrasive or other methods. Reduced spacing of traffic drums will be required during certain phases on this project. Truck mounted attenuators will be required at each work zone.
- B. **Site Preparation.** Be responsible for all site preparation. Do not disturb existing signs unless in conflict. This item will include, but is not limited to, incidental excavation and backfilling; removal of all obstructions or any other items; disposal of materials; sweeping and removal of debris; shoulder preparation and restoration, temporary and permanent erosion and pollution control; and all incidentals. Site preparation will be only as approved or directed by the Engineer.
- C. **Disposal of Waste.** Dispose of all cuttings, debris, and other waste off the right-of-way at approved sites obtained by the Contractor. The contractor will be responsible for obtaining any necessary permits for this work. Temporary openings in the right of way fence for direct access to waste sites off the right of way or for access to other public roads will not be allowed. No separate payment will be made for obtaining the necessary permits, but will be incidental to the other items of the work. Disposal of existing cuttings and brush shall adhere to Section 202 of the current Standard Drawings.
- D. **Final Dressing, Clean Up, and Seeding and Protection.** After all work is completed, completely remove all debris from the job site. Perform Class A Final Dressing on all disturbed areas. Sow disturbed earthen areas with Seed Mixture No. I and use erosion control blanket in lieu of “Seeding and Protection” in all seeding applications.
- E. **Pavement Striping and Type V Pavement Markers.** Pavement striping will be in accordance with Section 112 for temporary striping, and Section 714 for Thermoplastic Markings and Durable Type 1 Tape, except that:

- (1). Striping will be 6" in width, except 12" in gore area and splitter islands. Chevrons for gore areas will be 24" width.
  - (2). Permanent striping or temporary striping will be in place before a lane is opened to traffic.
  - (3). Pavement Markers shall be installed per Standard Drawings TPM-105-02 (Arrangement C), TPM-125-02, TPM-130-02 and TPM-135-02.
  - (4). Completely remove all existing striping prior to placement of Durable Type I markings by use of water-blasting techniques in a non-destructive manner. NOTICE: Existing durable tape is in place on this project and will be required to be completely removed prior to installation of the new markings.
- F. **On-Site Inspection.** In accordance with section 102.06, each Contractor submitting a bid for this work will make a thorough inspection of the site prior to submitting a bid and will thoroughly familiarize himself with existing conditions so that the work can be expeditiously performed after a contract is awarded. Submission of a bid will be considered evidence of this inspection having been made. Any claims resulting from site conditions will not be honored by the Department.
- G. **Caution:** Information shown on the drawings and in this proposal and the types and quantities of work listed are not to be taken as an accurate or complete evaluation of the material and conditions to be encountered during construction. The bidder must draw his own conclusions as to the conditions encountered. The Department does not give any guarantee as to the accuracy of the data and no claim will be considered for additional compensation if the conditions encountered are not in accordance with the information above.
- H. **Utility Clearance.** It is not anticipated that utility facilities will need to be relocated and/or adjusted; however, in the event that it is discovered that the work does require that utilities be relocated and/or adjusted, the utility companies will work concurrently with the Contractor while relocating their facilities.
- I. **Saw Clean and Reseal Joints.** Saw clean and reseal all remaining longitudinal and transverse joints and random cracks in the existing concrete pavement that are not replaced by partial depth polymer patching or full depth concrete patching in accordance with Section 501.03.18 F. Remove existing joint material by re-sawing and cleaning existing joints in preparation for the new joint sealant in accordance with Section 501.03.18 F. See Special Note for Concrete Pavement Joint and Random Crack Sealing.
- H. **Polymer Modified Partial Depth Patching.** See "Special Note for Polymer Modified Partial Depth Patching."

- I. **Full Depth Concrete Pavement Repair.** See Special Note 11J. For replacement of only one lane, saw and remove pavement along the existing longitudinal joint. For replacement adjacent an existing curb with a gutter pan, saw and remove pavement along the existing gutter pan edge. For replacement adjacent existing curb with no gutter pan, saw cut and remove concrete approximately 6 inches from the existing curb. The engineer may adjust removal limits based on field conditions.

#### IV. METHOD OF MEASUREMENT

- A. **Maintain and Control Traffic.** See Traffic Control Plan. Only the bid items listed will be measured for payment. Removal or covering of existing pavement marker lenses will be made and will be considered incidental to “Maintain and Control Traffic”. Any required covering of signs will be considered incidental.
- B. **Site Preparation.** Other than the bid items listed, site preparation will not be measured for payment, but will be incidental to the other items of work.
- C. **Final Dressing, Clean Up, and Seeding and Protection.** No direct payment will be made for final cleanup, final dressing or temporary or permanent erosion control measures and will be considered incidental to other items in the contract.
- D. **Saw Clean and Reseal Joints.** Contrary to the specifications, “Saw-Clean-Reseal Tverse Joint”, “Saw-Clean-Reseal Longit Joint” and “Saw-Clean-Reseal Random Cracks” will be measured by the linear foot along the length of the joints that are re-sawed, cleaned and resealed. Joints in new full depth JPC will not be measured for payment in accordance with Special Note 11J. See Special Note for Concrete Pavement Joint and Random Crack Sealing.
- E. **Polymer Modified Partial Depth Patching.** See “Special Note for Polymer Modified Partial Depth Patching.”
- F. **Pave Mark Thermo Chevron.** Chevrons for gore area markings will be measured by the square foot of painted area comprising the chevron, excluding gaps between chevrons. Measurement will only include the actual area of paint.
- G. **Full Depth Concrete Pavement Repair.** See Special Note 11J.

#### V. BASIS OF PAYMENT

No direct payment will be made other than for the bid items listed. All other items required to complete the construction will be incidental to the bid items listed. Existing signs damaged by the Contractor will be replaced by the Contractor at his expense. Payment will be made in accordance with the KYTC Standard Specifications, current edition with supplemental specifications and current Standard Drawings unless otherwise specified herein.



- A. **Maintain and Control Traffic.** See Traffic Control Plan.
- B. **Site Preparation.** Other than the bid items listed, no direct payment will be allowed for site preparation, but will be incidental to the other items of work.
- C. **Pavement Markers and Permanent Striping.** See Traffic Control Plan, Standard Specifications.
- D. **Lane Closures.** Contrary to Section 112, lane closures will not be measured for payment but will be incidental to the bid item "Maintain and Control Traffic". Arrow boards, portable message boards, and signs shall be paid for one time regardless of how many times they are moved.
- E. **Water Blasting Existing Stripe.** Pavement striping removal is required and will not be measured for payment. Pavement striping removal will be considered incidental to the new markings.
- F. **Polymer Modified Partial Depth Patching.** See "Special Note for Polymer Modified Partial Depth Patching." Removal of existing asphalt patching or asphalt overlays required for this work will be considered incidental to other items.
- G. **Leveling and Wedging PG64-22.** All preparatory measures required prior to placement of Leveling and Wedging for patching of shoulders for M.O.T. will be considered incidental to "Leveling and Wedging PG64-22", including but not limited to any excavation or milling for removal of failed materials.
- H. **Full Depth Concrete Pavement Repair.** See Special Note 11J. No additional payment will be made for increased cement, admixtures, etc. that may be required to attain early compressive strength.
- I. **Final Dressing, Clean Up, and Seeding and Protection.** No direct payment will be made for final cleanup, final dressing or temporary or permanent erosion control measures and will be considered incidental to other items in the contract.

**US 31 W  
JEFFERSON COUNTY  
NHPP 0311 (045) FD52  
056 031W 014-015 Item  
No. 5-20032**

**MP 14.511 to MP 14.999**

1. This project is intended to repair the existing concrete pavement within the project limits with a polymer modified asphalt partial depth patch or full depth concrete pavement repairs, repair damaged standard integral curb, re-seal all unaffected, remaining concrete joints, and install new pavement markings.
2. The dimensions shown on the typical section for pavement and shoulder widths and thickness are nominal or typical dimensions. The actual dimensions to be constructed may be varied to fit existing conditions as directed or approved by the Engineer. It is not intended that existing pavement or shoulders be widened unless otherwise specified in the Proposal.
3. The contractor is to be advised of the locations of overhead utility wires on the project. The following locations are approximate:

Mile 14.516  
Mile 14.540, Mainline and Ramp D  
Mile 14.598, Mainline and Ramp D  
Mile 14.635  
Mile 14.869  
Mile 14.894  
Mile 14.947  
Mile 14.612, 90' RT on Ramp D  
Mile 14.720, 85' RT on Ramp E

**CAUTION:** Other overhead utility locations may exist. These and all other utilities should be avoided on this project. If any utility is impacted, it will be the contractor's responsibility to contact the affected utility and cover any costs associated with the impact.

4. The contractor is advised that the planned locations of work established by milepoints are referenced from the Kentucky Transportation Cabinet's Official Route Log. The existing reference markers may not correspond to the established work locations.
5. The speed limit on the project will remain at 35 mph while lane closures are in place. Also, double fine signs are set up in the project to be installed while workers are present in the work zone.

6. The contractor is to take care not to damage any existing roadway signs. Any roadway signs that are damaged during construction are to be replaced at the contractor's expense in accordance with section 105.08 of the standard specifications.
7. The contractor is to take care not to damage any existing light poles and wiring. Any light poles or wiring that is damaged during construction is to be replaced at the contractor's expense in accordance with section 105.08 of the standard specifications. Contact District 5 Traffic for as-built lighting plans and/or assistance in locating the existing conduit.

The contractor is advised that an existing surveillance camera is in the project vicinity and is to take care not to damage the existing equipment, wiring, pole, etc. associated with this camera.

8. Areas established as Partial Depth Patching-Polymer Mod will be patched as directed by the Engineer. After the contractor has closed the roadway, the Engineer will mark the areas to be repaired. The engineer reserves the right to increase, decrease, or eliminate this item of work based on the field conditions encountered. The depth and extent of concrete removal and partial depth patching may be increased or decreased at the discretion of the engineer based on the pavement condition and project budget. Removal of existing asphalt pothole patching and/or asphalt overlay material may be required prior to removal of unsound concrete. Any necessary removal of existing asphalt patching or overlays will be considered incidental to other items in the contract.
9. **Attention:** Existing concrete pavement contains reinforcement. Reinforcement is visible near the surface in some locations and thus will be encountered during the patching operations. In order to ensure that the reinforcement can be removed without damaging the surrounding sound concrete, the contractor will be required to saw cut the perimeter of the proposed patch to a depth equal to the patch depth. Thus, subsequent jackhammering or milling of concrete will not tend to pull reinforcement through the surface of the concrete surrounding the intended patch area. Methods for removal of existing concrete for patch preparation will be approved by the engineer based on performance, including the ability to remove the intended unsound material without damage to the surrounding sound material intended to remain in place. The engineer reserves the right to suspend any removal operation that fails to yield an acceptable result.



Exposed reinforcement will be cut and removed from the patch area prior to placement of the patching material.

10. A quantity of saw cut and reseal has been established to clean and reseal all remaining concrete joints (both longitudinal and transverse) and random cracks that are not eliminated from the polymer modified patching operation or full depth concrete repairs.
11. A quantity of Leveling and Wedging PG64-22 has been established to repair ramp shoulders that may be used for placement of temporary traffic and to repair any damage that may result from temporarily running traffic on the shoulder.
12. Shoulders on this project will be used for Maintenance of Traffic on one lane ramps. Repair any damage to the shoulders prior to shifting traffic by pothole patching, or excavation to remove failed asphalt material or milling and inlay of leveling and wedging asphalt as approved by the engineer. Inspect shoulders regularly for signs of distress and repair any damages resulting from traffic using similar methods. Periodically inspect and correct any pavement edge drop-offs that may develop while traffic is required to travel on the shoulder. Payment, per ton, of Leveling and Wedging PG64-22 will be full compensation for all work required to repair ramp shoulders for the purposes of maintaining traffic and restoring damage from traffic application.
13. Coordinate activities of any adjacent contracts with this contract. An ongoing construction project is in progress along the corridor of this project. The engineer will make final determination as to priority of activities in case of conflict between adjacent projects.

## REFERENCES

1. Kentucky Transportation Cabinet, Department of Highways, Standard Specifications for Road and Bridge Construction, Edition of 2019.
2. FHWA Manual on Uniform Traffic Control Devices – 2009 Edition.
3. Kentucky Department of Highways Standard Drawings, Current Edition, as applicable:

RDI-040-01	EROSION CONTROL BLANKET SLOPE INSTALLATION
RDX-210-03	TEMPORARY SILT FENCE
RDX-215-01	TEMPORARY SILT FENCE WITH WOVEN WIRE FENCE FABRIC
RDX-220-05	SILT TRAP - TYPE A
RDX-225-01	SILT TRAP - TYPE B
RDX-230-01	SILT TRAP - TYPE C
RGS-001-07	CURVE WIDENING AND SUPERELEVATION TRANSITIONS
RGS-002-06	SUPERELEVATION FOR MULTI-LANE PAVEMENT
RPN-020-04	CONCRETE PAVEMENT JOINTS TYPES & SPACING
RPS-010-11	CONCRETE PAVEMENT JOINT DETAILS
RPS-020-14	EXPANSION AND CONTRACTION JOINT LOAD TRANSFER ASSEMBLIES
RPX-015-04	HOT-POURED ELASTIC JOINT SEALS FOR CONCRETE PAVEMENT
TPM-100-03	PAVEMENT MARKER ARRANGEMENTS MULTI-LANE ROADWAYS
TPM-171	FLEXIBLE DELINEATOR POST ARRANGEMENTS FOR INTERCHANGE RAMPS AND CROSSOVERS
TTC-115-03	LANE CLOSURE MULTI-LANE HIGHWAY CASE I
TTC-125-03	DOUBLE LANE CLOSURE
TTC-135-02	SHOULDER CLOSURE
TTD-125-02	PAVEMENT CONDITION WARNING SIGNS
TTS-110-02	MOBILE OPERATION FOR PAINT STRIPING CASE III
TTS-115-02	MOBILE OPERATION FOR PAINT STRIPING CASE IV

4. Kentucky Transportation Cabinet, Department of Highways, Standard Specifications for Road and Bridge Construction, Edition of 2019, Appendix B - Supplemental Specifications, as applicable:

Special Note	Typical Section Dimensions <i>attached</i>
Special Note	Special Note for Project Completion and Liquidated Damages <i>attached</i>
Special Note	Before You Dig <i>attached</i>
Special Note	Asphalt Milling and Texturing <i>attached</i>
Special Note	Special Note for Polymer Modified Partial Depth Patching <i>attached</i>
Special Note	Special Note for Concrete Pavement Joint and Random Crack Sealing
Special Note	11J Full Depth Concrete Pavement Repair

Special Note  
Special Note

Portable Changeable Message Signs *attached*  
Special Note for Significant Project *attached*



**SPECIAL NOTE FOR TYPICAL SECTION DIMENSIONS**  
**US 31W**  
**JEFFERSON CO.**  
**ITEM NO. 5-20032**

The dimensions shown on the typical sections for pavement and shoulder widths are nominal or typical dimensions. The actual dimensions to be constructed may be varied to fit existing conditions as directed or approved by the Engineer. It is not intended that existing pavement or shoulders be widened or narrowed **EXCEPT** where specified elsewhere in the Proposal.

**SPECIAL NOTE FOR PROJECT COMPLETION AND LIQUIDATED DAMAGES**  
**US 31W**  
**JEFFERSON CO.**  
**ITEM NO. 5-20032**

This project has a specified date of completion for all items in the contract of May 31, 2020. Contrary to Section 108.09 of the Specifications, liquidated damages in the amount of \$5000 per calendar day will be applied if all items in the contract are not completed by the Specified Completion Date.

In addition to the Liquidated Damages specified above, Liquidated Damages in the following amounts will be charged any time a lane closure (mainline or ramp) or ramp closure remains in place during times outside the times allowed in the Traffic Control Plan.

\$5,000 for the first hour or fraction thereof

\$10,000 for any additional hour or fraction thereof

These hourly disincentives will remain in effect both during the original contract time and after the Specified Completion Date and will be charged in addition to the \$5,000 per calendar day if warranted. The Contractor is expected to make every effort to complete the work and open all existing lanes to traffic within the timeframes specified as allowed in the Traffic Control Plan.

Contrary to the Specifications, Liquidated Damages will be applied for each Calendar Day that work is not completed after the Specified Completion Date and for each hour a lane closure is in place during times not allowed in the Traffic Control Plan, regardless of seasonal or weather limitations, and will be applied through the months of December – March. Additionally, all Liquidated Damages or penalties assessed will be charged cumulatively.

**SPECIAL NOTE FOR BEFORE YOU DIG**

**US 31W  
JEFFERSON CO.  
ITEM NO. 5-20032**

Call 1-800-752-6007 toll free a minimum of two and no more than ten business days prior to excavation for information on the location of existing under-ground utilities which subscribe to the before-u-dig (BUD) service. Coordinate excavation with all utility owners, including those who do not subscribe to BUD.



**SPECIAL NOTE FOR  
ASPHALT MILLING AND TEXTURING  
US 31W  
JEFFERSON CO.  
ITEM NO. 5-20032**

Existing shoulders will be used to maintain traffic temporarily on one lane interchange ramps. These shoulders will be inspected prior to application of traffic, and after application of traffic for damage and needed repairs. If shoulder repairs are required, which may involve removal of damaged pavement, the contractor may elect to remove the existing failing material by excavation or by milling. No direct payment for removal of existing failing asphalt materials will be made, whether by milling operations or other operations, and will be considered incidental to the other items in the contract.

Removal of existing asphalt overlays may be required to perform Polymer Modified Patching on underlying PCC slabs. Removal methods will be at the choice of the contractor and as approved by the engineer, however if milling and texturing methods are used, no direct measurement or payment will be made for "Asphalt Pave Milling and Texturing".

Contrary to the specifications, no direct payment for "Asphalt Pave Milling and Texturing" will be made if this item of work is required or chosen to be employed on this project.

July 23, 2018

## **SPECIAL NOTE FOR POLYMER MODIFIED PARTIAL DEPTH PATCHING**

### **DESCRIPTION**

This work consists of patching transverse and longitudinal random cracks, centerline joints, contraction joints, longitudinal and transverse expansion joints, holes from pavement markers, or spalled areas in Portland cement concrete pavement.

### **APPLICATIONS**

The installed product shall be a hot applied, flexible mastic sealant made from highly polymer-modified synthetic resins and high quality aggregate. The installed product shall provide a load-transferring repair that has superior tensile strength and flexibility to accommodate joint and crack movement associated with thermal expansion and contraction, and vibratory movements. The patch must have exceptional resistance to water intrusion and to a broad range of salts, bases, and organic materials.

### **MATERIAL SPECIFICATIONS**

<b><u>PROPERTY</u></b>	<b><u>METHOD</u></b>	<b><u>REQUIREMENT</u></b>
Color		Gray
Tensile Strain		29%
Cone Penetration Flow	ASTM D5329	7% Maximum
Aggregate Settlement		3 mm Maximum
Flexibility, lab std. condition	ASTM D3111	No cracking or loss of aggregate adhesion
Impact Testing	ASTM D3111	No cracking, chipping, or separation @ 6ft-lb
Resilience		50% Minimum
Min. Application Temp.		300°F
Max. Heating Temp.		400°F
Specific Gravity	ASTM D5329	1.8 -2.1

### **SITE PREPARATION**

The area to be replaced shall be removed by saw cutting, jackhammering, or milling to the specified width and depth. The repair surfaces will be cleaned and dried with a hot air lance. The recessed area and vertical walls will be treated with a primer agent to promote adhesion and prevent moisture intrusion (for concrete applications only).

### **INSTALLATION**

Installation of the material shall be by factory trained and certified installation professionals and done according to the manufacturer's recommendations. Installers are to certify that material has not exceeded manufacturer's assigned expiration date or shelf life.

Heat the material in a thermostatically controlled purpose built mixer, having a horizontal agitator that ensures complete mixing. Once the material has reached the manufacturer's

recommended temperature, the molten material will be introduced into the prepared repair area, sealing the bottom of the repair from water intrusion.

If the depth of the repair exceeds 1 inch, the remainder of the repair process will consist of layering coarse hot angular aggregate (cleaned and dried) at a rate of 25%-35% by volume with the molten material until within ¾" of the top of the repair. The bulking aggregate must be worked into the patch completely.

**NO DRY LAYERS OF BULKING AGGREGATE WILL BE ALLOWED.**

The final ¾" of the repair will be material for optimum flexibility of the repair. Once this top layer has been screeded to a level grade, apply a high polish stone value (PSV) aggregate to the top of the repair to ensure proper skid resistance.

All removed materials and residual repair materials will be recovered and disposed of away from the site at the Contractor's expense.

### **DIAMOND GRINDING**

If diamond grinding will be required after placing the polymer modified partial depth patch:

1. Repair spalls a minimum of 24 hours before diamond grinding.
2. Assess the size and frequency of repairs to be made. For large spalls where it is possible for more than 1 grinder wheel to be simultaneously on the patched area, fortify the final layer of material. To fortify the top layer add 20-30% structural aggregate to the mastic compound. It is acceptable to leave the top slightly rough since the Diamond Grinding will smooth the surface.
  - a. If the structural aggregate has evidence of moisture, heat and dry the aggregate to 300°F (149°C) in a vented barrel mixer before application. The structural aggregate can be applied after the aggregate has been heated or when the aggregate is at ambient temperature. If Contractor chooses to increase the structural aggregate volume, heating the aggregate prior to application may be necessary to adequately coat the aggregate, eliminate trapped air, and ensure adhesion. Use manufacturer suggested aggregate or other aggregate approved by the Engineer.
3. Make sure the final layer of partial depth patching material is covered with surfacing aggregate as specified by the manufacturer.
4. Reduce weight and time grinding.
  - a. Assure that all or most of the wheels on the grinder are on solid pavement when grinding to minimize the load on the patch when grinding.
  - b. When grinding large repairs, float the grinding head to remove the downward load. Have the head or wheels skim the surface of the material to level and smooth the surface without sinking into the material and creating excessive fins.
5. Grind over partial depth repairs during the coolest temperatures possible. Minimize high-ambient temperatures.
6. Keep the grinding head as cool as possible.



### MEASUREMENT

The Department will measure the quantity of PARTIAL DEPTH PATCHING-POLYMER MOD in cubic feet, from field measurements or from the metered quantity from the mixer, as determined by the Engineer.

### PAYMENT

The Department will make payment for the completed and accepted quantities under the following:

<u>Code</u>	<u>Pay Item</u>	<u>Pay Unit</u>
24997EC	PARTIAL DEPTH PATCHING-POLYMER MOD	Cubic Foot

The Department will consider payment as full compensation for all work required in this special note.

Acceptable products to meet this specification are Fibrecrete G and Crafcote Techcrete (R or TBR). Other products that fully meet this specification will also be accepted if approved by the Engineer.

August 13, 2019

## **SPECIAL NOTE FOR CONCRETE PAVEMENT JOINT AND RANDOM CRACK SEALING**

### **I. DESCRIPTION**

Except as specified herein, perform all work in accordance with the Department's 2019 Standard and Supplemental Specifications, Special Notes and Special Provisions, and Standard and Sepia Drawings, current editions, as applicable. Article references are to the Standard Specifications. Furnish all materials, labor, equipment, and incidentals for the following work:

Saw, Clean, and Reseal Longitudinal Joints, Transverse Joints, and Random Cracks.

### **II. MATERIALS**

The Department will sample and test all materials according to the Department's Sampling Manual. Make the materials available for sampling a sufficient time in advance of the use of the materials to allow for the necessary time for testing, unless otherwise specified in these notes.

**A. Joint Sealant.** Contrary to Section 501.03.18 (B), use hot poured elastic, no alternates.

### **III. CONSTRUCTION METHODS**

**A. Site Preparation.** Be responsible for all site preparation, including, but not limited to, removal of all obstructions or any other items; disposal of materials; sweeping and removal of debris; and any other incidentals. All site preparation shall be only as approved or directed by the Engineer.

**B. Sealing Joints and Random Cracks.** Saw cut, clean, and reseal longitudinal, transverse, and random cracks within the project limits as directed by the Engineer. Contrary to Standard Drawing RPX- 015-04, saw cut the joint or crack a minimum of 1/8 inch wider than the existing joint or crack or to the width necessary to provide a clean, new face for a reservoir for the new seal. Except as provided herein, perform all joint and crack sealing according to section 501.03.18(F) except random cracks only need to be routed to a depth of approximately one inch.

### **IV. METHOD OF MEASUREMENT**

Except as provided herein, the Department will measure all work in accordance with the 2019 Standard and Supplemental Specifications, Special Provisions and Special Notes, and Standard and Sepia Drawings, current editions. The Department will measure only the bid items listed. Consider all other items required to complete the work as incidental to the listed items.

**A. Site Preparation.** Other than the bid items listed, the Department will not measure Site Preparation for payment, but shall be incidental to the other items of the work, as applicable.

**B. Saw-Clean-Reseal Joints and Random Cracks.** The Department will measure sawed and resealed joints and random cracks in linear feet along the joint or crack. The Department will not measure removing existing joint material or cleaning joints but shall be incidental to Saw-Clean-Reseal Joints and Random Cracks.

August 13, 2019

**V. BASIS OF PAYMENT**

The Department will make direct payment only for the bid items listed. Consider all other items required to complete the construction to be incidental to the bid items listed.

**A. Saw-Clean-Reseal Joints and Random Cracks.** Accept payment at the contract unit price per linear foot of each type as full compensation for all materials, equipment, labor and incidentals necessary to complete the work as specified.

<u>CODE</u>	<u>PAY ITEM</u>	<u>PAY UNIT</u>
02115	Saw-Clean-Reseal Transverse Joint	Linear Foot
02116	Saw-Clean-Reseal Longitudinal Joint	Linear Foot
021173EC	Saw-Clean-Reseal Random Cracks	Linear Foot





### **SPECIAL NOTE FOR CONCRETE SLURRY**

If diamond grinding, grooving or any other process which produces slurry is required on roadways or bridges, the contractor shall ensure that all concrete slurry associated with these processes is collected, managed, and disposed of appropriately. The waste material shall be disposed of at a permitted disposal facility, in accordance with the Kentucky Standard Specifications for Road and Bridge Construction and the Environmental Performance Standards outlined in 401 KAR 47:030, or managed as a material for beneficial reuse. Any fines or remediation related to improper disposal shall be the sole responsibility of the contractor.

Disposal of concrete slurry will not be paid separately and shall be considered incidental to other bid items.

8/20/2019

	KENTUCKY TRANSPORTATION CABINET Department of Highways DIVISION OF RIGHT OF WAY & UTILITIES  <b>RIGHT OF WAY CERTIFICATION</b>	TC 62-226 Rev. 01/2016 Page 1 of 1
--	--	--

<input checked="" type="checkbox"/>	Original	<input type="checkbox"/>	Re-Certification	<b>RIGHT OF WAY CERTIFICATION</b>		
<b>ITEM #</b>		<b>COUNTY</b>		<b>PROJECT # (STATE)</b>		<b>PROJECT # (FEDERAL)</b>
5-20032		Jefferson		FD52 056 031W 014-015		NHPP 0311 (035)
<b>PROJECT DESCRIPTION</b>						
Small concrete repair project with some slab replacements and patching from MP 14.511 to 14.999 on US 31W						
<input checked="" type="checkbox"/>	<b>No Additional Right of Way Required</b>					
Construction will be within the limits of the existing right of way. The right of way was acquired in accordance to FHWA regulations under the Uniform Relocation Assistance and Real Property Acquisitions Policy Act of 1970, as amended. No additional right of way or relocation assistance were required for this project.						
<input type="checkbox"/>	<b>Condition # 1 (Additional Right of Way Required and Cleared)</b>					
All necessary right of way, including control of access rights when applicable, have been acquired including legal and physical possession. Trial or appeal of cases may be pending in court but legal possession has been obtained. There may be some improvements remaining on the right-of-way, but all occupants have vacated the lands and improvements, and KYTC has physical possession and the rights to remove, salvage, or demolish all improvements and enter on all land. Just Compensation has been paid or deposited with the court. All relocations have been relocated to decent, safe, and sanitary housing or that KYTC has made available to displaced persons adequate replacement housing in accordance with the provisions of the current FHWA directive.						
<input type="checkbox"/>	<b>Condition # 2 (Additional Right of Way Required with Exception)</b>					
The right of way has not been fully acquired, the right to occupy and to use all rights-of-way required for the proper execution of the project has been acquired. Some parcels may be pending in court and on other parcels full legal possession has not been obtained, but right of entry has been obtained, the occupants of all lands and improvements have vacated, and KYTC has physical possession and right to remove, salvage, or demolish all improvements. Just Compensation has been paid or deposited with the court for most parcels. Just Compensation for all pending parcels will be paid or deposited with the court prior to AWARD of construction contract						
<input type="checkbox"/>	<b>Condition # 3 (Additional Right of Way Required with Exception)</b>					
The acquisition or right of occupancy and use of a few remaining parcels are not complete and/or some parcels still have occupants. All remaining occupants have had replacement housing made available to them in accordance with 49 CFR 24.204. KYTC is hereby requesting authorization to advertise this project for bids and to proceed with bid letting even though the necessary right of way will not be fully acquired, and/or some occupants will not be relocated, and/or the just compensation will not be paid or deposited with the court for some parcels until after bid letting. KYTC will fully meet all the requirements outlined in 23 CFR 635.309(c)(3) and 49 CFR 24.102(j) and will expedite completion of all acquisitions, relocations, and full payments after bid letting and prior to AWARD of the construction contract or force account construction.						
Total Number of Parcels on Project		EXCEPTION (S) Parcel #		ANTICIPATED DATE OF POSSESSION WITH EXPLANATION		
Number of Parcels That Have Been Acquired						
Signed Deed						
Condemnation						
Signed ROE						
Notes/ Comments (Use Additional Sheet if necessary)						
<b>LPA RW Project Manager</b>				<b>Right of Way Supervisor</b>		
Printed Name				Printed Name		Tom Boykin
Signature				Signature		Tom Boykin <small>Digitally signed by Tom Boykin Date: 2019.08.13 12:46:34 -04'00'</small>
Date				Date		
<b>Right of Way Director</b>				<b>FHWA</b>		
Printed Name				Printed Name		No Signature Required as per FHWA-KYTC
Signature		 <small>Digitally signed by DM Loy Date: 2019.08.13 14:21:45 -04'00'</small>		Signature		Current Stewardship Agreement
Date				Date		

## UTILITIES AND RAIL CERTIFICATION NOTE

**JEFFERSON COUNTY, NHPP 0311 (035))  
FD 52 056 031W 014-015)  
US31W/ Dixie Highway Pavement Rehabilitation  
5-20032.00)**

*Utility coordination efforts conducted by the project sponsor have determined that no significant utility relocation work is required to complete the project. Any work pertaining to these utility facilities is defined in the bid package and is to be carried out as instructed by the Kentucky Transportation Cabinet. The contractor will be responsible for any coordination or adjustments that are discussed or quantified in the proposal.*

### THE FOLLOWING RAIL COMPANIES HAVE FACILITIES IN CONJUNCTION WITH THIS PROJECT AS NOTED

No Rail Involved     Minimal Rail Involved (See Below)     Rail Involved (See Below)

### UNDERGROUND FACILITY DAMAGE PROTECTION – BEFORE YOU DIG

The contractor shall make every effort to protect underground facilities from damage as prescribed in the Underground Facility Damage Protection Act of 1994, Kentucky Revised Statute KRS 367.4901 to 367.4917. It is the contractor's responsibility to determine and take steps necessary to be in compliance with federal and state damage prevention directives. The contractor is instructed to contact KY 811 for the location of existing underground utilities. Contact shall be made a minimum of two (2) and no more than ten (10) business days prior to excavation.

The contractor shall submit Excavation Locate Requests to the Kentucky Contact Center (KY 811) via web ticket entry. The submission of this request does not relieve the contractor from the responsibility of contacting non-member facility owners, whom are to be contacted through their individual Protection Notification Center. It may be necessary for the contractor to contact the County Court Clerk to determine what utility companies have facilities in the area. Non-compliance with these directives can result in the enforcement of penalties.

### SPECIAL CAUTION NOTE – PROTECTION OF UTILITIES

The contractor will be responsible for contacting all utility facility owners on the subject project to coordinate his activities. The contractor will coordinate his activities to minimize and, where possible, avoid conflicts with utility facilities. Due to the nature of the work proposed, it is unlikely to conflict with the existing utilities beyond minor facility adjustments. Where conflicts with utility facilities are unavoidable, the contractor will coordinate any necessary relocation work with the facility owner and Resident Engineer. The

Kentucky Transportation Cabinet maintains the right to remove or alter portions of this contract if a utility conflict occurs.



## UTILITIES AND RAIL CERTIFICATION NOTE

**JEFFERSON COUNTY, NHPP 0311 (035))  
FD 52 056 031W 014-015)  
US31W/ Dixie Highway Pavement Rehabilitation  
5-20032.00)**

The utility facilities as noted in the previous section(s) have been determined using data garnered by varied means and with varying degrees of accuracy: from the facility owners, a result of S.U.E., field inspections, and/or reviews of record drawings. The facilities defined may not be inclusive of all utilities in the project scope and are not Level A quality, unless specified as such. It is the contractor’s responsibility to verify all utilities and their respective locations before excavating.

***Please Note: The information presented in this Utility Note is informational in nature and the information contained herein is not guaranteed.***

### AREA UTILITIES CONTACT LIST AS PROVIDED BY KY 811

	<u>Utility Company/Agency</u>	<u>Contact Name</u>	<u>Contact Information</u>
1.	LG&E KU (Electric) 820 West Broadway Louisville, KY 40202 LG&E Emergency Number (502) 589-1444 LG&E and KU Emergency Number 1-800-331-7370		Caroline Justice work: (502) 627-3708 <a href="mailto:caroline.justice@LGE-KU.com">caroline.justice@LGE-KU.com</a>
2.	LG&E (Gas) 820 West Broadway Louisville, KY 40202 Gas Emergency Number (502) 589-5511 LG&E and KU Emergency Number 1-800-331-7370		Caroline Justice work: (502) 627-3708 <a href="mailto:caroline.justice@LGE-KU.com">caroline.justice@LGE-KU.com</a>
3.	Louisville Water Company 550 South Third Street Louisville, KY 40202		Daniel Tegene, PE (502) 569-3649 <a href="mailto:DTegene@LWCky.com">DTegene@LWCky.com</a>
4.	AT&T KY 1340 E. John Rowan Blvd Bardstown, KY 40004		Scott Roche <a href="mailto:sr8832@att.com">sr8832@att.com</a> Office - (502) 348-4528 Cell – (502) 827-4703
5.	Metropolitan Sewer District 700 West Liberty Street Louisville, KY 40203-1911		Brandon Flaherty <a href="mailto:Brandon.Flaherty@LouisvilleMSD.org">Brandon.Flaherty@LouisvilleMSD.org</a> Office: (502) 540-6632

## UTILITIES AND RAIL CERTIFICATION NOTE

**JEFFERSON COUNTY, NHPP 0311 (035))  
FD 52 056 031W 014-015)  
US31W/ Dixie Highway Pavement Rehabilitation  
5-20032.00)**

Cell: (502) 381-0804  
Greg Powell  
[Greg.Powell@LouisvilleMSD.org](mailto:Greg.Powell@LouisvilleMSD.org)

6. Charter Communications  
10168 Linn Station Road  
Suite 120  
Louisville, KY 40223

**Facility Map Requests:**  
Nathen L Howerton  
[Nathen.Howerton@charter.com](mailto:Nathen.Howerton@charter.com)

James Whitehouse  
(502) 643-0863  
[James.Whitehouse@charter.com](mailto:James.Whitehouse@charter.com)

Kevin Mercer  
(502) 817-5055 – Cell  
(502) 357-4724 - Office  
[kevin.mercer@charter.com](mailto:kevin.mercer@charter.com)

7. Texas Gas Transmission, LLC  
2332 Hwy 60 West  
Hardinsburg, KY 40143

Kevin Carman  
[Kevin.Carman@bwpmlp.com](mailto:Kevin.Carman@bwpmlp.com)  
Cell: (270) 779-3893

610 W 2<sup>nd</sup> Street  
PO Box 20008  
Owensboro, KY 42301

Amanda Isom  
[Amanda.Isom@bwpmlp.com](mailto:Amanda.Isom@bwpmlp.com)  
(270) 688-5854  
(270) 231-7629

10327 Gaslight Way  
Louisville, KY 40299

Thomas Spargo  
[trey.spargo@bwpmlp.com](mailto:trey.spargo@bwpmlp.com)  
502-438-2408

8. Marathon Pipeline, LLC  
539 South Main Street, Room X-05-018  
Findlay, OH 45840  
OR  
20-C Industrial Drive  
Lexington, OH 44904

Dennis Durnal  
Office – (502) 448-8311  
Cell – (419) 581-0038  
[ddurnal@marathonpetroleum.com](mailto:ddurnal@marathonpetroleum.com)  
Greg Newman  
[gnewman@marathonpetroleum.com](mailto:gnewman@marathonpetroleum.com)  
Office - (419) 884-0800x236

## UTILITIES AND RAIL CERTIFICATION NOTE

**JEFFERSON COUNTY, NHPP 0311 (035))  
FD 52 056 031W 014-015)  
US31W/ Dixie Highway Pavement Rehabilitation  
5-20032.00)**

Cell – (419) 564-8826

**Send to both contacts above**

Aron Velasquez

Office – (419) 421-3704

[advelasquez@marathonpetroleum.com](mailto:advelasquez@marathonpetroleum.com)

9. Indiana Gas Company Inc  
d.b.a. Vectren Energy Delivery of Indiana, Inc  
or  
Ohio River Pipeline Corporation  
2520 Lincoln Drive  
Clarksville, Indiana 47129

Mary Barber

[MBarber@Vectren.com](mailto:MBarber@Vectren.com)

(812) 948-4952

**Line Maintained By**

Texas Gas Transmission, LLC  
3800 Frederica Street  
Owensboro, Kentucky 42302  
Cell: (270) 485-1152

10. Indiana Utilities Corporation  
123 West Chestnut Street  
Corydon, Indiana 47112  
(812) 738-3235

Scott Schmitt

Office (812) 738-3235

Cell (812) 972-0539

[scotts@indianautilitiescorp.com](mailto:scotts@indianautilitiescorp.com)

Corey Thatcher, Field Technician

Office (812) 738-3235

Cell (812) 267-6936

[coreyt@indianautilitiescorp.com](mailto:coreyt@indianautilitiescorp.com)

Kevin Kinney

Ron Timberlake

11. Sprint - Fiber Optics  
11370 Enterprise Park Dr.  
Sharonville, OH 45241

Steven T. Hughes

[Steven.Hughes@sprint.com](mailto:Steven.Hughes@sprint.com)

Office (513) 459-5796

Cell (513) 462-7221



## UTILITIES AND RAIL CERTIFICATION NOTE

**JEFFERSON COUNTY, NHPP 0311 (035))  
FD 52 056 031W 014-015)  
US31W/ Dixie Highway Pavement Rehabilitation  
5-20032.00)**

- 12.** Mid - Valley Pipeline Company  
4910 Limaburg Road  
Burlington, KY 41005  
FAX (866) 699-1185  
Richard (Todd) Calfee  
(859) 371-4469x14  
Cell: 859-630-8271  
[RTCalfee@SunocoLogistics.com](mailto:RTCalfee@SunocoLogistics.com)
- 14.** Jefferson County Public Schools (JCPS)      Jeff Hardy  
C B Young  
Building 7  
3001 Crittenden Dr.  
Louisville, KY 40209  
Jeff.Hardy@Jefferson.kyschools.us  
(502) 379-9315  
Scott McMahan (Team Fishel)  
cell: (502) 664-9312  
office: (502) 456-2900  
  
\*\*Jeff's email keeps kicking back as undeliverable- CALL HIM.
- 15.** Kentucky Data Link (KDL now Windstream)  
111 S. Main St.  
Elizabethtown, KY 42071  
James Galvin  
Office: 270-765-1818  
Mobile: 270-748-9249  
[James.Galvin@windstream.com](mailto:James.Galvin@windstream.com)  
Mark Ware  
[Mark.Ware@windstream.com](mailto:Mark.Ware@windstream.com)  
**Send to both contacts**  
Timothy Gibson  
[Timothy.Gibson@Windstream.com](mailto:Timothy.Gibson@Windstream.com)  
**Emergency contact ONLY**  
  
[WCI.OSP.PERMITS@windstream.com](mailto:WCI.OSP.PERMITS@windstream.com)
- 16.** AT&T Legacy  
7555 E. Pleasant Valley Rd. – Suite 140  
Independence, OH 44131  
Mike Diederich  
[MD4145@att.com](mailto:MD4145@att.com)  
Phone - (216) 750-0135  
Cell - (216) 212-8556  
Don Garr  
[DRGarr@Hughes.net](mailto:DRGarr@Hughes.net)  
Cell - (502) 741-8374  
**Send to both contacts**
- 17.** City of Taylorsville Sewer & Water  
70 Taylorsville Rd., P O Box 279  
Harold Compton  
[HCompton@TaylorsvilleWater.org](mailto:HCompton@TaylorsvilleWater.org)

## UTILITIES AND RAIL CERTIFICATION NOTE

**JEFFERSON COUNTY, NHPP 0311 (035))  
FD 52 056 031W 014-015)  
US31W/ Dixie Highway Pavement Rehabilitation  
5-20032.00)**

Taylorsville, KY 40071  
Consultant: Kevin Sisler  
220 Reynolds Rd  
Lexington, KY 40517

(502) 477-3235  
Fax: (502) 477-1310  
[Kevin.@SislerMaggard.com](mailto:Kevin.@SislerMaggard.com)  
(859) 271-2978 (859) 509-3799  
Steve Biven-City Clerk  
[SBiven@taylorsvillewater.org](mailto:SBiven@taylorsvillewater.org)  
(502) 477-3235 ext. 106

18. CenturyLink  
260 Winn Ave  
Winchester, KY 40391

Jim Trapnell  
[jim.trapnell@centurylink.com](mailto:jim.trapnell@centurylink.com)  
Cell (859) 806-5833  
John Pellegrino  
[john.pellegrino@centurylink.com](mailto:john.pellegrino@centurylink.com)

CenturyLink National Network Construction  
3625 Brookside Parkway Suite 400  
Alpharetta, GA 30022

**Send Facility Map Requests to:**  
[CenturylinkNationalOSPRElocations@centurylink.com](mailto:CenturylinkNationalOSPRElocations@centurylink.com)

19. Shelby Energy Cooperative  
P.O. Box 311, 620 Old Finchville Road  
Shelbyville, KY 40065  
(502) 633-4420

Jason Ginn  
[Jason@ShelbyEnergy.com](mailto:Jason@ShelbyEnergy.com)  
cell: 502-643-2778

Zach Mischler  
[zach@shelbyenergy.com](mailto:zach@shelbyenergy.com)

**Send to both contacts**

20. Atmos Energy  
105 Hudson Blvd  
Shelbyville, KY 40065

Jake Basham  
cell: (270) 779-7381  
[Jake.Basham@AtmosEnergy.com](mailto:Jake.Basham@AtmosEnergy.com)  
Silas Bohlen  
[Silas.Bohlen@atmosenergy.com](mailto:Silas.Bohlen@atmosenergy.com)  
Cell: (270) 570-0445

**Send to both contacts**

21. Crown Castle Network Operations  
10300 Ormsby Park Place

John Demko  
[John.Demko@CrownCastle.com](mailto:John.Demko@CrownCastle.com)

## UTILITIES AND RAIL CERTIFICATION NOTE

**JEFFERSON COUNTY, NHPP 0311 (035))  
FD 52 056 031W 014-015)  
US31W/ Dixie Highway Pavement Rehabilitation  
5-20032.00)**

- |  |   |
|--|---|
| Suite 501<br>Louisville, KY 40223  | (724) 416-9188<br>Patrick Massie<br><a href="mailto:Patrick.Massie@crowncastle.com">Patrick.Massie@crowncastle.com</a><br>502 340-1403<br>Chris Gladstone<br><a href="mailto:Chris.Gladstone@CrownCastle.com">Chris.Gladstone@CrownCastle.com</a><br>(502) 689-2162 |
| <b>22.</b> Zayo<br>9209 Castlegate Dr<br>Indianapolis, IN 46256  | Ryan Burns<br><a href="mailto:ryan.burns@zayo.com">ryan.burns@zayo.com</a><br>Office: (317) 296-6048<br>Cell: (812) 589-9314  |
| <b>23.</b> MCI/Verizon(Owns WUTEL)<br>MCI/Verizon<br>730 West Henry Street<br>Indianapolis, IN 46225         | Jeff Tucker<br><a href="mailto:Jeffrey.tucker@verizon.com">Jeffrey.tucker@verizon.com</a><br>Office: (615) 777-7855   |
| <b>24.</b> TRIMARC<br>Public Safety & Transportation Systems<br>901 West Main Street<br>Louisville, KY 40202 | Todd Hood<br><a href="mailto:Todd.Hood@ngc.com">Todd.Hood@ngc.com</a><br>Office: (502) 290-7201<br>Cell: (270) 307-7456   |
| <b>25.</b> <del>Lightower/Fibertech</del> Crown Castle<br>3310 Ruckreigel Parkway<br>Jeffersontown, KY 40299 | Patrick Massie<br>Office- (502) 340-1403<br>Cell: (502) 604-5268  |
| <b>26.</b> Google Fiber<br>101 N. 7th Street, Ste 400<br>Louisville, KY 40202                                | Lewis Roberts<br>423-430-9853<br><a href="mailto:lewisrobertsjr@google.com">lewisrobertsjr@google.com</a><br><br>Jesse Quirion<br>650-214-3032<br><a href="mailto:jquirion@google.com">jquirion@google.com</a>  |

## UTILITIES AND RAIL CERTIFICATION NOTE

**JEFFERSON COUNTY, NHPP 0311 (035))  
FD 52 056 031W 014-015)  
US31W/ Dixie Highway Pavement Rehabilitation  
5-20032.00)**

27. Kentucky Wired  
209 St. Clair Street, 4<sup>th</sup> Floor  
  
Frankfort, KY 40601

Black&Veatch

Mike Hayden, Chief Operating Officer  
Office 502-782-2535

[Mike.Hayden@ky.gov](mailto:Mike.Hayden@ky.gov)

Harold Waters  
Lead Engineering Specialist,

Office (913) 458-1584

Cell (502) 612-8495

[watershw@bv.com](mailto:watershw@bv.com)

**Send to both contacts above**



**PART II**  
**SPECIFICATIONS AND STANDARD DRAWINGS**

### **SPECIFICATIONS REFERENCE**

Any reference in the plans or proposal to previous editions of the *Standard Specifications for Road and Bridge Construction* and *Standard Drawings* are superseded by *Standard Specifications for Road and Bridge Construction, Edition of 2019* and *Standard Drawings, Edition of 2016*.

## **SUPPLEMENTAL SPECIFICATIONS**

The contractor shall use the Supplemental Specifications that are effective at the time of letting.  
The Supplemental Specifications can be found at the following link:

<http://transportation.ky.gov/Construction/Pages/Kentucky-Standard-Specifications.aspx>

## **SPECIAL NOTE FOR PORTABLE CHANGEABLE MESSAGE SIGNS**

This Special Note will apply when indicated on the plans or in the proposal.

**1.0 DESCRIPTION.** Furnish, install, operate, and maintain variable message signs at the locations shown on the plans or designated by the Engineer. Remove and retain possession of variable message signs when they are no longer needed on the project.

### **2.0 MATERIALS.**

**2.1 General.** Use LED Variable Message Signs Class I, II, or III, as appropriate, from the Department's List of Approved Materials.

Unclassified signs may be submitted for approval by the Engineer. The Engineer may require a daytime and nighttime demonstration. The Engineer will make a final decision within 30 days after all required information is received.

**2.2 Sign and Controls.** All signs must:

- 1) Provide 3-line messages with each line being 8 characters long and at least 18 inches tall. Each character comprises 35 pixels.
- 2) Provide at least 40 preprogrammed messages available for use at any time. Provide for quick and easy change of the displayed message; editing of the message; and additions of new messages.
- 3) Provide a controller consisting of:
  - a) Keyboard or keypad.
  - b) Readout that mimics the actual sign display. (When LCD or LCD type readout is used, include backlighting and heating or otherwise arrange for viewing in cold temperatures.)
  - c) Non-volatile memory or suitable memory with battery backup for storing pre-programmed messages.
  - d) Logic circuitry to control the sequence of messages and flash rate.
- 4) Provide a serial interface that is capable of supporting complete remote control ability through land line and cellular telephone operation. Include communication software capable of immediately updating the message, providing complete sign status, and allowing message library queries and updates.
- 5) Allow a single person easily to raise the sign to a satisfactory height above the pavement during use, and lower the sign during travel.
- 6) Be Highway Orange on all exterior surfaces of the trailer, supports, and controller cabinet.
- 7) Provide operation in ambient temperatures from -30 to + 120 degrees Fahrenheit during snow, rain and other inclement weather.
- 8) Provide the driver board as part of a module. All modules are interchangeable, and have plug and socket arrangements for disconnection and reconnection. Printed circuit boards associated with driver boards have a conformable coating to protect against moisture.
- 9) Provide a sign case sealed against rain, snow, dust, insects, etc. The lens is UV stabilized clear plastic (polycarbonate, acrylic, or other approved material) angled to prevent glare.
- 10) Provide a flat black UV protected coating on the sign hardware, character PCB, and appropriate lens areas.
- 11) Provide a photocell control to provide automatic dimming.



11

- 12) Allow an on-off flashing sequence at an adjustable rate.
- 13) Provide a sight to aim the message.
- 14) Provide a LED display color of approximately 590 nm amber.
- 15) Provide a controller that is password protected.
- 16) Provide a security device that prevents unauthorized individuals from accessing the controller.
- 17) Provide the following 3-line messages preprogrammed and available for use when the sign unit begins operation:

/KEEP/RIGHT/=>=>=>/	/MIN/SPEED/**MPH/
/KEEP/LEFT/<=<=</	/ICY/BRIDGE/AHEAD/ /ONE
/LOOSE/GRAVEL/AHEAD/	LANE/BRIDGE/AHEAD/
/RD WORK/NEXT/**MILES/	/ROUGH/ROAD/AHEAD/
/TWO WAY/TRAFFIC/AHEAD/	/MERGING/TRAFFIC/AHEAD/
/PAINT/CREW/AHEAD/	/NEXT/***/MILES/
/REDUCE/SPEED/**MPH/	/HEAVY/TRAFFIC/AHEAD/
/BRIDGE/WORK/***0 FT/	/SPEED/LIMIT/**MPH/
/MAX/SPEED/**MPH/	/BUMP/AHEAD/
/SURVEY/PARTY/AHEAD/	/TWO/WAY/TRAFFIC/

\*Insert numerals as directed by the Engineer.

Add other messages during the project when required by the Engineer.

### 2.3 Power.

- 1) Design solar panels to yield 10 percent or greater additional charge than sign consumption. Provide direct wiring for operation of the sign or arrow board from an external power source to provide energy backup for 21 days without sunlight and an on-board system charger with the ability to recharge completely discharged batteries in 24 hours.

**3.0 CONSTRUCTION.** Furnish and operate the variable message signs as designated on the plans or by the Engineer. Ensure the bottom of the message panel is a minimum of 7 feet above the roadway in urban areas and 5 feet above in rural areas when operating. Use Class I, II, or III signs on roads with a speed limit less than 55 mph. Use Class I or II signs on roads with speed limits 55 mph or greater.

Maintain the sign in proper working order, including repair of any damage done by others, until completion of the project. When the sign becomes inoperative, immediately repair or replace the sign. Repetitive problems with the same unit will be cause for rejection and replacement.

Use only project related messages and messages directed by the Engineer, unnecessary messages lessen the impact of the sign. Ensure the message is displayed in either one or 2 phases with each phase having no more than 3 lines of text. When no message is needed, but it is necessary to know if the sign is operable, flash only a pixel.

When the sign is not needed, move it outside the clear zone or where the Engineer directs. Variable Message Signs are the property of the Contractor and shall be removed from the project when no longer needed. The Department will not assume ownership of these signs.

**4.0 MEASUREMENT.** The final quantity of Variable Message Sign will be

11

the actual number of individual signs acceptably furnished and operated during the project. The Department will not measure signs replaced due to damage or rejection.

**5.0 PAYMENT.** The Department will pay for the Variable Message Signs at the unit price each. The Department will not pay for signs replaced due to damage or rejection. Payment is full compensation for furnishing all materials, labor, equipment, and service necessary to, operate, move, repair, and maintain or replace the variable message signs. The Department will make payment for the completed and accepted quantities under the following:

<u>Code</u>	<u>Pay Item</u>	<u>Pay Unit</u>
02671	Portable Changeable Message Sign	Each

Effective June 15, 2012

11J

## **SPECIAL NOTE FOR FULL DEPTH CONCRETE PAVEMENT REPAIR**

This Special Note applies to full depth repairs of concrete pavement. Section references herein are to the Department's Standard Specifications for Road and Bridge Construction, current edition.

**1.0 DESCRIPTION.** Remove and replace concrete pavement. Comply with the applicable Standard Drawings and the Standard Specifications except as specifically superseded herein.

### **2.0 MATERIALS AND EQUIPMENT.**

**2.1 JPC Pavement.** Test concrete materials according to section 601.03.03. Conform to 501, 502, and 601 except that the concrete must achieve 3000 psi in accordance with Section 4.4 of this note. The Engineer may allow pavement to be opened to traffic at less than 3,000 psi subject to the deductions described in Section 4.4 of this note.

**2.2 Dowel Bars and Sleeves.** Conform to 811.

**2.3 Tie Bars.** Conform to Section 811. Use epoxy coated tie bars in longitudinal and transverse joints.

**2.4 Joint Sealants.** Conform to Subsection 807.03.01 or 807.03.05.

**2.5 Grout Adhesives and Epoxy Resin Systems.** Conform to Section 826.

**2.6 Dense Graded Aggregate (DGA) and Crushed Stone Base (CSB).** Conform to Section 805.

**2.7 Geotextile Fabric.** Conform to Section 843.

**2.8 Drills.** Drill holes using a gang drill, capable of drilling a minimum of four simultaneously. Misalignment of holes shall not exceed 1/4 inch in the vertical or oblique plane.

**2.9 Hammers.** Only use chisel point hammers weighing less than 40 pounds to remove deteriorated concrete.

### **3.0 CONSTRUCTION.**

**3.1 Removal of Existing Pavement.** Remove existing pavement to the extent the Contract specifies or as the Engineer directs. The minimum length of patches measured along centerline is 3 feet on each side of an existing joint.

When working with pavements with non-skewed transverse joints, if it is necessary to remove existing pavement closer than 6 feet to a transverse joint, remove the pavement 3 feet beyond that joint .

When working with pavements with skewed transverse joints, if it is necessary to remove existing pavement closer than 3 feet to a transverse joint, remove the pavement 3 feet beyond that joint.

Details of configurations of pavement and joints for various situations are depicted in the drawings herein.

11J

When small areas of removal and replacement are performed at bridge ends, maintain or reconstruct existing expansion joints at their existing location. When the Engineer determines extensive full width removal and replacement is required, construct new expansion joints at the locations shown on Standard Drawing No. RPN-010.

In the removal operation, make a full depth saw cut longitudinally along the centerline joint and shoulder joint and transversely along the area marked for removal. To prevent damage to the subbase, do not allow the saw to penetrate more than ½" into the subbase. The Engineer may direct or approve additional cuts within the removal area for ease of removal of the damaged slab and to prevent damage to adjacent pavement to remain in place. Do not overcut beyond the limits of the removal area. Prevent saw slurry from entering existing joints and cracks. To avoid pumping and erosion beneath the slab, do not allow traffic on sawed pavement for more than 48 hours before beginning removal procedures, unless directed by the Engineer.

Lift out the deteriorated concrete vertically with lift pins. If approved by the Engineer, use other methods that do not damage the base, shoulder, or sides of pavement that is to be left in place. If any damage does occur, repair as the Engineer directs and use an acceptable alternative method for the removal process. Do not damage the pavement base during these operations.

**3.2 Pavement Replacement.** Do not damage the pavement base during these operations.

**3.2.1 Preparation of Base.** Compact the new and existing aggregate base to the Engineer's satisfaction. The Engineer will accept compaction by either visual inspection or by nuclear gauge. When the Engineer deems it necessary to stabilize the existing base or replace unsuitable materials, excluding bridge ends, use 12 inches of geotextile fabric wrapped No. 2 aggregate topped with 4 inches of DGA or CSB. Use either Type III or Type IV geotextile fabric. Flowable fill and cement stabilization may be used as an alternative to stabilize the existing base or to replace unsuitable materials when a plan for such is presented to and approved by the Engineer. The Engineer may also direct using only DGA or CSB to correct base deficiencies. At bridge ends, treat existing base and subgrade as the Contract specifies. During compaction, wet the base as the Engineer directs. Compact areas not accessible to compaction equipment by hand tamping.

**3.2.2 Underdrains.** Construct, or repair damage to, pavement edge drains according to Section 704. If underdrains are placed omitting areas to be patched, construct additional lateral drains as necessary to provide outlets for the installed underdrain until performing the pavement replacement and completing the underdrain system. Provide drainage for any undercut or base repair areas.

**3.2.3 Pavement Replacement.** Using load transfer assemblies for dowel joints drill into the existing slab according to the details shown herein and on the Standard Drawings.

Use plain epoxy coated dowels of the size specified on the standard drawings based on the pavement thickness for contraction and expansion joints.

Drill holes for dowel bars and tie bars into the face of the existing slab, at a diameter as specified in the following. Drill the dowel bar holes and tie bar



11J

holes to a depth equal to 1/2 the length of the bars. Anchor tie bars into the existing pavement using an epoxy resin. Anchor dowel bars into the existing pavement using either an epoxy resin or an adhesive grout. For tie bars and dowel bars where an epoxy resin is to be used drill the holes 1/8 inch larger than the bar diameter. For dowel bars where an adhesive grout product is to be used, drill holes 1/4 inch larger than the bar diameter. Use a clear or opaque grout retention disk in both grout and epoxy applications. Operate the equipment to prevent damage to the pavement being drilled. Obtain the Engineer's approval of the drilling procedure. Install load transfer assemblies according to the Standard Drawings and Standard Specifications.

When indicated herein or in the Standard Drawings, use 1 inch deformed tie bars, 18 inches long on 30-inch centers and starting and ending 20 inches inside the edges of the repair area in the longitudinal joint. Use 1 inch deformed tie bars, or plain epoxy coated dowel bars sized in accordance with the Standard Drawings, 18 inches long beginning 12 inches inside of each edge and on 12-inch centers in transverse construction joints.

Install the dowels and tie bars according to Section 511 unless contradicted here. Ensure the holes are dry and free of dust and debris. Use a nozzle to insert the grout or epoxy starting at the back of the drilled hole to allow for full coating of the dowel or tie bar. After placement, use a bond breaker on the section of the dowel bar that is protruding from the hole.

Mix, place, finish, and cure concrete according to Section 501 with the exception that the Department will allow truck mixing, 2-bag mixers, and hand finishing.

When required, use a form on the side of the slab at longitudinal joints. When the adjacent traffic lane is not closed to traffic or the drop-off is not protected, temporarily fill the space between the form and the adjacent pavement with DGA. After placing the slab, remove the DGA and form. Fill the hole with concrete and thoroughly consolidate by rodding, spading, and sufficient vibration to form a dense homogeneous mass. Use a form on the side of the slab adjacent to shoulders. Excavate and backfill as shown on Section F'-F'.

For patches less than 25 feet in length, use a bond breaker and do not install tie bars at the longitudinal joint. Bond breakers should not exceed 1/8 inch in thickness, e.g. tar paper.

When resurfacing is required, a float finish is satisfactory. Otherwise, broom finish or, when the adjacent surface has a grooved finish, texture the surface according to Subsection 501.03.13 H). Finish the surface, including joints, to meet a surface tolerance of 1/8 inch in 10 feet that will be verified by straightedge. Cure the pavement and apply curing membranes according to 501.03.15.

Keep all pavement surfaces adjacent to this operation reasonably clean of excess grout and other materials at all times. Maintain all original longitudinal joints. Place transverse joints according to the details shown herein and on the Standard Drawings.

**3.3 Joint Sealing.** Seal all new or partially new joints with silicone rubber sealant or hot-poured elastic joint sealant according to Subsection 501.03.18.

#### **4.0 MEASUREMENT.**

**4.1 Remove JPC Pavement.** The Department will measure the quantity in square yards of surface area. The Department will not measure removal of

underlying base material for payment and will consider it incidental to Remove JPC Pavement.

**4.2 DGA or CSB.** The Department will measure the quantity used to stabilize the existing base or to replace unsuitable material in tons. The Department will not measure removal of existing base material or underlying material for payment and will consider incidental to DGA or CSB. The quantity of DGA used for the drop-off protection shall be incidental to this work and will not be measured for payment.

**4.3 JPC Pavement Non-Reinforced.** The Department will measure according to 501.04.01. The Department will not measure dowels, tie bars, or joint sealing for payment and will consider it incidental to Non-Reinforced JPC Pavement.

JPC Pavement will be paid according to section 5.0 below and according to the following payment schedule based on the compressive strength. The cylinders for payment will be tested two hours prior the scheduled opening of traffic.

3000 psi and up	100% payment
2750 to 3000 psi	75% payment and approval from the Engineer to open to traffic*
2500 to 2750 psi	50% payment and approval from the Engineer to open to traffic*
2250 to 2500 psi	25% payment and approval from the Engineer to open to traffic*
Below 2250 psi	10% payment and no potential to open to traffic. Maintain traffic closure until concrete reaches a minimum of 2250 psi.

\*If the Engineer approves opening to traffic, the Engineer will evaluate the concrete at 28 days (or sooner) to determine if the removal and replacement of the concrete is necessary due to pavement distress induced by the early opening (i.e. noticeable cracking). If required by the Engineer, remove and replace those slabs showing distress at no cost to the Department.

**4.4 Underdrains.** The Department will measure the quantity according to Subsection 704.04. The Department will not measure lateral drains for payment and will consider them incidental to the Underdrains.

**5.0 PAYMENT.** The Department will make payment for the completed and accepted quantities under the following:

<u>Code</u>	<u>Pay Item</u>	<u>Pay Unit</u>
----	Remove JPC Pavement	Square Yard
00001	DGA Base	Ton
00003	Crushed Stone Base	Ton
02069-02071, 02073, 02075, 02084, 02086, 02088	JPC Pavement Non-Reinforced, thickness	See Subsection 501.05
01000	Perforated Pipe, 4-inch	Linear Foot
02598, 02599	Fabric-Geotextile, Type	Square Yard

The Department will consider payment as full compensation for all work required in this provision.

June 15, 2012

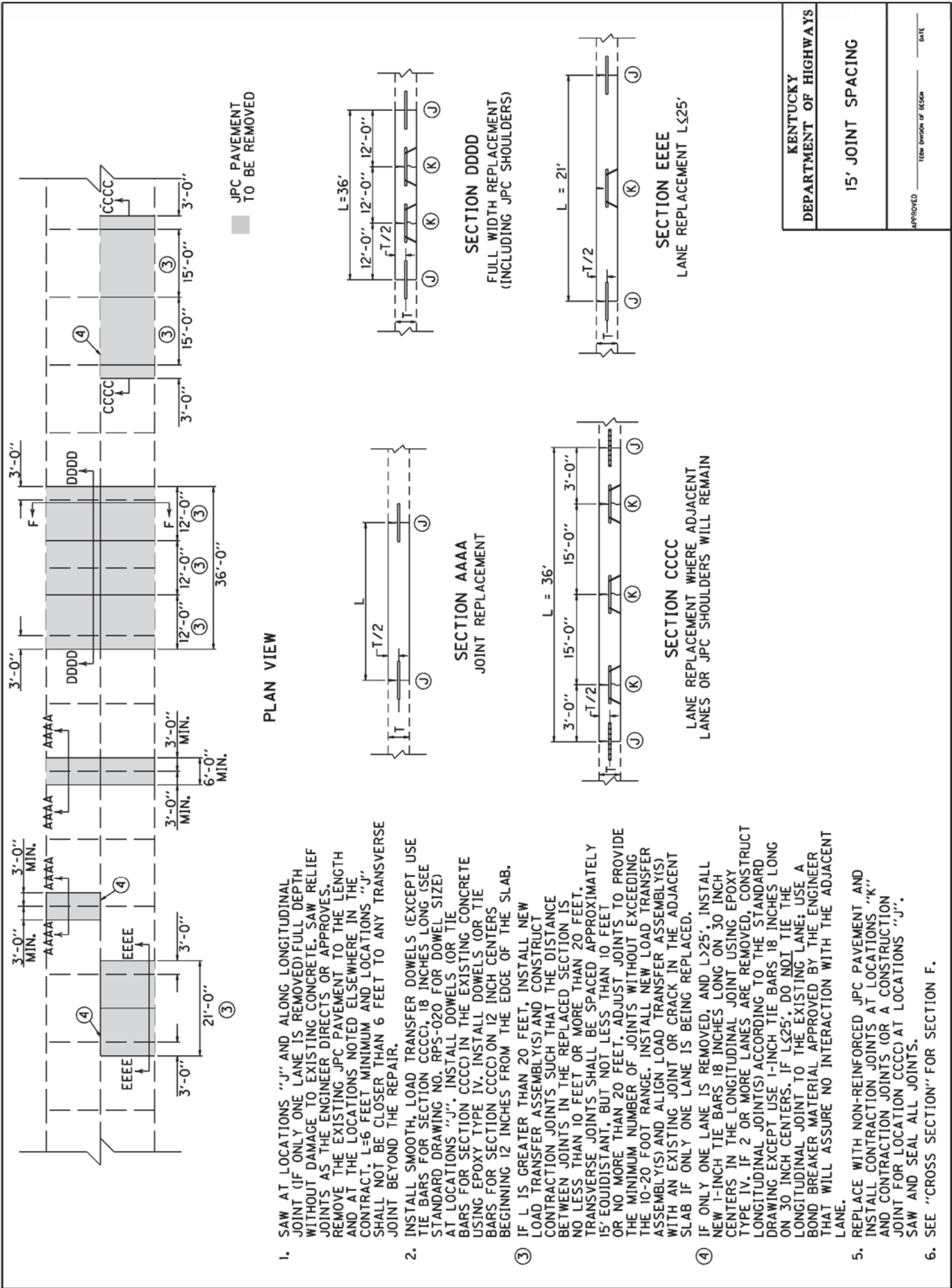

<b>KENTUCKY</b> <b>DEPARTMENT OF HIGHWAYS</b>
<b>15' JOINT SPACING</b>
APPROVED _____ DATE _____ <small>TERM DIVISION OF DESIGN</small>

1. SAW AT LOCATIONS "J" AND ALONG LONGITUDINAL JOINT (IF ONLY ONE LANE IS REMOVED) FULL DEPTH WITHOUT DAMAGE TO EXISTING CONCRETE; SAW RELIEF JOINTS AS THE ENGINEER DIRECTS OR APPROVES. REMOVE THE EXISTING JPC PAVEMENT TO THE LENGTH AND AT THE LOCATIONS NOTED ELSEWHERE IN THE CONTRACT. L=6 FEET MINIMUM AND LOCATIONS "J" SHALL NOT BE CLOSER THAN 6 FEET TO ANY TRANSVERSE JOINT BEYOND THE REPAIR.
2. INSTALL SMOOTH, LOAD TRANSFER DOWELS (EXCEPT USE TIE BARS FOR SECTION CCCC); 18 INCHES LONG (SEE STANDARD DRAWING NO. RPS-020 FOR DOWEL SIZE) AT LOCATIONS "J". INSTALL DOWELS (OR TIE BARS FOR SECTION CCCC) IN THE EXISTING CONCRETE USING EPOXY TYPE IV. INSTALL DOWELS (OR TIE BARS FOR SECTION CCCC) ON 12 INCH CENTERS BEGINNING 12 INCHES FROM THE EDGE OF THE SLAB.
3. IF L IS GREATER THAN 20 FEET, INSTALL NEW LOAD TRANSFER ASSEMBLY(S) AND CONSTRUCT CONTRACTION JOINTS SUCH THAT THE DISTANCE BETWEEN JOINTS IN THE REPLACED SECTION IS NO LESS THAN 10 FEET OR MORE THAN 20 FEET. TRANSVERSE JOINTS SHALL BE SPACED APPROXIMATELY 15' EQUIDISTANT, BUT NOT LESS THAN 10 FEET OR NO MORE THAN 20 FEET. ADJUST JOINTS TO PROVIDE THE MINIMUM NUMBER OF JOINTS WITHOUT EXCEEDING THE 10-20 FOOT RANGE. INSTALL NEW LOAD TRANSFER ASSEMBLY(S) AND ALIGN LOAD TRANSFER ASSEMBLY(S) WITH AN EXISTING JOINT OR CRACK IN THE ADJACENT SLAB IF ONLY ONE LANE IS BEING REPLACED.
4. IF ONLY ONE LANE IS REMOVED, AND L>25', INSTALL NEW 1-INCH TIE BARS 18 INCHES LONG ON 30 INCH CENTERS IN THE LONGITUDINAL JOINT USING EPOXY TYPE IV. IF 2 OR MORE LANES ARE REMOVED, CONSTRUCT LONGITUDINAL JOINT(S) ACCORDING TO THE STANDARD DRAWING EXCEPT USE 1-INCH TIE BARS 18 INCHES LONG ON 30 INCH CENTERS. IF L25', DO NOT TIE THE LONGITUDINAL JOINT TO THE EXISTING LANE; USE A BOND BREAKER MATERIAL APPROVED BY THE ENGINEER THAT WILL ASSURE NO INTERACTION WITH THE ADJACENT LANE.
5. REPLACE WITH NON-REINFORCED JPC PAVEMENT AND INSTALL CONTRACTION JOINTS AT LOCATIONS "K" AND CONTRACTION JOINTS (OR A CONTRACTION JOINT FOR LOCATION CCCC) AT LOCATIONS "J". SAW AND SEAL ALL JOINTS.
6. SEE "CROSS SECTION" FOR SECTION F.

1. SAW AT LOCATIONS "J" AND ALONG LONGITUDINAL JOINT (IF ONLY ONE LANE IS REMOVED) FULL DEPTH WITHOUT DAMAGE TO EXISTING CONCRETE. SAW RELIEF JOINTS AS THE ENGINEER DIRECTS OR APPROVES. REMOVE THE EXISTING JPC PAVEMENT TO THE LENGTH AND AT THE LOCATIONS NOTED ELSEWHERE IN THE CONTRACT. L=6 FEET MINIMUM AND LOCATIONS "J" SHALL NOT BE CLOSER THAN 6 FEET TO ANY TRANSVERSE JOINT BEYOND THE REPAIR.
2. INSTALL SMOOTH, LOAD TRANSFER DOWELS (EXCEPT USE TIE BARS FOR SECTION C), 18 INCHES LONG (SEE STANDARD DRAWING NO. RPS-020 FOR DOWEL SIZE) AT LOCATIONS "J". INSTALL DOWELS (OR TIE BARS FOR SECTION C) IN THE EXISTING CONCRETE USING EPOXY TYPE IV. INSTALL DOWELS (OR TIE BARS FOR SECTION C) ON 12 INCH CENTERS BEGINNING 12 INCHES FROM THE EDGE OF THE SLAB. IF L IS GREATER THAN 20 FEET, INSTALL NEW LOAD TRANSFER ASSEMBLY(S) AND CONSTRUCT CONTRACTION JOINTS SUCH THAT THE DISTANCE BETWEEN JOINTS IN THE REPLACED SECTION IS NO LESS THAN 10 FEET OR MORE THAN 20 FEET. TRANSVERSE JOINTS SHALL BE SPACED APPROXIMATELY 15' EQUIDISTANT, BUT NOT LESS THAN 10 FEET OR NO MORE THAN 20 FEET. ADJUST JOINTS TO PROVIDE THE MINIMUM NUMBER OF JOINTS WITHOUT EXCEEDING THE 10-20 FOOT RANGE. INSTALL NEW LOAD TRANSFER ASSEMBLY(S) AND ALIGN LOAD TRANSFER ASSEMBLY(S) WITH AN EXISTING JOINT OR CRACK IN THE ADJACENT SLAB IF ONLY ONE LANE IS BEING REPLACED.
3. IF ONLY ONE LANE IS REMOVED, AND L > 25', INSTALL NEW 1-INCH TIE BARS 18 INCHES LONG ON 30 INCH CENTERS IN THE LONGITUDINAL JOINT USING EPOXY TYPE IV. IF 2 OR MORE LANES ARE REMOVED, CONSTRUCT LONGITUDINAL JOINT(S) ACCORDING TO THE STANDARD DRAWING EXCEPT USE 1-INCH TIE BARS 18 INCHES LONG ON 30 INCH CENTERS. IF L > 25', DO NOT TIE THE LONGITUDINAL JOINT TO THE EXISTING LANE; USE A BOND BREAKER MATERIAL APPROVED BY THE ENGINEER THAT WILL ASSURE NO INTERACTION WITH THE ADJACENT LANE.
4. REPLACE WITH NON-REINFORCED JPC PAVEMENT AND INSTALL CONTRACTION JOINTS AT LOCATIONS "K" AND CONTRACTION JOINTS (OR A CONSTRUCTION JOINT FOR LOCATION C) AT LOCATIONS "J". SAW AND SEAL ALL JOINTS.
6. SEE "CROSS SECTION" FOR SECTION F.

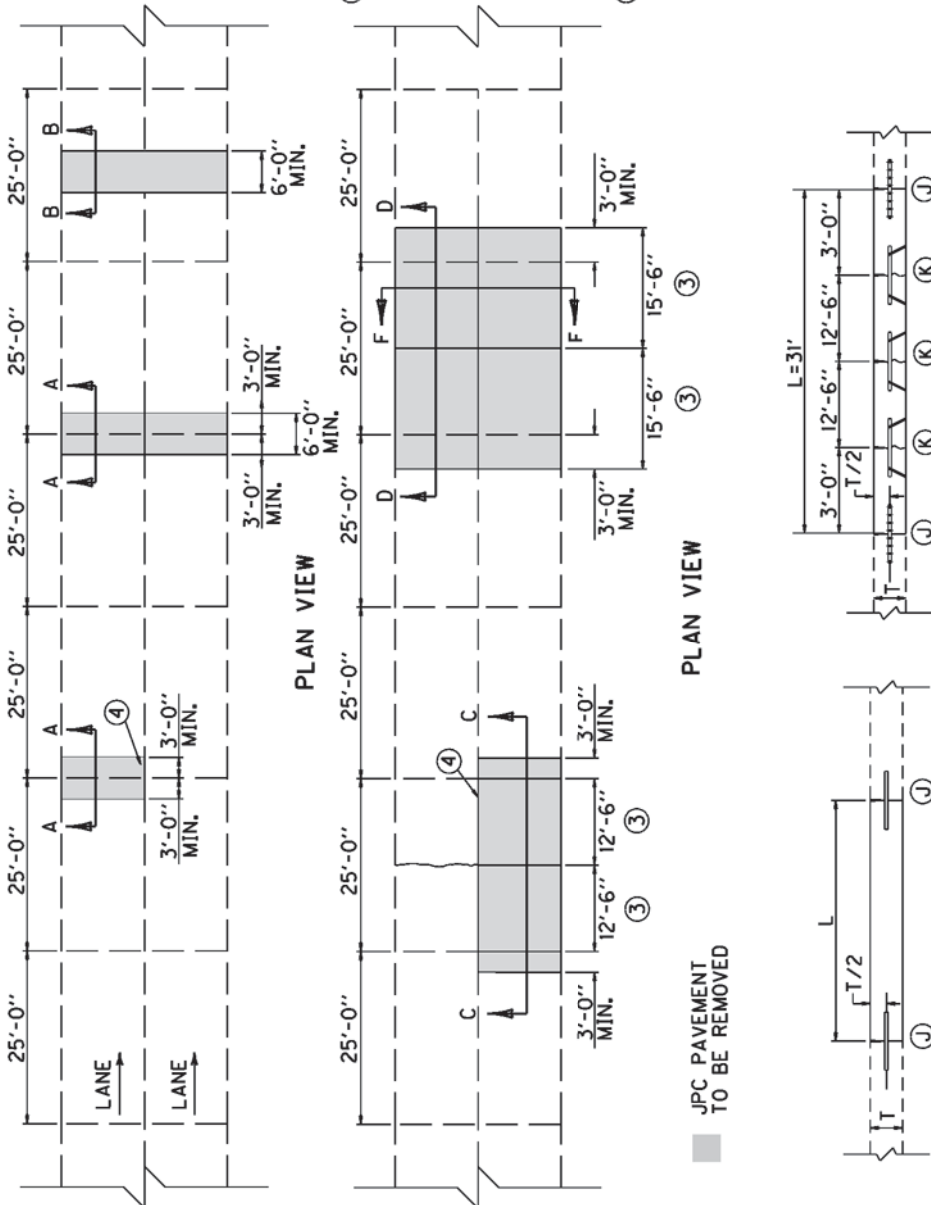

**SECTION A**  
JOINT REPLACEMENT

**SECTION B**  
MID-SLAB REPLACEMENT

**SECTION C**  
LANE REPLACEMENT WHERE ADJACENT LANES OR JPC SHOULDERS WILL REMAIN

**SECTION D**  
FULL WIDTH REPLACEMENT (INCLUDING JPC SHOULDERS)

<b>KENTUCKY DEPARTMENT OF HIGHWAYS</b>
<b>25' JOINT SPACING</b>
APPROVED _____ DATE _____ <small>TEAM DIVISION OF DESIGN</small>



1. SAW AT LOCATIONS "J" AND ALONG LONGITUDINAL JOINT (IF ONLY ONE LANE IS REMOVED) FULL DEPTH WITHOUT DAMAGE TO EXISTING CONCRETE. SAW RELIEF JOINTS AS THE ENGINEER DIRECTS OR APPROVES. REMOVE THE EXISTING JPC PAVEMENT TO THE LENGTH AND AT THE LOCATIONS NOTED ELSEWHERE IN THE CONTRACT. L=6 FEET MINIMUM AND LOCATIONS "J" SHALL NOT BE CLOSER THAN 6 FEET TO ANY TRANSVERSE JOINT BEYOND THE REPAIR.
2. INSTALL SMOOTH, LOAD TRANSFER DOWELS (EXCEPT USE TIE BARS FOR SECTION CC), 18 INCHES LONG (SEE STANDARD DRAWING NO. RPS-020 FOR DOWEL SIZE) AT LOCATIONS "J". INSTALL DOWELS OR TIE BARS FOR SECTION CC IN THE EXISTING CONCRETE USING EPOXY TYPE IV. INSTALL DOWELS OR TIE BARS FOR SECTION CC ON 12 INCH CENTERS BEGINNING 12 INCHES FROM THE EDGE OF THE SLAB.
3. IF L IS GREATER THAN 20 FEET, INSTALL NEW LOAD TRANSFER ASSEMBLY(S) AND CONSTRUCT CONTRACTION JOINTS SUCH THAT THE DISTANCE BETWEEN JOINTS IN THE REPLACED SECTION IS NO LESS THAN 10 FEET OR MORE THAN 20 FEET. TRANSVERSE JOINTS SHALL BE SPACED APPROXIMATELY 15' EQUIDISTANT, BUT NOT LESS THAN 10 FEET OR NO MORE THAN 20 FEET. ADJUST JOINTS TO PROVIDE THE MINIMUM NUMBER OF JOINTS WITHOUT EXCEEDING THE 10-20 FOOT RANGE. INSTALL NEW LOAD TRANSFER ASSEMBLY(S) AND ALIGN LOAD TRANSFER ASSEMBLY(S) WITH AN EXISTING JOINT OR CRACK IN THE ADJACENT SLAB IF ONLY ONE LANE IS BEING REPLACED.
4. IF ONLY ONE LANE IS REMOVED, AND L>25', INSTALL NEW 1-INCH TIE BARS 18 INCHES LONG ON 30 INCH CENTERS IN THE LONGITUDINAL JOINT USING EPOXY TYPE IV. IF 2 OR MORE LANES ARE REMOVED, CONSTRUCT LONGITUDINAL JOINT(S) ACCORDING TO THE STANDARD DRAWING EXCEPT USE 1-INCH TIE BARS 18 INCHES LONG ON 30 INCH CENTERS. IF L>25', DO NOT TIE THE LONGITUDINAL JOINT TO THE EXISTING LANE; USE A BOND BREAKER MATERIAL APPROVED BY THE ENGINEER THAT WILL ASSURE NO INTERACTION WITH THE ADJACENT LANE.
5. REPLACE WITH NON-REINFORCED JPC PAVEMENT AND INSTALL CONTRACTION JOINTS AT LOCATIONS "K" AND CONTRACTION JOINTS FOR A CONSTRUCTION JOINT FOR LOCATION CC AT LOCATIONS "J". SAW AND SEAL ALL JOINTS.
6. SEE "CROSS SECTION" FOR SECTION F.

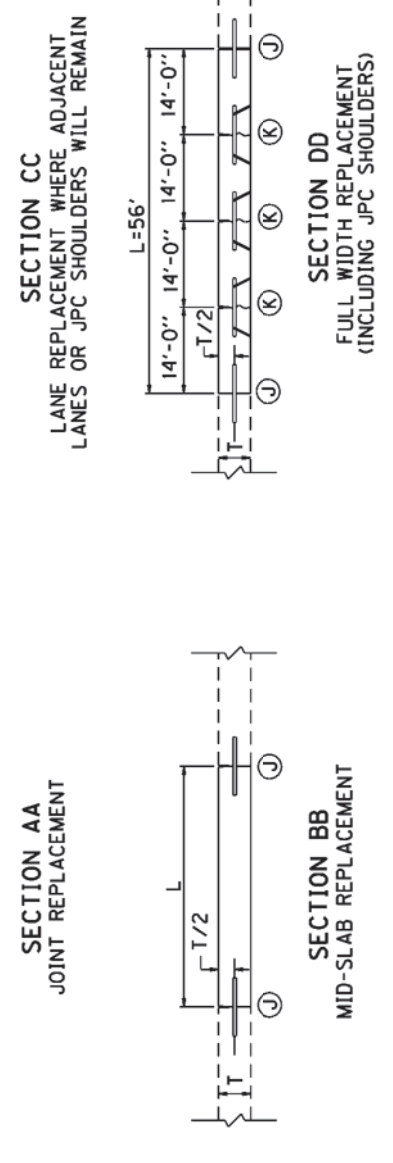
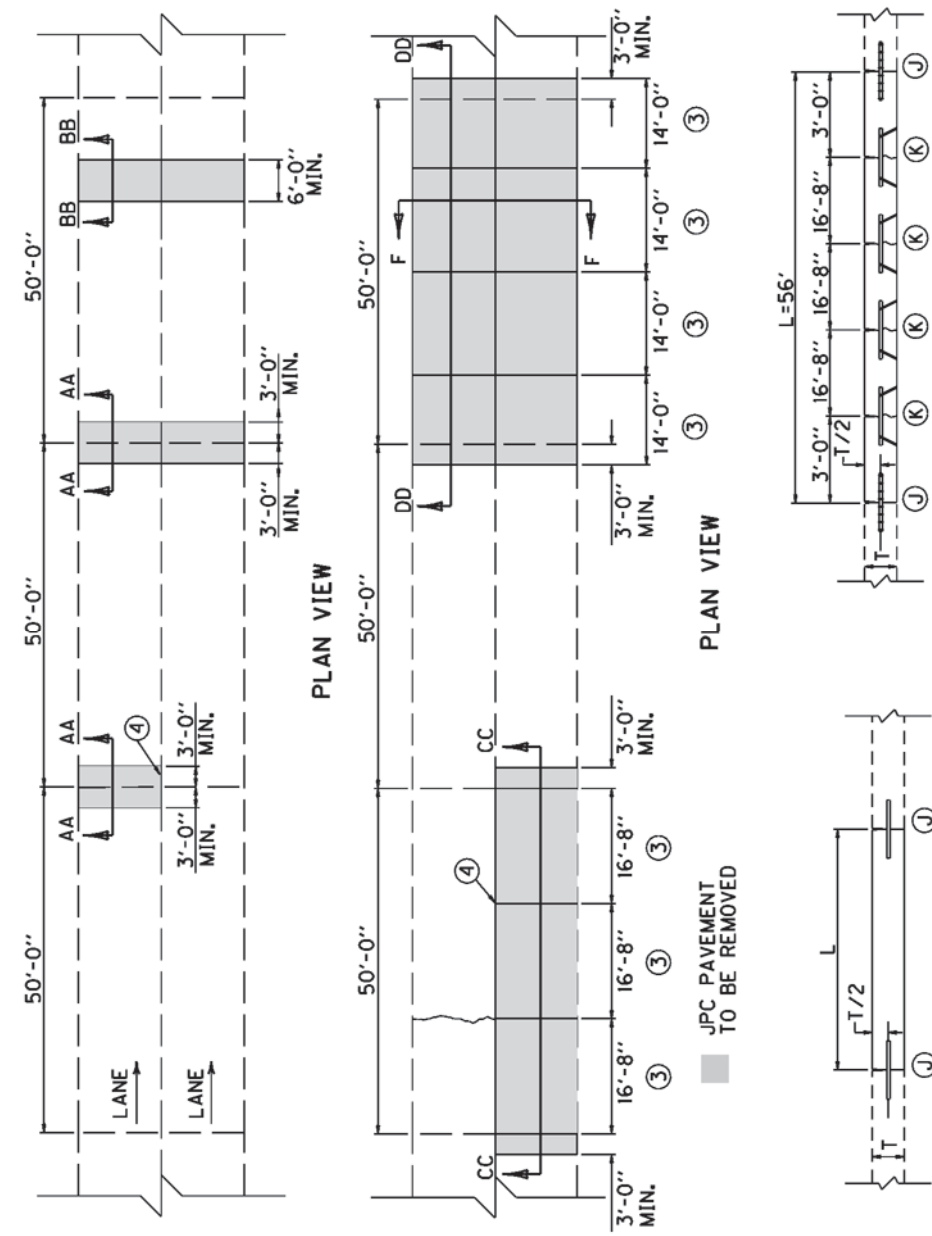

<b>KENTUCKY DEPARTMENT OF HIGHWAYS</b>
<b>50' JOINT SPACING</b>
SUBMITTED: _____ TEAM OFFICE OF DESIGN _____ DATE _____

1. SAW AT LOCATIONS "J" AND ALONG LONGITUDINAL JOINT (IF ONLY ONE LANE IS REMOVED) FULL DEPTH WITHOUT DAMAGE TO EXISTING CONCRETE. SAW RELIEF JOINTS AS THE ENGINEER DIRECTS OR APPROVES. REMOVE THE EXISTING JPC PAVEMENT TO THE LENGTH AND AT THE LOCATIONS NOTED ELSEWHERE IN THE CONTRACT. L=6 FEET MINIMUM AND LOCATIONS "J" SHALL NOT BE CLOSER THAN 6 FEET TO ANY TRANSVERSE JOINT BEYOND THE REPAIR.
2. INSTALL SMOOTH, LOAD TRANSFER DOWELS (EXCEPT USE TIE BARS FOR SECTION DDD), 18 INCHES LONG. (SEE STANDARD DRAWING NO. RPS-020 FOR DOWEL SIZE) AT LOCATIONS "J". INSTALL DOWELS (OR TIE BARS FOR SECTION DDD) IN THE EXISTING CONCRETE USING EPOXY TYPE IV. INSTALL DOWELS (OR TIE BARS FOR SECTION DDD) ON 12 INCH CENTERS BEGINNING 12 INCHES FROM THE EDGE OF THE SLAB. IF L IS GREATER THAN 20 FEET, INSTALL NEW LOAD TRANSFER ASSEMBLY(S) AND MATCH EXISTING JOINTS. INSTALL NEW LOAD TRANSFER ASSEMBLY(S) AND ALIGN LOAD TRANSFER ASSEMBLY(S) WITH EXISTING JOINTS IN ADJACENT SLABS.
- ④ IF ONLY ONE LANE IS REMOVED, AND  $L > 25'$ , INSTALL NEW 1-INCH TIE BARS 18 INCHES LONG ON 30 INCH CENTERS IN THE LONGITUDINAL JOINT USING EPOXY TYPE IV. IF 2 OR MORE LANES ARE REMOVED, CONSTRUCT LONGITUDINAL JOINT(S) ACCORDING TO THE STANDARD DRAWING EXCEPT USE 1-INCH TIE BARS 18 INCHES LONG ON 30 INCH CENTERS. IF  $L > 25'$ , DO NOT TIE THE LONGITUDINAL JOINT TO THE EXISTING LANE; USE A BOND BREAKER MATERIAL APPROVED BY THE ENGINEER THAT WILL ASSURE NO INTERACTION WITH THE ADJACENT LANE.
5. REPLACE WITH NON-REINFORCED JPC PAVEMENT AND INSTALL CONTRACTION JOINTS AT LOCATIONS "K". AND CONTRACTION JOINTS (OR A CONSTRUCTION JOINT FOR LOCATION DDD) AT LOCATIONS "J". SAW AND SEAL ALL JOINTS.
6. SEE "CROSS SECTION" FOR SECTION F.

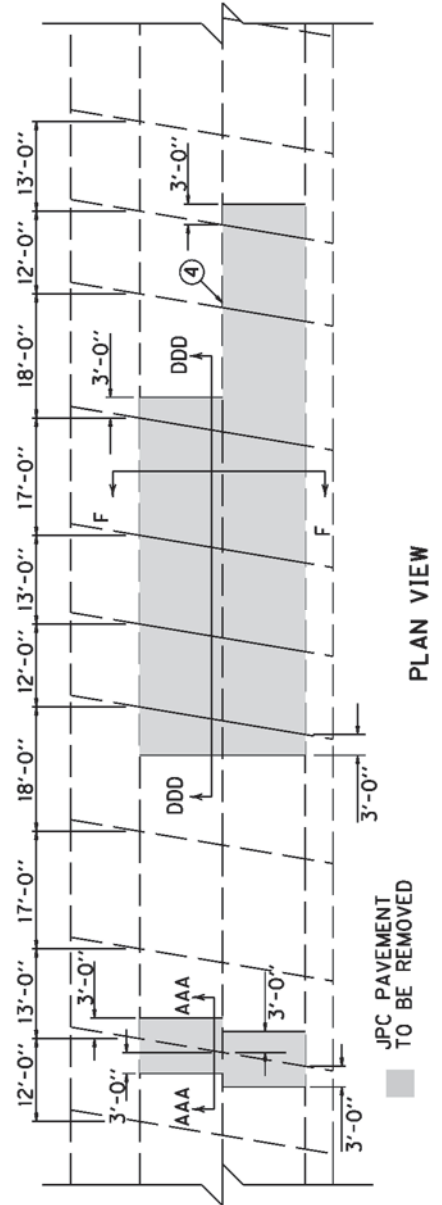

PLAN VIEW



SECTION AAA  
JOINT REPLACEMENT

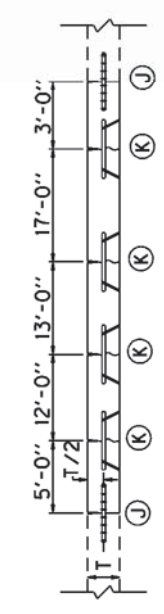

SECTION DDD  
LANE REPLACEMENT  
(ALWAYS MATCH EXISTING JOINTS)

KENTUCKY DEPARTMENT OF HIGHWAYS
RANDOM SKEWED
APPROVED _____ DATE _____ TECHNICAL ENGINEER

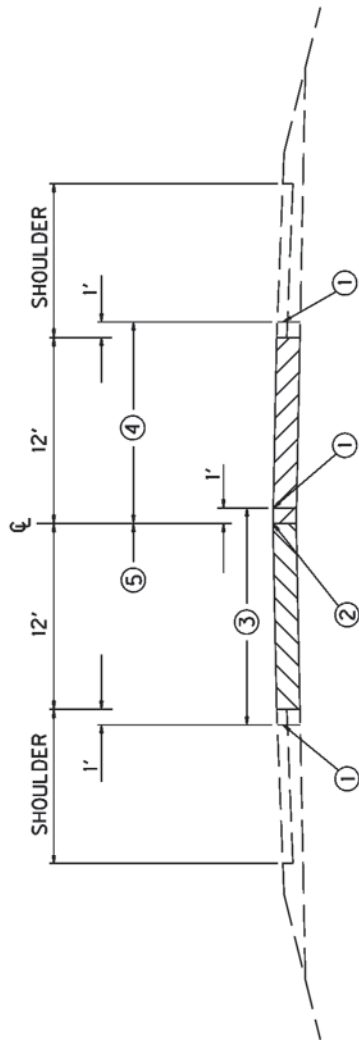

SECTION F

- ① SAW-CUT LINE. THIS ONE FOOT IS TO ALLOW FOR A FORM AND THE REMOVAL AND REPLACEMENT SHALL BE INCIDENTAL TO THE WORK, EXCEPT NEW ASPHALT MIXTURE SHALL BE PAID DIRECT ON A TONNAGE BASIS, AND NEW JPC PAVEMENT WILL BE PAID BY THE SQUARE YARD. COMPACT THE DGA BASE BY MECHANICAL TAMPERS TO THE ENGINEER'S SATISFACTION.
- ② EXISTING LONGITUDINAL JOINT.
- ③ FIRST SLAB REMOVAL LIMITS AND REPLACE 12-FOOT LANE.
- ④ SECOND SLAB REMOVAL LIMITS AND REPLACE 12-FOOT LANE.
- ⑤ THIS ONE FOOT IS TO ALLOW FOR A FORM ON THE FIRST POUR, AND A TEMPORARY PAVEMENT IS REQUIRED. THE DEPARTMENT WILL NOT REQUIRE REMOVAL OF THIS ONE FOOT IF THE GRADE OF THE EXISTING PAVEMENT IS ADEQUATE TO ENSURE THE NEW CONCRETE CAN BE PLACED AND FINISHED TO THE SATISFACTION OF THE ENGINEER. ANY TEMPORARY PAVEMENT IS INCIDENTAL TO JPC PAVEMENT.
6. THE ABOVE DRAWING DEPICTS THE ORDER OF SLAB REMOVAL WHEN BOTH ARE TO BE REMOVED AT THE SAME LOCATION. WHEN ONLY ONE SLAB OR LANE IS TO BE REMOVED, REMOVE AND REPLACE ACCORDING TO SECTION C, CC, OR CCCC. TRAFFIC CONTROL WILL SPECIFY WHICH LANE TO REMOVE FIRST.

KENTUCKY DEPARTMENT OF HIGHWAYS
CROSS SECTION
APPROVED _____ DATE _____ <small>TEAM DIVISION OF NELSON</small>

## **PART III**

### **EMPLOYMENT, WAGE AND RECORD REQUIREMENTS**



FHWA-1273 -- Revised May 1, 2012

**REQUIRED CONTRACT PROVISIONS  
FEDERAL-AID CONSTRUCTION CONTRACTS**

- I. General
- II. Nondiscrimination
- III. Nonsegregated Facilities
- IV. Davis-Bacon and Related Act Provisions
- V. Contract Work Hours and Safety Standards Act Provisions
- VI. Subletting or Assigning the Contract
- VII. Safety: Accident Prevention
- VIII. False Statements Concerning Highway Projects
- IX. Implementation of Clean Air Act and Federal Water Pollution Control Act
- X. Compliance with Governmentwide Suspension and Debarment Requirements
- XI. Certification Regarding Use of Contract Funds for Lobbying

3. A breach of any of the stipulations contained in these Required Contract Provisions may be sufficient grounds for withholding of progress payments, withholding of final payment, termination of the contract, suspension / debarment or any other action determined to be appropriate by the contracting agency and FHWA.

4. Selection of Labor: During the performance of this contract, the contractor shall not use convict labor for any purpose within the limits of a construction project on a Federal-aid highway unless it is labor performed by convicts who are on parole, supervised release, or probation. The term Federal-aid highway does not include roadways functionally classified as local roads or rural minor collectors.

**ATTACHMENTS**

A. Employment and Materials Preference for Appalachian Development Highway System or Appalachian Local Access Road Contracts (included in Appalachian contracts only)

**II. NONDISCRIMINATION**

The provisions of this section related to 23 CFR Part 230 are applicable to all Federal-aid construction contracts and to all related construction subcontracts of \$10,000 or more. The provisions of 23 CFR Part 230 are not applicable to material supply, engineering, or architectural service contracts.

**I. GENERAL**

1. Form FHWA-1273 must be physically incorporated in each construction contract funded under Title 23 (excluding emergency contracts solely intended for debris removal). The contractor (or subcontractor) must insert this form in each subcontract and further require its inclusion in all lower tier subcontracts (excluding purchase orders, rental agreements and other agreements for supplies or services).

In addition, the contractor and all subcontractors must comply with the following policies: Executive Order 11246, 41 CFR 60, 29 CFR 1625-1627, Title 23 USC Section 140, the Rehabilitation Act of 1973, as amended (29 USC 794), Title VI of the Civil Rights Act of 1964, as amended, and related regulations including 49 CFR Parts 21, 26 and 27; and 23 CFR Parts 200, 230, and 633.

The applicable requirements of Form FHWA-1273 are incorporated by reference for work done under any purchase order, rental agreement or agreement for other services. The prime contractor shall be responsible for compliance by any subcontractor, lower-tier subcontractor or service provider.

The contractor and all subcontractors must comply with: the requirements of the Equal Opportunity Clause in 41 CFR 60-1.4(b) and, for all construction contracts exceeding \$10,000, the Standard Federal Equal Employment Opportunity Construction Contract Specifications in 41 CFR 60-4.3.

Form FHWA-1273 must be included in all Federal-aid design-build contracts, in all subcontracts and in lower tier subcontracts (excluding subcontracts for design services, purchase orders, rental agreements and other agreements for supplies or services). The design-builder shall be responsible for compliance by any subcontractor, lower-tier subcontractor or service provider.

Note: The U.S. Department of Labor has exclusive authority to determine compliance with Executive Order 11246 and the policies of the Secretary of Labor including 41 CFR 60, and 29 CFR 1625-1627. The contracting agency and the FHWA have the authority and the responsibility to ensure compliance with Title 23 USC Section 140, the Rehabilitation Act of 1973, as amended (29 USC 794), and Title VI of the Civil Rights Act of 1964, as amended, and related regulations including 49 CFR Parts 21, 26 and 27; and 23 CFR Parts 200, 230, and 633.

Contracting agencies may reference Form FHWA-1273 in bid proposal or request for proposal documents, however, the Form FHWA-1273 must be physically incorporated (not referenced) in all contracts, subcontracts and lower-tier subcontracts (excluding purchase orders, rental agreements and other agreements for supplies or services related to a construction contract).

The following provision is adopted from 23 CFR 230, Appendix A, with appropriate revisions to conform to the U.S. Department of Labor (US DOL) and FHWA requirements.

2. Subject to the applicability criteria noted in the following sections, these contract provisions shall apply to all work performed on the contract by the contractor's own organization and with the assistance of workers under the contractor's immediate superintendence and to all work performed on the contract by piecework, station work, or by subcontract.

**1. Equal Employment Opportunity:** Equal employment opportunity (EEO) requirements not to discriminate and to take affirmative action to assure equal opportunity as set forth under laws, executive orders, rules, regulations (28 CFR 35, 29 CFR 1630, 29 CFR 1625-1627, 41 CFR 60 and 49 CFR 27) and orders of the Secretary of Labor as modified by the provisions prescribed herein, and imposed pursuant to 23 U.S.C. 140 shall constitute the EEO and specific affirmative action standards for the contractor's project activities under

this contract. The provisions of the Americans with Disabilities Act of 1990 (42 U.S.C. 12101 et seq.) set forth under 28 CFR 35 and 29 CFR 1630 are incorporated by reference in this contract. In the execution of this contract, the contractor agrees to comply with the following minimum specific requirement activities of EEO:

a. The contractor will work with the contracting agency and the Federal Government to ensure that it has made every good faith effort to provide equal opportunity with respect to all of its terms and conditions of employment and in their review of activities under the contract.

b. The contractor will accept as its operating policy the following statement:

"It is the policy of this Company to assure that applicants are employed, and that employees are treated during employment, without regard to their race, religion, sex, color, national origin, age or disability. Such action shall include: employment, upgrading, demotion, or transfer; recruitment or recruitment advertising; layoff or termination; rates of pay or other forms of compensation; and selection for training, including apprenticeship, pre-apprenticeship, and/or on-the-job training."

**2. EEO Officer:** The contractor will designate and make known to the contracting officers an EEO Officer who will have the responsibility for and must be capable of effectively administering and promoting an active EEO program and who must be assigned adequate authority and responsibility to do so.

**3. Dissemination of Policy:** All members of the contractor's staff who are authorized to hire, supervise, promote, and discharge employees, or who recommend such action, or who are substantially involved in such action, will be made fully cognizant of, and will implement, the contractor's EEO policy and contractual responsibilities to provide EEO in each grade and classification of employment. To ensure that the above agreement will be met, the following actions will be taken as a minimum:

a. Periodic meetings of supervisory and personnel office employees will be conducted before the start of work and then not less often than once every six months, at which time the contractor's EEO policy and its implementation will be reviewed and explained. The meetings will be conducted by the EEO Officer.

b. All new supervisory or personnel office employees will be given a thorough indoctrination by the EEO Officer, covering all major aspects of the contractor's EEO obligations within thirty days following their reporting for duty with the contractor.

c. All personnel who are engaged in direct recruitment for the project will be instructed by the EEO Officer in the contractor's procedures for locating and hiring minorities and women.

d. Notices and posters setting forth the contractor's EEO policy will be placed in areas readily accessible to employees, applicants for employment and potential employees.

e. The contractor's EEO policy and the procedures to implement such policy will be brought to the attention of employees by means of meetings, employee handbooks, or other appropriate means.

**4. Recruitment:** When advertising for employees, the contractor will include in all advertisements for employees the notation: "An Equal Opportunity Employer." All such advertisements will be placed in publications having a large circulation among minorities and women in the area from which the project work force would normally be derived.

a. The contractor will, unless precluded by a valid bargaining agreement, conduct systematic and direct recruitment through public and private employee referral sources likely to yield qualified minorities and women. To meet this requirement, the contractor will identify sources of potential minority group employees, and establish with such identified sources procedures whereby minority and women applicants may be referred to the contractor for employment consideration.

b. In the event the contractor has a valid bargaining agreement providing for exclusive hiring hall referrals, the contractor is expected to observe the provisions of that agreement to the extent that the system meets the contractor's compliance with EEO contract provisions. Where implementation of such an agreement has the effect of discriminating against minorities or women, or obligates the contractor to do the same, such implementation violates Federal nondiscrimination provisions.

c. The contractor will encourage its present employees to refer minorities and women as applicants for employment. Information and procedures with regard to referring such applicants will be discussed with employees.

**5. Personnel Actions:** Wages, working conditions, and employee benefits shall be established and administered, and personnel actions of every type, including hiring, upgrading, promotion, transfer, demotion, layoff, and termination, shall be taken without regard to race, color, religion, sex, national origin, age or disability. The following procedures shall be followed:

a. The contractor will conduct periodic inspections of project sites to insure that working conditions and employee facilities do not indicate discriminatory treatment of project site personnel.

b. The contractor will periodically evaluate the spread of wages paid within each classification to determine any evidence of discriminatory wage practices.

c. The contractor will periodically review selected personnel actions in depth to determine whether there is evidence of discrimination. Where evidence is found, the contractor will promptly take corrective action. If the review indicates that the discrimination may extend beyond the actions reviewed, such corrective action shall include all affected persons.

d. The contractor will promptly investigate all complaints of alleged discrimination made to the contractor in connection with its obligations under this contract, will attempt to resolve such complaints, and will take appropriate corrective action within a reasonable time. If the investigation indicates that the discrimination may affect persons other than the complainant, such corrective action shall include such other persons. Upon completion of each investigation, the contractor will inform every complainant of all of their avenues of appeal.

**6. Training and Promotion:**

a. The contractor will assist in locating, qualifying, and increasing the skills of minorities and women who are

applicants for employment or current employees. Such efforts should be aimed at developing full journey level status employees in the type of trade or job classification involved.

b. Consistent with the contractor's work force requirements and as permissible under Federal and State regulations, the contractor shall make full use of training programs, i.e., apprenticeship, and on-the-job training programs for the geographical area of contract performance. In the event a special provision for training is provided under this contract, this subparagraph will be superseded as indicated in the special provision. The contracting agency may reserve training positions for persons who receive welfare assistance in accordance with 23 U.S.C. 140(a).

c. The contractor will advise employees and applicants for employment of available training programs and entrance requirements for each.

d. The contractor will periodically review the training and promotion potential of employees who are minorities and women and will encourage eligible employees to apply for such training and promotion.

**7. Unions:** If the contractor relies in whole or in part upon unions as a source of employees, the contractor will use good faith efforts to obtain the cooperation of such unions to increase opportunities for minorities and women. Actions by the contractor, either directly or through a contractor's association acting as agent, will include the procedures set forth below:

a. The contractor will use good faith efforts to develop, in cooperation with the unions, joint training programs aimed toward qualifying more minorities and women for membership in the unions and increasing the skills of minorities and women so that they may qualify for higher paying employment.

b. The contractor will use good faith efforts to incorporate an EEO clause into each union agreement to the end that such union will be contractually bound to refer applicants without regard to their race, color, religion, sex, national origin, age or disability.

c. The contractor is to obtain information as to the referral practices and policies of the labor union except that to the extent such information is within the exclusive possession of the labor union and such labor union refuses to furnish such information to the contractor, the contractor shall so certify to the contracting agency and shall set forth what efforts have been made to obtain such information.

d. In the event the union is unable to provide the contractor with a reasonable flow of referrals within the time limit set forth in the collective bargaining agreement, the contractor will, through independent recruitment efforts, fill the employment vacancies without regard to race, color, religion, sex, national origin, age or disability; making full efforts to obtain qualified and/or qualifiable minorities and women. The failure of a union to provide sufficient referrals (even though it is obligated to provide exclusive referrals under the terms of a collective bargaining agreement) does not relieve the contractor from the requirements of this paragraph. In the event the union referral practice prevents the contractor from meeting the obligations pursuant to Executive Order 11246, as amended, and these special provisions, such contractor shall immediately notify the contracting agency.

**8. Reasonable Accommodation for Applicants / Employees with Disabilities:** The contractor must be familiar

with the requirements for and comply with the Americans with Disabilities Act and all rules and regulations established there under. Employers must provide reasonable accommodation in all employment activities unless to do so would cause an undue hardship.

**9. Selection of Subcontractors, Procurement of Materials and Leasing of Equipment:** The contractor shall not discriminate on the grounds of race, color, religion, sex, national origin, age or disability in the selection and retention of subcontractors, including procurement of materials and leases of equipment. The contractor shall take all necessary and reasonable steps to ensure nondiscrimination in the administration of this contract.

a. The contractor shall notify all potential subcontractors and suppliers and lessors of their EEO obligations under this contract.

b. The contractor will use good faith efforts to ensure subcontractor compliance with their EEO obligations.

**10. Assurance Required by 49 CFR 26.13(b):**

a. The requirements of 49 CFR Part 26 and the State DOT's U.S. DOT-approved DBE program are incorporated by reference.

b. The contractor or subcontractor shall not discriminate on the basis of race, color, national origin, or sex in the performance of this contract. The contractor shall carry out applicable requirements of 49 CFR Part 26 in the award and administration of DOT-assisted contracts. Failure by the contractor to carry out these requirements is a material breach of this contract, which may result in the termination of this contract or such other remedy as the contracting agency deems appropriate.

**11. Records and Reports:** The contractor shall keep such records as necessary to document compliance with the EEO requirements. Such records shall be retained for a period of three years following the date of the final payment to the contractor for all contract work and shall be available at reasonable times and places for inspection by authorized representatives of the contracting agency and the FHWA.

a. The records kept by the contractor shall document the following:

(1) The number and work hours of minority and non-minority group members and women employed in each work classification on the project;

(2) The progress and efforts being made in cooperation with unions, when applicable, to increase employment opportunities for minorities and women; and

(3) The progress and efforts being made in locating, hiring, training, qualifying, and upgrading minorities and women;

b. The contractors and subcontractors will submit an annual report to the contracting agency each July for the duration of the project, indicating the number of minority, women, and non-minority group employees currently engaged in each work classification required by the contract work. This information is to be reported on [Form FHWA-1391](#). The staffing data should represent the project work force on board in all or any part of the last payroll period preceding the end of July. If on-the-job training is being required by special provision, the contractor

will be required to collect and report training data. The employment data should reflect the work force on board during all or any part of the last payroll period preceding the end of July.

**III. NONSEGREGATED FACILITIES**

This provision is applicable to all Federal-aid construction contracts and to all related construction subcontracts of \$10,000 or more.

The contractor must ensure that facilities provided for employees are provided in such a manner that segregation on the basis of race, color, religion, sex, or national origin cannot result. The contractor may neither require such segregated use by written or oral policies nor tolerate such use by employee custom. The contractor's obligation extends further to ensure that its employees are not assigned to perform their services at any location, under the contractor's control, where the facilities are segregated. The term "facilities" includes waiting rooms, work areas, restaurants and other eating areas, time clocks, restrooms, washrooms, locker rooms, and other storage or dressing areas, parking lots, drinking fountains, recreation or entertainment areas, transportation, and housing provided for employees. The contractor shall provide separate or single-user restrooms and necessary dressing or sleeping areas to assure privacy between sexes.

**IV. DAVIS-BACON AND RELATED ACT PROVISIONS**

This section is applicable to all Federal-aid construction projects exceeding \$2,000 and to all related subcontracts and lower-tier subcontracts (regardless of subcontract size). The requirements apply to all projects located within the right-of-way of a roadway that is functionally classified as Federal-aid highway. This excludes roadways functionally classified as local roads or rural minor collectors, which are exempt. Contracting agencies may elect to apply these requirements to other projects.

The following provisions are from the U.S. Department of Labor regulations in 29 CFR 5.5 "Contract provisions and related matters" with minor revisions to conform to the FHWA-1273 format and FHWA program requirements.

**1. Minimum wages**

a. All laborers and mechanics employed or working upon the site of the work, will be paid unconditionally and not less often than once a week, and without subsequent deduction or rebate on any account (except such payroll deductions as are permitted by regulations issued by the Secretary of Labor under the Copeland Act (29 CFR part 3)), the full amount of wages and bona fide fringe benefits (or cash equivalents thereof) due at time of payment computed at rates not less than those contained in the wage determination of the Secretary of Labor which is attached hereto and made a part hereof, regardless of any contractual relationship which may be alleged to exist between the contractor and such laborers and mechanics.

Contributions made or costs reasonably anticipated for bona fide fringe benefits under section 1(b)(2) of the Davis-Bacon Act on behalf of laborers or mechanics are considered wages paid to such laborers or mechanics, subject to the provisions

of paragraph 1.d. of this section; also, regular contributions made or costs incurred for more than a weekly period (but not less often than quarterly) under plans, funds, or programs which cover the particular weekly period, are deemed to be constructively made or incurred during such weekly period. Such laborers and mechanics shall be paid the appropriate wage rate and fringe benefits on the wage determination for the classification of work actually performed, without regard to skill, except as provided in 29 CFR 5.5(a)(4). Laborers or mechanics performing work in more than one classification may be compensated at the rate specified for each classification for the time actually worked therein: Provided, That the employer's payroll records accurately set forth the time spent in each classification in which work is performed. The wage determination (including any additional classification and wage rates conformed under paragraph 1.b. of this section) and the Davis-Bacon poster (WH-1321) shall be posted at all times by the contractor and its subcontractors at the site of the work in a prominent and accessible place where it can be easily seen by the workers.

b.(1) The contracting officer shall require that any class of laborers or mechanics, including helpers, which is not listed in the wage determination and which is to be employed under the contract shall be classified in conformance with the wage determination. The contracting officer shall approve an additional classification and wage rate and fringe benefits therefore only when the following criteria have been met:

- (i) The work to be performed by the classification requested is not performed by a classification in the wage determination; and
- (ii) The classification is utilized in the area by the construction industry; and
- (iii) The proposed wage rate, including any bona fide fringe benefits, bears a reasonable relationship to the wage rates contained in the wage determination.

(2) If the contractor and the laborers and mechanics to be employed in the classification (if known), or their representatives, and the contracting officer agree on the classification and wage rate (including the amount designated for fringe benefits where appropriate), a report of the action taken shall be sent by the contracting officer to the Administrator of the Wage and Hour Division, Employment Standards Administration, U.S. Department of Labor, Washington, DC 20210. The Administrator, or an authorized representative, will approve, modify, or disapprove every additional classification action within 30 days of receipt and so advise the contracting officer or will notify the contracting officer within the 30-day period that additional time is necessary.

(3) In the event the contractor, the laborers or mechanics to be employed in the classification or their representatives, and the contracting officer do not agree on the proposed classification and wage rate (including the amount designated for fringe benefits, where appropriate), the contracting officer shall refer the questions, including the views of all interested parties and the recommendation of the contracting officer, to the Wage and Hour Administrator for determination. The Wage and Hour Administrator, or an authorized representative, will issue a determination within 30 days of receipt and so advise the contracting officer or



will notify the contracting officer within the 30-day period that additional time is necessary.

(4) The wage rate (including fringe benefits where appropriate) determined pursuant to paragraphs 1.b.(2) or 1.b.(3) of this section, shall be paid to all workers performing work in the classification under this contract from the first day on which work is performed in the classification.

c. Whenever the minimum wage rate prescribed in the contract for a class of laborers or mechanics includes a fringe benefit which is not expressed as an hourly rate, the contractor shall either pay the benefit as stated in the wage determination or shall pay another bona fide fringe benefit or an hourly cash equivalent thereof.

d. If the contractor does not make payments to a trustee or other third person, the contractor may consider as part of the wages of any laborer or mechanic the amount of any costs reasonably anticipated in providing bona fide fringe benefits under a plan or program. Provided, That the Secretary of Labor has found, upon the written request of the contractor, that the applicable standards of the Davis-Bacon Act have been met. The Secretary of Labor may require the contractor to set aside in a separate account assets for the meeting of obligations under the plan or program.

## 2. Withholding

The contracting agency shall upon its own action or upon written request of an authorized representative of the Department of Labor, withhold or cause to be withheld from the contractor under this contract, or any other Federal contract with the same prime contractor, or any other federally-assisted contract subject to Davis-Bacon prevailing wage requirements, which is held by the same prime contractor, so much of the accrued payments or advances as may be considered necessary to pay laborers and mechanics, including apprentices, trainees, and helpers, employed by the contractor or any subcontractor the full amount of wages required by the contract. In the event of failure to pay any laborer or mechanic, including any apprentice, trainee, or helper, employed or working on the site of the work, all or part of the wages required by the contract, the contracting agency may, after written notice to the contractor, take such action as may be necessary to cause the suspension of any further payment, advance, or guarantee of funds until such violations have ceased.

## 3. Payrolls and basic records

a. Payrolls and basic records relating thereto shall be maintained by the contractor during the course of the work and preserved for a period of three years thereafter for all laborers and mechanics working at the site of the work. Such records shall contain the name, address, and social security number of each such worker, his or her correct classification, hourly rates of wages paid (including rates of contributions or costs anticipated for bona fide fringe benefits or cash equivalents thereof of the types described in section 1(b)(2)(B) of the Davis-Bacon Act), daily and weekly number of hours worked, deductions made and actual wages paid. Whenever the Secretary of Labor has found under 29 CFR 5.5(a)(1)(iv) that the wages of any laborer or mechanic include the amount of any costs reasonably anticipated in providing benefits under a plan or program described in section 1(b)(2)(B) of the Davis-

Bacon Act, the contractor shall maintain records which show that the commitment to provide such benefits is enforceable, that the plan or program is financially responsible, and that the plan or program has been communicated in writing to the laborers or mechanics affected, and records which show the costs anticipated or the actual cost incurred in providing such benefits. Contractors employing apprentices or trainees under approved programs shall maintain written evidence of the registration of apprenticeship programs and certification of trainee programs, the registration of the apprentices and trainees, and the ratios and wage rates prescribed in the applicable programs.

b.(1) The contractor shall submit weekly for each week in which any contract work is performed a copy of all payrolls to the contracting agency. The payrolls submitted shall set out accurately and completely all of the information required to be maintained under 29 CFR 5.5(a)(3)(i), except that full social security numbers and home addresses shall not be included on weekly transmittals. Instead the payrolls shall only need to include an individually identifying number for each employee (e.g., the last four digits of the employee's social security number). The required weekly payroll information may be submitted in any form desired. Optional Form WH-347 is available for this purpose from the Wage and Hour Division Web site at <http://www.dol.gov/esa/whd/forms/wh347instr.htm> or its successor site. The prime contractor is responsible for the submission of copies of payrolls by all subcontractors. Contractors and subcontractors shall maintain the full social security number and current address of each covered worker, and shall provide them upon request to the contracting agency for transmission to the State DOT, the FHWA or the Wage and Hour Division of the Department of Labor for purposes of an investigation or audit of compliance with prevailing wage requirements. It is not a violation of this section for a prime contractor to require a subcontractor to provide addresses and social security numbers to the prime contractor for its own records, without weekly submission to the contracting agency..

(2) Each payroll submitted shall be accompanied by a "Statement of Compliance," signed by the contractor or subcontractor or his or her agent who pays or supervises the payment of the persons employed under the contract and shall certify the following:

(i) That the payroll for the payroll period contains the information required to be provided under §5.5 (a)(3)(ii) of Regulations, 29 CFR part 5, the appropriate information is being maintained under §5.5 (a)(3)(i) of Regulations, 29 CFR part 5, and that such information is correct and complete;

(ii) That each laborer or mechanic (including each helper, apprentice, and trainee) employed on the contract during the payroll period has been paid the full weekly wages earned, without rebate, either directly or indirectly, and that no deductions have been made either directly or indirectly from the full wages earned, other than permissible deductions as set forth in Regulations, 29 CFR part 3;

(iii) That each laborer or mechanic has been paid not less than the applicable wage rates and fringe benefits or cash equivalents for the classification of work performed, as specified in the applicable wage determination incorporated into the contract.

(3) The weekly submission of a properly executed certification set forth on the reverse side of Optional Form WH-347 shall satisfy the requirement for submission of the "Statement of Compliance" required by paragraph 3.b.(2) of this section.

(4) The falsification of any of the above certifications may subject the contractor or subcontractor to civil or criminal prosecution under section 1001 of title 18 and section 231 of title 31 of the United States Code.

c. The contractor or subcontractor shall make the records required under paragraph 3.a. of this section available for inspection, copying, or transcription by authorized representatives of the contracting agency, the State DOT, the FHWA, or the Department of Labor, and shall permit such representatives to interview employees during working hours on the job. If the contractor or subcontractor fails to submit the required records or to make them available, the FHWA may, after written notice to the contractor, the contracting agency or the State DOT, take such action as may be necessary to cause the suspension of any further payment, advance, or guarantee of funds. Furthermore, failure to submit the required records upon request or to make such records available may be grounds for debarment action pursuant to 29 CFR 5.12.

**4. Apprentices and trainees**

a. Apprentices (programs of the USDOL).

Apprentices will be permitted to work at less than the predetermined rate for the work they performed when they are employed pursuant to and individually registered in a bona fide apprenticeship program registered with the U.S. Department of Labor, Employment and Training Administration, Office of Apprenticeship Training, Employer and Labor Services, or with a State Apprenticeship Agency recognized by the Office, or if a person is employed in his or her first 90 days of probationary employment as an apprentice in such an apprenticeship program, who is not individually registered in the program, but who has been certified by the Office of Apprenticeship Training, Employer and Labor Services or a State Apprenticeship Agency (where appropriate) to be eligible for probationary employment as an apprentice.

The allowable ratio of apprentices to journeymen on the job site in any craft classification shall not be greater than the ratio permitted to the contractor as to the entire work force under the registered program. Any worker listed on a payroll at an apprentice wage rate, who is not registered or otherwise employed as stated above, shall be paid not less than the applicable wage rate on the wage determination for the classification of work actually performed. In addition, any apprentice performing work on the job site in excess of the ratio permitted under the registered program shall be paid not less than the applicable wage rate on the wage determination for the work actually performed. Where a contractor is performing construction on a project in a locality other than that in which its program is registered, the ratios and wage rates (expressed in percentages of the journeyman's hourly rate) specified in the contractor's or subcontractor's registered program shall be observed.

Every apprentice must be paid at not less than the rate specified in the registered program for the apprentice's level of progress, expressed as a percentage of the journeymen hourly

rate specified in the applicable wage determination. Apprentices shall be paid fringe benefits in accordance with the provisions of the apprenticeship program. If the apprenticeship program does not specify fringe benefits, apprentices must be paid the full amount of fringe benefits listed on the wage determination for the applicable classification. If the Administrator determines that a different practice prevails for the applicable apprentice classification, fringes shall be paid in accordance with that determination.

In the event the Office of Apprenticeship Training, Employer and Labor Services, or a State Apprenticeship Agency recognized by the Office, withdraws approval of an apprenticeship program, the contractor will no longer be permitted to utilize apprentices at less than the applicable predetermined rate for the work performed until an acceptable program is approved.

b. Trainees (programs of the USDOL).

Except as provided in 29 CFR 5.16, trainees will not be permitted to work at less than the predetermined rate for the work performed unless they are employed pursuant to and individually registered in a program which has received prior approval, evidenced by formal certification by the U.S. Department of Labor, Employment and Training Administration.

The ratio of trainees to journeymen on the job site shall not be greater than permitted under the plan approved by the Employment and Training Administration.

Every trainee must be paid at not less than the rate specified in the approved program for the trainee's level of progress, expressed as a percentage of the journeyman hourly rate specified in the applicable wage determination. Trainees shall be paid fringe benefits in accordance with the provisions of the trainee program. If the trainee program does not mention fringe benefits, trainees shall be paid the full amount of fringe benefits listed on the wage determination unless the Administrator of the Wage and Hour Division determines that there is an apprenticeship program associated with the corresponding journeyman wage rate on the wage determination which provides for less than full fringe benefits for apprentices. Any employee listed on the payroll at a trainee rate who is not registered and participating in a training plan approved by the Employment and Training Administration shall be paid not less than the applicable wage rate on the wage determination for the classification of work actually performed. In addition, any trainee performing work on the job site in excess of the ratio permitted under the registered program shall be paid not less than the applicable wage rate on the wage determination for the work actually performed.

In the event the Employment and Training Administration withdraws approval of a training program, the contractor will no longer be permitted to utilize trainees at less than the applicable predetermined rate for the work performed until an acceptable program is approved.

c. Equal employment opportunity. The utilization of apprentices, trainees and journeymen under this part shall be in conformity with the equal employment opportunity requirements of Executive Order 11246, as amended, and 29 CFR part 30.

d. Apprentices and Trainees (programs of the U.S. DOT).

Apprentices and trainees working under apprenticeship and skill training programs which have been certified by the Secretary of Transportation as promoting EEO in connection with Federal-aid highway construction programs are not subject to the requirements of paragraph 4 of this Section IV. The straight time hourly wage rates for apprentices and trainees under such programs will be established by the particular programs. The ratio of apprentices and trainees to journeymen shall not be greater than permitted by the terms of the particular program.

**5. Compliance with Copeland Act requirements.** The contractor shall comply with the requirements of 29 CFR part 3, which are incorporated by reference in this contract.

**6. Subcontracts.** The contractor or subcontractor shall insert Form FHWA-1273 in any subcontracts and also require the subcontractors to include Form FHWA-1273 in any lower tier subcontracts. The prime contractor shall be responsible for the compliance by any subcontractor or lower tier subcontractor with all the contract clauses in 29 CFR 5.5.

**7. Contract termination: debarment.** A breach of the contract clauses in 29 CFR 5.5 may be grounds for termination of the contract, and for debarment as a contractor and a subcontractor as provided in 29 CFR 5.12.

**8. Compliance with Davis-Bacon and Related Act requirements.** All rulings and interpretations of the Davis-Bacon and Related Acts contained in 29 CFR parts 1, 3, and 5 are herein incorporated by reference in this contract.

**9. Disputes concerning labor standards.** Disputes arising out of the labor standards provisions of this contract shall not be subject to the general disputes clause of this contract. Such disputes shall be resolved in accordance with the procedures of the Department of Labor set forth in 29 CFR parts 5, 6, and 7. Disputes within the meaning of this clause include disputes between the contractor (or any of its subcontractors) and the contracting agency, the U.S. Department of Labor, or the employees or their representatives.

**10. Certification of eligibility.**

a. By entering into this contract, the contractor certifies that neither it (nor he or she) nor any person or firm who has an interest in the contractor's firm is a person or firm ineligible to be awarded Government contracts by virtue of section 3(a) of the Davis-Bacon Act or 29 CFR 5.12(a)(1).

b. No part of this contract shall be subcontracted to any person or firm ineligible for award of a Government contract by virtue of section 3(a) of the Davis-Bacon Act or 29 CFR 5.12(a)(1).

c. The penalty for making false statements is prescribed in the U.S. Criminal Code, 18 U.S.C. 1001.

**V. CONTRACT WORK HOURS AND SAFETY STANDARDS ACT**

The following clauses apply to any Federal-aid construction contract in an amount in excess of \$100,000 and subject to the overtime provisions of the Contract Work Hours and Safety Standards Act. These clauses shall be inserted in addition to the clauses required by 29 CFR 5.5(a) or 29 CFR 4.6. As used in this paragraph, the terms laborers and mechanics include watchmen and guards.

**1. Overtime requirements.** No contractor or subcontractor contracting for any part of the contract work which may require or involve the employment of laborers or mechanics shall require or permit any such laborer or mechanic in any workweek in which he or she is employed on such work to work in excess of forty hours in such workweek unless such laborer or mechanic receives compensation at a rate not less than one and one-half times the basic rate of pay for all hours worked in excess of forty hours in such workweek.

**2. Violation; liability for unpaid wages; liquidated damages.** In the event of any violation of the clause set forth in paragraph (1.) of this section, the contractor and any subcontractor responsible therefor shall be liable for the unpaid wages. In addition, such contractor and subcontractor shall be liable to the United States (in the case of work done under contract for the District of Columbia or a territory, to such District or to such territory), for liquidated damages. Such liquidated damages shall be computed with respect to each individual laborer or mechanic, including watchmen and guards, employed in violation of the clause set forth in paragraph (1.) of this section, in the sum of \$10 for each calendar day on which such individual was required or permitted to work in excess of the standard workweek of forty hours without payment of the overtime wages required by the clause set forth in paragraph (1.) of this section.

**3. Withholding for unpaid wages and liquidated damages.** The FHWA or the contracting agency shall upon its own action or upon written request of an authorized representative of the Department of Labor withhold or cause to be withheld, from any moneys payable on account of work performed by the contractor or subcontractor under any such contract or any other Federal contract with the same prime contractor, or any other federally-assisted contract subject to the Contract Work Hours and Safety Standards Act, which is held by the same prime contractor, such sums as may be determined to be necessary to satisfy any liabilities of such contractor or subcontractor for unpaid wages and liquidated damages as provided in the clause set forth in paragraph (2.) of this section.

**4. Subcontracts.** The contractor or subcontractor shall insert in any subcontracts the clauses set forth in paragraph (1.) through (4.) of this section and also a clause requiring the subcontractors to include these clauses in any lower tier subcontracts. The prime contractor shall be responsible for compliance by any subcontractor or lower tier subcontractor with the clauses set forth in paragraphs (1.) through (4.) of this section.

**VI. SUBLETTING OR ASSIGNING THE CONTRACT**

This provision is applicable to all Federal-aid construction contracts on the National Highway System.

1. The contractor shall perform with its own organization contract work amounting to not less than 30 percent (or a greater percentage if specified elsewhere in the contract) of the total original contract price, excluding any specialty items designated by the contracting agency. Specialty items may be performed by subcontract and the amount of any such specialty items performed may be deducted from the total original contract price before computing the amount of work required to be performed by the contractor's own organization (23 CFR 635.116).

a. The term "perform work with its own organization" refers to workers employed or leased by the prime contractor, and equipment owned or rented by the prime contractor, with or without operators. Such term does not include employees or equipment of a subcontractor or lower tier subcontractor, agents of the prime contractor, or any other assignees. The term may include payments for the costs of hiring leased employees from an employee leasing firm meeting all relevant Federal and State regulatory requirements. Leased employees may only be included in this term if the prime contractor meets all of the following conditions:

- (1) the prime contractor maintains control over the supervision of the day-to-day activities of the leased employees;
- (2) the prime contractor remains responsible for the quality of the work of the leased employees;
- (3) the prime contractor retains all power to accept or exclude individual employees from work on the project; and
- (4) the prime contractor remains ultimately responsible for the payment of predetermined minimum wages, the submission of payrolls, statements of compliance and all other Federal regulatory requirements.

b. "Specialty Items" shall be construed to be limited to work that requires highly specialized knowledge, abilities, or equipment not ordinarily available in the type of contracting organizations qualified and expected to bid or propose on the contract as a whole and in general are to be limited to minor components of the overall contract.

2. The contract amount upon which the requirements set forth in paragraph (1) of Section VI is computed includes the cost of material and manufactured products which are to be purchased or produced by the contractor under the contract provisions.

3. The contractor shall furnish (a) a competent superintendent or supervisor who is employed by the firm, has full authority to direct performance of the work in accordance with the contract requirements, and is in charge of all construction operations (regardless of who performs the work) and (b) such other of its own organizational resources (supervision, management, and engineering services) as the contracting officer determines is necessary to assure the performance of the contract.

4. No portion of the contract shall be sublet, assigned or otherwise disposed of except with the written consent of the contracting officer, or authorized representative, and such consent when given shall not be construed to relieve the contractor of any responsibility for the fulfillment of the contract. Written consent will be given only after the contracting agency has assured that each subcontract is

evidenced in writing and that it contains all pertinent provisions and requirements of the prime contract.

5. The 30% self-performance requirement of paragraph (1) is not applicable to design-build contracts; however, contracting agencies may establish their own self-performance requirements.

**VII. SAFETY: ACCIDENT PREVENTION**

This provision is applicable to all Federal-aid construction contracts and to all related subcontracts.

1. In the performance of this contract the contractor shall comply with all applicable Federal, State, and local laws governing safety, health, and sanitation (23 CFR 635). The contractor shall provide all safeguards, safety devices and protective equipment and take any other needed actions as it determines, or as the contracting officer may determine, to be reasonably necessary to protect the life and health of employees on the job and the safety of the public and to protect property in connection with the performance of the work covered by the contract.

2. It is a condition of this contract, and shall be made a condition of each subcontract, which the contractor enters into pursuant to this contract, that the contractor and any subcontractor shall not permit any employee, in performance of the contract, to work in surroundings or under conditions which are unsanitary, hazardous or dangerous to his/her health or safety, as determined under construction safety and health standards (29 CFR 1926) promulgated by the Secretary of Labor, in accordance with Section 107 of the Contract Work Hours and Safety Standards Act (40 U.S.C. 3704).

3. Pursuant to 29 CFR 1926.3, it is a condition of this contract that the Secretary of Labor or authorized representative thereof, shall have right of entry to any site of contract performance to inspect or investigate the matter of compliance with the construction safety and health standards and to carry out the duties of the Secretary under Section 107 of the Contract Work Hours and Safety Standards Act (40 U.S.C.3704).

**VIII. FALSE STATEMENTS CONCERNING HIGHWAY PROJECTS**

This provision is applicable to all Federal-aid construction contracts and to all related subcontracts.

In order to assure high quality and durable construction in conformity with approved plans and specifications and a high degree of reliability on statements and representations made by engineers, contractors, suppliers, and workers on Federal-aid highway projects, it is essential that all persons concerned with the project perform their functions as carefully, thoroughly, and honestly as possible. Willful falsification, distortion, or misrepresentation with respect to any facts related to the project is a violation of Federal law. To prevent any misunderstanding regarding the seriousness of these and similar acts, Form FHWA-1022 shall be posted on each Federal-aid highway project (23 CFR 635) in one or more places where it is readily available to all persons concerned with the project:

18 U.S.C. 1020 reads as follows:



"Whoever, being an officer, agent, or employee of the United States, or of any State or Territory, or whoever, whether a person, association, firm, or corporation, knowingly makes any false statement, false representation, or false report as to the character, quality, quantity, or cost of the material used or to be used, or the quantity or quality of the work performed or to be performed, or the cost thereof in connection with the submission of plans, maps, specifications, contracts, or costs of construction on any highway or related project submitted for approval to the Secretary of Transportation; or

Whoever knowingly makes any false statement, false representation, false report or false claim with respect to the character, quality, quantity, or cost of any work performed or to be performed, or materials furnished or to be furnished, in connection with the construction of any highway or related project approved by the Secretary of Transportation; or

Whoever knowingly makes any false statement or false representation as to material fact in any statement, certificate, or report submitted pursuant to provisions of the Federal-aid Roads Act approved July 1, 1916, (39 Stat. 355), as amended and supplemented;

Shall be fined under this title or imprisoned not more than 5 years or both."

#### **IX. IMPLEMENTATION OF CLEAN AIR ACT AND FEDERAL WATER POLLUTION CONTROL ACT**

This provision is applicable to all Federal-aid construction contracts and to all related subcontracts.

By submission of this bid/proposal or the execution of this contract, or subcontract, as appropriate, the bidder, proposer, Federal-aid construction contractor, or subcontractor, as appropriate, will be deemed to have stipulated as follows:

1. That any person who is or will be utilized in the performance of this contract is not prohibited from receiving an award due to a violation of Section 508 of the Clean Water Act or Section 306 of the Clean Air Act.

2. That the contractor agrees to include or cause to be included the requirements of paragraph (1) of this Section X in every subcontract, and further agrees to take such action as the contracting agency may direct as a means of enforcing such requirements.

#### **X. CERTIFICATION REGARDING DEBARMENT, SUSPENSION, INELIGIBILITY AND VOLUNTARY EXCLUSION**

This provision is applicable to all Federal-aid construction contracts, design-build contracts, subcontracts, lower-tier subcontracts, purchase orders, lease agreements, consultant contracts or any other covered transaction requiring FHWA approval or that is estimated to cost \$25,000 or more – as defined in 2 CFR Parts 180 and 1200.

##### **1. Instructions for Certification – First Tier Participants:**

a. By signing and submitting this proposal, the prospective first tier participant is providing the certification set out below.

b. The inability of a person to provide the certification set out below will not necessarily result in denial of participation in this

covered transaction. The prospective first tier participant shall submit an explanation of why it cannot provide the certification set out below. The certification or explanation will be considered in connection with the department or agency's determination whether to enter into this transaction. However, failure of the prospective first tier participant to furnish a certification or an explanation shall disqualify such a person from participation in this transaction.

c. The certification in this clause is a material representation of fact upon which reliance was placed when the contracting agency determined to enter into this transaction. If it is later determined that the prospective participant knowingly rendered an erroneous certification, in addition to other remedies available to the Federal Government, the contracting agency may terminate this transaction for cause of default.

d. The prospective first tier participant shall provide immediate written notice to the contracting agency to whom this proposal is submitted if any time the prospective first tier participant learns that its certification was erroneous when submitted or has become erroneous by reason of changed circumstances.

e. The terms "covered transaction," "debarred," "suspended," "ineligible," "participant," "person," "principal," and "voluntarily excluded," as used in this clause, are defined in 2 CFR Parts 180 and 1200. "First Tier Covered Transactions" refers to any covered transaction between a grantee or subgrantee of Federal funds and a participant (such as the prime or general contract). "Lower Tier Covered Transactions" refers to any covered transaction under a First Tier Covered Transaction (such as subcontracts). "First Tier Participant" refers to the participant who has entered into a covered transaction with a grantee or subgrantee of Federal funds (such as the prime or general contractor). "Lower Tier Participant" refers any participant who has entered into a covered transaction with a First Tier Participant or other Lower Tier Participants (such as subcontractors and suppliers).

f. The prospective first tier participant agrees by submitting this proposal that, should the proposed covered transaction be entered into, it shall not knowingly enter into any lower tier covered transaction with a person who is debarred, suspended, declared ineligible, or voluntarily excluded from participation in this covered transaction, unless authorized by the department or agency entering into this transaction.

g. The prospective first tier participant further agrees by submitting this proposal that it will include the clause titled "Certification Regarding Debarment, Suspension, Ineligibility and Voluntary Exclusion-Lower Tier Covered Transactions," provided by the department or contracting agency, entering into this covered transaction, without modification, in all lower tier covered transactions and in all solicitations for lower tier covered transactions exceeding the \$25,000 threshold.

h. A participant in a covered transaction may rely upon a certification of a prospective participant in a lower tier covered transaction that is not debarred, suspended, ineligible, or voluntarily excluded from the covered transaction, unless it knows that the certification is erroneous. A participant is responsible for ensuring that its principals are not suspended, debarred, or otherwise ineligible to participate in covered transactions. To verify the eligibility of its principals, as well as the eligibility of any lower tier prospective participants, each participant may, but is not required to, check the Excluded Parties List System website (<https://www.epls.gov/>), which is compiled by the General Services Administration.

i. Nothing contained in the foregoing shall be construed to require the establishment of a system of records in order to render in good faith the certification required by this clause. The knowledge and information of the prospective participant is not required to exceed that which is normally possessed by a prudent person in the ordinary course of business dealings.

j. Except for transactions authorized under paragraph (f) of these instructions, if a participant in a covered transaction knowingly enters into a lower tier covered transaction with a person who is suspended, debarred, ineligible, or voluntarily excluded from participation in this transaction, in addition to other remedies available to the Federal Government, the department or agency may terminate this transaction for cause or default.

\*\*\*\*\*

**2. Certification Regarding Debarment, Suspension, Ineligibility and Voluntary Exclusion – First Tier Participants:**

a. The prospective first tier participant certifies to the best of its knowledge and belief, that it and its principals:

(1) Are not presently debarred, suspended, proposed for debarment, declared ineligible, or voluntarily excluded from participating in covered transactions by any Federal department or agency;

(2) Have not within a three-year period preceding this proposal been convicted of or had a civil judgment rendered against them for commission of fraud or a criminal offense in connection with obtaining, attempting to obtain, or performing a public (Federal, State or local) transaction or contract under a public transaction; violation of Federal or State antitrust statutes or commission of embezzlement, theft, forgery, bribery, falsification or destruction of records, making false statements, or receiving stolen property;

(3) Are not presently indicted for or otherwise criminally or civilly charged by a governmental entity (Federal, State or local) with commission of any of the offenses enumerated in paragraph (a)(2) of this certification; and

(4) Have not within a three-year period preceding this application/proposal had one or more public transactions (Federal, State or local) terminated for cause or default.

b. Where the prospective participant is unable to certify to any of the statements in this certification, such prospective participant shall attach an explanation to this proposal.

**2. Instructions for Certification - Lower Tier Participants:**

(Applicable to all subcontracts, purchase orders and other lower tier transactions requiring prior FHWA approval or estimated to cost \$25,000 or more - 2 CFR Parts 180 and 1200)

a. By signing and submitting this proposal, the prospective lower tier is providing the certification set out below.

b. The certification in this clause is a material representation of fact upon which reliance was placed when this transaction was entered into. If it is later determined that the prospective lower tier participant knowingly rendered an erroneous certification, in addition to other remedies available to the Federal Government, the department, or agency with which

this transaction originated may pursue available remedies, including suspension and/or debarment.

c. The prospective lower tier participant shall provide immediate written notice to the person to which this proposal is submitted if at any time the prospective lower tier participant learns that its certification was erroneous by reason of changed circumstances.

d. The terms "covered transaction," "debarred," "suspended," "ineligible," "participant," "person," "principal," and "voluntarily excluded," as used in this clause, are defined in 2 CFR Parts 180 and 1200. You may contact the person to which this proposal is submitted for assistance in obtaining a copy of those regulations. "First Tier Covered Transactions" refers to any covered transaction between a grantee or subgrantee of Federal funds and a participant (such as the prime or general contract). "Lower Tier Covered Transactions" refers to any covered transaction under a First Tier Covered Transaction (such as subcontracts). "First Tier Participant" refers to the participant who has entered into a covered transaction with a grantee or subgrantee of Federal funds (such as the prime or general contractor). "Lower Tier Participant" refers any participant who has entered into a covered transaction with a First Tier Participant or other Lower Tier Participants (such as subcontractors and suppliers).

e. The prospective lower tier participant agrees by submitting this proposal that, should the proposed covered transaction be entered into, it shall not knowingly enter into any lower tier covered transaction with a person who is debarred, suspended, declared ineligible, or voluntarily excluded from participation in this covered transaction, unless authorized by the department or agency with which this transaction originated.

f. The prospective lower tier participant further agrees by submitting this proposal that it will include this clause titled "Certification Regarding Debarment, Suspension, Ineligibility and Voluntary Exclusion-Lower Tier Covered Transaction," without modification, in all lower tier covered transactions and in all solicitations for lower tier covered transactions exceeding the \$25,000 threshold.

g. A participant in a covered transaction may rely upon a certification of a prospective participant in a lower tier covered transaction that is not debarred, suspended, ineligible, or voluntarily excluded from the covered transaction, unless it knows that the certification is erroneous. A participant is responsible for ensuring that its principals are not suspended, debarred, or otherwise ineligible to participate in covered transactions. To verify the eligibility of its principals, as well as the eligibility of any lower tier prospective participants, each participant may, but is not required to, check the Excluded Parties List System website (<https://www.epls.gov/>), which is compiled by the General Services Administration.

h. Nothing contained in the foregoing shall be construed to require establishment of a system of records in order to render in good faith the certification required by this clause. The knowledge and information of participant is not required to exceed that which is normally possessed by a prudent person in the ordinary course of business dealings.

i. Except for transactions authorized under paragraph e of these instructions, if a participant in a covered transaction knowingly enters into a lower tier covered transaction with a person who is suspended, debarred, ineligible, or voluntarily excluded from participation in this transaction, in addition to other remedies available to the Federal Government, the

department or agency with which this transaction originated may pursue available remedies, including suspension and/or debarment.

\* \* \* \* \*

**Certification Regarding Debarment, Suspension, Ineligibility and Voluntary Exclusion--Lower Tier Participants:**

1. The prospective lower tier participant certifies, by submission of this proposal, that neither it nor its principals is presently debarred, suspended, proposed for debarment, declared ineligible, or voluntarily excluded from participating in covered transactions by any Federal department or agency.

2. Where the prospective lower tier participant is unable to certify to any of the statements in this certification, such prospective participant shall attach an explanation to this proposal.

\* \* \* \* \*

**XI. CERTIFICATION REGARDING USE OF CONTRACT FUNDS FOR LOBBYING**

This provision is applicable to all Federal-aid construction contracts and to all related subcontracts which exceed \$100,000 (49 CFR 20).

1. The prospective participant certifies, by signing and submitting this bid or proposal, to the best of his or her knowledge and belief, that:

a. No Federal appropriated funds have been paid or will be paid, by or on behalf of the undersigned, to any person for influencing or attempting to influence an officer or employee of any Federal agency, a Member of Congress, an officer or employee of Congress, or an employee of a Member of Congress in connection with the awarding of any Federal contract, the making of any Federal grant, the making of any Federal loan, the entering into of any cooperative agreement, and the extension, continuation, renewal, amendment, or modification of any Federal contract, grant, loan, or cooperative agreement.

b. If any funds other than Federal appropriated funds have been paid or will be paid to any person for influencing or attempting to influence an officer or employee of any Federal agency, a Member of Congress, an officer or employee of Congress, or an employee of a Member of Congress in connection with this Federal contract, grant, loan, or cooperative agreement, the undersigned shall complete and submit Standard Form-LLL, "Disclosure Form to Report Lobbying," in accordance with its instructions.

2. This certification is a material representation of fact upon which reliance was placed when this transaction was made or entered into. Submission of this certification is a prerequisite for making or entering into this transaction imposed by 31 U.S.C. 1352. Any person who fails to file the required certification shall be subject to a civil penalty of not less than \$10,000 and not more than \$100,000 for each such failure.

3. The prospective participant also agrees by submitting its bid or proposal that the participant shall require that the language of this certification be included in all lower tier subcontracts, which exceed \$100,000 and that all such recipients shall certify and disclose accordingly.

**ATTACHMENT A - EMPLOYMENT AND MATERIALS  
PREFERENCE FOR APPALACHIAN DEVELOPMENT  
HIGHWAY SYSTEM OR APPALACHIAN LOCAL ACCESS  
ROAD CONTRACTS**

This provision is applicable to all Federal-aid projects funded under the Appalachian Regional Development Act of 1965.

1. During the performance of this contract, the contractor undertaking to do work which is, or reasonably may be, done as on-site work, shall give preference to qualified persons who regularly reside in the labor area as designated by the DOL wherein the contract work is situated, or the subregion, or the Appalachian counties of the State wherein the contract work is situated, except:

a. To the extent that qualified persons regularly residing in the area are not available.

b. For the reasonable needs of the contractor to employ supervisory or specially experienced personnel necessary to assure an efficient execution of the contract work.

c. For the obligation of the contractor to offer employment to present or former employees as the result of a lawful collective bargaining contract, provided that the number of nonresident persons employed under this subparagraph (1c) shall not exceed 20 percent of the total number of employees employed by the contractor on the contract work, except as provided in subparagraph (4) below.

2. The contractor shall place a job order with the State Employment Service indicating (a) the classifications of the laborers, mechanics and other employees required to perform the contract work, (b) the number of employees required in each classification, (c) the date on which the participant estimates such employees will be required, and (d) any other pertinent information required by the State Employment Service to complete the job order form. The job order may be placed with the State Employment Service in writing or by telephone. If during the course of the contract work, the information submitted by the contractor in the original job order is substantially modified, the participant shall promptly notify the State Employment Service.

3. The contractor shall give full consideration to all qualified job applicants referred to him by the State Employment Service. The contractor is not required to grant employment to any job applicants who, in his opinion, are not qualified to perform the classification of work required.

4. If, within one week following the placing of a job order by the contractor with the State Employment Service, the State Employment Service is unable to refer any qualified job applicants to the contractor, or less than the number requested, the State Employment Service will forward a certificate to the contractor indicating the unavailability of applicants. Such certificate shall be made a part of the contractor's permanent project records. Upon receipt of this certificate, the contractor may employ persons who do not normally reside in the labor area to fill positions covered by the certificate, notwithstanding the provisions of subparagraph (1c) above.

5. The provisions of 23 CFR 633.207(e) allow the contracting agency to provide a contractual preference for the use of mineral resource materials native to the Appalachian region.

6. The contractor shall include the provisions of Sections 1 through 4 of this Attachment A in every subcontract for work which is, or reasonably may be, done as on-site work.



**KENTUCKY TRANSPORTATION CABINET  
DEPARTMENT OF HIGHWAYS**

**EMPLOYMENT REQUIREMENTS  
RELATING TO  
NONDISCRIMINATION OF EMPLOYEES  
(APPLICABLE TO FEDERAL-AID SYSTEM CONTRACTS)**

**AN ACT OF THE KENTUCKY GENERAL ASSEMBLY  
TO PREVENT DISCRIMINATION IN EMPLOYMENT**

**KRS CHAPTER 344  
EFFECTIVE JUNE 16, 1972**

The contract on this project, in accordance with KRS Chapter 344, provides that during the performance of this contract, the contractor agrees as follows:

1. The contractor shall not fail or refuse to hire, or shall not discharge any individual, or otherwise discriminate against an individual with respect to his compensation, terms, conditions, or privileges of employment, because of such individual's race, color, religion, national origin, sex, disability or age (forty and above); or limit, segregate, or classify his employees in any way which would deprive or tend to deprive an individual of employment opportunities or otherwise adversely affect his status as an employee, because of such individual's race, color, religion, national origin, sex, disability or age forty (40) and over. The contractor agrees to post in conspicuous places, available to employees and applicants for employment, notices to be provided setting forth the provisions of this nondiscrimination clause.

2. The contractor shall not print or publish or cause to be printed or published a notice or advertisement relating to employment by such an employer or membership in or any classification or referral for employment by the employment agency, indicating any preference, limitation, specification, or discrimination, based on race, color, religion, national origin, sex, or age forty (40) and over, or because the person is a qualified individual with a disability, except that such a notice or advertisement may indicate a preference, limitation, or specification based on religion, national origin, sex, or age forty (40) and over, or because the person is a qualified individual with a disability, when religion, national origin, sex, or age forty (40) and over, or because the person is a qualified individual with a disability, is a bona fide occupational qualification for employment.

3. If the contractor is in control of apprenticeship or other training or retraining, including on-the-job training programs, he shall not discriminate against an individual because of his race, color, religion, national origin, sex, disability or age forty (40) and over, in admission to, or employment in any program established to provide apprenticeship or other training.

4. The contractor will send to each labor union or representative of workers with which he has a collective bargaining agreement or other contract or understanding, a notice to be provided advising the said labor union or workers' representative of the contractor's commitments under this section, and shall post copies of the notice in conspicuous places available to employees and applicants for employment. The contractor will take such action with respect to any subcontract or purchase order as the administering agency may direct as a means of enforcing such provisions, including sanctions for non-compliance.

Revised: January 25, 2017

### Standard Title VI/Non-Discrimination Assurances

During the performance of this contract, the contractor, for itself, its assignees, and successors in interest (hereinafter referred to as the "contractor") agrees as follows:

1. **Compliance with Regulations:** The contractor (hereinafter includes consultants) will comply with the Acts and the Regulations relative to Non-discrimination in Federally-assisted programs of the U.S. Department of Transportation, **Federal Highway Administration**, as they may be amended from time to time, which are herein incorporated by reference and made a part of this contract.
2. **Non-discrimination:** The contractor, with regard to the work performed by it during the contract, will not discriminate on the grounds of race, color, or national origin in the selection and retention of subcontractors, including procurements of materials and leases of equipment. The contractor will not participate directly or indirectly in the discrimination prohibited by the Acts and the Regulations, including employment practices when the contract covers any activity, project, or program set forth in Appendix B of 49 CFR Part 21.
3. **Solicitations for Subcontracts, Including Procurements of Materials and Equipment:** In all solicitations, either by competitive bidding, or negotiation made by the contractor for work to be performed under a subcontract, including procurements of materials, or leases of equipment, each potential subcontractor or supplier will be notified by the contractor of the contractor's obligations under this contract and the Acts and the Regulations relative to Non-discrimination on the grounds of race, color, or national origin.
4. **Information and Reports:** The contractor will provide all information and reports required by the Acts, the Regulations, and directives issued pursuant thereto and will permit access to its books, records, accounts, other sources of information, and its facilities as may be determined by the Recipient or the **Federal Highway Administration** to be pertinent to ascertain compliance with such Acts, Regulations, and instructions. Where any information required of a contractor is in the exclusive possession of another who fails or refuses to furnish the information, the contractor will so certify to the Recipient or the **Federal Highway Administration**, as appropriate, and will set forth what efforts it has made to obtain the information.
5. **Sanctions for Noncompliance:** In the event of a contractor's noncompliance with the Non-discrimination provisions of this contract, the Recipient will impose such contract sanctions as it or the **Federal Highway Administration** may determine to be appropriate, including, but not limited to:
  - a. withholding payments to the contractor under the contract until the contractor complies; and/or
  - b. cancelling, terminating, or suspending a contract, in whole or in part.
6. **Incorporation of Provisions:** The contractor will include the provisions of paragraphs one through six in every subcontract, including procurements of materials and leases of equipment, unless exempt by the Acts, the Regulations and directives issued pursuant thereto. The contractor will take action with respect to any subcontract or procurement as the Recipient or the **Federal Highway Administration** may direct as a means of enforcing such provisions including sanctions for noncompliance. Provided, that if the contractor becomes involved in, or is threatened with litigation by a subcontractor, or supplier because of such direction, the contractor may request the Recipient to enter into any litigation to protect the interests of the Recipient. In addition, the contractor may request the United States to enter into the litigation to protect the interests of the United States.

### Standard Title VI/Non-Discrimination Statutes and Authorities

During the performance of this contract, the contractor, for itself, its assignees, and successors in interest (hereinafter referred to as the “contractor”) agrees to comply with the following non-discrimination statutes and authorities; including but not limited to:

- Title VI of the Civil Rights Act of 1964 (42 U.S.C. § 2000d *et seq.*, 78 stat. 252), (prohibits discrimination on the basis of race, color, national origin); and 49 CFR Part 21;
- The Uniform Relocation Assistance and Real Property Acquisition Policies Act of 1970, (42 U.S.C. § 4601), (prohibits unfair treatment of persons displaced or whose property has been acquired because of Federal or Federal-aid programs and projects);
- Federal-Aid Highway Act of 1973, (23 U.S.C. § 324 *et seq.*), (prohibits discrimination on the basis of sex);
- Section 504 of the Rehabilitation Act of 1973, (29 U.S.C. § 794 *et seq.*), as amended, (prohibits discrimination on the basis of disability); and 49 CFR Part 27;
- The Age Discrimination Act of 1975, as amended, (42 U.S.C. § 6101 *et seq.*), (prohibits discrimination on the basis of age);
- Airport and Airway Improvement Act of 1982, (49 USC § 471, Section 47123), as amended, (prohibits discrimination based on race, creed, color, national origin, or sex);
- The Civil Rights Restoration Act of 1987, (PL 100-209), (Broadened the scope, coverage and applicability of Title VI of the Civil Rights Act of 1964, The Age Discrimination Act of 1975 and Section 504 of the Rehabilitation Act of 1973, by expanding the definition of the terms “programs or activities” to include all of the programs or activities of the Federal-aid recipients, sub-recipients and contractors, whether such programs or activities are Federally funded or not);
- Titles II and III of the Americans with Disabilities Act, which prohibit discrimination on the basis of disability in the operation of public entities, public and private transportation systems, places of public accommodation, and certain testing entities (42 U.S.C. §§ 12131 -- 12189) as implemented by Department of Transportation regulations at 49 C.F.R. parts 37 and 38;
- The Federal Aviation Administration’s Non-discrimination statute (49 U.S.C. § 47123) (prohibits discrimination on the basis of race, color, national origin, and sex);
- Executive Order 12898, Federal Actions to Address Environmental Justice in Minority Populations and Low-Income Populations, which ensures non-discrimination against minority populations by discouraging programs, policies, and activities with disproportionately high and adverse human health or environmental effects on minority and low-income populations;
- Executive Order 13166, Improving Access to Services for Persons with Limited English Proficiency, and resulting agency guidance, national origin discrimination includes discrimination because of limited English proficiency (LEP). To ensure compliance with Title VI, you must take reasonable steps to ensure that LEP persons have meaningful access to your programs (70 Fed. Reg. at 74087 to 74100);
- Title IX of the Education Amendments of 1972, as amended, which prohibits you from discriminating because of sex in education programs or activities (20 U.S.C. 1681 *et seq.*)

## EXECUTIVE BRANCH CODE OF ETHICS

In the 1992 regular legislative session, the General Assembly passed and Governor Brereton Jones signed Senate Bill 63 (codified as KRS 11A), the Executive Branch Code of Ethics, which states, in part:

KRS 11A.040 (7) provides:

No present or former public servant shall, within six (6) months following termination of his office or employment, accept employment, compensation, or other economic benefit from any person or business that contracts or does business with, or is regulated by, the state in matters in which he was directly involved during the last thirty-six (36) months of his tenure. This provision shall not prohibit an individual from returning to the same business, firm, occupation, or profession in which he was involved prior to taking office or beginning his term of employment, or for which he received, prior to his state employment, a professional degree or license, provided that, for a period of six (6) months, he personally refrains from working on any matter in which he was directly involved during the last thirty-six (36) months of his tenure in state government. This subsection shall not prohibit the performance of ministerial functions, including but not limited to filing tax returns, filing applications for permits or licenses, or filing incorporation papers, nor shall it prohibit the former officer or public servant from receiving public funds disbursed through entitlement programs.

KRS 11A.040 (9) states:

A former public servant shall not represent a person or business before a state agency in a matter in which the former public servant was directly involved during the last thirty-six (36) months of his tenure, for a period of one (1) year after the latter of:

- a) The date of leaving office or termination of employment; or
- b) The date the term of office expires to which the public servant was elected.

This law is intended to promote public confidence in the integrity of state government and to declare as public policy the idea that state employees should view their work as a public trust and not as a way to obtain private benefits.

If you have worked for the executive branch of state government within the past six months, you may be subject to the law's prohibitions. The law's applicability may be different if you hold elected office or are contemplating representation of another before a state agency.

Also, if you are affiliated with a firm which does business with the state and which employs former state executive-branch employees, you should be aware that the law may apply to them.

In case of doubt, the law permits you to request an advisory opinion from the Executive Branch Ethics Commission, 3 Fountain Place, Frankfort, Kentucky 40601; telephone (502) 564-7954.

Revised: January 27, 2017



## PROJECT WAGE RATES / FEDERAL FUNDED

The contractor shall use the Davis-Bacon Act Wage Determinations for Highway construction that are effective 10 calendar days prior to the letting date. The project wage determinations can be found at the following link.

[https://beta.sam.gov/search?index=wd&date\\_filter\\_index=0&date\\_rad\\_selection=date&wdType=dbra&construction\\_type=Highway&state=KY&page=1](https://beta.sam.gov/search?index=wd&date_filter_index=0&date_rad_selection=date&wdType=dbra&construction_type=Highway&state=KY&page=1)

The Division of Construction Procurement will post the official Wage Determinations for each Letting at <https://transportation.ky.gov/Construction-Procurement/Pages> under Lettings - Proposal Information - Wage Determinations.

---

Fringe benefit amounts are applicable for all hours worked except when otherwise noted.

No laborer, workman or mechanic shall be paid at a rate less than that of a Journeyman except those classified as bona fide apprentices.

Apprentices or trainees shall be permitted to work as such subject to Administrative Regulations adopted by the Commissioner of Workplace Standards. Copies of these regulations will be furnished upon request from any interested person.

Before using apprentices on the job the contractor shall present to the Contracting Officer written evidence of registration of such employees in a program of a State apprenticeship and training agency approved and recognized by the U. S. Bureau of Apprenticeship and Training. In the absence of such a State agency, the contractor shall submit evidence of approval and registration by the U. S. Bureau of Apprenticeship and Training.

The contractor shall submit to the Contracting Officer, written evidence of the established apprenticeship-journeyman ratios and wage rates in the project area, which will be the basis for establishing such ratios and rates for the project under the applicable contract provisions.

**TO: EMPLOYERS/EMPLOYEES**

### **PREVAILING WAGE SCHEDULE:**

**The wages indicated on this wage schedule are the least permitted to be paid for the occupations indicated. When an employee works in more than one classification, the employer must record the number of hours worked in each classification at the prescribed hourly base rate.**

### **OVERTIME:**

**Overtime is to be paid to an employee at a rate not less than one and one-half times the basic rate of pay for all hours worked in excess of forty (40) hours in such workweek. Wage violations or questions should be directed to the designated Engineer or the undersigned.**

Director  
Division of Construction Procurement  
Frankfort, Kentucky 40622  
502-564-3500

**NOTICE OF REQUIREMENT FOR AFFIRMATIVE ACTION  
TO ENSURE EQUAL EMPLOYMENT OPPORTUNITY  
(Executive Order 11246)**

1. The Offeror's or Bidder's attention is called to the "Equal Opportunity Clause" and the "Standard Federal Equal Employment Specifications" set forth herein.
2. The goals and timetables for minority and female participation, expressed in percentage terms for the Contractor's aggregate work force in each trade on all construction work in the covered area, are as follows:

<b>GOALS FOR MINORITY PARTICIPATION IN EACH TRADE</b>	<b>GOALS FOR FEMALE PARTICIPATION IN EACH TRADE</b>
11.2%	6.9%

These goals are applicable to all the Contractor's construction work (whether or not it is Federal or federally-assisted) performed in the covered area. If the contractor performs construction work in a geographical area located outside of the covered area, it shall apply the goals established for such geographical area where the work is actually performed. With regard to this second area, the contractor also is subject to the goals for both its federally involved and non-federally involved construction.

The Contractor's compliance with the Executive Order and the regulations in CFR Part 60-4 shall be based on its implementation of the Equal Opportunity Clause, specific affirmative action obligations required by the specifications set forth in 41 CFR 60-4, 3(a), and its efforts to meet the goals. The hours of minority and female employment and training must be substantially uniform throughout the length of the contract, and in each trade, and the contractor shall make a good faith effort to employ minorities and women evenly on each of its projects. The transfer of minority or female employees or trainees from Contractor to Contractor or from project to project for the sole purpose of meeting the Contractor's goals shall be a violation of the contract, the Executive Order and the regulations in 41 CFR Part 60-4. Compliance with the goals will be measured against the total work hours performed.

3. The Contractor shall provide written notification to the Director of the Office of Federal Contract Compliance Programs within ten (10) working days of award of any construction subcontract in excess of \$10,000.00 at any tier for construction work under the contract resulting from this solicitation. The notification shall list the name, address and telephone number of the subcontractor; employer identification number of the subcontractor; estimated dollar amount of the subcontract; estimated starting and completion dates of the subcontract; and the geographical area in which the subcontract is to be performed. The notification shall be mailed to:

**Evelyn Teague, Regional Director  
Office of Federal Contract Compliance Programs  
61 Forsyth Street, SW, Suite 7B75  
Atlanta, Georgia 30303-8609**

4. As used in this Notice, and in the contract resulting from this solicitation, the "**covered area**" is Jefferson County.

**PART IV**  
**INSURANCE**

Refer to  
*Kentucky Standard Specifications for Road and Bridge Construction,*  
current edition

**PART V**  
**BID ITEMS**



**PROPOSAL BID ITEMS**

191054

Page 1 of 1

Report Date 8/29/19

**Section: 0001 - PAVING**

LINE	BID CODE	ALT	DESCRIPTION	QUANTITY	UNIT	UNIT PRIC	FP	AMOUNT
0010	00001		DGA BASE	50.00	TON		\$	
0020	00190		LEVELING & WEDGING PG64-22	200.00	TON		\$	
0030	02058		REMOVE PCC PAVEMENT	1,632.00	SQYD		\$	
0040	02073		JPC PAVEMENT-9 IN	1,632.00	SQYD		\$	
0050	02115		SAW-CLEAN-RESEAL TVERSE JOINT	7,250.00	LF		\$	
0060	02116		SAW-CLEAN-RESEAL LONGIT JOINT	17,500.00	LF		\$	
0070	21173EC		SAW-CLEAN-RESEAL RANDOM CRACKS	2,700.00	LF		\$	
0080	24997EC		PARTIAL DEPTH PATCHING-POLYMER MOD	750.00	CUFT		\$	

**Section: 0002 - ROADWAY**

LINE	BID CODE	ALT	DESCRIPTION	QUANTITY	UNIT	UNIT PRIC	FP	AMOUNT
0090	01830		STANDARD INTEGRAL CURB	82.00	LF		\$	
0100	01904		REMOVE CURB	82.00	LF		\$	
0110	02014		BARRICADE-TYPE III	12.00	EACH		\$	
0120	02562		TEMPORARY SIGNS	1,000.00	SQFT		\$	
0130	02650		MAINTAIN & CONTROL TRAFFIC	1.00	LS		\$	
0140	02654		TRUCK MOUNTED ATTENUATOR	2.00	EACH		\$	
0150	02671		PORTABLE CHANGEABLE MESSAGE SIGN	4.00	EACH		\$	
0160	02726		STAKING	1.00	LS		\$	
0170	02775		ARROW PANEL	2.00	EACH		\$	
0180	06401		FLEXIBLE DELINEATOR POST-M/W	45.00	EACH		\$	
0190	06404		FLEXIBLE DELINEATOR POST-M/Y	30.00	EACH		\$	
0200	06511		PAVE STRIPING-TEMP PAINT-6 IN	4,070.00	LF		\$	
0210	06556		PAVE STRIPING-DUR TY 1-6 IN W	12,650.00	LF		\$	
0220	06557		PAVE STRIPING-DUR TY 1-6 IN Y	6,010.00	LF		\$	
0230	06560		PAVE STRIPING-DUR TY 1-12 IN W	1,690.00	LF		\$	
0240	06568		PAVE MARKING-THERMO STOP BAR-24IN	24.00	LF		\$	
0250	06589		PAVEMENT MARKER TYPE V-MW	25.00	EACH		\$	
0260	06590		PAVEMENT MARKER TYPE V-MY	5.00	EACH		\$	
0270	06600		REMOVE PAVEMENT MARKER TYPE V	30.00	EACH		\$	
0280	24679ED		PAVE MARK THERMO CHEVRON	260.00	SQFT		\$	

**Section: 0003 - DEMOBILIZATION &/OR MOBILIZATION**

LINE	BID CODE	ALT	DESCRIPTION	QUANTITY	UNIT	UNIT PRIC	FP	AMOUNT
0290	02569		DEMOBILIZATION	1.00	LS		\$	