



**CALL NO. 101**

**CONTRACT ID. 201027**

**WARREN COUNTY**

**FED/STATE PROJECT NUMBER NHPP 0031 (014)**

**DESCRIPTION NATCHER PARKWAY/US231 INTERCHANGE**

**WORK TYPE GRADE, DRAIN & SURFACE WITH BRIDGE**

**PRIMARY COMPLETION DATE 11/1/2021**

**LETTING DATE: September 25,2020**

Sealed Bids will be received electronically through the Bid Express bidding service until 10:00 am EASTERN DAYLIGHT TIME September 25,2020. Bids will be publicly announced at 10:00 am EASTERN DAYLIGHT TIME.

**PLANS AVAILABLE FOR THIS PROJECT.**

**DBE CERTIFICATION REQUIRED - 12%**

**REQUIRED BID PROPOSAL GUARANTY: Not less than 5% of the total bid.**

## TABLE OF CONTENTS

PART I	SCOPE OF WORK
	<ul style="list-style-type: none"><li>• PROJECT(S), COMPLETION DATE(S), &amp; LIQUIDATED DAMAGES</li><li>• CONTRACT NOTES</li><li>• FEDERAL CONTRACT NOTES</li><li>• SIGNIFICANT PROJECT -PROJECT TRAFFIC COORDINATOR</li><li>• ASPHALT MIXTURE</li><li>• INCIDENTAL SURFACING</li><li>• ASPHALT PAVEMENT RIDE QUALITY CAT B</li><li>• FUEL AND ASPHALT PAY ADJUSTMENT</li><li>• COMPACTION OPTION A</li><li>• MATERIAL TRANSFER VEHICLE (MTV)</li><li>• HOLD AWARD</li><li>• SPECIAL NOTE(S) APPLICABLE TO PROJECT</li><li>• TREE REMOVAL</li><li>• CONCRETE SLURRY</li><li>• BRIDGE DEMOLITION, RENOVATION AND ASBESTOS ABATEMENT</li><li>• ASBESTOS ABATEMENT REPORT</li><li>• RIGHT OF WAY CERTIFICATION</li><li>• UTILITY IMPACT &amp; RAIL CERTIFICATION NOTES</li><li>• GENERAL UTILITY NOTES</li><li>• SEWER STANDARD UTILITY BID ITEMS</li><li>• SEWERLINE SPECS</li><li>• DEPT OF ARMY - NATIONWIDE PERMIT</li><li>• KPDES STORM WATER PERMIT, BMP AND ENOI</li></ul>
PART II	SPECIFICATIONS AND STANDARD DRAWINGS
	<ul style="list-style-type: none"><li>• SPECIFICATIONS REFERENCE</li><li>• SUPPLEMENTAL SPECIFICATION</li><li>• [SN-11I] PORTABLE CHANGEABLE SIGNS</li><li>• [SN-11K] PARTIAL DEPTH CONCRETE PAVEMENT REPAIR</li><li>• [SN-11M] BARCODE LABEL ON PERMANENT SIGNS</li><li>• [SN-11N] LONGITUDINAL PAVEMENT JOINT ADHESIVE</li></ul>
PART III	EMPLOYMENT, WAGE AND RECORD REQUIREMENTS
	<ul style="list-style-type: none"><li>• FEDERAL-AID CONSTRUCTION CONTRACTS - FHWA 1273</li><li>• NONDISCRIMINATION OF EMPLOYEES</li><li>• EXECUTIVE BRANCH CODE OF ETHICS</li><li>• PROJECT WAGE RATES LOCALITY 1 / FEDERAL</li><li>• NOTICE OF REQUIREMENT FOR AFFIRMATIVE ACTION TO ENSURE EEO WARREN</li></ul>
PART IV	INSURANCE
PART V	BID ITEMS

**PART I**  
**SCOPE OF WORK**

## ADMINISTRATIVE DISTRICT - 03

**CONTRACT ID - 201027**

**NHPP 0031 (014)**

**COUNTY - WARREN**

**PCN - DE11490072027**

**NHPP 0031 (014)**

NATCHER PARKWAY/US231 INTERCHANGE (MP 9.4) I-65 SPUR CORRIDOR:IMPROVE THE NATCHER PARKWAY/  
US-231 INTERCHANGE(EXIT 9) ON THE WEST SIDE OF BOWLING GREEN (MP 9.6), A DISTANCE OF 02.87  
MILES.GRADE, DRAIN & SURFACE WITH BRIDGE SYP NO. 03-02042.20.

GEOGRAPHIC COORDINATES LATITUDE 36:59:32.00 LONGITUDE 86:30:15.00

**COMPLETION DATE(S):**

COMPLETED BY 11/01/2021

APPLIES TO ENTIRE CONTRACT

## **CONTRACT NOTES**

### **PROPOSAL ADDENDA**

All addenda to this proposal must be applied when calculating bid and certified in the bid packet submitted to the Kentucky Department of Highways. Failure to use the correct and most recent addenda may result in the bid being rejected.

### **BID SUBMITTAL**

Bidder must use the Department's electronic bidding software. The Bidder must download the bid file located on the Bid Express website ([www.bidx.com](http://www.bidx.com)) to prepare a bid packet for submission to the Department. The bidder must submit electronically using Bid Express.

### **JOINT VENTURE BIDDING**

Joint venture bidding is permissible. All companies in the joint venture must be prequalified in one of the work types in the Qualifications for Bidders for the project. The bidders must get a vendor ID for the joint venture from the Division of Construction Procurement and register the joint venture as a bidder on the project. Also, the joint venture must obtain a digital ID from Bid Express to submit a bid. A joint bid bond of 5% may be submitted for both companies or each company may submit a separate bond of 5%.

### **UNDERGROUND FACILITY DAMAGE PROTECTION**

The contractor shall make every effort to protect underground facilities from damage as prescribed in the Underground Facility Damage Protection Act of 1994, Kentucky Revised Statute KRS 367.4901 to 367.4917. It is the contractor's responsibility to determine and take steps necessary to be in compliance with federal and state damage prevention directives. When prescribed in said directives, the contractor shall submit Excavation Locate Requests to the Kentucky Contact Center (KY811) via web ticket entry. The submission of this request does not relieve the contractor from the responsibility of contacting non-member facility owners, whom shall be contacted through their individual Protection Notification Center. Non-compliance with these directives can result in the enforcement of penalties.

### **REGISTRATION WITH THE SECRETARY OF STATE BY A FOREIGN ENTITY**

Pursuant to KRS 176.085(1)(b), an agency, department, office, or political subdivision of the Commonwealth of Kentucky shall not award a state contract to a person that is a foreign entity required by [KRS 14A.9-010](#) to obtain a certificate of authority to transact business in the Commonwealth ("certificate") from the Secretary of State under [KRS 14A.9-030](#) unless the person produces the certificate within fourteen (14) days of the bid or proposal opening. If the foreign entity is not required to obtain a certificate as provided in [KRS 14A.9-010](#), the foreign entity should identify the applicable exception. Foreign entity is defined within [KRS 14A.1-070](#).

**For all foreign entities required to obtain a certificate of authority to transact business in the Commonwealth, if a copy of the certificate is not received by the contracting agency within the time frame identified above, the foreign entity's solicitation response shall be deemed non-responsive or the awarded contract shall be cancelled.**

Businesses can register with the Secretary of State at <https://secure.kentucky.gov/sos/ftbr/welcome.aspx>.

### **SPECIAL NOTE FOR PROJECT QUESTIONS DURING ADVERTISEMENT**

Questions about projects during the advertisement should be submitted in writing to the Division of Construction Procurement. This may be done by fax (502) 564-7299 or email to [kytc.projectquestions@ky.gov](mailto:kytc.projectquestions@ky.gov). The Department will attempt to answer all submitted questions. The Department reserves the right not to answer if the question is not pertinent or does not aid in clarifying the project intent.

The deadline for posting answers will be 3:00 pm Eastern Daylight Time, the day preceding the Letting. Questions may be submitted until this deadline with the understanding that the later a question is submitted, the less likely an answer will be able to be provided.

The questions and answers will be posted for each Letting under the heading "Questions & Answers" on the Construction Procurement website ([www.transportation.ky.gov/contract](http://www.transportation.ky.gov/contract)). The answers provided shall be considered part of this Special Note and, in case of a discrepancy, will govern over all other bidding documents.

### **HARDWOOD REMOVAL RESTRICTIONS**

The US Department of Agriculture has imposed a quarantine in Kentucky and several surrounding states, to prevent the spread of an invasive insect, the emerald ash borer. Hardwood cut in conjunction with the project may not be removed from the state. Chipping or burning on site is the preferred method of disposal.

### **INSTRUCTIONS FOR EXCESS MATERIAL SITES AND BORROW SITES**

Identification of excess material sites and borrow sites shall be the responsibility of the Contractor. The Contractor shall be responsible for compliance with all applicable state and federal laws and may wish to consult with the US Fish and Wildlife Service to seek protection under Section 10 of the Endangered Species Act for these activities.

### **ACCESS TO RECORDS**

The contractor, as defined in KRS 45A.030 (9) agrees that the contracting agency, the Finance and Administration Cabinet, the Auditor of Public Accounts, and the Legislative Research Commission, or their duly authorized representatives, shall have access to any books, documents, papers, records, or other evidence, which are directly pertinent to this contract for the purpose of financial audit or program review. Records and other prequalification information confidentially

disclosed as part of the bid process shall not be deemed as directly pertinent to the contract and shall be exempt from disclosure as provided in KRS 61.878(1)(c). The contractor also recognizes that any books, documents, papers, records, or other evidence, received during a financial audit or program review shall be subject to the Kentucky Open Records Act, KRS 61.870 to 61.884.

In the event of a dispute between the contractor and the contracting agency, Attorney General, or the Auditor of Public Accounts over documents that are eligible for production and review, the Finance and Administration Cabinet shall review the dispute and issue a determination, in accordance with Secretary's Order 11-004.

April 30, 2018

### **FEDERAL CONTRACT NOTES**

The Kentucky Department of Highways, in accordance with the Regulations of the United States Department of Transportation 23 CFR 635.112 (h), hereby notifies all bidders that failure by a bidder to comply with all applicable sections of the current Kentucky Standard Specifications, including, but not limited to the following, may result in a bid not being considered responsive and thus not eligible to be considered for award:

- |                                |  |
|--------------------------------|--|
| 102.02 Current Rating          | 102.08 Preparation and Delivery of Proposals |
| 102.13 Irregular Bid Proposals | 102.14 Disqualification of Bidders           |
| 102.09 Proposal Guaranty       |  |

### **CIVIL RIGHTS ACT OF 1964**

The Kentucky Department of Highways, in accordance with the provisions of Title VI of the Civil Rights Act of 1964 (78 Stat. 252) and the Regulations of the Federal Department of Transportation (49 C.F.R., Part 21), issued pursuant to such Act, hereby notifies all bidders that it will affirmatively insure that the contract entered into pursuant to this advertisement will be awarded to the lowest responsible bidder without discrimination on the ground of race, color, or national origin.

### **NOTICE TO ALL BIDDERS**

To report bid rigging activities call: 1-800-424-9071.

The U.S. Department of Transportation (DOT) operates the above toll-free "hotline" Monday through Friday, 8:00 a.m. to 5:00 p.m. eastern time. Anyone with knowledge of possible bid rigging, bidder collusion, or other fraudulent activities should use the "hotline" to report such activities.

The "hotline" is part of the DOT's continuing effort to identify and investigate highway construction contract fraud and abuse and is operated under the direction of the DOT Inspector General. All information will be treated confidentially and caller anonymity will be respected.

### **SECOND TIER SUBCONTRACTS**

Second Tier subcontracts on federally assisted projects shall be permitted. However, in the case of DBE's, second tier subcontracts will only be permitted where the other subcontractor is also a DBE. All second tier subcontracts shall have the consent of both the Contractor and the Engineer.



### **DISADVANTAGED BUSINESS ENTERPRISE PROGRAM**

It is the policy of the Kentucky Transportation Cabinet (“the Cabinet”) that Disadvantaged Business Enterprises (“DBE”) shall have the opportunity to participate in the performance of highway construction projects financed in whole or in part by Federal Funds in order to create a level playing field for all businesses who wish to contract with the Cabinet. To that end, the Cabinet will comply with the regulations found in 49 CFR Part 26, and the definitions and requirements contained therein shall be adopted as if set out verbatim herein.

The Cabinet, contractors, subcontractors, and sub-recipients shall not discriminate on the basis of race, color, national origin, or sex in the performance of work performed pursuant to Cabinet contracts. The contractor shall carry out applicable requirements of 49 CFR 26 in the award and administration of federally assisted highway construction projects. The contractor will include this provision in all its subcontracts and supply agreements pertaining to contracts with the Cabinet.

Failure by the contractor to carry out these requirements is a material breach of its contract with the Cabinet, which may result in the termination of the contract or such other remedy as the Cabinet deems necessary.

### **DBE GOAL**

The Disadvantaged Business Enterprise (DBE) goal established for this contract, as listed on the front page of the proposal, is the percentage of the total value of the contract.

The contractor shall exercise all necessary and reasonable steps to ensure that Disadvantaged Business Enterprises participate in at least the percent of the contract as set forth above as goals for this contract.

### **OBLIGATION OF CONTRACTORS**

Each contractor prequalified to perform work on Cabinet projects shall designate and make known to the Cabinet a liaison officer who is assigned the responsibility of effectively administering and promoting an active program for utilization of DBEs.

If a formal goal has not been designated for the contract, all contractors are encouraged to consider DBEs for subcontract work as well as for the supply of material and services needed to perform this work.

Contractors are encouraged to use the services of banks owned and controlled by minorities and women.

### **CERTIFICATION OF CONTRACT GOAL**

Contractors shall include the following certification in bids for projects for which a DBE goal has been established. BIDS SUBMITTED WHICH DO NOT INCLUDE CERTIFICATION OF DBE PARTICIPATION WILL NOT BE ACCEPTED. These bids will not be considered for award by the Cabinet and they will be returned to the bidder.

“The bidder certifies that it has secured participation by Disadvantaged Business Enterprises (“DBE”) in the amount of \_\_\_\_\_ percent of the total value of this contract and that the DBE participation is in compliance with the requirements of 49 CFR 26 and the policies of the Kentucky Transportation Cabinet pertaining to the DBE Program.”

**The certification statement is located in the electronic bid file. All contractors must certify their DBE participation on that page. DBEs utilized in achieving the DBE goal must be certified and prequalified for the work items at the time the bid is submitted.**

### **DBE PARTICIPATION PLAN**

Lowest responsive bidders must submit the *DBE Plan/ Subcontractor Request*, form TC 14-35 DBE, within **5** days of the letting. This is necessary before the Awards Committee will review and make a recommendation. **The project will not be considered for award prior to submission and approval of the apparent low bidder’s DBE Plan/Subcontractor Request.**

The DBE Participation Plan shall include the following:

1. Name and address of DBE Subcontractor(s) and/or supplier(s) intended to be used in the proposed project;
2. Description of the work each is to perform including the work item, unit, quantity, unit price and total amount of the work to be performed by the individual DBE. The Proposal Line Number, Category Number, and the Project Line Number can be found in the “material listing” on the Construction Procurement website under the specific letting;
3. The dollar value of each proposed DBE subcontract and the percentage of total project contract value this represents. DBE participation may be counted as follows:
  - a. If DBE suppliers and manufactures assume actual and contractual responsibility, the dollar value of materials to be furnished will be counted toward the goal as follows:
    - The entire expenditure paid to a DBE manufacturer;
    - 60 percent of expenditures to DBE suppliers that are not manufacturers provided the supplier is a regular dealer in the product involved. A regular dealer must be engaged in, as its principal business and in its own name, the sale of products to the public, maintain an inventory and own and operate distribution equipment; and
    - The amount of fees or commissions charged by the DBE firms for a bona fide service, such as professional, technical, consultant, or managerial services and assistance in the procurement of essential personnel, facilities, equipment, materials, supplies, delivery of materials and supplies or for furnishing bonds, or insurance, providing such fees or commissions are determined to be reasonable and customary.

- b) The dollar value of services provided by DBEs such as quality control testing, equipment repair and maintenance, engineering, staking, etc.;
  - c) The dollar value of joint ventures. DBE credit for joint ventures will be limited to the dollar amount of the work actually performed by the DBE in the joint venture;
4. Written and signed documentation of the bidder's commitment to use a DBE contractor whose participation is being utilized to meet the DBE goal; and
  5. Written and signed confirmation from the DBE that it is participating in the contract as provided in the prime contractor's commitment.

#### **UPON AWARD AND BEFORE A WORK ORDER WILL BE ISSUED**

Contractors must submit the signed subcontract between the contractor and the DBE contractor, along with the DBE's certificate of insurance. If the DBE is a supplier of materials for the project, a signed purchase order must be submitted to the Division of Construction Procurement.

Changes to DBE Participation Plans must be approved by the Cabinet. The Cabinet may consider extenuating circumstances including, but not limited to, changes in the nature or scope of the project, the inability or unwillingness of a DBE to perform the work in accordance with the bid, and/or other circumstances beyond the control of the prime contractor.

#### **CONSIDERATION OF GOOD FAITH EFFORTS REQUESTS**

If the DBE participation submitted in the bid by the apparent lowest responsive bidder does not meet or exceed the DBE contract goal, the apparent lowest responsive bidder must submit a Good Faith Effort Package to satisfy the Cabinet that sufficient good faith efforts were made to meet the contract goals prior to submission of the bid. Efforts to increase the goal after bid submission will not be considered in justifying the good faith effort, unless the contractor can show that the proposed DBE was solicited prior to the letting date. DBEs utilized in achieving the DBE goal must be certified and prequalified for the work items at the time the bid is submitted. One complete set (hard copy along with an electronic copy) of this information must be received in the Division of Contract Procurement no later than 12:00 noon of the tenth calendar day after receipt of notification that they are the apparent low bidder.

Where the information submitted includes repetitious solicitation letters it will be acceptable to submit a sample representative letter along with a distribution list of the firms solicited. Documentation of DBE quotations shall be a part of the good faith effort submittal as necessary to demonstrate compliance with the factors listed below which the Cabinet considers in judging good faith efforts. This documentation may include written subcontractors' quotations, telephone log notations of verbal quotations, or other types of quotation documentation.

The Good Faith Effort Package shall include, but may not be limited to information showing evidence of the following:

1. Whether the bidder attended any pre-bid meetings that were scheduled by the Cabinet to inform DBEs of subcontracting opportunities;
2. Whether the bidder provided solicitations through all reasonable and available means;
3. Whether the bidder provided written notice to all DBEs listed in the DBE directory at the time of the letting who are prequalified in the areas of work that the bidder will be subcontracting;
4. Whether the bidder followed up initial solicitations of interest by contacting DBEs to determine with certainty whether they were interested. If a reasonable amount of DBEs within the targeted districts do not provide an intent to quote or no DBEs are prequalified in the subcontracted areas, the bidder must notify the Disadvantaged Enterprise Business Liaison Officer (DEBLO) in the Office of Civil Rights and Small Business Development to give notification of the bidder's inability to get DBE quotes;
5. Whether the bidder selected portions of the work to be performed by DBEs in order to increase the likelihood of meeting the contract goals. This includes, where appropriate, breaking out contract work items into economically feasible units to facilitate DBE participation, even when the prime contractor might otherwise perform these work items with its own forces;
6. Whether the bidder provided interested DBEs with adequate and timely information about the plans, specifications, and requirements of the contract;
7. Whether the bidder negotiated in good faith with interested DBEs not rejecting them as unqualified without sound reasons based on a thorough investigation of their capabilities. Any rejection should be so noted in writing with a description as to why an agreement could not be reached;
8. Whether quotations were received from interested DBE firms but were rejected as unacceptable without sound reasons why the quotations were considered unacceptable. The fact that the DBE firm's quotation for the work is not the lowest quotation received will not in itself be considered as a sound reason for rejecting the quotation as unacceptable. The fact that the bidder has the ability and/or desire to perform the contract work with its own forces will not be considered a sound reason for rejecting a DBE quote. Nothing in this provision shall be construed to require the bidder to accept unreasonable quotes in order to satisfy DBE goals;
9. Whether the bidder specifically negotiated with subcontractors to assume part of the responsibility to meet the contract DBE goal when the work to be subcontracted includes potential DBE participation;
10. Whether the bidder made any efforts and/or offered assistance to interested DBEs in obtaining the necessary equipment, supplies, materials, insurance and/or bonding to satisfy the work requirements of the bid proposal; and
11. Any other evidence that the bidder submits which may show that the bidder has made reasonable good faith efforts to include DBE participation.

### **FAILURE TO MEET GOOD FAITH REQUIREMENT**

Where the apparent lowest responsive bidder fails to submit sufficient participation by DBE firms to meet the contract goal and upon a determination by the Good Faith Committee based upon the information submitted that the apparent lowest responsive bidder failed to make sufficient reasonable efforts to meet the contract goal, the bidder will be offered the opportunity to meet in person for administrative reconsideration. The bidder will be notified of the Committee's decision within 24 hours of its decision. The bidder will have 24 hours to request reconsideration of the Committee's decision. The reconsideration meeting will be held within two days of the receipt of a request by the bidder for reconsideration.

The request for reconsideration will be heard by the Office of the Secretary. The bidder will have the opportunity to present written documentation or argument concerning the issue of whether it met the goal or made an adequate good faith effort. The bidder will receive a written decision on the reconsideration explaining the basis for the finding that the bidder did or did not meet the goal or made adequate Good Faith efforts to do so.

The result of the reconsideration process is not administratively appealable to the Cabinet or to the United States Department of Transportation.

The Cabinet reserves the right to award the contract to the next lowest responsive bidder or to rebid the contract in the event that the contract is not awarded to the low bidder as the result of a failure to meet the good faith requirement.

### **SANCTIONS FOR FAILURE TO MEET DBE REQUIREMENTS OF THE PROJECT**

Failure by the prime contractor to fulfill the DBE requirements of a project under contract or to demonstrate good faith efforts to meet the goal constitutes a breach of contract. When this occurs, the Cabinet will hold the prime contractor accountable, as would be the case with all other contract provisions. Therefore, the contractor's failure to carry out the DBE contract requirements shall constitute a breach of contract and as such the Cabinet reserves the right to exercise all administrative remedies at its disposal including, but not limited to the following:

- Disallow credit toward the DBE goal;
- Withholding progress payments;
- Withholding payment to the prime in an amount equal to the unmet portion of the contract goal; and/or
- Termination of the contract.

### **PROMPT PAYMENT**

The prime contractor will be required to pay the DBE within seven (7) working days after he or she has received payment from the Kentucky Transportation Cabinet for work performed or materials furnished.

### **CONTRACTOR REPORTING**

All contractors must keep detailed records and provide reports to the Cabinet on their progress in meeting the DBE requirement on any highway contract. These records may include, but shall not be limited to payroll, lease agreements, cancelled payroll checks, executed subcontracting agreements, etc. Prime contractors will be required to complete and submit a **signed and notarized** Affidavit of Subcontractor Payment (TC 18-7) and copies of checks for any monies paid to each DBE subcontractor or supplier utilized to meet a DBE goal. These documents must be completed and signed within 7 days of being paid by the Cabinet.

Payment information that needs to be reported includes date the payment is sent to the DBE, check number, Contract ID, amount of payment and the check date. Before Final Payment is made on this contract, the Prime Contractor will certify that all payments were made to the DBE subcontractor and/or DBE suppliers.

**\*\*\*\*\* IMPORTANT \*\*\*\*\***

**Please mail the original, signed and completed TC (18-7) Affidavit of Subcontractor Payment form and all copies of checks for payments listed above to the following address:**

Office of Civil Rights and Small Business Development  
6<sup>th</sup> Floor West 200 Mero Street  
Frankfort, KY 40622

The prime contractor should notify the KYTC Office of Civil Rights and Small Business Development seven (7) days prior to DBE contractors commencing work on the project. The contact in this office is Mr. Melvin Bynes. Mr. Bynes' current contact information is email address – [melvin.bynes2@ky.gov](mailto:melvin.bynes2@ky.gov) and the telephone number is (502) 564-3601.

### **DEFAULT OR DECERTIFICATION OF THE DBE**

If the DBE subcontractor or supplier is decertified or defaults in the performance of its work, and the overall goal cannot be credited for the uncompleted work, the prime contractor may utilize a substitute DBE or elect to fulfill the DBE goal with another DBE on a different work item. If after exerting good faith effort in accordance with the Cabinet's Good Faith Effort policies and procedures, the prime contractor is unable to replace the DBE, then the unmet portion of the goal may be waived at the discretion of the Cabinet.

### **PROHIBITION ON TELECOMMUNICATIONS EQUIPMENT OR SERVICES**

In accordance with the FY 2019 National Defense Authorization Act (NDAA), 2 CFR 200.216, and 2 CFR 200.471, Federal agencies are prohibited, after August 13, 2020, from obligating or expending financial assistance to obtain certain telecommunications and video surveillance services and equipment from specific producers. As a result of these regulations, contractors and subcontractors are prohibited, on projects with federal funding participation, from providing telecommunication or video surveillance equipment, services, or systems produced by:

- Huawei Technologies Company or ZTE Corporation (or any subsidiary or affiliate of such entities)
- Hytera Communications Corporation, Hangzhou Hikvision Digital Technology Company, or Dahua Technology Company (or any subsidiary or affiliate of such entities)

**LEGAL REQUIREMENTS AND RESPONSIBILITY TO THE PUBLIC – CARGO PREFERENCE ACT (CPA).**

**(REV 12-17-15) (1-16)**

SECTION 7 is expanded by the following new Article:

102.10 **Cargo Preference Act – Use of United States-flag vessels.**

Pursuant to Title 46CFR Part 381, the Contractor agrees

- To utilize privately owned United States-flag commercial vessels to ship at least 50 percent of the gross tonnage (computed separately for dry bulk carriers, dry cargo liners, and tankers) involved, whenever shipping any equipment, material, or commodities pursuant to this contract, to the extent such vessels are available at fair and reasonable rates for United States-flag commercial vessels.

- To furnish within 20 days following the date of loading for shipments originating within the United States or within 30 working days following the date of loading for shipments originating outside the United States, a legible copy of a rated, 'on-board' commercial ocean bill-of-lading in English for each shipment of cargo described in paragraph 1 of this section to both the Contracting Officer (through the prime contractor in the case of subcontractor bills-of-lading) and to the Division of National Cargo, Office of Market Development, Maritime Administration, Washington, DC 20590.

- To insert the substance of the provisions of this clause in all subcontracts issued pursuant to this contract.

### **PROJECT TRAFFIC COORDINATOR (PTC)**

Be advised this project is a significant project pursuant to section 112.03.12.

### **ASPHALT MIXTURE**

Unless otherwise noted, the Department estimates the rate of application for all asphalt mixtures to be 110 lbs/sy per inch of depth.

### **INCIDENTAL SURFACING**

The Department has included in the quantities of asphalt mixtures established in the proposal estimated quantities required for resurfacing or surfacing mailbox turnouts, farm field entrances, residential and commercial entrances, curve widening, ramp gores and tapers, and road and street approaches, as applicable. Pave these areas to the limits as shown on Standard Drawing RPM-110-06 or as directed by the Engineer. In the event signal detectors are present in the intersecting streets or roads, pave the crossroads to the right of way limit or back of the signal detector, whichever is the farthest back of the mainline. Surface or resurface these areas as directed by the Engineer. The Department will not measure placing and compacting for separate payment but shall be incidental to the Contract unit price for the asphalt mixtures.

### **ASPHALT PAVEMENT RIDE QUALITY CATEGORY B**

The Department will apply Pavement Rideability Requirements on this project in accordance with Section 410, Category B.

### **FUEL AND ASPHALT PAY ADJUSTMENT**

The Department has included the Contract items Asphalt Adjustment and Fuel Adjustment for possible future payments at an established Contract unit price of \$1.00. The Department will calculate actual adjustment quantities after work is completed. If existing Contract amount is insufficient to pay all items on the contract with the adjustments, the Department will establish additional monies with a change order.

### **OPTION A**

Be advised that the Department will accept compaction of asphalt mixtures furnished for driving lanes and ramps, at 1 inch (25mm) or greater, on this project according to OPTION A in accordance with Section 402 and Section 403 of the current Standard Specifications. The Department will require joint cores as described in Section 402.03.02 for surface mixtures only. The Department will accept compaction of all other asphalt mixtures according to OPTION B.

### **MATERIAL TRANSFER VEHICLE (MTV)**

Provide and use a MTV in accordance with Sections 403.02.10 and 403.03.05.



## **SPECIAL NOTE FOR AWARD OF CONTRACT**

In accordance to section 103.02 of the Standard Specifications for Road and Bridge Construction, the Department may hold and not award the contract for a period not to exceed sixty (60) calendar days from the date of letting.

**SPECIAL NOTES  
DISTRICT NO. 3  
WARREN COUNTY  
BRIDGE REHABILITATION**

**114B00055N**

US 231 over KY 9007 (Natcher Parkway)

***Geographic Coordinates***

Latitude 36° 59' 32.28''

Longitude -86° 30' 14.76''

***Description***

58'-0"~ 86'-0"~ 86'-0"~ 58'-0" Rolled Steel Girder Spans, Existing Drawing No. 18119

**SPECIAL NOTES**

SPECIAL NOTE FOR BRIDGE RESTORATION AND WATERPROOFING WITH CONCRETE OVERLAYS

SPECIAL NOTE FOR REMOVE CONCRETE MEDIAN

SPECIAL NOTE FOR BRIDGE BARRIER RETROFIT

SPECIAL NOTE FOR REPLACING EXPANSION DAMS AND/OR INSTALLING ARMORED EDGES FOR CONCRETE ON BRIDGES

SPECIAL NOTE FOR CONCRETE SEALING

## **SPECIAL NOTE FOR BRIDGE DECK RESTORATION AND WATERPROOFING WITH CONCRETE OVERLAYS**

- 1. DESCRIPTION.** Perform all work in accordance with the Kentucky Transportation Cabinet, Department of Highway's Standard Specifications for Road and Bridge Construction and applicable Supplemental Specifications, the Standard Drawings (current editions), this Note, and the attached detail drawings. Section references are to the Standard Specifications. This work consists of the following: (1) Furnish all labor, materials, tools, and equipment; (2) Machine preparation the existing slab; (3) Complete full-depth and partial depth repairs as directed by the Engineer; (4) Repair/replace damaged and corroded reinforcing bars; (5) Place new concrete overlay and epoxy-sand slurry in accordance with Section 606; (6) Complete asphalt approach pavement; (7) Maintain and control traffic; and (8) Any other work specified as part of this contract. All construction will be in accordance with Section 606 unless otherwise specified.
- 2. MATERIALS.**

  - A. Latex Concrete.** See Section 606.03.17.
  - B. Class "M" Concrete.** Use either "M1" or "M2". See Section 601.
  - C. Bituminous Asphalt.** Use CL2 ASPH SURF 0.38D PG64-22.
  - D. Epoxy-Sand Slurry.** See Section 606.03.10.
- 3. CONSTRUCTION.**

  - A. Machine Preparation of Existing Slab.** After removal of 6" concrete median, remove concrete from existing slab to a depth of at least ¼" below the surface, and remove all patches completely, in accordance with the requirements of Section 606.03.03.
  - B. Partial Depth Slab Repair and Latex Overlay.** Remove areas determined to be unsound by the Engineer via hydro-demolition or via hand held jackhammers weighing less than 45lbs in accordance with Section 606.02.10 D. Repair/Replace all damaged or severely corroded reinforcing bars prior to partial depth repair operation. The Department will not measure material removal and will consider this work incidental to the bid item "PARTIAL DEPTH PATCHING". Mix and place Latex Modified Concrete Overlay in accordance with Sections 606.03.08 and 606.03.17.
  - C. Asphalt Approach Pavement.** Mill each existing asphalt approach for a distance of 100 feet from the bridge end. Remove the bituminous material uniformly by making an edge key, so as to provide a smooth transition to the finished bridge when a new bituminous overlay of compacted depth of approximately 1½" is added to the approaches. The grinding depth may vary depending on the condition of the existing approach and final elevation of bridge end. Dispose of all removed material away from the site.
  - D. Surface Texturing.** Texture the concrete surface of the overlay in accordance with Section 609.03.10.
  - E. Verifying Field Conditions.** The Contractor shall field verify all existing dimensions before ordering any material. New material that is unsuitable due to variation in existing structure shall be replaced at the Contractors expense.
  - F. Damage to the Structure.** The Contractor shall bear all responsibility and expense for any and all damage to the structure during the repair work even to

removal and replacement of a fallen span, should the fallen span result from the Contractor's actions.

- G. Residual lead paint may still be on bridge.** The Contractor is advised to take all necessary protective measures including worker safety and environmental regulations when performing surface preparation and other work. The Department will not consider any claims based on residual lead paint.
4. **MEASUREMENT.** See Section 606 and the following:
- A. Latex Modified Concrete for Overlay.** The Department will measure the quantity in cubic yards using the theoretical volume as follows for the bridge:
- $$114B00055N \quad (289'9'' \times 88'0'' \times 2'') = 157.4 \text{ CY}$$
- B. Latex Modified Concrete for Partial Depth Patching and variable thickness of Overlay.** The Department will measure the quantity in cubic yards by deducting the theoretical volume of bridge deck overlay (LMC) from the total volume (as indicated by the batch quantity tickets) of Concrete required to obtain the finished grade shown on the Plans or established by the Engineer.
- C. Machine Preparation of Slab.** The Department will measure the machine preparation of the existing bridge deck in square yards, which shall include all labor, equipment, and material needed to complete this work.
- D. Steel Reinforcement.** The Department will measure any reinforcing steel necessary for the partial or full depth patch in pounds, which shall include all labor, equipment, and material needed to complete this work.
- E. Asphalt Approach Pavement.** The Department will measure the quantity in square yards, which shall include all labor, equipment, and material needed to complete this work.
5. **PAYMENT.** See Section 606 and the following:
- A. Latex Modified Concrete for Overlay.** The Department will make payment for the Latex Modified Concrete under bid item #08534 "CONCRETE OVERLAY - LATEX" for the quantity in cubic yards complete in place.
- B. Latex Modified Concrete for Partial Depth Patching and variable thickness of Overlay.** The Department will make payment for the Partial Depth Patching under bid item #24094EC "PARTIAL DEPTH PATCHING". Payment will be for the quantity per cubic yard complete in place.
- C. Machine Preparation of Slab.** The Department will make payment for the machine preparation of the existing deck under bid item #08551 "MACHINE PREP OF SLAB". Payment will be for the square yard complete.
- D. Steel Reinforcement.** The Department will make payment for steel reinforcement, if necessary, under bid item #08151 "STEEL REINFORCEMENT-EPOXY COATED". Payment will be at the unit price per pound.
- E. Asphalt Approach Pavement.** The Department will make payment for the completed and accepted quantity of this work under the bid item #03304 "BRIDGE OVERLAY APPROACH PAVEMENT".

## SPECIAL NOTE FOR REMOVE MEDIAN

1. **DESCRIPTION.** Perform all work in accordance with the Kentucky Transportation Cabinet, Department of Highway's Standard Specifications for Road and Bridge Construction and applicable Supplemental Specifications, the Standard Drawings, (Current Additions), this note, and the attached detail drawings. This work consists of: (1) Furnish all labor, materials, tools, and equipment; (2) Remove Concrete Median and (3) Any other work specified as part of this contract.

### 2. CONSTRUCTION

- A. **Remove Concrete Median.** Remove all portions of the concrete median to depth that will match the new surface of the bridge deck that will receive the latex overlay. Remove all existing steel reinforcement above the new surface depth. Cut the existing vertical steel reinforcement flush with the new surface depth. See Section 606.03.03. Dispose of all removed material away from the site.
- B. **Coating Existing Steel Reinforcement.** Coat all exposed existing steel reinforcement with bituminous paint after blast cleaning.
- C. **Remove Asphalt Median.** Remove the medians at each approach of the bridge to a depth at or below the existing subgrade. Construct the median area back to match the existing roadway subgrade and asphalt depths before constructing the new bridge approaches. Dispose of all removed material away from the site.
- D. **Damage to the structure.** The Contractor shall bear all responsibility and expense for any and all damage to the structure during the repair work, even to the removal and replacement of a fallen span, should the fallen span result from the Contractors actions.

### 3. EQUIPMENT.

- A. **Hammer.** See Section 606.02.10 B.
- B. **Sawing Equipment.** See Section 606.02.10 C.
- C. **Hydraulic Impact Equipment.** See Section 606.02.10 D.

### 4. MEASUREMENT

- A. **Remove Concrete Median.** The Department will measure the quantity in linear feet from end to end of the bridge slab.
- B. **Remove Asphalt Median.** The Department will measure the quantity in linear feet 100 feet off each end of bridge.

### 5. PAYMENT

- A. **Remove Concrete Median (02006).** Payment at the contract unit price per linear foot for is full compensation for removing the concrete median and all incidental materials within the pay limits as specified by the note and the attached detailed drawings.
- B. **Remove Asphalt Median (02008).** Payment at the contract unit price per linear foot for is full compensation for removing the asphalt median and all incidental materials within the pay limits as specified by the note and the attached detailed drawings.

## SPECIAL NOTE FOR BRIDGE BARRIER RETROFIT

1. **DESCRIPTION.** Perform all work in accordance with the Kentucky Transportation Cabinet, Department of Highway's Standard Specification for Road and Bridge Construction and applicable Supplemental Specifications, the Standard Drawings (current editions), this note, and the attached detail drawings. Section references are to the Standard Specifications. This work consists of the following: (1) Furnish all labor, materials, tools, and equipment; (2) Remove existing spalled/delaminated concrete, specified concrete portions (3) Prepare the existing surface (4) Any other work specified as part of this contract.

2. **MATERIALS.**

A. **CLASS AA Concrete.** See Section 606.03.17.

B. **Steel Reinforcement.** Use Grade 60. See Section 602

C. **Conduit and Junction Boxes.** See attached detailed drawings and section 716 and 834

3. **EQUIPMENT.**

A. **Hammer.** See Section 606.02.10 B.

B. **Sawing Equipment.** See Section 606.02.10 C.

C. **Hydraulic Impact Equipment.** See Section 606.02.10 D.

4. **CONSTRUCTION.**

A. **Concrete Removal and Preparation.**

**Bridge Barrier.** The Contractor, as directed by the Engineer shall locate and remove all loose, spalled, deteriorated and delaminated concrete from the existing curb and specified areas of bridge end and abutment wingwalls. Sounding shall be used to locate delaminated areas. Care shall be exercised not to damage areas of sound concrete or reinforcing steel during concrete removal operations. Unless specifically directed by the Engineer, depth of removal shall not exceed 6 inches. Concrete removal shall be in accordance with a sequence approved by the Engineer. Concrete removal shall be accomplished by chipping with hand picks, chisels or light duty pneumatic or electric chipping hammers (not to exceed 15 lbs.). If sound concrete is encountered before existing reinforcing steel is exposed, the surface shall be prepared and repaired without further removal of the concrete. When corroded reinforcing steel is exposed, concrete removal shall continue until there is a minimum  $\frac{3}{4}$  inch clearance around the exposed, corroded reinforcing bar. Care shall be taken to not damage bond to adjacent non-exposed reinforcing steel during concrete removal processes. The perimeter of all areas where concrete is removed shall be tapered at an approximately 45° angle, except that the outer edges of all chipped areas shall be saw cut to minimum depth of  $\frac{3}{4}$  inch to prevent featheredging unless otherwise approved by the Engineer.

**Abutment Wing Wall and Bridge End Areas.**

Remove the specified areas of concrete as shown on the plans or as directed by the Engineer. Unless otherwise specified clean and leave all existing steel reinforcement encountered in place. Damaged steel reinforcement will be

repaired/replaced as directed by the Engineer at no additional cost to the Department.

After all loose, spalled, deteriorated, delaminated and specified concrete portions have been removed, abrasive blast clean the repaired surface to receive new concrete to remove all fractured surface concrete and all traces of any unsound material or contaminants such as oil, grease, dirt, slurry, or any materials which could interfere with the bond of freshly placed concrete. The Contractor shall dispose all removed material off State Right of Way in an approved site. All cost to remove the specified concrete and prepare the surfaces shall be included in unit price bid for "BRIDGE BARRIER RETROFIT".

- B. Handrail Removal.** The Contractor, as directed by the Engineer shall remove the existing handrail and components from the bridge barrier. After removal is complete all removed handrail and components shall be delivered to the Warren County Maintenance Facility, 2160 Three Springs Rd, Bowling Green, KY 42102 . All cost to remove and delivery of the handrail shall be included in unit price bid for "BRIDGE BARRIER RETROFIT".
  - C. Prepare existing surface.** Prepare the existing surface by blast cleaning in accordance with 606.03.04.
  - D. Construct Bridge Barrier Retrofit.** Form and pour new barrier wall in accordance with this note and the attached detailed drawings.
  - E. Install Conduit and Electric Junction Box.** Install conduit and junction boxes in accordance with this note, attached detailed drawings and section 716 and 834.
5. **MEASUREMENT.**
- A. Bridge Barrier Retrofit.** The Department will measure the quantity in linear feet from end to end of bridge wings.
  - B. Steel Reinforcement Epoxy Coated.** See Section 602.
  - C. Conduit 2 In.** The Department will measure the quantity in linear feet. The conduit shall extend 4" passed the end of the wingwalls.
  - D. Electrical Junction Box.** The Department will measure this quantity as Each.
6. **PAYMENT.**
- A. Bridge Barrier Retrofit (23032EN).** Payment will be full compensation for all materials for the construction of the bridge barrier wall retrofit, including but not limited to, all concrete and reinforcing steel. Payment will also be full compensation for all labor for the construction of the bridge barrier wall retrofit, including but not limited to, blast cleaning surface, all drilling and epoxying of reinforcement steel, forming, pouring and removing formwork of the barrier. Guardrail, end treatments, and bridge connections will all be pay items.
  - B. Conduit 2 In (04795).** Payment will be full compensation for installation of the conduit and all incidental items as specified in this note, attached detailed drawings and Section 716 and 834.
  - C. Electrical Junction Box (04810).** Payment will be full compensation for installation of the electrical junction boxes and all incidental items as specified in this note, attached detailed drawing and Section 716 and 834

## **SPECIAL NOTE FOR REPLACING EXPANSION DAMS AND/OR INSTALLING ARMORED EDGES FOR CONCRETE ON BRIDGES**

**I. DESCRIPTION.** Perform all work in accordance with the Kentucky Transportation Cabinet, Department of Highway's Standard Specification for Road and Bridge Construction and applicable Supplemental Specifications, the Standard Drawings (current editions), this note, and the attached detail drawings. This work consists of the following: (1) Furnish all labor, materials, tools, and equipment; (2) Remove existing concrete and expansion device(s) and/or bridge ends; (3) Install armored edges and new concrete as specified and in accordance with the attached detail drawings; (4) Install new joint seals (where required); (5) Maintain and control traffic; and (6) Any other work specified as part of this contract.

### **II. MATERIALS.**

- A. Class "M" Concrete.** Use either "M1" or "M2". See Section 601.
- B. Structural Steel.** Use new, commercial grade steel suitable for welding. The Engineer will base acceptance on visual inspection. For armored edges that make up the 4" neoprene joint, use Steelflex Strip Seal expansion joint by DS Brown, or approved equal. To be approved, armored edge extrusions must be embedded.
- C. Stud Anchors.** The armored edge stud anchors are ¾" embedded stud shear connectors conforming to ASTM A108, Grade 1015 (Nelson Studs or equal).
- D. Steel Reinforcement.** Use Grade 60. See Section 602.
- E. Epoxy Bond Coat.** See Section 511.
- F. Neoprene Strip Seals.** See attached detail drawings and Section 807.

### **III. EQUIPMENT.**

- A. Hammers.** See Section 606.02.10 B.
- B. Sawing Equipment.** See Section 606.02.10 C.
- C. Hydraulic Impact Equipment.** See Section 606.02.10 D.

### **IV. CONSTRUCTION.**

- A. Remove Existing Materials.** Remove existing Expansion Dam, Bridge End, Armored Edges and specified areas of concrete as shown on the attached sketches. Remove debris and/or expansion joint filler as directed by the Engineer. Clean and leave all existing steel reinforcement encountered in place. Damaged steel reinforcement will be repaired/replaced as directed by the Engineer at no additional cost to the Department.  
Dispose of all removed material entirely away from the job site. This work is incidental to the contract unit price for "Expansion Joint Replacement" or "Armored Edge for Concrete".
- B. Place New Concrete and Armored Edges.** After all specified existing materials have been removed; place new armored edges to match the grade of the proposed overlay or to match the original grade (See attached detail drawings). Place the new Class "M" concrete to the scarified grade and finish to receive the new overlay or place the new Class "M" concrete to the original grade and finish with broom strokes drawn transversely from curb to curb.



New Class "M" concrete will be needed to rebuild curbs after removal of existing joint.

All new structural steel shall be cleaned and painted in accordance with requirements of Section 607.03.23, except that surfaces to come in contact with concrete are not to be painted.

Blast clean all areas of existing concrete and structural steel to come in contact with new concrete until free of all laitance and deleterious substances immediately prior to the placement of the Class "M" Concrete. The surface areas of existing concrete to come in contact with the new Class "M" Concrete are to be coated with an epoxy bond coat immediately prior to placing new concrete in accordance with Section 511. The interfaces of the new and old concrete shall be as nearly vertical and horizontal as possible.

- C. Additional Steel Reinforcement.** Furnish for replacement, as directed by the Engineer, 1300 linear feet (Bridge 114B00055) of #5 steel reinforcing bars in 40' lengths. Place these bars in areas deemed by the Engineer to require additional reinforcement. Field cutting and bending is permitted. Do not place any additional steel reinforcement above the height of the top row of Nelson Studs on the armored edges. Ensure that all exposed steel reinforcement is tied in accordance with Section 602.03.04 prior to pouring the new Class "M" concrete. Deliver unused bars to the Local County Maintenance Barn. Payment will be made in accordance with Section 602.
  - D. Stage Construction.** Installation of concrete and armored edges in two (or more if specified) stages is necessary. Join the armored edges at or near the centerline of the roadway or lane line, field weld and grind smooth.
  - E. Preformed Neoprene Strip Seal.** Place the preformed joint seal in one continuous, unbroken length. Place neoprene strip seals as recommended by the manufacturer and in accordance with Section 609.03.04
  - F. Shop Plans.** Shop plans will not be required. The Contractor is responsible for obtaining field measurements and supplying properly sized materials to complete the work.
  - G. Verifying Field Conditions.** The Contractor shall field verify all existing dimensions before ordering any material. New material that is unsuitable due to variation in existing structure shall be replaced at the Contractors expense.
  - H. Damage to the Structure.** The Contractor shall bear all responsibility and expense for any and all damage to the structure during the repair work even to removal and replacement of a fallen span, should the fallen span result from the Contractor's actions.
  - I. Residual lead paint may still be on bridge.** The Contractor is advised to take all necessary protective measures including worker safety and environmental regulations when performing surface preparation and other work. The Department will not consider any claims based on residual lead paint.
- V. MEASUREMENT.**
- A. Expansion Joint Replacement – 4".** The Department will measure the quantity in linear feet from gutterline to gutterline along the centerline of the joint.
  - B. Armored Edge for Concrete.** The Department will measure the quantity in linear feet from gutterline to gutterline along the face of the bridge end.

**C. Steel Reinforcement.** See Section 602.

**VI. PAYMENT.**

**A. Expansion Joint Replacement –4".** Payment at the contract unit price per linear foot is full compensation for removing specified existing materials, furnishing and installing the new armored edges, concrete, neoprene strip seal or pre-compressed horizontal expansion joint system, and all incidental items necessary to complete the work (except the overlay material) within the specified pay limits as specified by this note and as shown on the attached detail drawings.

**B. Armored Edge for Concrete.** Payment at the contract unit price per linear foot is full compensation for removing specified existing materials, furnishing and installing the new armored edges, concrete and all incidental items necessary to complete the work (except the overlay material) within the specified pay limits as specified by this note and as shown on the attached detail drawings.

**C. Steel Reinforcement.** See Section 602.

**SPECIAL NOTE FOR CONCRETE SEALING**

These Notes or designated portions thereof, apply where so indicated on the plans, proposals or bidding instruction.

**I. DESCRIPTION.** Perform all work in accordance with the Department's 2019 Standard Specifications, and applicable Supplemental Specifications, the attached sketches, and these Notes. Section references are to the Standard Specifications. This work consists of: (1) Furnish all labor, materials, tools, and equipment; (2) Clean the bridge deck; (3) Seal the bridge deck; (4) Maintain & control traffic; and, (5) Any other work specified as part of this contract.

**II. MATERIALS.**

**D. Sealer.** Use one of the following:

Product	Supplier
Protectosil BHN	Evonik Industries
Protectosil 300S	Evonik Industries
TK-590-40 Tri-Silane 40%	TK Products
SW-244-100	Chemical Products Industries, Inc.
TK-590-1 MS Tri-Silane	TK Products
MasterProtect H1000	BASF
Aquanil Plus 40	ChemMasters
SIL-ACT ATS-100	Advanced Chemical Technologies
Certivex Penseal BTS 100%	Vexcon
Pentreat 244-40	W.R. Meadows
Aquanil Plus 40A	ChemMasters

- E. Coverage Rate:** Follow all manufacturers recommendations for coverage rates except the application rate must not exceed the square footage coverage rate per gallon of sealer as given in the chart below. If the manufacturer recommends a coverage rate greater than given in the table below, apply sealer at the rate given in the table below for the chosen sealers silane percentage.

% Silane	Coverage rate (ft <sup>2</sup> /gallon)
100	300
40	120
20	60

**III. CONSTRUCTION.**

- A. Curing Compound.** Contrary to Section 609.03.12 of the specifications, curing compound is not to be used on this deck due to potentially causing issues with the concrete sealer. During the deck pour, finishing, and tining operations the Class AA concrete shall be kept continuously moist with the use of a mister until burlap or curing blankets are applied to the surface. At no point should water be pooling or running off the surface or the surface of the concrete be allowed to become dry. After the burlap or curing blankets are installed, cure in accordance with the specifications. Include all costs in the unit price bid for Class AA concrete. Failure to properly cure the concrete in accordance with this note and the specifications may result in weakened or cracked concrete. If the concrete is weakened or cracked due to improper curing, the contractor will be responsible for providing alternates to fix the issues to the Engineer for review and the contractor will be solely responsible for all costs to do so, up to complete replacement. Do not begin any construction on fixing any issues without approval of the Engineer.
- B. Cleaning the Deck.** Dry clean the deck to remove all loose debris. Remove all visible hydrocarbons from the surface with detergent approved by the manufacturer of the deck sealant. Pressure wash all surfaces to be sealed at 2000 to 3000 psi. Install pressure gauges at each wand to verify pressure. Use 30° fan tip or as recommended by the manufacturer of the deck sealant. Hold pressure washing wand a minimum of 45° from the deck with a maximum stand-off distance of 12 inches.
- C. Sealing the Deck.** Allow new concrete to cure a minimum 28 days prior to application of sealer. Monitor weather conditions prior to sealer application. Refer to manufacturer’s recommendations for proper ambient conditions. Do not apply sealer if precipitation is anticipated within the time stated by the manufacturer. Allow the deck to dry 24 hours (after washing or rain event) before sealer application. The deck can be reopened to traffic while drying. Sealer must be applied within 48 hours of washing or the deck must be rewashed. Divide the deck into predefined areas of specific square footage to aid in determining usage.

Comply with manufacturer's usage recommendation. Using a low pressure pump, apply sealer and spread evenly with broom or squeegee; do not allow pooling to remain. When each predefined area is complete, measure the amount of sealer used to verify proper usage. After sealing, follow manufacturer's recommended cure time before opening to traffic. On vertical surfaces, apply the sealer in a flooding application from the bottom up, so the material runs down 6 to 8 inches below the spray pattern.

**D. Inspection:** Monitor all aspects of the project to assure compliance to this specification. Observe and document general conditions during the entirety of the project. Verify that each phase of work has been satisfactorily completed prior to beginning the next phase. Phases are described as follows:

1. Dry cleaning to remove loose debris, verify and document:
  - a. All debris has been removed and disposed of properly.
2. Removal of hydrocarbons, verify and document:
  - a. The manufacturer's recommended detergent is used for removal.
  - b. Hydrocarbons have been satisfactorily removed.
3. Pressure washing, verify and document:
  - a. Washing pressure at the wand.
  - b. Tip size used.
  - c. Wash angle and stand-off distance.
  - d. The deck is satisfactorily cleaned.
4. Sealer application, verify and document:
  - a. Proper cure time for new concrete.
  - b. Deck surface is dry.
    1. Document time since washed.
    2. Was deck opened to traffic after washing?
  - c. Ambient conditions.
    1. Document ambient temperature, surface temperature, relative humidity, and dew point.
  - d. Application and distribution method.
  - e. Coverage to be complete and even.
  - f. Material is not allowed to remain pooled.
  - g. Monitor material usage.
  - h. No traffic until proper cure time is allowed.

#### **IV. MEASUREMENT**

- A. Concrete Sealing.** The Department will measure the quantity per square feet of each area sealed.

#### **V. PAYMENT**

- A. Concrete Sealing.** Payment at the contract unit price per square feet is full compensation for the following: (1) Furnish all labor, materials, tools, and equipment; (2) Clean the bridge deck; (3) Seal the bridge deck; (4) Maintain & control traffic; and, (5) Any other work specified as part of this contract.

## SPECIAL NOTE FOR INLAID PAVEMENT MARKERS

---

### I. DESCRIPTION

Except as provided herein, perform all work in accordance with the Department's Standard and Supplemental Specifications and applicable Standard and Sepia Drawings, current editions. Article references are to the Standard Specifications. This work shall consist of:

- (1) Maintain and Control Traffic; and (2) Furnish and install Inlaid Pavement Markers (IPMs) in recessed grooves; and (3) Any other work as specified by these notes and the Contract.

### II. MATERIALS

The Department will sample all materials in accordance with the Department's Sampling Manual. Make the materials available for sampling a sufficient time in advance of the use of the materials to allow for the necessary time for testing unless otherwise specified in these Notes.

- A. Maintain and Control Traffic.** See the Traffic Control Plan.
- B. Markers.** Provide reflective lenses with depth control breakaway positioning tabs. Before furnishing the markers, provide to the Engineer the manufacturer's current recommendations for adhesives and installation procedures. Use one brand and design throughout the project. Use markers meeting the specifications in the table below.

<b>SPECIFICATIONS FOR HOUSING AND REFLECTOR</b>	
Material:	Polycarbonate Plastic
Weight:	Housing 2.00 oz.
	Reflector 2.00oz.
Housing Size:	5.00" x 3.00" x 0.70" high
Specific Intensity of Reflectivity at 0.2° Observation Angle	
White:	3.0 at 0°entrance angle
	1.2 at 20°entrance angle
Yellow:	60% of white values
Red:	25% of white values

- C. Adhesives.** Use adhesives that conform to the manufacturer's recommendations.

Inlaid Pavement Markers  
Page 2 of 4

**III. CONSTRUCTION**

- A. Experimental Evaluation.** The University of Kentucky Transportation Center will be evaluating this installation of IPMs. Notify the Engineer a minimum of 14 calendar days prior to beginning work. The Engineer will coordinate the University's activities with the Contractor's work.
- B. Maintain and Control Traffic.** See the Traffic Control Plan.
- C. Installation.** Install IPMs in recessed grooves cut into the final course of asphalt pavement according to the manufacturer's recommendations. Do not cut the grooves until the pavement has cured sufficiently to prevent tearing or raveling. Cut installation grooves using diamond blades on saws that accurately control groove dimensions. Remove all dirt, grease, oil, loose or unsound layers, and any other material from the marker area which would reduce the bond of the adhesive. Maintain pavement surfaces in a clean condition until placing markers.

Prepare the pavement surfaces, and install the markers in the recessed groove according to the drawing below. Use an approved snowplowable epoxy adhesive. Ensure that the adhesive bed area is equal to the bottom area of the marker, and apply adhesive in sufficient quantity to force excess out around the entire perimeter of the marker. Use materials, equipment, and construction procedures that ensure proper adhesion of the markers to the pavement surface according to the manufacturer's recommendations. Remove all excess adhesive from in front of the reflective faces. If any adhesive or foreign matter cannot be removed from the reflective faces, or if any marker fails to properly adhere to the pavement surface, remove and replace the marker at no additional cost to the Department.

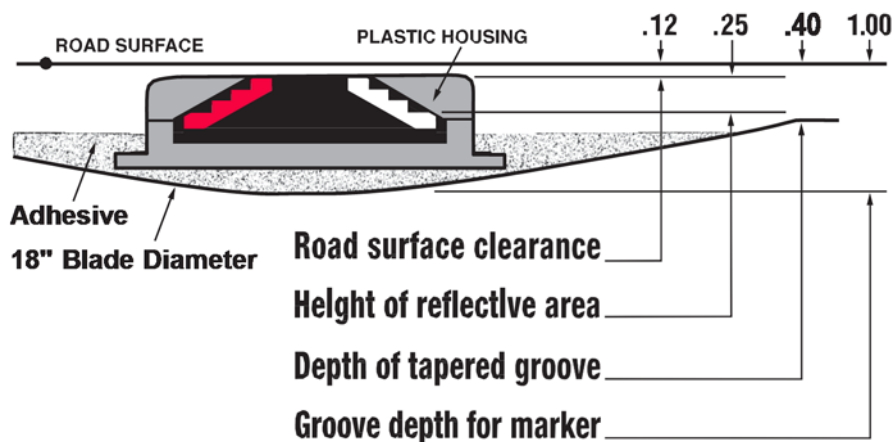

- D. Location and Spacing.** Install the markers in the pattern for high reflectivity with two (2) IPMs per groove. Locate and space markers as shown in the current Standard Drawings or Sepias. (Note: use Inlaid Pavement Markers wherever Type V Pavement

Inlaid Pavement Markers  
Page 3 of 4

Markers are called for.) Do not install markers on bridge decks. Do not install a marker on top of a pavement joint or crack. Offset the recessed groove a minimum of 2 inches from any longitudinal pavement joint or crack and at least one inch from the painted stripe, ensuring that the finished line of markers is straight with minimal lateral deviation. Give preference to maintaining the 2-inch offset between recessed groove and joint as opposed to keeping the line of markers straight.

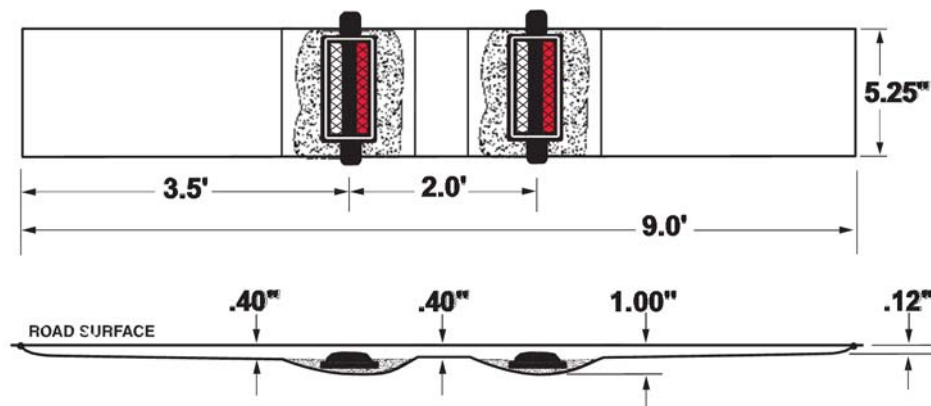

Place inlaid markers as much in line with existing pavement striping as possible. Place markers installed along an edge line or channelizing line so that the near edge of the plastic housing is no more than one inch from the near edge of the line. Place markers installed along a lane line between and in line with the dashes. Do not place markers over the lines except where the lines deviate visibly from their correct alignment, and then only after obtaining the Engineer's prior approval of the location.

If conflicts between recessed groove placement in relation to pavement joint and striping cannot be resolved, obtain the Engineer's approval to eliminate the marker or revise the alignment.

- E. Disposal of Waste.** Dispose of all removed asphalt pavement, debris, and other waste at sites off the right of way obtained by the Contractor at no additional cost to the Department. See the Special Provision for Waste and Borrow Sites.
- F. Restoration.** Be responsible for all damage to public and/or private property resulting from the work. Restore all damaged features in like kind materials and design at no additional cost to the Department.
- G. On-Site Inspection.** Make a thorough inspection of the site prior to submitting a bid and be thoroughly familiar with existing conditions so that the work can be expeditiously performed after a contract is awarded. The Department will consider submission of a bid as evidence of this inspection having been made and will not honor any claims for money or grant Contract time extensions resulting from site conditions.



Inlaid Pavement Markers  
Page 4 of 4

- H. Caution.** Do not take information shown on the drawings and in this proposal and the types and quantities of work listed as an accurate or complete evaluation of the material and conditions to be encountered during construction, but consider the types and quantities of work listed as approximate only. The bidder must draw his or her own conclusion as to the conditions encountered. The Department does not give any guarantee as to the accuracy of the data and no claim will be considered for additional compensation or extension of Contract time if the conditions encountered are not in accordance with the information shown.

**IV. MEASUREMENT**

- A. Maintain and Control Traffic.** See the Traffic Control Plan.
- B. Inlaid Pavement Markers.** The Department shall measure as Each. One (1) installation of "INLAID PAVEMENT MARKER" will consist of grooving the pavement, removing asphalt cuttings and debris, preheating pavement to remove moisture, adhesives, and installation of two (2) markers with all lenses in accordance with this note.

**Note: Each pay item of Inlaid Pavement Marker will require two markers.**

**V. PAYMENT**

- A. Maintain and Control Traffic.** See the Traffic Control Plan.
- B. Inlaid Pavement Markers.** The Department will make payment for the completed and accepted quantities of completely installed "INLAID PAVEMENT MARKERS" at the Contract unit price, Each. Accept payment as full compensation for all labor, equipment, materials, and incidentals necessary to accomplish this work to the satisfaction of the Engineer. A system of one (1) groove and two (2) markers shall be paid as one "INLAID PAVEMENT MARKER". The bid item "INLAID PAVEMENT MARKER" shall be used regardless of the color and type of lenses required.

**SPECIAL NOTE FOR NON-TRACKING TACK COAT**

1. DESCRIPTION AND USEAGE. This specification covers the requirements and practices for applying a non-tracking tack asphalt coating. Place this material on the existing pavement course, prior to placement of a new asphalt pavement layer. Use when expedited paving is necessary or when asphalt tracking would negatively impact the surrounding area. This material is not suitable for other uses. Ensure material can “break” within 15 minutes under conditions listed in 3.2.

2. MATERIALS, EQUIPMENT, AND PERSONNEL.

2.1 Non-Tracking Tack. Provide material conforming to Subsection 2.1.1.

2.1.1 Provide a tack conforming to the following material requirements:

Property	Specification	Test Procedure
Viscosity, SFS, 77 ° F	20 – 100	AASHTO T 72
Sieve, %	0.3 max.	AASHTO T 59
Asphalt Residue <sup>1</sup> , %	50 min.	AASHTO T 59
Oil Distillate, %	1.0 max.	AASHTO T 59
Residue Penetration, 77 ° F	20 max.	AASHTO T 49
Original Dynamic Shear (G*/sin δ), 82 ° C	1.0 min.	AASHTO T 315
Softening Point, ° F	149 min.	AASHTO T 53
Solubility, %	97.5 min.	AASHTO T 44

<sup>1</sup> Bring sample to 212 °F over a 10-15 minute period. Maintain 212 °F for 15-20 minutes or until 30-40 mL of water has distilled. Continue distillation as specified in T59.

2.2. Equipment. Provide a distributor truck capable of heating, circulating, and spraying the tack between 170 °F and 180 °F. Do not exceed 180 °F. Circulate the material while heating. As required by the manufacturer, ensure the spray bar is equipped with #1 or #2 ¼” V-slot Etnyre nozzles. Other nozzles are not acceptable. Arrange the nozzles in the following patterns from left to right:

Nozzle number(s)	Activity	Orientation
1	On	Vertical
2	Off	-
3	On	Horizontal
4 & 5	Off	-
6	On	Horizontal
Continue 2 off and 1 on pattern through rest of spray bar system.		

Ensure the bar can be raised to between 14 and 18” from the roadway.

2.3 Personnel. Ensure the tack supplier has provided training to the contractor on the installation procedures for this product. Make a technical representative from the supplier available at the request of the Engineer.

3. CONSTRUCTION.

3.1 Surface Preparation. Prior to the application of the non-tracking tack, ensure the pavement surface is thoroughly dry and free from dust or any other debris that would inhibit adhesion. Clean the surface by scraping, sweeping, and the use of compressed air. Ensure this preparation process occurs shortly before application to prevent the return of debris pavement. If rain is expected within one hour after application, do not apply material. Apply material only when the surface is dry, and no precipitation is expected.

3.2 Non-tracking Tack Application. Ensure the roadway temperature is a minimum of 40 °F and rising during the application of the tack. This material is not suitable for use in colder temperatures. Prior to applying the tack, demonstrate competence in applying the tack according to this note to the satisfaction of the Engineer. Heat the tack in the distributor to between 170 – 180 °F. After initial heating to between 170 – 180 °F, the material may be sprayed between 165 °F and 180 °F. Do not apply outside this temperature range. Apply material at a rate of 0.50 pounds (0.06 gallons) per square yard. Ensure full coverage of the material on the pavement surface. Full coverage of this material is critical. If full coverage is not achieved, material application rate may be increased to ensure full coverage. Do not heat material more than twice in one day.

3.3 Non-tracking Tack Certification. Furnish the tacks certification to the Engineer stating the material conforms to all requirements herein prior to use.

3.4 Sampling and Testing. The Department will require a sample of non-tracking tack be taken from the distributor at a rate of one sample per 15,000 tons of mix. Take two 1 gallon samples of the heated material and forward the sample to the Division of Materials for testing within 7 days. Ensure the product temperature is between 170 and 180 °F at the time of sampling.

4. MEASUREMENT. The Department will measure the quantity of non-tracking tack in tons. The Department will not measure for payment any extra materials, labor, methods, equipment, or construction techniques used to satisfy the requirements of this note. The Department will not measure for payment any trial applications of non-tracking tack, the cleaning of the pavement surface, or furnishing and placing the adhesive. The Department will consider all such items incidental to the non-tracking tack.

5. PAYMENT. The Department will pay for the non-tracking tack at the Contract unit bid price and apply an adjustment for each manufacturer's lot of material based on the degree of compliance as defined in the following schedule. When a sample fails on two or more tests, the Department may add the deductions, but the total deduction will not exceed 100 percent.

Non-Tracking Tack Price Adjustment Schedule						
Test	Specification	100% Pay	90% Pay	80% Pay	50% Pay	0% Pay
Viscosity, SFS, 77 ° F	20 – 100	19 - 102	17 - 18	15 - 16	14	≤13
			103 - 105	106 - 107	108 - 109	≥ 110
Sieve, %	0.30 max.	≤ 0.40	0.41 - 0.50	0.51 - 0.60	0.61 - 0.70	≥ 0.71
Asphalt Residue, %	50 min.	≥49.0	48.5 – 48.9	48.0 – 48.4	47.5-47.9	≤ 47.4
Oil Distillate, %	1.0 max.	≤1.0	1.1-1.5	1.6 - 1.7	1.8-1.9	>2.0
Residue Penetration, 77 ° F	20 max.	≤ 21	22 - 23	24 - 25	26 - 27	≥ 28
Original Dynamic Shear (G*/sin δ), 82 ° C	1.0 min.	≥0.95	0.92 – 0.94	0.90 – 0.91	0.85 - 0.89	≤ 0.84
Softening Point, ° F	149 min.	≥145	142 - 144	140 - 141	138 - 139	≤ 137
Solubility, %	97.5 min.	≥ 97.0	96.8 – 96.9	96.6 – 96.7	96.4 – 96.5	≤ 96.3

<u>Code</u>	<u>Pay Item</u>	<u>Pay Unit</u>
24970EC	Asphalt Material for Tack Non-Tracking	Ton

April 30, 2018

***SPECIAL NOTE***

**For Tree Removal**

**Butler County**

**I-65 SPUR CORRIDOR: IMPROVE THE NATCHER PARKWAY/US-  
231 INTERCHANGE (EXIT 9) ON THE WEST SIDE OF BOWLING  
GREEN**

**Item No. 3-2042.20**

NO CLEARING OF TREES 5 INCHES OR GREATER (DIAMETER BREST  
HEIGHT) FROM JUNE 1- JULY 31

**If there are any questions regarding this note, please contact Danny Peake, Director,  
Division of Environmental Analysis, 200 Mero Street, Frankfort, KY 40601, Phone:  
(502) 564-7250.**

### **SPECIAL NOTE FOR CONCRETE SLURRY**

If diamond grinding, grooving or any other process which produces slurry is required on roadways or bridges, the contractor shall ensure that all concrete slurry associated with these processes is collected, managed, and disposed of appropriately. The waste material shall be disposed of at a permitted disposal facility, in accordance with the Kentucky Standard Specifications for Road and Bridge Construction and the Environmental Performance Standards outlined in 401 KAR 47:030, or managed as a material for beneficial reuse. Any fines or remediation related to improper disposal shall be the sole responsibility of the contractor.

Disposal of concrete slurry will not be paid separately and shall be considered incidental to other bid items.

8/20/2019

### **Special Note for Bridge Demolition, Renovation and Asbestos Abatement**

**If the project includes any bridge demolition or renovation, the successful bidder is required to notify Kentucky Division for Air Quality (KDAQ) via filing of form (DEP 7036) a minimum of 10 working days prior to commencement of any bridge demolition or renovation work.**

**Any available information regarding possible asbestos containing materials (ACM) on or within bridges to be affected by the project has been included in the bid documents. These are to be included with the Contractor's notification filed with the KDAQ. If not included in the bid documents, the Department will provide that information to the successful bidder for inclusion in the KDAQ notice as soon as possible. If there are no documents stating otherwise, the bidders should assume there are no asbestos containing materials that will in any way affect the work.**



**Matthew G. Bevin**  
Governor

**COMMONWEALTH OF KENTUCKY**  
**TRANSPORTATION CABINET**  
Frankfort, Kentucky 40622  
[www.transportation.ky.gov/](http://www.transportation.ky.gov/)

**Greg Thomas**  
Secretary

## **Asbestos Inspection Report**

To: Steve Bohon

District: Central Office

Date: November 14, 2016

Conducted By: O'Dail Lawson

Report Prepared By: O'Dail Lawson

---

### **Project and Structure Identification**

Project Number: Warren County

Structure ID: 114B00055N

Structure Location: US 231 over Natcher Parkway

Sample Description: The samples collected were negative for asbestos.

Inspection Date: October 25, 2016

### **Results and Recommendations**

The results of the samples collected were negative for the presence of asbestos above 1%. No abatement is required at this time.

It is recommended that this report accompany the 10-Day Notice of Intent for Demolition ([DEP7036 Form](#)) which is to be submitted to the Kentucky Division of Air Quality prior to abatement, demolition, or renovation of any building or structure in the Commonwealth.









# Chain of Custody Record

Kentucky Transportation Cabinet

200 Mero Street, 5th Floor West  
Frankfort, Kentucky 40622  
(502) 564-7250 fax (502) 564-5655

US 231 over Narbera Parkway

O'Dail Lawson [odail.lawson@ky.gov](mailto:odail.lawson@ky.gov)  
KYTC  
Address: 200 Mero Street  
Frankfort KY  
Phone: 502-564-7250 Fax: 502-564-5655  
PO#:

Client Information KY TRANS CABINET  
Results Code:  
NID = None Detected  
FTD = Filter Tampering or Damaged  
N/A = Not Applicable

Samplers (signature):

Project or Subject Reference (W) Area 114B 00055 W

*[Signature]*

Sample ID	Sample Description	Collected		Analysis Requested	Cont. Type	Preservative
		Date	Time			
W55-1	Guano Rail Mark	10/26/16	13:15	Asbestos bulk	Good	N/A
W55-2	Joint Compound	↓	↓	↓	Good	N/A

Relinquished By: \_\_\_\_\_ Date/Time: \_\_\_\_\_

Received By: *Winters* Date/Time: *11/04/16*

Relinquished By: \_\_\_\_\_ Date/Time: \_\_\_\_\_

Received at Lab By: \_\_\_\_\_ Date/Time: \_\_\_\_\_

**ENVIRONMENTAL TRAINING CONCEPTS, INC**  
P.O. Box 99603 Louisville, KY 40269  
(502)640-2951

Certification Number: ETC-AIR-071116-00630

**O'Dail Lawson**

has on 07-11-2016, attended and successfully completed the requirements and passed the examination with a score of 70% of better on the entitled course.

**ASBESTOS INSPECTOR REFRESHER**

Training was in accordance with 40 CFR Part 763 (AHERA) approved by the Commonwealth of Kentucky, the Indiana Department of Environmental Management and Tennessee Department of Environment & Conservation. The above student received requisite training for Asbestos Accreditation under Title II of the Toxic Substance Act (TSCA).

Conducted at: 1301 Kentucky Mills Drive, Louisville, KY

  
Name - Training Manager

Expiration Date: 07-11-2017  
  
Name - Instructor



	KENTUCKY TRANSPORTATION CABINET Department of Highways DIVISION OF RIGHT OF WAY & UTILITIES	TC 62-226 Rev. 01/2016 Page 1 of 1
<b>RIGHT OF WAY CERTIFICATION</b>		

<input checked="" type="checkbox"/> Original	<input type="checkbox"/> Re-Certification	<b>RIGHT OF WAY CERTIFICATION</b>	
ITEM #	COUNTY	PROJECT # (STATE)	PROJECT # (FEDERAL)
03-2042.20.00	Warren	12FO FD52 114 9241901R	NHPP-31(013)

**PROJECT DESCRIPTION**

I-65 Spur Corridor

**No Additional Right of Way Required**

Construction will be within the limits of the existing right of way. The right of way was acquired in accordance to FHWA regulations under the Uniform Relocation Assistance and Real Property Acquisitions Policy Act of 1970, as amended. No additional right of way or relocation assistance were required for this project.

**Condition # 1 (Additional Right of Way Required and Cleared)**

All necessary right of way, including control of access rights when applicable, have been acquired including legal and physical possession. Trial or appeal of cases may be pending in court but legal possession has been obtained. There may be some improvements remaining on the right-of-way, but all occupants have vacated the lands and improvements, and KYTC has physical possession and the rights to remove, salvage, or demolish all improvements and enter on all land. Just Compensation has been paid or deposited with the court. All relocations have been relocated to decent, safe, and sanitary housing or that KYTC has made available to displaced persons adequate replacement housing in accordance with the provisions of the current FHWA directive.

**Condition # 2 (Additional Right of Way Required with Exception)**

The right of way has not been fully acquired, the right to occupy and to use all rights-of-way required for the proper execution of the project has been acquired. Some parcels may be pending in court and on other parcels full legal possession has not been obtained, but right of entry has been obtained, the occupants of all lands and improvements have vacated, and KYTC has physical possession and right to remove, salvage, or demolish all improvements. Just Compensation has been paid or deposited with the court for most parcels. Just Compensation for all pending parcels will be paid or deposited with the court prior to AWARD of construction contract

**Condition # 3 (Additional Right of Way Required with Exception)**

The acquisition or right of occupancy and use of a few remaining parcels are not complete and/or some parcels still have occupants. All remaining occupants have had replacement housing made available to them in accordance with 49 CFR 24.204. KYTC is hereby requesting authorization to advertise this project for bids and to proceed with bid letting even though the necessary right of way will not be fully acquired, and/or some occupants will not be relocated, and/or the just compensation will not be paid or deposited with the court for some parcels until after bid letting. KYTC will fully meet all the requirements outlined in 23 CFR 635.309(c)(3) and 49 CFR 24.102(j) and will expedite completion of all acquisitions, relocations, and full payments after bid letting and prior to AWARD of the construction contract or force account construction.

Total Number of Parcels on Project	-1-	EXCEPTION (S) Parcel #	ANTICIPATED DATE OF POSSESSION WITH EXPLANATION
Number of Parcels That Have Been Acquired			
Signed Deed	-1-		
Condemnation	-0-		
Signed ROE	-0-		

Notes/ Comments (Use Additional Sheet if necessary)

<b>LPA RW Project Manager</b>		<b>Right of Way Supervisor</b>	
Printed Name		Printed Name	Allen Arnold
Signature		Signature	allen arnold <small>Digitally signed by allen arnold Date: 2020.01.30 10:55:07 -0500</small>
Date		Date	01/30/2020
<b>Right of Way Director</b>		<b>RIGHT-OF-WAY</b>	
Printed Name	Kelly Divine	Printed Name	ACCEPTABLE FOR
Signature	 2020.01.30 10:35:09 -06'00'	Signature	P.S.&E APPROVAL
Date	01/30/2020	Date	

**1-20-20**  
 Date \_\_\_\_\_  
  
 Realty Officer

## UTILITIES AND RAIL CERTIFICATION NOTE

Warren County  
ONHPP0031014  
FD52 114 9241901U  
Mile point: TO  
**I-65 SPUR CORRIDOR: IMPROVE THE NATCHER PARKWAY/US-231 INTERCHANGE (EXIT 9) ON THE WEST SIDE OF BOWLING GREEN. (SEE ITEM NO. 3-202 FOR DESIGN) (2016BOP)**  
**ITEM NUMBER: 03-2042.20**

### PROJECT NOTES ON UTILITIES

For all projects under 2000 Linear feet which require a normal excavation locate request pursuant to KRS 367.4901-4917, the awarded contractor shall field mark the proposed excavation or construction boundaries of the project (also called white lining) using the procedure set forth in KRS 367.4909(9)(k). For all projects over 2000 linear feet, which are defined as a "Large Project" in KRS 367.4903(18), the awarded contractor shall initially mark the first 2000 linear feet minimally of proposed excavation or construction boundaries of the project to be worked using the procedure set forth in KRS 367.4909(9)(k). This temporary field locating of the project excavation boundary shall take place prior to submitting an excavation location request to the underground utility protection Kentucky Contact Center. For large projects, the awarded contractor shall work with the impacted utilities to determine when additional white lining of the remainder of the project site will take place. This provision shall not alter or relieve the awarded contractor from complying with requirements of KRS 367.4905 to 367.4917 in their entirety.

Please Note: The information presented in this Utility Note is informational in nature and the information contained herein is not guaranteed.

The contractor will be responsible for contacting all utility facility owners on the subject project to coordinate his activities. The contractor will coordinate his activities to minimize and, where possible, avoid conflicts with utility facilities. Due to the nature of the work proposed, it is unlikely to conflict with the existing utilities beyond minor facility adjustments. Where conflicts with utility facilities are unavoidable, the contractor will coordinate any necessary relocation work with the facility owner and Resident Engineer. The Kentucky Transportation Cabinet maintains the right to remove or alter portions of this contract if a utility conflict occurs. The utility facilities as noted in the previous section(s) have been determined using data garnered by varied means and with varying degrees of accuracy: from the facility owners, a result of S.U.E., field inspections, and/or reviews of record drawings. The facilities defined may not be inclusive of all utilities in the project scope and are not Level A quality, unless specified as such. It is the contractor's responsibility to verify all utilities and their respective locations before excavating.

## UTILITIES AND RAIL CERTIFICATION NOTE

**Warren County  
ONHPP0031014  
FD52 114 9241901U  
Mile point: TO  
I-65 SPUR CORRIDOR: IMPROVE THE NATCHER PARKWAY/US-231 INTERCHANGE (EXIT 9) ON THE  
WEST SIDE OF BOWLING GREEN. (SEE ITEM NO. 3-202 FOR DESIGN) (2016BOP)  
ITEM NUMBER: 03-2042.20**

The contractor shall make every effort to protect underground facilities from damage as prescribed in the Underground Facility Damage Protection Act of 1994, Kentucky Revised Statute KRS 367.4901 to 367.4917. It is the contractor's responsibility to determine and take steps necessary to be in compliance with federal and state damage prevention directives. The contractor is instructed to contact KY 811 for the location of existing underground utilities. Contact shall be made a minimum of two (2) and no more than ten (10) business days prior to excavation. The contractor shall submit Excavation Locate Requests to the Kentucky Contact Center (KY 811) via web ticket entry. The submission of this request does not relieve the contractor from the responsibility of contacting non-member facility owners, whom are to be contacted through their individual Protection Notification Center. It may be necessary for the contractor to contact the County Court Clerk to determine what utility companies have facilities in the area. Non-compliance with these directives can result in the enforcement of penalties.

## UTILITIES AND RAIL CERTIFICATION NOTE

<p>Warren County ONHPP0031014 FD52 114 9241901U Mile point: TO I-65 SPUR CORRIDOR: IMPROVE THE NATCHER PARKWAY/US-231 INTERCHANGE (EXIT 9) ON THE WEST SIDE OF BOWLING GREEN. (SEE ITEM NO. 3-202 FOR DESIGN) (2016BOP) ITEM NUMBER: 03-2042.20</p>
---

**NOTE: DO NOT DISTURB THE FOLLOWING FACILITIES LOCATED WITHIN THE PROJECT DISTURB LIMITS**

Warren Rural Electric Cooperative Corporation - Electric

AT&T - KY - Telephone

Warren County Water District - Water

**\*The Contractor is fully responsible for protection of all utilities listed above\***

**THE FOLLOWING FACILITY OWNERS ARE RELOCATING/ADJUSTING THEIR FACILITIES WITHIN THE PROJECT LIMITS AND WILL BE COMPLETE PRIOR TO CONSTRUCTION**

Not Applicable

**THE FOLLOWING FACILITY OWNERS HAVE FACILITIES TO BE RELOCATED/ADJUSTED BY THE OWNER OR THEIR SUBCONTRACTOR AND IS TO BE COORDINATED WITH THE ROAD CONTRACT**

Not Applicable

**THE FOLLOWING FACILITY OWNERS HAVE FACILITIES TO BE RELOCATED/ADJUSTED BY THE ROAD CONTRACTOR AS INCLUDED IN THIS CONTRACT**

Bowling Green Municipal Utilities – Sewer

**RAIL COMPANIES HAVE FACILITIES IN CONJUNCTION WITH THIS PROJECT AS NOTED**

No Rail Involvement    Rail Involved    Rail Adjacent

## UTILITIES AND RAIL CERTIFICATION NOTE

**Warren County**  
**ONHPP0031014**  
**FD52 114 9241901U**  
**Mile point: TO**  
**I-65 SPUR CORRIDOR: IMPROVE THE NATCHER PARKWAY/US-231 INTERCHANGE (EXIT 9) ON THE**  
**WEST SIDE OF BOWLING GREEN. (SEE ITEM NO. 3-202 FOR DESIGN) (2016BOP)**  
**ITEM NUMBER: 03-2042.20**

### AREA FACILITY OWNER CONTACT LIST

Facility Owner	Address	Contact Name	Phone	Email
Warren Rural Electric Cooperative Corporation - Electric	P.O. Box 1118 Bowling Green KY 42102	Jonathan Lindsey	270-842-6541	jonathanl@wrecc.com
AT&T - KY - Telephone	1150 State Street Bowling Green KY 42101	Travis Parsley	270-846-3196	tp2087@att.com
Warren County Water District	523 Highway US-31W By-pass, P.O Box 10180 Bowling Green KY 42102	Ryan Leisey	270-842-0052	ryanl@warrenwater.com
Bowling Green Municipal Utilities - Sewer	P.O. Box 10300 Bowling Green KY 42102	Emmet Wood	270-782-1200	ewood@BGMU.com



**GENERAL UTILITY NOTES AND INSTRUCTIONS**  
**APPLICABLE TO ALL UTILITY WORK**  
**MADE A PART OF THE**  
**ROAD CONSTRUCTION CONTRACT**

**The contractor should be aware the following utility notes and KYTC Utility Bid Item Descriptions shall supersede, replace and take precedence over any and all conflicting information that may be contained in utility owner supplied specifications contained in the contract, on plans supplied by the utility owner, or any utility owner specifications or information externally referenced in this contract.**

**Where information may have been omitted from these notes, bid item descriptions, utility owner supplied specifications or plans; the KYTC Standard Specifications for Road and Bridge Construction shall be referenced.**

**PROTECTION OF EXISTING UTILITIES**

The existing utilities shown on the plans are shown as best known at the time the plans were developed and are to be used as a guide only by the Contractor. The Contractor shall use all means at his disposal to accurately locate all existing utilities, whether shown on the plans or not, prior to excavation. The contractor shall protect these utilities during construction. Any damage to existing utilities during construction that are shown or not shown on the plans shall be repaired at the Contractor's expense.

**PREQUALIFIED UTILITY CONTRACTORS**

Some utility owners may require contractors that perform relocation work on their respective facilities as a part of the road contract be prequalified or preapproved by the utility owner. Those utility owners with a prequalification or preapproval requirement are as follows:

No contractors are required to be prequalified or preapproved by the utility owner to perform utility relocation work under this contract.

The bidding contractor needs to review the above list and choose from the list of approved subcontractors at the end of these general notes as identified above before bidding. When the list of approved subcontractors is provided, only subcontractors shown on the following list(s) will be allowed to work on that utility as a part of this contract.

When the list of approved subcontractors for the utility work is not provided in these general notes, the utility work can be completed by the prime contractor. If the prime contractor chooses to subcontract the work, the subcontractor shall be prequalified with the KYTC Division of Construction Procurement in the work type of "Utilities" (I33). Those who would like to become prequalified may contact the Division of Construction Procurement at (502) 564-3500. Please note: it could take up to 30 calendar days for prequalification to be approved. The prequalification does not have to be approved prior to the bid, but must be approved before the subcontract will be approved by KYTC and the work can be performed.

### CONTRACT ADMINISTRATION RELATIVE TO UTILITY WORK

All utility work is being performed as a part of a contract administered by KYTC; there is not a direct contract between the utility contractor and utility owner. The KYTC Section Engineer is ultimately responsible for the administration of the road contract and any utility work included in the contract.

### SUBMITTALS AND CORRESPONDENCE

All submittals and correspondence of any kind relative to utility work included in the road contract shall be directed to the KYTC Section Engineer, a copy of which may also be supplied to the utility owner by the contractor to expedite handling of items like material approvals and shop drawings. All approvals and correspondence generated by the utility owner shall be directed to the KYTC Section Engineer. The KYTC Section Engineer will relay any approvals or correspondence to the utility contractor as appropriate. At no time shall any direct communication between the utility owner and utility contractor without the communication flowing through the KYTC Section Engineer be considered official and binding under the contract.

### ENGINEER

Where the word "Engineer" appears in any utility owner specifications included in this proposal, utility owner specifications included as a part of this contract by reference or on the utility relocation plans, it shall be understood the "Engineer" is the Kentucky Transportation Cabinet (KYTC) Section Engineer or designated representative and the utility owner engineer or designated representative jointly. Both engineers must mutually agree upon all decisions made with regard to the utility construction. The Transportation Cabinet, Section Engineer shall make all final decisions in all disputes.

### INSPECTOR OR RESIDENT PROJECT REPRESENTATIVE

Where the word "Inspector" or "Resident Project Representative" appears in the utility specifications included in this proposal, utility owner specifications included as a part of this contract by reference or on the utility relocation plans, it shall be understood the "Inspector" or "Resident Project Representative" is the utility owner inspector and KYTC inspector jointly. The Transportation Cabinet, Section Engineer shall make all final decisions in all disputes.

### NOTICE TO UTILITY OWNERS OF THE START OF WORK

One month before construction is to start on a utility, the utility contractor shall make notice to the KYTC Section Engineer and the utility owner of when work on a utility is anticipated to start. The utility contractor shall again make confirmation notice to the KYTC Section Engineer and the utility owner one week before utility work is to actually start.

### UTILITY SHUTDOWNS

The Contractor shall not shut down any active and in-service mains, utility lines or services for any reason unless specifically given permission to do so by the utility owner. The opening and closing of valves and operating of other active utility facilities for main, utility line or utility service shut downs are to be performed by the utility owner unless specific permission is given to the contractor by the owner to make shutdowns. If and when the utility owner gives the contractor permission to shutdown mains, utility lines or utility services, the contractor shall do so following the rules, procedures and regulations of the utility owner. Any permission given by the utility owner to the contractor to shutdown active and in-service mains, utility lines or services shall be communicated to the KYTC Section Engineer by the utility owner that such permission has been given.

Notice to customers of utility shut downs is sometimes required to be performed by the utility contractor. The contractor may be required; but, is not limited to, making notice to utility customers in a certain minimum amount of time in advance of the shut down and by whatever means of communication specified by the utility owner. The means of communication to the customer may be; but is not limited to, a door hanger, notice by newspaper ad, telephone contact, or any combination of communication methods deemed necessary, customary and appropriate by the utility owner. The contractor should refer to the utility owner specifications for requirements on customer notice.

Any procedure the utility owner may require the contractor to perform by specification or plan note and any expense the contractor may incur to comply with the utility owner's shut down procedure and notice to customers shall be considered an incidental expense to the utility construction.

CUSTOMER SERVICE AND LATERAL ABANDONMENTS When temporary or permanent abandonment of customer water, gas, or sewer services or laterals are necessary during relocation of utilities included in the contract, the utility contractor shall perform these abandonments as part of the contract as incidental work. No separate payment will be made for service line and lateral abandonments. The contractor shall provide all labor, equipment and materials to accomplish the temporary or permanent abandonment in accordance with the plans, specifications and/or as directed by the engineer. Abandonment may include, but is not limited to, digging down on a water or gas main at the tap to turn off the tap valve or corporation stop and/or capping or plugging the tap, digging down on a sewer tap at the main and plugging or capping the tap, digging down on a service line or lateral at a location shown on the plans or agreeable to the engineer and capping or plugging, or performing any other work necessary to abandon the service or lateral to satisfactorily accomplish the final utility relocation.

### STATIONS AND DISTANCES

All stations and distances, when indicated for utility placement in utility relocation plans or specifications, are approximate; therefore, some minor adjustment may have to be made during construction to fit actual field conditions. Any changes in excess of 6 inches of plan location shall be reviewed and approved jointly by the KYTC Section Engineer or designated representative and utility owner engineer or designated representative. Changes in location without prior approval shall be remedied by the contractor at his own expense if the unauthorized change creates an unacceptable conflict or condition.

## RESTORATION

Temporary and permanent restoration of paved or stone areas due to utility construction shall be considered incidental to the utility work. No separate payment will be made for this work. Temporary restoration shall be as directed by the KYTC Section Engineer. Permanent restoration shall be “in-kind” as existing.

Restoration of seed and sod areas will be measured and paid under the appropriate seeding and sodding bid items established in the contract for roadway work.

---

BELOW ARE NOTES FOR WHEN “INST” ITEMS ARE IN THE CONTRACT MEANING THE UTILITY COMPANY IS PROVIDING CERTAIN MATERIALS FOR UTILITY RELOCATION

## MATERIAL

Contrary to Utility Bid Item Descriptions, those bid items that have the text “**Inst**” at the end of the bid item will have the major components of the bid item provided by the utility owner. No direct payment will be made for the major material component(s) supplied by the utility company. All remaining materials required to construct the bid item as detailed in utility bid item descriptions, in utility specifications and utility plans that are made a part of this contract will be supplied by the contractor. The contractor’s bid price should reflect the difference in cost due to the provided materials.

The following utility owners have elected to provide the following materials for work under this contract:

No materials are being supplied by the utility owner. All materials are to be supplied by the contractor per bid item descriptions, utility specifications and utility plans.

## SECURITY OF SUPPLIED MATERIALS

If any utility materials are to be supplied by the utility owner, it will be the responsibility of the utility contractor to secure all utility owner supplied materials after delivery to the project site. The utility contractor shall coordinate directly with the utility owner and their suppliers for delivery and security of the supplied materials. Any materials supplied by the utility owner and delivered to the construction site that are subsequently stolen, damaged or vandalized and deemed unusable shall be replaced with like materials at the contractor’s expense.

# Standard Sanitary Sewer Bid Item Descriptions

**S BYPASS PUMPING** This item shall include all labor, equipment, and materials needed to complete a bypass pumping and/or hauling operation for diversion of sewage during sanitary sewer construction. Examples of such operations when bypass pumping and/or hauling may be necessary is during force main tie-ins, manhole invert reconstruction, insertion of new manholes into existing mains, or other similar construction. There may be more than one bypass pumping/hauling operation on a project. This item shall be paid for each separate bypass pumping/hauling operation occurrence as called out on the plans or directed by the engineer and actually performed. There will be no separate bid items defined for length, duration, or volume of sewage pumped or hauled in each occurrence. If a bypass pumping/hauling operation is called out on the plans; but, conditions are such that the bypass pumping/hauling operation is not needed or utilized, no payment will be made under this item. The contractor shall draw his own conclusions as to what labor, equipment, and materials may be needed for each bypass pumping/hauling occurrence. The contractor should be prepared to handle the maximum volume of the sewer being bypassed, even during a storm event. This item shall not be paid separately, but shall be considered incidental, when bypass pumping and/or hauling is needed during cast-in-place-pipe (CIPP) and/or point repair operations. Please refer to the Utility Company's Specifications. If the Company does not have specifications, KYTC's Specifications shall be referenced. This item shall be paid EACH (EA).

**S CIPP LATERAL SERVICE INVESTIGATION** This item shall include all equipment, materials, labor and incidentals necessary to enter the sewer in compliance with all safety/confined space requirements and perform the identification, assessment and pre-measurement of all existing and abandoned laterals for the placement of Cured-In-Place-Pipe lining. This item shall be in payment for all lateral service investigation for all sewer segments to be lined as a part of this contract. This bid item shall include bypass pumping when required. Please refer to the Utility Company's Specifications. If the Company does not have specifications, KYTC's Specifications shall be referenced. Payment for this item shall be LUMP SUM (LS).

**S CIPP LATERAL REINSTATEMENT** This item is to pay for installing a Cured-In-Place-Pipe liner in service laterals and service/mainline connections to stabilize structural defects and construction inadequacies. This bid item shall include all labor, equipment, materials and incidentals necessary to perform the service lateral reinstatement in accordance with the plans and specifications. Work under this item shall include bypass pumping, sewer flow control, pre-installation cleaning, sealing connections to existing sewer main, pre- and post- construction CCTV inspection and final testing of the CIPP system. This item shall also include the "top hat" required by the specifications. All CIPP lateral reinstatements shall be paid under this item regardless of the size or length of reinstatement. No separate bid items of varying sizes or length of CIPP lateral reinstatement will be provided in the contract. Please refer to the Utility Company's Specifications. If the Company does not have specifications, KYTC's Specifications shall be referenced. Payment for this item shall be EACH (EA) for each CIPP lateral reinstatement complete and ready for use.

**S CIPP LINER** This bid Item is to pay for rehabilitation of existing sanitary sewers using the Cured-In-Place-Pipe method. This bid item description applies to all CIPP sizes included in the contract.

All CIPP Liner items of all varying sizes shall include all labor, materials, customer notification, testing, necessary permits, ingress and egress procedures, bypass pumping, pre-construction video, sediment and root removal, dewatering, traffic control, erosion and sediment control, excavation pits, removal and replacement of manhole frames and covers as necessary to facilitate the lining work, sealing at manholes and service connections, clearing and grubbing, pipeline cleaning, re-cleaning and video inspection as many times as necessary, debris collection and disposal, root removal, pre- and post-construction video inspection, all digital inspection footage, final report preparation and approval, the cost of potable water from the Owner, required compliance tests, site restoration, site cleanup, sealing of liner at manholes, acceptance testing and all other rehabilitation work and incidentals not included under other pay items necessary to complete the rehabilitation per the plans and specifications. There will be no separate payment for acceptance testing of the lined pipe; but shall be considered incidental to this item. Pay under this item shall be by each size bid in the contract. Pay measurement shall be from center of manhole to center of manhole. Please refer to the Utility Company's Specifications. If the Company does not have specifications, KYTC's Specifications shall be referenced. This item shall be paid LINEAR FEET (LF).

**S CIPP PROTRUDING LATERAL REMOVAL** This item includes all equipment, materials, labor and incidentals necessary to enter the sewer in compliance with all safety/confined space requirements, remove a sufficient amount of the protruding tap to insure a proper and safe Cured-In-Place-Pipe lining insertion and perform pre-installation CCTV. This bid item shall include bypass pumping when required. Please refer to the Utility Company's Specifications. If the Company does not have specifications, KYTC's Specifications shall be referenced. Payment for this item shall be EACH (EA) for each protruding lateral removed.

**S CONCRETE PIPE ANCHOR** This item shall be constructed on the sewer pipe at the locations shown on the plans in accordance with sanitary sewer specifications and standard drawings. Payment for concrete anchors will be made at the contract unit price each in place complete and ready for use. Each concrete anchor of sewer pipe or force main shall be paid under one bid item per contract regardless of the sizes of carrier pipe being anchored in the contract. No separate bid items will be established for size variations. Please refer to the Utility Company's Specifications. If the Company does not have specifications, KYTC's Specifications shall be referenced. This item shall be paid EACH (EA) when complete.

**S DIRECTIONAL BORE** Payment under this item is made whenever the plans or specifications specifically show directional boring is to be utilized in order to minimize the impact of open cut for the installation of force main or gravity sewer under streets, creeks, and etc. Payment under this item shall include the specified bore pipe, labor, and equipment. No separate payment shall be made for bore pipe installed in the bore whether used as a carrier pipe or an encasement of a separate carrier pipe. This item shall also include pipe anchors at each end of the bore when specified to prevent the creep or contraction of the bore pipe. Carrier pipe installed within a bore pipe shall be paid separately under pipe items. Payment under this item shall not be size specific and no separate bid items will be established for size variations. The bore pipe sizes to be included under this item shall be as shown on the plans and/or in the specifications. Any and all directional bores in each contract shall be paid under one directional bore bid item included in the contract regardless of size. Please refer to the Utility Company's Specifications. If the Company does not have specifications, KYTC's Specifications shall be referenced. This item shall be paid LINEAR FEET (LF).

**S ENCASEMENT CONCRETE** Includes all labor, equipment, excavation, concrete, reinforcing

steel, backfill, restoration, and etc., to construct the concrete encasement of the sewer or force main as shown on the plans, and in accordance with the specifications and standard drawings. Payment under this item shall be in addition to the carrier pipe as paid under separate bid items. Carrier pipe is not included in this bid item. Any and all concrete encasement shall be paid under one bid item included in the contract regardless of the size of the carrier pipe or the volume of concrete or steel reinforcement as specified in the plans and specifications. No separate bid items will be established for size variations. Measurement of pay quantity shall be from end of concrete to end of concrete. Please refer to the Utility Company's Specifications. If the Company does not have specifications, KYTC's Specifications shall be referenced. This item shall be paid LINEAR FEET (LF) when complete.

**S ENCASEMENT STEEL BORED** This item shall include the steel encasement pipe size as specified on the plans and in the specifications, casing spacers, end seals, labor, and equipment to bore and install the encasement in accordance with the plans and specifications, complete and ready for use. The size shall be the measured internal diameter of the encasement pipe. The sizes of encasement to be paid under the size ranges specified in the bid items shall be as follows:

- Range 1 = All encasement sizes greater than 2 inches to and including 6 inches
- Range 2 = All encasement sizes greater than 6 inches to and including 10 inches
- Range 3 = All encasement sizes greater than 10 inches to and including 14 inches
- Range 4 = All encasement sizes greater than 14 inches to and including 18 inches
- Range 5 = All encasement sizes greater than 18 inches to and including 24 inches
- Range 6 = All encasement sizes greater than 24 inches

*(Encasement sizes of 2 inches internal diameter or less shall not be paid separately; but, shall be considered incidental to the carrier pipe.)* Payment under this bid item shall not include the carrier pipe. Carrier pipe shall be paid under a separate bid item. Please refer to the Utility Company's Specifications. If the Company does not have specifications, KYTC's Specifications shall be referenced. This item shall be paid LINEAR FEET (LF).

**S ENCASEMENT STEEL OPEN CUT** This item shall include the steel encasement pipe size as specified on the plans and in the specifications, casing spacers, end seals, labor, and equipment to open cut install the encasement in accordance with the plans and specifications, complete and ready for use. The size shall be the measured internal diameter of the encasement pipe. The size encasement to be paid under the size ranges specified in the bid items shall be as follows:

- Range 1 = All encasement sizes greater than 2 inches to and including 6 inches
- Range 2 = All encasement sizes greater than 6 inches to and including 10 inches
- Range 3 = All encasement sizes greater than 10 inches to and including 14 inches
- Range 4 = All encasement sizes greater than 14 inches to and including 18 inches
- Range 5 = All encasement sizes greater than 18 inches to and including 24 inches
- Range 6 = All encasement sizes greater than 24 inches

*(Encasement sizes of 2 inches internal diameter or less shall not be paid separately; but, shall be considered incidental to the carrier pipe.)* Payment under this bid item shall not include the carrier pipe. Carrier pipe shall be paid under a separate bid item. Please refer to the Utility Company's Specifications. If the Company does not have specifications, KYTC's Specifications shall be referenced. This item shall be paid LINEAR FEET (LF).

**S FORCE MAIN** This description shall apply to all PVC and ductile iron and polyethylene/plastic pipe bid items of every size and type, except those bid items defined as "Special". This item includes the pipe specified by the plans and specifications, all fittings (including, but not limited to, bends, tees, reducers, plugs, and caps), tracing wire with test boxes (if required by specification), polyethylene wrap (when specified), labor, equipment, excavation, bedding, restoration, testing, backfill, and etc., required to install the specified new pipe and new fittings at the locations shown on the plans, or as directed, in accordance with the specifications and standard drawings complete and ready for use. No additional payment will be made for rock excavation. This bid item includes material and placement of flowable fill under existing and proposed pavement, and wherever else specified on the plans or in the specifications. This item shall also include pipe anchors on polyethylene pipe runs as shown on the plans or required by the specifications to prevent the creep or contraction of the pipe. Measurement of quantities under this item shall be through fittings, encasements, and directional bores (only when a separate carrier pipe is specified within the directional bore pipe). No separate payment will be made under pipe items when the directional bore pipe is the carrier pipe. Measurements shall be further defined to be to the center of tie-in where new pipe contacts existing pipe at the center of connecting fittings, to the outside face of vault or structure walls, or to the point of main termination at dead ends. Please refer to the Utility Company's Specifications. If the Company does not have specifications, KYTC's Specifications shall be referenced. This item shall be paid LINEAR FEET (LF).

**S FORCE MAIN AIR RLS/VAC VLV** This bid item description shall apply to all force main air release/vacuum valve installations of every size except those defined as "Special". This item shall include the air release/vacuum valve, main to valve connecting line or piping, manhole/vault/structure, access casting or doors, tapping the main, labor, equipment, excavation, proper backfill and restoration required to install the air release/vacuum valve at the location shown on the plans or as directed in accordance with the specifications and standard drawings complete and ready for use. All air release/vacuum valves on a project shall be paid under one bid item regardless of size. No separate pay items will be established for size variations. Only in the case of the uniqueness of a particular air release/vacuum valve would a separate bid item be established. Please refer to the Utility Company's Specifications. If the Company does not have specifications, KYTC's Specifications shall be referenced. This item shall be paid EACH (EA) when complete.

**S FORCE MAIN DIRECTIONAL BORE** Payment under this item is made whenever the plans or specifications specifically show directional boring is to be utilized in order to minimize the impact of open cut for the installation of sewer or force main under streets, buildings, creeks, and etc. Payment under this item shall include the specified bore pipe, labor, and equipment. No separate payment shall be made for bore pipe installed in the bore whether used as a carrier pipe or an encasement of a separate carrier pipe. This item shall also include pipe anchors at each end of the bore when specified to prevent the creep or contraction of the bore pipe. Carrier pipe installed within a bore pipe shall be paid separately under pipe items. Payment under this item shall not be size specific and no separate bid items will be established for size variations. The bore pipe sizes to be included under this item shall be as shown on the plans and/or in the specifications. Any and all directional bores in each contract shall be paid under one directional bore bid item included in the contract regardless of size. Please refer to the Utility Company's Specifications. If the Company does not have specifications, KYTC's Specifications shall be referenced. This item shall be paid LINEAR FEET (LF).

**S FORCE MAIN POINT RELOCATE** This item is intended for payment for horizontal and/or vertical relocation of a short length of an existing main at the locations shown on the plans. This bid item is to be used to relocate an existing force main at point locations such as to clear a conflict at a



proposed drainage structure, pipe or any other similar short relocation situation, and where the existing pipe material is to be reused. The contractor shall provide any additional pipe or fitting material needed to complete the work as shown on the plans and specifications. The materials provided shall be of the same type and specification as those that exist. Substitution of alternative materials shall be approved by the engineer in advance on a case by case basis. New polyethylene wrap is to be provided (if wrap exists or is specified in the specifications to be used). If it is necessary that the pipe be disassembled for relay, payment under this item shall also include replacement of joint gaskets as needed. Bedding and backfill shall be provided and performed the same as with any other pipe installation as detailed in the plans and specifications. Payment under this item shall be for each location requiring an existing main to be relocated horizontally or vertically regardless of pipe size or relocation length. No separate pay items will be established for pipe size variations or relocation segment length variations. Force Main Relocate shall not be paid on a linear feet basis; but shall be shall be paid EACH (EA) at each location when complete and placed in service. Please refer to the Utility Company's Specifications. If the Company does not have specifications, KYTC's Specifications shall be referenced.

**S FORCE MAIN TAP SLEVE/VALVE RANGE 1 OR 2** This item shall include the specified tapping sleeve, valve, valve box, concrete pad around valve box (when required in specifications or plans), labor, and equipment to install the specified tapping sleeve and valve, complete and ready for use in accordance with the plans and specifications. The size shall be the measured internal diameter of the live pipe to be tapped. The size tapping sleeve and valve to be paid under sizes 1 or 2 shall be as follows:

Range 1 = All live tapped main sizes up to and including 8 inches

Range 2 = All live tapped main sizes greater than 8 inches

Please refer to the Utility Company's Specifications. If the Company does not have specifications, KYTC's Specifications shall be referenced. This item shall be paid EACH (EA) when complete.

**S FORCE MAIN TIE-IN** This bid description shall be used for all force main tie-in bid items of every size except those defined as "Special". This item includes all labor, equipment, excavation, fittings, sleeves, reducers, couplings, blocking, anchoring, restoration, testing and backfill required to make the force main tie-in as shown on the plans and in accordance with the specifications complete and ready for use. This bid item shall include purge and sanitary disposal of any sewage from any abandoned segments of force main. Pipe for tie-ins shall be paid under separate bid items. Please refer to the Utility Company's Specifications. If the Company does not have specifications, KYTC's Specifications shall be referenced. This item shall be paid EACH (EA) when complete.

**S FORCE MAIN VALVE** This description shall apply to all force main valves of every size required in the plans and specifications, except those bid items defined as "Special". Payment under this description is to be for gate or butterfly force main valves being installed with new force main. This item includes the valve as specified in the plans and specifications, polyethylene wrap (if required by specification), labor, equipment, excavation, anchoring (if any), valve box and valve stem extensions, backfill, concrete pad around valve box (if required by specification), restoration, testing, and etc., required to install the specified valve at the location shown on the plans in accordance with the specifications and standard drawings complete and ready for use. If required on plans and/or proposed adjoining DIP is restrained, force main valves shall be restrained. Force main valve restraint shall be considered incidental to the force main valve and adjoining pipe. Please refer to the Utility Company's Specifications. If the Company does not have specifications, KYTC's Specifications shall be

referenced. This item shall be paid EACH (EA) when complete.

**S FORCE MAIN VALVE BOX ADJUST** Includes all labor, equipment, valve box and valve stem extensions (if required), excavation, backfill, concrete pad around valve box (when specified in specifications or plans), restoration, and etc., to adjust the top of the force main valve box to finished grade complete and ready for use. Please refer to the Utility Company's Specifications. If the Company does not have specifications, KYTC's Specifications shall be referenced. This item shall be paid EACH (EA) when complete.

**S LATERAL CLEANOUT** This item shall be for payment for installation of a cleanout in a service lateral line. This item shall include furnishing and installation of a tee, vertical pipe of whatever length required, and threaded cap. The cleanout shall extend from the lateral to final grade elevation. The size of the cleanout shall be equivalent to the size of the lateral. The cleanout materials shall meet the same specification as those for the lateral. The cleanout shall be installed at the locations shown on the plans or as directed by the engineer. Only one pay item shall be established for cleanout installation. No separate pay items shall be established for size or height variances. Please refer to the Utility Company's Specifications. If the Company does not have specifications, KYTC's Specifications shall be referenced. This item shall be paid EACH (EA) when complete.

**S LATERAL LOCATE** This bid item is to pay for all labor, equipment, and materials needed in locating an existing sanitary sewer service lateral for tie-in of the lateral to new mainline sewers and/or for the relocation of a lateral. This bid item shall be inclusive of any and all methods and efforts required to locate the lateral for tie-in or relocation of the lateral. Locating methods to be included under this items shall include, but are not limited to, those efforts employing the use of video cameras from within an existing sanitary sewer main or lateral, electronic locating beacons and/or tracers inserted into the sanitary sewer main or lateral, careful excavation as a separate operation from mainline sewer or lateral excavation, the use of dyes to trace the flow of a lateral, or any combination of methods required to accurately locate the lateral. Please refer to the Utility Company's Specifications. If the Company does not have specifications, KYTC's Specifications shall be referenced. This item shall be paid EACH (EA).

**S LATERAL LONG SIDE** This bid item description shall apply to all service lateral installations of every size up to and including 6 inch internal diameter, except those lateral bid items defined as "Special". This item includes the specified piping material, main tap, bends, clean outs, labor, equipment, excavation, backfill, testing, and restoration, at the locations shown on the plans or as directed, in accordance with the specifications and standard drawings, complete and ready for use. This bid item is to pay for service lateral installations where the ends of the lateral connection are on opposite sides of the public roadway. The new lateral must cross the centerline of the public roadway to qualify for payment as a long side lateral. The length of the service lateral is not to be specified. Payment under this item shall not be restricted by a minimum or maximum length. The contractor shall draw his own conclusions as to the length of piping that may be needed. Payment under this item shall include boring, jacking, or excavating across the public roadway for placement. Placement of a service lateral across a private residential or commercial entrance alone shall not be reason to make payment under this item. Private or commercial entrances shall not be considered a public roadway in defining payment under this item. No additional payment will be made for rock excavation or for bedding required in rock excavation. Please refer to the Utility Company's Specifications. If the Company does not have specifications, KYTC's Specifications shall be referenced. This item shall be paid EACH (EA) when complete.

**S LATERAL SHORT SIDE** This bid item description shall apply to all service lateral installations of every size up to and including 6 inch, except those lateral bid items defined as “Special”. This item includes the specified piping material, main tap tee, bends, clean outs, labor, equipment, excavation, backfill, testing, and restoration, at the locations shown on the plans or as directed, in accordance with the specifications and standard drawings, complete and ready for use. This bid item is to pay for lateral installations where both ends of the lateral connection are on the same side of the public roadway, or when an existing lateral crossing a public roadway will remain and is being extended, reconnected, or relocated with all work on one side of the public roadway centerline as shown on the plans. The length of the service lateral is not to be specified and shall not be restricted to any minimum or maximum length. Payment shall be made under this item even if the lateral crosses a private residential or commercial entrance; but, not a public roadway. Private or commercial entrances shall not be considered a public roadway in defining payment under this item. The contractor shall draw his own conclusions as to the length of piping that may be needed. No additional payment will be made for rock excavation or for bedding required in rock excavation. Please refer to the Utility Company’s Specifications. If the Company does not have specifications, KYTC’s Specifications shall be referenced. This item shall be paid EACH (EA) when complete.

**S LINE MARKER** This item is for payment for furnishing and installing a sewer utility line marker as specified by the utility owner specifications and plans. A line marker may consist of a post or monument of whatever materials specified and shall include markings and/or signage on same as specified by plans or specifications. This item shall include all labor, equipment, and materials needed for complete installation of the marker. This item shall be paid EACH (EA) when complete.

**S MANHOLE** Payment under this item is for the installation of new 4 foot interior diameter sanitary sewer manhole. Payment for manholes will be made at the contract unit price each in place complete and ready for use at the locations shown on plans in accordance with specifications and standard drawings. Manholes shall include concrete base, barrel sections, cone section or slab top, steps, excavation, backfilling, air testing, restoration, and cleanup in accordance with the specifications and standard drawings. Payment shall be made under this item regardless of whether the base is to be precast or cast-in-place (doghouse). All materials, except casting, shall be new and unused. An existing casting from an existing abandoned or removed manhole is to be reused and shall be considered incidental to this item. When a new casting is specified, or an existing casting is unavailable, it shall be paid as a separate bid item. Anchoring of casting, new or used, shall be considered incidental to this bid item. No additional compensation will be paid for manhole height variations. No additional payment will be made for rock excavation. Please refer to the Utility Company’s Specifications. If the Company does not have specifications, KYTC’s Specifications shall be referenced. This item shall be paid EACH (EA) when complete.

**S MANHOLE ABANDON/REMOVE** Payment under this item is for the partial removal and/or filling of any sanitary sewer manhole regardless of size or depth that no longer serves any purpose. Payment shall be made regardless of whether the manhole is or is not in conflict with other work. Any manhole requiring partial removal, but not total removal, in order to clear a conflict with other work shall be paid under this item. All manholes partially removed shall be removed to a point at least one foot below final grade, one foot below roadway subgrade, or one foot clear of any other underground infrastructure, whichever is lowest. If partial removal of an abandoned manhole is elected by the contractor, the remaining manhole structure shall be refilled with flowable fill. Payment for disposal of a sanitary sewer manhole will be made under this item only. Please refer to the Utility Company’s

Specifications. If the Company does not have specifications, KYTC's Specifications shall be referenced. This item shall be paid EACH (EA) when complete.

**S MANHOLE ADJUST TO GRADE** Payment under this item is for the adjustment of sanitary sewer casting elevation on all sizes of existing sanitary manholes. This work shall be performed in accordance with the sanitary sewer specifications. Payment shall be made under this bid item regardless of the amount of adjustment necessary to a sanitary sewer manhole casting or diameter of the manhole. Work under this pay item may be as simple as placing a bed of mortar under a casting; but, shall also be inclusive of installation of adjusting rings, and /or addition, removal, or replacement of barrel sections. The existing casting is to be reused unless a new casting is specified on the plans. New casting, when specified, shall be paid as a separate bid item. Anchoring of the casting shall be incidental to this item. Please refer to the Utility Company's Specifications. If the Company does not have specifications, KYTC's Specifications shall be referenced. This item shall be paid EACH (EA) when complete.

**S MANHOLE CASTING STANDARD** Payment under this bid items is for furnishing of a new standard traffic baring casting for sanitary manholes meeting the requirements of the sanitary sewer specifications and standard drawings. Please refer to the Utility Company's Specifications. If the Company does not have specifications, KYTC's Specifications shall be referenced. This item shall be paid EACH (EA) when installed.

**S MANHOLE CASTING WATERTIGHT** Payment under this bid item is for furnishing of a new watertight traffic baring casting for sanitary manholes meeting the requirements of the sanitary sewer specifications and standard drawings. Please refer to the Utility Company's Specifications. If the Company does not have specifications, KYTC's Specifications shall be referenced. This item shall be paid EACH (EA) when installed.

**S MANHOLE RECONSTRUCT INVERT** This bid item is to pay for all labor, equipment, and material for rework of the manhole bench to redirect or eliminate flow, such as when the flow of a pipe or pipes are being removed or redirected. This work will be as specified in the plans, specifications, or directed by the engineer. This work may consist of, but is not limited to, removal of concrete and/or placement of concrete in elimination or redirect of flow. This item shall also include providing and placement of a rubber seal or boot as required by utility specification, standard drawing or plan. The contractor shall draw his own conclusions as to the effort and scope of work needed to comply with the specifications, standard drawings, and plans. No payment shall be made under this bid when MANHOLE TAP EXISTING, or MANHOLE TAP EXISTING ADD DROP are being paid at the same location, as this type of work is included in those items. Please refer to the Utility Company's Specifications. If the Company does not have specifications, KYTC's Specifications shall be referenced. This item shall be paid EACH (EA) when complete.

**S MANHOLE TAP EXISTING** This bid item is to pay for all labor, equipment, and material for coring one opening in an existing manhole base, addition of a rubber seal as specified, and rework of the manhole bench to direct the additional pipe flow. The bid item shall be paid for each core opening added to a single manhole. This bid item shall also include any rework of the existing manhole bench due to the elimination of other existing pipes and flow. This work will be as specified in the plans, specifications, or directed by the engineer. This work may consist of, but is not limited to, removal of concrete and/or placement of concrete in the addition, elimination, or redirect of flow. The contractor shall draw his own conclusions as to the effort and scope of work needed to comply with the

specifications, standard drawings, and plans. Please refer to the Utility Company's Specifications. If the Company does not have specifications, KYTC's Specifications shall be referenced. This item shall be paid EACH (EA) when complete.

**S MANHOLE TAP EXISTING ADD DROP** This bid item is to pay for all labor, equipment, and material for coring one opening in an existing manhole base, addition of a rubber seal as specified, addition of a vertical drop pipe to the outside of the manhole, placement of reinforcing steel and concrete to encase vertical pipe, and rework of the manhole bench to direct the additional pipe flow. The bid item shall be paid for each drop added to a single manhole. This bid item shall also include any rework of the existing manhole bench due to the elimination of other existing pipes and flow. This work will be as specified in the plans, specifications, or directed by the engineer. This work may consist of, but is not limited to, removal of concrete and/or placement of concrete in the addition, elimination, or redirect of flow. The contractor shall draw his own conclusions as to the effort and scope of work needed to comply with the specifications, standard drawings, and plans. Please refer to the Utility Company's Specifications. If the Company does not have specifications, KYTC's Specifications shall be referenced. This item shall be paid EACH (EA) when complete.

**S MANHOLE WITH DROP** Payment under this item is for the installation of new 4 foot interior diameter sanitary sewer manhole with drop. Payment for drop manholes will be made at the contract unit price each in place complete and ready for use at the locations shown on plans in accordance with specifications and standard drawings. Drop manholes shall include concrete base, barrel sections, drop materials, cone section or slab top, steps, excavation, backfilling, air testing, restoration, and cleanup. Payment shall be made under this item regardless of whether the base is to be precast or cast-in-place (doghouse). All materials, except casting, shall be new and unused. An existing casting from an existing abandoned or removed manhole is to be reused and shall be considered incidental to this item. When a new casting is specified, or an existing casting is unavailable, it shall be paid as a separate bid item. Anchoring of casting, new or used, shall be considered incidental to this bid item. No additional compensation will be paid for manhole height variations. No additional payment will be made for rock excavation. Please refer to the Utility Company's Specifications. If the Company does not have specifications, KYTC's Specifications shall be referenced. This item shall be paid EACH (EA) when complete.

**S MANHOLE WITH LINING** Payment under this item is for the installation of new 4 foot interior diameter sanitary sewer manhole with corrosion resistant lining. Payment for manholes will be made at the contract unit price each in place complete and ready for use at the locations shown on plans in accordance with specifications and standard drawings. Manholes shall include concrete base, barrel sections, cone section or slab top, steps, lining, excavation, backfilling, air testing, restoration, and cleanup in accordance with the standard drawings. Payment shall be made under this item regardless of whether the base is to be precast or cast-in-place (doghouse). All materials, except casting, shall be new and unused. An existing casting from an existing abandoned or removed manhole is to be reused and shall be considered incidental to this item. When a new casting is specified, or an existing casting is unavailable, it shall be paid as a separate bid item. Anchoring of casting, new or used, shall be considered incidental to this bid item. No additional compensation will be paid for manhole height variations. No additional payment will be made for rock excavation. Please refer to the Utility Company's Specifications. If the Company does not have specifications, KYTC's Specifications shall be referenced. This item shall be paid EACH (EA) when complete.

**S MANHOLE WITH TRAP** Payment under this item is for the installation of a new manhole with

trap. Payment for trap manholes will be made at the contract unit price each in place complete and ready for use at the locations shown on plans in accordance with specifications and standard drawings. Trap manholes shall include concrete base, manhole structure and trap materials, cone section or slab top, steps, excavation, backfilling, air testing, restoration, and cleanup. All materials, except casting, shall be new and unused. Payment shall be made under this item regardless of whether the base is to be precast or cast-in-place (doghouse). An existing casting from an existing abandoned or removed manhole is to be reused and shall be considered incidental to this item. When a new casting is specified, or an existing casting is unavailable, it shall be paid as a separate bid item. Anchoring of casting, new or used, shall be considered incidental to this bid item. No additional compensation will be paid for manhole height variations. No additional payment will be made for rock excavation. Please refer to the Utility Company's Specifications. If the Company does not have specifications, KYTC's Specifications shall be referenced. This item shall be paid EACH (EA) when complete.

**S PIPE** This description shall apply to all PVC and ductile iron gravity sewer pipe bid items of every size and type 8 inches internal diameter and larger, except those bid items defined as "Special". This item includes the pipe specified by the plans and specifications, all fittings (including, but not limited to, tap tees and couplings for joining to existing similar or dissimilar pipes), polyethylene wrap (if required by specification), labor, equipment, excavation, bedding, restoration, pressure or vacuum testing, temporary testing materials, video inspection, backfill, and etc., required to install the specified new pipe and new fittings at the locations shown on the plans, or as directed, in accordance with the specifications and standard drawings complete and ready for use. This bid item shall include material and placement of flowable fill under existing and proposed pavement, and wherever specified on the plans or in the specifications. No additional payment will be made for rock excavation. Measurement of quantities under this item shall be through fittings and encasements to a point at the outside face of manhole barrels, or to the point of main termination at dead ends or lamp holes. Carrier pipe placed within an encasement shall be paid under this item and shall include casing spacers and end seals. Please refer to the Utility Company's Specifications. If the Company does not have specifications, KYTC's Specifications shall be referenced. This item shall be paid LINEAR FEET (LF).

**S PIPE POINT REPAIR** This item is to be used to pay for repair of short lengths of existing sanitary sewer pipe that, through prior video inspection or other means, are known to have pre-existing failure. Pipe Point Repair may be needed in preparation for installation of cured-in-place-pipe (CIPP) lining or other instances where failure is known and repair is prudent. The size of pipe shall not be defined in separate bid items. All diameter sizes of point repair shall be paid under this one item. The materials to be used to make the repair shall be as defined on the plans or in the specifications. This bid item shall include all excavation, pipe materials, joining materials to connect old and new pipe, bedding, and backfill to complete the repair at the locations shown on the plans or as directed by the engineer, complete and ready for use. This bid item shall include bypass pumping when required. Measurement shall be from contact point to contact point of old and new pipe. Please refer to the Utility Company's Specifications. If the Company does not have specifications, KYTC's Specifications shall be referenced. This item shall be paid LINEAR FEET (LF).

**S PUMP STATION** This item is for payment for installation of sanitary pump stations including above or below ground structure for housing of the pumps. This item shall include all pumps, piping, fittings, valves, electrical components, building materials, concrete, any other appurtenances, labor, equipment, excavation, and backfill, to complete the pump station installation as required by the plans, standard drawings, and specifications, complete and ready for use. Please refer to the Utility Company's Specifications. If the Company does not have specifications, KYTC's Specifications shall

be referenced. This item shall be paid LUMP SUM (LS) for each when complete.

**S STRUCTURE ABANDON** This item is to be used to pay for abandonment of larger above or below ground sewer structures such as air release/vacuum valve vaults, pump stations, tanks, etc. Payment under this time shall not be limited to size or scope; however structures with connecting pipes of 2 inches or less shall not be paid under this item; but, shall be considered incidental to sewer construction, (i.e., abandonment of standard air release/vacuum valves up to and including 2 inches would not be paid under this item). Payment under this item shall include all labor, equipment, and compacted fill or flowable fill for abandonment of the structure in place and restoration complete. No separate bid items will be established for size or structure variations. Please refer to the Utility Company's Specifications. If the Company does not have specifications, KYTC's Specifications shall be referenced. This item shall be paid EACH (EA) when complete.

**S STRUCTURE REMOVAL** This item is to be used to pay for removal of larger above or below ground sewer structures such as air release/vacuum valve vaults, pump stations, tanks, and etc. Payment under this time shall not be limited to size or scope; however, structures with connecting pipes of 2 inches or less shall not be paid under this item; but, shall be considered incidental to sewer construction, (i.e., removal of standard air release/vacuum valves and their structure up to and including 2 inches would not be paid under this item). Payment under this item shall include all labor, equipment, and compacted backfill for removal of the structure and restoration complete. No separate bid items will be established for size or structure variations. Please refer to the Utility Company's Specifications. If the Company does not have specifications, KYTC's Specifications shall be referenced. This item shall be paid EACH (EA) when complete.

Engineering  
Architecture  
Planning  
GIS  
Aviation Consultants

Indianapolis, IN  
Columbus, OH  
Cincinnati, OH  
Lexington, KY  
Louisville, KY  
Knoxville, TN  
Nashville, TN  
Saint Albans, WV  
Buckhannon, WV

## Contract Documents and Technical Specifications

---



engineering | architecture | geospatial

**Natcher Pkwy at US-231  
Sewer Relocation**

**Bowling Green  
Municipal Utilities**

**Item No. 03-2042.20**

**GRW Project No. 4697**

**May 2020**

**Bid Set**

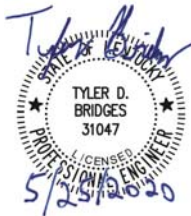



## TABLE OF CONTENTS

### Technical Specifications

#### DIVISION 1 - GENERAL REQUIREMENTS

011100 - Summary of Work.....	1-1
011400 - General Provisions .....	1-11
011410 - Special Provisions.....	1-1
012213 - Basis of Measurement and Payment - Sewer.....	1-5
012500 - Products and Substitutions .....	1-5
013113 - Project Coordination .....	1-2
013216 - Progress Schedules.....	1-3
013323 - Shop Drawings, Product Data, Samples and RFI's .....	1-6
014216 - Definitions and Standards.....	1-3
014500 - Quality Control Services - Line Project .....	1-3
017329 - Cutting and Patching.....	1-4
017400 - Cleaning .....	1-3
017700 - Project Closeout.....	1-3
017823 - Operations and Maintenance Manuals .....	1-6
017834 - Warranties and Bonds .....	1-3
017839 - Project Record Documents .....	1-3

#### DIVISION 3 - CONCRETE

034000 - Precast Concrete Structures.....	1-5
---	-----

#### DIVISION 31 - EARTHWORK

312000 - Earthwork .....	1-10
312319 - Dewatering .....	1-1
312500 - Erosion and Sedimentation Control - KPDES Requirements.....	1-6
315000 - Excavation Support and Protection.....	1-3

#### DIVISION 32 - EXTERIOR IMPROVEMENTS

321216 - Asphalt Paving (Kentucky) .....	1-5
329200 - Lawns and Grasses.....	1-5

#### DIVISION 33 - UTILITIES

330523 - Boring and Jacking.....	1-5
333113 - Gravity Sewer Piping .....	1-16
333913 - Sanitary Sewer Manholes, Frames and Covers.....	1-10

DIVISION 01  
GENERAL REQUIREMENTS

SECTION 011100 - SUMMARY OF WORK

PART 1 - GENERAL

1.1 SCOPE OF WORK PERFORMED UNDER THIS CONTRACT

*This project includes the relocation of gravity sewer mains adjacent to the Natcher Parkway at its intersection with US-231 (Scottsville Road) in Bowling Green, KY. In total, approximately 800 LF of 18 inch and 10 inch gravity sewer mains and associated manholes.*

1.2 ENUMERATION OF DRAWINGS & SPECIFICATIONS

*Following are the Drawings and Specifications which form the Contract Documents as set forth in Section 1.1 of the General Conditions:*

Drawings

Sheet Number

See Index of Sheets on Project Plans Cover

Specifications

See Table of Contents

PART 2 - PRODUCTS (Not Applicable)

PART 3 - EXECUTION (Not Applicable)

END OF SECTION 011100

## SECTION 011400 - GENERAL PROVISIONS

### PART 1 - GENERAL

#### 1.1 DESIGNATION OF PARTIES

- A. All references in the Specifications, Contract Documents and Drawings to "Owner" shall mean Bowling Green Municipal Utilities, 801 Center Street, Bowling Green, KY 42102; all references to "Engineer" shall mean GRW Engineers, Inc., 801 Corporate Drive, Lexington, Kentucky 40503.

#### 1.2 EXPERIENCE CLAUSE

- A. Wherever experience is required of equipment manufacturers in manufacturing or in records of satisfactory operation for a specified period of time, in lieu of the experience, the manufacturer may furnish a 100 percent (100%) performance guarantee bond or a cash deposit. The bond or cash deposit provided by the manufacturer shall guarantee replacement of the equipment process in the event of failure or unsatisfactory service. The period of time for which the bond or cash deposit is required shall be the same as the experience period of time specified.

#### 1.3 ACCESS TO INSPECTION OF WORK

- A. Representatives of the State Department of Health, the State Department for Natural Resources and Environmental Protection, local public health agencies, Owner, and Engineer shall at all times have full access to the project site for inspection of the work accomplished under this Contract and for inspection of all materials intended for use under the Contract. The Contractor shall provide proper facilities for such access and inspection.

#### 1.4 EQUIPMENT LUBRICATION

- A. The Contractor shall make suitable provision for the proper lubrication of all equipment furnished under this Contract. Accessible grease fittings shall be provided where required. A supply of oil, grease and other lubricants of proper quality, as recommended by the manufacturer of the equipment, shall be furnished. Lubricants shall be furnished in their original, unopened containers, in sufficient quantity for initial fillings and for at least one (1) year of operation.

#### 1.5 PRE-CONSTRUCTION CONFERENCE

- A. The Contractor, Engineer and Owner, or their duly appointed representative, shall meet in a preconstruction conference prior to the initiation of construction to organize, schedule and determine responsibilities for the work as it pertains to each party of the Contract.

1.6 CONSTRUCTION SCHEDULE CHART

- A. Prior to start of any construction, the Contractor shall furnish a construction schedule or progress chart. The schedule or chart shall be subject to the approval of the Engineer, and be of sufficient detail to show the chronological relationship of all activities of the project, the order in which the Contractor proposes to carry on the work, estimated starting and completion dates of major features, procurement of materials, and scheduling of equipment. The schedule shall be in a form suitable for appropriately indicating the percentage of work scheduled for completion at any time. The schedule shall be kept current and shall reflect completion of all work under the Contract within the specified time and in accordance with these Specifications.

1.7 CONSTRUCTION PROGRESS MEETINGS

- A. Monthly construction progress meetings shall be held at the project site or at a designated location established by the Owner. The Contractor, appropriate Sub-Contractors, the Engineer and the Owner shall meet to review construction progress, equipment or material submittals, construction schedules, etc.

1.8 PRECONSTRUCTION PHOTOGRAPHS

- A. Prior to construction and mobilization of equipment, Contractor shall take record photographs of all areas of the project site.
- B. In lieu of photographs, a videographic record may be made of the project site.
- C. Photographs and/or videos shall be provided to the engineer and owner in electronic format.

1.9 SPARE PARTS

- A. Spare parts for routine maintenance and minor repairs shall be provided for specified equipment items in the respective technical sections of these Specifications. Required spare parts to be provided are listed in the particular equipment Specifications.
- B. Parts shall be coated to protect them from a moist atmosphere. All spare parts shall be plainly tagged, marked for identification and reordering, and shall be delivered properly boxed. Required identification includes (but is not limited to):
  - 1. Name of the manufacturer or supplier of equipment.
  - 2. Name of the unit for which the part is intended.
  - 3. Name of the spare part.
  - 4. Name of the supplier of the spare part.
  - 5. Manufacturer's catalogue part number.
  - 6. Precautionary information.
  - 7. Any other identifying information deemed appropriate.
- C. All spare parts for a single equipment item shall be crated together in containers suitable for handling with hoisting equipment and designed for prolonged storage and stenciled to identify contents.

- D. Where oil or grease lubricated equipment is concerned, sufficient oil or grease of types recommended by the equipment manufacturer shall be supplied for one year's operation.
- E. The Contractor shall furnish and deliver the spare parts to the Owner at such time as he (Owner) may direct but prior to Contract expiration date. Furnish to the Engineer for record purposes a list of spare parts delivered to the Owner.

#### 1.10 CLEANING

- A. The Contractor shall at all times keep the construction site and the surrounding area presentable to the public, and clean of rubbish caused by the Contractor's operation. At completion of the work, the Contractor shall remove all the rubbish, all tools, equipment, temporary work and surplus materials, from and about the premises, and shall leave the site clean and ready for use.
- B. After completion of all work and before final acceptance of the work, the Contractor shall thoroughly clean all equipment and materials and shall remove all foreign matter such as grease, dirt, plaster, labels, stickers, etc., from the exterior of the piping, equipment and all associated fabrication.
- C. All waste and excess materials shall be disposed of off the project site and at no additional expense to the Owner. In no case shall waste materials (any removed concrete, piping, equipment, etc.) be buried on the site. Burning is not permitted.
- D. Upon completion of the project, the Contractor is responsible for leaving the project site in as good as or better condition than the original. This includes site grading, landscaping, replacement of sidewalks, driveways, curbs, mailboxes, clotheslines, fences, etc. and removal of all construction debris.

#### 1.11 TAXES

- A. Proposals shall be made to include any applicable taxes on payrolls, materials, equipment, vehicles, utilities, etc., including State sales taxes and shall include compensation for such taxes on all work under this Contract.

#### 1.12 LINES AND GRADES

- A. The Engineer will set a benchmark or marks near the site and furnish the Contractor with the elevation of same. The Engineer will assist the Contractor in laying out the axes of the structures. The Contractor shall be responsible for all other lines and grades required for the construction of structures. The Contractor shall set line and grade stakes for all gravity sewers, offset from the centerline of the trench or the axes of the pipelines.
- B. The Contractor shall use a laser beam instrument to set the grades on gravity sewer lines. In using such an instrument, the Contractor shall be responsible for maintaining grades and elevations as called for on the drawing profiles, and any variances found shall be corrected by the Contractor at his expense. The Contractor shall verify invert elevation at each manhole for a check. A blower shall be used with the laser beam instrument during warm or hot weather to assure accurate line and grade for the laser beam.

- C. When water lines, process piping and other such buried pressure pipelines are involved, the Engineer will assist the Contractor in the location of these lines; however, any detailed layout requiring surveying, or excavation including that required for establishing the grade of the pipeline, shall be accomplished by the Contractor.
- D. The Contractor shall furnish all materials, stakes and grade boards that are required for layout by the Contractor's forces. In addition, the Contractor shall furnish any necessary survey personnel to mark the location of the various facilities on the ground, establishing bench levels and determining as-built conditions after work is completed. The Contractor's personnel engaged in the layout work described herein and the aides furnished to the Engineer shall be fully capable of performing the duties set out herein and shall be fully qualified as required. Contractor shall be responsible for verifying all profiles and elevations prior to construction.

1.13 BLASTING

- A. All blasting operations shall be conducted in strict accordance with the Rules and Regulations of the State Department of Mine and Minerals, Division of Explosives and Blasting, which shall be deemed to be included in these Specifications the same as though herein written in full. The Contractor shall also comply with applicable municipal ordinances, Federal Safety Regulations and Section 9 of the Manual of Accident Prevention in Construction, published by the Associated General Contractor's of America, Inc. All explosives shall be stored in conformity with said ordinances, laws and safety regulations. No blasting shall be done within five feet of any water mains, or ten feet of any gas mains except with light charges of explosives. Any damage done by blasting is the responsibility of the Contractor and shall be promptly and satisfactorily repaired by him. All blast events shall be designed in accordance with state laws. These guidelines are established to limit peak particle velocities occurring as a result of blasting to protect structures from damage due to ground motions from blast events. The peak particle velocity is the maximum velocity of particle excitation measured along any of the three orthogonal axes (longitudinal, vertical or transverse). In addition the following guidelines shall be applicable to new concrete.

Age of Concrete, Days*	Maximum Permissible Particle Velocity, IPS**
0 to 1	0.25
2	0.50
3-or more	1.00

\* Concrete is defined as properly designed and placed, well-consolidated Portland Cement concrete achieving a normal increase in strength with age.

\*\* Measured at location of concrete, by probe fixed in or on soil surface.

As an option, a scaled distance (distance from blast to concrete/-square root of charge weight) of 130 or more can be used conservatively to design blast events.

- B. Unless otherwise required by ordinance or law, each excavation crew shall be provided with two metal boxes equipped with suitable locks. One of these boxes shall be for storing explosives and one for caps. The boxes shall always be locked except when in actual use. They shall be painted a bright color and stenciled with appropriate warning signs. At night, explosives and caps shall be stored in separate magazines.

- C. If any possibility exists of rock or any other debris leaving the site during a blast event, the shot shall be covered with rope, heavy timber or rubber mats, to prevent the aforementioned.
- D. The Contractor shall keep a blasting log and, for each blast, shall record the date, time of blast, number of holes, type of explosive, number of delays, amount of charge per delay; stemming type, and number of caps; and all other items as required by State laws and regulations.
- E. All blasting shall be supervised and performed by qualified personnel and shall be monitored to ensure compliance with the particle velocity requirements. The Contractor shall submit a monitoring plan to the Engineer prior to beginning blasting activities.
- F. A pre-blast survey shall be performed by the Contractor. The pre-blast survey shall be accurate and up to date at the time of the blast event. The survey shall be a compilation of the condition, type, and general appearance of all nearby structures. It shall also include a listing of any vibration-sensitive equipment or conditions which exist at adjacent facilities. The owners and occupants of these facilities shall be notified of the intent to blast and the blasting schedule. The survey shall be conducted by a competent engineering firm or other qualified firm and sufficiently documented by photographs, video, measurements, and diagrams. The survey shall include all structures within 200' of the project or any such structure the Contractor feels may be reasonably affected by ground and/or air vibrations from blasting. Pre-blast survey results shall be submitted to the Owner upon request.
- G. Shot rock which is excavated shall be disposed of offsite by the Contractor. No rock larger than one-half cubic foot will be permitted in the backfill.

#### 1.14 COMPLIANCE WITH SAFETY REGULATIONS

- A. The equipment items furnished shall comply with all governing federal and state laws regarding safety, including all current requirements of the Occupational Safety and Health Act (OSHA). Contractor shall be solely responsible for job safety in accordance with all laws, regulations, methods, etc. of OSHA and the state.

#### 1.15 MAINTENANCE AND OPERATIONS MANUAL

- A. Every piece of equipment furnished and installed shall be provided with complete maintenance and operations manuals. These shall be detailed in instructions to the Owner's personnel. They shall be attractively bound for the Owner's records. See 01 33 23 and Section 01 78 23 for requirements. The manuals shall be submitted to the Engineer for review as to adequacy and completeness. Provide four copies each, unless otherwise noted.

#### 1.16 OBSTRUCTIONS

- A. In cases where storm sewers, sanitary sewers, gas lines, water lines, telephone lines, electric lines or other underground structures are encountered, they shall not be displaced or molested unless necessary, in which case they shall be replaced in as good a condition as found and as quickly as possible.



- B. The Contractor is responsible for notifying the appropriate utility companies, and coordinating the protection of the utility. All such lines or underground structures damaged or molested in the construction shall be replaced at the Contractor's expense, unless in the opinion of the Engineer, such damage was caused through no fault of the Contractor.

#### 1.17 STORAGE FACILITIES

- A. The Contractor shall be responsible for proper and adequate storage of all materials and equipment used on the site. Any additional off-site space required for construction purposes shall be the Contractor's responsibility to obtain.
- B. Upon completion of the work, the Contractor shall remove all storage facilities, surplus materials and equipment and restore the site to its original condition, or to the finished condition as required by the Contract.

#### 1.18 STANDARDS OF WORKMANSHIP

- A. Work of all crafts and trades shall be laid out to lines and elevations as established by the Contractor from the Drawings or from instructions by the Engineer. Unless otherwise shown, all work shall be plumb and level, in straight lines and true planes, parallel or square to the established lines and levels. The work shall be accurately measured and fitted to tolerance as established by the best practices of the crafts and trades involved, and shall be as required to fit all parts of the work carefully and neatly together.

#### 1.19 PERFORMANCE AND PAYMENT BONDS

- A. Performance and payment bonds, as specified in of the General Conditions, shall run for a period of one (1) year after final acceptance of the work by the Owner. These bonds shall be executed on the forms provided as a part of the Contract Documents.

#### 1.20 INITIAL START-UP AND OPERATION

- A. The initial operation period provided for herein is to check and provide the satisfactory mechanical operation of the facilities. These requirements for start-up and operation in no way relieve the Contractor of his responsibility with respect to guaranty of work as specified in the "General Conditions." The manufacturer's representatives shall be present during this period to instruct the operators in the care, operation and maintenance of the equipment. When the shakedown period is completed, the Owner will assume responsibility for maintenance and operation, provided that all major items of the Work are operating satisfactorily.
- B. If any or all of the facilities are not operating satisfactorily at the end of the shakedown period, the Contractor shall continue to maintain those facilities that are incomplete or not operating satisfactorily until they are complete and acceptable to the Owner. Maintenance by the Contractor shall include all mechanical facilities such as pumps and like equipment. Prior to start-up, the Contractor will be required to prepare an operating schedule detailing the proposed start-up and his plans for manpower and auxiliary facilities to be provided.

1.21 GUARANTY

- A. Except as otherwise specified herein, the Contractor shall guarantee all work from latent defects in materials, equipment and workmanship for one (1) year from the date of substantial completion of the Contract as defined in Section 01 77 00 of the technical Specifications.
- B. The Contractor agrees that he will obtain from the manufacturers of equipment and materials furnished under this Contract, guarantees against defective materials and workmanship, and if those guarantees furnished by the manufacturer do not extend for the term of one (1) year from and after the date upon which the final estimate is formally approved by the Owner or other established date as set forth hereinbefore, he shall make the necessary arrangements and assume all cost for extending this guarantee for the required period.
- C. The Contractor shall promptly make such repairs or replacement as may be required under the above specified guarantee, and, when the repairs or replacements involve one or more items of installed equipment, shall provide the services of qualified factory-trained servicemen in the employ of the equipment manufacturers to perform or supervise the repairs or replacements.
- D. When the Engineer or the Owner deems it necessary, and so orders, such replacements or repairs under this section shall be undertaken by the Contractor within twenty-four (24) hours after service of notice. If the Contractor unnecessarily delays or fails to make the ordered replacements or repairs within the time specified, or if any replacements or repairs are of such nature as not to admit of the delay incident to the service of a notice, then the Owner shall have the right to make such replacements or repairs, and the expense thereof shall be paid by the Contractor or deducted from any moneys due the Contractor.
- E. The Performance Bond shall remain in full force and effect throughout the Guaranty period.
- F. All warranties and guarantees remaining in effect at and beyond the Guaranty expiration date shall be relinquished and transferred to the Owner. Copies of such warranty/guaranty shall be submitted to the Engineer prior to date of the start of the guaranty period.

1.22 TRAFFIC CONTROL AND MAINTENANCE

- A. Traffic shall be maintained on all highways and streets at all times during construction of pipe lines across or along side said highways and streets. Access to all existing subdivisions and private residences shall also be kept open. Work shall be performed in accordance with applicable City, County, and state Department of Transportation guidelines. Traffic control shall include proper signing and flagging per these guidelines.
- B. Traffic shall be maintained in accordance with the Manual on Uniform Traffic Control Devices. Work shall include all labor and materials necessary for construction and maintenance of traffic control devices and markings.
- C. Traffic control shall also include all flag persons and traffic control devices such as, but not limited to, flashers, signs, barricades and vertical panels, plastic drums (steel drums will not be permitted) and cones necessary for the control and protection of vehicular and pedestrian traffic as specified by the Manual on Uniform Traffic Control Devices.

- D. Any temporary traffic control items, devices, materials, and incidentals shall remain the property of the Contractor when no longer needed.
- E. The Contractor shall maintain a two-lane traveled way with a minimum lane width of 10 feet; however, during working hours, one-way traffic may be allowed at the discretion of the Engineer, provided adequate signing and flagpersons are at the location.
- F. The Contractor shall fully cover with plywood any signs, either existing, permanent or temporary, which do not properly apply to the current traffic phasing, and shall maintain the covering until the signs are applicable or are removed.
- G. In general, all traffic control devices shall be placed starting and proceeding in the direction of the flow of traffic and removed starting and proceeding in the direction opposite to the flow of traffic.
- H. The Engineer and Contractor shall review the signing before traffic is allowed to use lane closures, crossovers, or detours, and all signing shall be approved by the Engineer before work can be started by the Contractor.
- I. If traffic should be stopped due to construction operations and an emergency vehicle on an official emergency run arrives on the scene, the Contractor shall make provisions for the passage of that vehicle immediately.

#### 1.23 FLOOD INSURANCE

- A. Contractor is required to carry flood insurance for projects which are located in designated flood hazard areas unless Federal Flood Insurance is not available.

#### 1.24 UTILITY LINE ACTIVITIES COVERED UNDER NATIONWIDE PERMIT # 12

- A. All activities involving utility line construction covered under the US Army Corps of Engineers NATIONWIDE PERMIT # 12 shall meet the following conditions:
  - 1. Utility Line Activities. Activities required for the construction, maintenance, repair, and removal of utility lines and associated facilities in waters of the United States, provided the activity does not result in the loss of greater than 1/2-acre of waters of the United States for each single and complete project. Utility lines: This NWP authorizes the construction, maintenance, or repair of utility lines, including outfall and intake structures, and the associated excavation, backfill, or bedding for the utility lines, in all waters of the United States, provided there is no change in pre-construction contours. This NWP also authorizes temporary structures, fills, and work necessary to conduct the utility line activity.
  - 2. Appropriate measures must be taken to maintain normal downstream flows and minimize flooding to the maximum extent practicable, when temporary structures, work, and discharges, including cofferdams, are necessary for construction activities, access fills, or dewatering of construction sites. Temporary fills must consist of materials, and be placed in a manner, that will not be eroded by expected high flows. Temporary fills must be removed in their entirety and the affected areas returned to pre-construction elevations. The areas affected by temporary fills must be revegetated, as appropriate.

3. Notification: The permittee must submit a pre-construction notification to the US Army Corps district engineer prior to commencing the activity if any of the following criteria are met: (1) The activity involves mechanized land clearing in a forested wetland for the utility line right-of-way; (2) a section 10 permit is required; (3) the utility line in waters of the United States, excluding overhead lines, exceeds 500 feet; (4) the utility line is placed within a jurisdictional area (i.e., water of the United States), and it runs parallel to or along a stream bed that is within that jurisdictional area; (5) discharges that result in the loss of greater than 1/10-acre of waters of the United States; (6) permanent access roads are constructed above grade in waters of the United States for a distance of more than 500 feet; or (7) permanent access roads are constructed in waters of the United States with impervious materials.
- B. All activities involving utility line construction covered under KENTUCKY GENERAL CERTIFICATION of Nationwide Permit # 12 shall meet the following conditions:

The general Water Quality Certification applies to surface waters of the Commonwealth as defined in 401KAR10:001 Chapter 10, Section 1(80): Surface waters means those waters having well-defined banks and beds, either constantly or intermittently flowing, lakes and impounded waters; marshes and wetlands; and any subterranean waters flowing in well-defined channels and having a demonstrable hydrologic connection with the surface.

1. The activity will not occur within surface waters of the Commonwealth identified by the Kentucky Division of Water as Outstanding State or National Resource Water, Cold Water Aquatic Habitat, or Exceptional Waters.
2. The activity will not occur within surface waters of the Commonwealth identified as perpetually-protected (e.g. deed restriction, conservation easement) mitigation sites.
3. This general water quality certification does not authorize the installation of utility lines in a linear manner within the stream channel or below the top of the stream bank.
4. For a single crossing, impacts from the construction and maintenance corridor in surface waters shall not exceed 50 feet of bank disturbance.
5. This general certification shall not apply to nationwide permits issued for individual crossings which are part of a larger utility line project where the total cumulative impacts from a single and complete linear project exceed ½ acre of wetlands or 300 linear feet of surface waters. Cumulative impacts include utility line crossings, permanent or temporary access roads, headwalls, associated bank stabilization areas, substations, pole or tower foundations, maintenance corridor, and staging areas.
6. Stream impacts under Conditions 4 and 5 of this certification are defined as the length of bank disturbed. For the utility line crossing and roads, only one bank length is used in calculation of the totals.
7. Stream impacts covered under this General Water Quality Certification and undertaken by those persons defined as an agricultural operation under the Agricultural Water Quality Act must be completed in compliance with the Kentucky Agricultural Water Quality Plan (KWQP).
8. The Kentucky Division of Water may require submission of a formal application for an individual certification for any project if the project has been determined to likely have a significant adverse effect upon water quality or degrade the waters of the Commonwealth so that existing uses of the water body or downstream waters are precluded.
9. Activities that do not meet the conditions of this General Water Quality Certification require an Individual Section 401 Water Quality Certification.
10. Blasting of stream channels, even under dry conditions, is not allowed under this general water quality certification.

11. Utility lines placed parallel to the stream shall be located at least 50 feet from an intermittent or perennial stream, measured from the top of the stream bank. The cabinet may allow construction within the 50 foot buffer if avoidance and minimization efforts are shown and adequate methods are utilized to prevent soil from entering the stream.
12. Utility line stream crossings shall be constructed by methods that maintain flow and allow for a dry excavation. Water pumped from the excavation shall be contained and allowed to settle prior to re-entering the stream. Excavation equipment and vehicles shall operate outside of the flowing portion of the stream. Spoil material from the excavation shall not be allowed to enter the flowing portion of the stream.
13. The activities shall not result in any permanent changes in pre-construction elevation contours in surface waters or wetlands or stream dimension, pattern or profile.
14. Utility line activities which impact wetlands shall not result in conversion of the area to non-wetland status. Mechanized land clearing of forested wetlands for the installation or maintenance of utility lines is not authorized under this certification.
15. Activities qualifying for coverage under this General Water Quality Certification are subject to the following conditions:
  - a. Erosion and sedimentation pollution control plans and Best Management Practices must be designed, installed, and maintained in effective operating condition at all times during construction activities so that violations of state water quality standards do not occur.
  - b. Sediment and erosion control measures, such as check-dams constructed of any material, silt fencing, hay bales, etc., shall not be placed within surface waters of the Commonwealth, either temporarily or permanently, without prior approval by the Kentucky Division of Water's Water Quality Certification Section. If placement of sediment and erosion control measures in surface waters is unavoidable, design and placement of temporary erosion control measures shall not be conducted in such a manner that may result in instability of streams that are adjacent to, upstream, or downstream of the structures. All sediment and erosion control devices shall be removed and the natural grade restored within the completion timeline of the activities.
  - c. Measures shall be taken to prevent or control spills of fuels, lubricants, or other toxic materials used in construction from entering the watercourse.
  - d. Removal of riparian vegetation shall be limited to that necessary for equipment access.
  - e. To the maximum extent practicable, all in-stream work under this certification shall be performed under low-flow conditions.
  - f. Heavy equipment, e.g. bulldozers, backhoes, draglines, etc., if required for this project, should not be used or operated within the stream channel. In those instances in which such in-stream work is unavoidable, then it shall be performed in such a manner and duration as to minimize turbidity and disturbance to substrates and bank or riparian vegetation.
  - g. Any fill shall be of such composition that it will not adversely affect the biological, chemical, or physical properties of the receiving waters and/or cause violations of water quality standards. If rip-rap is utilized, it should be of such weight and size that bank stress or slump conditions will not be created because of its placement.
  - h. If there are water supply intakes located downstream that may be affected by increased turbidity and suspended solids, the permittee shall notify the operator when such work will be done.
  - i. Should evidence of stream pollution or jurisdictional wetland impairment and/or violations of water quality standards occur as a result of this activity (either from a

spill or other forms of water pollution), the Kentucky Division of Water shall be notified immediately by calling (800) 928-2380.

16. Non-compliance with the conditions of this general certification or violation of Kentucky state water quality standards may result in civil penalties.

#### 1.25 PROTECTION OF VEGETATION

- A. Reasonable care shall be taken during construction to avoid damage to vegetation. Ornamental shrubbery and tree branches shall be temporarily tied back, where appropriate, to minimize damage. Trees which receive damage to branches shall be trimmed of those branches to improve the appearance of the tree. Tree trunks receiving damage from equipment shall be treated with a tree dressing.

#### 1.26 PIPE AND MANHOLE REPLACEMENT

- A. Where indicated in the Contract Documents, pipe and manholes to be replaced shall be removed from the site and disposed of by the Contractor. Material shall not be placed back in the trench or buried on the site.

PART 2 - PRODUCTS (Not Applicable)

PART 3 - EXECUTION (Not Applicable)

END OF SECTION 011400

## SECTION 011410 - SPECIAL PROVISIONS

### PART 1 - GENERAL

#### 1.1 DESCRIPTION OF REQUIREMENTS

- A. The Contractor shall coordinate the project schedule such that the Water and Sanitary Sewer Utility relocation portion of this project is completed prior to beginning any Highway work.
- B. The Contractor shall perform the utility relocation (Water and Sanitary Sewer) work in a continuous 12-week time frame. If the Contractor fails to complete the work in the given time frame, he will be responsible for the Residents Inspector's time and expenses.

#### 1.2 COORDINATION WITH OTHER UTILITIES

- A. The locations of the existing utilities are show to the best information available. Prior to construction, the Contractor shall work with the local utility companies to verify locations and depths (by probing, excavation and/or vacuum excavation) of the existing utility lines. This work is not a pay item.
- B. Contractor shall note that the construction of the new sewer will be performed in close proximity to other active utilities, both above and below grade. The Contractor shall include in his pay item any associated cost for working around other utilities. This shall include any cost for loss in production, temporary supports, temporary bracing and/or the use of trench boxes. The Contractor shall coordinate this work with the other utility as required.

#### 1.3 EXCAVATION REQUIREMENTS

- A. The Contractor shall note that all excavation is unclassified. No separate payment will be made for rock excavation.

### PART 2 - PRODUCTS (Not Applicable)

### PART 3 - EXECUTION (Not Applicable)

END OF SECTION 011410



## SECTION 012213 - BASIS OF MEASUREMENT AND PAYMENT-SEWER

### PART 1 - GENERAL

#### 1.1 SCOPE OF WORK

- A. The Contractor shall furnish all necessary labor, machinery, tools, apparatus, equipment, materials, service and other necessary supplies and perform all work shown on the Drawings and/or described in the specifications and Contract documents at the unit prices for items in the following paragraphs.
- B. The Bidder declares that he has examined the site of the work and informed himself fully in regard to all conditions pertaining to the place where the work is to be done; that he has examined the plans, specification and Contract documents for the work, and has read all special provisions furnished prior to the opening of bids; and that he has further satisfied himself relative to the work to be performed. The Bidder further declares that he understands that unit quantities shown in the Proposal are approximately only, are subject to increase or decrease, and that, should the quantities of any of the items be decreased, the Bidder will make no claim for the anticipated profits. In addition, the Owner also reserves the right to adjust quantities, either by addition or deletion and as-BID unit price shall remain in effect for these quantity adjustments.
- C. All excavation required of the work shall be done as part of the total price for the complete project. All excavation shall be unclassified.
- D. No extra payment will be made for increase in pipe cover from the minimum of 42-inches. It is probable that over excavation will be required to avoid existing utilities and to comply with the proposed earthwork and storm drainage features included in the roadway project, in addition to the notations included on the Drawings.
- E. All work (water and sewer) shall be in accordance with the latest revision of the Kentucky Plumbing code. The Contractor is responsible for all permits, fees, and coordination of work with the State Plumbing Inspector.
- F. The Contractor shall be responsible for removing, hauling, and properly disposing of all excavated materials at no additional cost to the Owner.

#### 1.2 GRAVITY SEWERS

- A. Payment for gravity sewer lines of the different types and sizes will be made at the Contract unit price per linear foot in place, which price will include compensation for furnishing pipe, all trenching (including rock excavation), bedding, laying, jointing, testing, backfilling, surface restoration (except pavement and aggregate surface replacement) connections to new manholes, and all plugs as required. The quantity of sewer to be paid for shall be the length of pipe measured along the centerline of the completed pipeline without deducting the length of branches, fittings and manhole inverts.
- B. Connections of existing sewers to new sewers will be additional and not included under the



scope of this pay item.

- C. Pay depth measurements shall be taken from the contract profile drawings. If a change in alignment or depth is approved in the field, pay depths may then be measured in the field.
- D. The Contractor shall note that all excavation is unclassified. No separate payment will be made for rock excavation.
- E. It should be noted that construction of this item will be performed in close proximity to other active utilities, both above and below grade. The Contractor shall include in his price any additional cost for working around other utilities, such as, coordination with other utilities, locating other utilities by excavation (potholing), trench boxes as needed, supporting, bracing and loss of production. No additional pay will be granted for such items.
- F. Installation and maintenance of any and all temporary erosion and sedimentation control devices and methods as described in the Contract Documents and as required by Local, State and Federal requirements are included under this pay item.

### 1.3 GRAVITY SEWERS WITHIN STEEL ENCASEMENT PIPE

- A. Payment for gravity sewer pipe installed within steel encasement pipe will be paid at the contract unit price per foot complete in place, which price shall include the gravity sewer pipe, material and work for blocking the ends of the encasement pipe, supporting and bracing of the gravity sewer pipe within the steel encasement, and all other items necessary for its construction as shown on the Drawings and/or described in the Specifications.

### 1.4 MANHOLES

- A. Payment for shallow, standard, or special manholes, as described, will be made at the Contract unit price each, complete in place, which price will include the manhole, complete with footing, precast concrete riser sections and cone (or flat slab top), standard watertight manhole frame and cover, inverts, steps, stub outs, excavation (including rock), backfilling, surface restoration (except pavement replacement), and testing.
- B. Note the maximum height for manhole grade rings is 12-inches.
- C. It should be noted that construction of this item will be performed in close proximity to other active utilities, both above and below grade. The Contractor shall include in his price any additional cost for working around other utilities, such as, coordination with other utilities, locating other utilities by excavation (potholing), trench boxes as needed, supporting, bracing and loss of production. No additional pay will be granted for such items.
- D. Contractor shall be responsible for confirming all final grade elevations for manhole rims prior to ordering manholes.

### 1.5 MANHOLE BARREL EXTENSION

- A. For manholes greater than six (6) feet in depth and barrels added to existing manholes, the

additional manhole barrel measured as defined in the Detailed Specifications will be paid for at the Contract unit price per vertical linear foot of additional depth, which price will include the precast concrete barrel sections, water proof seals, excavation (including rock) and backfilling. No separate payment will be made for additional steps that are required. Depth of manhole shall be measured vertically from the top of cast iron frame to the downstream invert.

- B. Note manhole grade rings are not part to this pay item and will not be included in the footage.

#### 1.6 STEEL ENCASEMENT PIPE – OPEN CUT

- A. The steel encasement pipe required to be open cut installed (to the elevations provided) in place, of the sizes indicated on the Drawings, will be measured from end to end of the completed encasement pipe in place and will be paid for at the contract unit price per foot complete in place. Price shall include the encasement pipe laid therein, crushed stone backfill, (flowable fill excluded where required), geotextile fabric material (where required) surface restoration (except pavement replacement) and all other items necessary for its construction as shown on the Drawings and/or described in the Specifications.

#### 1.7 EXISTING STEEL ENCASEMENT PIPE – CARRIER PIPE REMOVAL

- A. The existing concrete carrier pipe to be removed from the existing steel encasement pipe will be paid for the contract lump sum, which will include compensation for complete removal of the existing concrete pipe, bedding material and any other material within the existing steel encasement pipe, and all other items necessary for its construction as shown on the Drawings and/or described in the Specifications.

#### 1.8 PAVEMENT REPLACEMENT FOR HIGHWAYS, STREETS, AND DRIVEWAYS

- A. Paving replacement for bituminous concrete or Portland cement highway, street, and driveway will be paid for at the Contract unit price per linear foot of trench paved, which price will include compensation for furnishing and placing crushed stone trench backfill in accordance with Method "C", furnishing and placing base course for paving, placing the concrete sub-slab (for State Highways or where required by the Contract Documents), and furnishing and laying bituminous concrete surface. No additional payment will be made for paving around manholes.

#### 1.9 CONCRETE FOR CRADLE, ANCHORS, OR ENCASEMENT

- A. Payment for concrete cradles, anchors, or encasement will be made at the Contract unit price per cubic yard, complete in place. Approximate quantity of concrete required for each specific use is noted on the Contract Drawings.

#### 1.10 CRUSHED STONE FOR SPECIAL GRANULAR FILL

- A. Whenever payment shall be deemed due under the provisions of the Detailed Specifications, said material will be paid for at the Contract unit price per ton, furnished and placed as specified. Any installation of Special Granular Fill must be approved by the Engineer. The

Contractor shall furnish the Engineer with duplicate weigh slips for all such material delivered to the project.

1.11 GRAVITY SEWER CONNECTION TO EXISTING MANHOLE

- A. Payment for the installation of gravity sewer to an existing manhole shall be made at the Contract unit price each in-place. This cost will include all labor, material, and equipment to install the gravity sewer through the wall of the existing manhole, patch the manhole wall, remove the apron and invert and construct a new apron and invert in accordance with these plans and detailed specifications. All concrete, pipe, plugs, sealant, etc. shall be considered a part of this pay item.

1.12 ABANDONMENT OF MANHOLES

- A. Payment for abandoning manholes will be made at the contract unit price each, price will include excavation, removal of the **manhole to an minimum of 2 feet the below the proposed subgrade, hauling, disposal and backfilling** with #57 stone backfill to top of remaining structure, and earthen backfill from top of structure to finished grade and surface restoration (except pavement replacement).

1.13 PLUG EXISTING SEWER TO BE ABANDONED

- A. Payment for plugging existing sewers to be abandoned shall be made at the contract unit price each. This cost will include all labor, material, and equipment to install the plug on the existing sewer to be abandoned in accordance with the project plans and specifications.

1.14 SAFE LOADING ABANDONED LINES

- A. Payment for safe loading abandoned lines of all sizes and types of pipes by means of pumping/injecting grout into the existing sewer pipe to assure pipe is full shall be made at the contract unit price per cubic yard, which price shall include all labor, materials, equipment and services necessary for blocking (plugging or capping) the downstream portion of the abandoned pipe (in a manner acceptable to the Engineer), and in accordance KYTC Section 708, of their standard specifications. This includes all excavation (including rock), backfilling (except flowable fill) and surface restoration (except pavement replacement).

1.15 BY-PASS PUMPING

- A. Payment for by-pass pumping will be made at the contract unit price per hour of operation. Any cost associated with pumping set-up operation and temporary plugging of the sewer shall be considered incidental to this item. Any by-pass pumping shall be authorized by the Engineer/Owner.

1.16 PAY ITEMS

- A. The items listed hereinbefore refer to and are the same items listed in the PROPOSAL, and constitute all of the pay items in this Contract. Any other items of work listed in the Specifications or shown on the Drawings shall be considered incidental to the above items.

PART 2 - PRODUCTS (Not Applicable)

PART 3 - EXECUTION (Not Applicable)

END OF SECTION 012213

## SECTION 012500 - PRODUCTS AND SUBSTITUTIONS

### PART 1 - GENERAL

#### 1.1 DESCRIPTION OF REQUIREMENTS

- A. General: Substitution of materials and/or equipment is defined in Paragraph 6.7.1 of the General Conditions and more fully hereinafter.
- B. Definitions: Definitions used in this paragraph are not intended to negate the meaning of other terms used in the Contract Documents including such terms as "specialties", "systems", "structure", "finishes", "accessories", "furnishings", "special construction" and similar terms. Such terms are self-explanatory and have recognized meanings in the construction industry.
  - 1. "Products" are items purchased for incorporation in the Work, regardless of whether they were specifically purchased for the project or taken from the Contractor's previously purchased stock. The term "product" as used herein includes the terms "material", "equipment", "system" and other terms of similar intent.
  - 2. "Named Products" are products identified by use of the manufacturer's name for a product, including such items as a make or model designation, as recorded in published product literature, of the latest issue as of the date of the Contract Documents.
  - 3. "Materials" are products that must be substantially cut, shaped, worked, mixed, finished, refined or otherwise fabricated, processed, or installed to form units of work.
  - 4. "Equipment" is defined as a product with operational parts, regardless of whether motorized or manually operated, and in particular, a product that requires service connections such as wiring or piping.
- C. Substitutions: The Contractor's requests for changes in the products, materials, equipment and methods of construction required by the Contract Documents are considered requests for "substitutions", and are subject to the requirements specified herein. The following are not considered as substitutions:
  - 1. Revisions to the Contract Documents, where requested by the Owner, Engineer are considered as "changes" not substitutions.
  - 2. Substitutions requested during the bidding period, which have been accepted prior to the Contract Date, are included in the Contract Documents and are not subject to the requirements for substitutions as herein specified.
  - 3. Specified Contractor options on products and construction methods included in the Contract Documents are choices available to the Contractor and are not subject to the requirements for substitutions as herein specified.
  - 4. Except as otherwise provided in the Contract Documents, the Contractor's determination of and compliance with governing regulations and orders as issued by governing authorities do not constitute "substitutions" and do not constitute a basis for change orders.
- D. Standards: Refer to Division-01 section "Definitions and Standards" for applicability of industry standards to the products specified for the project, and for acronyms used in the text of the specification sections.

## 1.2 RELATED DOCUMENTS

- A. Drawings and general provisions of Contract, including General and Supplementary Conditions and other Division-01 Specification sections, apply to Work of this Section.

## 1.3 SUBMITTALS

The information required to be furnished for evaluation of product substitution will be as follows:

- A. Performance capabilities, and materials and construction details will be evaluated based upon conformance with the Specifications. Products that do not conform with the Specification shall not be accepted.
- B. Manufacturer's production and service capabilities, and evidence of proven reliability will be acceptable if the following is furnished.
  - 1. Written evidence that the manufacturer has not less than (3) years experience in the design and manufacture of the substitute product.
  - 2. Written evidence of at least one application, of a type and size similar to the proposed substitute product, in successful operation in a wastewater treatment plant for a period of at least one year.
  - 3. In lieu of furnishing evidence of a manufacturer's Experience and successful operation of an application of the product to be substituted, the Contractor has the option of furnishing a cash deposit or bond which will guarantee replacement if the product the furnished does not satisfy the other requirements specified in this section. The amount of each deposit or bond will be subject to the approval.
- C. Specific reference to characteristics either superior or inferior to specified requirements will be evaluated based on their net effect on the project. Products with any characteristics inferior to those specified will not be acceptable unless offset by characteristics that, in the opinion of the Engineer, will cause the overall effect of the product on the project to be at least equal to that of those specified.

## 1.4 QUALITY ASSURANCE

- A. Source Limitations: To the fullest extent possible, provide products of the same generic kind, from a single source, for each unit of work.
- B. Compatibility of Options: Compatibility of products is a basic requirement of product selection. When the Contractor is given the option of selecting between two or more products for use on the project, the product selected must be compatible with other products previously selected, even if the products previously selected were also Contractor options. The complete compatibility between the various choices available to the Contractor is not assured by the various requirements of the Contract Documents, but must be provided by the Contractor.
- C. The detailed estimate of operating and maintenance costs will be evaluated based on comparison with similar data on the specified products. Proposed substitute products which have an operating and maintenance cost that, in the opinion of the Engineer, exceeds that of the specified products will not be considered equal and will not be acceptable.

## 1.5 PRODUCT DELIVERY, STORAGE, AND HANDLING

General: Deliver, store, and handle products in accordance with manufacturer's recommendations, using means and methods that will prevent damage, deterioration and loss, including theft. Control delivery schedules to minimize long-term storage at the site and to prevent overcrowding of construction spaces. In particular coordinate delivery and installation to ensure minimum holding or storage times for items known or recognized to be flammable, hazardous, easily damaged, or sensitive to deterioration, theft and other sources of loss.

- A. Deliver products to the site in the manufacturer's sealed container or other packaging system, complete with labels and instructions for handling, storing, unpacking, protecting and installing.
- B. Store products at the site in a manner that will facilitate inspection and measurement of quantity or counting of units.
- C. Store heavy materials away from the project structure in a manner that will not endanger the supporting construction.

## PART 2 - PRODUCTS

### 2.1 GENERAL PRODUCT COMPLIANCE

A. General: Requirements for individual products are indicated in the Contract Documents; compliance with these requirements is in itself a Contract Requirement. These requirements may be specified in any one of several different specifying methods, or in any combination of these methods. These methods include the following:

- 1. Proprietary.
- 2. Descriptive.
- 3. Performance.
- 4. Compliance with Reference Standards.

Compliance with codes, compliance with graphic details, allowances, and similar provisions of the Contract Documents also have a bearing on the selection process.

B. Procedures for Selecting Products: Contractor's options in selecting products are limited by requirements of the Contract Documents and governing regulations. They are not controlled by industry traditions or procedures experienced by the Contractor on previous construction projects.

### 2.2 SUBSTITUTIONS

A. Conditions: Contractor's request for substitution will be received and considered when extensive revisions to the Contract Documents are not required, when the proposed changes are in keeping with the general intent of the Contract Documents, when the request are timely, fully documented and properly submitted, and when one or more of the following conditions is satisfied, all as judged by the Engineer; otherwise the requests will be returned without action except to record non-compliance with these requirements.

1. The Engineer will consider a request for substitution where the request is directly related to an "or equal" clause or similar language in the Contract Documents.
  2. The Engineer will consider a request for substitution where the specified product or method cannot be provided within the Contract Time. However, the request will not be considered if the product or method cannot be provided as a result of the Contractor's failure to pursue the work promptly or to coordinate the various activities properly.
  3. The Engineer will consider a request for substitution where the specified product or method cannot receive necessary approval by a governing authority, and the requested substitution can be approved.
  4. The Engineer will consider a request for a substitution where a substantial advantage is offered the Owner, in terms of cost, time, energy conservation or other considerations of merit, after deducting offsetting responsibilities the Owner may be required to bear. These additional responsibilities may include such considerations as additional compensation to the Engineer for redesign and evaluation services, the increased cost of other work by the Owner or separate contractors, and similar considerations.
  5. The Engineer will consider a request for substitution when the specified product or method cannot be provided in a manner which is compatible with other materials of the work, and where the Contractor certifies that the substitution will overcome the incompatibility.
  6. The Engineer will consider a request for substitution when the specified product or method cannot be properly coordinated with other materials in the work, and where the Contractor certifies that the proposed substitution can be properly coordinated.
  7. The Engineer will consider a request for substitution when the specified product or method cannot receive a warranty as required by the Contract Documents and where the Contractor certifies that the proposed substitution receive the required warranty.
  8. The Contractor shall reimburse the Owner any costs for review by the Engineer of proposed product substitutions which require major design changes, as determined by the Owner, to related of adjacent work made necessary by the proposed substitutions.
- B. Work-Related Submittals: Contractor's submittal of and the Engineer's acceptance of shop drawings, product data or samples which relate to work not complying with requirements of the Contract Documents, does not constitute an acceptable or valid request for a substitution, nor approval thereof.

### 2.3 GENERAL PRODUCT REQUIREMENTS

- A. General: Provide products that comply with the requirements of the Contract Documents and that are undamaged and, unless otherwise indicated, unused at the time of installation. Provide products that are complete with all accessories, trim, finish, safety guards and other devices and details needed for a complete installation and for the intended use and effect.
1. Standard Products: Where they are available, provide standard products of types that have been produced and used successfully in similar situations on other projects.
  2. Continued Availability: Where, because of the nature of its application, the Owner is likely to need replacement parts or additional amounts of a product at a later date, either for maintenance and repair or replacement, provide standard, domestically produced products for which the manufacturer has published assurances that the products and its parts are likely to be available to the Owner at a later date.



- B. Nameplates: Except as otherwise indicated for required labels and operating data, do not permanently attach or imprint manufacturer's or producer's nameplates or trademarks on exposed surfaces of products which will be exposed to view either in occupied spaces or on the exterior of the completed project.
1. Labels: Locate required product labels and stamps on a concealed surface or, where required for observation after installation, on an accessible surface which, in occupied spaces, is not conspicuous.
  2. Equipment Nameplates: Provide permanent nameplate on each item of service-connected or power operated equipment. Locate the nameplate on an easily accessible surface which is inconspicuous in occupied spaces. The nameplate shall contain the following information and other essential operating data.
    - a. Name of manufacturer
    - b. Name of product
    - c. Model number
    - d. Serial number
    - e. Capacity
    - f. Speed
    - g. Ratings

### PART 3 - EXECUTION

#### 3.1 INSTALLATION OF PRODUCTS

- A. General: Except as otherwise indicated in individual sections of these Specifications, comply with the manufacturer's instructions and recommendations for installation of the products in the applications indicated. Anchor each product securely in place, accurately located and aligned with other work. Clean exposed surfaces and protect surfaces as necessary to ensure freedom from damage and deterioration at Time of Acceptance.

END OF SECTION 012500

## SECTION 013113 - PROJECT COORDINATION

### PART 1 - GENERAL

#### 1.1 DESCRIPTION OF REQUIREMENTS

Minimum administrative and supervisory requirements necessary for coordination of work on the project include but are not necessarily limited to the following:

- A. Coordination and meetings
- B. Limitations for use of site
- C. Coordination of crafts, trades and subcontractors
- D. General installation provisions
- E. Cleaning and protection
- F. Conservation and salvage

#### 1.2 RELATED DOCUMENTS

- A. Drawings and general provisions of Contract, including General and Supplementary Conditions and other Division-1 Specification sections, apply to work of this section.

#### 1.3 COORDINATION AND MEETINGS

- A. Monthly general project coordination meetings will be held at regularly scheduled times convenient for all parties involved. These meetings are in addition to specific meetings held for other purposes, such as regular project meetings and special pre-installation meetings. Representation at each meeting by every party currently involved in coordination or planning for the work of the entire project is requested. Meetings shall be conducted in a manner which will resolve coordination problems. Results of the meeting shall be recorded and copies distributed to everyone in attendance and to others affected by decisions or actions resulting from each meeting.

#### 1.4 LIMITATIONS ON USE OF THE SITE

- A. Limitations on site usage as well as specific requirements that impact site utilization are indicated on the drawings and by other contract documents. In addition to these limitations and requirements, allocation of available space shall be administered equitably among entities needing both access and space so as to produce the best overall efficiency in performance of the total work of the project. Schedule deliveries so as to minimize space and time requirements for storage of materials and equipment on site.

1.5 COORDINATION OF CRAFTS, TRADES AND SUBCONTRACTORS

- A. The Contractor shall coordinate the work of all the crafts, trades and subcontractors engaged on the work, and he shall have final responsibility as regards the schedule, workmanship and completeness of each and all parts of the work.
- B. All crafts, trades and subcontractors shall be made to cooperate with each other and with others as they may be involved in the installation of work which adjoins, incorporates, precedes or follows the work of another. It shall be the Contractor's responsibility to point out areas of cooperation prior to the execution of subcontractor agreements and the assignment of the parts of the work. Each craft, trade and subcontractor shall be made responsible to the Owner, for furnishing embedded items and giving directions, for doing all cutting and fitting and making all provisions for accommodating the work, and for protecting, patching, repairing and cleaning as required to satisfactorily perform the work.
- C. The Contractor shall be responsible for all cutting, digging and other action of his subcontractors and workmen. Where such action impairs the safety or function of any structure or component of the project, the Contractor shall make such repairs, alterations and additions as will, in the opinion of the Engineer, bring said structure or component back to its original design condition at no additional cost to the Owner.
- D. Each subcontractor is expected to be familiar with the General Requirements and all sections of the detailed Specifications for all other trades and to study all Drawings applicable to his work including Architectural and Structural Drawings, to the end that complete coordination between trades will be effected. Consult with the Engineer if conflicts exist on the Drawings.
- E. Special attention shall be given to points where ducts or piping must cross other ducts or piping, where lighting fixtures must be recessed in ceilings and where ducts, piping and conduits must fit into walls and columns. It shall be the responsibility of such subcontractor to leave the necessary room for other trades.
- F. No extra compensation will be allowed to cover the cost of removing piping, conduit, ducts, etc., or equipment found encroaching on space required by others.

PART 2 - PRODUCTS (Not Applicable)

PART 3 - EXECUTION (Not Applicable)

END OF SECTION 013113

## SECTION 013216 - PROGRESS SCHEDULES

### PART 1 - GENERAL

#### 1.1 DESCRIPTION OF REQUIREMENTS

##### A. Scheduling Responsibilities:

1. In order to provide a definitive basis for determining job progress, a construction schedule of a type approved by the Owner will be used to monitor the project.
2. The Contractor shall be responsible for preparing the schedule and updating on a monthly basis. It shall at all times remain the Contractor's responsibility to schedule and direct his forces in a manner that will allow for the completion of the work within the contractual period.

##### B. Construction Hours:

1. No work shall be done between 6:00 p.m. and 7:00 a.m. nor on Saturdays, Sundays or legal holidays without the prior written permission of the Owner. However, emergency work may be done without prior written permission.
2. If the Contractor, for his convenience and at his own expense, should desire to carry on his work at night or outside the regular hours, he shall submit a written request to the Engineer and shall allow nine (9) days for satisfactory arrangements to be made for inspecting the work in progress. If permission is granted, the Contractor shall light the different parts of the project as required to comply with all applicable federal, state, and local regulations. The Contractor shall also revise his schedule as appropriate at the next monthly schedule update meeting to reflect the changes in working hours.

##### C. Progress of the Work:

1. The work shall be started within ten (10) days following the Notice to Proceed and shall be executed with such progress as may be required to prevent delay to other Contractors or to the general completion of the project. The work shall be executed at such times and in or on such parts of the project, and with such forces, material and equipment, to assure completion of the work in the time established by the Contract.
2. The Contractor agrees that whenever it becomes apparent from the current monthly schedule update that delays have resulted and, hence, that the Contract completion date will not be met or when so directed by the Owner, he will take some or all of the following actions at no additional cost to the Owner:
  - a. Increase construction manpower in such quantities and crafts as will substantially eliminate the backlog of work.
  - b. Increase the number of working hours per shift, shifts per working day or days per week, the amount of construction equipment, or any combination of the foregoing to substantially eliminate the backlog of work.
  - c. Reschedule activities to achieve maximum practical concurrency of accomplishment of activities, and comply with the revised schedule.
  - d. The Contractor shall submit to the Owner or the Owner's representative for review a written statement of the steps he intends to take to remove or arrest the delay to

the critical path in the accepted schedule. If the Contractor should fail to submit a written statement of the steps he intends to take or should fail to take such steps as required by the Contract, the Owner may direct the level of effort in manpower (trades), equipment, and work schedule (overtime, weekend and holiday work, etc.), to be employed by the Contractor in order to remove or arrest the delay to the critical path in the accepted schedule, and Contractor shall promptly provide such level of effort at no additional cost to the Owner.

## 1.2 CONSTRUCTION SCHEDULE

- A. Within ten (10) calendar days of the Notice to Proceed, the Contractor shall submit to the Engineer five (5) copies of his proposed schedule. The schedule will be the subject of a schedule review meeting with the Contractor, the Engineer and the Owner or the Owner's representative within one (1) week of its submission. The Contractor will revise and resubmit the schedule until it is acceptable and accepted by the Owner or the Owner's representative.

## 1.3 SUBMITTAL SCHEDULE

- A. In addition to the above scheduling requirements, the Contractor will be required to submit a complete and detailed listing of anticipated submittals during the course of the Contract. The Contractor will coordinate his submittals with those of his Subcontractors and Suppliers and will identify each submittal by Contract drawing number and specification number. The anticipated submission date for each submittal must be indicated along with the date on which its return is anticipated. For planning purposes, the Engineer will usually return shop drawings thirty (30) days after receipt. However, longer durations for review will not be considered a basis for a claim.
- B. The Submittal Schedule must be submitted within twenty (20) working days of the Notice to Proceed and will be the subject of a special meeting with the Engineer and the Owner or the Owner's representative within one (1) week of the schedule's submission. At that meeting, the Submittal Schedule will be reviewed for comprehensiveness and feasibility. The Engineer will adjust the projected return dates based on the need for more or less time for each submittal's review. The Submittal Schedule will then be accepted or revised as required.

## 1.4 SCHEDULE UPDATES

- A. Monthly Meetings:
  - 1. A monthly Schedule Update Meeting will be held in conjunction with the applicable progress meeting at the construction site to review and update the Schedule. The Schedule Update Meetings will be chaired by the Owner or the Owner's representative and attended by the Contractor and the Engineer. Actual progress of the previous month will be recorded and future activities will be reviewed. The duration of activities and their logical connections may be revised as needed. Decisions made at these meetings and agreed to by all parties are binding with the exception that no contractual completion dates will be modified without formal written requests and acceptance as specified herein.

B. Revisions to Schedule:

1. The Schedule shall be formally revised if any of the following conditions are encountered:
  - a. When a delay in completion of any work item or sequence of work items results in an indicated extension of the project completion.
  - b. When delays in submittals or deliveries or work stoppages are encountered which make replanning or rescheduling of the work necessary.
  - c. When the schedule does not represent the actual prosecution and progress of the project.

1.5 CONTRACT COMPLETION TIME

A. Causes for Extensions:

1. The Contract completion time will be adjusted only for causes specified in this Contract. In the event the Contractor requests an extension of any Contract completion date, he shall furnish such justification and supporting evidence as the Owner or the Owner's representative may deem necessary for a determination as to whether the Contractor is entitled to an extension of time under the provisions of this Contract. The Owner, with the assistance of the Engineer, will, after receipt of such justification and supporting evidence, make findings of fact and will advise the Contractor in writing thereof.

B. Requests for Time Extension:

1. Each request for change in any Contract completion date shall be initially submitted to the Owner within the time frame stated in the General Conditions. All information known to the Contractor at that time concerning the nature and extent of the delay shall be transmitted to the Owner at that time. Within the time frame stated in the General Conditions but before the date of final payment under this Contract, all information as required above concerning the delay must be submitted to the Owner. No time extension will be granted for requests which are not submitted within the foregoing time limits.

PART 2 - PRODUCTS (Not Applicable)

PART 3 - EXECUTION (Not Applicable)

END OF SECTION 013216

SECTION 013323 - SHOP DRAWINGS, PRODUCT DATA, SAMPLES AND RFI'S

PART 1 - GENERAL

1.1 DESCRIPTION OF REQUIREMENTS

- A. General: This section specifies procedural requirements for non- administrative submittals including shop drawings, product data, samples (when samples are specifically requested) and other miscellaneous work-related submittals. Shop drawings, product data, samples and other work-related submittals are required to amplify, expand and coordinate the information contained in the Contract Documents.
- B. Refer to other Division-01 sections and other Contract Documents for Specifications on administrative, non-work-related submittals. Such submittals include, but are not limited to the following items:
  - 1. Permits.
  - 2. Payment applications.
  - 3. Performance and payment bonds.
  - 4. Insurance certificates.
  - 5. Inspection and test reports.
  - 6. Schedule of values.
  - 7. Progress reports.
  - 8. Listing of subcontractors.
  - 9. Operating and Maintenance Manuals
- C. Engineer prefers initial submittals be in electronic media along with one paper copy for review. Engineer utilizes Newforma software and will provide Contractor with the necessary links and instructions for submittal purposes. Upon completion of the review process, Contractor shall print two (2) copies of complete submittal, including transmittal cover page and stamp page, and deliver to Engineer.

If Contractor does not have capability to submit electronic submittals, then Contractor shall submit a request to Engineer for waiver. In the event a waiver is granted, paper submittals shall be provided as directed by the Engineer.
- D. Submittals shall be checked and reviewed by the Contractor and stamped with Contractor's review stamp before submission to the Engineer. The review of the submittals by the Engineer shall not be construed as a complete check but will indicate only that the general method of construction and detailing is satisfactory. Review of such submittals will not relieve the Contractor of the responsibility for any errors which may exist as the Contractor shall be responsible for the dimensions and design of adequate connections, details, and satisfactory construction of all work.
- E. All Requests for Information (RFI) to Engineer shall be submitted electronically via Engineer's Newforma software.

1.2 RELATED DOCUMENTS

- A. Drawings and general provisions of Contract, including General and Supplementary Conditions and other Division-01 Specification sections, apply to work of this section.
- B. Section 017823 - Operating and Maintenance Manuals.

1.3 DEFINITIONS

- A. Shop drawings are technical drawings and data that have been specially prepared for this project, including but not limited to the following items:

- 1. Fabrication and installation drawings.
- 2. Setting diagrams.
- 3. Shopwork manufacturing instructions.
- 4. Templates.
- 5. Patterns.
- 6. Coordination drawings (for use on site).
- 7. Schedules.
- 8. Design mix formulas.
- 9. Contractor's engineering calculations.

Standard information prepared without specific reference to a project is not considered to be shop drawings.

- B. Product data includes standard printed information on manufactured products that has not been specially-prepared for this project, including but not limited to the following items:

- 1. Manufacturer's product specifications and installation instructions.
- 2. Standard color charts.
- 3. Catalog cuts.
- 4. Roughing-in diagram and templates.
- 5. Standard wiring diagrams.
- 6. Printed performance curves.
- 7. Operational range diagrams.
- 8. Mill reports.
- 9. Standard product operating and maintenance manuals.

- C. Samples, where specifically required, are physical examples of work, including but not limited to the following items:

- 1. Partial sections of manufactured or fabricated work.
- 2. Small cuts or containers of materials.
- 3. Complete units of repetitively-used materials.
- 4. Swatches showing color, texture and pattern.
- 5. Color range sets.
- 6. Units of work to be used for independent inspection and testing.

- D. Miscellaneous submittals are work-related, non-administrative submittals that do not fit in the three previous categories, including, but not limited to the following:



1. Specially-prepared and standard printed warranties.
2. Maintenance agreements.
3. Workmanship bonds.
4. Survey data and reports.
5. Testing and certification reports.
6. Record drawings.
7. Field measurement data.

#### 1.4 SUBMITTAL PROCEDURES

- A. General: Refer to the General Conditions and Paragraph 1.1 hereinbefore for basic requirements for submittal handling.
- B. Coordination: Coordinate the preparation and processing of submittals with the performance of the work. Coordinate each separate submittal with other submittals and related activities such as testing, purchasing, fabrication, delivery and similar activities that require sequential activity.
  1. It is the Contractor's responsibility to make such field measurements as are needed to base submittals on actual field conditions to assure proper connection, fit, function and performance of all work and equipment in the execution of the contract work.
  2. Coordinate the submittal of different units of interrelated work so that one submittal will not be delayed by the Architect/Engineer's need to review a related submittal. The Architect/Engineer reserves the right to withhold action on any submittal requiring coordination with other submittals until related submittals are forthcoming.
- C. Coordination of Submittal Times: Prepare and transmit each submittal to the Architect/Engineer sufficiently in advance of the scheduled performance of related work and other applicable activities. Transmit different kinds of submittals for the same unit of work so that processing will not be delayed by the Architect/Engineer's need to review submittals concurrently for coordination.
- D. Review Time: Allow sufficient time so that the installation will not be delayed as a result of the time required to properly process submittals, including time for resubmittal, if necessary. Advise the Architect/Engineer on each submittal, as to whether processing time is critical to the progress of the work and if the work would be expedited if processing time could be shortened.
  1. Allow a longer time period where processing must be delayed for coordination with subsequent submittals. The Architect/Engineer will advise the Contractor promptly when it is determined that a submittal being processed must be delayed for coordination.
  2. No extension of time will be authorized because of the Contractor's failure to transmit submittals to the Architect/Engineer sufficiently in advance of the work.
- E. Submittal Preparation: Mark each submittal with a permanent label for identification. Provide the following information on the label for proper processing and recording of action taken.
  1. Project name.
  2. Date.
  3. Name and address of Architect/Engineer.
  4. Name and address of Contractor.
  5. Name and address of subcontractor.

6. Name and address of supplier.
  7. Name of manufacturer.
  8. Number and title of appropriate specification section.
  9. Drawing number and detail references, as appropriate.
  10. Similar definitive information as necessary.
- F. All submittals shall be referenced to the applicable item, section and division of the Specifications, and to the applicable drawing(s) or drawing schedule(s). Include only one item in a submittal.
- G. The Contractor shall review and check submittals, and shall indicate his review by initials and date. Any submittal received without this evidence of review shall be returned to the Contractor without review.
- H. If the submittals deviate from the Contract Drawings and/or Specifications, the Contractor shall advise the Engineer in writing of the deviation and the reasons therefore.
- I. Submittal Transmittal: Package each submittal appropriately for transmittal and handling. Transmit each submittal from the Contractor to the Architect/Engineer, and to other destinations as indicated, by use of a transmittal form. Submittals received from sources other than the Contractor will be returned to the sender "without action".
- J. Electronic Submittals: If the electronic method of submittals is agreed to by Contractor, Engineer, and Owner, the format and procedures will be determined and implemented prior to any submittals. Submittals will be processed through "Newforma" software. Each item of the submittal documents shall be in .pdf format and shall be oriented so that they are read from upper left corner to lower right corner, with no rotation of said document being required after receiving it. The .pdf file shall be named so that it describes the item being submitted. All other requirements herein are part of the electronic submittal process with the exception of the duplicate copies. Contractor stamp indicating review and any comments or notes must be on the .pdf submittal.

#### 1.5 SPECIFIC SUBMITTAL REQUIREMENTS

- A. Shop drawings shall be prepared by a qualified detailer. Details shall be identified by reference to sheet and detail numbers shown on Contract Drawings. Where applicable, show fabrication, layout, setting and erection details.

Shop drawings are defined as original drawings prepared by the Contractor, subcontractors, suppliers, or distributors performing work under this Contract. Shop drawings illustrate some portion of the work and show fabrication, layout, setting or erection details of equipment, materials and components. The Contractor shall, except as otherwise noted, have prepared the number of reviewed copies required for his distribution plus four (4) which will be retained by the Engineer. Shop drawings shall be folded to an approximate size of 8-1/2" x 11" and in such manner that the title block will be located in the lower right-hand corner of the exposed surface.

- B. Project data shall include manufacturer's standard schematic drawings modified to delete information which is not applicable to the project, and shall be supplemented to provide additional information applicable to the project. Each copy of descriptive literature shall be clearly marked to identify pertinent information as it applies to the project.

- C. Where samples are required, they shall be adequate to illustrate materials, equipment or workmanship, and to establish standards by which completed work is judged. Provide sufficient size and quantity to clearly illustrate functional characteristics of product and material, with integrally related parts and attachment devices, along with a full range of color samples.
  - D. In the event the Engineer does not specifically reject the use of material or equipment at variance to that which is shown on the Drawings or specified, the Contractor shall, at no additional expense to the Owner, and using methods reviewed by the Engineer, make any changes to structures, piping, controls, electrical work, mechanical work, etc., that may be necessary to accommodate this equipment or material. Should equipment other than that on which design drawings are based be accepted by the Engineer, shop drawings shall be submitted detailing all modification work and equipment changes made necessary by the substituted item.
  - E. Additional information on particular items, such as special drawings, schedules, calculations, performance curves, and material details, shall be provided when specifically requested in the technical Specifications.
  - F. Submittals for all electrically operated items (including instrumentation and controls) shall include complete size, color coding, all terminations and connections, and coordination with related equipment.
  - G. Equipment shop drawings shall indicate all factory or shop paint coatings applied by suppliers, manufacturers and fabricators; the Contractor shall be responsible for insuring the compatibility of such coatings with the field-applied paint products and systems.
  - H. Fastener specifications of manufacturer shall be indicated on equipment shop drawings.
  - I. Where manufacturer's brand names are given in the Specifications for building and construction materials and products, such as grout, bonding compounds, curing compounds, masonry cleaners, waterproofing solutions and similar products, the Contractor shall submit names and descriptive literature of such materials and products he proposes to use in this Contract.
  - J. No material shall be fabricated or shipped unless the applicable drawings or submittals have been reviewed by the Engineer and returned to the Contractor.
  - K. All bulletins, brochures, instructions, parts lists, and warranties package with and accompanying materials and products delivered to and installed in the project shall be saved and transmitted to the Owner through the Engineer.
- 1.6 REVIEW STATUS
- A. Submittals will be returned, stamped with the following classifications: "Reviewed", "Furnish as Corrected", "Revise and Resubmit", "Rejected", or "Submit Specified Item".
  - B. In some instances, corrections to dimensions or clarification notations will be required, in which case the drawings will be marked "Furnish as Corrected." These shop drawings will not be required to be resubmitted for further approval. If the supplier makes additional modifications after receiving a "Furnish as Corrected" disposition, the drawings must then be resubmitted for review.

- C. If the shop drawing is returned with the notation "Revise and Resubmit", the Contractor shall promptly make the revisions indicated and repeat the submittal approval procedure.
- D. If the shop drawing is returned with the notation "Submit Specified Item", this indicates that the submittal does not meet the specification, will not be reviewed, and is unacceptable. Upon return of a drawing so marked, the Contractor shall repeat the initial approval procedure, submitting acceptable materials or equipment.
- E. The "Rejected" notation is used to indicate materials or equipment that are not acceptable and are not included in the project.

#### 1.7 REMINDER OF CONTRACTOR RESPONSIBILITIES

- A. Verify field measurements, field construction criteria, catalog numbers, and similar data.
- B. Coordinate each submittal with requirements of work and of Contract Documents.
- C. Notify Engineer, in writing at time of submission, of deviations in submittals from requirements of Contract Documents.
- D. Begin no work, and have no material or products fabricated or shipped which requires submittals until return of submittals with Engineer's stamp and initials or signature indicating review.
- E. Upon review and close-out of a submittal, Contractor shall print two (2) copies of complete submittal, including transmittal cover page and stamp page, and deliver to Engineer.
- F. It is emphasized that the review of shop drawings by the Engineer is for general conformance to the Contract Drawings and Specifications, but subject to the detailed requirements of the Contract Drawings and Specifications. Although the Engineer may check submitted data in more or less detail, such checking is an effort to discover errors and omissions in the Contractor's drawings and to assist the Contractor in coordinating and expediting his work, but shall in no way relieve the Contractor of his obligation and responsibility to properly coordinate the work, and to Engineer the details of the work in such a manner, that the purpose and intent of the Contract will be achieved nor shall any such detailed checking by the Engineer be construed as placing on him or on the Owner, any responsibility for the accuracy, proper fit, functioning or performance of any phase of the work included in this Contract. The Contractor is responsible for confirmation and correlation of dimensions at the job site; for information that pertains solely to the fabrication processes or to the techniques of construction; for the coordination of the work of all trades; and for performance of his work in a safe and satisfactory manner.

PART 2 - PRODUCTS (Not Applicable)

PART 3 - EXECUTION (Not Applicable)

END OF SECTION 013323

## SECTION 014216 - DEFINITIONS AND STANDARDS – SHORT FORM

### PART 1 - GENERAL

#### 1.1 DESCRIPTION OF REQUIREMENTS

- A. This section specifies procedural and administrative requirements for compliance with governing regulations and codes and standards imposed upon the Work. These requirements include obtaining permits, licenses, inspections, releases and similar documentation, as well as payments, statements and similar requirements associated with regulations, codes and standards.
- B. The term, "Regulations", is defined to include laws, statutes, ordinances and lawful orders issued by governing authorities, as well as those rules, conventions and agreements within the construction industry which effectively control the performance of the Work regardless of whether they are lawfully imposed by governing authority or not.

#### 1.2 RELATED DOCUMENTS

- A. Drawings and general provisions of Contract, including General and Supplementary Conditions and other Division-01 Specification Sections, apply to Work of this Section.

#### 1.3 DEFINITIONS

A substantial amount of specification language consists of definitions of terms found in other Contract Documents, including Drawings. (Drawings are recognized as being diagrammatic in nature and not completely descriptive of the requirements indicated thereon). Certain terms used in Contract Documents are defined in this article. Definitions and explanations contained in this section are not necessarily either complete or exclusive, but are general for the Work to the extent that they are not stated more explicitly in another element of the Contract Documents.

The provisions or requirements of other Division-01 sections apply to entire Work of the Contract and, where so indicated, to other elements which are included in the Project.

- A. Indicated: The term, "indicated", is a cross-reference to graphic representations, notes or schedules on the Drawings, to other paragraphs or schedules in the Specifications, and to similar means of recording requirements in Contract Documents. Where terms such as "shown", "noted", "scheduled", and "specified" are used in lieu of "indicated", it is for the purpose of helping the reader locate the cross-reference, and no limitation of location is intended except as specifically noted.
- B. Directed, Requested, Etc.: Where not otherwise explained, terms such as "directed", "requested", "authorized", "selected", "approved", "required", "accepted", and "permitted" mean "directed by the Architect/ Engineer", "requested by the Architect/ Engineer", and similar phrases. However, no such implied meaning will be interpreted to extend the Architect's/Engineer's responsibility into the Contractor's area of construction supervision.

- C. Approve: Where used in conjunction with the Architect's/Engineer's response to submittals, requests, applications, inquiries, reports and claims by the Contractor, the meaning of the term "approved" will be held to limitations of the Architect's/Engineer's responsibilities and duties as specified in General and Supplementary Conditions. In no case will the Architect/Engineer's approval be interpreted as a release of the Contractor from responsibilities to fulfill requirements of Contract Documents.
- D. Project Site: The term, "project site", is defined as the space available to the Contractor for performance of the Work, either exclusively or in conjunction with others performing other work as part of the Project. The extent of the Project site is shown on the Drawings, and may or may not be identical with the description of the land upon which the Project is to be built.
- E. Furnish: Except as otherwise defined in greater detail, the term "furnish" is used to mean "supply and deliver to the project site, ready for unloading, unpacking, assembly, installation, and similar operations" as applicable in each instance.
- F. Install: Except as otherwise defined in greater detail, the term "install" is used to describe operations at project site including the actual "unloading, unpacking, assembly, erection, placing, anchoring, applying, working to dimension, finishing, curing protecting, cleaning and similar operations", as applicable in each instance.
- G. Provide: Except as otherwise defined in greater detail, the term "provide" means "to furnish and install, complete and ready for intended use", as applicable in each instance.
- H. Installer: The term "installer" is defined as "the entity" (person or firm) engaged by the Contractor, its subcontractor or sub-subcontractor for performance of a particular unit of work at the project site, including installation, erection, application and similar required operations. It is a requirement that installers are experienced in the operations they are engaged to perform.
- I. Testing Laboratories: The term "testing laboratory" is defined as an independent entity engaged to perform specific inspections or tests of the Work, either at the project site or elsewhere, and to report, and (if required) interpret results of those inspections or tests.

#### 1.4 INDUSTRY STANDARDS

- A. Applicability of Standards: Except where more explicit or more stringent requirements are written into the Contract Documents, applicable construction industry standards have the same force and effect as if bound into or copied directly into the Contract Documents. Such industry standards are made a part of the Contract Documents by reference. Individual specification sections indicate which codes and standards the Contractor must keep available at the project site for reference.
  - 1. Referenced standards (standards referenced directly in the Contract Documents) take precedence over non-referenced standards that are recognized in the industry for applicability to the Work.
  - 2. Non-referenced standards are defined as not being applicable to the Work, except as a general requirement of whether the Work complies with recognized construction industry standards.

- B. Publication Dates: Except as otherwise indicated, where compliance with an industry standard is required, comply with standard in effect as of date of Contract Documents.
- C. Conflicting Requirements: Where compliance with two (2) or more standards is specified, and where these standards establish different or conflicting requirements for minimum quantities or quality levels, the most stringent requirement will be enforced, unless the Contract Documents specifically indicate a less stringent requirement. Refer requirements that are different, but apparently equal, and uncertainties as to which quality level is more stringent to the Architect/Engineer for a decision before proceeding.
  - 1. Minimum Quantities or Quality Levels: In every instance the quantity or quality level shown or specified is intended to be the minimum for the work to be provided or performed. Unless otherwise indicated, the actual work may either comply exactly, within specified tolerances, with the minimum quantity or quality specified, or may exceed that minimum within reasonable limits. In complying with these requirements, the indicated numeric values are either minimum or maximum values, as notes, or as appropriate for the context of the requirements. Refer instances of uncertainty to the Architect/Engineer for decision before proceeding.
- D. Copies of Standards: The Contract Documents require that each entity performing work be experienced in that part of the Work being performed. Each entity is also required to be familiar with industry standards applicable to that part of the work. Copies of applicable standards are not bound with the Contract Documents.
  - 1. Where copies of standards are needed for proper performance of the Work, the Contractor is required to obtain such copies directly from the publication source.
  - 2. Although certain copies of standards needed for enforcement of the requirements may be required submittals, the Architect/ Engineer reserves the right to require the Contractor to submit additional copies of these standards as necessary for enforcement of the requirements.

#### 1.5 SUBMITTALS

- A. Permits, Licenses, and Certificates: For the Owner's records, submit copies of permits, licenses, certifications, inspection reports, releases, jurisdictional settlements, notices, receipts for fee payments, and similar documents, correspondence and records established in conjunction with compliance with standards and regulations bearing upon performance of the work.

PART 2 - PRODUCTS (Not Applicable)

PART 3 - EXECUTION (Not Applicable)

END OF SECTION 014216



SECTION 014500 - QUALITY CONTROL SERVICES – LINE PROJECT

PART 1 - GENERAL

1.1 DESCRIPTION OF REQUIREMENTS

- A. Required inspection and testing services are intended to assist in the determination of probable compliance of the Work with requirements specified or indicated. These required services do not relieve the Contractor of responsibility for compliance with these requirements or for compliance with requirements of the Contract Documents.
- B. Tests, inspections and certifications of materials, equipment, subcontractors or completed Work, as required by the various sections of the Specifications shall be obtained by the Contractor and all costs shall be included in the Contract Price.
- C. The Contractor shall submit to the Engineer the name of any testing laboratory to be used.
- D. Contractor shall deliver written notice to the Engineer at least 24 hours in advance of any inspections or tests to be made at the project site. All inspections or tests to be conducted at the field shall be done in the presence of the Engineer or his representative.
- E. Certifications by independent testing laboratories may be by copy of the attest and shall give scientific procedures and results of tests. Certifications by persons having interest in the matter shall be by original attest properly sworn to and notarized.
- F. Inspections, tests and related actions specified in this section and elsewhere in the Contract Documents are not intended to limit the Contractor's own quality control procedures which facilitate overall compliance with requirements of the Contract Documents.

1.2 RELATED DOCUMENTS

- A. Drawings and general provisions of Contract, including General and Supplementary Conditions and other Division-01 Specification sections, apply to Work of this Section.

1.3 SUBMITTALS

- A. General: Refer to Section 013323 for the general requirements on submittals. Submit a certified written report of each inspection, test or similar service, directly to the Architect/Engineer.
- B. Report Data: Written reports of each inspection, test or similar service shall include, but not be limited to the following:
  - 1. Name of testing agency or test laboratory.
  - 2. Dates and locations of samples and tests or inspections.
  - 3. Names of individuals making the inspection or test.
  - 4. Designation of the work and test method.
  - 5. Complete inspection or test data.



6. Test results.
7. Interpretations of test results.
8. Notation of significant ambient conditions at the time of sample-taking and testing.
9. Comments or professional opinion as to whether inspected or tested work complies with requirements of the Contract Documents.
10. Recommendations on retesting, if applicable.

#### 1.4 RESPONSIBILITIES

- A. Contractor Responsibilities: Except where they are specifically indicated as being the Owner's responsibility, or where they are to be provided by another identified entity, inspections, tests and similar quality control services are the Contractor's responsibility; these services also include those specified to be performed by an independent agency and not directly by the Contractor. Costs for these services shall be included in the Contract Sum. The Contractor shall employ and pay an independent agency, testing laboratory or other qualified firm to perform quality control services specified.
- B. Retest Responsibility: Where results of required inspections, tests or similar services prove unsatisfactory and do not indicate compliance of related Work with the requirements of the Contract Documents, then retests are the responsibility of the Contractor, regardless of whether the original test was the Contractor's responsibility. Retesting of work revised or replaced by the Contractor is the Contractor's responsibility, where required tests were performed on original Work.
- C. Responsibility for Associated Services: The Contractor is required to cooperate with the independent performing required inspections, tests and similar services. Provide such auxiliary services as are reasonably requested. Notify the testing agency sufficiently in advance of operations to permit assignment of personnel. These auxiliary services include but are not necessarily limited to the following:
  1. Providing access to the work.
  2. Taking samples or assistance with taking samples.
  3. Delivery of Samples to test laboratories.
  4. Delivery and protection of samples and test equipment at the project site.
- D. Coordination: The Contractor and each independent agency engaged to perform inspections, tests and similar services for the project shall coordinate the sequence of their activities so as to accommodate required services with a minimum of delay in the progress of the Work. In addition, the Contractor and each independent testing agency shall coordinate their Work so as to avoid the necessity of removing and replacing Work to accommodate inspections and tests. The Contractor is responsible for scheduling times for inspections, tests, taking of samples and similar activities.

#### PART 2 - PRODUCTS (Not Applicable)

### PART 3 - EXECUTION

#### 3.1 REPAIR AND PROTECTION

- A. Upon completion of inspection, testing, sample taking and similar services performed on the Work, repair damaged work and restore substrates and finishes to eliminate deficiencies, including deficiencies in the visual qualities of exposed finishes. Comply with the Contract Document requirements for "Cutting and Patching". Protect Work exposed by or for quality control service activities, and protect repaired work. Repair and protection is the Contractor's responsibility, regardless of the assignment of responsibility for inspection, testing or similar services.

END OF SECTION 014500

## SECTION 017329 - CUTTING AND PATCHING

### PART 1 - GENERAL

#### 1.1 DESCRIPTION OF REQUIREMENTS

- A. Definition: "Cutting and patching" includes cutting into existing construction to provide for the installation or performance of other Work and subsequent fitting and patching required to restore surfaces to their original condition.
- B. Cutting and patching" is performed for coordination of the work, to uncover work for access or inspection, to obtain samples for testing, to permit alterations to be performed or for other similar purposes upon written instructions of the Engineer.
- C. Cutting and patching is performed during the manufacture of products, or during the initial fabrication. Erection or installation processes are not considered to be "cutting and patching" under this definition. Drilling of holes to install fasteners and similar operations are also not considered to be "cutting and patching".
- D. "Cutting and Patching" includes removal and replacement of Work not conforming to requirements of the Contract Documents, removal and replacement of defective Work, and uncovering Work to provide for installation of ill-timed Work.
- E. No Work shall be endangered by cutting or altering Work or any part of it.

#### 1.2 RELATED DOCUMENTS

- A. Drawing and general provisions of Contract, including General and Supplementary Conditions and other Division-1 Specification sections, apply to Work of this Section.

#### 1.3 SUBMITTALS

- A. Prior to cutting which affects structural safety of Project, submit written notice to the Engineer, requesting consent to proceed with cutting, including:
  - 1. Identification of Project.
  - 2. Description of affected work.
  - 3. Necessity for cutting.
  - 4. Effect on structural integrity of Project.
  - 5. Description of proposed work. Designate:
    - a. Scope of cutting and patching.
    - b. Trades to execute work.
    - c. Products proposed to be used.
    - d. Extent of refinishing.
  - 6. Alternatives to cutting and patching.

- B. Should conditions of work, or schedule, indicate change of materials or methods, submit written recommendation to the Engineer, including:
  - 1. Conditions indicating change.
  - 2. Recommendations for alternative materials or methods.
  - 3. Submittals as required for Substitutions.
- C. Submit written notice to the Engineer, designating time Work will be uncovered, to provide for observation.

#### 1.4 QUALITY ASSURANCE

- A. Requirements for Structural Work: Do not cut and patch structural Work in a manner that would result in a reduction of load-carrying capacity or of load-deflection ratio.
- B. Operational and Safety Limitations: Do not cut and patch operational elements or safety related components in a manner that would result in a reduction of their capacity to perform in the manner intended, including energy performance, or that would result in increased maintenance, or decreased operational life or decreased energy.

### PART 2 - PRODUCTS

#### 2.1 MATERIALS

- A. For replacement of work removed, comply with Specifications for type of work to be done.

### PART 3 - EXECUTION

#### 3.1 INSPECTION

- A. Before cutting, examine the surfaces to be cut and patched and the conditions under which the Work is to be performed. If unsafe or otherwise unsatisfactory conditions are encountered, take corrective action before proceeding with the Work.
- B. After uncovering Work, inspect the condition affecting the installation of products, or performance of the work.
- C. Report unsatisfactory or questionable conditions to Engineer in writing, do not proceed with the Work until the Engineer has provided further instructions.

#### 3.2 PREPARATION

- A. Temporary Support: To prevent failure, provide temporary support of Work to be cut. Provide shoring, bracing and support as required to maintain structural integrity of project.

- B. Protection: Protect other Work during cutting and patching to prevent damage. Provide protection from adverse weather conditions for that part of the project that may be exposed during cutting and patching operations. Avoid interference with use of adjoining areas or interruption of free passage to adjoining areas. Take precautions not to cut existing pipe, conduit or duct serving the building but scheduled to be relocated until provisions have been made to bypass them.

### 3.3 PERFORMANCE

- A. General: Employ skilled workmen to perform cutting and patching Work. Except as otherwise indicated or as approved by the Engineer, proceed with cutting and patching at the earliest feasible time and complete Work without delay.
- B. Cutting: Cut the Work using methods that are least likely to damage work to be retained or adjoining Work. Where possible, review proposed procedures with the original installer; comply with original installer's recommendations.
  - 1. In general, where cutting is required use hand or small power tools designed for sawing or grinding, not hammering and chopping. Cut through concrete and masonry using a cutting machine such as a carborundum saw or core drill to insure a neat hole. Cut holes and slots neatly to size required with minimum disturbance of adjacent work. To avoid marring existing finished surfaces, cut or drill from the exposed or finished side into concealed surfaces. Temporarily cover openings when not in use.
  - 2. Comply with requirements of applicable sections of Division 2 where cutting and patching requires excavating and backfilling.
  - 3. By-pass utility services such as pipe and conduit, before cutting, where such utility services are shown or required to be removed, relocated or abandoned. Cut-off conduit and pipe in wall or partitions to be removed. After by-pass and cutting, cap, valve or plug and seal tight remaining portion of pipe and conduit to prevent entrance of moisture or other foreign matter.
- C. Patching: Patch with seams which are durable and as invisible as possible. Comply with specified tolerances for the Work.
  - 1. Where feasible, inspect and test patched areas to demonstrate integrity of work.
  - 2. Restore exposed finishes of patched areas and where necessary, extend finish restoration into retained adjoining Work in a manner which will eliminate evidence of patching and refinishing.
  - 3. Execute fittings and adjustment of products to provide finished installations to comply with specified tolerances.
  - 4. Restore work which has been cut or removed; install new products to provide completed work in accord with requirements of Contract Documents.
  - 5. Refinish entire surfaces as necessary to provide an even finish.
    - a. Continuous Surfaces: To nearest intersection.
    - b. Assembly: Entire refinishing.

3.4 CLEANING

- A. Thoroughly clean areas and spaces where Work is performed or used as access to work. Remove completely point, mortar, oils, putty and items of similar nature. Thoroughly clean piping, conduit and similar features before painting or other finishing is applied. Restore damaged pipe covering to its original condition.

END OF SECTION 017329

## SECTION 017400 - CLEANING

### PART 1 - GENERAL

#### 1.1 DESCRIPTION OF REQUIREMENTS

- A. Maintain premises free from accumulations of waste, debris, and rubbish.
- B. At completion of work, remove waste materials, rubbish, tools, equipment, machinery and surplus materials, and clean all exposed surfaces. Leave project clean and ready for occupancy.

#### 1.2 RELATED DOCUMENTS

- A. Cutting and Patching: Section 017329.
- B. Project Closeout: Section 017700.
- C. Cleaning for Specific Products of Work: Specification Section for that work.

#### 1.3 SAFETY REQUIREMENTS

- A. Hazards Control:
  - 1. Store volatile wastes in covered metal containers, and remove from premises daily.
  - 2. Prevent accumulation of wastes which create hazardous conditions.
  - 3. Provide adequate ventilation during use of volatile noxious substances.
- B. Conduct cleaning and disposal operations to comply with local ordinances and anti-pollution laws.
  - 1. Do not burn or bury rubbish and waste materials on project site.
  - 2. Do not dispose of volatile wastes such as mineral spirits, oil, or paint thinner in storm or sanitary drains.
  - 3. Do not dispose of wastes into streams or waterways.

### PART 2 - PRODUCTS

#### 2.1 MATERIALS

- A. Use only cleaning materials recommended by manufacturer of surface to be cleaned.
- B. Use cleaning materials only on surfaces recommended by cleaning material manufacturer.

### PART 3 - EXECUTION

#### 3.1 DURING CONSTRUCTION

- A. Execute cleaning to ensure that building, grounds, and public properties are maintained free from accumulations of waste materials and rubbish.
- B. Wet down dry materials and rubbish to lay dust and prevent blowing dust.
- C. At reasonable intervals during progress of work, clean site and public properties, and dispose of waste materials, debris and rubbish.
- D. Provide on-site containers for collection of waste materials, debris and rubbish.
- E. Remove waste materials, debris and rubbish from site and legally dispose of at public or private dumping areas off Owner's property.
- F. Handle materials in a controlled manner with as few handlings as possible; do not drop or throw materials from heights.
- G. Schedule cleaning operations so that dust and other contaminants resulting from cleaning process will not fall on wet, newly painted surfaces.

#### 3.2 FINAL CLEANING

- A. IT IS OF PARAMOUNT IMPORTANCE THAT THE CONTRACTOR REGARD THIS ITEM WITH THE UTMOST AWARENESS AND CONCERN FOR THE OWNER'S CUSTOMERS. THE CONTRACTOR SHALL PROVIDE ADEQUATE LABOR AND EQUIPMENT TO PERFORM AND ACCOMPLISH THIS CONTINUOUS CLEAN-UP WORK.
- B. During the course of the project, the Contractor shall keep the work area tidy and neat. There shall not be any lingering nuisances and/or eyesores, such as mounds of rubbish and dirt, material and equipment spread randomly about, barricaded holes, obstructions and hindrance to pedestrian and/or vehicular traffic, etc.. Weather permitting, driveways and sidewalks shall be promptly replaced in a permanent fashion.
- C. Before final acceptance of the work, the Contractor shall satisfactorily clean all areas within the limits of his operations including the street surfaces, walks, gutters, fences, lawns, private property, and structures, leaving them in as neat, clean, and usable condition as originally found. He shall remove all machinery, tools, surplus materials, temporary buildings, and other structures from the site work. He shall also remove all organic matter and materials containing organic matter from all areas and places used by him during construction. All areas shall be cleaned of all sedimentation, debris, rubbish, and dirt.
- D. Where the Contractor's operations have resulted in filling existing ditches, clogging existing culverts, damaging ground surfaces, sidewalks, driveways, etc., the Contractor shall reditch, clean culverts, repair or replace ground surfaces, sidewalks, driveways, etc. so as to return them to a condition as good or better than existed prior to the beginning of his operations.



- E. The Contractor's cleanup operations, which include repair, restoration or replacement of ground surfaces and existing improvements and the removal of rock, shall be performed continuously during the construction operations.
- F. Employ experienced workmen, or professional cleaners, for final cleaning.
- G. In preparation for substantial completion or occupancy, conduct final inspection of sight-exposed interior and exterior surfaces, and of concealed spaces.
- H. Remove grease, dust, dirt, stains, labels, fingerprints, and other foreign materials, from sight-exposed interior or exterior finished surfaces; polish surfaces so designated to shine finish.
- I. Repair, patch and touch up marred surfaces to specified finish, to match adjacent surfaces.
- J. Broom clean paved surfaces; rake clean other surfaces of grounds.
- K. Maintain cleaning until project, or portion thereof, is occupied by Owner.
- L. The work will not be considered as completed and final payment made until all final cleaning up has been done by the Contractor in a manner satisfactory to the Engineer.

END OF SECTION 017400

SECTION 017700 - PROJECT CLOSEOUT

PART 1 - GENERAL

1.1 RELATED REQUIREMENTS SPECIFIED ELSEWHERE

- A. Liquidated Damages: Supplemental General Conditions
- B. Cleaning: Section 017400.
- C. Project Record Documents: Section 017839.

1.2 SUBSTANTIAL COMPLETION

- A. In order to initiate project closeout procedures, the Contractor shall submit the following:
  - 1. Written certification to Engineer that project is Substantially Complete.
  - 2. List of major items to be completed or corrected.
- B. Engineer will make an inspection within seven (7) days after receipt of certification, together with Owner's Representative.
- C. Should Engineer consider that work is Substantially Complete:
  - 1. Contractor shall prepare, and submit to Engineer, a list of items to be completed or corrected, as determined by the inspection.
  - 2. Engineer will prepare and issue a Certificate of Substantial Completion, containing:
    - a. Date of Substantial Completion.
    - b. Contractor's list of items to be completed or corrected, verified and amended by Engineer.
    - c. The time within which Contractor shall complete or correct work of listed items.
    - d. Time and date Owner will assume possession of work or designated portion thereof.
    - e. Responsibilities of Owner and Contractor for:
      - 1) Insurance
      - 2) Utilities
      - 3) Operation of Mechanical, Electrical, and Other Systems.
      - 4) Maintenance and Cleaning.
      - 5) Security.
    - f. Signatures of:
      - 1) Engineer
      - 2) Contractor
      - 3) Owner

3. Owner occupancy of Project or Designated Portion of Project:
    - a. Contractor shall:
      - 1) Obtain certificate of occupancy.
      - 2) Perform final cleaning in accordance with Section 017400.
    - b. Owner will occupy Project, under provisions stated in Certificates of Substantial Completion.
  4. Contractor: Complete work listed for completion or correction, within designated time.
- D. Should Engineer consider that work is not Substantially Complete:
1. He shall immediately notify Contractor, in writing, stating reasons.
  2. Contractor: Complete work, and send second written Engineer, certifying that Project, or designated portion of Project is substantially complete.
  3. Engineer will reinspect work.
- E. Should Engineer consider that work is still not finally complete:
1. He shall notify Contractor, in writing, stating reasons.
  2. Contractor shall take immediate steps to remedy the stated deficiencies, and send third written notice to the Engineer certifying that the work is complete.
  3. Engineer and Owner will reinspect work at Contractor's expense.
- 1.3 FINAL INSPECTION
- A. Contractor shall submit written certification that:
1. Contract Documents have been reviewed.
  2. Project has been inspected for compliance with Contract Documents.
  3. Work has been completed in accordance with Contract Documents.
  4. Equipment and systems have been tested in presence of Owner's Representative and are operational.
  5. Project is completed, and ready for final inspection.
- B. Engineer will make final inspection within seven (7) days after receipt of certification.
- C. Should Engineer consider that work is finally complete in accordance with requirements of Contract Documents, he shall request Contractor to make Project Closeout submittals.
- D. Should Engineer consider that work is not finally complete:
1. He shall notify Contractor in writing, stating reasons.
  2. Contractor shall take immediate steps to remedy the stated deficiencies, and send second written notice to Engineer certifying that work is complete.
  3. Engineer will reinspect work.

1.4 CLOSEOUT SUBMITTALS

- A. Project Record Documents: To requirements of Section 017839.
- B. Guarantees, Warranties and Bonds: To requirements of particular technical Specifications and Section 017834.

1.5 INSTRUCTION

- A. Instruct Owner's personnel in operation of all systems, mechanical, electrical, and other equipment.

1.6 FINAL APPLICATION FOR PAYMENT

- A. Contractor shall submit final applications in accordance with requirements of General Conditions.

1.7 FINAL CERTIFICATE FOR PAYMENT

- A. Engineer will issue final certificate in accordance with provisions of general conditions.
- B. Should final completion be materially delayed through no fault of Contractor, Engineer may issue a Semi-Final Certificate for Payment.

PART 2 - PRODUCTS (Not Applicable)

PART 3 - EXECUTION (Not Applicable)

END OF SECTION 017700

## SECTION 017823 – OPERATIONS AND MAINTENANCE MANUALS

### PART 1 - GENERAL

#### 1.1 RELATED DOCUMENTS

- A. Compile product data and related information appropriate for Owner's maintenance and operation of equipment furnished under the Contract. Prepare operating and maintenance data as specified.
- B. In addition to maintenance and operations data, the manufacturer's printed recommended installation practice shall also be included. If not part of the operations and maintenance manual, separate written installation instructions shall be provided, serving to assist the Contractor in equipment installation.
- C. Related requirements specified elsewhere:
  - 1. Shop Drawings, Product Data and Samples: 013323
  - 2. Project Closeout: Section 017700
  - 3. Project Record Documents: Section 017839
  - 4. Warranties and Bonds: Section 017834

#### 1.2 QUALITY ASSURANCE

- A. Preparation of data shall be done by personnel:
  - 1. Trained and experienced in maintenance and operation of the described products.
  - 2. Completely familiar with requirements of this Section.
  - 3. Skilled as a technical writer to the extent required to communicate essential data.
  - 4. Skilled as a draftsman competent to prepare required drawings.

#### 1.3 SUBMITTAL SCHEDULE

- A. Submit one (1) digital copy and one (1) printed copy of preliminary draft of proposed formats and outlines of contents prior to submittal of operation and maintenance data of equipment.
  - 1. Engineer will review draft and return with comments.
- B. Submit one (1) digital copy and one (1) printed copy of completed data for final review:
  - 1. Prior to the completion of the Contract and before payment in excess of 90% of the total Contract amount is authorized.
- C. Provide two (2) copies of approved completed O & M Manual in final form ten (10) days prior to final inspection or acceptance to the Owner.

- D. Engineers copies for both review and final version shall be in electronic format. Owner shall receive an electronic version AND two (2) hard copies.

#### 1.4 FORM OF SUBMITTALS

- A. Prepare data in the form of an instructional manual for use by Owner's personnel.
- B. Format:
  - 1. Size: 8-1/2 in. x 11 in.
  - 2. Paper: 20 pound minimum, white, for typed pages.
  - 3. Text: Manufacturer's printed data, or neatly typewritten.
  - 4. Photo copies must be clear and legible.
  - 5. Drawings:
    - a. Provide reinforced punched binder tab, bind in with text.
    - b. Fold large drawings to the size of the text pages where feasible.
    - c. For flow or piping diagrams that cannot be detailed on the standard size drawings, a larger, appropriate size drawing may be submitted and supplied in a properly marked map packet.
  - 6. Provide fly-leaf for each separate product, or each piece of operating equipment.
    - a. Provide typed description of product, and major component parts of equipment.
    - b. Provide indexed tabs.
  - 7. Cover: Identify each volume with types or printed title "OPERATING AND MAINTENANCE INSTRUCTIONS". List:
    - a. Title of Project.
    - b. Identity of separate structure as applicable.
    - c. Identity of general subject matter covered in the manual.
- C. Binders:
  - 1. Commercial quality, durable and cleanable, 3-hole, 3" or 4" D-ring binders, with oil and moisture resistant hard covers.
  - 2. When multiple binders are used, correlate the data into related consistent grouping.
  - 3. Imprinted on the front cover and side of each binder shall be the name of the Plant, the Contract Number and Volume Number.
  - 4. Binders shall be new and not recycled form a prior data manual.
- D. Engineers copies for both review and final version shall be in electronic format. Owner shall receive an electronic version AND two (2) hard copies.

#### 1.5 CONTENTS OF MANUAL

- A. Table of Contents: Each item of equipment shall be placed in a logical sequential order, as listed or ordered in the Contract Documents.

- B. Content, for each unit of equipment and system, as appropriate:
1. Process Description: Detailed description of the process and operation functions as applicable.
  2. Component Instructions: Instructions for all components of the equipment whether manufactured by the supplier or not, including valves, controllers and other miscellaneous components.
  3. Component Data: Description of unit and component parts.
    - a. Function, normal operating characteristics, and limiting conditions.
    - b. Performance curves, engineering data and tests.
    - c. Complete nomenclature and commercial number of all replaceable parts.
    - d. Exploded and/or sectional drawing views.
    - e. Piping diagrams numbered to correspond to the installation.
    - f. Equipment model number and serial number.
  4. Control and Wiring Diagrams:
    - a. Internal and external wiring diagrams numbered to correspond to the installation.
    - b. Control circuit diagrams
    - c. One line diagrams
    - d. P&ID drawings
    - e. As-installed control diagrams by controls supplier.
  5. Operating procedures:
    - a. Start-up, break-in, routine and normal operating instructions.
    - b. Regulation, control, stopping, shutdown and emergency instructions.
    - c. Summer and winter operating instructions.
    - d. Special operating instructions.
    - e. Description of sequence of operation by control supplier.
  6. Maintenance Procedures:
    - a. Routine operations.
    - b. Guide to "trouble-shooting".
    - c. Disassembly, repair and reassembly.
    - d. Alignment, adjusting and checking.
    - e. Equipment parts list.
    - f. Original manufacturer's parts list, illustrations, assembly drawings and diagrams required for maintenance.
      - 1) Predicted life of parts subject to wear.
    - g. Local service center.
  7. Lubrication and Service schedule.
    - a. Preventative maintenance schedule.
    - b. Component lubrication and servicing interval schedule.
    - c. List of lubricants and/or filters required.

- d. Lubrication and servicing procedures.
  8. Recommended spare parts list and quantities.
  9. Guide to "trouble-shooting".
  10. Plant specific instructions:
    - a. Each Contractor's coordination drawings.
    - b. As-installed color coded piping diagrams.
    - c. Detailed specific "Sequence of Operation" for the constructed plant or project.
    - d. Charts of valve tag numbers, with the location and function of each valve.
  11. Plant specific start-up and shut-down procedures.
  12. Detailed instructions for emergency operation
  13. Other data as required under pertinent sections of Specifications.
- C. Content, for each electrical system, as appropriate:
1. Description of system and component parts.
    - a. Function, normal operating characteristics, and limiting conditions.
    - b. Performance curves, engineering data and tests.
    - c. Complete nomenclature and commercial number of replacement parts.
  2. Circuit directories of panel boards.
    - a. Electrical service.
    - b. Controls.
    - c. Communications.
  3. As-installed color-coded wiring diagrams.
  4. Operating procedures:
    - a. Routine and normal operating instructions.
    - b. Sequences required.
    - c. Special operating instructions.
  5. Maintenance procedures:
    - a. Routine operations.
    - b. Guide to "trouble-shooting".
    - c. Disassembly, repair and reassembly.
    - d. Adjustment and checking.
  6. Manufacturer's printed operating and maintenance instructions.
  7. List of original manufacturer's recommended spare parts, manufacturer's current prices, and recommended quantities to be maintained in storage.
- D. Prepare and include additional data when the need for such data becomes apparent during instruction of Owner's personnel.



- E. Additional requirements for operating and maintenance data: The respective section of Specifications.

PART 2 - PRODUCTS (Not Applicable)

PART 3 - EXECUTION (Not Applicable)

END OF SECTION 017823



## SECTION 017834 - WARRANTIES AND BONDS

### PART 1 - GENERAL

#### 1.1 DESCRIPTION OF REQUIREMENTS

- A. Compile specified warranties and bonds.
- B. Compile specified service and maintenance contracts.
- C. Co-execute submittals when so specified.
- D. Review submittals to verify compliance with Contract Documents.
- E. Submit to Engineer for review and transmittal to Owner. **Comply with provisions of Section 013323.**

#### 1.2 RELATED DOCUMENTS

- A. Bid Bond: Instructions to Bidders.
- B. Performance and Payment Bonds: General Conditions and Supplemental General Conditions.
- C. Guaranty: General Conditions and Supplemental General Conditions.
- D. General Warranty of Construction: General Conditions.
- E. Project Closeout: Section 017700.
- F. Warranties and Bonds required for specific products: As listed in technical specifications in these Contract Documents herein.
- G. Provisions of Warranties and Bonds, Duration: Respective specification sections for particular products.

#### 1.3 SUBMITTALS REQUIREMENTS

- A. Assemble warranties, bonds and service and maintenance contracts, executed by each of the respective manufacturers, suppliers and subcontractors.
- B. Furnish two (2) original signed copies.
- C. Table of Contents: Neatly typed, in orderly sequence. Provide complete information for each item.
  - 1. Product, equipment or work item.

2. Firm name, address and telephone number.
3. Scope
4. Date of beginning of warranty, bond or service and maintenance contract.
5. Duration of warranty, bond or service and maintenance contract.
6. Provide information for Owner's personnel:
  - a. Proper procedure in case of failure.
  - b. Instances which might affect the validity of warranty or bond.
7. Contractor name, address and telephone number.

#### 1.4 FORM OF SUBMITTALS

- A. Prepare in duplicate packets.
- B. Format:
  1. Size 8-1/2 in. x 11 in., punch sheets for 3-ring binder.
    - a. Fold larger sheets to fit into binders.
  2. Cover: Identify each packet with typed or printed title "WARRANTIES AND BONDS."  
List:
    - a. Title of Project
    - b. Name of Contractor
- C. Binders: Commercial quality, three-ring, with durable and cleanable plastic covers.

#### 1.5 TIME OF SUBMITTALS

- A. For equipment or component parts of equipment put into service during progress of construction:
  1. Submit documents within 10 days after inspection and acceptance.
- B. Otherwise make submittals within 10 days after date of substantial completion, prior to final request for payment.
- C. For items of work, where acceptance is delayed materially beyond the Date of Substantial Completion, provide updated submittal within 10 days after acceptance, listing the date of acceptance as the start of the warranty period.

#### 1.6 SUBMITTALS REQUIRED

- A. Submit warranties, bonds, service and maintenance contracts as specified in the respective sections of the Specifications.

PART 2 - PRODUCTS (Not Applicable)

PART 3 - EXECUTION (Not Applicable)

END OF SECTION 017834

SECTION 017839 - PROJECT RECORD DOCUMENTS - SEWER

PART 1 - GENERAL

1.1 MAINTENANCE OF DOCUMENTS

- A. Maintain at job site, one copy of:
  - 1. Contract Drawings
  - 2. Specifications
  - 3. Addenda
  - 4. Reviewed Shop Drawings
  - 5. Change Orders
  - 6. Other Modifications to Contract
- B. Store documents in approved location, apart from documents used for construction.
- C. Provide files and racks for storage of documents.
- D. Maintain documents in clean, dry, legible condition.
- E. Do not use record documents for construction purposes.
- F. Make documents available at all times for inspection by Engineer and Owner.

1.2 RELATED WORK SPECIFIED ELSEWHERE

- A. Shop Drawings, Product Data, and Samples: Section 01 33 23.

1.3 MARKING DEVICES

- A. Provide colored pencil or felt-tip marking pen for all marking.

1.4 RECORDING

- A. Label each document "PROJECT RECORD" in 2-inch high printed letters.
- B. Keep record documents current.
- C. Do not permanently conceal any work until required information has been recorded.
- D. Contract Drawings: Legibly mark to record actual construction:
  - 1. Horizontal and vertical location of underground utilities and appurtenances referenced to permanent surface improvements.

2. Location of internal utilities and appurtenances concealed in construction referenced to visible and accessible features of structure.
  3. Field changes of dimension and detail.
  4. Changes made by Change Order or Field Order.
  5. Details not on original Contract Drawings.
- E. Specifications and Addenda: Legibly mark up each section to record:
1. Manufacturer, trade name, catalog number, and supplier of each product and item of equipment actually installed.
  2. Changes made by Change Order or Field Order.
  3. Other matters not originally specified.
- F. Shop Drawings: Maintain as record documents; legibly annotate shop drawings to record changes made after review. Coordinate and confirm with Engineer that electronic media versions of all shop drawings have been provided to Engineer.
- 1.5 SUBMITTALS
- A. At completion of project, deliver record documents to Engineer.
- B. Accompany submittal with transmittal letter, in duplicate, containing:
1. Date.
  2. Project Title and Number.
  3. Contractor's Name and Address.
  4. Title and Number of each Record Document.
  5. Certification that each Document as Submitted is Complete and Accurate.
  6. Signature of Contractor, or His Authorized Representative.
- 1.6 STANDARD PROCEDURE FOR AS CONSTRUCTED LOCATION OF LATERAL SERVICE CONNECTIONS
- A. See Exhibit 1:
- Exhibit 1 – Standard Procedure for as constructed location of lateral service connections.

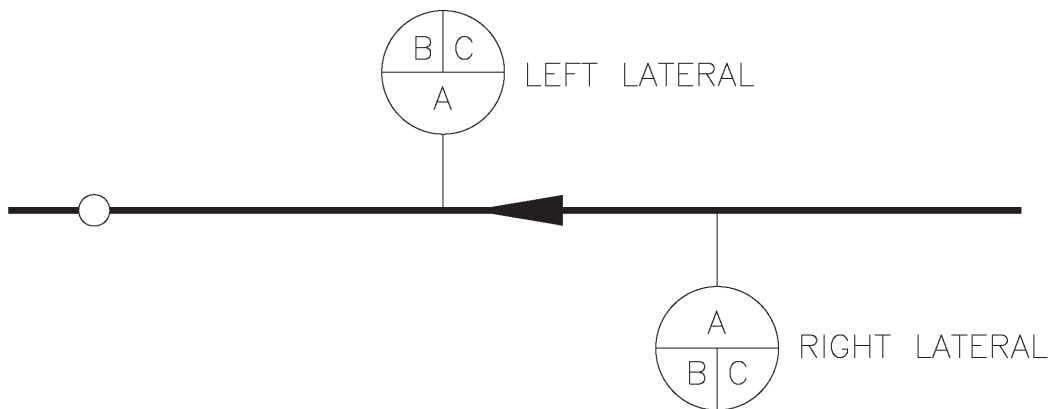

EXPLANATION

- A. Laterals for service connections shall be located with reference to the nearest downstream manhole. The distance from the downstream manhole to the tee is measured along the centerline of the main sewer and noted as "A" in the circle diagram.

When the lateral is out of manhole, "A" is noted as "N/A" (not Applicable).

- B. Distance from main sewer to the end of lateral is measured at right angles to the main sewer from centerline of tee to the end of lateral. Distance is shown as "B" in circle diagram. When only one length of pipe is installed, distance is given as 5-feet.

- C. Depth at end of lateral is from top of ground to top of lateral and shown as "C" in circle diagram.

TYPICAL EXAMPLE

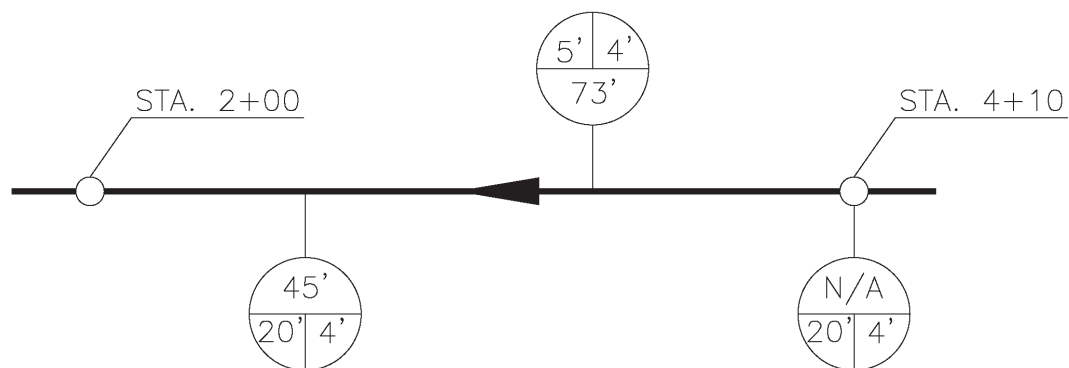

PART 2 - PRODUCTS (Not Applicable)

PART 3 - EXECUTION (Not Applicable)

END OF SECTION 017839



DIVISION 03

CONCRETE

## SECTION 034000 – PRECAST CONCRETE STRUCTURES

### PART 1 - GENERAL

#### 1.1 SCOPE OF WORK

- A. Provide all labor, materials, equipment and services required to furnish and install all precast concrete structures and accessories appurtenances as shown on the Drawings and specified herein.
- B. Delegated Design: Design precast concrete structures, including comprehensive engineering analysis by a qualified professional engineer, licensed in the state in which the project using performance requirements and design criteria indicated.

#### 1.2 RELATED WORK SPECIFIED ELSEWHERE

- A. Cast-in-Place Concrete: Section 033100
- B. Access Hatches: Section 083110

#### 1.3 SUBMITTALS

The Contractor shall submit the following data for Engineer's review in accordance with Section 013323.

- A. Delegated Design Submittal: For installed products indicated to comply with performance requirements and design criteria, including analysis data, calculations, and erection drawings signed and sealed by the qualified professional engineer responsible for their preparation.
- B. Product Data: For each type of product indicated included but not limited to standard precast units, proprietary precast units, embedded items, and accessories.
- C. Design Data: Submit calculations prepared under the direct supervision of a professional engineer supporting the structural design, including resistance to buoyancy with groundwater table to the top of the structure, resistance to uplift and resistance to wheel loads in accordance with requirements and references indicated. The calculations shall be sealed by a professional engineer licensed in the state in which the project is located.
- D. Test Reports: Submit test reports for the following:
  - 1. Material certifications and/or laboratory test reports, including mill tests and all other test data, for Portland cement, blended cement, pozzolans, ground granulated blast furnace slag, silica fume, aggregate, admixtures, and curing compound proposed for use on this Project.
  - 2. Test reports showing that the mix has been successfully tested to produce concrete with the properties specified and will be suitable for the job conditions. Such tests may include compressive strength, flexural strength, plastic or hardened air content, freeze

- thaw durability, abrasion and absorption. Clearly detail in the specifications special tests for precast concrete or cast-in items.
3. Sufficient documentation, when the use of self-consolidating concrete (SCC) is proposed, showing a minimum of 30-days production track records demonstrating that SCC is appropriate for casting of the product.
  4. In-plant QA/QC inspection reports, upon the request of the Project Representative.
- E. Shop Drawings: Submit shop drawings for standard precast units and custom-made precast units prepared under direct supervision of a professional engineer licensed in the state in which the project is located. Shop drawings shall include:
1. The criteria and loads used in the design of the precast components.
  2. All materials used, their specifications and their design strengths.
  3. Layout, piecemark, dimensions, reinforcing, and connection details of each precast member, including openings.
  4. Details and instructions for lifting, rigging, erection, and installation of each precast component.
  5. Lists and descriptions of all loose accessory materials supplied.
  6. Instructions on secondary pours (in the field) when required.
  7. Professional Engineer's seal.
- F. Quality Control Procedures: Submit certificate from the NPCA QC Manual that the precast concrete structure manufacturer participates in their QA/QC program.
- G. Manufacturer's Instructions.
- 1.4 QUALITY ASSURANCE
- A. Manufacturer of precast concrete structures shall be quality certified by NCPA. Inspect manufacture of structures in accordance with ASTM C1037.
  - B. Installer of precast concrete structures shall have a record of at least three (3) years of successful installation of similar products on similar projects.
  - C. Inspection of earthwork, compaction and backfill shall be in accordance with the earthwork specifications in Division 31.
- 1.5 DELIVERY, STORAGE, AND HANDLING
- A. Deliver precast units to the site in accordance with the delivery schedule to avoid excessive build-up of units in storage at the site. Upon delivery to the jobsite, all precast concrete units will be inspected by the Project Representative for quality and final acceptance.
  - B. Store units off the ground or in a manner that will minimize potential damage.
  - C. Handle, transport, and store products in a manner to minimize damage. Lifting devices or holes shall be consistent with industry standards. Perform lifting with methods or devices intended for this purpose as indicated on Shop Drawings.

## PART 2 - PRODUCTS

### 2.1 PRECAST CONCRETE STRUCTURES

- A. Circular precast vaults and structures shall conform to ASTM C478. Non-circular vaults and structures shall conform to ASTM C857. Access hatch and pipe penetrations shall be cast in the top slab and/or sides as indicated on the drawings.
- B. Manhole frames and covers shall have a clear opening of 22 inches and shall be made of cast iron conforming to ASTM A48/A48M Class 30. Casting shall be smooth, clean and free from blisters, blowholes and shrinkage. Castings shall be dipped twice in a preparation of asphalt or coal tar and oil applied at a temperature of not less than 144 degrees F and not more than 155 degrees F so as to form a tenacious coating.
- C. Structural design of precast concrete structures is hereby delegated.
- D. All precast concrete structures shall be designed to resist the lateral soil pressures and fluid pressures in accordance with ASTM C857.
- E. All precast concrete structures have integral flanges at the base to engage enough soil resistance to resist the buoyant force from full submergence.
- F. All precast concrete structures shall be designed to support HL-93 or HS25-44 wheel loads in accordance with the AASTHO HB-17 anywhere on the top surface of the structure.
- G. Joints: Joints shall be watertight and shall be sealed with one of the following:
  - 1. Rubber gaskets conforming to ASTM C443.
  - 2. Pre-formed flexible butyl type joint sealant conforming to AASHTO M198.
    - a. Hamilton Kent "Kent Seal No. 2"
    - b. K.T. Snyder Company "Rub'r Nek"
    - c. Press Seal Gasket "E Z Stik"
- H. Corrosion Control: Follow recommendations outlined in ACPA 01-110 when hydrogen sulfide is indicated as a potential problem.

## PART 3 - EXECUTION

### 3.1 FABRICATION

- A. Fabricate precast concrete structures in accordance with NPCA QC Manual.

### 3.2 INSTALLATION

- A. Install precast concrete structures in accordance with ASTM C891 and the manufacturer's instructions.

- B. Lift precast components at designated lifting points in accordance with the manufacturer's instructions and other applicable safety standards.
- C. Precast concrete structures shall bear on a minimum 4 inch thick bedding / base / drainage course of free-draining granular material. See Division 31 for bedding / base / drainage course materials.
- D. Do not bear precast concrete structures on uneven subgrade or grade with high points from rock pinnacles or boulders or rock ledges.
- E. Install precast concrete structures in proper location, with the proper alignment and level.
- F. Backfill around the precast concrete structures in accordance with Division 31 specifications.

### 3.3 JOINTS

- A. Joints shall be sealed with an approved sealant as specified in Part 2, and shall be mortared or grouted.
- B. When making joints with mastic compound prime and seal all joints with primer supplied with the joint compound.
- C. Joints shall be watertight.
- D. Pipe Connections into Precast Structures:
  - 1. Precast Openings:
    - a. Pipe shall be sealed in the precast section pipe opening with a resilient connector meeting the requirements of ASTM C923. Resilient connector shall be "Dura-Seal III" by Dura-Tech, Dayton, Ohio; "A-Lok" by A-LOK Products, Inc.; or approved equal.
    - b. Resilient connector shall be cast integrally into the wall of the precast section at the time of manufacture. There shall be no mortar placed around the connector on the outside of the manhole and no mortar shall be placed around the top half of the connector on the inside of the manhole when completing the invert work.
  - 2. Cored Openings:
    - a. Pipe shall be sealed in cored precast section pipe opening with a resilient mechanical connector meeting the requirements of ASTM C923. Resilient connector shall be "NPC Kor-N-Seal I" (with stainless steel wedge) by Trelleborg Pipe Seals Milford, Inc.; "PSX: Direct Drive" by Press-Seal Gasket Corporations; interlocking link pipe seal; or approved equal. All fasteners and hardware shall be Type 304 stainless steel.
    - b. There shall be no mortar placed around the connector on the outside of the structure and no mortar shall be placed around the top half of the connector on the inside of the structure when completing the invert work.

### 3.4 LEAKAGE TESTING

- A. Leakage tests shall be made and observed by the Project Representative's representative for all precast structures. The test shall be the watertightness (exfiltration) test as described herein.
- B. After each structure has been assembled in place, including wall piping, all lifting holds shall be filled with an approved non-shrink, non-metallic grout. Upon completion, each precast structure shall be tested to determine watertightness. The leakage test shall be made prior to placing any fill material and prior to application of interior/exterior wall coatings if specified. If the groundwater table has been allowed to rise above the bottom of the structure, it shall be lowered for the duration of the test. All pipes and other openings into the structures shall be suitably plugged and the plugs braced to prevent blow out.
- C. The tank shall be filled with potable water to the maximum level. The test shall consist of measuring the liquid level over the next 24 hours to determine if any change has occurred. If a change is observed and exceeds the maximum allowance, the test shall be extended to a total of five days. If at the end of five days the average daily change has not exceeded the maximum allowance, the test shall be considered satisfactory.
- D. The liquid volume loss for a period of 24 hours shall not exceed one-twentieth of one percent of the tank capacity,  $0.0005 \times$  tank volume. If the liquid volume loss exceeds this amount, it shall be considered excessive, and the tank shall be repaired and retested.
- E. Damp spots will not be permitted at any location on the structure wall. Damp spots are defined as spots where moisture can be picked up on a dry hand. All such areas shall be repaired as necessary.
- F. Damp spots or standing water on the footing may occur upon tank filling and are permissible within the allowable volume loss. Measurable flow in this area is not permissible and must be corrected.
- G. It shall be the Contractor's responsibility to uncover the structure as necessary and to disassemble, reconstruct, or replace it as directed by the Project Representative. The structure shall then be retested.
- H. No adjustment in the leakage allowance will be made for unknown causes such as leaking plugs, absorptions, etc. It will be assumed that all loss of water during the test is a result of leaks through the joints or through the concrete. Furthermore, the Contractor shall take any steps necessary to assure the Project Representative that the water table is below the bottom of the structure throughout the test.

### 3.5 CLEAN UP

- A. Upon completion of installation of the precast structures and appurtenances, the Contactor shall remove all debris and surplus construction materials resulting from the Work. The Contractor shall grade the ground around and adjacent to the construction area in a uniform and neat manner to the final grade lines.

END OF SECTION 034000

DIVISION 31  
EARTHWORK

## SECTION 312000 - EARTHWORK

### PART 1 - GENERAL

#### 1.1 SCOPE OF WORK

- A. Provide all materials, labor, equipment and services necessary to do all clearing and grubbing, excavation, backfilling, providing of additional fill material and topsoil, control of surface drainage and ground water, finished site grading and erosion control required to construct the work as shown.

#### 1.2 RELATED WORK SPECIFIED ELSEWHERE

- A. State and local code requirements shall control the disposal of trees and shrubs.
- B. All burning shall be controlled by applicable local regulations.
- C. Excavation Support and Protection – Section 315000
- D. Erosion and Sedimentation Control – Section 312500

#### 1.3 JOB CONDITIONS

- A. Weather: Earthwork operations shall be suspended at any time when satisfactory results cannot be obtained on account of rain, snow, ice, drought or other adverse weather conditions.
- B. Existing Utilities: Prior to commencement of work, the Contractor shall locate existing underground utilities in areas of the work. If utilities are to remain in place, provide adequate means of protection during earthwork operations.
- C. Use of Explosives: The Contractor (or any of his Subcontractors) shall not bring explosives onto site or use in work without prior written permission from the Owner. All activities involving explosives shall be in compliance with the rules and regulations of the State Department of Mines, and Minerals, Division of Explosives and Blasting. Contractor is solely responsible for handling, storage, and use of explosive materials when their use is permitted.
- D. Protection of Persons and Property:
  - 1. Barricade open excavations occurring as part of this work and post with warning lights.
    - a. Operate warning lights as recommended by authorities having jurisdiction.
    - b. Protect structures, utilities, sidewalks, pavements, and other facilities from damage caused by settlement, lateral movement, undermining, washout, and other hazards created by earthwork operations.



- E. Dust Control: Use all means necessary to control dust on or near the project site where such dust is caused by the Contractor's operations or directly results from conditions left by the Contractor.

#### 1.4 UTILITY LINE ACTIVITIES COVERED UNDER NATIONWIDE PERMIT # 12

All activities involving utility line construction covered under NATIONWIDE PERMIT # 12 shall meet the following conditions:

- A. The general Water Quality Certification is limited to the crossing of intermittent and perennial streams by utility lines.
- B. The construction of permanent or temporary access roads will impact less than 300 linear feet of intermittent and perennial streams and less than one acre of jurisdictional wetlands.
- C. Utility lines shall be located at least 50 feet away from a stream which appears as a blue line on a USGA 7 ½ minute topographic map except where the utility line alignment crosses the stream. Utility lines that cross streams shall be constructed by methods that maintain normal stream flow and allow for a dry excavation. Water pumped from the excavation shall be contained and allowed to settle prior to re-entering the stream. Excavation equipment and vehicles shall operate outside of the flowing portion of the stream. Spoil material from the utility line excavation shall not be allowed to enter the flowing portion of the stream.
- D. The activities shall not result in any permanent changes in preconstruction elevation contours in waters or wetlands or stream dimension, pattern or profile.
- E. Utility line construction projects through jurisdictional wetlands shall not result in conversion of the area to non-wetland status.
- F. Measures shall be taken to prevent or control spills of fuels, lubricants, or other toxic materials used in construction from entering the watercourse.
- G. Removal of riparian vegetation in the utility line right-of-way shall be limited to that necessary for equipment access. Effective erosion and sedimentation control measures must be employed at all times during the project to prevent degradation of waters of the Commonwealth. Site regrading and reseeding will be accomplished within 14 days after disturbance.
- H. To the maximum extent practicable, all in stream work under this certification shall be performed during low flow.
- I. Heavy equipment, e.g. bulldozers, backhoes, draglines, etc., if required for this project, should not be used or operated within the stream channel. In those instances where such in stream work is unavoidable, then it shall be performed in such a manner and duration as to minimize turbidity and disturbance to substrates and bank or riparian vegetation.
- J. Any fill shall be of such composition that it will not adversely affect the biological, chemical, or physical properties of the receiving waters and/or cause violations of water quality standards. If riprap is utilized, it is to be of such weight and size that bank stress or slump conditions will not be created because of its placement.

- K. Removal of existing riparian vegetation should be restricted to the minimum necessary for project construction.
- L. Should evidence of stream pollution or jurisdictional wetland impairment and/or violations of water quality standards occur as a result of this activity (either from a spill or other forms of water pollution), the Kentucky Division of Water shall be notified immediately by calling 800/928-2380.

## PART 2 - PRODUCTS

### 2.1 SOIL MATERIALS

#### A. Definitions:

1. Satisfactory soil materials are defined as those complying with ASTM D2487 soil classification groups GW, GP, GM, SM, SW, SP, GC, SC, ML, and CL.
2. Unsatisfactory soil materials are defined as those complying with ASTM D2487 soil classification groups MH, CH, OL, OH and PT. The Contractor shall notify the Engineer if these soil materials are encountered.
3. Subbase Material: Naturally or artificially graded mixture of natural or crushed gravel, crushed stone, crushed slag, natural or crushed sand.
4. Drainage Fill: Washed, evenly graded mixture of crushed stone, or uncrushed gravel, with 100 percent passing a 1/2 inch sieve and not more than 5 percent passing a No. 4 sieve.
5. Backfill and Fill Materials: Satisfactory soil materials free of debris, waste, frozen materials, vegetable, and other deleterious matter.

### 2.2 DENSE GRADED AGGREGATE D.G.A.

- A. Dense graded aggregate shall consist of crushed stone or crushed slag in combination with approved mineral filler needed to meet grading requirements. The D.G.A. shall comply with the applicable requirements of Section 805 of the Kentucky Department of Transportation's Standard Specifications for Road and Bridge Construction, 2000.

### 2.3 PIPE BEDDING & BACKFILL

- A. Pipe Bedding: Pipe bedding material shall consist of crushed stone and shall conform to grading limits for No. 9 crushed stone as specified in Section 805 of the Kentucky Department of Transportation's Standard Specifications for Road and Bridge Construction, 2000.
- B. Crushed Stone Backfill: Crushed stone for backfilling in paved areas (not in the State's right-of-way) and areas within the State's right-of-way, but not beneath existing pavement shall be No. 9 as specified in the Kentucky Department of Transportation's Standard Specifications for Road and Bridge Construction, 2000. If in rock cut or unsuitable backfill may backfill with No. 57 or 67 stone. Backfill shall be compacted in six (6) inch layers or lifts.

- C. Flowable Fill Backfill: Flowable fill shall be used as backfill material in accordance with the standard detail drawings for pipe main lines and services under existing State roadways. Flowable fill shall conform to Subsection 601.03.03B of Kentucky Transportation Cabinet's Standard Specifications for Road and Bridge Construction, 2000 edition.
- D. Geotextile Fabric Material (For Crushed Stone Backfill): Contractor shall use Type IV fabric with a minimum width of 36 inches conforming to Section 843 of Kentucky Transportation Cabinet's Standard Specifications for Road and Bridge Construction, 2000 edition. All pipes within the State's right-of-way (not backfilled with flowable fill as specified herein) should be backfilled as noted and wrapped with geotextile fabric. See item B of this Section 2.03.

### PART 3 - EXECUTION

#### 3.1 CLEARING AND GRUBBING

- A. Work shall consist of cutting and removing designated trees, stumps, brush, logs, removal of fences, or other loose and projecting material. Unless otherwise specified, it shall also include the grubbing of stumps, roots, and other natural obstructions which, in the opinion of the Engineer, must be removed to execute properly the construction work and operate properly the facility upon the completion of construction.
- B. Trees, bushes, and all natural vegetation shall only be removed with the approval of the Engineer. No cleared or grubbed materials shall be used in backfills or embankment fills. All stumps, roots, and other objectionable material shall be grubbed up so that no roots larger than 3 inches in diameter remain less than 18 inches below the ground surface. All holes and depressions left by grubbing operations shall be filled with suitable material and compacted to grade, as recommended in Paragraph 3.06.
- C. Disposal shall be by burning or other methods satisfactory to the Engineer; however, burning will be permitted only when the Contractor has obtained written permission from the local regulatory agency.
- D. The Contractor shall also remove from the site and satisfactorily dispose of all miscellaneous rubbish including, but not limited to, masonry, scrap metal, rock, pavement, etc., that is under the fill or to be removed as shown on the Drawings, specified herein, or directed by the Engineer.
- E. Existing improvements, adjacent property, utility and other facilities, and trees, plants, and brush that are not to be removed shall be protected from injury or damage resulting from the Contractor's operations.
- F. Trees and shrubs, designated to remain or that are beyond the clearing and grubbing limit, which are injured or damaged during construction operations shall be treated or replaced at the Contractor's expense by experienced tree surgery personnel.

3.2 EROSION CONTROL

- A. Temporary measures shall be applied throughout the construction period to control and to minimize siltation to adjacent properties and waterways. Such measures shall include, but not be limited to, the use of berms, silt barriers, gravel or crushed stone, mulch, slope drains and other methods.
- B. These temporary measures shall be applied to erodible material exposed by any activity associated with the construction of this project.
- C. Refer to Section 312500, Erosion and Sedimentation Control for requirements.

3.3 EXCAVATION

- A. Excavation of every description and of whatever substances encountered within the grading limits of the project shall be performed to the lines and grades indicated on the Drawings. All excavation shall be performed in the manner and sequence as required for the work.
- B. All excavated materials that meet the requirements for fill, subgrades or backfill shall be stockpiled within the site for use as fill or backfill, or for providing the final site grades. Where practicable, suitable excavated material shall be transported directly to any place in the fill areas within the limits of the work. All excavated materials that are not suitable for fill, and any surplus of excavated material that is not required for fill shall be disposed of by the Contractor.
- C. The site shall be kept free of surface water at all times. The Contractor shall install drainage ditches, dikes and shall perform all pumping and other work necessary to divert or remove rainfall and all other accumulations of surface water from the excavations. The diversion and removal of surface water shall be performed in a manner that will prevent flooding and/or damage to other locations within the construction area where it may be detrimental. The Contractor shall provide, install and operate sufficient trenches, sumps, pumps, hose piping, well points, deep wells, etc., necessary to depress and maintain the ground water level at least two (2) feet below the base of the excavation during all stages of construction operations. The ground water table shall be lowered in advance of excavation and maintained a minimum of two (2) feet below the lowest excavation subgrade made until the excavation is backfilled or the structure has sufficient strength and weight to withstand horizontal and vertical soil and water pressures from natural ground water.
- D. Excavations for concrete structural slabs on grade shall extend two (2) feet below the indicated bottom of slabs. The over-excavation shall be backfilled with 18 inches, compacted thickness, of over lot fill material or suitable material as herein specified. The remaining six (6) inches of over-excavation shall be backfilled with porous fill material. The porous fill layer shall extend beyond the limits of the concrete slab a minimum of two (2) feet on all sides as indicated on the Drawings. The porous fill shall be crushed stone or gravel and shall have the following U.S. Standard Sieve gradation:

Sieve	1-1/2	1	3/4	1/2	3/8
% Passing	Min 100	95±5	58±17	Max 15	Max 5

- E. Excavations for the construction shall be carefully made to the depths required. Bottoms for footings and grade beams shall be level, clean and clear of loose material, the lower sections

true to size. Bottoms of footings and grade beams, in all locations, shall be at a minimum depth of 30 inches below adjacent exterior finished grade or 30 inches below adjacent existing grade, whichever is lower, whether so indicated or not. Footings and grade beam bottoms shall be inspected by the Engineer before any concrete is placed thereon.

- F. In excavations for structures where, in the opinion of the Engineer, the ground is spongy or otherwise unsuitable for the contemplated foundation, the Contractor shall remove such unsuitable material and replace it with suitable material properly compacted.
- G. Sheeting and shoring shall be provided as necessary for the protection of the work and for the safety of the personnel. The clearances and types of the temporary structures, insofar as they affect the character of the finished work, will be subject to the review of the Engineer, but the Contractor shall be responsible for the adequacy of all sheeting, bracing and coffer damming. All shoring, bracing and sheeting shall be removed as the excavations are backfilled in a manner such as to prevent injurious caving; or, if so directed by the Engineer, shall be left in place. Sheeting left in place shall be cut off 18 inches below the surface.
- H. Excavation for structures which have been carried below the depths indicated without specific instructions shall be refilled to the proper grade with suitable material properly compacted, except that in excavation for columns, walls or footings, the concrete footings shall extend to this lower depth. All work of this nature shall be at the Contractor's expense.

#### 3.4 FILL

- A. All existing fill below structures and paved areas must be stripped. The upper six (6) inches of the natural subgrade below shall be scarified and recompactd at optimum moisture to at least ninety-five percent (95%) of Standard Proctor Density ASTM D 698 (latest revision).
- B. All vegetation, such as roots, brush, heavy sods, heavy growth of grass and all decayed vegetable matter, rubbish and other unsuitable material within the area upon which fill is to be placed shall be stripped or otherwise removed before the fill is started. In no case will such objectionable material be allowed to remain in or under the fill area. Existing fill from excavated areas on site shall be used as fill for open and/or planted areas. Additional fill stockpiled at the site can be used for structural fill if approved by the Engineer. Any additional material necessary for establishing the indicated grades shall be furnished by the Contractor and approved by the Engineer. All fill material shall be free from trash, roots and other organic material. The best material to be used in fills shall be reserved for backfilling pipe lines and for finishing and dressing the surface. Material larger than 3 inches maximum dimension shall not be permitted in the upper 6 inches of the fill area. Fill material shall be placed in successive layers and thoroughly tamped or rolled in a manner approved by the Engineer, each layer being moistened or dried such that the specified degree of compaction shall be obtained. No fill shall be placed or compacted in a frozen condition or on top of frozen material. No fill material shall be placed when free water is standing on the surface of the area where the fill is to be placed and no compaction of fill will be permitted with free water on any point of the surface of the fill to be compacted.
- C. Where concrete slabs are placed on earth, all loam and organic or other unsuitable material shall be removed. Where fill is required to raise the subgrade for concrete slabs to the elevations as indicated on the Drawings or as required by the Engineer, such fill shall consist of suitable material and shall be placed in layers. Each layer shall be moistened or dried such that the

specified degree of compaction shall be obtained. All compaction shall be accomplished in a manner and with equipment as approved by the Engineer. When the subgrade is part fill and part excavation or natural ground, the excavated or natural ground portion shall be scarified to a depth of 12 inches and compacted as specified for adjacent fill.

### 3.5 BACKFILLING

- A. After completion of footings, grade beams and other construction below the elevation of the final grades and prior to backfilling, all forms shall be removed and the excavation shall be cleaned of all trash and debris. Material for backfilling shall be as specified for suitable material, placed and compacted as specified hereinafter. Backfill shall be placed in horizontal layers of the thickness specified and shall have a moisture content such that the required degree of compaction is obtained. Each layer shall be compacted by mechanical tampers or by other suitable equipment approved by the Engineer to the specified density. Special care shall be taken to prevent wedging action or eccentric loading upon or against the structure. Trucks and machinery used for grading shall not be allowed within 45 degrees above the bottom of the footings or grade beams.
- B. The trenches shall be backfilled following visual inspection by the Engineer and prior to pressure testing. The trenches shall be carefully backfilled with the excavated materials approved for backfilling, or other suitable materials, free from large clods of earth or stones. Each layer shall be compacted to a density at least equal to that of the surrounding earth and in such a manner as to permit the rolling and compaction of the filled trench with the adjoining earth to provide the required bearing value, so that paving, if required, can proceed immediately after backfilling is completed.
- C. Pipe Bedding: In all cases the foundation for pipes shall be prepared to that the entire load of the backfill on top of the pipe will be carried on the barrel of the pipe and insofar as possible where bell and spigot pipe are involved so that none of the load will be carried on the bells.
- D. The depth at the bottom of the bells of the pipe will be at least four inches above the bottom of the trench as excavated.
- E. Supporting of pipe shall be as set out hereinbefore, and in no case shall the supporting of pipe on blocks be permitted.
  - 1. Earth Foundations: All water and sewer main and service pipe shall be supported on a bed of Size Number 9 crushed stone as defined by the Kentucky Department of Highways Specifications and as shown on the Detail Sheets. Bedding material shall be free from rock and be acceptable to the Engineer. In no case shall pipe be supported directly on rock.
  - 2. Rock Foundation: If the trench bottom is in rock, the excavation shall be undercut to a minimum depth of six inches below the bottom of the pipe. The pipe shall be laid on a bed of granular material to provide continuous support for the lower section of the pipe. Granular bedding shall be Number 9 crushed stone as shown on the Detail Sheets.
  - 3. Special Bedding: In wet, yielding murky locations, where pipe is in danger of sinking below grade or floating out of line or grade, or where backfill materials are of such a fluid nature that such movements of the pipe might take place during the placing of the backfill, the pipe must be weighted or secured permanently in place by such means as will prove

effective. When ordered by the Engineer, yielding and murky material in subgrades shall be removed below ordinary trench depth in order to prepare a proper bed for the pipe. Crushed stone or other granular material, if necessary, as determined by the Engineer to replace poor subgrade material, shall be classified as “Special Pipe Bedding”. Granular material for “Special Pipe Bedding” shall be Number 57 or 67 as directed by the Engineer.

- F. Backfill in Open Terrain (Outside the State’s Right-of-Way, Outside of the Railway’s Right-of-Way and not Beneath Pavement): In all installations, the lower portion of the trench, from the pipe bedding to the springline (centerline) of the pipe shall be backfilled with No. 9 crushed stone.
  - 1. Ductile Iron Pipe: When installing ductile iron pipe, the portion of the trench from the springline of the pipe to a point twelve (12) inches above the pipe shall be backfilled with No. 9 crushed stone. The upper portion of the trench shall be backfilled with selected native backfill material. Backfilling this portion of the trench is to be accomplished by any means approved by the Engineer.
  - 2. Polyvinyl Chloride Sewer Pipe: When installing P.V.C. sewer pipe, the portion of the trench from the springline of the pipe to a point twelve (12) inches above the pipe shall be backfilled with Number 9 crushed stone. The upper portion of the trench above the crushed stone shall be backfilled with selected native backfill material. Backfilling this portion of the trench is to be accomplished by any means approved by the Engineer.
- G. Backfill Under Paved Area: See Paragraph 2.03 of this section for information regarding the various backfill requirements under paved areas.

3.6 COMPACTION

- A. Suitable material as hereinbefore specified shall be placed in maximum 8" horizontal layers. Compaction shall be performed by rolling with approved tamping rollers, pneumatic-tired rollers, three wheel power rollers or other approved equipment. The degree of compaction required is expressed as a percentage of the maximum dry density obtained by the test procedure presented in ASTM D-698. Laboratory moisture density tests shall be performed on all fill material. Material shall be moistened or aerated as necessary to provide the moisture content that will readily facilitate obtaining the specified compaction. Compaction requirements shall be as specified below:

Fill Utilized For	Required Density (%)	Maximum Permissible Lift Thickness As Compacted, Inches
Backfill & Utility Trenches Under Foundations & Pavements	95-100	8
Backfill Around Structures	95-100	8
Field and Utility Trench Backfill Under Sidewalks and Open Areas	90-100	8

- B. Field density tests shall be performed in sufficient number to insure that the specified density is being obtained. Tests shall be in accordance with ASTM Standards D 1556 or D 2922/D 3017



and shall be performed as authorized by the Engineer. Payment for field density tests shall be by the Contractor. Contractor shall provide suitable notification for coordination of testing. Delays due to the lack of adequate advance notification shall be the responsibility of the Contractor.

### 3.7 SITE GRADING

- A. Where indicated or directed, topsoil shall be removed without contamination with subsoil and spread on areas already graded and prepared for topsoil, or transported and stockpiled convenient to areas for later application, or at locations specified. Topsoil shall be stripped to full depth and, when stored, shall be kept separate from other excavated materials and piled free of roots, stones, and other undesirable materials.
- B. Following stripping, fill areas shall be scarified to a minimum depth of six (6) inches to provide bond between existing ground and the fill material. Material should be placed in successive horizontal layers not exceeding twelve (12) inches uncompacted thickness. In general, layers shall be placed approximately parallel to the finished grade line.
- C. In general and unless otherwise specified, the Contractor may use any type of earth moving equipment he has at his disposal, provided such equipment is in satisfactory condition and of such type and capacity that the work may be accomplished properly and the grading schedule maintained. During construction, the Contractor shall route equipment at all times, both when loaded and empty, over the layers as they are placed, and shall distribute the travel evenly over the entire area.
- D. The material in the layers shall be of the proper moisture content before rolling or tamping to obtain the prescribed compaction. Wetting or drying throughout the layer shall be required. Should the material be too wet to permit proper compaction or rolling, all work on the fill thus affected shall be delayed until the material has dried to the required moisture content. If the material is too dry, it shall be sprinkled with water and manipulated to obtain the uniform moisture content required throughout a layer before it is compacted.
- E. Each layer of the fill shall be compacted by rolling or tamping to the standard specified in Paragraph 3.06 and not less than 90% maximum density at optimum moisture content as determined by field density tests made by the Standard Proctor method in accordance with ASTM D 698. In general and unless otherwise specified, the Contractor may use any type of compaction equipment such as sheepsfoot rollers, pneumatic rollers, smooth rollers and other such equipment he has at his disposal, provided such equipment is in satisfactory condition and is of such design, type, size, weight, and quantity to obtain the required density in the embankment. If at any time the required density is not being obtained with the equipment then in use by the Contractor, the Engineer may require that different and/or additional compaction equipment be obtained and placed in use at once to obtain the required compaction.
- F. The Contractor shall be responsible for the stability of all embankments and shall replace any portion which, in the opinion of the Engineer, has become displaced due to carelessness or negligence on the part of the Contractor.



3.8 TOPSOIL

- A. Provide all labor, materials, equipment and services required for furnishing and placing topsoil. Samples of topsoil shall be submitted to the Engineer for review before topsoil is placed. The material shall be good quality loam and shall be fertile, friable, mellow; free from stones larger than one (1) inch, excessive gravel, junk metal, glass, wood, plastic articles, and roots and shall have a liberal amount of organic matter. Light sand loam or heavy clay loam will not be acceptable.
- B. The topsoil shall be 3 inches thick in all areas to be seeded. No topsoil shall be placed until the area to be covered is excavated or filled to the required grade. Imported backfill material will be stockpiled on site for structure backfilling and top soiling.

END OF SECTION 312000

## SECTION 312319 - DEWATERING

### PART 1 - GENERAL

#### 1.1 SCOPE OF WORK

- A. Furnish all labor and equipment required to dewater all excavations.
- B. Dewatering of all excavations shall be the responsibility of the Contractor, and no additional compensation will be allowed for same unless specifically included as a bid item.

#### 1.2 RELATED WORK SPECIFIED ELSEWHERE

- A. Earthwork is included in Section 312000.
- B. Erosion and Sedimentation Control is included in Section 312500.

### PART 2 - PRODUCTS (Not Applicable)

### PART 3 - EXECUTION

#### 3.1 GENERAL

- A. Dewatering equipment shall be of adequate size and quantity to assure maintaining proper conditions for installing pipe, concrete, backfill or other material or structure in the excavation.
- B. Dewatering shall include proper removal of any and all liquid, regardless of its source, from the excavation and the use of all practical means available to prevent surface runoff from entering any excavation.
- C. The site shall be kept free of surface water at all times. The Contractor shall install drainage ditches, dikes and shall perform all pumping and other work necessary to divert or remove rainfall and all other accumulations of surface water from the excavations. The diversion and removal of surface water shall be performed in a manner that will prevent flooding and/or damage to other locations within the construction area where it may be detrimental. The Contractor shall provide, install and operate sufficient trenches, sumps, pumps, hose piping, well points, deep wells, etc., necessary to depress and maintain the ground water level at least two (2) feet below the base of the excavation during all stages of construction operations. The ground water table shall be lowered in advance of excavation and maintained a minimum of two (2) feet below the lowest excavation subgrade made until the structure has sufficient strength and weight to withstand horizontal and vertical soil and water pressures from natural ground water.
- D. Dewatering operations should not discharge into the sanitary sewer system, or into any ditch, pipe or other conveyance that leads to a regulated water body, except as authorized by a KPDES permit.

END OF SECTION 312319

SECTION 312500 - EROSION AND SEDIMENTATION CONTROL (Areas Less Than One Acre)

PART 1 - GENERAL

1.1 SCOPE OF WORK

- A. Furnish all labor, materials, and equipment required for erecting, maintaining and removing temporary erosion and sedimentation controls as shown on the Drawings and as specified herein and as recommended by state and local regulatory agencies.
- B. Temporary erosion controls include, but are not limited to grassing, mulching, seeding, providing erosion control and turf reinforcement mats on all disturbed surfaces including waste area surfaces and stockpile and borrow area surfaces; scheduling work to minimize erosion and providing interceptor ditches at those locations which will ensure that erosion during construction will be either eliminated or maintained within acceptable limits.
- C. Temporary sedimentation controls include, but are not limited to, silt dams, traps, barriers, and appurtenances on sloped surfaces which will ensure that sedimentation pollution will be either eliminated or maintained within acceptable limits.
- D. Contractor is responsible for providing and maintaining effective temporary erosion and sediment control measures prior to and during construction or until final controls become effective.
- E. The Contractor shall be responsible for placement of erosion and sedimentation controls. Prior to construction, the Contractor shall develop an erosion control plan and submit to the Engineer for review. Prior to excavation, fill or grade work, the Contractor shall place controls in locations required by the erosion control plan. If during the course of construction, the Engineer determines additional controls are required, the Contractor shall furnish, install and maintain additional mulching, blankets and/or sediment barriers to control erosion and sedimentation to the satisfaction of the Engineer.
- F. The Contractor shall notify the appropriate state agency before beginning construction, and shall implement erosion control measures as may be required by state and federal agencies. If disturbed area is greater than one acre, Contractor shall submit a signed Notice of Intent form to the Division of Water at least 48 hours prior to beginning of construction activity.
- G. The Contractor shall inspect and repair all erosion and sedimentation controls every seven (7) days and after each rainfall of 0.5 inch or greater.
- H. Bare soil areas must be seeded, mulched, or covered after 14 days if no work will be done in the area within the next 7 days.

1.2 RELATED WORK

- A. Dewatering is included in this Division, Section 312319.
- B. Final erosion protection measures where required are included in this Section.

4697

EROSION AND SEDIMENTATION CONTROL  
(Areas Less Than One Acre)

312500-1

C. Utility Line Stream Crossings – Division 2

PART 2 – PRODUCTS

2.1 SEED

A. The seed mixture to be sown shall be in the following proportions:

<u>Common Name</u>	<u>Proportion By Weight</u>	<u>% of Purity</u>	<u>% of Germination</u>
Fine Lawn Fescue	40	90	85
Chewings Fescue	25	90	85
Italian Rye Grass	20	90	85
Red Top	10	90	85
White Clover	5	95	90

B. All seed shall be fresh and clean and shall be delivered mixed, in unopened packages, bearing a guaranteed analysis of the seed mixture.

2.2 FERTILIZER

A. Just prior to the planting of turf, evenly broadcast 15 pounds per thousand square feet of fertilizer, 10-10-10 (nitrogen, phosphorus, potassium). Disc or harrow fertilizer 2 to 4 inches into the soil.

B. Fertilizer shall be delivered to the site in the original unopened container bearing the manufacturer’s guarantee analysis. Any fertilizer that becomes caked or damaged making it unsuitable for use, will not be accepted.

2.3 SOD

A. Sod shall be at least 70% Bluegrass, strongly rooted and free of weeds.

B. It shall be mowed to a height not to exceed 3” before lifting, and shall be of uniform thickness with not over 1-1/2” of soil.

2.4 MULCH

A. Mulch for seeded areas shall be Conwed Hydro Mulch, Silva-Fiber, or equal. It shall be suitable for use in a water slurry or for application with hydraulic equipment.

B. Clean straw is acceptable as mulch. It shall be spread at the rate of one (1) bale per 1,000 feet (approximately 2” loose depth).

C. Mulch on slopes at or greater than 3:1 shall be held in place with turf reinforcement mat.

- D. Mulch on areas subject to surface water run-off or in drainage ditches shall be held in place with turf reinforcement mat.

## 2.5 EROSION CONTROL BLANKETS

- A. Erosion Control Blanket shall be made up of biodegradable and/or photodegradable products such as jute, wood fiber, coconut fiber, straw and degradable plastic netting. They shall degrade at a rate of approximately 6 months to 24 months.
- B. Erosion Control Blanket shall be installed on slopes less than 3:1.

## 2.6 TURF REINFORCEMENT MAT

- A. Where indicated on the Contract Drawings or as described in the Specifications, in all ditches and drainage channels and on all slopes equal to or greater than 3:1, Turf Reinforcement Mat shall be installed for long-term erosion control.
- B. Turf Reinforcement Mat shall consist of top and bottom heavy weight netting and biodegradable matrix such as coconut fiber or aspen curled wood excelsior, as manufactured by Western Excelsior Excel PP5-8 Turf Reinforcement Mat or equal. Product shall degrade at a minimum rate of 36 months.
- C. Where slope and hydraulic conditions are severe, a synthetic matrix may be used, based on manufacturer's recommendations.

## 2.7 SILT FENCE

- A. Temporary Silt Fence shall consist of woven geotextile fabric attached to 2" X 2" X 48" tall hardwood stakes.
  - 1. Exposed Fabric shall be 36" and a minimum of 4" shall be buried in trench as shown on the Detail Drawings.
  - 2. Stakes shall be at 6' centers unless stated otherwise on Contract Documents.
- B. Temporary Reinforced Silt Fence
  - 1. For areas of steep slopes and high flows, where indicated on the Contract Drawings, or as directed by state or local regulations, Reinforced Silt Fence shall be installed.
  - 2. Fabric shall be woven monofilament geotextile attached to 11 gauge steel fencing of 2" X 4" grid.
  - 3. Stakes shall be 5' tall steel and shall be installed on 4' centers.
  - 4. Fabric and fencing shall be buried in trench as shown on the Detail Drawings.
- C. Spacing of Silt Fences on slopes shall be according to the following table, or as directed by state or local regulatory agencies:

Slope Angle	Soil Type		
	Silty	Clays	Sandy
Very Steep (1:1)	50 ft.	75 ft.	100 ft.
Steep (2:1)	75 ft.	100 ft.	125 ft.
Moderate (4:1)	100 ft.	125 ft.	150 ft.
Slight (10:1)	125 ft.	150 ft.	200 ft.

- D. If runoff flows along the uphill side of the silt fence, Contractor shall install “J-hooks” every 40 to 80 feet. These are curved sections of silt fence above the continuous fence that serve as small dams to stop and hold the flow to allow sediment to settle.

2.8 FIBER ROLLS

- A. On long slopes less than 10:1, and where indicated on the Contract Drawings or recommended by the regulatory agency, Fiber Rolls shall be installed.
- B. Fiber Rolls shall be made of wood shavings, coconut fiber or other similar material encased in heavy duty netting.
- C. Wooden stakes at 4'-0" on center shall be used to anchor the Fiber Rolls along the contours of the slope.

2.9 AGGREGATE SILT CHECKS

- A. Where needed to slow flow velocity, to cause ponding or to protect storm water inlet structures, Aggregate Silt Checks shall be installed.
- B. Aggregate Silt Checks shall consist of rock of various sizes ranging from 2" to 6" contained in or placed on geotextile filter fabric. Pea-stone or gravel-filled bags are acceptable for temporary silt checks in low-flow conditions.

2.10 RIP RAP

- A. Rip Rap shall be installed at the outlets of storm drains and on channel banks as noted on the Contract Drawings and/or recommended by state and local regulatory agencies.
- B. Rip Rap shall have no less than 80%, by volume, of individual stones that range in size from 0.0247 to 1.483 cubic feet.

2.11 CONSTRUCTION ENTRANCE PAD

- A. Contractor shall construct entrance pads at all locations where vehicles will enter or exit the site.
- B. Pad shall be a minimum of 20 feet wide, 50 feet long and 6" thick, and consist of No. 2 stone laid on top of filter fabric.

## PART 3 - EXECUTION

### 3.1 GENERAL

- A. Erosion and sediment control practices shall be consistent with the requirements of the state and local regulatory agencies and in any case shall be adequate to prevent erosion of disturbed and/or regraded areas.
- B. Contractor is responsible for notifying the state regulatory agency concerning inclusion under the NPDES General Permit for Storm Water Discharges from Construction Activities.
- C. Gravity sewer lines and force mains that cross streams shall be constructed by methods that maintain normal stream flow and allow for a dry exaction. Water pumped from the excavation shall be contained and allowed to settle prior to reentering the stream. Excavation equipment and vehicles shall operate outside of the flowing portion of the stream. Spoil material from the sewer line excavation shall not be allowed to enter the flowing portion of the stream. The provisions of this condition shall apply to all types of utility line stream crossings.
- D. Removal of riparian vegetation in the utility line right-of-way shall be limited to that necessary for equipment access. Effective erosion and sedimentation control measures must be employed at all times during the project to prevent degradation of waters of the Commonwealth. Site regrading and reseeding will be accomplished with 14 days after disturbance.

### 3.2 SEEDING

- A. The areas to be seeded shall be thoroughly tilled to a depth of at least 4" by discing, harrowing, or other approved methods until the condition of the soil is acceptable to the Engineer. After harrowing or discing, the seed bed shall be dragged and/or hand raked to finish grade.
- B. The incorporation of the fertilizer and the agricultural lime may be a part of the tillage operation and shall be applied no less than 24 hours nor more than 48 hours before the seed is to be sown.
- C. Seed shall be broadcast either by hand or approved sowing equipment at the rate of ninety (90) pounds per acre (two pounds per 1,000 square feet), uniformly distributed over the area. Broadcasting seeding during high winds will not be permitted. The seed shall be drilled or raked into a depth of approximately 2 inch and the seeded areas shall be lightly raked to cover the seed and rolled. Drilling seeding shall be done with approved equipment with drills not more than 3 inches apart. All ridges shall be smoothed out, and all furrows and wheel tracks likely to develop into washes, shall be removed.
- D. After the seed has been sown, the areas so seeded shall be mulched with clean straw at the rate of one (1) bale per 1,000 feet (approximately 2 inch loose depth). Mulch on slopes and in all ditches and drainage channels shall be held in place with erosion control blankets.
- E. Areas seeded shall be watered and protected until a uniform stand develops, and then inspected periodically and maintained appropriately. Displaced mulch shall be replaced or any damage to the seeded area shall be repaired promptly, both in a manner to cause minimum disturbance to the existing stand of grass. If necessary to obtain a uniform stand, the Contractor shall

refertilize, reseed and mulch as needed. Scattered bare spots up to one (1) square yard in size will be allowed up to a maximum of 10 percent of any area.

- F. Payment for seeding and mulching shall be included in the Contractor's bid.

### 3.3 SOD

- A. To install, bring soil to final grade and clear of trash, wood, rock, and other debris. Apply topsoil, fertilizer at approximately 1000 lbs per acre.
- B. Use sod within 36 hours of cutting. Lay sod in straight lines. Butt joints tightly, but do not overlap joints or stretch sod. Stagger joints in adjacent rows in a brickwork type pattern. Use torn or uneven pieces on the end of the row.
- C. Notch into existing grass. Anchor sod with pins or stakes if placed on slopes greater than 3:1. Roll or tamp sod after installation and water immediately. Soak to a depth of 4 to 6 inches. Replace sod that grows poorly. Do not cut or lay sod in extremely wet or cold weather. Do not mow regularly until sod is well established.

### 3.4 INSTALLATION OF EROSION AND SEDIMENT CONTROL DEVICES

- A. All erosion and sediment control products and materials shall be installed per manufacturer's recommendations and in accordance with the Kentucky Erosion Prevention and Sediment Control Field Guide.
- B. Contractor shall pay special attention to the trenching-in of the bottoms of silt fence, the staking of sediment barriers, and the stapling of erosion control blankets.

### 3.5 MAINTENANCE OF EROSION AND SEDIMENT CONTROL DEVICES

- A. Erosion and sedimentation controls shall be inspected weekly and after rain events of 0.5 inch or greater. Replace silt fencing as needed, filter stone which is dislodged, erosion control blanket which is damaged, and make other necessary repairs.
- B. Remove sediment from fences and barriers when it accumulates to half the height of the barrier, or more often as needed.

### 3.6 CLEAN UP

- A. Upon completion of the project and/or establishment of satisfactory turf, vegetation or permanent erosion control structures, Contractor shall remove all temporary devices and properly dispose of such.

END OF SECTION 312500



## SECTION 315000 - EXCAVATION SUPPORT AND PROTECTION

### PART 1 - GENERAL

#### 1.1 SCOPE OF WORK

- A. This Section includes, but is not limited to, the following:
  - 1. Shoring and bracing necessary to protect existing buildings, streets, walkways, utilities, and other improvements and excavation against loss of ground or caving embankments.
  - 2. Maintenance of shoring and bracing.
  - 3. Removal of shoring and bracing, as required.
- B. Types of shoring and bracing systems include, but are not limited to, the following:
  - 1. Steel H-section (soldier) piles.
  - 2. Timber lagging.
  - 3. Steel sheet piles.
  - 4. Portable Steel Trench Box.
- C. Building excavation is specified in another Section.

#### 1.2 RELATED DOCUMENTS

- A. Drawings and general provisions of Contract, including General and Supplementary Conditions and Division 01 Specification Sections, apply to this Section.

#### 1.3 SUBMITTALS

- A. General: Submit the following in accordance with Conditions of Contract and Division 01 Specification Section 013323.

Layout drawings for excavation support system and other data prepared by, or under the supervision of, a qualified professional engineer. System design and calculations must be acceptable to local authorities having jurisdiction. This submittal is for information only. Engineer's review is not for adequacy design, but to verify that it has been designed by a licensed professional. Design of shoring is part of means and methods of construction and remains solely the responsibility of the contractor.

#### 1.4 QUALITY ASSURANCE

- A. Engineer Qualifications: A professional engineer legally authorized to practice in jurisdiction where Project is located, and experienced in providing successful engineering services for excavation support systems similar in extent required for this Project.
- B. Supervision: Engage and assign supervision of excavation support system to a qualified

professional engineer foundation consultant.

- C. Regulations: Comply with codes and ordinances of governing authorities having jurisdiction.

#### 1.5 JOB CONDITIONS

- A. Before starting work, verify governing dimensions and elevations. Verify condition of adjoining properties. Take photographs to record any existing settlement or cracking of structures, pavements, and other improvements. Prepare a list of such damages, verified by dated photographs, and signed by Contractor and others conducting investigation.
- B. Survey adjacent structures and improvements, employing qualified professional engineer, establishing exact elevations at fixed points to act as benchmarks. Clearly identify benchmarks and record existing elevations.
- C. During excavation, resurvey benchmarks weekly, maintaining accurate log of surveyed elevations for comparison with original elevations. Promptly notify Engineer if changes in elevations occur or if cracks, sags, or other damage is evident.

#### 1.6 EXISTING UTILITIES

- A. Protect existing active sewer, water, gas, electricity and other utility services and structures.
- B. Notify municipal agencies and service utility companies having jurisdiction. Comply with requirements of governing authorities and agencies for protection, relocation, removal, and discontinuing of services.
- C. The Contractor shall be solely responsible for locating the existing utilities, verifying their size and elevation, protecting them during construction, repairing as needed or temporary relocating or supporting when required.

### PART 2 - PRODUCTS

#### 2.1 MATERIALS

- A. General: Provide adequate shoring and bracing materials which will support loads imposed. Materials need not be new, but should be in serviceable condition.
- B. Structural Steel: ASTM A 36.
- C. Steel Sheet Piles: ASTM A 328.
- D. Timber Lagging: Any species, rough-cut, mixed hardwood, nominal 3 inches thick, unless otherwise indicated.
- E. Portable Steel Trench Box shall be OSHA approved.

### PART 3 - EXECUTION

#### 3.1 SHORING

- A. Wherever shoring is required, locate the system to clear permanent construction and to permit forming and finishing of concrete surfaces. Provide shoring system adequately anchored and braced to resist earth and hydrostatic pressures.
- B. Shoring systems retaining earth on which the support or stability of existing structures is dependent must be left in place at completion of work.

#### 3.2 BRACING

- A. Locate bracing to clear columns, floor framing construction, and other permanent work. If necessary to move a brace, install new bracing prior to removal of original brace.
- B. Do not place bracing where it will be cast into or included in permanent concrete work, except as otherwise acceptable to Engineer.
- C. Install internal bracing, if required, to prevent spreading or distortion of braced frames.
- D. Maintain bracing until structural elements are supported by other bracing or until permanent construction is able to withstand lateral earth and hydrostatic pressures.
- E. Remove sheeting, shoring, and bracing in stages to avoid disturbance to underlying soils and damage to structures, pavements, facilities, and utilities.
- F. Repair or replace, as acceptable to Engineer, adjacent work damaged or displaced through installation or removal of shoring and bracing work.

END OF SECTION 315000

DIVISION 32  
EXTERIOR IMPROVEMENTS

## SECTION 321216 – ASPHALT PAVING (KENTUCKY)

### PART 1 - GENERAL

#### 1.1 SCOPE OF WORK

- A. The hot-mix asphalt paving work includes the construction of an aggregate base course, asphalt base and wearing courses as specified herein. This work is to replace paving disturbed by the construction and any damages to paving by Contractor's operations, as well as new pavement and driveways, within the limits shown on the plans.

#### 1.2 RELATED WORK SPECIFIED ELSEWHERE

- A. The general provisions of the Contract, including General Conditions and General Requirements apply to the work specified in this section.
- B. Earthwork: Section 312000

#### 1.3 APPLICABLE STANDARDS

- A. All references in this section to the Standard Specifications shall refer to the most recent Edition of Standard Specifications for Road and Bridge Construction with all amendments thereto as published by the Kentucky Transportation Cabinet (KYTC).

#### 1.4 SUBMITTALS

- A. Job-Mix Designs: For each job mix proposed for the Work.
- B. Comply with the requirements of Section 013323.

#### 1.5 QUALITY ASSURANCE

- A. Hot Mix Asphalt Producer Qualifications: Engage a firm experienced in producing hot-mix asphalt similar to that indicated for this Project and with a record of successful in-service performance.
- B. Producer firms shall be qualified through the Kentucky Transportation Cabinet as an approved Asphalt Mix Producing Firm.
- C. Testing and inspection: The Contractor shall retain a qualified testing laboratory for testing and inspection.

1.6 PROJECT CONDITIONS

- A. Environmental Limitations: Do not apply asphalt materials if subgrade is wet or excessively damp. Comply with the provisions of KYTC Standard Specifications Section 403.03.01 for temperature requirements.
- B. Grade Control: Establish and maintain required lines and elevations.

PART 2 – PRODUCTS

2.1 AGGREGATES

- A. General: Use materials and gradations that have performed satisfactorily in previous installations.
- B. Aggregate Base Course: Dense Graded Aggregate Base (DGA) complying with Section 302 and 805 of the Standard Specifications.
- C. Coarse Aggregate: Sound, angular crushed stone, or crushed gravel, complying with Standard Specifications Section 805.

2.2 ASPHALT MATERIALS

- A. Asphalt Binder: AASHTO MP 1, Performance Graded Binder PG 64-22 for general applications.
- B. Tack Coat: Comply with provisions in KYTC Standard Specifications Section 406.

2.3 MIXES

- A. Hot-Mix Asphalt: Hot-laid, hot-mix asphalt plant mixes meeting the requirements of the Standard Specifications of the Kentucky Transportation Cabinet (KYTC) or Asphalt Institute (AI) MS-2 and complying with the following requirements:
  - 1. Base Course: Produce KYTC mixture designation Class 2 Base. There shall be no restrictions on polish resistant aggregates (utilize KYTC Type “D” aggregates). Recycled Asphalt Pavement (RAP) may be utilized in accordance with Standard Specifications Section 409.
  - 2. Surface Course: KYTC mixture designation Class 2 Surface. The mixture gradation may pass through the restricted zone and there shall be no restriction on polish resistant aggregates (utilize KYTC Type “D” aggregates). Recycled Asphalt Pavement (RAP) may be utilized in accordance with Standard Specifications Section 409.
- B. Hot-Mix Asphalt: Hot-laid, hot-mix asphalt plant mixes designed according to procedures established by the Kentucky Transportation Cabinet (KYTC) and complying with the following requirements.

1. Provide mixes complying with composition, grading, and tolerance requirements Standard Specifications for the following nominal, maximum aggregate sizes:
  - a. Base Course: Mixture with a nominal maximum aggregate size of 0.75 inch with a minimum Voids in the Mineral Aggregate (VMA) of 12 percent.
  - b. Surface Course: Mixture with a nominal maximum aggregate size of 0.38 inch with a minimum VMA of 14 percent.

### PART 3 - EXECUTION

#### 3.1 INSPECTION

- A. Pavement installer must examine the areas excavated and backfilled and conditions under which pavement is to be constructed. Notify the Contractor in writing of conditions detrimental to the proper and timely completion of the work. Do not proceed with the work until satisfactory embankments and subgrade have been established to a uniform line, properly shaped and compacted.
- B. Verify that subgrade is dry and in suitable condition to support paving and imposed loads.
- C. Proof-roll subbase using loaded dump trucks or heavy rubber-tired construction equipment to locate areas that are unstable or that require further compaction.
- D. Proceed with paving only after unsatisfactory conditions have been corrected.
- E. Repairs to Base Course: Fill excavated pavements with hot-mix asphalt base mix and, while still hot, compact flush with adjacent surface.
- F. Patching: Partially fill excavated pavements with hot-mix asphalt base mix and, while still hot, compact. Cover asphalt base course with compacted, hot-mix surface layer finished flush with adjacent surfaces.

#### 3.2 AGGREGATE BASE COURSES

- A. Place aggregate base course on subgrades free of mud, frost, snow, or ice in accordance with Section 302 of the Standard Specifications.
- B. On prepared subgrade, place base course as follows:
  1. Shape base course to required crown elevations and cross-slope grades.
  2. Place base course that exceeds 9 inches in compacted thickness in layers of equal thickness, with no compacted layer more than 6 inches thick or less than 3 inches thick.
  3. Compact base course at optimum moisture content to required grades, lines, cross sections, and thickness to not less than 98 percent of maximum dry unit weight according to ASTM D698 or in accordance with Section 302.03.04 of the Standard Specifications.

### 3.3 SURFACE PREPARATION

- A. General: Immediately before placing asphalt materials, remove loose and deleterious material from substrate surfaces. Ensure that prepared subgrade is ready to receive paving.
  - 1. Sweep loose granular particles from surface of unbound-aggregate base course. Do not dislodge or disturb aggregate embedded in compacted surface of base course.
- B. Tack Coat: Comply with provisions in Standard Specifications Section 406. Apply to the surface of concrete surfaces, existing asphalt surfaces and, when necessary, to newly constructed asphalt surfaces.

### 3.4 HOT-MIX ASPHALT PLACING

- A. Machine place hot-mix asphalt on prepared surface, spread uniformly, and strike off. Place asphalt mix by hand to areas inaccessible to equipment in a manner that prevents segregation of mix. Comply with applicable provisions of KYTC Standard Specifications Section 403 for delivery, placement, spreading and compaction of the mixture.
  - 1. Average Density: 92 percent of reference maximum theoretical density according to ASTM D 2041, but not less than 90 percent.

### 3.5 FIELD QUALITY CONTROL

- A. Thickness Tolerances: Compact each course to produce the thickness indicated within the following tolerances:
  - 1. Aggregate and asphalt base Course: Plus or minus 1/2 inch.
  - 2. Asphalt surface course: Plus or minus 1/4 inch.
  - 3. Provide a minimum fall of 2% to facilitate drainage unless otherwise indicated on the Drawings.
- B. Surface Smoothness: Compact each course to produce a surface smoothness with the following tolerances as determined using a 10-foot straightedge applied transversely or longitudinally to paved areas:
  - 1. Aggregate base course: 3/8 inch.
  - 2. Asphalt base course: 1/4 inch.
  - 3. Asphalt surface course: 1/8 inch.
  - 4. Crowned surfaces: Test with crowned template centered and at a right angle to crown. Maximum allowable variance from template is 1/4 inch.
- C. In-Place Density: Field density test of in-place compacted aggregate base will be determined by nuclear method in accordance with ASTM D 2940. Field density of in-place compacted pavement will be determined by nuclear method according to ASTM D 2950 and correlated with ASTM D 1188 or ASTM D 2726. Test will be made for every 1,000 square yards or less of installed pavement.



- D. Core Sampling: If required to confirm either thickness tolerances or compaction of asphalt courses, core samples shall be taken and tested according to ASTM D 3549 for thickness and ASTM D 1188 or ASTM D 2726 for compaction. Determination of need for core samples will be made by the Engineer.

END OF SECTION 321216

## SECTION 329200 - LAWNS AND GRASSES

### PART 1 - GENERAL

#### 1.1 DESCRIPTION OF WORK

- A. Provide all labor, materials, equipment, and services required for seeding of all disturbed areas caused by construction activities and for installation of sod where indicated on the Contract Drawings or specified herein.

#### 1.2 RELATED DOCUMENTS

- A. Drawings and General Provisions of Contract, including General and Supplementary Conditions and Division-1 Specification sections, apply to Work of this Section.
- B. Earthwork: Section 312000

#### 1.3 MAINTENANCE

- A. Maintenance shall begin immediately following the last operation of installation for each portion of lawn.
- B. Lawns shall be maintained by watering, mowing, and for resodding for a period of forty-five (45) days. At the end of this period an inspection will be made and any deficiencies, which may be attributable to the Contractor, will be noted in writing. At this time, the Owner will assume the maintenance. Another inspection will be made at the beginning of the next planting season, and any of the previously noted deficiencies still existing shall be repaired by the Contractor.

#### 1.4 INSPECTION FOR ACCEPTANCE

- A. The Inspection of the Work:
  - 1. The inspection of the work of lawns to determine the completion of contract work exclusive of the possible replacement of plants, will be made by the Architect/Engineer upon written notice requesting such inspection submitted by the Contractor at least ten (10) days prior to the anticipated date.
- B. Acceptance:
  - 1. After inspection, the Contractor will be notified in writing by the Owner of acceptance of all work of this Section, exclusive of the possible replacement of plants subject to guaranty, or if there are any deficiencies of the requirements of completion of the Work.

PART 2 - PRODUCTS

2.1 WATER

- A. Water used in this work shall be suitable for irrigation and free from ingredients harmful to plant life.
- B. Hose and other watering equipment required for the Work shall be furnished by the Contractor.

2.2 TOPSOIL

- A. The Contractor shall furnish and place sufficient topsoil for the seeding and installation of sod.

2.3 FERTILIZER

- A. Commercial fertilizer for lawn areas shall be complete fertilizer, formula 10-10-10, for lawns and shall conform to the applicable state fertilizer laws. Fertilizer shall be uniform in composition, dry and free flowing and shall be delivered to the site in the original, unopened containers, each bearing the manufacturer's guarantee analysis. Any fertilizer which becomes caked or otherwise damaged making it unsuitable for use will not be accepted.
- B. Fertilizer shall be applied at the rate of 25 pounds per 1,000 square feet.

2.4 GRASS SEED

- A. The seed mixture to be sown shall be in the following proportions:

<u>Common Name</u>	<u>Proportion By Weight</u>	<u>% of Purity</u>	<u>% of Germination</u>
Fine Lawn Fescue	40	90	85
Chewings Fescue	25	90	85
Italian Rye Grass	20	90	85
Red Top	10	90	85
White Clover	5	95	90

- B. All seed shall be fresh and clean and shall be delivered mixed, in unopened packages, bearing a guaranteed analysis of the seed mixture.
- C. Germination must be certified to conform to the following minimums:

Purity	90%
Germination	85%

2.5 SOD

- A. Sod shall be at least 70% Bluegrass, strongly rooted and free of pernicious weeds.

- B. It shall be mowed to a height not to exceed 3" before lifting, and shall be of uniform thickness with not over 1-1/2" or less than 1" of soil.

## 2.6 MULCH

- A. Mulch for seeded areas shall be Conwed Hydro Mulch, Silva-Fiber, or equal. It shall be suitable for use in a water slurry or for application with hydraulic equipment.
- B. Clean straw is acceptable as mulch. It shall be spread at the rate of one (1) bale per 1,000 feet (approximately 2 inch loose depth).
- C. Mulch on slopes greater than 1: 3 shall be held in place with turf reinforcing mat.
- D. Mulch on areas subject to surface water run-off or in drainage ditches shall be held in place with erosion control netting.

## PART 3 - EXECUTION

### 3.1 TIME OF PLANTING

- A. Planting operations shall be conducted under favorable weather conditions during seasons which are normal for such work as determined by accepted practice in the locality of the project. At the option and on full responsibility of the Contractor, planting operations may be conducted under unseasonable conditions without additional compensation.

### 3.2 LAWNS

- A. Areas to be sodded are designated on the Drawings. All other lawn areas, including areas of cut and fill and where existing ground has been disturbed by construction operations shall be seeded.
- B. Fertilizer:
  - 1. Fertilizer shall be applied at the rate of 25 pounds per 1,000 square feet to the lawn area being prepared for planting and mixed lightly into the top few inches of topsoil. Fertilizer may be mixed with and distributed with grass seed.
- C. Planting of Lawns:
  - 1. Sowing of Seed:
    - a. Immediately before any seed is to be sown, the ground shall be scarified as necessary, and shall be raked until the surface is smooth, friable and of uniformly fine texture. Lawn areas shall be seeded evenly with a mechanical spreader at the rate of 4 pounds per 1,000 square feet of area, lightly raked, rolled with a 200-pound roller and watered with a fine spray. The method of seeding may be varied at the discretion of the Contractor on his own responsibility to establish a

smooth, uniform turf composed of the grasses specified. The sowing of seed shall be done only within the season extending from March 1st to May 15th and from September 1st to October 15th, unless other seasons may be approved by the Owner.

2. Laying of Sod:

- a. Before any sod is laid, all soft spots and inequalities in grade shall be corrected. Fertilizer spread shall be raked in. Sod shall be laid so that no voids occur, tamped or rolled and then thoroughly watered. The complete sodded surface shall be true to finished grade, even and firm at all points. Sodding shall be done only within the seasons extending from March 1st to May 15th and from September 1st to October 15th, unless other seasons may be approved by the Owner.

3. Sod on Slopes:

- a. Sod on slopes 2 to 1 or steeper shall be held in place by wooden pins about 1-inch square and about 6 inches long driven through the sod into the soil until they are flush with the top of the sod, or by other approved methods for holding the sod in place.

4. Mulching:

- a. All seeded areas are to be mulched with Conwed Hydro Mulch, Silva-Fiber, or equal, or with clean straw as specified under PRODUCTS. Mulch shall be applied at the rate of 1,500 pounds per acre. It may be applied with hydraulic equipment or may be added to the water slurry in a hydraulic seeder and the seeding and mulching combined in one operation. Clean straw may be spread by hand to cover the seeded areas at a depth of two (2) inches. Erosion control netting shall be installed and anchored per manufacturer's instructions in areas of slopes, ditches, or surface water runoff.

3.3 CLEAN UP

- A. All soil, peat or similar material which has been brought over paved areas by hauling operations or otherwise, shall be removed promptly, keeping these areas clean at all times. Upon completion of the planting all excess soil, stone and debris which have not previously been cleaned up shall be removed from the site or disposed of as directed by the Owner. All lawns shall be prepared for final inspection.

3.4 OTHER WORK

- A. The Contractor also shall be responsible for the repair of any damage caused by his activities or those of his subcontractors, such as the storage of topsoil or other materials, operations or equipment, or other usages to all on-site areas outside the contract limits. Such repair operations shall include any regrading, seeding or other work necessary to restore such areas to an acceptable condition.

### 3.5 QUALITY CONTROL

- A. Areas seeded shall be protected until a uniform stand develops, when it will be accepted and the Contractor relieved of further responsibility for maintenance. Displaced mulch shall be replaced or any damage to the seeded area shall be repaired promptly, both in a manner to cause minimum disturbance to the existing stand of grass. If necessary to obtain a uniform stand, the Contractor shall refertilize, reseed and remulch as needed. Scattered bare spots up to one (1) square foot in size will be allowed up to a maximum of 10 percent of any area.

END OF SECTION 329200

DIVISION 33

UTILITIES

SECTION 330523 - BORING AND JACKING

PART 1 - GENERAL

1.1 SCOPE OF WORK

- A. Provide all labor, materials, equipment and services required to furnish and install all bored and jacked carrier pipes in encasement pipes under railroad and highway crossings as shown on the Drawings and/or specified herein.

1.2 RELATED WORK SPECIFIED ELSEWHERE

- A. Earthwork: Section 312000
- B. Water Distribution Piping: Section 331113

1.3 SUBMITTALS

- A. Descriptive literature, catalog cuts, and dimensional prints clearly indicating all dimensions and materials of construction, shall be submitted on all items specified herein to the Engineer for review before ordering.
- B. At the time of submission, the Contractor shall, in writing, call the Engineer’s attention to any deviations that the submittals may have from the requirements of the Contract Drawings and Specifications.
- C. Comply with all requirements of Section 013323.
- D. In accordance with the requirements of the General and Special Conditions and this Section, the following table includes, but is not limited to, the items required to be submitted:

Item Description	Shop Drawings	Product Data	Schedules	Installation Data	Parts Lists	Wiring Diagram	Samples	O & M Manual	Certificates	Warranty	Report	Other
Carrier Pipe		X							X			
Casing Pipe		X										
Casing Spacers		X		X								
Casing End Seals		X		X								



1.4 EXISTING CONDITIONS

- A. The existing piping & other utilities shown on the Contract Drawings is based on the best available information. The Engineer makes no guarantee as to the accuracy of the locations or type of piping or utility depicted. All new piping which ties into existing lines must be made compatible with that piping.
- B. So that piping conflicts may be avoided, Contractor shall locate the utility (vertically & horizontally) well ahead of the pipe laying operation to confirm exact locations of existing piping before installing any new piping.
- C. Contractor shall provide all fittings and adapters necessary to complete all connections to existing piping.

PART 2 - PRODUCTS

2.1 CARRIER PIPE

- A. Carrier pipe shall be as specified in the applicable Division 33 section unless otherwise noted.

2.2 CASING PIPE

- A. Casing pipe shall be steel, plain end, have a minimum yield point strength of 35,000 psi and conform to ASTM A 252 Grade 2 or ASTM A 139 Grade B without hydrostatic tests. The steel pipe shall have welded joints and be in at least 18 foot lengths.
- B. The diameter of the casing pipe shall be as follows:

Carrier Pipe Nominal Diameter (Inches)															
4	6	8	10	12	14	15	16	18	20	21	24	27	30	33	36
Casing Pipe Nominal Diameter (Inches)															
10	12	16	18	20	24	24	30	30	30	36	36	42	48	50	50

For carrier pipe sizes greater than 36-inches nominal diameter, the casing pipe diameter size shall be determined by the Engineer or as shown on the Contract Drawings.

- C. The wall thickness of the casing pipe shall be as follows:

Casing Pipe Nominal Diameter (Inches)								
Under 20	20 & 22	24	30	36	38	42	48	50
Casing Pipe Nominal Thickness (Inches)								
.250 (1/4")	.281 (9/32")	.312 (5/16")	.406 (13/32")	.469 (15/32")	.500 (1/2")	.562 (9/16")	.625 (10/16")	.656 (21/32")

However, should casing pipe thickness be specified or required on Highway or Railroad permit approval sheets, said permit thickness requirement shall govern. Permit approval sheets will be made available to the Contractor.

### 2.3 CASING SPACERS

- A. Stainless Steel Casing Spacers: Stainless steel casing spacers shall be bolt-on style with a shell made in two (2) sections of heavy T-304 stainless steel. Connecting flanges shall be ribbed for extra strength. The shell shall be lined with a PVC liner .090" thick with 85-90 durometer. All nuts and bolts are to be 18-8 stainless steel. Runners shall be made of ultra high molecular weight polymer with inherent high abrasion resistance and a low coefficient of friction. Runners shall be supported by risers made of heavy T-304 stainless steel. The supports shall be mig welded to the shell and all welds shall be fully passivated. Stainless steel casing spacers shall be made by Cascade Waterworks Mfg. Co., or equal.
- B. Solid Polyethylene Casing Spacers (to be used with PVC pipe only): Solid polyethylene casing spacers shall be bolt-on style with a shell made in two (2) sections. Carrier pipe shall be wrapped with rubber strap inside casing space to prevent slippage. All nuts and bolts are to be 18-8 stainless steel. Solid polyethylene casing spacers shall be made by Calpico Inc., Advance Products & Systems, Inc., or equal.

### 2.4 CASING END SEALS

- A. Wrap-around end seals - Wrap-around end seals shall be made of a waterproof flexible coal tar membrane reinforced with fiberglass, or synthetic rubber. The two exposed edges of the wrap-around seal shall be adhesively bonded forming a watertight seal. The ends of the wrap shall be sealed on the casing and carrier pipe by stainless steel bands. Wrap-around end seals shall be made by Calpico Inc., Advance Products & Systems, Inc., or equal.

## PART 3 - EXECUTION

### 3.1 CROSSINGS - GENERAL

- A. Where designated on the drawings, crossings beneath state maintained roads, not to be disturbed shall be accomplished by boring and jacking a casing pipe.
- B. Steel casing pipe for crossings shall be bored and/or jacked (or open cut installed where indicated on the Drawings) into place to the elevations shown on the drawings. All joints between lengths shall be solidly butt-welded with a smooth non-obstructing joint inside. The casing pipe shall be installed without bends. The carrier pipe shall be installed after the casing pipe is in place, and shall extend a minimum of two (2) feet beyond each end of the casing to facilitate making joint connections. The carrier shall be braced and centered with casing spacers within the casing pipe to preclude possible flotation. Casing spacers shall be installed a maximum of eight (8) feet apart along the length of the carrier pipe within the casing pipe, within two (2) feet of each side of a pipe joint, and the rest evenly spaced. The height of the supports and runners combined shall be sufficient to keep the carrier pipe at least 0.75" from the casing pipe wall at all times. Manufacturer's recommendations may govern these requirements.

- C. At each end of the casing pipe, the carrier pipe shall be sealed with casing end seals. The end seals shall extend a minimum of 12 inches in each direction from the end of the casing pipe.
- D. Wood skids are not an acceptable method of supporting the carrier pipe.

### 3.2 CROSSING - RAILROAD

- A. All water or sewer line crossings of railroads shall be prominently marked at railroad right-of-way lines, on both sides of the track crossing, by durable, weatherproof signs located over the center of the water line. When possible, signs shall be located so that when standing at one sign, the other marker is visible. Signs shall show the following:
  - 1. Name and address of Owner.
  - 2. Contents of pipe.
  - 3. Pressure in pipe.
  - 4. Pipe depth below grade at point of sign.
  - 5. Emergency telephone number in event of pipe rupture.
- B. Contractor must adhere to all safety requirements of the Railway line involved in the crossing.
  - 1. All operations shall be conducted so as to not interfere with, interrupt, or endanger the operation of trains nor damage, destroy, or endanger the integrity of railroad facilities. The Contractor shall provide written acknowledgment to the Railway line that the Contractor and its employees have received, read, and understood the safety rules. Operations will be subject to inspection at any and all time.
  - 2. All cranes, lifts, or other equipment that will be operated in the vicinity of the railroad's electrification and power transmission facilities shall be electrically grounded in an approved manner.
  - 3. At all times, while work is in progress, a field supervisor with no less than twelve (12) months experience in the operation of the equipment being used shall be present. If boring equipment or similar machines are being used, the machine operator shall also have a minimum of twelve (12) months experience in the operation of the equipment being used.
  - 4. Whenever equipment or personnel are working closer than fifteen (15) feet from the centerline of an adjacent track, that track shall be considered as being obstructed. Operations closer than fifteen (15) feet from the centerline of the track shall be conducted only with the permission of, and as directed by, a duly qualified railroad employee present at the site of the work.
  - 5. Crossing the tracks at grade by equipment and personnel is prohibited except by prior arrangement with, and as directed by, the railroad line. A separate permit must be obtained, by the Contractor, for any "at grade" crossing of the tracks.
- C. All railroad costs incurred by the Railway line due to work associated with the crossing (inspection, flagging, track work, etc.) shall be paid by the Owner. However, it is the Contractor's responsibility to coordinate the work with the Railway.
- D. Contractor shall notify the Railway line's area engineer a minimum of 14 working days prior to desired start of construction.

### 3.3 BORING AND JACKING

- A. The Contractor shall excavate his own pits, as he may deem necessary, and will set his own line and grade stakes which shall be checked by the Engineer. Permits, as required, will be furnished or obtained by the Owner, but shall be in the Contractor's hands before any excavating is commenced.
- B. The boring method shall consist of pushing the pipe into the earth with a boring auger rotating within the pipe to remove the spoil.
  - 1. The front of the pipe shall be provided with mechanical arrangements or devices that will positively prevent the auger from leading the pipe so that there will be no unsupported excavation ahead of the pipe.
  - 2. The auger and cutting head arrangement shall be removable from within the pipe in the event an obstruction is encountered. If the obstruction cannot be removed without excavation in advance of the pipe, the pipe shall be abandoned in place and immediately filled with grout.
  - 3. The over-cut by the cutting head shall not exceed the outside diameter of the pipe by more than 2 inch. If voids should develop or if the bored hole diameter is greater than the outside diameter of the pipe by more than approximately 1 inch, grouting or other approved methods must be used to fill such voids.
  - 4. The face of the cutting head shall be arranged to provide a reasonable obstruction to the free flow of soft or poor material.
  - 5. Any method which does not have this boring arrangement will not be permitted. Contractor's boring arrangement plans and methods must be submitted to, and approved by, the Engineer.
- C. In the event an obstruction is encountered in boring which cannot be removed and it becomes necessary to withdraw the casing and commence elsewhere, the hole from which the casing is withdrawn shall be completely backfilled with coarse sand rammed in.
- D. Insurance to be furnished by the Contractor to cover this type of work shall be adequate to meet the requirements of the Railroad and/or State or County Highway Departments. Insurance shall consist of comprehensive general liability and automobile liability insurance.
- E. Before award of the contract, the Contractor shall furnish a statement of his experience of such work, or if inexperienced, shall advise the Owner as to whom he will sublet the work and give a statement of the experience of the subcontractor, which shall be satisfactory to the Owner.

### 3.4 CONTRACTOR'S RESPONSIBILITIES

- A. Obtain a copy of the Highway Encroachment and/or Railroad Permit before beginning construction.
- B. Attend a preconstruction meeting at the construction site with the Resident Project Representative, Railroad Inspector, Highway Inspector, Engineer, and Contractor being present.
- C. Contractor shall be responsible for protecting, temporarily supporting, bracing or if required relocating any existing utility that would be affected by the location of the bore pit.

END OF SECTION 330523

## SECTION 333113 - GRAVITY SEWER PIPING

### PART 1 - GENERAL

#### 1.1 SCOPE OF WORK

- A. Provide all labor, materials, equipment and services required for furnishing and installing all piping and appurtenances as shown on the Drawings and specified herein.
- B. Contractor shall note that the construction of the new sewer will be performed in close proximity to other active utilities, both above and below grade. The Contractor shall include in his pay item any associated cost for working around other utilities. This shall include any cost for loss in production, temporary supports, temporary bracing and/or the use of trench boxes. The Contractor shall coordinate this work with the other utility as required.

#### 1.2 RELATED WORK SPECIFIED ELSEWHERE

- A. Earthwork: Section 312000
- B. Boring and Jacking: Section 330523
- C. Sanitary Sewer Manholes, Frames and Covers: Section 333913
- D. Excavation Support and Protection: Section 315000

#### 1.3 SUBMITTALS

- A. Submit manufacturer's data as specified herein. Comply with all requirements of Section 013323.

#### 1.4 INTERNAL PIPE DIAMETER

- A. All sewer pipe provided shall have a minimum actual internal diameter which is equal to or greater than the diameter indicated on the Contract Drawings.

#### 1.5 UTILITY LINE ACTIVITIES COVERED UNDER NATIONWIDE PERMIT # 12

- A. All activities involving utility line construction covered under the US Army Corps of Engineers NATIONWIDE PERMIT # 12 shall meet the following conditions:
  - 1. Utility Line Activities. Activities required for the construction, maintenance, repair, and removal of utility lines and associated facilities in waters of the United States, provided the activity does not result in the loss of greater than 1/2-acre of waters of the United States for each single and complete project. Utility lines: This NWP authorizes the construction, maintenance, or repair of utility lines, including outfall and intake

structures, and the associated excavation, backfill, or bedding for the utility lines, in all waters of the United States, provided there is no change in pre-construction contours. This NWP also authorizes temporary structures, fills, and work necessary to conduct the utility line activity.

2. Appropriate measures must be taken to maintain normal downstream flows and minimize flooding to the maximum extent practicable, when temporary structures, work, and discharges, including cofferdams, are necessary for construction activities, access fills, or dewatering of construction sites. Temporary fills must consist of materials, and be placed in a manner, that will not be eroded by expected high flows. Temporary fills must be removed in their entirety and the affected areas returned to pre-construction elevations. The areas affected by temporary fills must be revegetated, as appropriate.
  3. Notification: The permittee must submit a pre-construction notification to the US Army Corps district engineer prior to commencing the activity if any of the following criteria are met: (1) The activity involves mechanized land clearing in a forested wetland for the utility line right-of-way; (2) a section 10 permit is required; (3) the utility line in waters of the United States, excluding overhead lines, exceeds 500 feet; (4) the utility line is placed within a jurisdictional area (i.e., water of the United States), and it runs parallel to or along a stream bed that is within that jurisdictional area; (5) discharges that result in the loss of greater than 1/10-acre of waters of the United States; (6) permanent access roads are constructed above grade in waters of the United States for a distance of more than 500 feet; or (7) permanent access roads are constructed in waters of the United States with impervious materials.
- B. All activities involving utility line construction covered under KENTUCKY GENERAL CERTIFICATION of Nationwide Permit # 12 shall meet the following conditions:

The general Water Quality Certification applies to surface waters of the Commonwealth as defined in 401KAR10:001 Chapter 10, Section 1(80): Surface waters means those waters having well-defined banks and beds, either constantly or intermittently flowing, lakes and impounded waters; marshes and wetlands; and any subterranean waters flowing in well-defined channels and having a demonstrable hydrologic connection with the surface.

1. The activity will not occur within surface waters of the Commonwealth identified by the Kentucky Division of Water as Outstanding State or National Resource Water, Cold Water Aquatic Habitat, or Exceptional Waters.
2. The activity will not occur within surface waters of the Commonwealth identified as perpetually-protected (e.g. deed restriction, conservation easement) mitigation sites.
3. This general water quality certification does not authorize the installation of utility lines in a linear manner within the stream channel or below the top of the stream bank.
4. For a single crossing, impacts from the construction and maintenance corridor in surface waters shall not exceed 50 feet of bank disturbance.
5. This general certification shall not apply to nationwide permits issued for individual crossings which are part of a larger utility line project where the total cumulative impacts from a single and complete linear project exceed ½ acre of wetlands or 300 linear feet of surface waters. Cumulative impacts include utility line crossings, permanent or temporary

access roads, headwalls, associated bank stabilization areas, substations, pole or tower foundations, maintenance corridor, and staging areas.

6. Stream impacts under Conditions 4 and 5 of this certification are defined as the length of bank disturbed. For the utility line crossing and roads, only one bank length is used in calculation of the totals.
7. Stream impacts covered under this General Water Quality Certification and undertaken by those persons defined as an agricultural operation under the Agricultural Water Quality Act must be completed in compliance with the Kentucky Agricultural Water Quality Plan (KWQP).
8. The Kentucky Division of Water may require submission of a formal application for an individual certification for any project if the project has been determined to likely have a significant adverse effect upon water quality or degrade the waters of the Commonwealth so that existing uses of the water body or downstream waters are precluded.
9. Activities that do not meet the conditions of this General Water Quality Certification require an Individual Section 401 Water Quality Certification.
10. Blasting of stream channels, even under dry conditions, is not allowed under this general water quality certification.
11. Utility lines placed parallel to the stream shall be located at least 50 feet from an intermittent or perennial stream, measured from the top of the stream bank. The cabinet may allow construction within the 50 foot buffer if avoidance and minimization efforts are shown and adequate methods are utilized to prevent soil from entering the stream.
12. Utility line stream crossings shall be constructed by methods that maintain flow and allow for a dry excavation. Water pumped from the excavation shall be contained and allowed to settle prior to re-entering the stream. Excavation equipment and vehicles shall operate outside of the flowing portion of the stream. Spoil material from the excavation shall not be allowed to enter the flowing portion of the stream.
13. The activities shall not result in any permanent changes in pre-construction elevation contours in surface waters or wetlands or stream dimension, pattern or profile.
14. Utility line activities which impact wetlands shall not result in conversion of the area to non-wetland status. Mechanized land clearing of forested wetlands for the installation or maintenance of utility lines is not authorized under this certification.
15. Activities qualifying for coverage under this General Water Quality Certification are subject to the following conditions:
  - a. Erosion and sedimentation pollution control plans and Best Management Practices must be designed, installed, and maintained in effective operating condition at all times during construction activities so that violations of state water quality standards do not occur.
  - b. Sediment and erosion control measures, such as check-dams constructed of any material, silt fencing, hay bales, etc., shall not be placed within surface waters of the Commonwealth, either temporarily or permanently, without prior approval by the Kentucky Division of Water's Water Quality Certification Section. If placement of



sediment and erosion control measures in surface waters is unavoidable, design and placement of temporary erosion control measures shall not be conducted in such a manner that may result in instability of streams that are adjacent to, upstream, or downstream of the structures. All sediment and erosion control devices shall be removed and the natural grade restored within the completion timeline of the activities.

- c. Measures shall be taken to prevent or control spills of fuels, lubricants, or other toxic materials used in construction from entering the watercourse.
  - d. Removal of riparian vegetation shall be limited to that necessary for equipment access.
  - e. To the maximum extent practicable, all in-stream work under this certification shall be performed under low-flow conditions.
  - f. Heavy equipment, e.g. bulldozers, backhoes, draglines, etc., if required for this project, should not be used or operated within the stream channel. In those instances in which such in-stream work is unavoidable, then it shall be performed in such a manner and duration as to minimize turbidity and disturbance to substrates and bank or riparian vegetation.
  - g. Any fill shall be of such composition that it will not adversely affect the biological, chemical, or physical properties of the receiving waters and/or cause violations of water quality standards. If rip-rap is utilized, it should be of such weight and size that bank stress or slump conditions will not be created because of its placement.
  - h. If there are water supply intakes located downstream that may be affected by increased turbidity and suspended solids, the permittee shall notify the operator when such work will be done.
  - i. Should evidence of stream pollution or jurisdictional wetland impairment and/or violations of water quality standards occur as a result of this activity (either from a spill or other forms of water pollution), the Kentucky Division of Water shall be notified immediately by calling (800) 928-2380.
16. Non-compliance with the conditions of this general certification or violation of Kentucky state water quality standards may result in civil penalties.

#### 1.6 CONSTRUCTION IN A FLOODPLAIN

- A. No material shall be placed in the stream or in the flood plain to form construction pads, coffer dams, access roads, etc. unless prior approval has been obtained from the Environmental and Public Protection Cabinet.
- B. The trench shall be backfilled as closely as possible to the original contour. All excess material from construction of the trench shall be disposed of outside the flood plain unless the applicant has received prior approval from the Cabinet to fill within the flood plain.

### PART 2 - PRODUCTS

#### 2.1 GRAVITY SEWER PIPE

- A. Ductile Iron Pipe



1. Ductile Iron Pipe shall be installed where indicated on the Contract Drawings.
2. Ductile iron pipe shall conform to the current requirements of AWWA C151, Pressure Class 200, with push-on joints unless otherwise noted on drawings.
3. The interior of the pipe shall be cement-mortar lined with bituminous seal coat in accordance with the current requirements of AWWA C104. Thickness of the lining shall be set forth in Section 4.10.1 of the aforementioned specification unless otherwise directed by the Engineer. The exterior of all pipe, unless otherwise specified, shall receive either coal tar or asphalt base coating a minimum of 1 mil thick.
4. Each piece of pipe shall bear the manufacturer's name or trademark, the year in which it was produced and the letters "DI" or the word "DUCTILE". Pipe manufacturer shall furnish notarized certificate of compliance to the above AWWA or ANSI specifications.
5. The cleaning and assembly of pipe and fitting joints shall be in accordance with the manufacturer's recommendations.

B. Polyvinyl Chloride (PVC) Pipe and Fittings

1. PVC Pipe shall be installed where indicated on the Contract Drawings. PVC pipe shall not be used in locations where the depth of cut is greater than 16 feet.
2. Pipe must be delivered to job site by means which will adequately support it, and not subject it to undue stresses. In particular, the load shall be so supported that the bottom rows of pipe are not damaged by crushing. Pipe shall be unloaded carefully and strung or stored as close to the final point of placement as is practical. Pipe shall not be stored outside where subject to sunlight.
3. Jointing of PVC pipe shall be by a natural rubber ring inserted into the belled end of the pipe or double hub joints. Solvent weld joints are not acceptable.
4. The PVC pipe manufacturer shall provide special fittings, acceptable to the Engineer to make watertight connections to manholes.
5. Pipe manufacturer shall furnish notarized certificate of compliance with applicable specifications.

a. Gravity Sewer Application (15" and Smaller):

- 1) PVC pipe used for gravity sewer applications shall meet all requirements of ASTM Specification D-3034, latest revision. Pipe and fittings shall meet the extra strength minimum of SDR-35 of that Specification.
- 2) All pipe and fittings shall be inspected at the factory and on the job site. Testing of PVC pipe and fittings shall be accomplished in conformance with the latest revision of ASTM D3034, ASTM D2444, ASTM D2412, and ASTM D2152. The manufacturer shall submit five (5) copies of certification of test for each lot of material represented by shipment to the job site.
- 3) The pipe shall be homogeneous throughout and free from cracks, holes, foreign inclusions or other defects. The pipe shall be as uniform in color as commercially practical. PVC pipe shall have a ring painted around spigot ends in such a manner as to allow field checking of setting depth of pipe in the socket.

b. Large Diameter Gravity Sewer Application (Greater than 15"):

- 1) Large diameter PVC pipe used for gravity sewer applications shall meet or exceed all performance requirements of Paragraph 2.01.B. of this section,

except ASTM F679 shall be referenced instead of ASTM D3034.

6. The cleaning and assembly of pipe and fittings shall be in accordance with the manufacturer's recommendation.
7. PVC Gravity Lateral Service Connection Piping (6").
  - a. PVC gravity lateral service connection pipe (6") shall be ASTM-3034, SDR 35 solid wall PVC pipe.
  - b. For deep sewer house connection laterals (deeper than 10 feet) and for near vertical (within 30 degrees of vertical) lateral risers, install a vertical riser adapter with flange (Plastic Treads Model No. G-986 or equal) between the bottom fitting and the vertical riser section to prevent settlement of the lateral riser and to prevent possible damage to the bottom fitting joint. See detail on Drawing SD-2 for deep sewer house connection laterals.

## 2.2 PIPE EMBEDMENT & BACKFILL MATERIALS (Per ASTM D2321)

- A. Classes of Embedment and Backfill Materials are defined in ASTM D2321. Embedment Materials are those used for bedding, haunching and initial backfill.
- B. Class 1A and Class 2 materials are acceptable for Pipe Embedment. Included in this category are #9 and #57 crushed stone.
- C. Class 1, 2, 3 and 4A materials are acceptable for Final Backfill, compacted 85% Standard Proctor Density except that Class 4A material must be compacted to 95% Standard Proctor Density and Class 4A material is not allowed for backfill under pavement or traffic areas or in trenches where water content may cause instability of uncontrolled water content.
  1. No rocks larger than 3" shall be incorporated into the Final Backfill materials.
- D. Class 1A Manufactured Aggregates: Open graded clean, angular, crushed stone or rock. These materials compact with little or no mechanical effort.
- E. Class 1B Manufactured, Processed Aggregate: Dense graded clean, angular crushed stone. Compact to 85% Standard Proctor Density with hand tampers or vibratory compaction.
- F. Class 2: Clean, coarse-grained materials, such as gravel, coarse sands, and gravel/sand mixtures (1" maximum size). The materials are classified by the Unified Soil Classification System as GW, GP, SW, SP, and GW-GC or SP-SM. Hand tamping or mechanical vibration is required to provide the necessary 85% Standard Proctor Density.
- G. Class 3: Coarse-grained materials with fines including silty or clayey gravels or sands. Gravel or sand must comprise more than 50% of Class 3 materials (1" maximum size). Soils classified as GM, GC, SM or SC meets these requirements. Hand tamping or mechanical vibration is required to provide the necessary 90% Standard Proctor Density.
- H. Class 4: Fine-grained materials, such as fine sands and soils, containing 50% or more clay or silt. Soils classified as Class 4A (ML or CL) have medium to low plasticity. Soils classified as Class 4B (MH or CH) have high plasticity and are NOT allowed as embedment or backfill

materials.

### 2.3 COMPRESSION COUPLINGS

- A. When joining different types of pipe together or new pipe to existing pipe, the Contractor shall use Fernco Compression Couplings, or equal, that are resistant to corrosion by soil and sewage and that will provide a permanent watertight joint.
- B. The compression coupling shall meet the physical test and joint-leak requirements specified in ASTM C-1173. The bands for attaching pipes shall be stainless steel conforming to ASTM C-1173. Each coupling shall bear the manufacturer's name and an indication of its size.

### 2.4 CONCRETE PIPE ANCHORS

- A. Where indicated on the Drawings, required by the specifications or as directed by the Engineer, concrete pipe anchors shall be installed. Concrete shall be 2000 psi, and reinforcing bars shall be as indicated on the anchor detail.

### 2.5 PRE-FABRICATED TRENCH BAFFLES

- A. Where indicated on the Drawings, required by the specifications, or as directed by the Engineer, Contractor shall install pre-fabricated trench baffles in the pipeline trench. The Baffle shall be self-supporting, made of ABS (Acrylonitrile Butadiene Styrene) or comparable material, and shall provide a watertight seal around the pipe by use of an elastomeric PVC flexible coupling. The purpose of the baffle is to stop the flow of groundwater along the trench, and around the pipe. The trench baffle shall be "Ripley's Dam" as manufactured by EJP, or equal.

### 2.6 POLYETHYLENE ENCASUREMENT FOR DUCTILE IRON PIPE, FITTINGS & VALVES

- A. Polyethylene encasement for use with ductile iron pipe shall meet all the requirements for ANSI/AWWA C105/A21.5, Polyethylene Encasement for Ductile Iron Pipe Systems.
- B. In addition, polyethylene encasement for use with ductile iron pipe systems shall consist of three layers of co-extruded linear low density polyethylene (LLDPE), fused into a single thickness of not less than 8 mils.
- C. The inside surface of the polyethylene wrap to be in contact with the pipe exterior shall be infused with a blend of anti-microbial biocide to mitigate microbiologically influenced corrosion and a volatile corrosion inhibitor to control galvanic corrosion.
- D. Ductile iron pipe and the polyethylene encasement used to protect it shall be installed in accordance with AWWA C600 and ANSI/AWWA C105/A21.5 and also in accordance with all recommendations and practices of the AWWA M41, *Manual of Water Supply Practices – Ductile Iron Pipe and Fittings*. Specifically, the wrap shall be overlapped one foot in each direction at joints and secured in place around the pipe and any wrap at tap locations shall be taped tightly prior to tapping and inspected or any needed repairs following the tap.
- E. All installations shall be carried out by personnel trained and equipped to meet these

various requirements.

- F. The installing contractor shall submit an affidavit stating compliance with the requirements and practices of ANSI/AWWA C150/A21.50, ANSI/AWWA C151/A21.51, ANSI/AWWA C105/A21.5, AWWA C600, and M 41.

### PART 3 - EXECUTION

#### 3.1 EXCAVATION FOR PIPELINE TRENCHES

- A. Unless otherwise directed by the Engineer, trenches in which pipes are to be laid shall be excavated in open cut to the depths required by field conditions or as specified by the Engineer. In general this shall be interpreted to mean that machine excavation in earth shall not extend below an elevation permitting the pipe to be properly bedded. Installation shall be in accordance with ASTM-D-2321 except as modified herein.
- B. Excavation may be undercut to a depth below the required invert elevation that will permit laying the pipe in a bed of granular material to provide continuous support for the bottom quadrant of the pipe. When this method is used, the bedding shall be as set out in Paragraph 3.02 hereinafter.
- C. Trenches shall be of sufficient width to provide free working space on each side of the pipe and to permit proper backfilling around the pipe, but unless specifically authorized by the Engineer, trenches shall in no case be excavated or permitted to become wider than 2'-0" plus the nominal diameter of the pipe at the level of or below the top of the pipe. If the trench does become wider than 2'-0" at the level of or below the top of the pipe, special precaution may be necessary, such as providing compacted, granular fill up to top of the pipe or providing pipe with additional crushing strength as determined by the Engineer after taking into account the actual trench loads that may result and the strength of the pipe being used. The Contractor shall bear the cost of such special precautions as are necessary.
- D. All excavated materials shall be placed a minimum of two feet (2') back from the edge of the trench.
- E. Before laying the pipe, the trench shall be opened far enough ahead to reveal obstructions that may necessitate changing the line or grade of the pipeline.
- F. The trench shall be straight and uniform so as to permit laying pipe to lines and grades given by the Engineer. It shall be kept free of water during the laying of the pipe and until the pipeline has been backfilled. Removal of trench water shall be at the Contractor's expense. Dry conditions shall be maintained in the excavations until the backfill has been placed. During the excavation, the grade shall be maintained so that it will freely drain and prevent surface water from entering the excavation at all times. When directed by Engineer, temporary drainage ditches shall be installed to intercept or direct surface water which may affect work. All water shall be pumped or drained from the excavation and disposed of in a suitable manner without damage to adjacent property or to other work.
- G. Minimum cover of 42" shall be provided for all pipelines.

### 3.2 PIPE BEDDING

- A. All sewer pipe shall be supported on a bed of granular material. In no case shall pipe be supported directly on rock. Bedding shall not be a separate pay item unless otherwise set out in the Detailed Specifications. Bedding shall be provided in earth bottom trenches, as well as rock bottom trenches. Bedding material shall be free from rock, foreign material, frozen earth, and be acceptable to the Engineer. Bedding shall be a minimum of 6" below pipe barrel.
- B. In all cases the foundation for pipes shall be prepared so that the entire load of the backfill on top of the pipe will be carried on the barrel of the pipe and insofar as possible where bell and spigot pipe is involved so that none of the load will be carried on the bells.
- C. Where flexible pipe is used, the granular bedding shall be placed up to at least the spring line (horizontal center line) of the pipe. The bedding material and procedures shall conform to ASTM D 2321 and any Technical Specifications set out hereinafter. If conditions warrant, the Engineer may require the bedding to be placed above the springline of the pipe. Granular bedding shall be Size #9 or #57 crushed stone, fine gravel, or sand, and is not a separate pay item. Refer to Paragraph 2.2 for specifications for pipe embedment materials.
- D. Where undercutting and granular bedding are involved the undercutting shall be of such depth that the bottom of the bells of the pipe will be at least three inches above the bottom of the trench as excavated. Undercutting is not a separate pay item.
- E. In wet, yielding mucky locations where pipe is in danger of sinking below grade or floating out of line or grade, or where backfill materials are of such a fluid nature that such movements of the pipe might take place during the placing of the backfill, the pipe must be weighted or secured permanently in place by such means as will prove effective. When ordered by the Engineer, yielding and mucky materials in subgrades shall be removed below ordinary trench depth in order to prepare a proper bed for the pipe. Crushed stone or other such granular material, if necessary, as determined by the Engineer to replace poor subgrade material, shall be a separate pay item and classified as "Special Granular Fill". Removal of poor material is not a separate pay item.
- F. Installation shall be in accordance with ASTM D 2321 except as modified hereinafter.

### 3.3 SPECIAL GRANULAR FILL

- A. As noted in Paragraph 3.02E, granular material for "Special Granular Fill" when directed by the Engineer shall be Department of Transportation crushed limestone, Size #57. Payment for "Special Granular Fill" must have approval from the Engineer prior to installation.

### 3.4 LAYING PIPE

- A. The laying of pipe in finished trenches shall be commenced at the lowest point so the spigot ends point in the direction of flow.
- B. All pipes shall be laid with ends abutting and true to line and grade as given by the Engineer. Supporting of pipes shall be as set out hereinbefore under "Pipe Bedding" and in no case shall the supporting of pipes on blocks be permitted.

- C. Before each piece of pipe is lowered into the trench, it shall be thoroughly inspected to insure its being clean. Each piece of pipe shall be lowered separately unless special permission is given otherwise by the Engineer. No piece of pipe or fitting which is known to be defective shall be laid or placed in the lines. If any defective pipe or fitting shall be discovered after the pipe is laid, they shall be removed and replaced with a satisfactory pipe or fitting without additional charge. In case a length of pipe is cut to fit in a line it shall be so cut as to leave a smooth end at right angles to the longitudinal axis of the pipe.
- D. Pipe shall not be laid on solid rock. A pad of granular material as specified in Paragraph 3.02 "Pipe Bedding", shall be used as a pipe bedding. Pipe bedding is not a separate pay item. Irregularities in subgrade in an earth trench shall be corrected by use of granular material.
- E. When ordered by the Engineer, unsuitable materials in subgrades shall be removed below ordinary trench depth in order to prepare a proper bed for the pipe.
- F. When laying of pipe is stopped for any reason, the exposed end of such pipe shall be closed with a plywood or fabricated plug fitted into the pipe bell, so as to exclude earth or other material, and precautions taken to prevent flotation of pipe by runoff into trench.
- G. No backfilling (except for securing pipe in place) over pipe will be allowed until the Engineer has had an opportunity to make an inspection of the joints, alignment and grade, in the section laid.

### 3.5 BACKFILLING PIPELINE TRENCHES

- A. Backfilling of pipeline trenches shall be accomplished as shown on the Drawings and with the requirements set forth in Section 02300 "Earthwork". Before final acceptance, the Contractor will be required to level off all trenches or to bring the trench up to grade. The Contractor shall also remove from roadways, rights-of-way and/or private property all excess earth or other materials resulting from construction. In the event that pavement is not placed immediately following trench backfilling in paved areas, the Contractor shall be responsible for maintaining the trench surface in a level condition at proper pavement grade at all times.
- B. Method "1" - Backfilling in Open Terrain (outside State's R.O.W.).

Backfilling of pipeline trenches in open terrain, outside the State's R.O.W. shall be accomplished in the following manner:

1. The lower portion of the trench, from the pipe bedding to a point 12" above the top of the pipe, shall be backfilled with No. 9 crushed stone. This material shall be placed in a manner approved by the Engineer, and shall be carefully compacted to avoid displacement of the pipe.
2. The upper portion of the trench above the compacted portion shall be backfilled with material which is free from large rock. Incorporation of rock having a volume exceeding one-half cubic foot is prohibited. Backfilling this portion of the trench may be accomplished by any means approved by the Engineer. The trench backfill shall be heaped over or leveled as directed by the Engineer.

C. Method "2" - Backfilling in open areas (inside State's R.O.W.).

Backfilling of pipeline trenches in open areas inside State's R.O.W. shall be accomplished in the following manner.

1. The lower portion of the trench, from the pipe springline (horizontal center) to a point 6" below the grade line, shall be backfilled with No. 9 crushed stone. This portion of the trench shall be wrapped with geotextile fabric per Section 02300 and the Standard Detail Drawings.
2. The top 6" of trench shall be backfilled with heaped backfill, free of rock, with mechanical tamping. However, should this occur at an existing sidewalk or driveways the upper portion of the trench shall be temporarily backfilled and maintained with crushed stone or gravel until such time as the sidewalk is constructed or the driveway surface is restored.

D. Method "3" – Backfilling Under Streets, Roads, and Paved Driveways (inside State R.O.W.).

Backfilling of pipeline trenches under streets, roads and paved driveways (inside State R.O.W.) shall be accomplished in the following manner:

1. The lower portion of the trench, from the pipe bedding to a point 12 inches above the top of the pipe, shall be backfilled with No. 9 crushed stone. This material shall be placed in a manner to avoid displacement of the pipe.
2. The middle portion of the trench, from a point 12" above the top of the pipe to a point even with the bottom of the existing pavement shall be backfilled with flowable fill per Section 02300 and the Standard Detail Drawings.

E. Method "4" - Backfilling Under Streets, Roads, and Paved Driveways (outside the State's R.O.W.):

Backfilling of pipeline trenches under streets, roads and paved driveways (outside State's R.O.W.) shall be accomplished in the following manner:

1. The lower portion of the trench from the pipe bedding to a point 6" below the bottom of the pavement or concrete sub-slab, shall be backfilled with No. 9 crushed stone.
2. The upper portion of the trench, from a point 6" below the bottom of the pavement or concrete sub-slab to grade, shall be backfilled with a base course of dense graded aggregate. At such time that pavement replacement is accomplished, the excess base course shall be removed as required.

F. All backfilling methods are shown on the Detail Drawings. When directed by the Engineer, the Contractor shall wet backfill material to assure maximum compaction.

Before final acceptance, the Contractor will be required to level off all trenches or to bring the trench up to grade. The Contractor shall also remove from roadways, rights-of-ways and/or private property all excess earth or other materials resulting from construction.



In the event that pavement is not placed immediately following trench backfilling in streets and highways, the Contractor shall be responsible for maintaining the trench surface in a level condition at proper pavement grade at all times.

### 3.6 SETTLEMENT OF TRENCHES

- A. Whenever lines are in, or cross, driveways and streets, the Contractor shall be responsible for any trench settlement that occurs within these rights-of-way within one year from the time of final acceptance of the work. If paving shall require replacement because of trench settlement within this time, it shall be replaced by the Contractor at no extra cost to the Owner. Repair of settlement damage shall meet the approval of the Owner and/or the State Department of Transportation.

### 3.7 CONCRETE CRADLE, ANCHORS OR ENCASEMENT

- A. Concrete cradle, anchors or encasement shall be placed where shown on the Drawings, required by the specifications, or as directed by the Engineer.
- B. Concrete shall be 2000 psi and shall be mixed sufficiently wet to permit it to flow under the pipe to form a continuous bed. In tamping concrete, care shall be taken not to disturb the grade or line of the pipe or injure the joints. Concrete placed outside the specified limits or without authorization from the Engineer will not be subject to payment.

### 3.8 PRE-FABRICATED TRENCH BAFFLES

- A. Pre-fabricated trench baffles shall be installed where shown on the Drawings, required by the specifications or as directed by the Engineer. The product shall be installed according to the manufacturer's recommendations, and shall provide a watertight seal around the pipe. Contractor shall insure that the correct line and grade of the pipe is maintained before backfilling around the trench baffle.

### 3.9 BITUMINOUS CONCRETE HIGHWAY, STREET AND DRIVEWAY REPLACEMENT

- A. The Contractor shall replace those sections of existing roads, streets and driveways required to be removed to install the pipe lines under this contract. He shall construct same to the original lines and grades and in such manner as to leave all such surfaces in fully as good or better condition than that which existed prior to the operations.
- B. Prior to trenching, the pavement shall be scored or cut to straight edges at least twelve (12) inches outside each edge of the proposed trench to avoid unnecessary damage to the remainder of the paving. Edges of the existing pavement shall be re-cut and trimmed to square, straight edges after the pipeline has been installed and prior to placing the new base and pavement.
- C. Backfilling of the trench shall be in accordance with Method "C" as described hereinbefore. Base course for the paving shall be dense graded crushed limestone furnished and placed in accordance with the current requirements of Section 303 of the Standard Specifications for Road and Bridge Construction of the Kentucky Department of Transportation, to a depth of six



(6) inches in roads and streets and four (4) inches in driveways.

- D. A subslab of reinforced concrete shall be placed for state maintained highways as indicated on the Drawings. The subslab shall have a minimum thickness of 6 inches. Concrete for the subslab shall be 3000 psi, in accordance with the Details shown on the Drawings.
- E. The Contractor installing the utilities shall be responsible for installing 2" of asphalt base course flush with the existing grade. The General Road Contractor shall overlay this area with surface per their road paving specifications
- F. Prior to placing the bituminous binder course, the granular base course shall be thoroughly cleaned and broomed and a prime coat of Refined Tar RT-2 shall be uniformly applied at the rate of 0.35 gallons per square yard.
- G. The bituminous base course shall be hot mixed, hot laid, bituminous concrete base, furnished and placed in accordance with Section 402 of the Standard Specifications, and to match the existing depth or to a minimum compacted thickness of 3 inches.
- H. The surface course shall be hot mixed, hot laid, bituminous concrete, furnished and placed in accordance with Section 402 of the Standard Specifications, and to match the existing depth or to a minimum compacted thickness of 1-1/2 inches.

3.10 GRAVITY SEWER CONNECTION OF NEW SANITARY SEWER TO EXISTING MANHOLES

- A. New sanitary sewer shall be extended through the wall of the existing manhole, connector seal installed, sealed and patched with an expansive cement mortar and pipe sealed with a test plug. Test plug shall be a wing nut style as manufactured by Richmond Foundry, Richmond, Virginia, or equal. Apron and invert shall be removed in its entirety where required to allow placement of the new sewer at the specified invert elevation.
- B. Wherever plastic sewer pipe is to be field grouted into manhole openings, pipe-to-manhole connector seal shall be Fernco Concrete Manhole Adapters manufactured by Fernco, Inc., Division, Michigan, or equal. Adapter shall be mounted on pipe and shall be positioned about the center of the manhole wall.
- C. At the time the new sewer is placed into permanent service, as designated by the Owner, the Contractor shall remove the old sewer pipe from the manhole, patch and seal the wall with an expansive cement mortar, construct new apron and invert in accordance with the standard details, and remove plug from the new sewer. All temporary pumping, piping, excavation, etc. as required to maintain or divert the sewage flow shall be included by the Contractor.

3.11 CONCRETE CURB AND GUTTER REPLACEMENT

- A. The Contractor shall remove the curb and gutter when encountered when required for laying the sewer. Only that portion of the curb and gutter needed to lay the sewer line shall be removed.
- B. Where concrete curb and gutter removed or disturbed during the construction work, it shall be replaced, using 3000 psi concrete, in fully as good or better condition than which existed prior

to the Contractor's operation.

3.12 REPLACEMENT OF EXISTING MAIL BOXES, CULVERTS, CLOTHES LINE POSTS, FENCES AND OTHER SUCH FACILITIES

- A. Existing mail boxes, drainage culverts, clothes line posts, fences and the like shall not be damaged or disturbed unless necessary, in which case, they shall be replaced in as good condition as found as quickly as possible. Existing materials shall be reused in replacing such facilities when materials have not been damaged by the Contractor's operations. Existing facilities damaged by Contractor's operation shall be replaced with new materials of the same type at the Contractor's expense. Work in this category is not a pay item.
- B. Replacement of paved drainage ditches within highway right-of-way shall be accomplished in accordance with Department of Transportation specifications.

3.13 PORTLAND CEMENT CONCRETE DRIVEWAY REPLACEMENT

- A. Wherever Portland cement concrete driveways are removed, they shall be reconstructed to the original lines and grades and in such manner as to leave all such surfaces in fully as good or better condition than existed prior to the operation.
- B. The existing concrete paving shall be sawed or cut to straight edges 12-inches outside the edges of the trench or broken out to an existing joint, as directed by the Engineer. The concrete pavement shall be equal to the existing pavement thickness but not less than 6-inches in thickness for driveways.
- C. Pavement shall be reinforced with 6 x 6 #10-10 wire mesh and shall be constructed with 3000 psi concrete.

3.14 RIP-RAP STREAM BANK SLOPE PROTECTION

- A. The Contractor shall install rip-rap stream bank slope protection at locations directed by the Engineer. Rip-rap slope protection shall be 12-inches thick and shall meet State D.O.T. Standard Specifications.

3.15 TESTING

On all projects involving installation of sanitary sewer lines, the finished work shall comply with the provisions listed below or similar requirements which will insure equal or better results:

- A. Rod Out: After the collecting and/or outfall lines or system have been brought to completion, and prior to final inspection, the Contractor shall rod out the entire system by pushing through each individual line in the system, from manhole to manhole, appropriate tools for the removal from the lines of any and all dirt, debris and trash.
- B. Inspect Lines: During the final inspection, the Engineer will inspect each individual line, from manhole to manhole, either by use of lights or other means at his disposal to determine whether

the completed lines are true to line and grade as laid out or as shown on the plans.

- C. Deflection tests shall be performed on a flexible pipe. The test shall be conducted after the final backfill has been in place at least 30 days to permit stabilization of the soil-pipe system. No pipe shall exceed a deflection of 5 percent. If deflection exceeds 5 percent, pipe shall be replaced or corrected. The rigid ball cylinder or mandrel used for the deflection test shall have a diameter not less than 95 percent of the base inside diameter or average inside diameter of the pipe depending on which is specified in the ASTM Specification, including the appendix, to which the pipe is manufactured. The pipe shall be measured in compliance with ASTM D2122 Standard Test Method of Determining Dimensions of Thermoplastic Pipe and Fittings. The test shall be performed without mechanical pull devices.
- D. Replace Defective Lines: All lines or sections of lines that are found to be laid improperly with respect to line or grade, that are found to contain broken or leaking sections of pipe, or are obstructed in such a manner that they cannot be satisfactorily corrected otherwise, shall be removed and replaced at the Contractor's expense.
- E. I & I Limits: The Contractor shall lay sewer lines, including house connections so that the access of ground water or loss of water from the sewer system or other gravity flow piping which does not normally flow full will be limited to 10 gallons per inch diameter per mile per day. This limitation is inclusive of manholes, sewers, house connections, and appurtenances. This requirement may be applied to a portion of the contract work, such as the sewers in a separate drainage area or to a single section of the line between two manholes.
- F. Low Pressure Air Test: To test for leaks, the Engineer will require that all completed piping as specified herein after back filling be tested by low-pressure air test, exfiltration, or infiltration test. Should the low pressure air test results be inconclusive, or at the request of the Engineer, an exfiltration or infiltration test will be required on the low pressure air tested segments. Labor, equipment and supplies required for all tests shall be furnished by the Contractor.
  - 1. The low pressure air test shall consist of meeting a required holding time during a measured pressure drop. The initial test pressure shall be 4.0 psi, with the allowable pressure loss being 1.0 psi during the calculated holding time. Holding time shall be as indicated in the following table:

SPECIFICATION TIME REQUIRED FOR A 1.0 PSIG PRESSURE DROP FOR SIZE AND LENGTH OF PIPE INDICATED FOR Q = 0.0015*											
1 Pipe Dia. (in)	2 Minimum Time (min:sec)	3 Length for Minimum Time (ft)	4 Time for Longer Length (sec)	Specified Minimum for Length (L) Shown (min:sec)							
				100 ft	150 ft	200 ft	250 ft	300 ft	350 ft	400 ft	450 ft
4	3:46	597	.380 L	3:46	3:46	3:46	3:46	3:46	3:46	3:46	3:46
6	5:40	398	.854 L	5:40	5:40	5:40	5:40	5:40	5:40	5:42	6:24
8	7:34	298	1.520 L	7:34	7:34	7:34	7:34	7:36	8:52	10:08	11:24
10	9:26	239	2.374 L	9:26	9:26	9:26	9:53	11:52	13:51	15:49	17:48
12	11:20	199	3.418 L	11:20	11:20	11:24	14:15	17:05	19:56	22:47	25:38
15	14:10	159	5.342 L	14:10	14:10	17:48	22:15	26:42	31:09	35:36	40:04
18	17:00	133	7.692 L	17:00	19:13	25:38	32:03	38:27	44:52	51:16	57:41
21	19:50	114	10.470 L	19:50	26:10	34:54	43:37	52:21	61:00	69:48	78:31
24	22:40	99	13.674 L	22:47	34:11	45:34	56:58	68:22	79:46	91:10	102:33
27	25:30	88	17.306 L	28:51	43:16	57:41	72:07	86:32	100:57	115:22	129:48
30	28:20	80	21.366 L	35:37	53:25	71:13	89:02	106:50	124:38	142:26	160:15
33	31:10	72	25.852 L	43:05	64:38	86:10	107:43	129:16	150:43	172:21	193:53

SPECIFICATION TIME REQUIRED FOR A 1.0 PSIG PRESSURE DROP FOR SIZE AND LENGTH OF PIPE INDICATED FOR Q = 0.0015*											
1 Pipe Dia. (in)	2 Minimum Time (min:sec)	3 Length for Minimum Time (ft)	4 Time for Longer Length (sec)	Specified Minimum for Length (L) Shown (min:sec)							
				100 ft	150 ft	200 ft	250 ft	300 ft	350 ft	400 ft	450 ft
36	34:00	66	30.768 L	51:17	76:55	102:34	128:12	153:50	179:29	205:07	230:46
42	39:48	57	41.883 L	69:48	104:42	139:37	174:30	209:24	244:19	279:13	314:07
48	45:34	50	54.705 L	91:10	136:45	182:21	227:55	273:31	319:06	364:42	410:17
54	51:02	44	69.236 L	115:24	173:05	230:47	288:29	346:11	403:53	461:34	519:16
60	65:40	40	85.476 L	142:28	213:41	284:55	356:09	427:23	498:37	569:50	641:04

\* If there is no leakage (0 psi drop) after one hour of testing, the tested section shall be accepted.

- G. Exfiltration Test: In order to test for infiltration the Engineer may also require exfiltration tests on each section of pipe between manholes after it has been laid but prior to back filling of joints. Exfiltration tests shall be conducted by plugging the lower end of the section of sewer to be tested and filling the sewer with water to a point approximately five feet above the invert at the lower end and at least one foot above the pipe at the upper end, observing for leakage at all joints and measuring the amount of leakage for a given interval of time. Exfiltration shall not exceed 110 percent times the infiltration limits set out hereinbefore. All observed leaks shall be corrected even though exfiltration is within the allowable limits.
- H. Infiltration Test: To test for infiltration, the Engineer may also require that the Contractor plug the open ends of all lines at the manhole so that measurements may be made at each section of the sewer line. Infiltration tests shall consist of weir measurement to determine quantities of any infiltration. Measurements shall be taken at line locations directed by the Engineer. This infiltration test will not be made until the sewer line is completed, and the Contractor will be required to correct all conditions that are conducive to excessive infiltration and may be required to relay such sections of the line that may not be corrected even though infiltration is within allowable limits.
- I. Smoke testing may be used only to locate leaks and in no case shall be considered conclusive. In all cases the smoke test shall be accompanied by an air test, exfiltration test or infiltration test. Smoke testing may only be performed where ground water is low and smoke is blown into a conduit that is properly sealed. All such leaks or breaks discovered by the smoke tests shall be repaired and/or corrected by the Contractor at his own expense. Equipment and supplies required from smoke tests shall be furnished by the Contractor. The Contractor may also be required to smoke test the first section (manhole-to-manhole) of each size of pipe and type of joint on each construction contract prior to backfilling to establish and check laying and jointing procedures. Other supplementary smoke tests prior to backfilling may be performed by the Contractor at his option; however, any such tests shall not supplant the final tests of the completed work unless such final tests are waived by the Engineer.

3.16 CLEAN UP

- A. Upon completion of installation of the piping and appurtenances, the Contractor shall remove all debris and surplus construction materials resulting from the Work. The Contractor shall grade the ground along each side of pipe trenches in a uniform and neat manner leaving the construction area in a shape as near as possible to the original ground line.

END OF SECTION 333113

SECTION 333913 - SANITARY SEWER MANHOLES, FRAMES, AND COVERS

PART 1 - GENERAL

1.1 SCOPE OF WORK

- A. Provide all labor, materials, equipment and services required for furnishing and installing all manholes and appurtenances specified herein and shown on the Drawings.

1.2 RELATED WORK SPECIFIED ELSEWHERE

- A. Earthwork: Section 312000

1.3 SUBMITTALS

- A. Submit manufacturer’s data and shop drawings for the materials specified herein. Comply with all requirements of Section 013323.
- B. In accordance with the requirements of the General and Special Conditions and this Section, the following table includes, but is not limited to, the items required to be submitted:

Item Description	Shop Drawings	Product Data	Schedules	Installation Data	Parts Lists	Wiring Diagram	Samples	O & M Manual	Certificates	Warranty	Report	Other
Manholes	X				X							
Joint Seal	X	X		X								
Steps	X			X								
Frames & Lids	X											
Pipe Connectors	X											
External Rubber Wrap	X	X										
External Rubber Chimney Seal	X	X										

## PART 2 - PRODUCTS

### 2.1 MANHOLES

- A. Manholes of the form and dimensions shown on the Drawings shall be constructed of ASTM C 478 precast reinforced concrete manhole sections erected on 3,000 psi concrete foundation.
- B. Precast concrete manhole bottom sections may be substituted for "cast-in-place" foundations subject to the Owner's review.
- C. The excavation shall be kept free of water while the manhole is being constructed and the manhole shall not be backfilled until inspected by the Engineer.
- D. Standard Manholes:
  - 1. The standard manhole shall be 4' -0" in diameter and not greater than six (6) feet in depth, measured from the top of the cover frame to the invert of the outlet and shall be cone type- top construction as shown on the Drawings.
  - 2. Manholes greater than six (6) feet in depth, measured as above, shall be paid for as a standard six foot manhole, plus the additional vertical depth at the Contract unit price.
- E. Shallow Manholes:
  - 1. The shallow manholes shall be five (5) feet or less in depth, measured from the top of the cover frame to the invert of the outlet and shall be of flat top construction as shown on the Drawings.
- F. Concrete Manhole Sections:
  - 1. Precast concrete manhole sections (risers and grade rings) shall conform to ASTM C 478.
- G. Precast Concrete Eccentric Cones:
  - 1. Precast concrete eccentric cones shall be of the size and shape shown on the Drawings and shall conform to ASTM C 478.
- H. Precast Manhole Section Joints:
  - 1. Precast manhole section joints shall be jointed with one of the following products:
    - ASTM C 443 rubber gaskets
    - AASHTO M-198-75 preformed flexible butyl type joint sealant
    - Hamilton-Kent "Kent-Seal No. 2"
    - K.T. Snyder Co. "Rub'r-Nek"
    - Press Seal Gasket "E-Z stik"
    - Concrete Sealants, Inc. "Conseal"

or equal, or joined with bituminous mastic joint sealing compound. When making joints with mastic compound prime and seal all joints with primer supplied with the joint

compound. Manhole section joints shall be watertight. These requirements apply to all joints, including manhole risers, cones, and grade rings.

I. External Rubber Wrap:

Each manhole barrel joint shall be sealed with an external rubber wrap as manufactured by Sealing Systems, Inc., or equal. The wrap shall be made of a Stretchable, Self-Shrinking, IntraCuring Halogenated Based Rubber with a minimum thickness of 30 mils. The back side of each unit shall be coated with a cross-linked re-enforced butyl adhesive. The butyl adhesive shall be non-hardening sealant, with a minimum thickness of 30 mils. The wrap shall be designed to stretch around the substrate then overlapped creating a cross-link and fused bond between the rubber and butyl adhesive. The application shall form a continuous rubber seal that applies inward pressure on the protected area for the life of the application. The butyl adhesive and the inward pressure exerted on the substrate will prevent the intrusion of water and soil through the joint sections of a manhole.

External Rubber Wrap Specifications

<b>Height</b>	9 inches
<b>Length</b>	16 or 50 foot rolls
<b>Thickness</b>	60 mils
<b>Height tolerances</b>	9 inches +/- .188"
<b>Length tolerances</b>	+/- 3"
<b>Rubber Thickness tolerances</b>	30 mils
<b>Butyl Adhesive Thickness</b>	30 mils

Stretchable, Self-Shrinking, Intra-Curing Halogenated Based Rubber

Physical Properties	ASTM Test Method	Typical Value
Shear Strength	D816	20 lb. PSI min
Tensile, PSI	D412	50 PSI
Elongation %	D412	500 %
Penetration	D217	60/140 MM
Low Temperature	D746	Minus 49° F flexibility
Heat Aging	D573 7 days @ 90 degrees C	
Tensile Strength	minimum, PSI (MPa) > 100 PSI	Pass
Fusion	5/64" (0.2) max	Pass
Elongation %	minimum 300% at break	Pass
Ozone Resistance	no visible signs of cracking	Pass
Aging and Storage	300% elongation applied (10 Years)	Pass
UV Resistance	No visible signs of cracking	Pass

J. Manhole Inverts:

1. Manhole inverts shall be formed with 3,000 psi concrete. Inverts shall be constructed as shown on the Contract Drawings and shall form a smooth finish. Inverts may be shop

fabricated or constructed on site.

K. Manhole Steps:

1. Plastic manhole steps shall be PS1-PF (Press Fit) polypropylene plastic as manufactured by MA Industries, Peachtree City, Georgia or equal. Steps shall be driven into specially sized holes cast into the manhole section. Holes shall be formed in the manhole section using an insert plug that is removed upon curing.
2. Steps shall be aligned vertically above the outlet, in line with the flow through. Step spacing shall be 16”.

L. Manhole Frames and Covers:

1. Manhole castings shall consist of cast iron frames with a minimum clear opening of twenty-two (22) inches. Casting shall have a minimum of four (4) bolt holes for the purpose of anchoring the casting to the manhole cone or grade ring. Manhole frame castings shall be securely anchored to the manhole. Anchoring shall be by means of ½” diameter stainless steel wedge anchor. Wedge anchors shall only be placed in the cone section or flat top slab, with anchor rod passing through grade ring and frame casting.
2. Manhole covers must set neatly in the rings, with contact edges machined for even bearing and tops flush with ring edge. They shall have sufficient corrugations to prevent slipperiness and be marked in large letters, "SANITARY SEWER". The covers shall have two concealed pick holes. Covers on sanitary sewer manholes shall not be perforated.
3. Acceptable manufacturers are J.R. Hoe & Sons, Middlesboro, KY; John Bouchard & Sons Co., Nashville, TN; and Neenah Foundry Company, Neenah, WI., or equal.
  - a. Where indicated on the Drawings or in the Specifications, Traffic Weight Manhole frames and covers shall be provided. These shall weigh a minimum of 325 pounds.
  - b. Non-Traffic Weight: Manhole frame and cover weight to be minimum of 250 pounds.

M. Watertight Manhole Covers:

1. Watertight manhole covers shall consist of cast iron frames with machined bearing surfaces, continuous gasket seal preinstalled into slots with dovetail design and shall be of the self-sealing type as manufactured by Neenah Foundry Company or equal. Watertight manhole covers shall have sufficient corrugations to prevent slipperiness and be marked in large letters "SANITARY SEWER". Weight of manhole covers shall be as specified in Paragraph 2.1.K of this specification.

N. Pipe Connections Into Manholes:

1. Sewer pipe shall be sealed in the manhole section pipe openings with a resilient connector meeting the requirements of ASTM C923. Resilient connector shall be A-Lok or Z-Lok by A-Lok Products, Inc., Cast-A-Seal 12-08 by Press-Seal Gasket Corporation, or equal.
2. Resilient connector shall be cast integrally into the wall of the manhole section at time of manufacture. There shall be no mortar placed around the connector on the outside of the manhole and no mortar shall be placed around the top half of the connector on the inside



- of the manhole when completing the invert work.
- 3. Resilient connectors requiring compression clamps or take up clamps will not be approved.
- 4. Wherever plastic sewer pipe is to be field grouted into manhole openings, pipe-to-manhole connector seal shall be Fernco Concrete Manhole Adapters manufactured by Fernco, Inc., Division, Michigan, or equal. Adapter shall be mounted on pipe and shall be positioned about the center of the manhole wall.

O. Precast Concrete Manhole Base Sections:

- 1. Precast concrete manhole base sections, if provided in lieu of cast-in-place foundations, shall be "monolithic", consisting of base slab, and base riser section. Upon review and approval by the Owner and Engineer, precast base sections may include floor invert channel and apron. All precast base sections with pipe openings shall be furnished with ASTM C 923 pipe-to-manhole connector gaskets, as specified hereinbefore. Precast base sections shall be furnished with an integral anti-flotation footing, thickness as specified hereinafter, with 6-inch projection, as shown in the Details. Precast base sections shall be set on a 6-inch deep pad (compacted thickness) of dense graded aggregate, placed to proper elevation and leveled. The Engineer reserves the right to inspect precast manhole base sections at the construction site and to reject the use of such sections if the Engineer determines the products unsuitable for the Owner's installation.
- 2. Precast concrete manhole base slab thickness shall comply with the following schedule:

0' - 10'	Vertical Height - 6" Slab
10.1' - 15'	Vertical Height - 8" Slab
15.1' - 20'	Vertical Height - 10" Slab
20.1' - 25'	Vertical Height - 12" Slab
25.1' - 30'	Vertical Height - 14" Slab

P. Drop Connections into Manholes

- 1. Where indicated on the Drawings, drop connections into manholes shall be installed. Drop connections shall be cast-in-place or precast, and shall conform to the requirements shown on the Details.

Q. External Rubber Chimney Seal:

- 1. This section shall include the complete external rubber chimney seal manhole sealing system. The sealing system shall prevent leakage of water into the manhole through the frame joint area and through the adjustment ring area. All materials required for the installation of the sealing system shall be furnished by the contractor and shall be new, of first grade, and shall be of reputable manufacturers known to the trade.
- 2. The casting shall be sealed to the structure with an external rubber chimney sealing system as manufactured by Sealing Systems, Inc., or approved equal. The seal shall be a continuous seamless band made of high quality EPDM (Ethylene Propylene Diene Monomer) rubber with a minimum thickness of 65 mils. There shall be a preformed L shaped corner molded into the top of the seal. The top section and the side section will extend from the L shaped corner at a generally 90-degree angle to each other. Wherein the seal is pre-formed in substantially the same shape as when attached to the manhole structure. The thickness of the L shaped corner extending 1" into the top section and 1" down the side section is increased and may be at least twice the thickness of the top

section reinforcing the seal at this particular area. There shall be a 2" to 3" wide strip of butyl mastic attached to the underside of top section of the seal. There shall be a 2" wide strip of butyl mastic attached to the inside of the side section at the bottom of the seal. The mastic shall be non-hardening butyl rubber sealant, with a minimum thickness of 1/8", and shall seal to the cone/top of the manhole section and over the flange of the casting frame. An aerosol primer shall be used to enhance the bond strength of the seal to the structure.

## 2.2 COMPRESSION COUPLINGS

- A. When joining different types of pipe together or new pipe to existing pipe, the Contractor shall use Fernco Compression Couplings, or equal, that are resistant to corrosion by soil and sewage and that will provide a permanent watertight joint. The compression coupling shall meet the physical test and joint-leak requirements specified in ASTM C-594. The bands for attaching pipes shall be stainless steel conforming to ASTM C-594. Each coupling shall bear the manufacturer's name and an indication of its size.

## 2.03 MANHOLE GRADE ADJUSTMENT

- A. Adjustments to manholes, whether new or existing as shown on the plans will be made in the following manner:
  - 1. A maximum of 12" total height of concrete grade ring will be allowed.  
  
All other elevation adjustment must be made by removing or adding complete barrel section in the manner as described in this section.
  - 2. In no case will concrete grade ring diameter be less than manhole frame.
  - 3. Frames of all new or adjusted manholes within highway construction limits will be secured to the manhole cone section by (2) 3/4" diameter anchor bolts, drilled 3" minimum into the cone.

## PART 3 - EXECUTION

### 3.1 EXCAVATION FOR MANHOLE INSTALLATION

- A. Unless otherwise directed by the Engineer, excavation in which manholes are to be installed shall be excavated in open cut to the depths required by field conditions or as specified by the Engineer. In general this shall be interpreted to mean that machine excavation in earth shall not extend below an elevation permitting the manhole to be properly bedded.
- B. Excavation may be undercut to a depth below the required invert elevation that will permit installing the manhole on a bed of granular material to provide continuous support for the manhole base. When this method is used, the bedding shall be as set out in Paragraph 3.2 hereinafter.

- C. Excavations shall be of sufficient dimensions to provide free working space on all sides of the manhole and to permit proper backfilling around the manhole. All excavated materials shall be placed a minimum of two feet (2') back from the edge of the excavation.
- D. The excavation shall be straight and uniform so as to permit installation of the manhole to lines and grades given by the Engineer. It shall be kept free of water during the installation of the manhole and until the manhole has been backfilled. Removal of water shall be at the Contractor's expense. Dry conditions shall be maintained in the excavations until the backfill has been placed. During the excavation, the grade shall be maintained so that it will freely drain and prevent surface water from entering the excavation at all times. When directed by the Owner or the Engineer, temporary drainage ditches shall be installed to intercept or direct surface water which may affect work. All water shall be pumped or drained from the excavation and disposed of in a suitable manner without damage to adjacent property or to other work.

### 3.2 MANHOLE BEDDING

- A. All manholes shall be supported on a bed of granular material. In no case shall manhole be supported directly on rock. Bedding shall not be a separate pay item unless otherwise set out in the Detailed Specifications. Bedding shall be provided in earth bottom excavations, as well as rock bottom excavations. Bedding material shall be free from rock, foreign material, frozen earth, and be acceptable to the Engineer. Bedding shall be a minimum of 6" below manhole base.
- B. Granular bedding shall be Size #9-m or ASTM C 33, Size #7 crushed stone, fine gravel, or sand, and is not a separate pay item.
- C. Where undercutting and granular bedding is involved it shall be of such depth that the bottom of the manhole will be at least six inches above the bottom of the excavation. Undercutting is not a separate pay item.
- D. In wet, yielding, mucky locations where the manhole is in danger of sinking below grade or floating out of line or grade, or where backfill materials are of such a fluid nature that such movements of the pipe and/or manhole might take place during the placing of the backfill, the pipe and/or manhole must be weighted or secured permanently in place by such means as will prove effective. When ordered by the Engineer, yielding and mucky materials in subgrades shall be removed below ordinary excavation depth in order to prepare a proper bed for the manhole. Crushed stone or other such granular material, if necessary, as determined by the Engineer to replace poor subgrade material, shall be a separate pay item and classified as "Special Granular Fill". Removal of poor material is not a separate pay item.

### 3.3 SPECIAL GRANULAR FILL

- A. As noted in Paragraph 3.2.D, granular material for "Special Granular Fill " when directed by the Engineer shall be Department of Transportation crushed limestone, Size #57. Payment for "Special Granular Fill" must have approval from the Engineer prior to installation.

3.4 BITUMINOUS CONCRETE HIGHWAY, STREET AND DRIVEWAY REPLACEMENT

- A. The Contractor shall replace those sections of existing roads, streets and driveways required to be removed to install the pipelines and manholes under this Contract. He shall construct same to the original lines and grades and in such manner as to leave all such surfaces in fully as good or better condition than that which existed prior to the operations.
- B. Prior to excavating, the pavement shall be scored or cut to straight edges at least twelve (12) inches outside each edge of the proposed excavation to avoid unnecessary damage to the remainder of the paving. Edges of the existing pavement shall be re-cut and trimmed to square, straight edges after the manhole has been installed and prior to placing the new base and pavement.
- C. Backfilling of the excavation shall be in accordance with Method "C" as described hereinbefore. Base course for the paving shall be dense graded crushed limestone furnished and placed in accordance with the current requirements of the Standard Specifications for Road and Bridge Construction of the Department of Transportation, to a depth of six (6) inches in roads and streets and four (4) inches in driveways.
- D. A subslab of reinforced concrete shall be placed for state maintained highways as indicated on the Drawings. The subslab shall have a minimum thickness of 6 inches. Concrete for the subslab shall be 3000 psi, in accordance with the Details shown on the Drawings.
- E. Bituminous Concrete Surface and Bituminous Concrete Base shall conform to the requirements of Sections 402 and 403 of the Standard Specifications for Road and Bridge Construction of the Department of Transportation.

3.5 REMOVING AND REPLACING CONCRETE CURB AND GUTTER

- A. The Contractor shall remove the curb and gutter when encountered when required for installing the manhole. Only that portion of the curb and gutter needed to install the manhole shall be removed. Where concrete curb and gutter removed or disturbed during the construction work, it shall be replaced, using 3,000 psi concrete, in fully as good or better condition than which existed prior to the Contractor's operation.

3.6 REPLACEMENT OF EXISTING MAIL BOXES, CULVERTS, CLOTHES LINE POSTS, FENCES AND OTHER SUCH FACILITIES

- A. Existing mail boxes, drainage culverts, clothes line posts, fences and the like shall not be molested or disturbed unless necessary, in which case, they shall be replaced in as good condition as found as quickly as possible. Existing materials shall be reused in replacing such facilities when materials have not been damaged by the Contractor's operations. Existing facilities damaged by Contractor's operation shall be replaced with new materials of the same type at the Contractor's expense. Work in this category is not a pay item.
- B. Replacement of paved drainage ditches within highway right-of-way shall be accomplished in accordance with Department of Transportation specifications.

3.7 MANHOLE FRAME INSTALLATION

- A. The manhole frame casting shall be centered over the opening in the cone or grade ring of the manhole, with a bituminous mastic joint sealing compound applied between the concrete and the casting.
- B. The frame shall be bolted to the cone or grade ring with stainless steel wedge anchors.

3.8 EXTERNAL RUBBER CHIMNEY SEAL INSTALLATION

- A. The external rubber chimney seal sealing system shall be installed according to the manufacturer’s recommendations. The top section of the seal shall extend 3” attaching to the casting base/flange with the side section covering over the entire grade adjustment ring area and onto the cone section a minimum of 2”.

3.9 TESTING

This specification shall govern the vacuum testing of sanitary sewer manholes and structures and shall be used as a method of determining acceptability by the Owner, in accepting maintenance of a sanitary sewer manhole or structure on behalf of the public. Test procedure shall comply with ASTM C1244. Other forms of testing of some manholes may be required, as deemed necessary by the Owner.

- A. Manholes shall be tested after installation with all connections in place.
  - 1. Lift holes, if any, shall be plugged with an approved, non-shrinkable grout prior to testing.
  - 2. Drop connections shall be installed prior to testing.
  - 3. The vacuum test shall include testing of the seal between the cast iron frame and the concrete cone, slab or grade rings.
  - 4. The manholes shall be backfilled and finished to design grade.
- B. Test Procedure:
  - 1. Temporarily plug, with the plugs being braced to prevent the plugs or pipes from being drawn into the manhole, all pipes entering the manhole at least eight inches into the sewer pipe(s). The plug must be inflated at a location past the manhole/pipe gasket.
  - 2. The test head shall be placed inside the frame at the tope of the manhole and inflated, in accordance with the manufacturer's recommendations.
  - 3. A vacuum of 10" of mercury shall be drawn on the manhole. Shut the valve on the vacuum line to the manhole and disconnect the vacuum line.
  - 4. The pressure gauge shall be liquid filled, having a 3.5 inch diameter face with a reading from zero to thirty inches of mercury.
  - 5. The manhole shall be considered to pass the vacuum test if it holds at least 9 inches of mercury for the following time durations:

Manhole Depth	Time (Minutes)		
	4' Diameter	5' Diameter	6' Diameter
20 Feet or Less	1	2	3
20.1 to 30 Feet	2	3	4

6. If a manhole fails the vacuum test, the manhole shall be repaired with a non-shrinkable grout or other suitable material based on the material of which the manhole is constructed and retested, as stated above.
  7. All temporary plugs and braces shall be removed after each test.
- C. Manholes will be accepted as having passed the vacuum test requirements if they meet the criteria stated above.

### 3.10 CLEAN UP

- A. Upon completion of installation of the manholes and appurtenances, the Contractor shall remove all debris and surplus construction materials resulting from the Work. The Contractor shall grade the ground around and adjacent to the construction area in a uniform and neat manner leaving the construction area in a shape as near as possible to the original ground line.

END OF SECTION 333913



**DEPARTMENT OF THE ARMY**  
U.S. ARMY ENGINEER DISTRICT, LOUISVILLE  
CORPS OF ENGINEERS  
P.O. BOX 59  
LOUISVILLE KY 40201-0059

REPLY TO  
ATTENTION OF:

April 18, 2018

Regulatory Division  
South Branch  
ID No. LRL-2018-32

Mr. Adam Michels  
Kentucky Transportation Cabinet  
Division of Environmental Analysis  
200 Mero Street  
Frankfort, Kentucky 40622

Dear Mr. Michels,

This is in regard to your application for a Department of the Army (DA) permit dated December 28, 2017, concerning a plan to reconstruct US 231 and Natcher Parkway interchange in Warren County, Kentucky. We have reviewed your application and submitted information, and have made the following determinations: the work is minor in nature, will not have a significant impact on the environment, and should encounter no opposition.

Based on these determinations, the proposed work satisfies the Letter of Permission (LOP) criteria, as specified in our regulations and the procedures outlined in the LOP No. 200600259-pgj. Therefore, you are authorized, in accordance with Section 404 of the Clean Water Act (CWA), to impact 698 linear feet (0.09 acre) of streams located in the Jennings Creek Watershed. This permission is granted with the following conditions:

- 1) The project shall be constructed in accordance with plans included in the December 28, 2017, application for Kentucky Transportation Cabinet, Item No. 3-202 and all subsequent information received regarding changes to the original submittal and/or mitigation plan.
- 2) The permittee must provide proof of purchase for 572 AMU stream mitigation credits from the Excel Clark Stream Bank prior to any discharge of dredged or fill material into "waters of the U.S."
- 3) The time limit for completing the work authorized ends on April 30, 2023. If the permittee finds that more time is needed to complete the authorized activity, an application must be submitted for a time extension to this office for consideration at least 1 month before the above date is reached.
- 4) Upon completion of construction you are to notify the District Engineer.

The enclosed Completion Report form must be completed and returned to this office.

- 5) The permittee must agree to comply with the enclosed General Conditions.
- 6) The permittee must comply with the FHWA Rangewide informal program or the 2016 Revised Conservation Strategy CMOA concerning any impacts to Indiana and northern long-eared bats or their habitat.

This authorization will be effective as soon as we receive your signed acceptance of these conditions. Please sign and date the duplicate copy of this letter in the space provided and return the signed copy in the enclosed envelope. Please note that we also perform periodic inspections to ensure compliance with our permit conditions and appropriate Federal laws.

This letter contains a proffered permit for the extension of the Georgetown Bypass project. If you object to this decision, you may request an administrative appeal under Corps regulations at 33 CFR Part 331. Enclosed you will find a Notification of Appeal Process (NAP) fact sheet and Request for Appeal (RFA) form. If you request to appeal this decision, you must submit a completed RFA form to the Great Lakes and Ohio River Division Office at the following address.

US Army Corps of Engineers  
Great Lakes and Ohio River Division  
CELRD-CM-O  
550 Main Street, Rm 10032  
Cincinnati, Ohio 45201-3222

In order for an RFA to be accepted by the Corps, the Corps must determine that it is complete, that it meets the criteria for appeal under 33 CFR Part 331.5, and that it has been received by the Division Office within 60 days of the date of the NAP. Should you decide to submit an RFA form, it must be received at the above address by **June 18, 2018**. It is not necessary to submit an RFA form to the Division Office if you do not object to the decision in this letter.

Copies of this letter will be sent to the appropriate coordinating agencies (see enclosure for addresses).



FOR THE DISTRICT ENGINEER:

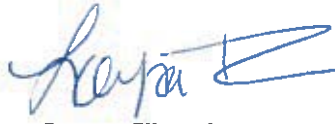

Layna Thrush  
Project Manager, South Branch  
Regulatory Division

Enclosures

(I accept the conditions of this authorization):



\_\_\_\_\_  
Kentucky Transportation Cabinet

4-20-18

\_\_\_\_\_  
Date



GENERAL CONDITIONS:

1. Discharges of dredged or fill material into “waters of the U.S.” must be minimized or avoided to the maximum extent practicable at the project site (i.e. on-site). In determining the minimal impact threshold, the Districts will consider the direct, secondary, and cumulative impacts of the fill or work and any mitigation measures.
2. The permittee shall provide a mitigation/monitoring plan for impacts resulting from the placement of fill into “waters of the U.S.” in excess of 300 linear feet of intermittent or perennial stream; the filling of greater than 0.10 acre (4,356 sq. feet) of waters of the U.S.; or work causing more than minimal effects, to compensate for impacts to the “waters of the U.S.” These impact thresholds are applied for each crossing. When mitigation is required, the permittee will develop the mitigation site concurrently with, or in advance of, the site construction unless the Corps determines on a project specific basis that it is not practical to do so. This will ensure that aquatic functions are not lost for long periods of time (e.g. temporal loss) which could adversely affect water quality and wildlife. The requirement for conservation easements or deed restrictions will be determined on a project specific basis.
3. The permittee shall ensure that sedimentation and soil erosion control measures are in place prior to commencement of construction activities. These measures will remain in place and be properly maintained throughout construction. Sedimentation and soil control measures shall include the installation of straw bale barriers, silt fencing and/or other approved methods to control sedimentation and erosion. Sedimentation and erosion controls will not be placed in “waters of the U.S.” except if specifically approved by the District.
4. The permittee shall ensure that areas disturbed by any construction activity, including channel and stream banks, are immediately stabilized and re-vegetated with a combination of non-invasive plants (grasses, legumes and shrubs) which are compatible with the affected area and will not compete with native vegetation.
5. The permittee shall ensure that no in-stream construction activity is performed during periods of high stream flow or during the fish spawning season (April 1 through June 30) without first contacting the Kentucky Department of Fish and Wildlife Resources (KDFWR) for their expertise on impacts to the fishery resource. Additionally, the discharge of dredged and/or fill material in known waterfowl breeding and wintering areas must be avoided to the maximum extent practicable.
6. The permittee will ensure that the activity authorized will not disrupt movement of those aquatic species indigenous to the water body, including those species which normally migrate through the area, unless the activity's specific purpose is to impound water.

7. The permittee shall ensure that all construction equipment is refueled and maintained on an upland site away from existing streams, drainage ways and wetland areas. Heavy equipment working in wetlands must be placed on mats or other measures must be taken to minimize soil disturbance.
8. The permittee must comply with any case specific special conditions added by the Corps or by the State Section 401 Water Quality Certification (WQC). The conditions imposed in the State Section 401 WQC are also conditions of this LOP.
9. The permittee shall ensure that no activity authorized by the LOP may cause more than a minimal adverse effect on navigation.
10. The permittee shall ensure proper maintenance of any structure or fill authorized by the LOP, in good condition and in conformance with the terms and conditions of the LOP, including maintenance to ensure public safety. The permittee is not relieved of this requirement if the permitted activity is abandoned, although the permittee may make a good faith transfer to a third party. Should the permittee wish to cease to maintain the authorized activity or desire to abandon it without a good faith transfer, the permittee must obtain a modification to the LOP from the Corps, which may require restoration of the area.
11. The permittee shall not perform any work within any Wild and Scenic Rivers or in any river officially designated as a "study river" for possible inclusion in the system, unless the appropriate Federal agency, with direct management responsibility for such river, has determined in writing that the proposed activity authorized by the LOP will not adversely affect the Wild and Scenic River designation or study status. Information on Wild and Scenic Rivers may be obtained from the appropriate Federal Land Management agency in the area (e.g. U.S. Forest Service, Bureau of Land Management, the National Parks Service, or the U.S. Fish and Wildlife Service).
12. The permittee shall not perform any work under the LOP which is likely to jeopardize the continued existence of a threatened or endangered species or a species proposed for such designation, as identified under the Federal Endangered Species Act, or which is likely to destroy or adversely modify the critical habitat of such species. The permittee shall notify the Corps and coordinate the proposed action with the USFWS to determine if any listed species or critical habitat might be affected and/or adversely modified by the proposed work. No activity is authorized under the LOP which "may affect" a listed species or critical habitat, unless Section 7 consultation addressing the effects of the proposed activity has been completed. At the direction of the Corps, the permittee shall complete the necessary consultation with the USFWS, satisfying the requirements of Section 7(a)(2) of the Endangered Species Act. The permittee shall not begin work until notified by the District Engineer that the requirements of the Endangered Species Act have been satisfied and that the activity is authorized. Authorization of an activity under the LOP does not authorize the "take" of a threatened or endangered species as defined

under the Federal Endangered Species Act. In the absence of separate authorization (e.g., an ESA Section 10 Permit, a Biological Opinion with "incidental take" provisions, etc.) from the U.S. Fish and Wildlife Service, both lethal and non-lethal "takes" of protected species are in violation of the Endangered Species Act.

Obligations under Section 7 of the Act must be reconsidered by the Corps Districts if (1) new information reveals impacts of the proposed action may affect listed species or critical habitat in a manner not previously considered, (2) the proposed action is subsequently modified to include activities which were not considered during consultation, or (3) new species are listed or critical habitat designated that might be affected by the proposed action.

13. The permittee shall not perform any activity under the LOP which may affect historic properties listed, or eligible for listing, in the National Register of Historic Places until the District Engineer has complied with the provisions of 33 CFR Part 325, Appendix C. The permittee must notify the District Engineer if the activity authorized by the LOP may affect any historic properties listed, determined to be eligible or which the permittee has reason to believe may be eligible for listing on the National Register of Historic Places, and shall not begin construction until notified by the District Engineer that the requirements of the National Historic Preservation Act have been satisfied and that the activity is authorized. Information on the location and existence of historic resources can be obtained from the Kentucky Heritage Council.

If the permittee discovers any previously unknown historic or archaeological remains while accomplishing the activity authorized by the LOP, work must be immediately stopped and this office immediately notified regarding the discovery. The District will initiate the Federal, Tribal and State coordination required to determine if the remains warrant a recovery effort or if the site is eligible for listing in the National Register of Historic Places.

14. The permittee shall not perform any work under the LOP where the discharge of dredged and/or fill material will occur in the proximity of a public water supply intake.

15. No activity, including structures or work in "waters of the U.S." or discharges of dredged or fill material may consist of unsuitable materials (e.g. trash, debris, car bodies, asphalt, etc.) and that materials used for construction or discharge must be free from toxic pollutants in toxic amounts.

16. The permittee shall, to the maximum extent practicable, design the project to maintain pre-construction downstream flow conditions. Furthermore, the work must not permanently restrict or impede the passage of normal or expected high flows and the structure or discharge of fill must withstand expected high flows. The project must provide, to the maximum extent practicable, for retaining excess flows from the site and for establishing flow rates from the site similar to pre-construction conditions.

17. The permittee shall ensure that all temporary fills, authorized under the LOP, be removed in their entirety and the affected areas returned to pre-construction elevation.

18. Representatives from the Corps of Engineers and/or the State of Kentucky may inspect any authorized activity or mitigation site at any time deemed necessary to ensure compliance with the terms and conditions of the LOP, Section 401 WQC, and applicable laws.

19. All work authorized by this LOP must be completed within five years after the date of the Corps authorization letter. If you find you need more time to complete the authorized activity, submit your request for a time extension to this office for consideration at least three months before the expiration date.

20. The permittee, after completion of work under the LOP, shall submit a signed certification letter regarding the completed work and required mitigation, if applicable. The certification letter will include a statement that the work was done in accordance with the LOP authorization including compliance with all general and special conditions and completion of mitigation work.

21. You must allow representatives from this office to inspect the authorized activity at any time deemed necessary to ensure that it is being or has been accomplished with the terms and conditions of the LOP.

22. For Section 10 waters, if future operations by the United States require the removal, relocation, or other alteration, of the structure or work authorized, or if, in the opinion of the Secretary of the Army or his authorized representative, said structure or work shall cause unreasonable obstruction to the free navigation of the navigable waters, the permittee will be required, upon due notice from the Corps of Engineers, to remove, relocate, or alter the structural work or obstructions caused thereby, without expense to the United States. No claim shall be made against the United States on account of any such removal or alteration.

## ADDRESSES FOR COORDINATING AGENCIES

Mr. Duncan Powell  
USEPA, Region 4  
Sam Nunn Atlanta Federal Center  
61 Forsyth Street, SW  
Atlanta, GA 30303-8960

Mr. Lee Andrews  
U.S. Fish & Wildlife Service  
JC Watts Federal Building  
330 West Broadway, Room 265  
Frankfort, KY 40601

Ms. Andrea Keatley  
Kentucky Energy & Environment Cabinet  
Division of Water  
200 Fair Oaks, 4th Floor  
Frankfort, KY 40601

Mr. Gregory Johnson, Commissioner  
KY Dept. of Fish and Wildlife Resources  
#1 Sportsman's Lane  
Frankfort, KY 40601



**NOTIFICATION OF ADMINISTRATIVE APPEAL OPTIONS AND PROCESS AND  
REQUEST FOR APPEAL**

Applicant: Kentucky Transportation Cabinet		File Number: LRL-2018-32	Date: Apr 18, 2018
Attached is:		See Section below	
	INITIAL PROFFERED PERMIT (Standard Permit or Letter of permission)	A	
X	PROFFERED PERMIT (Standard Permit or Letter of permission)	B	
	PERMIT DENIAL	C	
	APPROVED JURISDICTIONAL DETERMINATION	D	
	PRELIMINARY JURISDICTIONAL DETERMINATION	E	

**SECTION I -** The following identifies your rights and options regarding an administrative appeal of the above decision. Additional information may be found at [http://www.usace.army.mil/CECW/Pages/reg\\_materials.aspx](http://www.usace.army.mil/CECW/Pages/reg_materials.aspx) or Corps regulations at 33 CFR Part 331.

**A: INITIAL PROFFERED PERMIT:** You may accept or object to the permit.

- **ACCEPT:** If you received a Standard Permit, you may sign the permit document and return it to the district engineer for final authorization. If you received a Letter of Permission (LOP), you may accept the LOP and your work is authorized. Your signature on the Standard Permit or acceptance of the LOP means that you accept the permit in its entirety, and waive all rights to appeal the permit, including its terms and conditions, and approved jurisdictional determinations associated with the permit.
- **OBJECT:** If you object to the permit (Standard or LOP) because of certain terms and conditions therein, you may request that the permit be modified accordingly. You must complete Section II of this form and return the form to the district engineer. Your objections must be received by the district engineer within 60 days of the date of this notice, or you will forfeit your right to appeal the permit in the future. Upon receipt of your letter, the district engineer will evaluate your objections and may: (a) modify the permit to address all of your concerns, (b) modify the permit to address some of your objections, or (c) not modify the permit having determined that the permit should be issued as previously written. After evaluating your objections, the district engineer will send you a proffered permit for your reconsideration, as indicated in Section B below.

**B: PROFFERED PERMIT:** You may accept or appeal the permit

- **ACCEPT:** If you received a Standard Permit, you may sign the permit document and return it to the district engineer for final authorization. If you received a Letter of Permission (LOP), you may accept the LOP and your work is authorized. Your signature on the Standard Permit or acceptance of the LOP means that you accept the permit in its entirety, and waive all rights to appeal the permit, including its terms and conditions, and approved jurisdictional determinations associated with the permit.
- **APPEAL:** If you choose to decline the proffered permit (Standard or LOP) because of certain terms and conditions therein, you may appeal the declined permit under the Corps of Engineers Administrative Appeal Process by completing Section II of this form and sending the form to the division engineer. This form must be received by the division engineer within 60 days of the date of this notice.

**C: PERMIT DENIAL:** You may appeal the denial of a permit under the Corps of Engineers Administrative Appeal Process by completing Section II of this form and sending the form to the division engineer. This form must be received by the division engineer within 60 days of the date of this notice.

**D: APPROVED JURISDICTIONAL DETERMINATION:** You may accept or appeal the approved JD or provide new information.

- **ACCEPT:** You do not need to notify the Corps to accept an approved JD. Failure to notify the Corps within 60 days of the date of this notice, means that you accept the approved JD in its entirety, and waive all rights to appeal the approved JD.
- **APPEAL:** If you disagree with the approved JD, you may appeal the approved JD under the Corps of Engineers Administrative Appeal Process by completing Section II of this form and sending the form to the division engineer. This form must be received by the division engineer within 60 days of the date of this notice.

**E: PRELIMINARY JURISDICTIONAL DETERMINATION:** You do not need to respond to the Corps regarding the preliminary JD. The Preliminary JD is not appealable. If you wish, you may request an approved JD (which may be appealed), by contacting the Corps district for further instruction. Also you may provide new information for further consideration by the Corps to reevaluate the JD.



**SECTION II - REQUEST FOR APPEAL or OBJECTIONS TO AN INITIAL PROFFERED PERMIT**

**REASONS FOR APPEAL OR OBJECTIONS:** (Describe your reasons for appealing the decision or your objections to an initial proffered permit in clear concise statements. You may attach additional information to this form to clarify where your reasons or objections are addressed in the administrative record.)

**ADDITIONAL INFORMATION:** The appeal is limited to a review of the administrative record, the Corps memorandum for the record of the appeal conference or meeting, and any supplemental information that the review officer has determined is needed to clarify the administrative record. Neither the appellant nor the Corps may add new information or analyses to the record. However, you may provide additional information to clarify the location of information that is already in the administrative record.

**POINT OF CONTACT FOR QUESTIONS OR INFORMATION:**

If you have questions regarding this decision and/or the appeal process you may contact:

Layna Thrush  
U.S. Army Corps of Engineers  
P.O. Box 59, Rm 752  
Attn: CELRL-RD  
Louisville, Kentucky 40201-0059  
(502) 315 - 6714

If you only have questions regarding the appeal process you may also contact:

U.S. Army Corps of Engineers  
ATTN: Jacob Siegrist  
Regulatory Appeals Review Officer  
CELRD-PD-REG  
550 Main Street, Room 10524  
Cincinnati, OH 45202-3222  
TEL (513) 684-2699; FAX (513) 684-2460

**RIGHT OF ENTRY:** Your signature below grants the right of entry to Corps of Engineers personnel, and any government consultants, to conduct investigations of the project site during the course of the appeal process. You will be provided a 15 day notice of any site investigation, and will have the opportunity to participate in all site investigations.

Signature of appellant or agent.	Date:	Telephone number:
----------------------------------	-------	-------------------

Habitat Acreage Cost Calculator for Use of the Imperiled Bat CMOA (January 2018)														
Project Number:	3-202		County:	Warren		Road:	Natcher Parkway/US-231 Interchange			USFWS KFO-determined price per acre:	\$ 3,420.00			
TOTAL PROGRAMMATIC (B/C/M/OA) COST (Project is an estimate. Final cost may vary due to future changes in average prices.)														
Table from Appendix B of the April 2015 USFWS-KFO Conservation Strategy for Forest-Dwelling Bats in the Commonwealth of Kentucky	# of Acres (lower constant)	# of Acres (higher constant)	NOV 15 - MAR 31 Project Cost Per Acreage Type between NOV 15 - MAR 31 all habitats unoccupied	# of Acres (lower constant)	# of Acres (higher constant)	APR 1 - AUG 15 Project Cost Per Acreage Type between APR 1 - AUG 15 if using higher constant*	# of Acres (lower constant)	# of Acres (higher constant)	AUG 16 - OCT 14 Swarming occupied potential occupied maternity unoccupied	Project Cost Per Acreage Type between AUG 16 - OCT 14	# of Acres (lower constant)	# of Acres (higher constant)	OCT 15 - NOV 14 swarming occupied potential occupied maternity unoccupied	Project Cost Per Acreage Type between OCT 15 - NOV 14
Summer 1 + Swarming 1			2.5 \$			3.0(4.0) ^** \$			3.5 \$				3.5 \$	
Summer 1 + Swarming 2			2.0 \$			2.5(3.5) ^** \$			3.0 \$				3.0 \$	
Summer 2 + Swarming 1			2.0 \$			2.5(3.5) ^** \$			3.0 \$				3.0 \$	
Summer 2 + Swarming 2			1.5 \$			2.0(3.0) ^** \$			2.5 \$				2.5 \$	
Swarming 1			1.5 \$			2.0(3.0) ^** \$			2.5 \$				2.5 \$	
Swarming 2			1.0 \$			1.5(2.5) ^** \$			2.0 \$				2.0 \$	
Summer 1			1.5 \$			2.0(3.0)** \$			1.5 \$				1.5 \$	
Summer 2			1.0 \$			1.5(2.5)** \$			1.0 \$				1.0 \$	
Potential			0.5 \$	0.57		1.0(2.0)** \$			1.0 \$				0.5 \$	
<b>SUBTOTALS</b>	<b>0.00</b>	<b>0.00</b>	<b>\$</b>	<b>0.57</b>	<b>0.00</b>	<b>\$ 1,949.40</b>	<b>0.00</b>	<b>0.00</b>	<b>\$</b>	<b>0.00</b>	<b>0.00</b>	<b>0.00</b>	<b>\$</b>	<b>1,949.40</b>
<p><b>Comments:</b> KYTC proposes to clear 0.57 acres of "potential" habitat for the Indiana bat and northern long-eared bats with seasonal restrictions that require NO TREE CLEARING FROM JUNE 1 TO JULY 31. A small area within the project footprint falls within "Summer 1" habitat for the northern long-eared bat, but no tree clearing will occur in that area. No impacts to winter habitat. The effects determination for the Indiana bat and northern long-eared bat is "may affect, likely to adversely affect". Final costs may vary.</p>											<p>Individual Tree Committed to acreage:****</p> <p># of trees: _____</p> <p>Use this acreage: <b>0</b></p> <p>****NOTE: Individual trees may only be used for projects that include a tree data file which is included in "study report". Standard logging requirements still apply.</p>			
<p>The amount listed above has been determined in accordance with the BFO Participation in CMOA for the Indiana Bat and/or Northern Long-eared Bat Biological Opinion, issued by the US Fish and Wildlife Service April 21, 2015, and any subsequent amendments thereto.</p>											<p>Signature: <i>Ellen Mullins</i> Date: <b>March 15, 2018</b></p>			
<p>All Project Manager, I understand that this authorization for use of the Imperiled Bat CMOA represents an irrevocable commitment for the referenced project. Furthermore, I acknowledge that funds are available for payment of this expense.</p>											<p>Signature: <i>Andrew Stewart</i> Date: <b>3/15/2018</b></p>			
											<p><b>TOTAL ACRES: 0.57</b></p>			

Aerial map showing project footprint, habitat acreage, and coordinates MUST be attached to this form. Multiple maps may be necessary.

KyTC BMP Plan for Project CID ## - ####



**Kentucky Transportation Cabinet**

**Highway District \_3\_**

**And**

\_\_\_\_\_ **(2), Construction**

**Kentucky Pollutant Discharge Elimination System  
Permit KYR10  
Best Management Practices (BMP) plan**

**Groundwater protection plan**

**For Highway Construction Activities**

**For**

**Warren County; I-165 Spur Corridor: Improve I-  
165/ US-231 Interchange (Exit 9)**

**Project: CID 03-2042.20**

KPDES BMP Plan Page 1 of 14

Revised 3/4/2016

## KyTC BMP Plan for Project CID ## - ####

### Project information

Note – (1) = Design (2) = Construction (3) = Contractor

1. Owner – Kentucky Transportation Cabinet, District \_3\_
2. Resident Engineer: (2)
3. Contractor name: (2)  
Address: (2)  
  
Phone number: (2)  
Contact: (2)  
Contractors agent responsible for compliance with the KPDES permit requirements (3):
4. Project Control Number (2)
5. Route (Address) – I-165 and US-231
6. Latitude/Longitude (project mid-point) 36° 59' 32" N/ 86° 30' 14" W
7. County (project mid-point) - Warren
8. Project start date (date work will begin): (2)
9. Projected completion date: (2)



## KyTC BMP Plan for Project CID ## - ####

### A. Site description:

1. Nature of Construction Activity (from letting project description) –Improve I-165 and the US 231 Interchange (Exit 9)
2. Order of major soil disturbing activities (2) and (3)
3. Projected volume of material to be moved – 92,847 cubic yards
4. Estimate of total project area (acres) – 46.78 acres
5. Estimate of area to be disturbed (acres) – 46.78 acres
6. Post construction runoff coefficient will be included in the project drainage folder. Persons needing information pertaining to the runoff coefficient will contact the resident engineer to request this information.
7. Data describing existing soil condition - The Geotechnical Report states that some of the soil horizons and slopes on the project are subject to erosion. & (2)
8. Data describing existing discharge water quality (if any) None known. & (2)
9. Receiving water name – Jennings Creek
10. TMDLs and Pollutants of Concern in Receiving Waters: There are no TMDLs for Jennings Creek at this location according to the KDOW 2016 Integrated Report.
11. Site map – Project layout sheet plus the erosion control sheets in the project plans that depict Disturbed Drainage Areas (DDAs) and related information. These sheets depict the existing project conditions with areas delineated by DDA (drainage area bounded by watershed breaks and right of way limits), the storm water discharge locations (either as a point discharge or as overland flow) and the areas that drain to each discharge point. These plans define the limits of areas to be disturbed and the location of control measures. Controls will be either site specific as designated by the designer or will be annotated by the contractor and resident engineer before disturbance commences. The project layout sheet shows the surface waters and wetlands.

## KyTC BMP Plan for Project CID ## - #####

### 12. Potential sources of pollutants:

The primary source of pollutants is solids that are mobilized during storm events. Other sources of pollutants include oil/fuel/grease from servicing and operating construction equipment, concrete washout water, sanitary wastes and trash/debris. (3)

## B. Sediment and Erosion Control Measures:

1. Plans for highway construction projects will include erosion control sheets that depict Disturbed Drainage Areas (DDAs) and related information. These plan sheets will show the existing project conditions with areas delineated by DDA within the right of way limits, the discharge points and the areas that drain to each discharge point. Project managers and designers will analyze the DDAs and identify Best Management Practices (BMPs) that are site specific. The balance of the BMPs for the project will be listed in the bid documents for selection and use by the contractor on the project with approval by the resident engineer.

Projects that do not have DDAs annotated on the erosion control sheets will employ the same concepts for development and managing BMP plans.

2. Following award of the contract, the contractor and resident engineer will annotate the erosion control sheets showing location and type of BMPs for each of the DDAs that will be disturbed at the outset of the project. This annotation will be accompanied by an order of work that reflects the order or sequence of major soil moving activities. The remaining DDAs are to be designated as "Do Not Disturb" until the contractor and resident engineer prepare the plan for BMPs to be employed. The initial BMP's shall be for the first phase (generally Clearing and Grubbing) and shall be modified as needed as the project changes phases. The BMP Plan will be modified to reflect disturbance in additional DDA's as the work progresses. All DDA's will have adequate BMP's in place before being disturbed.
3. As DDAs are prepared for construction, the following will be addressed for the project as a whole or for each DDA as appropriate:
  - Construction Access – This is the first land-disturbing activity. As soon as construction begins, bare areas will be stabilized with gravel and temporary mulch and/or vegetation.

## KyTC BMP Plan for Project CID ## - #####

- At the beginning of the project, all DDAs for the project will be inspected for areas that are a source of storm water pollutants. Areas that are a source of pollutants will receive appropriate cover or BMPs to arrest the introduction of pollutants into storm water. Areas that have not been opened by the contractor will be inspected periodically (once per month) to determine if there is a need to employ BMPs to keep pollutants from entering storm water.
- Clearing and Grubbing – The following BMP's will be considered and used where appropriate.
  - Leaving areas undisturbed when possible.
  - Silt basins to provide silt volume for large areas.
  - Silt Traps Type A for small areas.
  - Silt Traps Type C in front of existing and drop inlets which are to be saved
  - Diversion ditches to catch sheet runoff and carry it to basins or traps or to divert it around areas to be disturbed.
  - Brush and/or other barriers to slow and/or divert runoff.
  - Silt fences to catch sheet runoff on short slopes. For longer slopes, multiple rows of silt fence may be considered.
  - Temporary Mulch for areas which are not feasible for the fore mentioned types of protections.
  - Non-standard or innovative methods.
- Cut & Fill and placement of drainage structures - The BMP Plan will be modified to show additional BMP's such as:
  - Silt Traps Type B in ditches and/or drainways as they are completed
  - Silt Traps Type C in front of pipes after they are placed
  - Channel Lining
  - Erosion Control Blanket
  - Temporary mulch and/or seeding for areas where construction activities will be ceased for 21 days or more.
  - Non-standard or innovative methods
- Profile and X-Section in place – The BMP Plan will be modified to show elimination of BMP's which had to be removed and the addition of new BMP's as the roadway was shaped. Probably changes include:
  - Silt Trap Type A, Brush and/or other barriers, Temporary Mulch, and any other BMP which had to be removed for final grading to take place.
  - Additional Silt Traps Type B and Type C to be placed as final drainage patterns are put in place.
  - Additional Channel Lining and/or Erosion Control Blanket.
  - Temporary Mulch for areas where Permanent Seeding and Protection cannot be done within 21 days.
  - Special BMP's such as Karst Policy

## KyTC BMP Plan for Project CID ## - ####

- Finish Work (Paving, Seeding, Protect, etc.) – A final BMP Plan will result from modifications during this phase of construction. Probably changes include:
  - Removal of Silt Traps Type B from ditches and drainways if they are protected with other BMP's which are sufficient to control erosion, i.e. Erosion Control Blanket or Permanent Seeding and Protection on moderate grades.
  - Permanent Seeding and Protection
  - Placing Sod
  - Planting trees and/or shrubs where they are included in the project
- BMP's including Storm Water Management Devices such as velocity dissipation devices and Karst policy BMP's to be installed during construction to control the pollutants in storm water discharges that will occur after construction has been completed are : None.

### **C. Other Control Measures**

1. No solid materials, including building materials, shall be discharged to waters of the commonwealth, except as authorized by a Section 404 permit.
2. Waste Materials

All waste materials that may leach pollutants (paint and paint containers, caulk tubes, oil/grease containers, liquids of any kind, soluble materials, etc.) will be collected and stored in appropriate covered waste containers. Waste containers shall be removed from the project site on a sufficiently frequent basis as to not allow wastes to become a source of pollution. All personnel will be instructed regarding the correct procedure for waste disposal. Wastes will be disposed in accordance with appropriate regulations. Notices stating these practices will be posted in the office.

3. Hazardous Waste

All hazardous waste materials will be managed and disposed of in the manner specified by local or state regulation. The contractor shall notify the Section Engineer if there any hazardous wastes being generated at the project site and how these wastes are being managed. Site personnel will be instructed with regard to proper storage and handling of hazardous wastes when required. The Transportation Cabinet will file for generator, registration when appropriate, with the Division of Waste Management and advise the contractor regarding waste management requirements.



## KyTC BMP Plan for Project CID ## - #####

### 4. Spill Prevention

The following material management practices will be used to reduce the risk of spills or other exposure of materials and substances to the weather and/or runoff.

#### ➤ **Good Housekeeping:**

The following good housekeeping practices will be followed onsite during the construction project.

- An effort will be made to store only enough product required to do the job
- All materials stored onsite will be stored in a neat, orderly manner in their appropriate containers and, if possible, under a roof or other enclosure
- Products will be kept in their original containers with the original manufacturer's label
- Substances will not be mixed with one another unless recommended by the manufacturer
- Whenever possible, all of the product will be used up before disposing of the container
- Manufacturers' recommendations for proper use and disposal will be followed
- The site contractor will inspect daily to ensure proper use and disposal of materials onsite

#### ➤ **Hazardous Products:**

These practices will be used to reduce the risks associated with any and all hazardous materials.

- Products will be kept in original containers unless they are not resealable
- Original labels and material safety data sheets (MSDS) will be reviewed and retained
- Contractor will follow procedures recommended by the manufacturer when handling hazardous materials
- If surplus product must be disposed of, manufacturers' or state/local recommended methods for proper disposal will be followed

**The following product-specific practices will be followed onsite:**

#### ➤ **Petroleum Products:**

## KyTC BMP Plan for Project CID ## - #####

Vehicles and equipment that are fueled and maintained on site will be monitored for leaks, and receive regular preventative maintenance to reduce the chance of leakage. Petroleum products onsite will be stored in tightly sealed containers, which are clearly labeled and will be protected from exposure to weather.

The contractor shall prepare an Oil Pollution Spill Prevention Control and Countermeasure plan when the project that involves the storage of petroleum products in 55 gallon or larger containers with a total combined storage capacity of 1,320 gallons. This is a requirement of 40 CFR 112.

This project (will / will not) (3) have over 1,320 gallons of petroleum products with a total capacity, sum of all containers 55 gallon capacity and larger.

### ➤ **Fertilizers:**

Fertilizers will be applied at rates prescribed by the contract, standard specifications or as directed by the resident engineer. Once applied, fertilizer will be covered with mulch or blankets or worked into the soil to limit exposure to storm water. Storage will be in a covered shed. The contents of any partially used bags of fertilizer will be transferred to a sealable plastic bin to avoid spills.

### ➤ **Paints:**

All containers will be tightly sealed and stored indoors or under roof when not being used. Excess paint or paint wash water will not be discharged to the drainage or storm sewer system but will be properly disposed of according to manufacturers' instructions or state and local regulations.

### ➤ **Concrete Truck Washout:**

Concrete truck mixers and chutes will not be washed on pavement, near storm drain inlets, or within 75 feet of any ditch, stream, wetland, lake, or sinkhole. Where possible, excess concrete and wash water will be discharged to areas prepared for pouring new concrete, flat areas to be paved that are away from ditches or drainage system features, or other locations that will not drain off site. Where this approach is not possible, a shallow earthen wash basin will be excavated away from ditches to receive the wash water

### ➤ **Spill Control Practices**

In addition to the good housekeeping and material management practices discussed in the previous sections of this plan, the following practices will be followed for spill prevention and cleanup:

## KyTC BMP Plan for Project CID ## - #####

- Manufacturers' recommended methods for spill cleanup will be clearly posted. All personnel will be made aware of procedures and the location of the information and cleanup supplies.
- Materials and equipment necessary for spill cleanup will be kept in the material storage area. Equipment and materials will include as appropriate, brooms, dust pans, mops, rags, gloves, oil absorbents, sand, sawdust, and plastic and metal trash containers.
- All spills will be cleaned up immediately after discovery.
- The spill area will be kept well ventilated and personnel will wear appropriate protective clothing to prevent injury from contact with a hazardous substance.
- Spills of toxic or hazardous material will be reported to the appropriate state/local agency as required by KRS 224 and applicable federal law.
- The spill prevention plan will be adjusted as needed to prevent spills from reoccurring and improve spill response and cleanup.
- Spills of products will be cleaned up promptly. Wastes from spill clean up will be disposed in accordance with appropriate regulations.

### **D. Other State and Local Plans**

This BMP plan shall include any requirements specified in sediment and erosion control plans, storm water management plans or permits that have been approved by other state or local officials. Upon submittal of the NOI, other requirements for surface water protection are incorporated by reference into and are enforceable under this permit (even if they are not specifically included in this BMP plan). This provision does not apply to master or comprehensive plans, non-enforceable guidelines or technical guidance documents that are not identified in a specific plan or permit issued for the construction site by state or local officials. Warren County is a MS4 Community, and the BMP Plan and NOI should be also be submitted to Matt Powell at the City of Bowling Green at [matt.powell@bgky.org](mailto:matt.powell@bgky.org).

#### Maintenance

1. The BMP plan shall include a clear description of the maintenance procedures necessary to keep the control measures in good and effective operating condition.
- Maintenance of BMPs during construction shall be a result of weekly and post rain event inspections with action being taken by the contractor to correct deficiencies.
  - Post Construction maintenance will be a function of normal highway maintenance operations. Following final project acceptance by the

## KyTC BMP Plan for Project CID ## - #####

cabinet, district highway crews will be responsible for identification and correction of deficiencies regarding ground cover and cleaning of storm water BMPs. The project manager shall identify any BMPs that will be for the purpose of post construction storm water management with specific guidance for any non-routine maintenance. None.

### **E. Inspections**

Inspection and maintenance practices that will be used to maintain erosion and sediment controls:

- All erosion prevention and sediment control measures will be inspected at least once each week and following any rain of one-half inch or more.
- Inspections will be conducted by individuals that have successfully completed the KEPSC-RI course as required by Section 213.02.02 of the Standard Specifications for Road and Bridge Construction, current edition.
- Inspection reports will be written, signed, dated, and kept on file.
- Areas at final grade will be seeded and mulched within 14 days.
- Areas that are not at final grade where construction has ceased for a period of 21 days or longer and soil stock piles shall receive temporary mulch no later than 14 days from the last construction activity in that area.
- All measures will be maintained in good working order; if a repair is necessary, it will be initiated within 24 hours of being reported.
- Built-up sediment will be removed from behind the silt fence before it has reached halfway up the height of the fence.
- Silt fences will be inspected for bypassing, overtopping, undercutting, depth of sediment, tears, and to ensure attachment to secure posts.
- Sediment basins will be inspected for depth of sediment, and built-up sediment will be removed when it reaches 50 percent of the design capacity and at the end of the job.
- Diversion dikes and berms will be inspected and any breaches promptly repaired. Areas that are eroding or scouring will be repaired and re-seeded / mulched as needed.
- Temporary and permanent seeding and mulching will be inspected for bare spots, washouts, and healthy growth. Bare or eroded areas will be repaired as needed.
- All material storage and equipment servicing areas that involve the management of bulk liquids, fuels, and bulk solids will be inspected

## KyTC BMP Plan for Project CID ## - ####

weekly for conditions that represent a release or possible release of pollutants to the environment.

### **F. Non – Storm Water discharges**

It is expected that non-storm water discharges may occur from the site during the construction period. Examples of non-storm water discharges include:

- Water from water line flushings.
- Water form cleaning concrete trucks and equipment.
- Pavement wash waters (where no spills or leaks of toxic or hazardous materials have occurred).
- Uncontaminated groundwater and rain water (from dewatering during excavation).

All non-storm water discharges will be directed to the sediment basin or to a filter fence enclosure in a flat vegetated infiltration area or be filtered via another approved commercial product.

### **G. Groundwater Protection Plan (3)**

This plan serves as the groundwater protection plan as required by 401 KAR 5:037.

- Contractors statement: (3)

The following activities, as enumerated by 401 KAR 5:037 Section 2 that require the preparation and implementation of a groundwater protection plan, will or may be may be conducted as part of this construction project:

\_\_\_\_\_ 2. (e) land treatment or land disposal of a pollutant;

\_\_\_\_\_ 2. (f) Storing, ..., or related handling of hazardous waste, solid waste or special waste, ..., in tanks, drums, or other containers, or in piles, (This does not include wastes managed in a container placed for collection and removal of municipal solid waste for disposal off site);

\_\_\_\_\_ 2. (g) .... Handling of materials in bulk quantities (equal or greater than 55 gallons or 100 pounds net dry weight transported held in an individual container) that, if released to the environment, would be a pollutant;

\_\_\_\_\_ 2. (j) Storing or related handling of road oils, dust suppressants, ....., at a central location;

## KyTC BMP Plan for Project CID ## - #####

\_\_\_\_\_ 2. (k) Application or related handling of road oils, dust suppressants or deicing materials, (does not include use of chloride-based deicing materials applied to roads or parking lots);

\_\_\_\_\_ 2. (m) Installation, construction, operation, or abandonment of wells, bore holes, or core holes, (this does not include bore holes for the purpose of explosive demolition);

Or, check the following only if there are no qualifying activities

\_\_\_\_\_ There are no activities for this project as listed in 401 KAR 5:037 Section 2 that require the preparation and implementation of a groundwater protection plan.

The contractor is responsible for the preparation of a plan that addresses the

401 KAR 5:037 Section 3. (3) Elements of site specific groundwater protection plan:

- (a) General information about this project is covered in the Project information;
- (b) Activities that require a groundwater protection plan have been identified above;
- (c) Practices that will protect groundwater from pollution are addressed in section C. Other control measures.
- (d) Implementation schedule – all practices required to prevent pollution of groundwater are to be in place prior to conducting the activity;
- (e) Training is required as a part of the ground water protection plan. All employees of the contractor, sub-contractor and resident engineer personnel will be trained to understand the nature and requirements of this plan as they pertain to their job function(s). Training will be accomplished within one week of employment and annually thereafter. A record of training will be maintained by the contractor with a copy provide to the resident engineer.
- (f) Areas of the project and groundwater plan activities will be inspected as part of the weekly sediment and erosion control inspections
- (g) Certification (see signature page.)

Contractor and Resident Engineer Plan certification

The contractor that is responsible for implementing this BMP plan is identified in the Project Information section of this plan.







## ***SPECIAL NOTE***

### **Filing of eNOI for KPDES Construction Stormwater Permit**

**County: Warren**  
**Item No.: 3-2042.20**

**Route: US 231 & I-165**  
**KDOW Submittal ID: 192847**

#### **Project Description: Interchange improvements of US 231 & I-165**

**A Notice of Intent for obtaining coverage under the Kentucky Pollutant Discharge Elimination System (KPDES) General Permit for Stormwater Discharges Associated with Construction Activities (KYR10) has been drafted, copy of which is attached. Upon award, the Contractor will be identified in Section III of the form as the “Building Contractor” and it will be submitted for approval to the Kentucky Division of Water. The Contractor shall be responsible for advancing the work in a manner that is compliant with all applicable and appropriate KYTC specifications for sediment and erosion control as well as meeting the requirements of the KYR10 permit and the KDOW.**

**If there are any questions regarding this note, please contact David Waldner, Director, Division of Environmental Analysis, TCOB, 200 Mero Street, Frankfort, KY 40622, Phone: (502) 564-7250.**

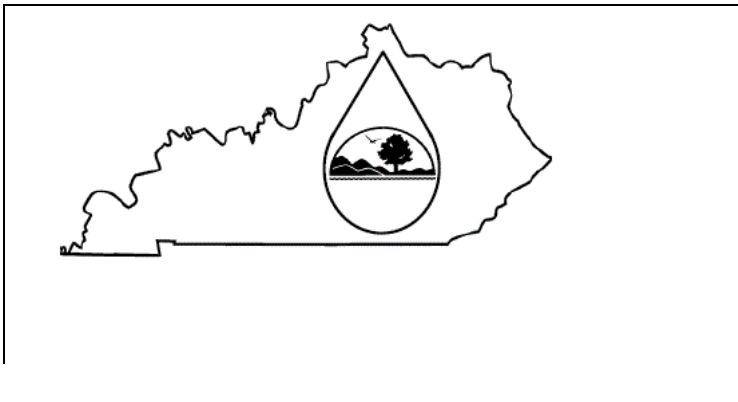

## KENTUCKY POLLUTION DISCHARGE ELIMINATION SYSTEM (KPDES)

Notice of Intent (NOI) for coverage of Storm Water Discharge  
Associated with Construction Activities Under the KPDES Storm  
Water General Permit KYR100000

[Click here for Instructions  
\(Controls/KPDES\\_FormKYR10\\_Instructions.htm\)](#)

[Click here to obtain information and a copy of the KPDES General Permit.  
\(http://dep.ky.gov/formslibrary/Documents/KYR10PermitPage.pdf\)](http://dep.ky.gov/formslibrary/Documents/KYR10PermitPage.pdf)

(\*) indicates a required field; (✓) indicates a field may be required based on user input or is an optionally required field

Reason for Submittal:(*) <input type="text" value="Application for New Permit Coverage"/>	Agency Interest ID: <input type="text" value="Agency Interest ID"/>	Permit Number:(✓) <input type="text" value="KPDES Permit Number"/>
--	--	---

If change to existing permit coverage is requested, describe the changes for which modification of coverage is being sought:(✓)

**ELIGIBILITY:**  
Stormwater discharges associated with construction activities disturbing individually one (1) acre or more, including, in the case of a common plan of development, contiguous construction activities that cumulatively equal one (1) acre or more of disturbance.

**EXCLUSIONS:**  
The following are excluded from coverage under this general permit:  
 1) Are conducted at or on properties that have obtained an individual KPDES permit for the discharge of other wastewaters which requires the development and implementation of a Best Management Practices (BMP) plan;  
 2) Any operation that the DOW determines an individual permit would better address the discharges from that operation;  
 3) Any project that discharges to an Impaired Water listed in the most recent Integrated Report, §305(b) as impaired for sediment and for which an approved TMDL has been developed.

**SECTION I -- FACILITY OPERATOR INFORMATION (PERMITTEE)**

Company Name:(✓) <input type="text" value="Kentucky Transportation Cabinet Department of Highways"/>	First Name:(✓) <input type="text" value="Gavin"/>	M.I.: <input type="text" value="MI"/>	Last Name:(✓) <input type="text" value="Hodges"/>
Mailing Address:(*) <input type="text" value="900 Morgantown Road"/>	City:(*) <input type="text" value="Bowling Green, KY"/>	State:(*) <input type="text" value="Kentucky"/>	Zip:(*) <input type="text" value="42101"/>
eMail Address:(*) <input type="text" value="gavin.hodges@ky.gov"/>	Business Phone:(*) <input type="text" value="2707467898"/>	Alternate Phone: <input type="text" value="2705791297"/>	

**SECTION II -- GENERAL SITE LOCATION INFORMATION**

Project Name:(*) <input type="text" value="3-2042.20 (I-165 Interchange at US 231 (Exit 9) )"/>	Status of Owner/Operator(*) <input type="text" value="State Government"/>	SIC Code(*) <input type="text" value=""/>
Company Name:(✓) <input type="text" value="Kentucky Transportation Cabinet Department of Highways"/>	First Name:(✓) <input type="text" value="Gavin"/>	M.I.: <input type="text" value="MI"/>
Last Name:(✓) <input type="text" value="Hodges"/>		
Site Physical Address:(*) <input type="text" value="900 Morgantown Road"/>		
City:(*) <input type="text" value="Bowling Green, KY"/>	State:(*) <input type="text" value="Kentucky"/>	Zip:(*) <input type="text" value="42101"/>
County:(*) <input type="text" value="Warren"/>	Latitude(decimal degrees)(*)DMS to DD Converter (https://www.fcc.gov/media/radio/dms-decimal) <input type="text" value="36.992222"/>	Longitude(decimal degrees)(*) <input type="text" value="-86.503889"/>

**SECTION III -- SPECIFIC SITE ACTIVITY INFORMATION**

Project Description:(\*)

a. For single projects provide the following information

Total Number of Acres in Project:(√) 50.00	Total Number of Acres Disturbed:(√) 46.78
Anticipated Start Date:(√)	Anticipated Completion Date:(√)

b. For common plans of development provide the following information

Total Number of Acres in Project:(√) # Acre(s)	Total Number of Acres Disturbed:(√) # Acre(s)
Number of individual lots in development, if applicable:(√) # lot(s)	Number of lots in development:(√) # lot(s)
Total acreage of lots intended to be developed:(√) Project Acres	Number of acres intended to be disturbed at any one time:(√) Disturbed Acres
Anticipated Start Date:(√)	Anticipated Completion Date:(√)

List Building Contractor(s) at the time of Application:(\*)

Company Name
+  

SECTION IV -- IF THE PERMITTED SITE DISCHARGES TO A WATER BODY THE FOLLOWING INFORMATION IS REQUIRED ?

Discharge Point(s):

Unnamed Tributary?	Latitude	Longitude	Receiving Water Name
+  			

SECTION V -- IF THE PERMITTED SITE DISCHARGES TO A MS4 THE FOLLOWING INFORMATION IS REQUIRED ?

Name of MS4:  
City of Bowling Green-BOWLING GREEN

Date of application/notification to the MS4 for construction site permit coverage: Date	Discharge Point(s):(*) <table border="1"> <thead> <tr> <th>Latitude</th> <th>Longitude</th> </tr> </thead> <tbody> <tr> <td>+  </td> <td></td> </tr> </tbody> </table>	Latitude	Longitude	+  	
Latitude	Longitude				
+  					

SECTION VI -- WILL THE PROJECT REQUIRE CONSTRUCTION ACTIVITIES IN A WATER BODY OR THE RIPARIAN ZONE?

Will the project require construction activities in a water body or the riparian zone?: (*)	Yes
If Yes, describe scope of activity: (√)	Culvert Work
Is a Clean Water Act 404 permit required?:(*)	No

Is a Clean Water Act 401 Water Quality Certification required?:(*)		Yes	
<b>SECTION VII -- NOI PREPARER INFORMATION</b>			
First Name:(*) Gavin	M.I.: MI	Last Name:(*) Hodges	Company Name:(*) Kentucky Transportation Cabinet Department of Highways
Mailing Address:(*) 900 Morgantown Road	City:(*) Bowling Green, KY	State:(*) Kentucky	Zip:(*) 42101
eMail Address:(*) gavin.hodges@ky.gov	Business Phone:(*) 2707467898	Alternate Phone: 2705791297	
<b>SECTION VIII -- ATTACHMENTS</b>			
Facility Location Map:(*)	Upload file		
Supplemental Information:	Upload file		
<b>SECTION IX -- CERTIFICATION</b>			
I certify under penalty of law that this document and all attachments were prepared under my direction or supervision in accordance with a system designed to assure that qualified personnel properly gather and evaluate the information submitted. Based on my inquiry of the person or persons who manage the system, or those persons directly responsible for gathering the information submitted is, to the best of my knowledge and belief, true, accurate, and complete. I am aware that there are significant penalties for submitting false information, including the possibility of fine and imprisonment for knowing violations.			
Signature:(*) Gavin Hodges		Title:(*) Environmental Coordinator	
First Name:(*) Gavin	M.I.: MI	Last Name:(*) Hodges	
eMail Address:(*) gavin.hodges@ky.gov	Business Phone:(*) 2707467898	Alternate Phone: 2705791297	Signature Date:(*) Date
<div style="display: flex; justify-content: space-around; margin-top: 20px;"> <span>Click to Save Values for Future Retrieval</span> <span>Click to Submit to EEC</span> </div>			

**PART II**  
**SPECIFICATIONS AND STANDARD DRAWINGS**

### **SPECIFICATIONS REFERENCE**

Any reference in the plans or proposal to previous editions of the *Standard Specifications for Road and Bridge Construction* and *Standard Drawings* are superseded by *Standard Specifications for Road and Bridge Construction, Edition of 2019* and *Standard Drawings, Edition of 2020*.

## **SUPPLEMENTAL SPECIFICATIONS**

The contractor shall use the Supplemental Specifications that are effective at the time of letting.  
The Supplemental Specifications can be found at the following link:

<http://transportation.ky.gov/Construction/Pages/Kentucky-Standard-Specifications.aspx>

## **SPECIAL NOTE FOR PORTABLE CHANGEABLE MESSAGE SIGNS**

This Special Note will apply when indicated on the plans or in the proposal.

**1.0 DESCRIPTION.** Furnish, install, operate, and maintain variable message signs at the locations shown on the plans or designated by the Engineer. Remove and retain possession of variable message signs when they are no longer needed on the project.

### **2.0 MATERIALS.**

**2.1 General.** Use LED Variable Message Signs Class I, II, or III, as appropriate, from the Department's List of Approved Materials.

Unclassified signs may be submitted for approval by the Engineer. The Engineer may require a daytime and nighttime demonstration. The Engineer will make a final decision within 30 days after all required information is received.

#### **2.2 Sign and Controls.** All signs must:

- 1) Provide 3-line messages with each line being 8 characters long and at least 18 inches tall. Each character comprises 35 pixels.
- 2) Provide at least 40 preprogrammed messages available for use at any time. Provide for quick and easy change of the displayed message; editing of the message; and additions of new messages.
- 3) Provide a controller consisting of:
  - a) Keyboard or keypad.
  - b) Readout that mimics the actual sign display. (When LCD or LCD type readout is used, include backlighting and heating or otherwise arrange for viewing in cold temperatures.)
  - c) Non-volatile memory or suitable memory with battery backup for storing pre-programmed messages.
  - d) Logic circuitry to control the sequence of messages and flash rate.
- 4) Provide a serial interface that is capable of supporting complete remote control ability through land line and cellular telephone operation. Include communication software capable of immediately updating the message, providing complete sign status, and allowing message library queries and updates.
- 5) Allow a single person easily to raise the sign to a satisfactory height above the pavement during use, and lower the sign during travel.
- 6) Be Highway Orange on all exterior surfaces of the trailer, supports, and controller cabinet.
- 7) Provide operation in ambient temperatures from -30 to + 120 degrees Fahrenheit during snow, rain and other inclement weather.
- 8) Provide the driver board as part of a module. All modules are interchangeable, and have plug and socket arrangements for disconnection and reconnection. Printed circuit boards associated with driver boards have a conformable coating to protect against moisture.
- 9) Provide a sign case sealed against rain, snow, dust, insects, etc. The lens is UV stabilized clear plastic (polycarbonate, acrylic, or other approved material) angled to prevent glare.
- 10) Provide a flat black UV protected coating on the sign hardware, character PCB, and appropriate lens areas.
- 11) Provide a photocell control to provide automatic dimming.



- 12) Allow an on-off flashing sequence at an adjustable rate.
- 13) Provide a sight to aim the message.
- 14) Provide a LED display color of approximately 590 nm amber.
- 15) Provide a controller that is password protected.
- 16) Provide a security device that prevents unauthorized individuals from accessing the controller.
- 17) Provide the following 3-line messages preprogrammed and available for use when the sign unit begins operation:

/KEEP/RIGHT/=>=>=>/	/MIN/SPEED/**MPH/
/KEEP/LEFT/<<<</	/ICY/BRIDGE/AHEAD/ /ONE
/LOOSE/GRAVEL/AHEAD/	LANE/BRIDGE/AHEAD/
/RD WORK/NEXT/**MILES/	/ROUGH/ROAD/AHEAD/
/TWO WAY/TRAFFIC/AHEAD/	/MERGING/TRAFFIC/AHEAD/
/PAINT/CREW/AHEAD/	/NEXT/***/MILES/
/REDUCE/SPEED/**MPH/	/HEAVY/TRAFFIC/AHEAD/
/BRIDGE/WORK/***0 FT/	/SPEED/LIMIT/**MPH/
/MAX/SPEED/**MPH/	/BUMP/AHEAD/
/SURVEY/PARTY/AHEAD/	/TWO/WAY/TRAFFIC/

\*Insert numerals as directed by the Engineer.  
Add other messages during the project when required by the Engineer.

**2.3 Power.**

- 1) Design solar panels to yield 10 percent or greater additional charge than sign consumption. Provide direct wiring for operation of the sign or arrow board from an external power source to provide energy backup for 21 days without sunlight and an on-board system charger with the ability to recharge completely discharged batteries in 24 hours.

**3.0 CONSTRUCTION.** Furnish and operate the variable message signs as designated on the plans or by the Engineer. Ensure the bottom of the message panel is a minimum of 7 feet above the roadway in urban areas and 5 feet above in rural areas when operating. Use Class I, II, or III signs on roads with a speed limit less than 55 mph. Use Class I or II signs on roads with speed limits 55 mph or greater.

Maintain the sign in proper working order, including repair of any damage done by others, until completion of the project. When the sign becomes inoperative, immediately repair or replace the sign. Repetitive problems with the same unit will be cause for rejection and replacement.

Use only project related messages and messages directed by the Engineer, unnecessary messages lessen the impact of the sign. Ensure the message is displayed in either one or 2 phases with each phase having no more than 3 lines of text. When no message is needed, but it is necessary to know if the sign is operable, flash only a pixel.

When the sign is not needed, move it outside the clear zone or where the Engineer directs. Variable Message Signs are the property of the Contractor and shall be removed from the project when no longer needed. The Department will not assume ownership of these signs.

**4.0 MEASUREMENT.** The final quantity of Variable Message Sign will be

11

the actual number of individual signs acceptably furnished and operated during the project. The Department will not measure signs replaced due to damage or rejection.

**5.0 PAYMENT.** The Department will pay for the Variable Message Signs at the unit price each. The Department will not pay for signs replaced due to damage or rejection. Payment is full compensation for furnishing all materials, labor, equipment, and service necessary to, operate, move, repair, and maintain or replace the variable message signs. The Department will make payment for the completed and accepted quantities under the following:

<u>Code</u>	<u>Pay Item</u>	<u>Pay Unit</u>
02671	Portable Changeable Message Sign	Each

Effective June 15, 2012

11K

### **SPECIAL NOTE FOR PARTIAL DEPTH CONCRETE PAVEMENT REPAIR**

This Special Note applies to partial depth repairs of concrete pavement. Section references herein are to the Department's Standard Specifications for Road and Bridge Construction, current edition.

**1.0 DESCRIPTION.** Remove and replace small, shallow areas of deteriorated concrete that extend no deeper than one-third of the slab thickness. Comply with the applicable Standard Drawings and the Standard Specifications except as specifically superseded herein.

#### **2.0 MATERIALS AND EQUIPMENT.**

**2.1 JPC Pavement 24/48/72.** Conform to Section 502.

**2.2 Latex Materials.** Conform to Section 606.

**2.3 Rapid Set Concrete Patching Materials.** See the List of Approved Materials for Rapid and Very Rapid hardening materials from the Division of Materials.

**2.4 Hot-Poured Elastic and Silicone Rubber Sealant.** Conform to Subsection 807.03.01 or 807.03.05.

**2.5 Hammers.** Only use chisel point hammers weighing less than 15 pounds to remove deteriorated concrete.

#### **3.0 CONSTRUCTION.**

**3.1 Repair Dimension Selection.** The locations for partial-depth repair will be identified in the plans or proposal or as specified by the Engineer during construction. Identify the repair boundaries by sounding the concrete with a solid steel rod, a heavy chain, or a ball peen hammer. Repair boundaries should extend a minimum of 3 inches outside unsound areas.

**3.2 Concrete Removal.** Saw the hole to be patched with a vertical face, to a 2-inch minimum depth and to the configuration the Contract specifies or the Engineer directs. After sawing, keep exposure to traffic to a minimum until patching.

If the area to be patched is deeper than 1/3 the slab depth, construct full depth patches according to the "Special Note for Full-Depth Concrete Pavement Repair". Partial depth patches that become full depth repairs will be paid forty (40) percent of the unit price for Partial Depth Patching.

Keep overcutting beyond the limits of the removed area to a minimum. Prevent saw slurry from entering existing joints and cracks. Clean all saw slurry and other contaminants from overcutting. Repair the overcut area with a low viscosity epoxy compound.

**3.3 Repair Area Preparation.** Following the removal of the concrete, the surface of the repair area must be prepared to provide a clean, irregular surface for the development of a good bond between the repair material and the

11K

existing slab. Clean the repair area by sandblasting followed by compressed airblasting to remove dirt, oil, thin layers of unsound concrete, and laitance. The compressed air used in the final cleaning must be free of oil. This should be checked by placing a cloth over the air compressor nozzle and visually inspecting for oil.

**3.4 Joint Preparation.** Partial-depth repairs placed against transverse joints require the use of an insert to act as a bondbreaker or joint reformer. Place the insert so that it prevents intrusion of repair material into the joint opening. Insure the compressible insert extends 1 inch below and 3 inches beyond the repair boundaries. Prior to placement, score the insert at the appropriate depth to accommodate the joint sealant material to be used. Once the patch has cured or set, remove the scored top strip to allow for the joint sealant to be placed.

### **3.5 Patching Material and Placement.**

**3.5.1 Portland Cement Patch.** Use a mixture conforming to Section 502 except use No. 8 or 9M coarse aggregate. Submit a mix design for the Engineer's approval. Vigorously scrub a grout bond coat into the repair area. Use a grout consisting of a slurry made of water mixed with equal parts of Portland cement and mortar sand.

Place the patch before the grout shows any sign of drying. Cure according to Subsection 502.03. Two applications of curing compound will be required. Remove and replace all areas of the patches that display cracks or are not bonded to the underlying pavement.

**3.5.2 Latex Concrete Patch.** Prepare the patch area and apply a latex grout bond coat. Furnish, mix, place, and cure the latex concrete according to Section 606. Ensure the curing materials required by Subsection 606.03.17 A) 4) remain in place for the specified time. Remove and replace all areas of the patches that display cracks or are not bonded to the underlying pavement.

**3.5.3 Rapid Set Concrete Patching Materials.** Furnish a repair material specified as "Rapid" or "Very Rapid" hardening listed on the Division of Materials *List of Approved Materials* when the repair area is required to be opened to traffic in a short time frame. A substitute product may be allowed only after submittal and approval by the Division of Materials. Repair materials should be installed according to the manufacturer's recommendations. All materials used will be tested prior to the project beginning to insure that a minimum opening compressive strength of 3,000 psi can be obtained based on the time requirements listed in the maintenance of traffic notes for the project.

Remove and replace all areas of the patches that display cracks or are not bonded to the underlying pavement.

**3.6 Joint Sealing.** Seal all new or partially new joints with hot-poured elastic or silicone rubber sealant according to Subsection 501.03.18 D).

11K

**4.0 MEASUREMENT.**

**4.1 Partial Depth Patching.** The Department will measure the quantity in cubic feet, either from field measurements or the metered quantity from the mixer, as the Engineer determines.

**5.0 PAYMENT.** The Department will make payment for the completed and accepted quantities under the following:

<u>Code</u>	<u>Pay Item</u>	<u>Pay Unit</u>
02110	Partial Depth Patching	Cubic Foot

The Department will consider payment as full compensation for all work required in this provision.

June 15, 2012

## SPECIAL NOTE FOR BARCODE LABEL ON PERMANENT SIGNS

**1.0 DESCRIPTION.** Install barcode label on sheeting signs. Section references herein are to the Department’s Standard Specifications for Road and Bridge Construction, current edition.

**2.0 MATERIALS.** The Department will provide the Contractor with a 2 inch x 1 inch foil barcode label for each permanent sheeting sign. A unique number will be assigned to each barcode label.

The Contractor shall contact the Operations and Pavement Management Branch in the Division of Maintenance at (502) 564-4556 to obtain the barcode labels.

**3.0 CONSTRUCTION.** Apply foil barcode label in the lower right quadrant of the sign back. Signs where the bottom edge is not parallel to the ground, the lowest corner of the sign shall serve as the location to place the barcode label. The barcode label shall be placed no less than one-inch and no more than three inches from any edge of the sign. The barcode must be placed so that the sign post does not cover the barcode label.

Barcodes shall be applied in an indoor setting with a minimum air temperature of 50°F or higher. Prior to application of the barcode label, the back of the sign must be clean and free of dust, oil, etc. If the sign is not clean, an alcohol swab shall be used to clean the area. The area must be allowed to dry prior to placement of the barcode label.

Data for each sign shall include the barcode number, MUTCD reference number, sheeting manufacturer, sheeting type, manufacture date, color of primary reflective surface, installation date, latitude and longitude using the North American Datum of 1983 (NAD83) or the State Plane Coordinates using an x and y ordinate of the installed location.

Data should be provided electronically on the TC 71-229 Sign Details Information and TC 71-230 Sign Assembly Information forms. The Contractor may choose to present the data in a different format provided that the information submitted to the Department is equivalent to the information required on the Department TC forms. The forms must be submitted in electronic format regardless of which type of form is used. The Department will not accept PDF or handwritten forms. These completed forms must be submitted to the Department prior to final inspection of the signs. The Department will not issue formal acceptance for the project until the TC 71-229 and TC-230 electronic forms are completed for all signs and sign assemblies on the project.

**4.0 MEASUREMENT.** The Department will measure all work required for the installation of the barcode label and all work associated with completion and submission of the sign inventory data (TC 71-229 and TC 71-230).

The installation of the permanent sign will be measured in accordance to Section 715.

**5.0 PAYMENT.** The Department will make payment for the completed and accepted quantities under the following:

<u>Code</u>	<u>Pay Item</u>	<u>Pay Unit</u>
24631EC	Barcode Sign Inventory	Each

The Department will not make payment for this item until all barcodes are installed and sign inventory is complete on every permanent sign installed on the project. The Department will make payment for installation of the permanent sign in accordance to Section 715. The Department will consider payment as full compensation for all work required under this special note.

### One Sign Post



↑  
2" Wide Post

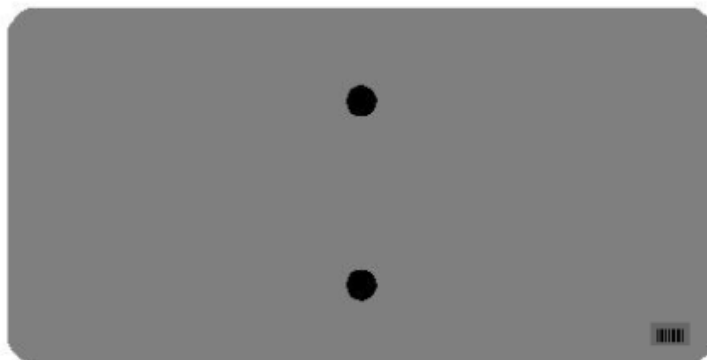
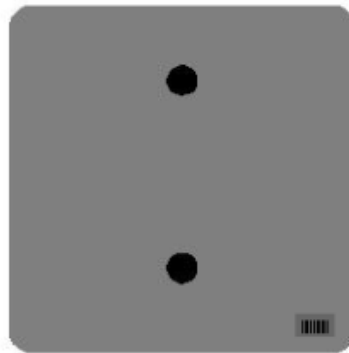

### One Sign Post

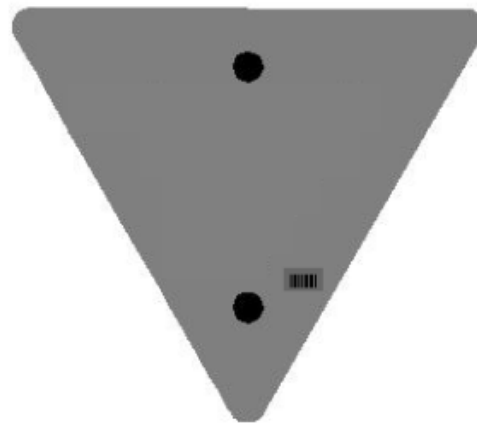
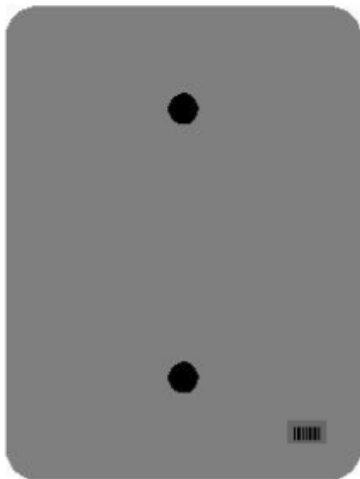
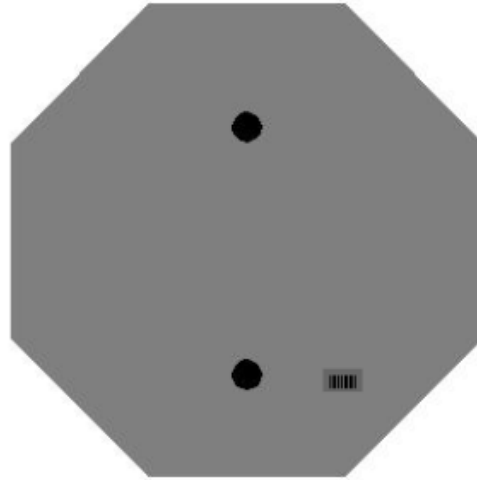
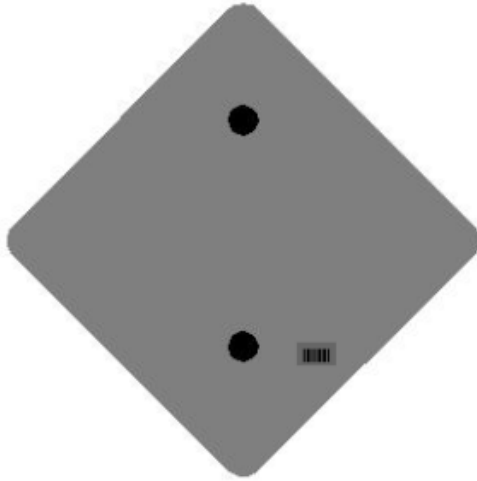



### One Sign Post

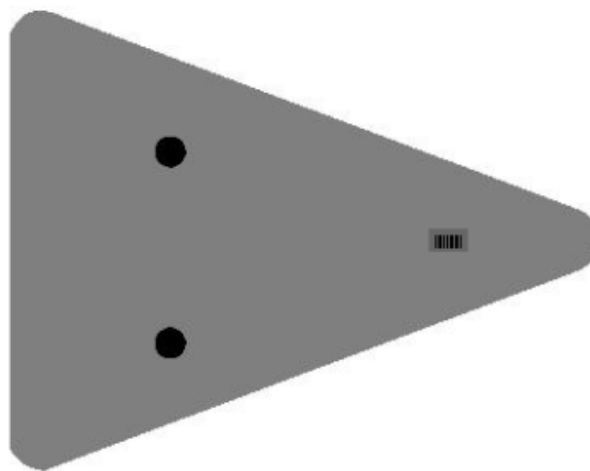
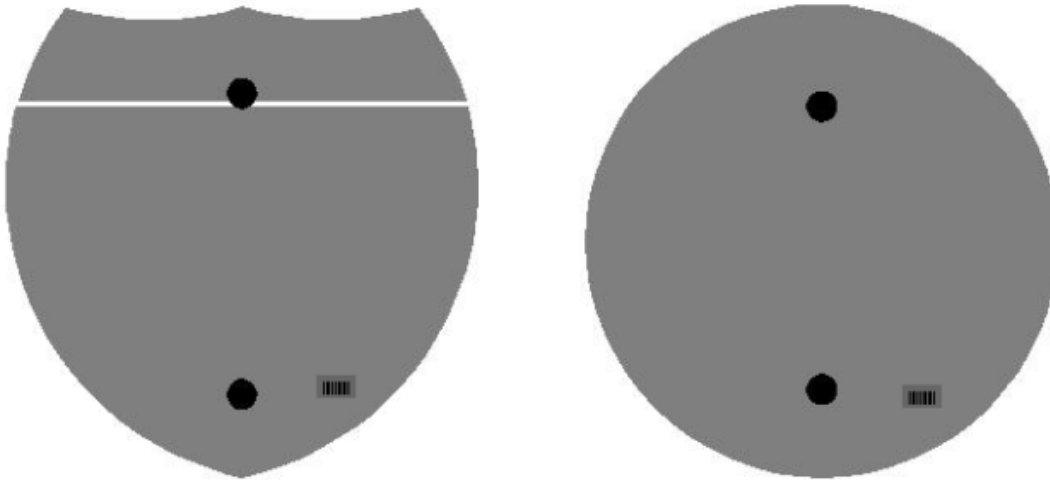

### Double Sign Post

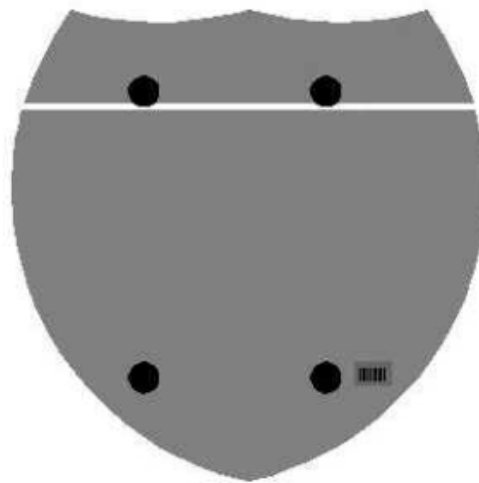

Interstate  
Shield

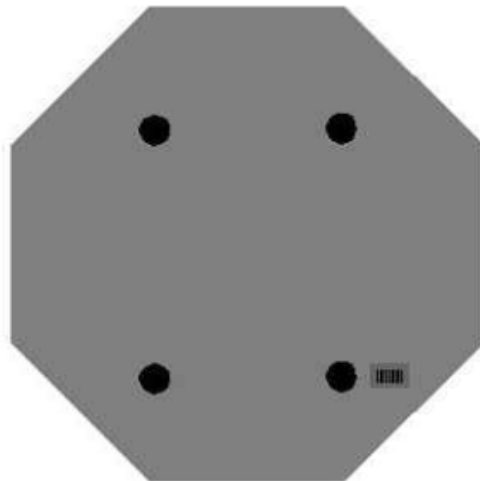

48" Stop

### 2 Post Signs



↑  
2" Wide Post

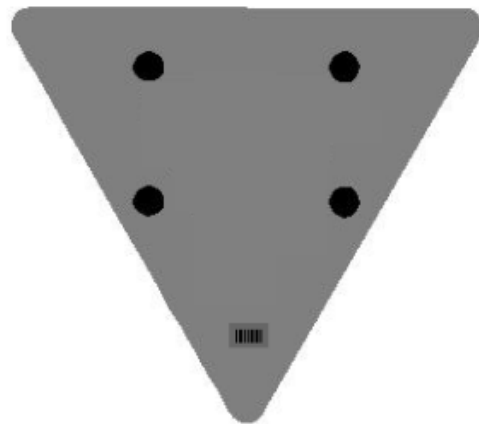

**SPECIAL NOTE FOR LONGITUDINAL PAVEMENT JOINT ADHESIVE**

1. DESCRIPTION. This specification covers the requirements and practices for applying an asphalt adhesive material to the longitudinal joint of the surface course of an asphalt pavement. Apply the adhesive to the face of longitudinal joint between driving lanes for the first lane paved. Then, place and compact the adjacent lane against the treated face to produce a strong, durable, waterproof longitudinal joint.
2. MATERIALS, EQUIPMENT, AND PERSONNEL.

2.1 Joint Adhesive. Provide material conforming to Subsection 2.1.1.

2.1.1 Provide an adhesive conforming to the following requirements:

Property	Specification	Test Procedure
Viscosity, 400 ° F (Pa·s)	4.0 – 10.0	ASTM D 4402
Cone Penetration, 77 ° F	60 – 100	ASTM D 5329
Flow, 140 ° F (mm)	5.0 max.	ASTM D 5329
Resilience, 77 ° F (%)	30 min.	ASTM D 5329
Ductility, 77 ° F (cm)	30.0 min.	ASTM D 113
Ductility, 39 ° F (cm)	30.0 min.	ASTM D 113
Tensile Adhesion, 77 ° F (%)	500 min.	ASTM D 5329, Type II
Softening Point, ° F	171 min.	AASHTO T 53
Asphalt Compatibility	Pass	ASTM D 5329

Ensure the temperature of the pavement joint adhesive is between 380 and 410 °F when the material is extruded in a 0.125-inch-thick band over the entire face of the longitudinal joint.

2.2. Equipment.

2.2.1 Melter Kettle. Provide an oil-jacketed, double-boiler, melter kettle equipped with any needed agitation and recirculating systems.

2.2.2 Applicator System. Provide a pressure-feed-wand applicator system with an applicator shoe attached.

2.3 Personnel. Ensure a technical representative from the manufacturer of the pavement joint adhesive is present during the initial construction activities and available upon the request of the Engineer.

3. CONSTRUCTION.

3.1 Surface Preparation. Prior to the application of the pavement joint adhesive, ensure the face of the longitudinal joint is thoroughly dry and free from dust or any other debris that would inhibit adhesion. Clean the joint face by the use of compressed air.

11N

Ensure this preparation process occurs shortly before application to prevent the return of debris on the joint face.

3.2 Pavement Joint Adhesive Application. Ensure the ambient temperature is a minimum of 40 ° F during the application of the pavement joint adhesive. Prior to applying the adhesive, demonstrate competence in applying the adhesive according to this note to the satisfaction of the Engineer. Heat the adhesive in the melter kettle to the specified temperature range. Pump the adhesive from the melter kettle through the wand onto the vertical face of the cold joint. Apply the adhesive in a continuous band over the entire face of the longitudinal joint. Do not use excessive material in either thickness or location. Ensure the edge of the extruded adhesive material is flush with the surface of the pavement. Then, place and compact the adjacent lane against the joint face. Remove any excessive material extruded from the joint after compaction (a small line of material may remain).

3.3 Pavement Joint Adhesive Certification. Furnish the joint adhesive's certification to the Engineer stating the material conforms to all requirements herein prior to use.

3.4 Sampling and Testing. The Department will require a random sample of pavement joint adhesive from each manufacturer's lot of material. Extrude two 5 lb. samples of the heated material and forward the sample to the Division of Materials for testing. Reynolds oven bags, turkey size, placed inside small cardboard boxes or cement cylinder molds have been found suitable. Ensure the product temperature is 400°F or below at the time of sampling.

4. MEASUREMENT. The Department will measure the quantity of Pavement Joint Adhesive in linear feet. The Department will not measure for payment any extra materials, labor, methods, equipment, or construction techniques used to satisfy the requirements of this note. The Department will not measure for payment any trial applications of Pavement Joint Adhesive, the cleaning of the joint face, or furnishing and placing the adhesive. The Department will consider all such items incidental to the Pavement Joint Adhesive.
5. PAYMENT. The Department will pay for the Pavement Joint Adhesive at the Contract unit bid price and apply an adjustment for each manufacturer's lot of material based on the degree of compliance as defined in the following schedule. When a sample fails on two or more tests, the Department may add the deductions, but the total deduction will not exceed 100 percent.

11N

Pavement Joint Adhesive Price Adjustment Schedule						
Test	Specification	100% Pay	90% Pay	80% Pay	50% Pay	0% Pay
Joint Adhesive Referenced in Subsection 2.1.1						
Viscosity, 400 ° F (Pa•s) ASTM D 3236	4.0-10.0	3.5-10.5	3.0-3.4 10.6-11.0	2.5-2.9 11.1-11.5	2.0-2.4 11.6-12.0	≤1.9 ≥ 12.1
Cone Penetration, 77 ° F ASTM D 5329	60-100	57-103	54-56 104-106	51-53 107-109	48-50 110-112	≤ 47 ≥ 113
Flow, 140 ° F (mm) ASTM D 5329	≤ 5.0	≤ 5.5	5.6-6.0	6.1-6.5	6.6-7.0	≥ 7.1
Resilience, 77 ° F (%) ASTM D 5329	≥ 30	≥ 28	26-27	24-25	22-23	≤ 21
Tensile Adhesion, 77 ° F (%) ASTM D 5329	≥ 500	≥ 490	480-489	470-479	460-469	≤ 459
Softening Point, ° F AASHTO T 53	≥ 171	≥ 169	166-168	163-165	160-162	≤ 159
Ductility, 77 ° F (cm) ASTM D 113	≥ 30.0	≥ 29.0	28.0-28.9	27.0-27.9	26.0-26.9	≤ 25.9
Ductility, 39 ° F (cm) ASTM D 113	≥ 30.0	≥ 29.0	28.0-28.9	27.0-27.9	26.0-26.9	≤ 25.9

Code  
20071EC

Pay Item  
Joint Adhesive

Pay Unit  
Linear Foot

May 7, 2014

## **PART III**

### **EMPLOYMENT, WAGE AND RECORD REQUIREMENTS**

FHWA-1273 -- Revised May 1, 2012

**REQUIRED CONTRACT PROVISIONS  
FEDERAL-AID CONSTRUCTION CONTRACTS**

- I. General
- II. Nondiscrimination
- III. Nonsegregated Facilities
- IV. Davis-Bacon and Related Act Provisions
- V. Contract Work Hours and Safety Standards Act Provisions
- VI. Subletting or Assigning the Contract
- VII. Safety: Accident Prevention
- VIII. False Statements Concerning Highway Projects
- IX. Implementation of Clean Air Act and Federal Water Pollution Control Act
- X. Compliance with Governmentwide Suspension and Debarment Requirements
- XI. Certification Regarding Use of Contract Funds for Lobbying

3. A breach of any of the stipulations contained in these Required Contract Provisions may be sufficient grounds for withholding of progress payments, withholding of final payment, termination of the contract, suspension / debarment or any other action determined to be appropriate by the contracting agency and FHWA.

4. Selection of Labor: During the performance of this contract, the contractor shall not use convict labor for any purpose within the limits of a construction project on a Federal-aid highway unless it is labor performed by convicts who are on parole, supervised release, or probation. The term Federal-aid highway does not include roadways functionally classified as local roads or rural minor collectors.

**ATTACHMENTS**

A. Employment and Materials Preference for Appalachian Development Highway System or Appalachian Local Access Road Contracts (included in Appalachian contracts only)

**II. NONDISCRIMINATION**

The provisions of this section related to 23 CFR Part 230 are applicable to all Federal-aid construction contracts and to all related construction subcontracts of \$10,000 or more. The provisions of 23 CFR Part 230 are not applicable to material supply, engineering, or architectural service contracts.

**I. GENERAL**

1. Form FHWA-1273 must be physically incorporated in each construction contract funded under Title 23 (excluding emergency contracts solely intended for debris removal). The contractor (or subcontractor) must insert this form in each subcontract and further require its inclusion in all lower tier subcontracts (excluding purchase orders, rental agreements and other agreements for supplies or services).

In addition, the contractor and all subcontractors must comply with the following policies: Executive Order 11246, 41 CFR 60, 29 CFR 1625-1627, Title 23 USC Section 140, the Rehabilitation Act of 1973, as amended (29 USC 794), Title VI of the Civil Rights Act of 1964, as amended, and related regulations including 49 CFR Parts 21, 26 and 27; and 23 CFR Parts 200, 230, and 633.

The applicable requirements of Form FHWA-1273 are incorporated by reference for work done under any purchase order, rental agreement or agreement for other services. The prime contractor shall be responsible for compliance by any subcontractor, lower-tier subcontractor or service provider.

The contractor and all subcontractors must comply with: the requirements of the Equal Opportunity Clause in 41 CFR 60-1.4(b) and, for all construction contracts exceeding \$10,000, the Standard Federal Equal Employment Opportunity Construction Contract Specifications in 41 CFR 60-4.3.

Form FHWA-1273 must be included in all Federal-aid design-build contracts, in all subcontracts and in lower tier subcontracts (excluding subcontracts for design services, purchase orders, rental agreements and other agreements for supplies or services). The design-builder shall be responsible for compliance by any subcontractor, lower-tier subcontractor or service provider.

Note: The U.S. Department of Labor has exclusive authority to determine compliance with Executive Order 11246 and the policies of the Secretary of Labor including 41 CFR 60, and 29 CFR 1625-1627. The contracting agency and the FHWA have the authority and the responsibility to ensure compliance with Title 23 USC Section 140, the Rehabilitation Act of 1973, as amended (29 USC 794), and Title VI of the Civil Rights Act of 1964, as amended, and related regulations including 49 CFR Parts 21, 26 and 27; and 23 CFR Parts 200, 230, and 633.

Contracting agencies may reference Form FHWA-1273 in bid proposal or request for proposal documents, however, the Form FHWA-1273 must be physically incorporated (not referenced) in all contracts, subcontracts and lower-tier subcontracts (excluding purchase orders, rental agreements and other agreements for supplies or services related to a construction contract).

The following provision is adopted from 23 CFR 230, Appendix A, with appropriate revisions to conform to the U.S. Department of Labor (US DOL) and FHWA requirements.

2. Subject to the applicability criteria noted in the following sections, these contract provisions shall apply to all work performed on the contract by the contractor's own organization and with the assistance of workers under the contractor's immediate superintendence and to all work performed on the contract by piecework, station work, or by subcontract.

**1. Equal Employment Opportunity:** Equal employment opportunity (EEO) requirements not to discriminate and to take affirmative action to assure equal opportunity as set forth under laws, executive orders, rules, regulations (28 CFR 35, 29 CFR 1630, 29 CFR 1625-1627, 41 CFR 60 and 49 CFR 27) and orders of the Secretary of Labor as modified by the provisions prescribed herein, and imposed pursuant to 23 U.S.C. 140 shall constitute the EEO and specific affirmative action standards for the contractor's project activities under



this contract. The provisions of the Americans with Disabilities Act of 1990 (42 U.S.C. 12101 et seq.) set forth under 28 CFR 35 and 29 CFR 1630 are incorporated by reference in this contract. In the execution of this contract, the contractor agrees to comply with the following minimum specific requirement activities of EEO:

a. The contractor will work with the contracting agency and the Federal Government to ensure that it has made every good faith effort to provide equal opportunity with respect to all of its terms and conditions of employment and in their review of activities under the contract.

b. The contractor will accept as its operating policy the following statement:

"It is the policy of this Company to assure that applicants are employed, and that employees are treated during employment, without regard to their race, religion, sex, color, national origin, age or disability. Such action shall include: employment, upgrading, demotion, or transfer; recruitment or recruitment advertising; layoff or termination; rates of pay or other forms of compensation; and selection for training, including apprenticeship, pre-apprenticeship, and/or on-the-job training."

**2. EEO Officer:** The contractor will designate and make known to the contracting officers an EEO Officer who will have the responsibility for and must be capable of effectively administering and promoting an active EEO program and who must be assigned adequate authority and responsibility to do so.

**3. Dissemination of Policy:** All members of the contractor's staff who are authorized to hire, supervise, promote, and discharge employees, or who recommend such action, or who are substantially involved in such action, will be made fully cognizant of, and will implement, the contractor's EEO policy and contractual responsibilities to provide EEO in each grade and classification of employment. To ensure that the above agreement will be met, the following actions will be taken as a minimum:

a. Periodic meetings of supervisory and personnel office employees will be conducted before the start of work and then not less often than once every six months, at which time the contractor's EEO policy and its implementation will be reviewed and explained. The meetings will be conducted by the EEO Officer.

b. All new supervisory or personnel office employees will be given a thorough indoctrination by the EEO Officer, covering all major aspects of the contractor's EEO obligations within thirty days following their reporting for duty with the contractor.

c. All personnel who are engaged in direct recruitment for the project will be instructed by the EEO Officer in the contractor's procedures for locating and hiring minorities and women.

d. Notices and posters setting forth the contractor's EEO policy will be placed in areas readily accessible to employees, applicants for employment and potential employees.

e. The contractor's EEO policy and the procedures to implement such policy will be brought to the attention of employees by means of meetings, employee handbooks, or other appropriate means.

**4. Recruitment:** When advertising for employees, the contractor will include in all advertisements for employees the notation: "An Equal Opportunity Employer." All such advertisements will be placed in publications having a large circulation among minorities and women in the area from which the project work force would normally be derived.

a. The contractor will, unless precluded by a valid bargaining agreement, conduct systematic and direct recruitment through public and private employee referral sources likely to yield qualified minorities and women. To meet this requirement, the contractor will identify sources of potential minority group employees, and establish with such identified sources procedures whereby minority and women applicants may be referred to the contractor for employment consideration.

b. In the event the contractor has a valid bargaining agreement providing for exclusive hiring hall referrals, the contractor is expected to observe the provisions of that agreement to the extent that the system meets the contractor's compliance with EEO contract provisions. Where implementation of such an agreement has the effect of discriminating against minorities or women, or obligates the contractor to do the same, such implementation violates Federal nondiscrimination provisions.

c. The contractor will encourage its present employees to refer minorities and women as applicants for employment. Information and procedures with regard to referring such applicants will be discussed with employees.

**5. Personnel Actions:** Wages, working conditions, and employee benefits shall be established and administered, and personnel actions of every type, including hiring, upgrading, promotion, transfer, demotion, layoff, and termination, shall be taken without regard to race, color, religion, sex, national origin, age or disability. The following procedures shall be followed:

a. The contractor will conduct periodic inspections of project sites to insure that working conditions and employee facilities do not indicate discriminatory treatment of project site personnel.

b. The contractor will periodically evaluate the spread of wages paid within each classification to determine any evidence of discriminatory wage practices.

c. The contractor will periodically review selected personnel actions in depth to determine whether there is evidence of discrimination. Where evidence is found, the contractor will promptly take corrective action. If the review indicates that the discrimination may extend beyond the actions reviewed, such corrective action shall include all affected persons.

d. The contractor will promptly investigate all complaints of alleged discrimination made to the contractor in connection with its obligations under this contract, will attempt to resolve such complaints, and will take appropriate corrective action within a reasonable time. If the investigation indicates that the discrimination may affect persons other than the complainant, such corrective action shall include such other persons. Upon completion of each investigation, the contractor will inform every complainant of all of their avenues of appeal.

**6. Training and Promotion:**

a. The contractor will assist in locating, qualifying, and increasing the skills of minorities and women who are

applicants for employment or current employees. Such efforts should be aimed at developing full journey level status employees in the type of trade or job classification involved.

b. Consistent with the contractor's work force requirements and as permissible under Federal and State regulations, the contractor shall make full use of training programs, i.e., apprenticeship, and on-the-job training programs for the geographical area of contract performance. In the event a special provision for training is provided under this contract, this subparagraph will be superseded as indicated in the special provision. The contracting agency may reserve training positions for persons who receive welfare assistance in accordance with 23 U.S.C. 140(a).

c. The contractor will advise employees and applicants for employment of available training programs and entrance requirements for each.

d. The contractor will periodically review the training and promotion potential of employees who are minorities and women and will encourage eligible employees to apply for such training and promotion.

**7. Unions:** If the contractor relies in whole or in part upon unions as a source of employees, the contractor will use good faith efforts to obtain the cooperation of such unions to increase opportunities for minorities and women. Actions by the contractor, either directly or through a contractor's association acting as agent, will include the procedures set forth below:

a. The contractor will use good faith efforts to develop, in cooperation with the unions, joint training programs aimed toward qualifying more minorities and women for membership in the unions and increasing the skills of minorities and women so that they may qualify for higher paying employment.

b. The contractor will use good faith efforts to incorporate an EEO clause into each union agreement to the end that such union will be contractually bound to refer applicants without regard to their race, color, religion, sex, national origin, age or disability.

c. The contractor is to obtain information as to the referral practices and policies of the labor union except that to the extent such information is within the exclusive possession of the labor union and such labor union refuses to furnish such information to the contractor, the contractor shall so certify to the contracting agency and shall set forth what efforts have been made to obtain such information.

d. In the event the union is unable to provide the contractor with a reasonable flow of referrals within the time limit set forth in the collective bargaining agreement, the contractor will, through independent recruitment efforts, fill the employment vacancies without regard to race, color, religion, sex, national origin, age or disability; making full efforts to obtain qualified and/or qualifiable minorities and women. The failure of a union to provide sufficient referrals (even though it is obligated to provide exclusive referrals under the terms of a collective bargaining agreement) does not relieve the contractor from the requirements of this paragraph. In the event the union referral practice prevents the contractor from meeting the obligations pursuant to Executive Order 11246, as amended, and these special provisions, such contractor shall immediately notify the contracting agency.

**8. Reasonable Accommodation for Applicants / Employees with Disabilities:** The contractor must be familiar

with the requirements for and comply with the Americans with Disabilities Act and all rules and regulations established there under. Employers must provide reasonable accommodation in all employment activities unless to do so would cause an undue hardship.

**9. Selection of Subcontractors, Procurement of Materials and Leasing of Equipment:** The contractor shall not discriminate on the grounds of race, color, religion, sex, national origin, age or disability in the selection and retention of subcontractors, including procurement of materials and leases of equipment. The contractor shall take all necessary and reasonable steps to ensure nondiscrimination in the administration of this contract.

a. The contractor shall notify all potential subcontractors and suppliers and lessors of their EEO obligations under this contract.

b. The contractor will use good faith efforts to ensure subcontractor compliance with their EEO obligations.

**10. Assurance Required by 49 CFR 26.13(b):**

a. The requirements of 49 CFR Part 26 and the State DOT's U.S. DOT-approved DBE program are incorporated by reference.

b. The contractor or subcontractor shall not discriminate on the basis of race, color, national origin, or sex in the performance of this contract. The contractor shall carry out applicable requirements of 49 CFR Part 26 in the award and administration of DOT-assisted contracts. Failure by the contractor to carry out these requirements is a material breach of this contract, which may result in the termination of this contract or such other remedy as the contracting agency deems appropriate.

**11. Records and Reports:** The contractor shall keep such records as necessary to document compliance with the EEO requirements. Such records shall be retained for a period of three years following the date of the final payment to the contractor for all contract work and shall be available at reasonable times and places for inspection by authorized representatives of the contracting agency and the FHWA.

a. The records kept by the contractor shall document the following:

(1) The number and work hours of minority and non-minority group members and women employed in each work classification on the project;

(2) The progress and efforts being made in cooperation with unions, when applicable, to increase employment opportunities for minorities and women; and

(3) The progress and efforts being made in locating, hiring, training, qualifying, and upgrading minorities and women;

b. The contractors and subcontractors will submit an annual report to the contracting agency each July for the duration of the project, indicating the number of minority, women, and non-minority group employees currently engaged in each work classification required by the contract work. This information is to be reported on [Form FHWA-1391](#). The staffing data should represent the project work force on board in all or any part of the last payroll period preceding the end of July. If on-the-job training is being required by special provision, the contractor

will be required to collect and report training data. The employment data should reflect the work force on board during all or any part of the last payroll period preceding the end of July.

**III. NONSEGREGATED FACILITIES**

This provision is applicable to all Federal-aid construction contracts and to all related construction subcontracts of \$10,000 or more.

The contractor must ensure that facilities provided for employees are provided in such a manner that segregation on the basis of race, color, religion, sex, or national origin cannot result. The contractor may neither require such segregated use by written or oral policies nor tolerate such use by employee custom. The contractor's obligation extends further to ensure that its employees are not assigned to perform their services at any location, under the contractor's control, where the facilities are segregated. The term "facilities" includes waiting rooms, work areas, restaurants and other eating areas, time clocks, restrooms, washrooms, locker rooms, and other storage or dressing areas, parking lots, drinking fountains, recreation or entertainment areas, transportation, and housing provided for employees. The contractor shall provide separate or single-user restrooms and necessary dressing or sleeping areas to assure privacy between sexes.

**IV. DAVIS-BACON AND RELATED ACT PROVISIONS**

This section is applicable to all Federal-aid construction projects exceeding \$2,000 and to all related subcontracts and lower-tier subcontracts (regardless of subcontract size). The requirements apply to all projects located within the right-of-way of a roadway that is functionally classified as Federal-aid highway. This excludes roadways functionally classified as local roads or rural minor collectors, which are exempt. Contracting agencies may elect to apply these requirements to other projects.

The following provisions are from the U.S. Department of Labor regulations in 29 CFR 5.5 "Contract provisions and related matters" with minor revisions to conform to the FHWA-1273 format and FHWA program requirements.

**1. Minimum wages**

a. All laborers and mechanics employed or working upon the site of the work, will be paid unconditionally and not less often than once a week, and without subsequent deduction or rebate on any account (except such payroll deductions as are permitted by regulations issued by the Secretary of Labor under the Copeland Act (29 CFR part 3)), the full amount of wages and bona fide fringe benefits (or cash equivalents thereof) due at time of payment computed at rates not less than those contained in the wage determination of the Secretary of Labor which is attached hereto and made a part hereof, regardless of any contractual relationship which may be alleged to exist between the contractor and such laborers and mechanics.

Contributions made or costs reasonably anticipated for bona fide fringe benefits under section 1(b)(2) of the Davis-Bacon Act on behalf of laborers or mechanics are considered wages paid to such laborers or mechanics, subject to the provisions

of paragraph 1.d. of this section; also, regular contributions made or costs incurred for more than a weekly period (but not less often than quarterly) under plans, funds, or programs which cover the particular weekly period, are deemed to be constructively made or incurred during such weekly period. Such laborers and mechanics shall be paid the appropriate wage rate and fringe benefits on the wage determination for the classification of work actually performed, without regard to skill, except as provided in 29 CFR 5.5(a)(4). Laborers or mechanics performing work in more than one classification may be compensated at the rate specified for each classification for the time actually worked therein: Provided, That the employer's payroll records accurately set forth the time spent in each classification in which work is performed. The wage determination (including any additional classification and wage rates conformed under paragraph 1.b. of this section) and the Davis-Bacon poster (WH-1321) shall be posted at all times by the contractor and its subcontractors at the site of the work in a prominent and accessible place where it can be easily seen by the workers.

b.(1) The contracting officer shall require that any class of laborers or mechanics, including helpers, which is not listed in the wage determination and which is to be employed under the contract shall be classified in conformance with the wage determination. The contracting officer shall approve an additional classification and wage rate and fringe benefits therefore only when the following criteria have been met:

- (i) The work to be performed by the classification requested is not performed by a classification in the wage determination; and
- (ii) The classification is utilized in the area by the construction industry; and
- (iii) The proposed wage rate, including any bona fide fringe benefits, bears a reasonable relationship to the wage rates contained in the wage determination.

(2) If the contractor and the laborers and mechanics to be employed in the classification (if known), or their representatives, and the contracting officer agree on the classification and wage rate (including the amount designated for fringe benefits where appropriate), a report of the action taken shall be sent by the contracting officer to the Administrator of the Wage and Hour Division, Employment Standards Administration, U.S. Department of Labor, Washington, DC 20210. The Administrator, or an authorized representative, will approve, modify, or disapprove every additional classification action within 30 days of receipt and so advise the contracting officer or will notify the contracting officer within the 30-day period that additional time is necessary.

(3) In the event the contractor, the laborers or mechanics to be employed in the classification or their representatives, and the contracting officer do not agree on the proposed classification and wage rate (including the amount designated for fringe benefits, where appropriate), the contracting officer shall refer the questions, including the views of all interested parties and the recommendation of the contracting officer, to the Wage and Hour Administrator for determination. The Wage and Hour Administrator, or an authorized representative, will issue a determination within 30 days of receipt and so advise the contracting officer or

will notify the contracting officer within the 30-day period that additional time is necessary.

(4) The wage rate (including fringe benefits where appropriate) determined pursuant to paragraphs 1.b.(2) or 1.b.(3) of this section, shall be paid to all workers performing work in the classification under this contract from the first day on which work is performed in the classification.

c. Whenever the minimum wage rate prescribed in the contract for a class of laborers or mechanics includes a fringe benefit which is not expressed as an hourly rate, the contractor shall either pay the benefit as stated in the wage determination or shall pay another bona fide fringe benefit or an hourly cash equivalent thereof.

d. If the contractor does not make payments to a trustee or other third person, the contractor may consider as part of the wages of any laborer or mechanic the amount of any costs reasonably anticipated in providing bona fide fringe benefits under a plan or program. Provided, That the Secretary of Labor has found, upon the written request of the contractor, that the applicable standards of the Davis-Bacon Act have been met. The Secretary of Labor may require the contractor to set aside in a separate account assets for the meeting of obligations under the plan or program.

## 2. Withholding

The contracting agency shall upon its own action or upon written request of an authorized representative of the Department of Labor, withhold or cause to be withheld from the contractor under this contract, or any other Federal contract with the same prime contractor, or any other federally-assisted contract subject to Davis-Bacon prevailing wage requirements, which is held by the same prime contractor, so much of the accrued payments or advances as may be considered necessary to pay laborers and mechanics, including apprentices, trainees, and helpers, employed by the contractor or any subcontractor the full amount of wages required by the contract. In the event of failure to pay any laborer or mechanic, including any apprentice, trainee, or helper, employed or working on the site of the work, all or part of the wages required by the contract, the contracting agency may, after written notice to the contractor, take such action as may be necessary to cause the suspension of any further payment, advance, or guarantee of funds until such violations have ceased.

## 3. Payrolls and basic records

a. Payrolls and basic records relating thereto shall be maintained by the contractor during the course of the work and preserved for a period of three years thereafter for all laborers and mechanics working at the site of the work. Such records shall contain the name, address, and social security number of each such worker, his or her correct classification, hourly rates of wages paid (including rates of contributions or costs anticipated for bona fide fringe benefits or cash equivalents thereof of the types described in section 1(b)(2)(B) of the Davis-Bacon Act), daily and weekly number of hours worked, deductions made and actual wages paid. Whenever the Secretary of Labor has found under 29 CFR 5.5(a)(1)(iv) that the wages of any laborer or mechanic include the amount of any costs reasonably anticipated in providing benefits under a plan or program described in section 1(b)(2)(B) of the Davis-

Bacon Act, the contractor shall maintain records which show that the commitment to provide such benefits is enforceable, that the plan or program is financially responsible, and that the plan or program has been communicated in writing to the laborers or mechanics affected, and records which show the costs anticipated or the actual cost incurred in providing such benefits. Contractors employing apprentices or trainees under approved programs shall maintain written evidence of the registration of apprenticeship programs and certification of trainee programs, the registration of the apprentices and trainees, and the ratios and wage rates prescribed in the applicable programs.

b.(1) The contractor shall submit weekly for each week in which any contract work is performed a copy of all payrolls to the contracting agency. The payrolls submitted shall set out accurately and completely all of the information required to be maintained under 29 CFR 5.5(a)(3)(i), except that full social security numbers and home addresses shall not be included on weekly transmittals. Instead the payrolls shall only need to include an individually identifying number for each employee (e.g., the last four digits of the employee's social security number). The required weekly payroll information may be submitted in any form desired. Optional Form WH-347 is available for this purpose from the Wage and Hour Division Web site at <http://www.dol.gov/esa/whd/forms/wh347instr.htm> or its successor site. The prime contractor is responsible for the submission of copies of payrolls by all subcontractors. Contractors and subcontractors shall maintain the full social security number and current address of each covered worker, and shall provide them upon request to the contracting agency for transmission to the State DOT, the FHWA or the Wage and Hour Division of the Department of Labor for purposes of an investigation or audit of compliance with prevailing wage requirements. It is not a violation of this section for a prime contractor to require a subcontractor to provide addresses and social security numbers to the prime contractor for its own records, without weekly submission to the contracting agency..

(2) Each payroll submitted shall be accompanied by a "Statement of Compliance," signed by the contractor or subcontractor or his or her agent who pays or supervises the payment of the persons employed under the contract and shall certify the following:

(i) That the payroll for the payroll period contains the information required to be provided under §5.5 (a)(3)(ii) of Regulations, 29 CFR part 5, the appropriate information is being maintained under §5.5 (a)(3)(i) of Regulations, 29 CFR part 5, and that such information is correct and complete;

(ii) That each laborer or mechanic (including each helper, apprentice, and trainee) employed on the contract during the payroll period has been paid the full weekly wages earned, without rebate, either directly or indirectly, and that no deductions have been made either directly or indirectly from the full wages earned, other than permissible deductions as set forth in Regulations, 29 CFR part 3;

(iii) That each laborer or mechanic has been paid not less than the applicable wage rates and fringe benefits or cash equivalents for the classification of work performed, as specified in the applicable wage determination incorporated into the contract.

(3) The weekly submission of a properly executed certification set forth on the reverse side of Optional Form WH-347 shall satisfy the requirement for submission of the "Statement of Compliance" required by paragraph 3.b.(2) of this section.

(4) The falsification of any of the above certifications may subject the contractor or subcontractor to civil or criminal prosecution under section 1001 of title 18 and section 231 of title 31 of the United States Code.

c. The contractor or subcontractor shall make the records required under paragraph 3.a. of this section available for inspection, copying, or transcription by authorized representatives of the contracting agency, the State DOT, the FHWA, or the Department of Labor, and shall permit such representatives to interview employees during working hours on the job. If the contractor or subcontractor fails to submit the required records or to make them available, the FHWA may, after written notice to the contractor, the contracting agency or the State DOT, take such action as may be necessary to cause the suspension of any further payment, advance, or guarantee of funds. Furthermore, failure to submit the required records upon request or to make such records available may be grounds for debarment action pursuant to 29 CFR 5.12.

#### 4. Apprentices and trainees

##### a. Apprentices (programs of the USDOL).

Apprentices will be permitted to work at less than the predetermined rate for the work they performed when they are employed pursuant to and individually registered in a bona fide apprenticeship program registered with the U.S. Department of Labor, Employment and Training Administration, Office of Apprenticeship Training, Employer and Labor Services, or with a State Apprenticeship Agency recognized by the Office, or if a person is employed in his or her first 90 days of probationary employment as an apprentice in such an apprenticeship program, who is not individually registered in the program, but who has been certified by the Office of Apprenticeship Training, Employer and Labor Services or a State Apprenticeship Agency (where appropriate) to be eligible for probationary employment as an apprentice.

The allowable ratio of apprentices to journeymen on the job site in any craft classification shall not be greater than the ratio permitted to the contractor as to the entire work force under the registered program. Any worker listed on a payroll at an apprentice wage rate, who is not registered or otherwise employed as stated above, shall be paid not less than the applicable wage rate on the wage determination for the classification of work actually performed. In addition, any apprentice performing work on the job site in excess of the ratio permitted under the registered program shall be paid not less than the applicable wage rate on the wage determination for the work actually performed. Where a contractor is performing construction on a project in a locality other than that in which its program is registered, the ratios and wage rates (expressed in percentages of the journeyman's hourly rate) specified in the contractor's or subcontractor's registered program shall be observed.

Every apprentice must be paid at not less than the rate specified in the registered program for the apprentice's level of progress, expressed as a percentage of the journeymen hourly

rate specified in the applicable wage determination. Apprentices shall be paid fringe benefits in accordance with the provisions of the apprenticeship program. If the apprenticeship program does not specify fringe benefits, apprentices must be paid the full amount of fringe benefits listed on the wage determination for the applicable classification. If the Administrator determines that a different practice prevails for the applicable apprentice classification, fringes shall be paid in accordance with that determination.

In the event the Office of Apprenticeship Training, Employer and Labor Services, or a State Apprenticeship Agency recognized by the Office, withdraws approval of an apprenticeship program, the contractor will no longer be permitted to utilize apprentices at less than the applicable predetermined rate for the work performed until an acceptable program is approved.

##### b. Trainees (programs of the USDOL).

Except as provided in 29 CFR 5.16, trainees will not be permitted to work at less than the predetermined rate for the work performed unless they are employed pursuant to and individually registered in a program which has received prior approval, evidenced by formal certification by the U.S. Department of Labor, Employment and Training Administration.

The ratio of trainees to journeymen on the job site shall not be greater than permitted under the plan approved by the Employment and Training Administration.

Every trainee must be paid at not less than the rate specified in the approved program for the trainee's level of progress, expressed as a percentage of the journeyman hourly rate specified in the applicable wage determination. Trainees shall be paid fringe benefits in accordance with the provisions of the trainee program. If the trainee program does not mention fringe benefits, trainees shall be paid the full amount of fringe benefits listed on the wage determination unless the Administrator of the Wage and Hour Division determines that there is an apprenticeship program associated with the corresponding journeyman wage rate on the wage determination which provides for less than full fringe benefits for apprentices. Any employee listed on the payroll at a trainee rate who is not registered and participating in a training plan approved by the Employment and Training Administration shall be paid not less than the applicable wage rate on the wage determination for the classification of work actually performed. In addition, any trainee performing work on the job site in excess of the ratio permitted under the registered program shall be paid not less than the applicable wage rate on the wage determination for the work actually performed.

In the event the Employment and Training Administration withdraws approval of a training program, the contractor will no longer be permitted to utilize trainees at less than the applicable predetermined rate for the work performed until an acceptable program is approved.

c. Equal employment opportunity. The utilization of apprentices, trainees and journeymen under this part shall be in conformity with the equal employment opportunity requirements of Executive Order 11246, as amended, and 29 CFR part 30.

d. Apprentices and Trainees (programs of the U.S. DOT).

Apprentices and trainees working under apprenticeship and skill training programs which have been certified by the Secretary of Transportation as promoting EEO in connection with Federal-aid highway construction programs are not subject to the requirements of paragraph 4 of this Section IV. The straight time hourly wage rates for apprentices and trainees under such programs will be established by the particular programs. The ratio of apprentices and trainees to journeymen shall not be greater than permitted by the terms of the particular program.

**5. Compliance with Copeland Act requirements.** The contractor shall comply with the requirements of 29 CFR part 3, which are incorporated by reference in this contract.

**6. Subcontracts.** The contractor or subcontractor shall insert Form FHWA-1273 in any subcontracts and also require the subcontractors to include Form FHWA-1273 in any lower tier subcontracts. The prime contractor shall be responsible for the compliance by any subcontractor or lower tier subcontractor with all the contract clauses in 29 CFR 5.5.

**7. Contract termination: debarment.** A breach of the contract clauses in 29 CFR 5.5 may be grounds for termination of the contract, and for debarment as a contractor and a subcontractor as provided in 29 CFR 5.12.

**8. Compliance with Davis-Bacon and Related Act requirements.** All rulings and interpretations of the Davis-Bacon and Related Acts contained in 29 CFR parts 1, 3, and 5 are herein incorporated by reference in this contract.

**9. Disputes concerning labor standards.** Disputes arising out of the labor standards provisions of this contract shall not be subject to the general disputes clause of this contract. Such disputes shall be resolved in accordance with the procedures of the Department of Labor set forth in 29 CFR parts 5, 6, and 7. Disputes within the meaning of this clause include disputes between the contractor (or any of its subcontractors) and the contracting agency, the U.S. Department of Labor, or the employees or their representatives.

**10. Certification of eligibility.**

a. By entering into this contract, the contractor certifies that neither it (nor he or she) nor any person or firm who has an interest in the contractor's firm is a person or firm ineligible to be awarded Government contracts by virtue of section 3(a) of the Davis-Bacon Act or 29 CFR 5.12(a)(1).

b. No part of this contract shall be subcontracted to any person or firm ineligible for award of a Government contract by virtue of section 3(a) of the Davis-Bacon Act or 29 CFR 5.12(a)(1).

c. The penalty for making false statements is prescribed in the U.S. Criminal Code, 18 U.S.C. 1001.

**V. CONTRACT WORK HOURS AND SAFETY STANDARDS ACT**

The following clauses apply to any Federal-aid construction contract in an amount in excess of \$100,000 and subject to the overtime provisions of the Contract Work Hours and Safety Standards Act. These clauses shall be inserted in addition to the clauses required by 29 CFR 5.5(a) or 29 CFR 4.6. As used in this paragraph, the terms laborers and mechanics include watchmen and guards.

**1. Overtime requirements.** No contractor or subcontractor contracting for any part of the contract work which may require or involve the employment of laborers or mechanics shall require or permit any such laborer or mechanic in any workweek in which he or she is employed on such work to work in excess of forty hours in such workweek unless such laborer or mechanic receives compensation at a rate not less than one and one-half times the basic rate of pay for all hours worked in excess of forty hours in such workweek.

**2. Violation; liability for unpaid wages; liquidated damages.** In the event of any violation of the clause set forth in paragraph (1.) of this section, the contractor and any subcontractor responsible therefor shall be liable for the unpaid wages. In addition, such contractor and subcontractor shall be liable to the United States (in the case of work done under contract for the District of Columbia or a territory, to such District or to such territory), for liquidated damages. Such liquidated damages shall be computed with respect to each individual laborer or mechanic, including watchmen and guards, employed in violation of the clause set forth in paragraph (1.) of this section, in the sum of \$10 for each calendar day on which such individual was required or permitted to work in excess of the standard workweek of forty hours without payment of the overtime wages required by the clause set forth in paragraph (1.) of this section.

**3. Withholding for unpaid wages and liquidated damages.** The FHWA or the contracting agency shall upon its own action or upon written request of an authorized representative of the Department of Labor withhold or cause to be withheld, from any moneys payable on account of work performed by the contractor or subcontractor under any such contract or any other Federal contract with the same prime contractor, or any other federally-assisted contract subject to the Contract Work Hours and Safety Standards Act, which is held by the same prime contractor, such sums as may be determined to be necessary to satisfy any liabilities of such contractor or subcontractor for unpaid wages and liquidated damages as provided in the clause set forth in paragraph (2.) of this section.

**4. Subcontracts.** The contractor or subcontractor shall insert in any subcontracts the clauses set forth in paragraph (1.) through (4.) of this section and also a clause requiring the subcontractors to include these clauses in any lower tier subcontracts. The prime contractor shall be responsible for compliance by any subcontractor or lower tier subcontractor with the clauses set forth in paragraphs (1.) through (4.) of this section.

## VI. SUBLETTING OR ASSIGNING THE CONTRACT

This provision is applicable to all Federal-aid construction contracts on the National Highway System.

1. The contractor shall perform with its own organization contract work amounting to not less than 30 percent (or a greater percentage if specified elsewhere in the contract) of the total original contract price, excluding any specialty items designated by the contracting agency. Specialty items may be performed by subcontract and the amount of any such specialty items performed may be deducted from the total original contract price before computing the amount of work required to be performed by the contractor's own organization (23 CFR 635.116).

a. The term "perform work with its own organization" refers to workers employed or leased by the prime contractor, and equipment owned or rented by the prime contractor, with or without operators. Such term does not include employees or equipment of a subcontractor or lower tier subcontractor, agents of the prime contractor, or any other assignees. The term may include payments for the costs of hiring leased employees from an employee leasing firm meeting all relevant Federal and State regulatory requirements. Leased employees may only be included in this term if the prime contractor meets all of the following conditions:

(1) the prime contractor maintains control over the supervision of the day-to-day activities of the leased employees;

(2) the prime contractor remains responsible for the quality of the work of the leased employees;

(3) the prime contractor retains all power to accept or exclude individual employees from work on the project; and

(4) the prime contractor remains ultimately responsible for the payment of predetermined minimum wages, the submission of payrolls, statements of compliance and all other Federal regulatory requirements.

b. "Specialty Items" shall be construed to be limited to work that requires highly specialized knowledge, abilities, or equipment not ordinarily available in the type of contracting organizations qualified and expected to bid or propose on the contract as a whole and in general are to be limited to minor components of the overall contract.

2. The contract amount upon which the requirements set forth in paragraph (1) of Section VI is computed includes the cost of material and manufactured products which are to be purchased or produced by the contractor under the contract provisions.

3. The contractor shall furnish (a) a competent superintendent or supervisor who is employed by the firm, has full authority to direct performance of the work in accordance with the contract requirements, and is in charge of all construction operations (regardless of who performs the work) and (b) such other of its own organizational resources (supervision, management, and engineering services) as the contracting officer determines is necessary to assure the performance of the contract.

4. No portion of the contract shall be sublet, assigned or otherwise disposed of except with the written consent of the contracting officer, or authorized representative, and such consent when given shall not be construed to relieve the contractor of any responsibility for the fulfillment of the contract. Written consent will be given only after the contracting agency has assured that each subcontract is

evidenced in writing and that it contains all pertinent provisions and requirements of the prime contract.

5. The 30% self-performance requirement of paragraph (1) is not applicable to design-build contracts; however, contracting agencies may establish their own self-performance requirements.

## VII. SAFETY: ACCIDENT PREVENTION

This provision is applicable to all Federal-aid construction contracts and to all related subcontracts.

1. In the performance of this contract the contractor shall comply with all applicable Federal, State, and local laws governing safety, health, and sanitation (23 CFR 635). The contractor shall provide all safeguards, safety devices and protective equipment and take any other needed actions as it determines, or as the contracting officer may determine, to be reasonably necessary to protect the life and health of employees on the job and the safety of the public and to protect property in connection with the performance of the work covered by the contract.

2. It is a condition of this contract, and shall be made a condition of each subcontract, which the contractor enters into pursuant to this contract, that the contractor and any subcontractor shall not permit any employee, in performance of the contract, to work in surroundings or under conditions which are unsanitary, hazardous or dangerous to his/her health or safety, as determined under construction safety and health standards (29 CFR 1926) promulgated by the Secretary of Labor, in accordance with Section 107 of the Contract Work Hours and Safety Standards Act (40 U.S.C. 3704).

3. Pursuant to 29 CFR 1926.3, it is a condition of this contract that the Secretary of Labor or authorized representative thereof, shall have right of entry to any site of contract performance to inspect or investigate the matter of compliance with the construction safety and health standards and to carry out the duties of the Secretary under Section 107 of the Contract Work Hours and Safety Standards Act (40 U.S.C.3704).

## VIII. FALSE STATEMENTS CONCERNING HIGHWAY PROJECTS

This provision is applicable to all Federal-aid construction contracts and to all related subcontracts.

In order to assure high quality and durable construction in conformity with approved plans and specifications and a high degree of reliability on statements and representations made by engineers, contractors, suppliers, and workers on Federal-aid highway projects, it is essential that all persons concerned with the project perform their functions as carefully, thoroughly, and honestly as possible. Willful falsification, distortion, or misrepresentation with respect to any facts related to the project is a violation of Federal law. To prevent any misunderstanding regarding the seriousness of these and similar acts, Form FHWA-1022 shall be posted on each Federal-aid highway project (23 CFR 635) in one or more places where it is readily available to all persons concerned with the project:

18 U.S.C. 1020 reads as follows:

"Whoever, being an officer, agent, or employee of the United States, or of any State or Territory, or whoever, whether a person, association, firm, or corporation, knowingly makes any false statement, false representation, or false report as to the character, quality, quantity, or cost of the material used or to be used, or the quantity or quality of the work performed or to be performed, or the cost thereof in connection with the submission of plans, maps, specifications, contracts, or costs of construction on any highway or related project submitted for approval to the Secretary of Transportation; or

Whoever knowingly makes any false statement, false representation, false report or false claim with respect to the character, quality, quantity, or cost of any work performed or to be performed, or materials furnished or to be furnished, in connection with the construction of any highway or related project approved by the Secretary of Transportation; or

Whoever knowingly makes any false statement or false representation as to material fact in any statement, certificate, or report submitted pursuant to provisions of the Federal-aid Roads Act approved July 1, 1916, (39 Stat. 355), as amended and supplemented;

Shall be fined under this title or imprisoned not more than 5 years or both."

#### **IX. IMPLEMENTATION OF CLEAN AIR ACT AND FEDERAL WATER POLLUTION CONTROL ACT**

This provision is applicable to all Federal-aid construction contracts and to all related subcontracts.

By submission of this bid/proposal or the execution of this contract, or subcontract, as appropriate, the bidder, proposer, Federal-aid construction contractor, or subcontractor, as appropriate, will be deemed to have stipulated as follows:

1. That any person who is or will be utilized in the performance of this contract is not prohibited from receiving an award due to a violation of Section 508 of the Clean Water Act or Section 306 of the Clean Air Act.

2. That the contractor agrees to include or cause to be included the requirements of paragraph (1) of this Section X in every subcontract, and further agrees to take such action as the contracting agency may direct as a means of enforcing such requirements.

#### **X. CERTIFICATION REGARDING DEBARMENT, SUSPENSION, INELIGIBILITY AND VOLUNTARY EXCLUSION**

This provision is applicable to all Federal-aid construction contracts, design-build contracts, subcontracts, lower-tier subcontracts, purchase orders, lease agreements, consultant contracts or any other covered transaction requiring FHWA approval or that is estimated to cost \$25,000 or more – as defined in 2 CFR Parts 180 and 1200.

##### **1. Instructions for Certification – First Tier Participants:**

a. By signing and submitting this proposal, the prospective first tier participant is providing the certification set out below.

b. The inability of a person to provide the certification set out below will not necessarily result in denial of participation in this

covered transaction. The prospective first tier participant shall submit an explanation of why it cannot provide the certification set out below. The certification or explanation will be considered in connection with the department or agency's determination whether to enter into this transaction. However, failure of the prospective first tier participant to furnish a certification or an explanation shall disqualify such a person from participation in this transaction.

c. The certification in this clause is a material representation of fact upon which reliance was placed when the contracting agency determined to enter into this transaction. If it is later determined that the prospective participant knowingly rendered an erroneous certification, in addition to other remedies available to the Federal Government, the contracting agency may terminate this transaction for cause of default.

d. The prospective first tier participant shall provide immediate written notice to the contracting agency to whom this proposal is submitted if any time the prospective first tier participant learns that its certification was erroneous when submitted or has become erroneous by reason of changed circumstances.

e. The terms "covered transaction," "debarred," "suspended," "ineligible," "participant," "person," "principal," and "voluntarily excluded," as used in this clause, are defined in 2 CFR Parts 180 and 1200. "First Tier Covered Transactions" refers to any covered transaction between a grantee or subgrantee of Federal funds and a participant (such as the prime or general contract). "Lower Tier Covered Transactions" refers to any covered transaction under a First Tier Covered Transaction (such as subcontracts). "First Tier Participant" refers to the participant who has entered into a covered transaction with a grantee or subgrantee of Federal funds (such as the prime or general contractor). "Lower Tier Participant" refers any participant who has entered into a covered transaction with a First Tier Participant or other Lower Tier Participants (such as subcontractors and suppliers).

f. The prospective first tier participant agrees by submitting this proposal that, should the proposed covered transaction be entered into, it shall not knowingly enter into any lower tier covered transaction with a person who is debarred, suspended, declared ineligible, or voluntarily excluded from participation in this covered transaction, unless authorized by the department or agency entering into this transaction.

g. The prospective first tier participant further agrees by submitting this proposal that it will include the clause titled "Certification Regarding Debarment, Suspension, Ineligibility and Voluntary Exclusion-Lower Tier Covered Transactions," provided by the department or contracting agency, entering into this covered transaction, without modification, in all lower tier covered transactions and in all solicitations for lower tier covered transactions exceeding the \$25,000 threshold.

h. A participant in a covered transaction may rely upon a certification of a prospective participant in a lower tier covered transaction that is not debarred, suspended, ineligible, or voluntarily excluded from the covered transaction, unless it knows that the certification is erroneous. A participant is responsible for ensuring that its principals are not suspended, debarred, or otherwise ineligible to participate in covered transactions. To verify the eligibility of its principals, as well as the eligibility of any lower tier prospective participants, each participant may, but is not required to, check the Excluded Parties List System website (<https://www.epls.gov/>), which is compiled by the General Services Administration.



i. Nothing contained in the foregoing shall be construed to require the establishment of a system of records in order to render in good faith the certification required by this clause. The knowledge and information of the prospective participant is not required to exceed that which is normally possessed by a prudent person in the ordinary course of business dealings.

j. Except for transactions authorized under paragraph (f) of these instructions, if a participant in a covered transaction knowingly enters into a lower tier covered transaction with a person who is suspended, debarred, ineligible, or voluntarily excluded from participation in this transaction, in addition to other remedies available to the Federal Government, the department or agency may terminate this transaction for cause or default.

\*\*\*\*\*

**2. Certification Regarding Debarment, Suspension, Ineligibility and Voluntary Exclusion – First Tier Participants:**

a. The prospective first tier participant certifies to the best of its knowledge and belief, that it and its principals:

(1) Are not presently debarred, suspended, proposed for debarment, declared ineligible, or voluntarily excluded from participating in covered transactions by any Federal department or agency;

(2) Have not within a three-year period preceding this proposal been convicted of or had a civil judgment rendered against them for commission of fraud or a criminal offense in connection with obtaining, attempting to obtain, or performing a public (Federal, State or local) transaction or contract under a public transaction; violation of Federal or State antitrust statutes or commission of embezzlement, theft, forgery, bribery, falsification or destruction of records, making false statements, or receiving stolen property;

(3) Are not presently indicted for or otherwise criminally or civilly charged by a governmental entity (Federal, State or local) with commission of any of the offenses enumerated in paragraph (a)(2) of this certification; and

(4) Have not within a three-year period preceding this application/proposal had one or more public transactions (Federal, State or local) terminated for cause or default.

b. Where the prospective participant is unable to certify to any of the statements in this certification, such prospective participant shall attach an explanation to this proposal.

**2. Instructions for Certification - Lower Tier Participants:**

(Applicable to all subcontracts, purchase orders and other lower tier transactions requiring prior FHWA approval or estimated to cost \$25,000 or more - 2 CFR Parts 180 and 1200)

a. By signing and submitting this proposal, the prospective lower tier is providing the certification set out below.

b. The certification in this clause is a material representation of fact upon which reliance was placed when this transaction was entered into. If it is later determined that the prospective lower tier participant knowingly rendered an erroneous certification, in addition to other remedies available to the Federal Government, the department, or agency with which

this transaction originated may pursue available remedies, including suspension and/or debarment.

c. The prospective lower tier participant shall provide immediate written notice to the person to which this proposal is submitted if at any time the prospective lower tier participant learns that its certification was erroneous by reason of changed circumstances.

d. The terms "covered transaction," "debarred," "suspended," "ineligible," "participant," "person," "principal," and "voluntarily excluded," as used in this clause, are defined in 2 CFR Parts 180 and 1200. You may contact the person to which this proposal is submitted for assistance in obtaining a copy of those regulations. "First Tier Covered Transactions" refers to any covered transaction between a grantee or subgrantee of Federal funds and a participant (such as the prime or general contract). "Lower Tier Covered Transactions" refers to any covered transaction under a First Tier Covered Transaction (such as subcontracts). "First Tier Participant" refers to the participant who has entered into a covered transaction with a grantee or subgrantee of Federal funds (such as the prime or general contractor). "Lower Tier Participant" refers any participant who has entered into a covered transaction with a First Tier Participant or other Lower Tier Participants (such as subcontractors and suppliers).

e. The prospective lower tier participant agrees by submitting this proposal that, should the proposed covered transaction be entered into, it shall not knowingly enter into any lower tier covered transaction with a person who is debarred, suspended, declared ineligible, or voluntarily excluded from participation in this covered transaction, unless authorized by the department or agency with which this transaction originated.

f. The prospective lower tier participant further agrees by submitting this proposal that it will include this clause titled "Certification Regarding Debarment, Suspension, Ineligibility and Voluntary Exclusion-Lower Tier Covered Transaction," without modification, in all lower tier covered transactions and in all solicitations for lower tier covered transactions exceeding the \$25,000 threshold.

g. A participant in a covered transaction may rely upon a certification of a prospective participant in a lower tier covered transaction that is not debarred, suspended, ineligible, or voluntarily excluded from the covered transaction, unless it knows that the certification is erroneous. A participant is responsible for ensuring that its principals are not suspended, debarred, or otherwise ineligible to participate in covered transactions. To verify the eligibility of its principals, as well as the eligibility of any lower tier prospective participants, each participant may, but is not required to, check the Excluded Parties List System website (<https://www.epls.gov/>), which is compiled by the General Services Administration.

h. Nothing contained in the foregoing shall be construed to require establishment of a system of records in order to render in good faith the certification required by this clause. The knowledge and information of participant is not required to exceed that which is normally possessed by a prudent person in the ordinary course of business dealings.

i. Except for transactions authorized under paragraph e of these instructions, if a participant in a covered transaction knowingly enters into a lower tier covered transaction with a person who is suspended, debarred, ineligible, or voluntarily excluded from participation in this transaction, in addition to other remedies available to the Federal Government, the

department or agency with which this transaction originated may pursue available remedies, including suspension and/or debarment.

\* \* \* \* \*

**Certification Regarding Debarment, Suspension, Ineligibility and Voluntary Exclusion--Lower Tier Participants:**

1. The prospective lower tier participant certifies, by submission of this proposal, that neither it nor its principals is presently debarred, suspended, proposed for debarment, declared ineligible, or voluntarily excluded from participating in covered transactions by any Federal department or agency.

2. Where the prospective lower tier participant is unable to certify to any of the statements in this certification, such prospective participant shall attach an explanation to this proposal.

\* \* \* \* \*

**XI. CERTIFICATION REGARDING USE OF CONTRACT FUNDS FOR LOBBYING**

This provision is applicable to all Federal-aid construction contracts and to all related subcontracts which exceed \$100,000 (49 CFR 20).

1. The prospective participant certifies, by signing and submitting this bid or proposal, to the best of his or her knowledge and belief, that:

a. No Federal appropriated funds have been paid or will be paid, by or on behalf of the undersigned, to any person for influencing or attempting to influence an officer or employee of any Federal agency, a Member of Congress, an officer or employee of Congress, or an employee of a Member of Congress in connection with the awarding of any Federal contract, the making of any Federal grant, the making of any Federal loan, the entering into of any cooperative agreement, and the extension, continuation, renewal, amendment, or modification of any Federal contract, grant, loan, or cooperative agreement.

b. If any funds other than Federal appropriated funds have been paid or will be paid to any person for influencing or attempting to influence an officer or employee of any Federal agency, a Member of Congress, an officer or employee of Congress, or an employee of a Member of Congress in connection with this Federal contract, grant, loan, or cooperative agreement, the undersigned shall complete and submit Standard Form-LLL, "Disclosure Form to Report Lobbying," in accordance with its instructions.

2. This certification is a material representation of fact upon which reliance was placed when this transaction was made or entered into. Submission of this certification is a prerequisite for making or entering into this transaction imposed by 31 U.S.C. 1352. Any person who fails to file the required certification shall be subject to a civil penalty of not less than \$10,000 and not more than \$100,000 for each such failure.

3. The prospective participant also agrees by submitting its bid or proposal that the participant shall require that the language of this certification be included in all lower tier subcontracts, which exceed \$100,000 and that all such recipients shall certify and disclose accordingly.

**ATTACHMENT A - EMPLOYMENT AND MATERIALS  
PREFERENCE FOR APPALACHIAN DEVELOPMENT  
HIGHWAY SYSTEM OR APPALACHIAN LOCAL ACCESS  
ROAD CONTRACTS**

This provision is applicable to all Federal-aid projects funded under the Appalachian Regional Development Act of 1965.

1. During the performance of this contract, the contractor undertaking to do work which is, or reasonably may be, done as on-site work, shall give preference to qualified persons who regularly reside in the labor area as designated by the DOL wherein the contract work is situated, or the subregion, or the Appalachian counties of the State wherein the contract work is situated, except:

a. To the extent that qualified persons regularly residing in the area are not available.

b. For the reasonable needs of the contractor to employ supervisory or specially experienced personnel necessary to assure an efficient execution of the contract work.

c. For the obligation of the contractor to offer employment to present or former employees as the result of a lawful collective bargaining contract, provided that the number of nonresident persons employed under this subparagraph (1c) shall not exceed 20 percent of the total number of employees employed by the contractor on the contract work, except as provided in subparagraph (4) below.

2. The contractor shall place a job order with the State Employment Service indicating (a) the classifications of the laborers, mechanics and other employees required to perform the contract work, (b) the number of employees required in each classification, (c) the date on which the participant estimates such employees will be required, and (d) any other pertinent information required by the State Employment Service to complete the job order form. The job order may be placed with the State Employment Service in writing or by telephone. If during the course of the contract work, the information submitted by the contractor in the original job order is substantially modified, the participant shall promptly notify the State Employment Service.

3. The contractor shall give full consideration to all qualified job applicants referred to him by the State Employment Service. The contractor is not required to grant employment to any job applicants who, in his opinion, are not qualified to perform the classification of work required.

4. If, within one week following the placing of a job order by the contractor with the State Employment Service, the State Employment Service is unable to refer any qualified job applicants to the contractor, or less than the number requested, the State Employment Service will forward a certificate to the contractor indicating the unavailability of applicants. Such certificate shall be made a part of the contractor's permanent project records. Upon receipt of this certificate, the contractor may employ persons who do not normally reside in the labor area to fill positions covered by the certificate, notwithstanding the provisions of subparagraph (1c) above.

5. The provisions of 23 CFR 633.207(e) allow the contracting agency to provide a contractual preference for the use of mineral resource materials native to the Appalachian region.

6. The contractor shall include the provisions of Sections 1 through 4 of this Attachment A in every subcontract for work which is, or reasonably may be, done as on-site work.

**KENTUCKY TRANSPORTATION CABINET  
DEPARTMENT OF HIGHWAYS**

**EMPLOYMENT REQUIREMENTS  
RELATING TO  
NONDISCRIMINATION OF EMPLOYEES  
(APPLICABLE TO FEDERAL-AID SYSTEM CONTRACTS)**

**AN ACT OF THE KENTUCKY GENERAL ASSEMBLY  
TO PREVENT DISCRIMINATION IN EMPLOYMENT**

**KRS CHAPTER 344  
EFFECTIVE JUNE 16, 1972**

The contract on this project, in accordance with KRS Chapter 344, provides that during the performance of this contract, the contractor agrees as follows:

1. The contractor shall not fail or refuse to hire, or shall not discharge any individual, or otherwise discriminate against an individual with respect to his compensation, terms, conditions, or privileges of employment, because of such individual's race, color, religion, national origin, sex, disability or age (forty and above); or limit, segregate, or classify his employees in any way which would deprive or tend to deprive an individual of employment opportunities or otherwise adversely affect his status as an employee, because of such individual's race, color, religion, national origin, sex, disability or age forty (40) and over. The contractor agrees to post in conspicuous places, available to employees and applicants for employment, notices to be provided setting forth the provisions of this nondiscrimination clause.

2. The contractor shall not print or publish or cause to be printed or published a notice or advertisement relating to employment by such an employer or membership in or any classification or referral for employment by the employment agency, indicating any preference, limitation, specification, or discrimination, based on race, color, religion, national origin, sex, or age forty (40) and over, or because the person is a qualified individual with a disability, except that such a notice or advertisement may indicate a preference, limitation, or specification based on religion, national origin, sex, or age forty (40) and over, or because the person is a qualified individual with a disability, when religion, national origin, sex, or age forty (40) and over, or because the person is a qualified individual with a disability, is a bona fide occupational qualification for employment.

3. If the contractor is in control of apprenticeship or other training or retraining, including on-the-job training programs, he shall not discriminate against an individual because of his race, color, religion, national origin, sex, disability or age forty (40) and over, in admission to, or employment in any program established to provide apprenticeship or other training.

4. The contractor will send to each labor union or representative of workers with which he has a collective bargaining agreement or other contract or understanding, a notice to be provided advising the said labor union or workers' representative of the contractor's commitments under this section, and shall post copies of the notice in conspicuous places available to employees and applicants for employment. The contractor will take such action with respect to any subcontract or purchase order as the administering agency may direct as a means of enforcing such provisions, including sanctions for non-compliance.

Revised: January 25, 2017

### Standard Title VI/Non-Discrimination Assurances

During the performance of this contract, the contractor, for itself, its assignees, and successors in interest (hereinafter referred to as the "contractor") agrees as follows:

1. **Compliance with Regulations:** The contractor (hereinafter includes consultants) will comply with the Acts and the Regulations relative to Non-discrimination in Federally-assisted programs of the U.S. Department of Transportation, **Federal Highway Administration**, as they may be amended from time to time, which are herein incorporated by reference and made a part of this contract.
2. **Non-discrimination:** The contractor, with regard to the work performed by it during the contract, will not discriminate on the grounds of race, color, or national origin in the selection and retention of subcontractors, including procurements of materials and leases of equipment. The contractor will not participate directly or indirectly in the discrimination prohibited by the Acts and the Regulations, including employment practices when the contract covers any activity, project, or program set forth in Appendix B of 49 CFR Part 21.
3. **Solicitations for Subcontracts, Including Procurements of Materials and Equipment:** In all solicitations, either by competitive bidding, or negotiation made by the contractor for work to be performed under a subcontract, including procurements of materials, or leases of equipment, each potential subcontractor or supplier will be notified by the contractor of the contractor's obligations under this contract and the Acts and the Regulations relative to Non-discrimination on the grounds of race, color, or national origin.
4. **Information and Reports:** The contractor will provide all information and reports required by the Acts, the Regulations, and directives issued pursuant thereto and will permit access to its books, records, accounts, other sources of information, and its facilities as may be determined by the Recipient or the **Federal Highway Administration** to be pertinent to ascertain compliance with such Acts, Regulations, and instructions. Where any information required of a contractor is in the exclusive possession of another who fails or refuses to furnish the information, the contractor will so certify to the Recipient or the **Federal Highway Administration**, as appropriate, and will set forth what efforts it has made to obtain the information.
5. **Sanctions for Noncompliance:** In the event of a contractor's noncompliance with the Non-discrimination provisions of this contract, the Recipient will impose such contract sanctions as it or the **Federal Highway Administration** may determine to be appropriate, including, but not limited to:
  - a. withholding payments to the contractor under the contract until the contractor complies; and/or
  - b. cancelling, terminating, or suspending a contract, in whole or in part.
6. **Incorporation of Provisions:** The contractor will include the provisions of paragraphs one through six in every subcontract, including procurements of materials and leases of equipment, unless exempt by the Acts, the Regulations and directives issued pursuant thereto. The contractor will take action with respect to any subcontract or procurement as the Recipient or the **Federal Highway Administration** may direct as a means of enforcing such provisions including sanctions for noncompliance. Provided, that if the contractor becomes involved in, or is threatened with litigation by a subcontractor, or supplier because of such direction, the contractor may request the Recipient to enter into any litigation to protect the interests of the Recipient. In addition, the contractor may request the United States to enter into the litigation to protect the interests of the United States.

### Standard Title VI/Non-Discrimination Statutes and Authorities

During the performance of this contract, the contractor, for itself, its assignees, and successors in interest (hereinafter referred to as the “contractor”) agrees to comply with the following non-discrimination statutes and authorities; including but not limited to:

- Title VI of the Civil Rights Act of 1964 (42 U.S.C. § 2000d *et seq.*, 78 stat. 252), (prohibits discrimination on the basis of race, color, national origin); and 49 CFR Part 21;
- The Uniform Relocation Assistance and Real Property Acquisition Policies Act of 1970, (42 U.S.C. § 4601), (prohibits unfair treatment of persons displaced or whose property has been acquired because of Federal or Federal-aid programs and projects);
- Federal-Aid Highway Act of 1973, (23 U.S.C. § 324 *et seq.*), (prohibits discrimination on the basis of sex);
- Section 504 of the Rehabilitation Act of 1973, (29 U.S.C. § 794 *et seq.*), as amended, (prohibits discrimination on the basis of disability); and 49 CFR Part 27;
- The Age Discrimination Act of 1975, as amended, (42 U.S.C. § 6101 *et seq.*), (prohibits discrimination on the basis of age);
- Airport and Airway Improvement Act of 1982, (49 USC § 471, Section 47123), as amended, (prohibits discrimination based on race, creed, color, national origin, or sex);
- The Civil Rights Restoration Act of 1987, (PL 100-209), (Broadened the scope, coverage and applicability of Title VI of the Civil Rights Act of 1964, The Age Discrimination Act of 1975 and Section 504 of the Rehabilitation Act of 1973, by expanding the definition of the terms “programs or activities” to include all of the programs or activities of the Federal-aid recipients, sub-recipients and contractors, whether such programs or activities are Federally funded or not);
- Titles II and III of the Americans with Disabilities Act, which prohibit discrimination on the basis of disability in the operation of public entities, public and private transportation systems, places of public accommodation, and certain testing entities (42 U.S.C. §§ 12131 -- 12189) as implemented by Department of Transportation regulations at 49 C.F.R. parts 37 and 38;
- The Federal Aviation Administration’s Non-discrimination statute (49 U.S.C. § 47123) (prohibits discrimination on the basis of race, color, national origin, and sex);
- Executive Order 12898, Federal Actions to Address Environmental Justice in Minority Populations and Low-Income Populations, which ensures non-discrimination against minority populations by discouraging programs, policies, and activities with disproportionately high and adverse human health or environmental effects on minority and low-income populations;
- Executive Order 13166, Improving Access to Services for Persons with Limited English Proficiency, and resulting agency guidance, national origin discrimination includes discrimination because of limited English proficiency (LEP). To ensure compliance with Title VI, you must take reasonable steps to ensure that LEP persons have meaningful access to your programs (70 Fed. Reg. at 74087 to 74100);
- Title IX of the Education Amendments of 1972, as amended, which prohibits you from discriminating because of sex in education programs or activities (20 U.S.C. 1681 *et seq.*)

## EXECUTIVE BRANCH CODE OF ETHICS

In the 1992 regular legislative session, the General Assembly passed and Governor Brereton Jones signed Senate Bill 63 (codified as KRS 11A), the Executive Branch Code of Ethics, which states, in part:

KRS 11A.040 (7) provides:

No present or former public servant shall, within six (6) months following termination of his office or employment, accept employment, compensation, or other economic benefit from any person or business that contracts or does business with, or is regulated by, the state in matters in which he was directly involved during the last thirty-six (36) months of his tenure. This provision shall not prohibit an individual from returning to the same business, firm, occupation, or profession in which he was involved prior to taking office or beginning his term of employment, or for which he received, prior to his state employment, a professional degree or license, provided that, for a period of six (6) months, he personally refrains from working on any matter in which he was directly involved during the last thirty-six (36) months of his tenure in state government. This subsection shall not prohibit the performance of ministerial functions, including but not limited to filing tax returns, filing applications for permits or licenses, or filing incorporation papers, nor shall it prohibit the former officer or public servant from receiving public funds disbursed through entitlement programs.

KRS 11A.040 (9) states:

A former public servant shall not represent a person or business before a state agency in a matter in which the former public servant was directly involved during the last thirty-six (36) months of his tenure, for a period of one (1) year after the latter of:

- a) The date of leaving office or termination of employment; or
- b) The date the term of office expires to which the public servant was elected.

This law is intended to promote public confidence in the integrity of state government and to declare as public policy the idea that state employees should view their work as a public trust and not as a way to obtain private benefits.

If you have worked for the executive branch of state government within the past six months, you may be subject to the law's prohibitions. The law's applicability may be different if you hold elected office or are contemplating representation of another before a state agency.

Also, if you are affiliated with a firm which does business with the state and which employs former state executive-branch employees, you should be aware that the law may apply to them.

In case of doubt, the law permits you to request an advisory opinion from the Executive Branch Ethics Commission, 3 Fountain Place, Frankfort, Kentucky 40601; telephone (502) 564-7954.

Revised: January 27, 2017



"General Decision Number: KY20200040 08/28/2020

Superseded General Decision Number: KY20190040

State: Kentucky

Construction Type: Highway

Counties: Allen, Ballard, Butler, Caldwell, Calloway, Carlisle, Christian, Crittenden, Daviess, Edmonson, Fulton, Graves, Hancock, Henderson, Hickman, Hopkins, Livingston, Logan, Lyon, Marshall, McCracken, McLean, Muhlenberg, Ohio, Simpson, Todd, Trigg, Union, Warren and Webster Counties in Kentucky.

HIGHWAY CONSTRUCTION PROJECTS (excluding tunnels, building structures in rest area projects & railroad construction; bascule, suspension & spandrel arch bridges designed for commercial navigation, bridges involving marine construction; and other major bridges).

Note: Under Executive Order (EO) 13658, an hourly minimum wage of \$10.80 for calendar year 2020 applies to all contracts subject to the Davis-Bacon Act for which the contract is awarded (and any solicitation was issued) on or after January 1, 2015. If this contract is covered by the EO, the contractor must pay all workers in any classification listed on this wage determination at least \$10.80 per hour (or the applicable wage rate listed on this wage determination, if it is higher) for all hours spent performing on the contract in calendar year 2020. If this contract is covered by the EO and a classification considered necessary for performance of work on the contract does not appear on this wage determination, the contractor must pay workers in that classification at least the wage rate determined through the conformance process set forth in 29 CFR 5.5(a)(1)(ii) (or the EO minimum wage rate, if it is higher than the conformed wage rate). The EO minimum wage rate will be adjusted annually. Please note that this EO applies to the above-mentioned types of contracts entered into by the federal government that are subject to the Davis-Bacon Act itself, but it does not apply to contracts subject only to the Davis-Bacon Related Acts, including those set forth at 29 CFR 5.1(a)(2)-(60). Additional information on contractor requirements and worker protections under the EO is available at [www.dol.gov/whd/govcontracts](http://www.dol.gov/whd/govcontracts).

Modification Number	Publication Date
0	01/03/2020
1	01/10/2020
2	01/31/2020
3	08/14/2020
4	08/28/2020

BRIN0004-002 06/01/2017

BALLARD, BUTLER, CALDWELL, CARLISLE, CRITTENDEN, DAVIESS, EDMONSON, FULTON, GRAVES, HANCOCK, HENDERSON, HICKMAN, HOPKINS, LIVINGSTON, LYON, MARSHALL, MCCRACKEN, MCLEAN, MUHLENBERG, OHIO, UNION, and WEBSTER COUNTIES

Rates

Fringes



BRICKLAYER

Ballard, Caldwell, Carlisle, Crittenden, Fulton, Graves, Hickman, Livingston, Lyon, Marshall, and McCracken Counties.....	\$ 30.50	15.16
Butler, Edmonson, Hopkins, Muhlenberg, and Ohio Counties.....	\$ 26.80	12.38
Daviess, Hancock, Henderson, McLean, Union, and Webster Counties.....	\$ 30.00	15.16

-----  
BRTN0004-005 06/01/2017

ALLEN, CALLOWAY, CHRISTIAN, LOGAN, SIMPSON, TODD, TRIGG, and  
WARREN COUNTIES

	Rates	Fringes
BRICKLAYER.....	\$ 26.80	12.38

-----  
CARP0357-002 04/01/2019

	Rates	Fringes
CARPENTER.....	\$ 29.25	19.23
Diver.....	\$ 44.25	19.23
PILEDRIVERMAN.....	\$ 29.50	19.23

-----  
ELEC0369-006 05/28/2019

BUTLER, EDMONSON, LOGAN, TODD & WARREN COUNTIES:

	Rates	Fringes
ELECTRICIAN.....	\$ 32.44	17.22

-----  
ELEC0429-001 01/01/2020

ALLEN & SIMPSON COUNTIES:

	Rates	Fringes
ELECTRICIAN.....	\$ 27.72	13.48

-----  
ELEC0816-002 01/01/2020

BALLARD, CALDWELL, CALLOWAY, CARLISLE, CHRISTIAN, CRITTENDEN,  
FULTON (Except a 5 mile radius of City Hall in Fulton), GRAVES,  
HICKMAN, LIVINGSTON, LYON, MARSHALL, MCCRACKEN & TRIGG COUNTIES:

	Rates	Fringes
ELECTRICIAN.....	\$ 33.58	25.5%+7.25

Cable spicers receive \$.25 per hour additional.

-----  
ELEC1701-003 06/01/2018

DAVISS, HANCOCK, HENDERSON, HOPKINS, MCLEAN, MUHLENBERG, OHIO,  
UNION & WEBSTER COUNTIES:

	Rates	Fringes
ELECTRICIAN.....	\$ 31.04	15.74

Cable spicers receive \$.25 per hour additional.

-----  
ELEC1925-002 01/01/2019

FULTON COUNTY (Up to a 5 mile radius of City Hall in Fulton):

	Rates	Fringes
CABLE SPLICER.....	\$ 25.80	12.16
ELECTRICIAN.....	\$ 25.20	13.74

-----  
\* ENGI0181-017 07/01/2020

	Rates	Fringes
POWER EQUIPMENT OPERATOR		
GROUP 1.....	\$ 33.95	17.25
GROUP 2.....	\$ 31.09	17.25
GROUP 3.....	\$ 31.54	17.25
GROUP 4.....	\$ 30.77	17.25

OPERATING ENGINEER CLASSIFICATIONS

GROUP 1 - A-Frame Winch Truck; Auto Patrol; Backfiller; Batcher Plant; Bituminous Paver; Bituminous Transfer Machine; Boom Cat; Bulldozer; Mechanic; Cableway; Carry-All Scoop; Carry Deck Crane; Central Compressor Plant; Cherry Picker; Clamshell; Concrete Mixer (21 cu. ft. or Over); Concrete Paver; Truck-Mounted Concrete Pump; Core Drill; Crane; Crusher Plant; Derrick; Derrick Boat; Ditching & Trenching Machine; Dragline; Dredge Operator; Dredge Engineer; Elevating Grader & Loaders; Grade-All; Gurries; Heavy Equipment Robotics Operator/Mechanic; High Lift; Hoe-Type Machine; Hoist (Two or More Drums); Hoisting Engine (Two or More Drums); Horizontal Directional Drill Operator; Hydrocrane; Hyster; KeCal Loader; LeTourneau; Locomotive; Mechanic; Mechanically Operated Laser Screed; Mechanic Welder; Mucking Machine; Motor Scraper; Orangepeel Bucket; Overhead Crane; Piledriver; Power Blade; Pumpcrete; Push Dozer; Rock Spreader, attached to equipment; Rotary Drill; Roller (Bituminous); Rough Terrain Crane; Scarifier; Scoopmobile; Shovel; Side Boom; Subgrader; Tailboom; Telescoping Type Forklift; Tow or Push Boat; Tower Crane (French, German & other types); Tractor Shovel; Truck Crane; Tunnel Mining Machines, including Moles, Shields or similar types of Tunnel Mining Equipment

GROUP 2 - Air Compressor (Over 900 cu. ft. per min.); Bituminous Mixer; Boom Type Tamping Machine; Bull Float; Concrete Mixer (Under 21 cu. ft.); Dredge Engineer; Electric Vibrator; Compactor/Self-Propelled Compactor; Elevator (One Drum or Buck Hoist); Elevator (When used to Hoist Building Material); Finish Machine; Firemen & Hoist (One Drum); Flexplane; Forklift (Regardless of Lift Height); Form Grader; Joint Sealing Machine; Outboard Motor Boat; Power Sweeper (Riding Type); Roller (Rock); Ross

Carrier; Skid Mounted or Trailer Mounted Concrete Pump; Skid Steer Machine with all Attachments; Switchman or Brakeman; Throttle Valve Person; Tractair & Road Widening Trencher; Tractor (50 H.P. or Over); Truck Crane Oiler; Tugger; Welding Machine; Well Points;& Whirley Oiler

GROUP 3 -All Off Road Material Handling Equipment, including Articulating Dump Trucks; Greaser on Grease Facilities servicing Heavy Equipment

GROUP 4 - Bituminous Distributor; Burlap & Curing Machine; Cement Gun; Concrete Saw; Conveyor; Deckhand Oiler; Grout Pump; Hydraulic Post Driver; Hydro Seeder; Mud Jack; Oiler; Paving Joint Machine; Power Form Handling Equipment; Pump; Roller (Earth); Steerman; Tamping Machine; Tractor (Under 50 H.P.); & Vibrator

CRANES - with booms 150 ft. & Over (Including JIB), and where the length of the boom in combination with the length of the piling equals or exceeds 150 ft. - \$1.00 above Group 1 rate

EMPLOYEES ASSIGNED TO WORK BELOW GROUND LEVEL ARE TO BE PAID 10% ABOVE BASIC WAGE RATE. THIS DOES NOT APPLY TO OPEN CUT WORK.

-----  
IRON0070-005 06/01/2020

BUTLER COUNTY (Eastern eighth, including the Townships of Decker, Lee & Tilford);  
EDMONSON COUNTY (Northern three-fourths, including the Townships of Asphalt, Bee Spring, Brownsville, Grassland, Huff, Kyrock, Lindseyville, Mammoth Cave, Ollie, Prosperity, Rhoda, Sunfish & Sweden)

Rates                      Fringes

IRONWORKER  
    Structural; Ornamental;  
    Reinforcing; Precast  
    Concrete Erectors.....\$ 30.42                      23.15

-----  
IRON0103-004 08/01/2018

DAVISS, HANCOCK, HENDERSON, HOPKINS, MCLEAN, OHIO, UNION & WEBSTER COUNTIES  
BUTLER COUNTY (Townships of Aberdeen, Bancock, Casey, Dexterville, Dunbar, Elfie, Gilstrap, Huntsville, Logansport, Monford, Morgantown, Provo, Rochester, South Hill & Welchs Creek);  
CALDWELL COUNTY (Northeastern third, including the Township of Creswell);  
CHRISTIAN COUNTY (Northern third, including the Townships of Apex, Crofton, Kelly, Mannington & Wynns);  
CRITTENDEN COUNTY (Northeastern half, including the Townships of Grove, Mattoon, Repton, Shady Grove & Tribune);  
MUHLENBERG COUNTY (Townships of Bavier, Beech Creek Junction, Benton, Brennen, Browder, Central City, Cleaton, Depoy, Drakesboro, Eunis, Graham, Hillside, Luzerne, Lynn City, Martwick, McNary, Millport, Moorman, Nelson, Paradise, Powderly, South Carrollton, Tarina & Weir)

	Rates	Fringes
Ironworkers:.....	\$ 28.66	22.435

-----  
IRON0492-003 05/01/2018

ALLEN, LOGAN, SIMPSON, TODD & WARREN COUNTIES  
 BUTLER COUNTY (Southern third, including the Townships of  
 Boston, Berrys Lick, Dimple, Jetson, Quality, Sharer, Sugar  
 Grove & Woodbury);  
 CHRISTIAN COUNTY (Eastern two-thirds, including the Townships  
 of Bennettstown, Casky, Herndon, Hopkinsville, Howell,  
 Masonville, Pembroke & Thompsonville);  
 EDMONSON COUNTY (Southern fourth, including the Townships of  
 Chalybeate & Rocky Hill);  
 MUHLENBERG COUNTY (Southern eighth, including the Townships of  
 Dunnior, Penrod & Rosewood)

	Rates	Fringes
Ironworkers:.....	\$ 26.11	14.02

-----  
IRON0782-006 05/01/2018

BALLARD, CALLOWAY, CARLISLE, FULTON, GRAVES, HICKMAN,  
 LIVINGSTON, LYON, MARSHALL, MCCRACKEN & TRIGG COUNTIES  
 CALDWELL COUNTY (Southwestern two-thirds, including the  
 Townships of Cedar Bluff, Cider, Claxton, Cobb, Crowtown,  
 Dulaney, Farmersville, Fredonia, McGowan, Otter Pond &  
 Princeton);  
 CHRISTIAN COUNTY (Western third, Excluding the Townships of  
 Apex, Crofton, Kelly, Mannington, Wynns, Bennettstown, Casky,  
 Herndon, Hopkinsville, Howell, Masonville, Pembroke &  
 Thompsonville);  
 CRITTENDEN COUNTY (Southwestern half, including the Townships  
 of Crayne, Dycusburg, Frances, Marion, Mexico, Midway,  
 Sheridan & Told)

	Rates	Fringes
Ironworkers:		
Projects with a total contract cost of		
\$20,000,000.00 or above.....	\$ 28.79	24.17
All Other Work.....	\$ 27.20	22.75

-----  
LABO0189-005 07/01/2018

BALLARD, CALLOWAY, CARLISLE, FULTON, GRAVES, HICKMAN,  
 LIVINGSTON, LYON, MARSHALL & MCCRACKEN COUNTIES

	Rates	Fringes
Laborers:		
GROUP 1.....	\$ 23.07	14.21
GROUP 2.....	\$ 23.32	14.21
GROUP 3.....	\$ 23.37	14.21
GROUP 4.....	\$ 23.97	14.21

LABORER CLASSIFICATIONS

GROUP 1 - Aging & Curing of Concrete; Asbestos Abatement Worker; Asphalt Plant; Asphalt; Batch Truck Dump; Carpenter Tender; Cement Mason Tender; Cleaning of Machines; Concrete; Demolition; Dredging; Environmental - Nuclear, Radiation, Toxic & Hazardous Waste - Level D; Flagperson; Grade Checker; Hand Digging & Hand Back Filling; Highway Marker Placer; Landscaping, Mesh Handler & Placer; Puddler; Railroad; Rip-rap & Grouter; Right-of-Way; Sign, Guard Rail & Fence Installer; Signal Person; Sound Barrier Installer; Storm & Sanitary Sewer; Swamper; Truck Spotter & Dumper; Wrecking of Concrete Forms; General Cleanup

GROUP 2 - Batter Board Man (Sanitary & Storm Sewer); Brickmason Tender; Mortar Mixer Operator; Scaffold Builder; Burner & Welder; Bushhammer; Chain Saw Operator; Concrete Saw Operator; Deckhand Scow Man; Dry Cement Handler; Environmental - Nuclear, Radiation, Toxic & Hazardous Waste - Level C; Forklift Operator for Masonary; Form Setter; Green Concrete Cutting; Hand Operated Grouter & Grinder Machine Operator; Jackhammer; Pavement Breaker; Paving Joint Machine; Pipelayer; Plastic Pipe Fusion; Power Driven Georgia Buggy & Wheel Barrow; Power Post Hole Digger; Precast Manhole Setter; Walk-Behind Tamper; Walk-Behind Trencher; Sand Blaster; Concrete Chipper; Surface Grinder; Vibrator Operator; Wagon Driller

GROUP 3 - Asphalt Luteman & Raker; Gunnite Nozzleman; Gunnite Operator & Mixer; Grout Pump Operator; Blaster; Side Rail Setter; Rail Paved Ditches; Screw Operator; Tunnel (Free Air); Water Blaster

GROUP 4 - Caisson Worker (Free Air); Cement Finisher; Environmental - Nuclear, Radiation, Toxic & Hazardous Waste - Levels A & B; Miner & Driller (Free Air); Tunnel Blaster; & Tunnel Mucker (Free Air); Directional & Horizontal Boring; Air Track Drillers (All Types); Powdermen & Blasters; Troxler & Concrete Tester if Laborer is Utilized

-----  
LAB00189-006 07/01/2018

ALLEN, BUTLER, CALDWELL, CHRISTIAN, DAVIESS, EDMONSON, HANCOCK, HOPKINS, LOGAN, MCLEAN, MUHLENBERG, OHIO, SIMPSON, TODD, TRIGG & WARREN COUNTIES

	Rates	Fringes
Laborers:		
GROUP 1.....	\$ 23.07	14.21
GROUP 2.....	\$ 23.32	14.21
GROUP 3.....	\$ 23.37	14.21
GROUP 4.....	\$ 23.97	14.21

LABORER CLASSIFICATIONS

GROUP 1 - Aging & Curing of Concrete; Asbestos Abatement Worker; Asphalt Plant; Asphalt; Batch Truck Dump; Carpenter Tender; Cement Mason Tender; Cleaning of Machines; Concrete; Demolition; Dredging; Environmental - Nuclear, Radiation, Toxic & Hazardous Waste - Level D; Flagperson; Grade Checker; Hand Digging & Hand Back Filling; Highway Marker Placer; Landscaping, Mesh Handler & Placer; Puddler;

Railroad; Rip-rap & Grouter; Right-of-Way; Sign, Guard Rail & Fence Installer; Signal Person; Sound Barrier Installer; Storm & Sanitary Sewer; Swamper; Truck Spotter & Dumper; Wrecking of Concrete Forms; General Cleanup

GROUP 2 - Batter Board Man (Sanitary & Storm Sewer); Brickmason Tender; Mortar Mixer Operator; Scaffold Builder; Burner & Welder; Bushhammer; Chain Saw Operator; Concrete Saw Operator; Deckhand Scow Man; Dry Cement Handler; Environmental - Nuclear, Radiation, Toxic & Hazardous Waste - Level C; Forklift Operator for Masonary; Form Setter; Green Concrete Cutting; Hand Operated Grouter & Grinder Machine Operator; Jackhammer; Pavement Breaker; Paving Joint Machine; Pipelayer; Plastic Pipe Fusion; Power Driven Georgia Buggy & Wheel Barrow; Power Post Hole Digger; Precast Manhole Setter; Walk-Behind Tamper; Walk-Behind Trencher; Sand Blaster; Concrete Chipper; Surface Grinder; Vibrator Operator; Wagon Driller

GROUP 3 - Asphalt Luteman & Raker; Gunnite Nozzleman; Gunnite Operator & Mixer; Grout Pump Operator; Blaster; Side Rail Setter; Rail Paved Ditches; Screw Operator; Tunnel (Free Air); Water Blaster

GROUP 4 - Caisson Worker (Free Air); Cement Finisher; Environmental - Nuclear, Radiation, Toxic & Hazardous Waste - Levels A & B; Miner & Driller (Free Air); Tunnel Blaster; & Tunnel Mucker (Free Air); Directional & Horizontal Boring; Air Track Drillers (All Types); Powdermen & Blasters; Troxler & Concrete Tester if Laborer is Utilized

-----  
LABO0561-001 07/01/2018

CRITTENDEN, HENDERSON, UNION & WEBSTER COUNTIES

	Rates	Fringes
Laborers:		
GROUP 1.....	\$ 22.71	15.00
GROUP 2.....	\$ 22.96	15.00
GROUP 3.....	\$ 23.01	15.00
GROUP 4.....	\$ 23.61	15.00

LABORER CLASSIFICATIONS

GROUP 1 - Aging & Curing of Concrete; Asbestos Abatement Worker; Asphalt Plant; Asphalt; Batch Truck Dump; Carpenter Tender; Cement Mason Tender; Cleaning of Machines; Concrete; Demolition; Dredging; Environmental - Nuclear, Radiation, Toxic & Hazardous Waste - Level D; Flagperson; Grade Checker; Hand Digging & Hand Back Filling; Highway Marker Placer; Landscaping, Mesh Handler & Placer; Puddler; Railroad; Rip-rap & Grouter; Right-of-Way; Sign, Guard Rail & Fence Installer; Signal Person; Sound Barrier Installer; Storm & Sanitary Sewer; Swamper; Truck Spotter & Dumper; Wrecking of Concrete Forms; General Cleanup

GROUP 2 - Batter Board Man (Sanitary & Storm Sewer); Brickmason Tender; Mortar Mixer Operator; Scaffold Builder; Burner & Welder; Bushhammer; Chain Saw Operator; Concrete Saw Operator; Deckhand Scow Man; Dry Cement Handler; Environmental - Nuclear, Radiation, Toxic & Hazardous Waste - Level C; Forklift Operator for Masonary; Form Setter;

Green Concrete Cutting; Hand Operated Grouter & Grinder  
Machine Operator; Jackhammer; Pavement Breaker; Paving  
Joint Machine; Pipelayer; Plastic Pipe Fusion; Power Driven  
Georgia Buggy & Wheel Barrow; Power Post Hole Digger;  
Precast Manhole Setter; Walk-Behind Tamper; Walk-Behind  
Trencher; Sand Blaster; Concrete Chipper; Surface  
Grinder; Vibrator Operator; Wagon Driller

GROUP 3 - Asphalt Luteman & Raker; Gunnite Nozzleman; Gunnite  
Operator & Mixer; Grout Pump Operator; Blaster; Side Rail  
Setter; Rail Paved Ditches; Screw Operator; Tunnel (Free  
Air); Water Blaster

GROUP 4 - Caisson Worker (Free Air); Cement Finisher;  
Environmental - Nuclear, Radiation, Toxic & Hazardous Waste  
- Levels A & B; Miner & Driller (Free Air); Tunnel Blaster;  
& Tunnel Mucker (Free Air); Directional & Horizontal  
Boring; Air Track Drillers (All Types); Powdermen &  
Blasters; Troxler & Concrete Tester if Laborer is Utilized

-----  
PAIN0032-002 09/01/2018

BALLARD COUNTY

	Rates	Fringes
Painters:		
Bridges.....	\$ 33.56	16.13
All Other Work.....	\$ 31.86	16.13

Spray, Blast, Steam, High & Hazardous (Including Lead  
Abatement) and All Epoxy - \$1.00 Premium

-----  
PAIN0118-003 06/01/2014

EDMONSON COUNTY:

	Rates	Fringes
Painters:		
Brush & Roller.....	\$ 18.50	11.97
Spray, Sandblast, Power Tools, Waterblast & Steam Cleaning.....	\$ 19.50	11.97

-----  
PAIN0156-006 04/01/2015

DAVISS, HANCOCK, HENDERSON, MCLEAN, OHIO, UNION & WEBSTER  
COUNTIES

	Rates	Fringes
Painters:		
BRIDGES		
GROUP 1.....	\$ 27.60	12.85
GROUP 2.....	\$ 27.85	12.85
GROUP 3.....	\$ 28.60	12.85
GROUP 4.....	\$ 29.60	12.85
ALL OTHER WORK:		
GROUP 1.....	\$ 26.45	12.85
GROUP 2.....	\$ 26.70	12.85

GROUP 3.....	\$ 27.45	12.85
GROUP 4.....	\$ 28.45	12.85

PAINTER CLASSIFICATIONS

GROUP 1 - Brush & Roller

GROUP 2 - Plasterers

GROUP 3 - Spray; Sandblast; Power Tools; Waterblast;  
Steamcleaning; Brush & Roller of Mastics, Creosotes, Kwinch  
Koate & Coal Tar Epoxy

GROUP 4 - Spray of Mastics, Creosotes, Kwinch Koate & Coal  
Tar Epoxy

-----  
PAIN0500-002 06/01/2018

CALDWELL, CALLOWAY, CARLISLE, CHRISTIAN, CRITTENDEN, FULTON,  
GRAVES, HICKMAN, HOPKINS, LIVINGSTON, LYON, MARSHALL, MCCRACKEN  
& TRIGG COUNTIES:

	Rates	Fringes
Painters:		
Bridges.....	\$ 27.75	13.60
All Other Work.....	\$ 21.50	13.60

Waterblasting units with 3500 PSI and above - \$.50 premium  
Spraypainting and all abrasive blasting - \$1.00 premium  
Work 40 ft. and above ground level - \$1.00 premium

-----  
PLUM0184-002 07/01/2018

BALLARD, CALDWELL, CALLOWAY, CARLISLE, CHRISTIAN, CRITTENDEN,  
FULTON, GRAVES, HICKMAN, LIVINGSTON, LYON, MARSHALL, MCCRACKEN  
and TRIGG COUNTIES

	Rates	Fringes
Plumber; Steamfitter.....	\$ 35.06	18.18

-----  
PLUM0502-004 08/01/2020

ALLEN, BUTLER, EDMONSON, SIMPSON & WARREN

	Rates	Fringes
Plumber; Steamfitter.....	\$ 36.92	20.78

-----  
PLUM0633-002 07/01/2017

DAVISS, HANCOCK, HENDERSON, HOPKINS, LOGAN, MCLEAN,  
MUHLENBERG, OHIO, TODD, UNION & WEBSTER COUNTIES:

	Rates	Fringes
PLUMBER/PIPEFITTER.....	\$ 31.47	16.80

-----



TEAM0089-003 04/01/2019

ALLEN, BUTLER, EDMONSON, LOGAN, SIMPSON & WARREN COUNTIES

	Rates	Fringes
Truck drivers:		
Zone 1:		
Group 1.....	\$ 20.82	21.96
Group 2.....	\$ 21.00	21.96
Group 3.....	\$ 21.08	21.96
Group 4.....	\$ 21.10	21.96

GROUP 1 - Greaser; Tire Changer

GROUP 2 - Truck Mechanic; Single Axle Dump; Flat Bed; All Terrain Vehicles when used to haul materials; Semi Trailer or Pole Trailer when used to pull building materials and equipment; Tandem Axle Dump; Driver of Distributors

GROUP 3 - Mixer All Types

GROUP 4 - Winch and A-Frame when used in transporting materials; Ross Carrier; Fork Lift when used to transport building materials; Driver on Pavement Breaker; Euclid and Other Heavy Earth Moving Equipment; Low Boy; Articulator Cat; Five Axle Vehicle

-----  
TEAM0215-003 04/01/2019

DAVIESS, HANCOCK, HENDERSON, HOPKINS, MCLEAN, MUHLENBERG, OHIO & WEBSTER COUNTIES

	Rates	Fringes
TRUCK DRIVER		
Group 1.....	\$ 22.45	21.96
Group 2.....	\$ 22.68	21.96
Group 3.....	\$ 22.75	21.96
Group 4.....	\$ 22.76	21.96

GROUP 1: Greaser, Tire Changer

GROUP 2: Truck Mechanic

GROUP 3: Single Axle Dump; Flat Bed; All Terrain Vehicle when used to haul materials; Semi Trailer or Pole Trailer when used to pull building materials and equipment; Tandem Axle Dump; Driver of Distributors; Mixer All Types

GROUP 4: Euclid and other heavy earth moving equipment; Low Boy; Articulator Cat; 5 Axle Vehicle; Winch and A- Frame when used in transporting materials; Ross Carrier; Fork Lift when used to transport building materials; Driver on Pavement Breaker

-----  
TEAM0236-001 04/01/2019

BALLARD, CALDWELL, CALLOWAY, CARLISLE, CHRISTIAN, CRITTENDEN, FULTON, GRAVES, HICKMAN, LIVINGSTON, LYON, MARSHALL, MCCracken, TODD & TRIGG COUNTIES

	Rates	Fringes
TRUCK DRIVER		
Group 1.....	\$ 20.82	21.96
Group 2.....	\$ 21.00	21.96
Group 3.....	\$ 21.00	21.96
Group 4.....	\$ 20.10	21.96
Group 5.....	\$ 21.08	21.96

GROUP 1: Greaser, Tire Changer

GROUP 2: Truck Mechanic

GROUP 3: Single Axle Dump; Flat Bed; All Terrain Vehicle when used to haul materials; Semi Trailer or Pole Trailer when used to pull building materials and equipment; Tandem Axle Dump; Drivers of Distributors

GROUP 4: Euclid and other heavy earth moving equipment; Low Boy; Articulator Cat; Five Axle Vehicle; Winch and A-Frame when used in transporting materials; Ross Carrier

GROUP 5: Mixer All Types

-----  
WELDERS - Receive rate prescribed for craft performing operation to which welding is incidental.

=====  
Note: Executive Order (EO) 13706, Establishing Paid Sick Leave for Federal Contractors applies to all contracts subject to the Davis-Bacon Act for which the contract is awarded (and any solicitation was issued) on or after January 1, 2017. If this contract is covered by the EO, the contractor must provide employees with 1 hour of paid sick leave for every 30 hours they work, up to 56 hours of paid sick leave each year. Employees must be permitted to use paid sick leave for their own illness, injury or other health-related needs, including preventive care; to assist a family member (or person who is like family to the employee) who is ill, injured, or has other health-related needs, including preventive care; or for reasons resulting from, or to assist a family member (or person who is like family to the employee) who is a victim of, domestic violence, sexual assault, or stalking. Additional information on contractor requirements and worker protections under the EO is available at [www.dol.gov/whd/govcontracts](http://www.dol.gov/whd/govcontracts).

Unlisted classifications needed for work not included within the scope of the classifications listed may be added after award only as provided in the labor standards contract clauses (29CFR 5.5 (a) (1) (ii)).

-----  
The body of each wage determination lists the classification and wage rates that have been found to be prevailing for the cited type(s) of construction in the area covered by the wage determination. The classifications are listed in alphabetical

order of ""identifiers"" that indicate whether the particular rate is a union rate (current union negotiated rate for local), a survey rate (weighted average rate) or a union average rate (weighted union average rate).

#### Union Rate Identifiers

A four letter classification abbreviation identifier enclosed in dotted lines beginning with characters other than ""SU"" or ""UAVG"" denotes that the union classification and rate were prevailing for that classification in the survey. Example: PLUM0198-005 07/01/2014. PLUM is an abbreviation identifier of the union which prevailed in the survey for this classification, which in this example would be Plumbers. 0198 indicates the local union number or district council number where applicable, i.e., Plumbers Local 0198. The next number, 005 in the example, is an internal number used in processing the wage determination. 07/01/2014 is the effective date of the most current negotiated rate, which in this example is July 1, 2014.

Union prevailing wage rates are updated to reflect all rate changes in the collective bargaining agreement (CBA) governing this classification and rate.

#### Survey Rate Identifiers

Classifications listed under the ""SU"" identifier indicate that no one rate prevailed for this classification in the survey and the published rate is derived by computing a weighted average rate based on all the rates reported in the survey for that classification. As this weighted average rate includes all rates reported in the survey, it may include both union and non-union rates. Example: SULA2012-007 5/13/2014. SU indicates the rates are survey rates based on a weighted average calculation of rates and are not majority rates. LA indicates the State of Louisiana. 2012 is the year of survey on which these classifications and rates are based. The next number, 007 in the example, is an internal number used in producing the wage determination. 5/13/2014 indicates the survey completion date for the classifications and rates under that identifier.

Survey wage rates are not updated and remain in effect until a new survey is conducted.

#### Union Average Rate Identifiers

Classification(s) listed under the UAVG identifier indicate that no single majority rate prevailed for those classifications; however, 100% of the data reported for the classifications was union data. EXAMPLE: UAVG-OH-0010 08/29/2014. UAVG indicates that the rate is a weighted union average rate. OH indicates the state. The next number, 0010 in the example, is an internal number used in producing the wage determination. 08/29/2014 indicates the survey completion date for the classifications and rates under that identifier.

A UAVG rate will be updated once a year, usually in January of each year, to reflect a weighted average of the current negotiated/CBA rate of the union locals from which the rate is based.

-----  
WAGE DETERMINATION APPEALS PROCESS

1.) Has there been an initial decision in the matter? This can be:

- \* an existing published wage determination
- \* a survey underlying a wage determination
- \* a Wage and Hour Division letter setting forth a position on a wage determination matter
- \* a conformance (additional classification and rate) ruling

On survey related matters, initial contact, including requests for summaries of surveys, should be with the Wage and Hour Regional Office for the area in which the survey was conducted because those Regional Offices have responsibility for the Davis-Bacon survey program. If the response from this initial contact is not satisfactory, then the process described in 2.) and 3.) should be followed.

With regard to any other matter not yet ripe for the formal process described here, initial contact should be with the Branch of Construction Wage Determinations. Write to:

Branch of Construction Wage Determinations  
Wage and Hour Division  
U.S. Department of Labor  
200 Constitution Avenue, N.W.  
Washington, DC 20210

2.) If the answer to the question in 1.) is yes, then an interested party (those affected by the action) can request review and reconsideration from the Wage and Hour Administrator (See 29 CFR Part 1.8 and 29 CFR Part 7). Write to:

Wage and Hour Administrator  
U.S. Department of Labor  
200 Constitution Avenue, N.W.  
Washington, DC 20210

The request should be accompanied by a full statement of the interested party's position and by any information (wage payment data, project description, area practice material, etc.) that the requestor considers relevant to the issue.

3.) If the decision of the Administrator is not favorable, an interested party may appeal directly to the Administrative Review Board (formerly the Wage Appeals Board). Write to:

Administrative Review Board  
U.S. Department of Labor  
200 Constitution Avenue, N.W.  
Washington, DC 20210

4.) All decisions by the Administrative Review Board are final.

=====  
END OF GENERAL DECISION"

Fringe benefit amounts are applicable for all hours worked except when otherwise noted.

No laborer, workman or mechanic shall be paid at a rate less than that of a Journeyman except those classified as bona fide apprentices.

Apprentices or trainees shall be permitted to work as such subject to Administrative Regulations adopted by the Commissioner of Workplace Standards. Copies of these regulations will be furnished upon request from any interested person.

Before using apprentices on the job the contractor shall present to the Contracting Officer written evidence of registration of such employees in a program of a State apprenticeship and training agency approved and recognized by the U. S. Bureau of Apprenticeship and Training. In the absence of such a State agency, the contractor shall submit evidence of approval and registration by the U. S. Bureau of Apprenticeship and Training.

The contractor shall submit to the Contracting Officer, written evidence of the established apprenticeship-journeyman ratios and wage rates in the project area, which will be the basis for establishing such ratios and rates for the project under the applicable contract provisions.

**TO: EMPLOYERS/EMPLOYEES**

**PREVAILING WAGE SCHEDULE:**

**The wages indicated on this wage schedule are the least permitted to be paid for the occupations indicated. When an employee works in more than one classification, the employer must record the number of hours worked in each classification at the prescribed hourly base rate.**

**OVERTIME:**

**Overtime is to be paid to an employee at a rate not less than one and one-half times the basic rate of pay for all hours worked in excess of forty (40) hours in such workweek. Wage violations or questions should be directed to the designated Engineer or the undersigned.**

Director  
Division of Construction Procurement  
Frankfort, Kentucky 40622  
502-564-3500

**NOTICE OF REQUIREMENT FOR AFFIRMATIVE ACTION  
TO ENSURE EQUAL EMPLOYMENT OPPORTUNITY  
(Executive Order 11246)**

1. The Offeror's or Bidder's attention is called to the "Equal Opportunity Clause" and the "Standard Federal Equal Employment Specifications" set forth herein.
2. The goals and timetables for minority and female participation, expressed in percentage terms for the Contractor's aggregate work force in each trade on all construction work in the covered area, are as follows:

<b>GOALS FOR MINORITY PARTICIPATION IN EACH TRADE</b>	<b>GOALS FOR FEMALE PARTICIPATION IN EACH TRADE</b>
12.0%	6.9%

These goals are applicable to all the Contractor's construction work (whether or not it is Federal or federally-assisted) performed in the covered area. If the contractor performs construction work in a geographical area located outside of the covered area, it shall apply the goals established for such geographical area where the work is actually performed. With regard to this second area, the contractor also is subject to the goals for both its federally involved and non-federally involved construction.

The Contractor's compliance with the Executive Order and the regulations in CFR Part 60-4 shall be based on its implementation of the Equal Opportunity Clause, specific affirmative action obligations required by the specifications set forth in 41 CFR 60-4, 3(a), and its efforts to meet the goals. The hours of minority and female employment and training must be substantially uniform throughout the length of the contract, and in each trade, and the contractor shall make a good faith effort to employ minorities and women evenly on each of its projects. The transfer of minority or female employees or trainees from Contractor to Contractor or from project to project for the sole purpose of meeting the Contractor's goals shall be a violation of the contract, the Executive Order and the regulations in 41 CFR Part 60-4. Compliance with the goals will be measured against the total work hours performed.

3. The Contractor shall provide written notification to the Director of the Office of Federal Contract Compliance Programs within ten (10) working days of award of any construction subcontract in excess of \$10,000.00 at any tier for construction work under the contract resulting from this solicitation. The notification shall list the name, address and telephone number of the subcontractor; employer identification number of the subcontractor; estimated dollar amount of the subcontract; estimated starting and completion dates of the subcontract; and the geographical area in which the subcontract is to be performed. The notification shall be mailed to:

**Evelyn Teague, Regional Director  
Office of Federal Contract Compliance Programs  
61 Forsyth Street, SW, Suite 7B75  
Atlanta, Georgia 30303-8609**

4. As used in this Notice, and in the contract resulting from this solicitation, the "**covered area**" is Warren County.

**PART IV**  
**INSURANCE**

Refer to  
*Kentucky Standard Specifications for Road and Bridge Construction,*  
current edition

**PART V**  
**BID ITEMS**



### PROPOSAL BID ITEMS

201027

Page 1 of 7

Report Date 8/28/20

#### Section: 0001 - PAVING

LINE	BID CODE	ALT	DESCRIPTION	QUANTITY	UNIT	UNIT PRIC	FP	AMOUNT
0010	00003		CRUSHED STONE BASE	16,304.00	TON		\$	
0020	00100		ASPHALT SEAL AGGREGATE	164.00	TON		\$	
0030	00103		ASPHALT SEAL COAT	20.00	TON		\$	
0040	00190		LEVELING & WEDGING PG64-22	1,460.00	TON		\$	
0050	00212		CL2 ASPH BASE 1.00D PG64-22	4,613.00	TON		\$	
0060	00214		CL3 ASPH BASE 1.00D PG64-22	4,490.00	TON		\$	
0070	00216		CL3 ASPH BASE 1.00D PG76-22	2,713.00	TON		\$	
0080	00301		CL2 ASPH SURF 0.38D PG64-22	2,066.00	TON		\$	
0090	00336		CL3 ASPH SURF 0.38A PG76-22	2,998.00	TON		\$	
0100	00388		CL3 ASPH SURF 0.38B PG64-22	1,708.00	TON		\$	
0110	02604		FABRIC-GEOTEXTILE CLASS 1A	43,982.00	SQYD		\$	
0120	02676		MOBILIZATION FOR MILL & TEXT	1.00	LS		\$	
0130	02677		ASPHALT PAVE MILLING & TEXTURING	2,332.00	TON		\$	
0140	20071EC		JOINT ADHESIVE	27,072.00	LF		\$	
0150	24970EC		ASPHALT MATERIAL FOR TACK NON-TRACKING	34.00	TON		\$	

#### Section: 0002 - ROADWAY

LINE	BID CODE	ALT	DESCRIPTION	QUANTITY	UNIT	UNIT PRIC	FP	AMOUNT
0160	00078		CRUSHED AGGREGATE SIZE NO 2	36,460.00	TON		\$	
0170	01000		PERFORATED PIPE-4 IN	776.00	LF		\$	
0180	01010		NON-PERFORATED PIPE-4 IN	128.00	LF		\$	
0190	01020		PERF PIPE HEADWALL TY 1-4 IN	7.00	EACH		\$	
0200	01024		PERF PIPE HEADWALL TY 2-4 IN	1.00	EACH		\$	
0210	01028		PERF PIPE HEADWALL TY 3-4 IN	4.00	EACH		\$	
0220	01718		REMOVE INLET	4.00	EACH		\$	
0230	01825		ISLAND CURB AND GUTTER	40.00	LF		\$	
0240	01891		ISLAND HEADER CURB TYPE 2	50.00	LF		\$	
0250	01982		DELINEATOR FOR GUARDRAIL MONO DIRECTIONAL WHITE	66.00	EACH		\$	
0260	01983		DELINEATOR FOR GUARDRAIL MONO DIRECTIONAL YELLOW	6.00	EACH		\$	
0270	01985		DELINEATOR FOR BARRIER - YELLOW	46.00	EACH		\$	
0280	01987		DELINEATOR FOR GUARDRAIL BI DIRECTIONAL WHITE	24.00	EACH		\$	
0290	01990		DELINEATOR FOR BARRIER WALL-B/W	8.00	EACH		\$	
0300	02014		BARRICADE-TYPE III	12.00	EACH		\$	
0310	02091		REMOVE PAVEMENT	5,010.00	SQYD		\$	
0320	02159		TEMP DITCH	5,466.00	LF		\$	
0330	02160		CLEAN TEMP DITCH	2,733.00	LF		\$	
0340	02223		GRANULAR EMBANKMENT	14.00	CUYD		\$	
0350	02230		EMBANKMENT IN PLACE	90,488.00	CUYD		\$	
0360	02262		FENCE-WOVEN WIRE TYPE 1	1,495.00	LF		\$	
0370	02268		REMOVE & REPLACE FENCE	445.00	LF		\$	
0380	02351		GUARDRAIL-STEEL W BEAM-S FACE	6,112.50	LF		\$	

**PROPOSAL BID ITEMS**

201027

Page 2 of 7

Report Date 8/28/20

LINE	BID CODE	ALT	DESCRIPTION	QUANTITY	UNIT	UNIT PRIC	FP	AMOUNT
0390	02363		GUARDRAIL CONNECTOR TO BRIDGE END TY A	4.00	EACH		\$	
0400	02364		GUARDRAIL TERMINAL SECTION NO 2	1.00	EACH		\$	
0410	02367		GUARDRAIL END TREATMENT TYPE 1	12.00	EACH		\$	
0420	02369		GUARDRAIL END TREATMENT TYPE 2A	11.00	EACH		\$	
0430	02381		REMOVE GUARDRAIL	5,756.00	LF		\$	
0440	02397		TEMP GUARDRAIL	1,162.50	LF		\$	
0450	02429		RIGHT-OF-WAY MONUMENT TYPE 1	2.00	EACH		\$	
0460	02432		WITNESS POST	2.00	EACH		\$	
0470	02469		CLEAN SINKHOLE	1.00	EACH		\$	
0480	02483		CHANNEL LINING CLASS II	8,070.00	TON		\$	
0490	02484		CHANNEL LINING CLASS III	166.00	TON		\$	
0500	02545		CLEARING AND GRUBBING 50 ACRES	1.00	LS		\$	
0510	02555		CONCRETE-CLASS B	6.30	CUYD		\$	
0520	02562		TEMPORARY SIGNS	750.00	SQFT		\$	
0530	02602		FABRIC-GEOTEXTILE CLASS 1	60,820.00	SQYD		\$	
0540	02603		FABRIC-GEOTEXTILE CLASS 2	15,170.00	SQYD		\$	
0550	02650		MAINTAIN & CONTROL TRAFFIC DIVERSIONS (BY-PASS DETOURS) NO. 1	1.00	LS		\$	
0560	02651		DIVERSIONS (BY-PASS DETOURS) NO. 2	1.00	LS		\$	
0570	02651		DIVERSIONS (BY-PASS DETOURS) NO. 3	1.00	LS		\$	
0580	02651		DIVERSIONS (BY-PASS DETOURS) NO. 4	1.00	LS		\$	
0590	02651		PORTABLE CHANGEABLE MESSAGE SIGN	6.00	EACH		\$	
0600	02671		SAFELOADING	5.10	CUYD		\$	
0610	02690		SHOULDER RUMBLE STRIPS	27,198.00	LF		\$	
0620	02696		TEMP SILT FENCE	5,466.00	LF		\$	
0630	02701		SILT TRAP TYPE A	50.00	EACH		\$	
0640	02703		SILT TRAP TYPE B	50.00	EACH		\$	
0650	02704		SILT TRAP TYPE C	50.00	EACH		\$	
0660	02705		CLEAN SILT TRAP TYPE A	50.00	EACH		\$	
0670	02706		CLEAN SILT TRAP TYPE B	50.00	EACH		\$	
0680	02707		CLEAN SILT TRAP TYPE C	50.00	EACH		\$	
0690	02708		STAKING	1.00	LS		\$	
0700	02726		REMOVE STRUCTURE RCBC STA 305+30	1.00	LS		\$	
0710	02731		REMOVE STRUCTURE RCBC STA 409+90	1.00	LS		\$	
0720	02731		REMOVE STRUCTURE STA 111+00	1.00	LS		\$	
0730	02731		ARROW PANEL	4.00	EACH		\$	
0740	02775		CONCRETE BARRIER WALL TYPE 9T	1,320.00	LF		\$	
0750	03171		TEMP RELOCATION OF SIGNAL HEAD	10.00	EACH		\$	
0760	04953		EROSION CONTROL BLANKET	1,561.00	SQYD		\$	
0770	05950		TEMP MULCH	74,057.00	SQYD		\$	
0780	05952		TEMP SEEDING AND PROTECTION	55,541.00	SQYD		\$	
0790	05953		INITIAL FERTILIZER	5.30	TON		\$	
0800	05963		MAINTENANCE FERTILIZER	5.30	TON		\$	
0810	05964							

**PROPOSAL BID ITEMS**

201027

Page 3 of 7

Report Date 8/28/20

LINE	BID CODE	ALT	DESCRIPTION	QUANTITY	UNIT	UNIT PRIC	FP	AMOUNT
0820	05985		SEEDING AND PROTECTION	96,442.00	SQYD		\$	
0830	05992		AGRICULTURAL LIMESTONE	60.90	TON		\$	
0840	06401		FLEXIBLE DELINEATOR POST-M/W	65.00	EACH		\$	
0850	06404		FLEXIBLE DELINEATOR POST-M/Y	39.00	EACH		\$	
0860	06510		PAVE STRIPING-TEMP PAINT-4 IN	31,695.00	LF		\$	
0870	06511		PAVE STRIPING-TEMP PAINT-6 IN	39,088.00	LF		\$	
0880	06542		PAVE STRIPING-THERMO-6 IN W	21,557.00	LF		\$	
0890	06543		PAVE STRIPING-THERMO-6 IN Y YELLOW	27,072.00	LF		\$	
0900	06546		PAVE STRIPING-THERMO-12 IN W	2,874.00	LF		\$	
0910	06547		PAVE STRIPING-THERMO-12 IN Y	114.00	LF		\$	
0920	06549		PAVE STRIPING-TEMP REM TAPE-B WHITE	882.00	LF		\$	
0930	06550		PAVE STRIPING-TEMP REM TAPE-W	882.00	LF		\$	
0940	06551		PAVE STRIPING-TEMP REM TAPE-Y	882.00	LF		\$	
0950	06556		PAVE STRIPING-DUR TY 1-6 IN W	1,256.00	LF		\$	
0960	06557		PAVE STRIPING-DUR TY 1-6 IN Y	682.00	LF		\$	
0970	06568		PAVE MARKING-THERMO STOP BAR-24IN	197.00	LF		\$	
0980	06569		PAVE MARKING-THERMO CROSS-HATCH	3,255.00	SQFT		\$	
0990	06574		PAVE MARKING-THERMO CURV ARROW	21.00	EACH		\$	
1000	06575		PAVE MARKING-THERMO COMB ARROW	3.00	EACH		\$	
1010	06585		PAVEMENT MARKER TY IVA-MW TEMP	164.00	EACH		\$	
1020	06586		PAVEMENT MARKER TY IVA-MY TEMP	164.00	EACH		\$	
1030	06600		REMOVE PAVEMENT MARKER TYPE V	94.00	EACH		\$	
1040	08901		CRASH CUSHION TY VI CLASS BT TL2	3.00	EACH		\$	
1050	10020NS		FUEL ADJUSTMENT	65,837.00	DOLL	\$1.00	\$	\$65,837.00
1060	10030NS		ASPHALT ADJUSTMENT	78,380.00	DOLL	\$1.00	\$	\$78,380.00
1070	20191ED		OBJECT MARKER TY 3	10.00	EACH		\$	
1080	20208NC		PAVE MARK-PAINT ARROWS "- TEMP"	50.00	EACH		\$	
1090	20458ES403		CENTERLINE RUMBLE STRIPS	2,361.00	LF		\$	
1100	21289ED		LONGITUDINAL EDGE KEY	10,422.00	LF		\$	
1110	23010EN		PAVE MARK TEMP PAINT STOP BAR-24 IN	332.00	LF		\$	
1120	23131ER701		PIPELINE VIDEO INSPECTION	454.00	LF		\$	
1130	23157EN		TRAFFIC SIGNAL POLE BASE	3.20	CUYD		\$	
1140	23270ES717		PAVE MARK TY 1 TAPE-CURV ARROW	4.00	EACH		\$	
1150	24489EC		INLAID PAVEMENT MARKER	533.00	EACH		\$	
1160	24605ED		RELOCATE (TRAFFIC SIGNAL POLE & CONTROLLER)	1.00	EACH		\$	
1170	24679ED		PAVE MARK THERMO CHEVRON	558.00	SQFT		\$	
1180	24683ED		PAVE MARKING-THERMO DOTTED LANE EXTEN	345.00	LF		\$	

**Section: 0003 - DRAINAGE**

LINE	BID CODE	ALT	DESCRIPTION	QUANTITY	UNIT	UNIT PRIC	FP	AMOUNT
1190	00461		CULVERT PIPE-15 IN	14.00	LF		\$	
1200	00462		CULVERT PIPE-18 IN	59.00	LF		\$	
1210	00464		CULVERT PIPE-24 IN	44.00	LF		\$	
1220	00468		CULVERT PIPE-36 IN	28.00	LF		\$	

**PROPOSAL BID ITEMS**

201027

Page 4 of 7

Report Date 8/28/20

LINE	BID CODE	ALT	DESCRIPTION	QUANTITY	UNIT	UNIT PRIC	FP	AMOUNT
1230	00469		CULVERT PIPE-42 IN	55.00	LF		\$	
1240	00521		STORM SEWER PIPE-15 IN	12.00	LF		\$	
1250	00522		STORM SEWER PIPE-18 IN	120.00	LF		\$	
1260	00524		STORM SEWER PIPE-24 IN	178.00	LF		\$	
1270	01204		PIPE CULVERT HEADWALL-18 IN	1.00	EACH		\$	
1280	01208		PIPE CULVERT HEADWALL-24 IN	1.00	EACH		\$	
1290	01310		REMOVE PIPE	25.00	LF		\$	
1300	01396		METAL END SECTION TY 3-42 IN	2.00	EACH		\$	
1310	01432		SLOPED BOX OUTLET TYPE 1-15 IN	2.00	EACH		\$	
1320	01450		S & F BOX INLET-OUTLET-18 IN	2.00	EACH		\$	
1330	01451		S & F BOX INLET-OUTLET-24 IN	3.00	EACH		\$	
1340	01453		S & F BOX INLET-OUTLET-36 IN	1.00	EACH		\$	
1350	01484		CURB BOX INLET TYPE B-T	2.00	EACH		\$	
1360	01511		DROP BOX INLET TYPE 5D	2.00	EACH		\$	
1370	02607		FABRIC-GEOTEXTILE CLASS 2 FOR PIPE	742.00	SQYD	\$2.00	\$	\$1,484.00
1380	02625		REMOVE HEADWALL	6.00	EACH		\$	
1390	08100		CONCRETE-CLASS A	6.00	CUYD		\$	

**Section: 0004 - BRIDGE-18119**

LINE	BID CODE	ALT	DESCRIPTION	QUANTITY	UNIT	UNIT PRIC	FP	AMOUNT
1400	02006		REMOVE CONCRETE MEDIAN US 231 BRIDGE REHABILITATION	290.00	LF		\$	
1410	02008		REMOVE ASPHALT MEDIAN	200.00	LF		\$	
1420	03298		EXPAN JOINT REPLACE 4 IN	203.00	LF		\$	
1430	03299		ARMORED EDGE FOR CONCRETE	203.00	LF		\$	
1440	03304		BRIDGE OVERLAY APPROACH PAVEMENT	1,956.00	SQYD		\$	
1450	04795		CONDUIT-2 IN	632.00	LF		\$	
1460	04810		ELECTRICAL JUNCTION BOX PKWY STA. 1312+04.70 EX. 16X6 RCBC EXTENSION	4.00	EACH		\$	
1470	08151		STEEL REINFORCEMENT-EPOXY COATED	1,356.00	LB		\$	
1480	08504		EPOXY SAND SLURRY	124.00	SQYD		\$	
1490	08526		CONC CLASS M FULL DEPTH PATCH	32.00	CUYD		\$	
1500	08534		CONCRETE OVERLAY-LATEX	157.40	CUYD		\$	
1510	08549		BLAST CLEANING	2,892.00	SQYD		\$	
1520	08551		MACHINE PREP OF SLAB	2,834.00	SQYD		\$	
1530	23032EN		BRIDGE BARRIER RETROFIT	628.00	LF		\$	
1540	23378EC		CONCRETE SEALING PKWY STA. 1325+74.18 EX. 14X5 RCBC EXTENSION	28,260.00	SQFT		\$	
1550	24094EC		PARTIAL DEPTH PATCHING RAMP D STA. 412+01.00 PROPOSED 16X6 RCBC	40.00	CUYD		\$	

**Section: 0005 - BRIDGE-CULVERT-27799**

LINE	BID CODE	ALT	DESCRIPTION	QUANTITY	UNIT	UNIT PRIC	FP	AMOUNT
1560	08002		STRUCTURE EXCAV-SOLID ROCK	168.40	CUYD		\$	

**PROPOSAL BID ITEMS**

201027

Page 5 of 7

Report Date 8/28/20

LINE	BID CODE	ALT	DESCRIPTION	QUANTITY	UNIT	UNIT PRIC	FP	AMOUNT
1570	08003		FOUNDATION PREPARATION	1.00	LS		\$	
1580	08100		CONCRETE-CLASS A	511.00	CUYD		\$	
1590	08150		STEEL REINFORCEMENT	70,256.00	LB		\$	

**Section: 0006 - BRIDGE-CULVERT-27800**

LINE	BID CODE	ALT	DESCRIPTION	QUANTITY	UNIT	UNIT PRIC	FP	AMOUNT
1600	02403		REMOVE CONCRETE MASONRY	21.50	CUYD		\$	
1610	08002		STRUCTURE EXCAV-SOLID ROCK	97.10	CUYD		\$	
1620	08003		FOUNDATION PREPARATION	1.00	LS		\$	
1630	08100		CONCRETE-CLASS A	202.80	CUYD		\$	
1640	08150		STEEL REINFORCEMENT	31,811.00	LB		\$	

**Section: 0007 - BRIDGE-CULVERT-27801**

LINE	BID CODE	ALT	DESCRIPTION	QUANTITY	UNIT	UNIT PRIC	FP	AMOUNT
1650	02403		REMOVE CONCRETE MASONRY	23.20	CUYD		\$	
1660	08003		FOUNDATION PREPARATION	1.00	LS		\$	
1670	08100		CONCRETE-CLASS A	158.20	CUYD		\$	
1680	08150		STEEL REINFORCEMENT	22,336.00	LB		\$	

**Section: 0008 - SEWER**

LINE	BID CODE	ALT	DESCRIPTION	QUANTITY	UNIT	UNIT PRIC	FP	AMOUNT
1690	02220		FLOWABLE FILL	50.00	CUYD		\$	
1700	02268		REMOVE & REPLACE FENCE	20.00	LF		\$	
1710	02690		SAFELOADING	3.00	CUYD		\$	
1720	15000		S BYPASS PUMPING	1.00	EACH		\$	
1730	15013		S ENCASEMENT SPECIAL	160.00	LF		\$	
1740	15025		S ENCASEMENT STEEL OPEN CUT RANGE 6	50.00	LF		\$	
1750	15092		S MANHOLE	2.00	EACH		\$	
1760	15093		S MANHOLE ABANDON/REMOVE	3.00	EACH		\$	
1770	15094		S MANHOLE ADJUST TO GRADE	17.00	EACH		\$	
1780	15099		S MANHOLE TAP EXISTING	1.00	EACH		\$	
1790	15108		S PIPE DUCTILE IRON 20 INCH	60.00	LF		\$	
1800	15108		S PIPE DUCTILE IRON 20 INCH WITHIN 42 IN STEEL CASTING PIPE	210.00	LF		\$	
1810	15113		S PIPE PVC 10 INCH	365.00	LF		\$	
1820	15118		S PIPE SPECIAL	2.00	LF		\$	
1830	15120		S SPECIAL ITEM	110.00	EACH		\$	
1840	21234ED		ASPHALT PAVING REPLACEMENT	30.00	SQYD		\$	
1850	21741NC		MAINTAIN & CONTROL TRAFFIC	1.00	EACH		\$	

**Section: 0009 - SIGNING**

**PROPOSAL BID ITEMS**

201027

Page 6 of 7

Report Date 8/28/20

LINE	BID CODE	ALT	DESCRIPTION	QUANTITY	UNIT	UNIT PRIC	FP	AMOUNT
1860	06227		REMOVE SIGN BR ATTACH BRACKETS	1.00	EACH		\$	
1870	06400		GMSS GALV STEEL TYPE A	5,124.00	LB		\$	
1880	06405		SBM ALUMINUM PANEL SIGNS	1,887.00	SQFT		\$	
1890	06406		SBM ALUM SHEET SIGNS .080 IN	421.00	SQFT		\$	
1900	06407		SBM ALUM SHEET SIGNS .125 IN	413.00	SQFT		\$	
1910	06410		STEEL POST TYPE 1	1,412.00	LF		\$	
1920	06412		STEEL POST MILE MARKERS	2.00	EACH		\$	
1930	06441		GMSS GALV STEEL TYPE C	4,927.00	LB		\$	
1940	06451		REMOVE SIGN SUPPORT BEAM	19.00	EACH		\$	
1950	06490		CLASS A CONCRETE FOR SIGNS	38.80	CUYD		\$	
1960	06491		STEEL REINFORCEMENT FOR SIGNS	1,100.00	LB		\$	
1970	20418ED		REMOVE & RELOCATE SIGNS	1.00	EACH		\$	
1980	20419ND		ROADWAY CROSS SECTION	9.00	EACH		\$	
1990	21373ND		REMOVE SIGN	8.00	EACH		\$	
2000	21596ND		GMSS TYPE D	6.00	EACH		\$	
2010	24631EC		BARCODE SIGN INVENTORY	153.00	EACH		\$	

**Section: 0010 - SIGNALIZATION**

LINE	BID CODE	ALT	DESCRIPTION	QUANTITY	UNIT	UNIT PRIC	FP	AMOUNT
2020	04792		CONDUIT-1 IN	17.00	LF		\$	
2030	04811		ELECTRICAL JUNCTION BOX TYPE B	3.00	EACH		\$	
2040	04820		TRENCHING AND BACKFILLING	420.00	LF		\$	
2050	04830		LOOP WIRE	1,120.00	LF		\$	
2060	04844		CABLE-NO. 14/5C	680.00	LF		\$	
2070	04850		CABLE-NO. 14/1 PAIR	2,330.00	LF		\$	
2080	04886		MESSENGER-15400 LB	540.00	LF		\$	
2090	04895		LOOP SAW SLOT AND FILL	370.00	LF		\$	
2100	04932		INSTALL STEEL STRAIN POLE	4.00	EACH		\$	
2110	20094ES835		TEMP RELOCATION OF SIGNAL HEAD	16.00	EACH		\$	
2120	20188NS835		INSTALL LED SIGNAL-3 SECTION	8.00	EACH		\$	
2130	20390NS835		INSTALL COORDINATING UNIT	1.00	EACH		\$	
2140	23157EN		TRAFFIC SIGNAL POLE BASE	24.00	CUYD		\$	
2150	24601EC		INSTALL RADAR ADVANCE DETECTOR TYPE B	1.00	EACH		\$	
2160	24901EC		PVC CONDUIT-2 IN-SCHEDULE 80	403.00	LF		\$	
2170	24908EC		INSTALL SIGNAL CONTROLLER-TY ATC	1.00	EACH		\$	
2180	24955ED		REMOVE SIGNAL EQUIPMENT	1.00	EACH		\$	

**Section: 0011 - LIGHTING**

LINE	BID CODE	ALT	DESCRIPTION	QUANTITY	UNIT	UNIT PRIC	FP	AMOUNT
2190	04710		POLE 80 FT MTG HT HIGH MAST	2.00	EACH		\$	
2200	04711		POLE 90 FT MTG HT HIGH MAST	8.00	EACH		\$	
2210	04712		POLE 100 FT MTG HT HIGH MAST	2.00	EACH		\$	
2220	04740		POLE BASE	6.00	EACH		\$	
2230	04750		TRANSFORMER BASE	6.00	EACH		\$	

**PROPOSAL BID ITEMS**

201027

Page 7 of 7

Report Date 8/28/20

LINE	BID CODE	ALT	DESCRIPTION	QUANTITY	UNIT	UNIT PRIC	FP	AMOUNT
2240	04760		POLE W/SECONDARY CONTROL EQUIP	1.00	EACH		\$	
2250	04761		LIGHTING CONTROL EQUIPMENT	1.00	EACH		\$	
2260	04780		FUSED CONNECTOR KIT	46.00	EACH		\$	
2270	04793		CONDUIT-1 1/4 IN	3,220.00	LF		\$	
2280	04795		CONDUIT-2 IN	1,675.00	LF		\$	
2290	04797		CONDUIT-3 IN	2,365.00	LF		\$	
2300	04800		MARKER	22.00	EACH		\$	
2310	04820		TRENCHING AND BACKFILLING	11,380.00	LF		\$	
2320	04821		OPEN CUT ROADWAY	740.00	LF		\$	
2330	04832		WIRE-NO. 12	3,450.00	LF		\$	
2340	04940		REMOVE LIGHTING	1.00	LS		\$	
2350	04942		REMOVE STORE & REINSTALL POLE	6.00	EACH		\$	
2360	20391NS835		ELECTRICAL JUNCTION BOX TYPE A	19.00	EACH		\$	
2370	20392NS835		ELECTRICAL JUNCTION BOX TYPE C	6.00	EACH		\$	
2380	20410ED		MAINTAIN LIGHTING	1.00	LS		\$	
2390	21543EN		BORE AND JACK CONDUIT	1,570.00	LF		\$	
2400	23161EN		POLE BASE-HIGH MAST	109.00	CUYD		\$	
2410	23778EC		WIRE-NO. 10	16,770.00	LF		\$	
2420	24589ED		LED LUMINAIRE	23.00	EACH		\$	
2430	24749EC		HIGH MAST LED LUMINAIRE	52.00	EACH		\$	
2440	24851EC		CABLE-NO. 10/3C DUCTED	15,225.00	LF		\$	

**Section: 0012 - DEMOBILIZATION &/OR MOBILIZATION**

LINE	BID CODE	ALT	DESCRIPTION	QUANTITY	UNIT	UNIT PRIC	FP	AMOUNT
2450	02568		MOBILIZATION	1.00	LS		\$	
2460	02569		DEMOBILIZATION	1.00	LS		\$	