



**CALL NO. 100**

**CONTRACT ID. 191048**

**MAGOFFIN COUNTY**

**FED/STATE PROJECT NUMBER NHPP 0061 (076)**

**DESCRIPTION BERT T. COMBS MOUNTAIN PARKWAY(PW-9009)**

**WORK TYPE GRADE, DRAIN & SURFACE WITH BRIDGE**

**PRIMARY COMPLETION DATE 380 WORKING DAYS**

**LETTING DATE: August 23,2019**

Sealed Bids will be received electronically through the Bid Express bidding service until 10:00 AM EASTERN DAYLIGHT TIME August 23,2019. Bids will be publicly announced at 10:00 AM EASTERN DAYLIGHT TIME.

**PLANS AVAILABLE FOR THIS PROJECT.**

**DBE CERTIFICATION REQUIRED - 6%**

**REQUIRED BID PROPOSAL GUARANTY:** Not less than 5% of the total bid.

## TABLE OF CONTENTS

<b>PART I</b>	<b>SCOPE OF WORK</b>
	<ul style="list-style-type: none"><li>• PROJECT(S), COMPLETION DATE(S), &amp; LIQUIDATED DAMAGES</li><li>• CONTRACT NOTES</li><li>• FEDERAL CONTRACT NOTES</li><li>• TRAINEES</li><li>• SIGNIFICANT PROJECT -PROJECT TRAFFIC COORDINATOR</li><li>• ASPHALT MIXTURE</li><li>• INCIDENTAL SURFACING</li><li>• FUEL AND ASPHALT PAY ADJUSTMENT</li><li>• ASPHALT PAVEMENT RIDE QUALITY CAT A</li><li>• COMPACTION OPTION A</li><li>• MATERIAL TRANSFER VEHICLE (MTV)</li><li>• SPECIAL NOTE(S) APPLICABLE TO PROJECT</li><li>• TREE REMOVAL</li><li>• SPECIAL NOTE FOR PIPELINE INSPECTION</li><li>• SPECIAL NOTE FOR INTELLIGENT COMPACTION FOR ASPHALT MIXTURES</li><li>• SPECIAL NOTE FOR INTELLIGENT COMPACTION FOR AGGREGATE BASES AND SOILS</li><li>• SPECIAL NOTE FOR PAVER MOUNTED TEMPERATURE PROFILES</li><li>• BRIDGE DEMOLITION, RENOVATION</li><li>• ASBESTOS ABATEMENT REPORT</li><li>• RIGHT OF WAY NOTES</li><li>• UTILITY IMPACT &amp; RAIL CERTIFICATION NOTES</li><li>• GENERAL UTILITY NOTES</li><li>• WATER STANDARD UTILITY BID ITEMS</li><li>• WATERLINE SPECIFICATIONS</li><li>• DEPT OF ARMY - NATIONWIDE PERMIT</li><li>• KPDES STORM WATER PERMIT, BMP AND ENOI</li><li>• COMMUNICATING ALL PROMISES</li><li>• GUARDRAIL DELIVERY VERIFICATION SHEET</li></ul>
<b>PART II</b>	<b>SPECIFICATIONS AND STANDARD DRAWINGS</b>
	<ul style="list-style-type: none"><li>• SPECIFICATIONS REFERENCE</li><li>• SUPPLEMENTAL SPECIFICATION</li><li>• [SN-1I] PORTABLE CHANGEABLE SIGNS</li><li>• [SN-6U] STRUCTURAL MASS CONCRETE</li><li>• [SN-11C] DRILLED SHAFTS</li><li>• [SN-11D] ROCK BLASTING</li><li>• [SN-11E] BORING AND JACKING STEEL PIPE WITHOUT CARRIER PIPE</li><li>• [SN-11F] TURF REINFORCEMENT MAT</li><li>• [SN-11M] BARCODE LABEL ON PERMANENT SIGNS</li><li>• [SP-69] EMBANKMENT AT BRIDGE END BENT STRUCTURES</li></ul>
<b>PART III</b>	<b>EMPLOYMENT, WAGE AND RECORD REQUIREMENTS</b>
	<ul style="list-style-type: none"><li>• FEDERAL-AID CONSTRUCTION CONTRACTS - FHWA 1273</li><li>• NONDISCRIMINATION OF EMPLOYEES</li><li>• EXECUTIVE BRANCH CODE OF ETHICS</li><li>• TRAINING SPECIAL PROVISIONS</li><li>• PROJECT WAGE RATES LOCALITY 2 / FEDERAL</li></ul>

- NOTICE OF REQUIREMENT FOR AFFIRMATIVE ACTION TO ENSURE EEO  
MAGOFFIN

PART IV INSURANCE

PART V BID ITEMS

**PART I**  
**SCOPE OF WORK**

## ADMINISTRATIVE DISTRICT - 10

**CONTRACT ID - 191048**

**NHPP 0061 (076)**

**COUNTY - MAGOFFIN**

**PCN - DE07790091948**

**NHPP 0061 (076)**

BERT T. COMBS MOUNTAIN PARKWAY(PW-9009) (MP 65.000) MOUNTAIN PARKWAY CORRIDOR,WIDEN THE MOUNTAIN PARKWAY TO 4 LANES FROM 0.3 MILES WEST OF KY-3047(MP 65.0) TO 0.7 MILES WEST OF MIDDLE FORK LICKING RIVER BRIDGE(MP 69.6) (MP 69.600), A DISTANCE OF 04.16 MILES.GRADE, DRAIN & SURFACE WITH BRIDGE SYP NO. 10-00126.40.

GEOGRAPHIC COORDINATES LATITUDE 37:45:01.00 LONGITUDE 83:10:19.00

**COMPLETION DATE(S):**

380 WORKING Days

APPLIES TO ENTIRE CONTRACT

## **CONTRACT NOTES**

### **PROPOSAL ADDENDA**

All addenda to this proposal must be applied when calculating bid and certified in the bid packet submitted to the Kentucky Department of Highways. Failure to use the correct and most recent addenda may result in the bid being rejected.

### **BID SUBMITTAL**

Bidder must use the Department's electronic bidding software. The Bidder must download the bid file located on the Bid Express website ([www.bidx.com](http://www.bidx.com)) to prepare a bid packet for submission to the Department. The bidder must submit electronically using Bid Express.

### **JOINT VENTURE BIDDING**

Joint venture bidding is permissible. All companies in the joint venture must be prequalified in one of the work types in the Qualifications for Bidders for the project. The bidders must get a vendor ID for the joint venture from the Division of Construction Procurement and register the joint venture as a bidder on the project. Also, the joint venture must obtain a digital ID from Bid Express to submit a bid. A joint bid bond of 5% may be submitted for both companies or each company may submit a separate bond of 5%.

### **UNDERGROUND FACILITY DAMAGE PROTECTION**

The contractor shall make every effort to protect underground facilities from damage as prescribed in the Underground Facility Damage Protection Act of 1994, Kentucky Revised Statute KRS 367.4901 to 367.4917. It is the contractor's responsibility to determine and take steps necessary to be in compliance with federal and state damage prevention directives. When prescribed in said directives, the contractor shall submit Excavation Locate Requests to the Kentucky Contact Center (KY811) via web ticket entry. The submission of this request does not relieve the contractor from the responsibility of contacting non-member facility owners, whom shall be contacted through their individual Protection Notification Center. Non-compliance with these directives can result in the enforcement of penalties.

### **REGISTRATION WITH THE SECRETARY OF STATE BY A FOREIGN ENTITY**

Pursuant to KRS 176.085(1)(b), an agency, department, office, or political subdivision of the Commonwealth of Kentucky shall not award a state contract to a person that is a foreign entity required by [KRS 14A.9-010](#) to obtain a certificate of authority to transact business in the Commonwealth ("certificate") from the Secretary of State under [KRS 14A.9-030](#) unless the person produces the certificate within fourteen (14) days of the bid or proposal opening. If the foreign entity is not required to obtain a certificate as provided in [KRS 14A.9-010](#), the foreign entity should identify the applicable exception. Foreign entity is defined within [KRS 14A.1-070](#).

**For all foreign entities required to obtain a certificate of authority to transact business in the Commonwealth, if a copy of the certificate is not received by the contracting agency within the time frame identified above, the foreign entity's solicitation response shall be deemed non-responsive or the awarded contract shall be cancelled.**

Businesses can register with the Secretary of State at <https://secure.kentucky.gov/sos/ftbr/welcome.aspx>.

### **SPECIAL NOTE FOR PROJECT QUESTIONS DURING ADVERTISEMENT**

Questions about projects during the advertisement should be submitted in writing to the Division of Construction Procurement. This may be done by fax (502) 564-7299 or email to [kytc.projectquestions@ky.gov](mailto:kytc.projectquestions@ky.gov). The Department will attempt to answer all submitted questions. The Department reserves the right not to answer if the question is not pertinent or does not aid in clarifying the project intent.

The deadline for posting answers will be 3:00 pm Eastern Daylight Time, the day preceding the Letting. Questions may be submitted until this deadline with the understanding that the later a question is submitted, the less likely an answer will be able to be provided.

The questions and answers will be posted for each Letting under the heading "Questions & Answers" on the Construction Procurement website ([www.transportation.ky.gov/contract](http://www.transportation.ky.gov/contract)). The answers provided shall be considered part of this Special Note and, in case of a discrepancy, will govern over all other bidding documents.

### **HARDWOOD REMOVAL RESTRICTIONS**

The US Department of Agriculture has imposed a quarantine in Kentucky and several surrounding states, to prevent the spread of an invasive insect, the emerald ash borer. Hardwood cut in conjunction with the project may not be removed from the state. Chipping or burning on site is the preferred method of disposal.

### **INSTRUCTIONS FOR EXCESS MATERIAL SITES AND BORROW SITES**

Identification of excess material sites and borrow sites shall be the responsibility of the Contractor. The Contractor shall be responsible for compliance with all applicable state and federal laws and may wish to consult with the US Fish and Wildlife Service to seek protection under Section 10 of the Endangered Species Act for these activities.

### **ACCESS TO RECORDS**

The contractor, as defined in KRS 45A.030 (9) agrees that the contracting agency, the Finance and Administration Cabinet, the Auditor of Public Accounts, and the Legislative Research Commission, or their duly authorized representatives, shall have access to any books, documents, papers, records, or other evidence, which are directly pertinent to this contract for the purpose of financial audit or program review. Records and other prequalification information confidentially

disclosed as part of the bid process shall not be deemed as directly pertinent to the contract and shall be exempt from disclosure as provided in KRS 61.878(1)(c). The contractor also recognizes that any books, documents, papers, records, or other evidence, received during a financial audit or program review shall be subject to the Kentucky Open Records Act, KRS 61.870 to 61.884.

In the event of a dispute between the contractor and the contracting agency, Attorney General, or the Auditor of Public Accounts over documents that are eligible for production and review, the Finance and Administration Cabinet shall review the dispute and issue a determination, in accordance with Secretary's Order 11-004.

April 30, 2018



### **FEDERAL CONTRACT NOTES**

The Kentucky Department of Highways, in accordance with the Regulations of the United States Department of Transportation 23 CFR 635.112 (h), hereby notifies all bidders that failure by a bidder to comply with all applicable sections of the current Kentucky Standard Specifications, including, but not limited to the following, may result in a bid not being considered responsive and thus not eligible to be considered for award:

- |                                |  |
|--------------------------------|--|
| 102.02 Current Rating          | 102.08 Preparation and Delivery of Proposals |
| 102.13 Irregular Bid Proposals | 102.14 Disqualification of Bidders           |
| 102.09 Proposal Guaranty       |  |

### **CIVIL RIGHTS ACT OF 1964**

The Kentucky Department of Highways, in accordance with the provisions of Title VI of the Civil Rights Act of 1964 (78 Stat. 252) and the Regulations of the Federal Department of Transportation (49 C.F.R., Part 21), issued pursuant to such Act, hereby notifies all bidders that it will affirmatively insure that the contract entered into pursuant to this advertisement will be awarded to the lowest responsible bidder without discrimination on the ground of race, color, or national origin.

### **NOTICE TO ALL BIDDERS**

To report bid rigging activities call: 1-800-424-9071.

The U.S. Department of Transportation (DOT) operates the above toll-free “hotline” Monday through Friday, 8:00 a.m. to 5:00 p.m. eastern time. Anyone with knowledge of possible bid rigging, bidder collusion, or other fraudulent activities should use the “hotline” to report such activities.

The “hotline” is part of the DOT’s continuing effort to identify and investigate highway construction contract fraud and abuse and is operated under the direction of the DOT Inspector General. All information will be treated confidentially and caller anonymity will be respected.

### **SECOND TIER SUBCONTRACTS**

Second Tier subcontracts on federally assisted projects shall be permitted. However, in the case of DBE’s, second tier subcontracts will only be permitted where the other subcontractor is also a DBE. All second tier subcontracts shall have the consent of both the Contractor and the Engineer.

### **DISADVANTAGED BUSINESS ENTERPRISE PROGRAM**

It is the policy of the Kentucky Transportation Cabinet (“the Cabinet”) that Disadvantaged Business Enterprises (“DBE”) shall have the opportunity to participate in the performance of highway construction projects financed in whole or in part by Federal Funds in order to create a level playing field for all businesses who wish to contract with the Cabinet. To that end, the Cabinet will comply with the regulations found in 49 CFR Part 26, and the definitions and requirements contained therein shall be adopted as if set out verbatim herein.

The Cabinet, contractors, subcontractors, and sub-recipients shall not discriminate on the basis of race, color, national origin, or sex in the performance of work performed pursuant to Cabinet contracts. The contractor shall carry out applicable requirements of 49 CFR 26 in the award and administration of federally assisted highway construction projects. The contractor will include this provision in all its subcontracts and supply agreements pertaining to contracts with the Cabinet.

Failure by the contractor to carry out these requirements is a material breach of its contract with the Cabinet, which may result in the termination of the contract or such other remedy as the Cabinet deems necessary.

### **DBE GOAL**

The Disadvantaged Business Enterprise (DBE) goal established for this contract, as listed on the front page of the proposal, is the percentage of the total value of the contract.

The contractor shall exercise all necessary and reasonable steps to ensure that Disadvantaged Business Enterprises participate in a least the percent of the contract as set forth above as goals for this contract.

### **OBLIGATION OF CONTRACTORS**

Each contractor prequalified to perform work on Cabinet projects shall designate and make known to the Cabinet a liaison officer who is assigned the responsibility of effectively administering and promoting an active program for utilization of DBEs.

If a formal goal has not been designated for the contract, all contractors are encouraged to consider DBEs for subcontract work as well as for the supply of material and services needed to perform this work.

Contractors are encouraged to use the services of banks owned and controlled by minorities and women.

### **CERTIFICATION OF CONTRACT GOAL**

Contractors shall include the following certification in bids for projects for which a DBE goal has been established. BIDS SUBMITTED WHICH DO NOT INCLUDE CERTIFICATION OF DBE PARTICIPATION WILL NOT BE ACCEPTED. These bids will not be considered for award by the Cabinet and they will be returned to the bidder.

“The bidder certifies that it has secured participation by Disadvantaged Business Enterprises (“DBE”) in the amount of \_\_\_\_\_ percent of the total value of this contract and that the DBE participation is in compliance with the requirements of 49 CFR 26 and the policies of the Kentucky Transportation Cabinet pertaining to the DBE Program.”

**The certification statement is located in the electronic bid file. All contractors must certify their DBE participation on that page. DBEs utilized in achieving the DBE goal must be certified and prequalified for the work items at the time the bid is submitted.**

### **DBE PARTICIPATION PLAN**

Lowest responsive bidders must submit the *DBE Plan/ Subcontractor Request*, form TC 14-35 DBE, within **5** days of the letting. This is necessary before the Awards Committee will review and make a recommendation. **The project will not be considered for award prior to submission and approval of the apparent low bidder’s DBE Plan/Subcontractor Request.**

The DBE Participation Plan shall include the following:

1. Name and address of DBE Subcontractor(s) and/or supplier(s) intended to be used in the proposed project;
2. Description of the work each is to perform including the work item, unit, quantity, unit price and total amount of the work to be performed by the individual DBE. The Proposal Line Number, Category Number, and the Project Line Number can be found in the “material listing” on the Construction Procurement website under the specific letting;
3. The dollar value of each proposed DBE subcontract and the percentage of total project contract value this represents. DBE participation may be counted as follows:
  - a. If DBE suppliers and manufactures assume actual and contractual responsibility, the dollar value of materials to be furnished will be counted toward the goal as follows:
    - The entire expenditure paid to a DBE manufacturer;
    - 60 percent of expenditures to DBE suppliers that are not manufacturers provided the supplier is a regular dealer in the product involved. A regular dealer must be engaged in, as its principal business and in its own name, the sale of products to the public, maintain an inventory and own and operate distribution equipment; and
    - The amount of fees or commissions charged by the DBE firms for a bona fide service, such as professional, technical, consultant, or managerial services and assistance in the procurement of essential personnel, facilities, equipment, materials, supplies, delivery of materials and supplies or for furnishing bonds, or insurance, providing such fees or commissions are determined to be reasonable and customary.

- b) The dollar value of services provided by DBEs such as quality control testing, equipment repair and maintenance, engineering, staking, etc.;
  - c) The dollar value of joint ventures. DBE credit for joint ventures will be limited to the dollar amount of the work actually performed by the DBE in the joint venture;
4. Written and signed documentation of the bidder's commitment to use a DBE contractor whose participation is being utilized to meet the DBE goal; and
  5. Written and signed confirmation from the DBE that it is participating in the contract as provided in the prime contractor's commitment.

#### **UPON AWARD AND BEFORE A WORK ORDER WILL BE ISSUED**

Contractors must submit the signed subcontract between the contractor and the DBE contractor, along with the DBE's certificate of insurance. If the DBE is a supplier of materials for the project, a signed purchase order must be submitted to the Division of Construction Procurement.

Changes to DBE Participation Plans must be approved by the Cabinet. The Cabinet may consider extenuating circumstances including, but not limited to, changes in the nature or scope of the project, the inability or unwillingness of a DBE to perform the work in accordance with the bid, and/or other circumstances beyond the control of the prime contractor.

#### **CONSIDERATION OF GOOD FAITH EFFORTS REQUESTS**

If the DBE participation submitted in the bid by the apparent lowest responsive bidder does not meet or exceed the DBE contract goal, the apparent lowest responsive bidder must submit a Good Faith Effort Package to satisfy the Cabinet that sufficient good faith efforts were made to meet the contract goals prior to submission of the bid. Efforts to increase the goal after bid submission will not be considered in justifying the good faith effort, unless the contractor can show that the proposed DBE was solicited prior to the letting date. DBEs utilized in achieving the DBE goal must be certified and prequalified for the work items at the time the bid is submitted. One complete set (hard copy along with an electronic copy) of this information must be received in the Division of Contract Procurement no later than 12:00 noon of the tenth calendar day after receipt of notification that they are the apparent low bidder.

Where the information submitted includes repetitious solicitation letters it will be acceptable to submit a sample representative letter along with a distribution list of the firms solicited. Documentation of DBE quotations shall be a part of the good faith effort submittal as necessary to demonstrate compliance with the factors listed below which the Cabinet considers in judging good faith efforts. This documentation may include written subcontractors' quotations, telephone log notations of verbal quotations, or other types of quotation documentation.

The Good Faith Effort Package shall include, but may not be limited to information showing evidence of the following:

1. Whether the bidder attended any pre-bid meetings that were scheduled by the Cabinet to inform DBEs of subcontracting opportunities;
2. Whether the bidder provided solicitations through all reasonable and available means;
3. Whether the bidder provided written notice to all DBEs listed in the DBE directory at the time of the letting who are prequalified in the areas of work that the bidder will be subcontracting;
4. Whether the bidder followed up initial solicitations of interest by contacting DBEs to determine with certainty whether they were interested. If a reasonable amount of DBEs within the targeted districts do not provide an intent to quote or no DBEs are prequalified in the subcontracted areas, the bidder must notify the Disadvantaged Enterprise Business Liaison Officer (DEBLO) in the Office of Civil Rights and Small Business Development to give notification of the bidder's inability to get DBE quotes;
5. Whether the bidder selected portions of the work to be performed by DBEs in order to increase the likelihood of meeting the contract goals. This includes, where appropriate, breaking out contract work items into economically feasible units to facilitate DBE participation, even when the prime contractor might otherwise perform these work items with its own forces;
6. Whether the bidder provided interested DBEs with adequate and timely information about the plans, specifications, and requirements of the contract;
7. Whether the bidder negotiated in good faith with interested DBEs not rejecting them as unqualified without sound reasons based on a thorough investigation of their capabilities. Any rejection should be so noted in writing with a description as to why an agreement could not be reached;
8. Whether quotations were received from interested DBE firms but were rejected as unacceptable without sound reasons why the quotations were considered unacceptable. The fact that the DBE firm's quotation for the work is not the lowest quotation received will not in itself be considered as a sound reason for rejecting the quotation as unacceptable. The fact that the bidder has the ability and/or desire to perform the contract work with its own forces will not be considered a sound reason for rejecting a DBE quote. Nothing in this provision shall be construed to require the bidder to accept unreasonable quotes in order to satisfy DBE goals;
9. Whether the bidder specifically negotiated with subcontractors to assume part of the responsibility to meet the contract DBE goal when the work to be subcontracted includes potential DBE participation;
10. Whether the bidder made any efforts and/or offered assistance to interested DBEs in obtaining the necessary equipment, supplies, materials, insurance and/or bonding to satisfy the work requirements of the bid proposal; and
11. Any other evidence that the bidder submits which may show that the bidder has made reasonable good faith efforts to include DBE participation.

### **FAILURE TO MEET GOOD FAITH REQUIREMENT**

Where the apparent lowest responsive bidder fails to submit sufficient participation by DBE firms to meet the contract goal and upon a determination by the Good Faith Committee based upon the information submitted that the apparent lowest responsive bidder failed to make sufficient reasonable efforts to meet the contract goal, the bidder will be offered the opportunity to meet in person for administrative reconsideration. The bidder will be notified of the Committee's decision within 24 hours of its decision. The bidder will have 24 hours to request reconsideration of the Committee's decision. The reconsideration meeting will be held within two days of the receipt of a request by the bidder for reconsideration.

The request for reconsideration will be heard by the Office of the Secretary. The bidder will have the opportunity to present written documentation or argument concerning the issue of whether it met the goal or made an adequate good faith effort. The bidder will receive a written decision on the reconsideration explaining the basis for the finding that the bidder did or did not meet the goal or made adequate Good Faith efforts to do so.

The result of the reconsideration process is not administratively appealable to the Cabinet or to the United States Department of Transportation.

The Cabinet reserves the right to award the contract to the next lowest responsive bidder or to rebid the contract in the event that the contract is not awarded to the low bidder as the result of a failure to meet the good faith requirement.

### **SANCTIONS FOR FAILURE TO MEET DBE REQUIREMENTS OF THE PROJECT**

Failure by the prime contractor to fulfill the DBE requirements of a project under contract or to demonstrate good faith efforts to meet the goal constitutes a breach of contract. When this occurs, the Cabinet will hold the prime contractor accountable, as would be the case with all other contract provisions. Therefore, the contractor's failure to carry out the DBE contract requirements shall constitute a breach of contract and as such the Cabinet reserves the right to exercise all administrative remedies at its disposal including, but not limited to the following:

- Disallow credit toward the DBE goal;
- Withholding progress payments;
- Withholding payment to the prime in an amount equal to the unmet portion of the contract goal; and/or
- Termination of the contract.

### **PROMPT PAYMENT**

The prime contractor will be required to pay the DBE within seven (7) working days after he or she has received payment from the Kentucky Transportation Cabinet for work performed or materials furnished.

### **CONTRACTOR REPORTING**

All contractors must keep detailed records and provide reports to the Cabinet on their progress in meeting the DBE requirement on any highway contract. These records may include, but shall not be limited to payroll, lease agreements, cancelled payroll checks, executed subcontracting agreements, etc. Prime contractors will be required to complete and submit a **signed and notarized** Affidavit of Subcontractor Payment (TC 18-7) and copies of checks for any monies paid to each DBE subcontractor or supplier utilized to meet a DBE goal. These documents must be completed and signed within 7 days of being paid by the Cabinet.

Payment information that needs to be reported includes date the payment is sent to the DBE, check number, Contract ID, amount of payment and the check date. Before Final Payment is made on this contract, the Prime Contractor will certify that all payments were made to the DBE subcontractor and/or DBE suppliers.

#### **\*\*\*\*\* IMPORTANT \*\*\*\*\***

**Please mail the original, signed and completed TC (18-7) Affidavit of Subcontractor Payment form and all copies of checks for payments listed above to the following address:**

Office of Civil Rights and Small Business Development  
6<sup>th</sup> Floor West 200 Mero Street  
Frankfort, KY 40622

The prime contractor should notify the KYTC Office of Civil Rights and Small Business Development seven (7) days prior to DBE contractors commencing work on the project. The contact in this office is Mr. Melvin Bynes. Mr. Bynes' current contact information is email address – [melvin.bynes2@ky.gov](mailto:melvin.bynes2@ky.gov) and the telephone number is (502) 564-3601.

### **DEFAULT OR DECERTIFICATION OF THE DBE**

If the DBE subcontractor or supplier is decertified or defaults in the performance of its work, and the overall goal cannot be credited for the uncompleted work, the prime contractor may utilize a substitute DBE or elect to fulfill the DBE goal with another DBE on a different work item. If after exerting good faith effort in accordance with the Cabinet's Good Faith Effort policies and procedures, the prime contractor is unable to replace the DBE, then the unmet portion of the goal may be waived at the discretion of the Cabinet.

7/19/2019

**LEGAL REQUIREMENTS AND RESPONSIBILITY TO THE PUBLIC – CARGO PREFERENCE ACT (CPA).**

**(REV 12-17-15) (1-16)**

SECTION 7 is expanded by the following new Article:

102.10 **Cargo Preference Act – Use of United States-flag vessels.**

Pursuant to Title 46CFR Part 381, the Contractor agrees

- To utilize privately owned United States-flag commercial vessels to ship at least 50 percent of the gross tonnage (computed separately for dry bulk carriers, dry cargo liners, and tankers) involved, whenever shipping any equipment, material, or commodities pursuant to this contract, to the extent such vessels are available at fair and reasonable rates for United States-flag commercial vessels.

- To furnish within 20 days following the date of loading for shipments originating within the United States or within 30 working days following the date of loading for shipments originating outside the United States, a legible copy of a rated, ‘on-board’ commercial ocean bill-of-lading in English for each shipment of cargo described in paragraph 1 of this section to both the Contracting Officer (through the prime contractor in the case of subcontractor bills-of-lading) and to the Division of National Cargo, Office of Market Development, Maritime Administration, Washington, DC 20590.

- To insert the substance of the provisions of this clause in all subcontracts issued pursuant to this contract.



### **TRAINEES**

In Compliance with the "TRAINING SPECIAL PROVISION" included in Part III of the Proposal, the Contractor will be required to employ a trainee(s) for this contract.

### **PROJECT TRAFFIC COORDINATOR (PTC)**

Be advised this project is a significant project pursuant to section 112.03.12.

### **ASPHALT MIXTURE**

Unless otherwise noted, the Department estimates the rate of application for all asphalt mixtures to be 110 lbs/sy per inch of depth.

### **INCIDENTAL SURFACING**

The Department has included in the quantities of asphalt mixtures established in the proposal estimated quantities required for resurfacing or surfacing mailbox turnouts, farm field entrances, residential and commercial entrances, curve widening, ramp gores and tapers, and road and street approaches, as applicable. Pave these areas to the limits as shown on Standard Drawing RPM-110-06 or as directed by the Engineer. In the event signal detectors are present in the intersecting streets or roads, pave the crossroads to the right of way limit or back of the signal detector, whichever is the farthest back of the mainline. Surface or resurface these areas as directed by the Engineer. The Department will not measure placing and compacting for separate payment but shall be incidental to the Contract unit price for the asphalt mixtures.

### **FUEL AND ASPHALT PAY ADJUSTMENT**

The Department has included the Contract items Asphalt Adjustment and Fuel Adjustment for possible future payments at an established Contract unit price of \$1.00. The Department will calculate actual adjustment quantities after work is completed. If existing Contract amount is insufficient to pay all items on the contract with the adjustments, the Department will establish additional monies with a change order.

### **ASPHALT PAVEMENT RIDE QUALITY CATEGORY A**

The Department will apply Pavement Rideability Requirements on this project in accordance with Section 410, Category A.

### **OPTION A**

Be advised that the Department will accept compaction of asphalt mixtures furnished for driving lanes and ramps, at 1 inch (25mm) or greater, on this project according to OPTION A in accordance with Section 402 and Section 403 of the current Standard Specifications. The Department will require joint cores as described in Section 402.03.02 for surface mixtures only. The Department will accept compaction of all other asphalt mixtures according to OPTION B.

### **MATERIAL TRANSFER VEHICLE (MTV)**

Provide and use a MTV in accordance with Sections 403.02.10 and 403.03.05.

## **SPECIAL NOTE FOR INSPECTION, MAINTENANCE AND REPAIR OF PAVEMENT**

The Contractor shall regularly inspect, maintain, and at the direction of the Engineer, perform corrective work to existing or newly constructed pavement utilized for maintenance of traffic, throughout the life of the project. This work will be in accordance with Section 105.11 and 107.08 of the Standard Specifications. Failure to perform corrective work within seven calendar days of written notice will result in Liquidated Damages at the contract rate according to Section 108.09 of the Standard Specifications.

**SPECIAL NOTE FOR INLAID PAVEMENT MARKERS**

---

**I. DESCRIPTION**

Except as provided herein, perform all work in accordance with the Department's Standard and Supplemental Specifications and applicable Standard and Sepia Drawings, current editions. Article references are to the Standard Specifications. This work shall consist of:

- (1) Maintain and Control Traffic; and (2) Furnish and install Inlaid Pavement Markers (IPMs) in recessed grooves; and (3) Any other work as specified by these notes and the Contract.

**II. MATERIALS**

The Department will sample all materials in accordance with the Department's Sampling Manual. Make the materials available for sampling a sufficient time in advance of the use of the materials to allow for the necessary time for testing unless otherwise specified in these Notes.

**A. Maintain and Control Traffic.** See Traffic Control Plan.

**B. Markers.** Provide reflective lenses with depth control breakaway positioning tabs. Before furnishing the markers, provide to the Engineer the manufacturer's current recommendations for adhesives and installation procedures. Use one brand and design throughout the project. Use markers meeting the specifications in the table below.

<b>SPECIFICATIONS FOR HOUSING AND REFLECTOR</b>	
Material:	Polycarbonate Plastic
Weight:	Housing 2.00 oz.
	Reflector 2.00oz.
Housing Size:	5.00" x 3.00" x 0.70" high
Specific Intensity of Reflectivity at 0.2° Observation Angle	
White:	3.0 at 0°entrance angle
	1.2 at 20°entrance angle
Yellow:	60% of white values
Red:	25% of white values

**C. Adhesives.** Use adhesives that conform to the manufacturer's recommendations.

### III. CONSTRUCTION

**A. Experimental Evaluation.** The University of Kentucky Transportation Center will be evaluating this installation of IPMs. Notify the Engineer a minimum of 14 calendar days prior to beginning work. The Engineer will coordinate the University's activities with the Contractor's work.

**B. Maintain and Control Traffic.** See Traffic Control Plan.

**C. Installation.** Install IPMs in recessed grooves cut into the final course of asphalt pavement according to the manufacturer's recommendations. Do not cut the grooves until the pavement has cured sufficiently to prevent tearing or raveling. Cut installation grooves using diamond blades on saws that accurately control groove dimensions. Remove all dirt, grease, oil, loose or unsound layers, and any other material from the marker area which would reduce the bond of the adhesive. Maintain pavement surfaces in a clean condition until placing markers.

Prepare the pavement surfaces, and install the markers in the recessed groove according to the drawing below. Use an approved snowplowable epoxy adhesive. Ensure that the adhesive bed area is equal to the bottom area of the marker, and apply adhesive in sufficient quantity to force excess out around the entire perimeter of the marker. Use materials, equipment, and construction procedures that ensure proper adhesion of the markers to the pavement surface according to the manufacturer's recommendations. Remove all excess adhesive from in front of the reflective faces. If any adhesive or foreign matter cannot be removed from the reflective faces, or if any marker fails to properly adhere to the pavement surface, remove and replace the marker at no additional cost to the Department.

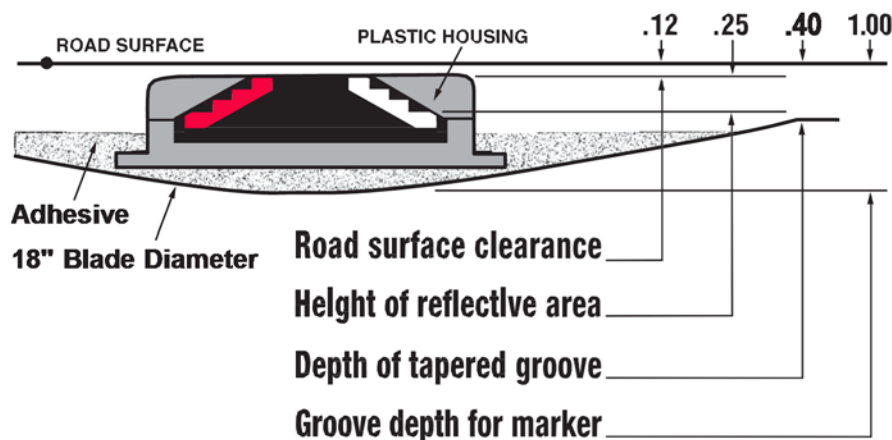

**D. Location and Spacing.** Install the markers in the pattern for high reflectivity with two (2) IPMs per groove. Locate and space markers as shown in the current standard drawings or sepias (note: use Inlaid Pavement Markers wherever Type V Pavement Markers are called for). Do not install markers on bridge decks. Do not install a marker

Inlaid Pavement Markers  
Page 3 of 4

on top of a pavement joint or crack. Offset the recessed groove a minimum of 2 inches from any longitudinal pavement joint or crack and at least one inch from the painted stripe, ensuring that the finished line of markers is straight with minimal lateral deviation. Give preference to maintaining the 2-inch offset between recessed groove and joint as opposed to keeping the line of markers straight.

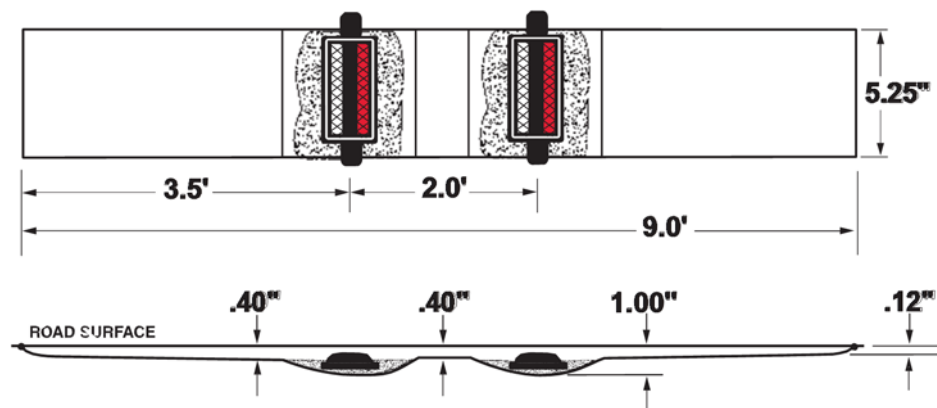

Place inlaid markers as much in line with existing pavement striping as possible. Place markers installed along an edge line or channelizing line so that the near edge of the plastic housing is no more than one inch from the near edge of the line. Place markers installed along a lane line between and in line with the dashes. Do not place markers over the lines except where the lines deviate visibly from their correct alignment, and then only after obtaining the Engineer's prior approval of the location.

If conflicts between recessed groove placement in relation to pavement joint and striping cannot be resolved, obtain the Engineer's approval to eliminate the marker or revise the alignment.

**E. Disposal of Waste.** Dispose of all removed asphalt pavement, debris, and other waste at sites off the right of way obtained by the Contractor at no additional cost to the Department. See Special Note for waste and Borrow.

**F. Restoration.** Be responsible for all damage to public and/or private property resulting from the work. Restore all damaged features in like kind materials and design at no additional cost to the Department.

**G. On-Site Inspection.** Make a thorough inspection of the site prior to submitting a bid and be thoroughly familiar with existing conditions so that the work can be expeditiously performed after a contract is awarded. The Department will consider submission of a bid as evidence of this inspection having been made and will not honor any claims for money or grant Contract time extensions resulting from site conditions.

**H. Caution.** Do not take information shown on the drawings and in this proposal and the types and quantities of work listed as an accurate or complete evaluation of the

Inlaid Pavement Markers  
Page 4 of 4

material and conditions to be encountered during construction, but consider the types and quantities of work listed as approximate only. The bidder must draw his own conclusion as to the conditions encountered. The Department does not give any guarantee as to the accuracy of the data and no claim will be considered for additional compensation or extension of Contract time if the conditions encountered are not in accordance with the information shown.

#### **IV. MEASUREMENT**

**A. Maintain and Control Traffic.** See Traffic Control Plan.

**B. "INLAID PAYMENT MARKER"** shall be measured as each. One (1) installation of "INLAID PAVEMENT MARKER" will consist of grooving the pavement, removing asphalt cuttings and debris, preheating pavement to remove moisture, adhesives, and installation of two (2) markers with all lenses in accordance with this note.

**Note: Each pay item of Inlaid Pavement Marker will require two markers.**

#### **V. PAYMENT**

**A. Maintain and Control Traffic.** See Traffic Control Plan.

**B. Inlaid Pavement Markers.** The Department will make payment for the completed and accepted quantity of completely installed "INLAID PAVEMENT MARKERS" at the Contract unit price, each. Accept payment as full compensation for all labor, equipment, materials, and incidentals to accomplish this work to the satisfaction of the Engineer. A system of one (1) groove and two (2) markers shall be paid as one "INLAID PAVEMENT MARKER". The bid item "INLAID PAVEMENT MARKER" shall be used regardless of the color and type of lenses required.

## ***SPECIAL NOTE***

### **For Tree Removal**

### **Magoffin County Mountain Parkway Reconstruction Item No. 10-126.40**

NO CLEARING OF TREES 5 INCHES OR GREATER (DIAMETER BREST HEIGHT) FROM JUNE 1- JULY 31.

**ADDITIONALLY**, THE CONTRACTOR WILL BE RESPONSIBLE FOR RECORDING AND REPORTING THE PROGRESS OF TREE REMOVAL THROUGHOUT THE ENTIRE PROJECT LENGTH (INCLUDING ANY EXCESS MATERIAL SITES, VALUE ENGINEERING AREAS, ETC.). REPORTING SHALL IDENTIFY THE LOCATION(S) CLEARED ON AERIAL MAPPING OF THE PROJECT AREA AND ALSO LIST THE ACREAGE OF FORESTED HABITAT REMOVED SINCE THE PREVIOUS REPORTING PERIOD. REPORTS SHALL BE PRODUCED BY THE CONTRACTOR AND PROVIDED TO KYTC DIVISION OF ENVIRONMENTAL ANALYSIS (DAVE HARMON; [dave.harmon@ky.gov](mailto:dave.harmon@ky.gov)) BY APRIL 15<sup>TH</sup> (FOR THE PERIOD RUNNING OCTOBER 16<sup>TH</sup> THROUGH MARCH 31<sup>ST</sup>) AND AGAIN BY NOVEMBER 1<sup>ST</sup> (FOR THE PERIOD RUNNING APRIL 1<sup>ST</sup> THROUGH OCTOBER 15<sup>TH</sup>). THESE TRACKING AND REPORTING EFFORTS SHALL BEGIN AS OF OCTOBER 16, 2017 AND CONTINUE UNTIL PROJECT COMPLETION.

**If there are any questions regarding this note, please contact David Waldner, Director, Division of Environmental Analysis, 200 Mero Street, Frankfort, KY 40601, Phone: (502) 564-7250.**

## **SPECIAL NOTE FOR PIPELINE INSPECTION**

**1.0 DESCRIPTION.** The Department will perform visual inspections on all pipe on the project. A video inspection will be required on projects having more than 250 linear feet of storm sewer and/or culvert pipe and on routes with an ADT of greater than 1,000 vehicles. Conduct video inspections on all pipe located under the roadway and 50 percent of the remaining pipe not under the roadway. Storm sewer runs and outfall pipes not under the roadway take precedence over rural entrance pipes. Contractors performing this item of work must be prequalified with the Department in the work type J51 (Video Pipe Inspection and Cleaning). Deflection testing shall be completed using a mandrel in accordance with the procedure outlined below or by physical measurement for pipes greater than 36 inches in diameter. Mandrel testing for deflection must be completed prior to the video inspection testing. Unless otherwise noted, Section references herein are to the Department's 2019 Standard Specifications for Road and Bridge Construction.

**2.0 VIDEO INSPECTION.** Ensure pipe is clear of water, debris or obstructions. Complete the video inspection and any necessary measurement prior to placing the final surface over any pipe. When paving will not be delayed, take measurements 30 days or more after the completion of earthwork to within 1 foot of the finished subgrade. Notify the Engineer a minimum of 24 hours in advance of inspection and notify the Engineer immediately if distresses or locations of improper installation are logged.

### **2.1 INSPECTION FOR DEFECTS AND DISTRESSES**

**A)** Begin at the outlet end and proceed through to the inlet at a speed less than or equal to 30 ft/minute. Remove blockages that will prohibit a continuous operation.

**B)** Document locations of all observed defects and distresses including but not limited to: cracking, spalling, slabbing, exposed reinforcing steel, sags, joint offsets, joint separations, deflections, improper joints/connections, blockages, leaks, rips, tears, buckling, deviation from line and grade, damaged coatings/paved inverts, and other anomalies not consistent with a properly installed pipe.

**C)** During the video inspection provide a continuous 360 degree pan of every pipe joint.

**D)** Identify and measure all cracks greater than 0.1" and joint separations greater than 0.5".

**E)** Video Inspections are conducted from junction to junction which defines a pipe run. A junction is defined as a headwall, drop box inlet, curb box inlet, manhole, buried junction, or other structure that disturbs the continuity of the pipe. Multiple pipe inspections may be conducted from a single set up location, but each pipe run must be on a separate video file and all locations are to be referenced from nearest junction relative to that pipe run.

**F)** Record and submit all data on the TC 64-765 and TC 64-766 forms.

**3.0 MANDREL TESTING.** Mandrel testing will be used for deflection testing. For use on Corrugated Metal Pipe, High Density Polyethylene Pipe, and Polyvinyl Chloride Pipe,



use a mandrel device with an odd number of legs (9 minimum) having a length not less than the outside diameter of the mandrel. The diameter of the mandrel at any point shall not be less than the diameter specified in Section 3.6. Mandrels can be a fixed size or a variable size.

**3.1** Use a proving ring or other method recommended by the mandrel manufacturer to verify mandrel diameter prior to inspection. Provide verification documentation for each size mandrel to the Engineer.

**3.2** All deflection measurements are to be based off of the AASHTO Nominal Diameters. Refer to the chart in section 3.6.

**3.3** Begin by using a mandrel set to the 5.0% deflection limit. Place the mandrel in the inlet end of the pipe and pull through to the outlet end. If resistance is met prior to completing the entire run, record the maximum distance achieved from the inlet side, then remove the mandrel and continue the inspection from the outlet end of the pipe toward the inlet end. Record the maximum distance achieved from the outlet side.

**3.4** If no resistance is met at 5.0% then the inspection is complete. If resistance occurred at 5.0% then repeat 3.1 and 3.2 with the mandrel set to the 10.0% deflection limit. If the deflection of entire pipe run cannot be verified with the mandrel then immediately notify the Engineer.

**3.5** Care must be taken when using a mandrel in all pipe material types and lining/coating scenarios. Pipe damaged during the mandrel inspection will be video inspected to determine the extent of the damage. If the damaged pipe was video inspected prior to mandrel inspection then a new video inspection is warranted and supersedes the first video inspection. Immediately notify the Engineer of any damages incurred during the mandrel inspection and submit a revised video inspection report.

**3.6** AASHTO Nominal Diameters and Maximum Deflection Limits.

Base Pipe Diameter (inches)	AASHTO Nominal Diameter (inches)	Max. Deflection Limit (inches)	
		5.0%	10.0%
15	14.76	14.02	13.28
18	17.72	16.83	15.95
24	23.62	22.44	21.26
30	29.53	28.05	26.58
36	35.43	33.66	31.89
42	41.34	39.27	37.21
48	47.24	44.88	42.52
54	53.15	50.49	47.84
60	59.06	56.11	53.15

**4.0 PHYSICAL MEASUREMENT OF PIPE DEFLECTION.** Alternate method for deflection testing when there is available access or the pipe is greater than 36 inches in diameter, as per 4.1. Use a contact or non-contact distance instrument. A leveling device is recommended for establishing or verifying vertical and horizontal control.

**4.1** Physical measurements may be taken after installation and compared to the AASHTO Nominal Diameter of the pipe as per Section 3.6. When this method is used, determine the smallest interior diameter of the pipe as measured through the center point of the pipe (D2). All measurements are to be taken from the inside crest of the corrugation. Take the D2 measurements at the most deflected portion of the pipe run in question and at intervals no greater than ten (10) feet through the run. Calculate the deflection as follows:

$$\% \text{ Deflection} = [(AASHTO \text{ Nominal Diameter} - D2) / AASHTO \text{ Nominal Diameter}] \times 100\%$$

Note: The Engineer may require that preset monitoring points be established in the culvert prior to backfilling. For these points the pre-installation measured diameter (D1) is measured and recorded. Deflection may then be calculated from the following formula:

$$\% \text{ Deflection} = [(D1 - D2) / D1] (100\%)$$

**4.2** Record and submit all data.

**5.0 DEDUCTION SCHEDULE.** All pipe deductions shall be handled in accordance with the tables shown below.

<b>FLEXIBLE PIPE DEFLECTION</b>	
Amount of Deflection (%)	Payment
0.0 to 5.0	100% of the Unit Bid Price
5.1 to 9.9	50% of the Unit Bid Price <sup>(1)</sup>
10 or greater	Remove and Replace <sup>(2)</sup>

<sup>(1)</sup> Provide Structural Analysis for HDPE and metal pipe. Based on the structural analysis, pipe may be allowed to remain in place at the reduced unit price. <sup>(2)</sup> The Department may allow the pipe to remain in place with no pay to the Contractor in instances where it is in the best interest to the public and where the structural analysis demonstrates that the pipe should function adequately.

<b>RIGID PIPE REMEDIATION TABLE PIPE</b>	
Crack Width (inches)	Payment
• 0.1	100% of the Unit Bid Price
Greater than 0.1	Remediate or Replace <sup>(1)</sup>

<sup>(1)</sup> Provide the Department in writing a method for repairing the observed cracking. Do not begin work until the method has been approved.

**6.0 PAYMENT.** The Department will measure the quantity in linear feet of pipe to inspect. The Department will make payment for the completed and accepted quantities under the following:

<u>Code</u>	<u>Pay Item</u>	<u>Pay Unit</u>
24814EC	Pipeline Inspection	Linear Foot
10065NS	Pipe Deflection Deduction	Dollars

## SPECIAL NOTE FOR INTELLIGENT COMPACTION OF ASPHALT MIXTURES

This Special Note will apply when indicated on the plans or in the proposal. Section references herein are to the Department's Standard Specifications for Road and Bridge Construction current edition.

**1.0 DESCRIPTION.** Provide and use Intelligent Compaction (IC) Rollers for compaction of all asphalt mixtures.

**2.0 MATERIALS AND EQUIPMENT.** In addition to the equipment specified in Subsection 403.02, a minimum of one (1) IC roller is to be used on the project at all times, two (2) IC rollers will be required when the paving train consists of three (3) or more rollers. The Contractor is to only use the IC roller(s) for compaction as the breakdown and/or intermediate roller(s). All IC rollers will meet the following minimum characteristics:

1. Are self propelled double-drum vibratory rollers equipped with accelerometers mounted in or about the drum to measure the interactions between the rollers and compacted materials in order to evaluate the applied compactive effort. The IC rollers must have the approval of the Engineer prior to use. Examples of rollers equipped with IC technology can be found at [www.IntelligentCompaction.com](http://www.IntelligentCompaction.com).
2. Are equipped with non-contact temperature sensors for measuring pavement surface temperatures.
3. The output from the roller is designated as the IC-MV which represents the stiffness of the materials based on the vibration of the roller drums and the resulting response from the underlying materials.
4. Are equipped with integrated on-board documentation systems that are capable of displaying real-time color-coded maps of IC measurement values including the stiffness response values, location of the roller, number of roller passes, machine settings, together with the material temperature, speed and the frequency and amplitude of roller drums. Ensure the display unit is capable of transferring the data by means of a cloud based system.
5. Are equipped with a mounted Global Positioning System GPS radio and receiver either a Real Time Kinematic (RTK-GPS) or Global Navigational Satellite System (GNSS) units that monitor the location and track the number of passes of the rollers. Accuracy of the positioning system is to be a minimum of 12 inches. Data is to be transferred to the Cabinet via a cloud based system within 30 minutes of collection.

**3.0 WORK PLAN.** Submit to the Engineer an IC Work Plan at the Preconstruction Conference and at least 2 weeks prior to beginning construction. Describe in the work plan the following:

1. Compaction equipment to be used including:
  - Vendor(s)
  - Roller model(s),
  - Roller dimensions and weights,
  - Description of IC measurement system,
  - GPS capabilities,
  - Documentation system,
  - Temperature measurement system, and
  - Software.
2. Roller data collection methods including sampling rates and intervals and data file types.
3. Transfer of data to the Engineer including method, timing, and personnel responsible. At the preconstruction meeting, provide the Cabinet with rights to allow for web access to the data file location. Access to the data is not to be hindered in any way. The Contractor will provide the Cabinet with any vendor specific software, user id, passwords, etc. needed to access the data through this service, cost of this access is incidental to the thermal profile bid item. The Cabinet is to have access to all data as it is being collected. If a third party is used for collecting and distributing the data the Cabinet is to have the same access rights and time as the Contractor.
4. Training plan and schedule for roller operators, project foreman, project surveyors, and Cabinet personnel; including both classroom and field training. Training should be conducted at least 1 week before beginning IC construction. The training is to be performed by a qualified representative(s) from the IC Roller manufacture(s) to be used on the project. This training shall include how to access and use the data from the cloud data source.

**4.0 CONSTRUCTION.** Do not begin work until the Engineer has approved the IC submittals and the IC equipment.

Follow requirements established in Section 400 for production and placement, materials, equipment, acceptance plans and adjustments except as noted or modified in this Specification. Provide the Engineer at least one day's notice prior to beginning construction or prior to resuming production if operations have been temporarily suspended. Ensure paving equipment complies with all requirements specified in Section 400. The IC roller temperatures will be evaluated by the Department with the data from a Paver Mounted Infrared Temperature Gauge.

A. Pre-Construction Test Section(s) Requirements.

Three to five days prior to the start of production, ensure the proper setup of the GPS, IC roller(s) and the rover(s) by conducting joint GPS correlation and verification testing between the Contractor, GPS representative and IC roller manufacturer using the same datum.

1. Ensure GPS correlation and verification testing includes the following minimum processes:
  - a. Establish the GPS system to be used either one with a base station or one with mobile receivers only. Ensure all components in the system are set to the correct coordinate system; then,
  - b. Verify that the roller and rover are working properly and that there is a connection with the base station; then,
  - c. Record the coordinates of the two edges where the front drum of the roller is in contact with the ground from the on-board, color-coded display; then,
  - d. Mark the locations of the roller drum edges and move the roller, and place the mobile receiver at each mark and record the readings; then,
2. Compare coordinates between the roller and rover receivers. If the coordinates are within 12.0 in. of each other, the comparison is acceptable. If the coordinates are not within 12.0 in., diagnose and perform necessary corrections and repeat the above steps until verification is acceptable.
3. Do not begin work until acceptable GPS correlation and verification has been obtained.
4. The Contractor and the Department should conduct random GPS verification testing during production to ensure data locations are accurate. The recommended rate is once per day with a requirement of at least once per week.
5. All acceptance testing shall be as outlined in Standard Specifications section 400.

B. Construction Test Section(s) Requirements.

Construct test section(s) at location(s) agreed on by the Contractor and the Engineer within the project limits. The test section is required to determine a compaction curve of the asphalt mixtures in relationship to number of roller passes and to the stiffness of mixture while meeting the Department in-place compaction requirements. All rollers and the respective number of passes for each is to be determined via control strip each time a material change, equipment change or when the Engineer deems necessary.

Conduct test section(s) on every lift and every asphalt mixture. Ensure test section quantities of 500 to 1,000 tons of mainline mixtures. Operate IC rollers in the low to medium amplitude range and at the same settings (speed, frequency) throughout the section while minimizing overlapping of the roller, **the settings are to be used throughout the project with no changes**. After each roller pass, the qualified technician from the contractor observed by the Department will use a nondestructive nuclear gauge that has been calibrated to the mixture to estimate the density of the asphalt at 10 locations uniformly spaced throughout the test section within the width of a single roller pass. The density readings and the number of roller passes needed to achieve the specified compaction will be recorded. The estimated target density will be the peak of the average of the nondestructive readings within the desired compaction temperature range for the mixture. The IC roller data in conjunction with the Veda software will create an IC compaction curve for the mixture. The target IC-MV is the point when the increase in the IC-MV of the material between passes is less than 5 percent on the compaction curve. The IC compaction curve is defined as the relationship between the IC-MV and the roller passes. A compaction curve example is as follows:

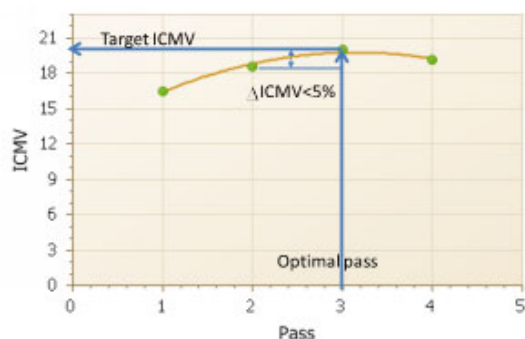

Subsequent to the determination of the target IC-MV, compact an adjoining > 250 < 500 tons section using same roller settings and the number of estimated roller passes and allow the Department to verify the compaction with the same calibrated nondestructive nuclear gauge following the final roller pass. **The Department will obtain cores at 10 locations (No cores for calibration are to be taken in the surface layer, use non-destructive density results only!!)** uniformly spaced throughout the test section within the width of the single roller. Obtain GPS measurement of the core locations with a GPS rover. Use the Veda software to perform least square linear regression between the core data and IC-MV in order to correlate the production IC-MV values to the Department specified in-place air voids. A sample linear regression curve example is as follows.

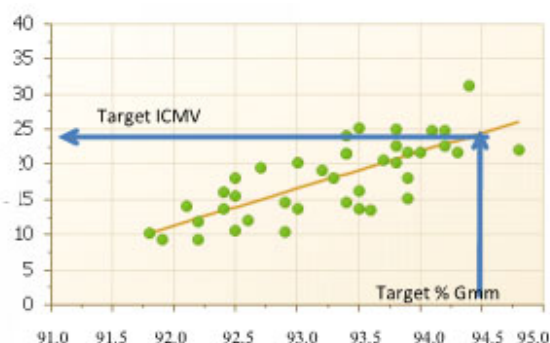

C. Construction Requirements.

Use the IC roller on all lifts and types of asphalt within the limits of the project.

Ensure the optimal number of roller passes determined from the test sections has been applied to a minimum coverage of 80% of the individual IC Construction area. Ensure a minimum of 75% of the individual IC Construction area meets the target IC-MV values determined from the test sections.

Do not continue paving operations if IC Construction areas not meeting the IC criteria are produced until they have been investigated by the Department. Obtain the Engineer’s approval to resume paving operations. Non-IC rollers are allowed to be used as the third roller on the project; one of the breakdown or the finish rollers is to be equipped with IC technology.

IC Construction areas are defined as subsections of the project being worked continuously by the Contractor. The magnitude of the IC Construction areas may vary with production but must be at least 750 tons per mixture for evaluation. Partial IC Construction areas of < 750 tons will be included in the previous area evaluation. IC Construction areas may extend over multiple days depending on the operations.

The IC Construction Operations Criteria does not affect the Department’s acceptance processes for the materials or construction operations

**5.0 MEASUREMENT.** The Department will measure the total tons of asphalt mixtures compacted using the IC roller(s). Compaction is to be performed by a minimum of one (1) IC roller for a two (2) roller operation and a minimum of two (2) IC rollers when three (3) or more rollers are used for compaction. Material compacted by rollers not equipped with properly functioning IC equipment will not be accepted for payment of the bid item asphalt mixtures IC rolled. Use of

non-IC rollers can be accepted on small areas due to equipment malfunctions at the written approval of the Engineer. Paving operations should be suspended for equipment malfunctions that will extend over three days of operation.

Data is to be transferred to the cabinet in usable form no later than 30 minutes after collection. Data is to be transferred via a cloud based system.

**6.0 PAYMENT.** The Department will make payment for the completed and accepted quantities under the following:

1. Payment is full compensation for all work associated with providing IC equipped rollers, laptop computer, transmission of electronic data files, two copies of IC roller manufacturer software, and training.
2. Delays due to GPS satellite reception of signals to operate the IC equipment or IC roller breakdowns will not be considered justification for contract modifications or contract extensions.
3. Delays in data transfer will result in a reduction payment. Delays over 1 hour after collection are 75% pay, over 90 minutes are 50% pay, over 2 hours are 25% pay.

<u>Code</u>	<u>Pay Item</u>	<u>Pay Unit</u>
24781EC	Intelligent Compaction for Asphalt	Ton

March 14, 2019

## **SPECIAL NOTE FOR INTELLIGENT COMPACTION OF AGGREGATE BASES AND SOILS**

This Special Note will apply when indicated on the plans or in the proposal. Section references herein are to the Department's current edition of the Standard Specifications for Road and Bridge Construction.

**1.0 DESCRIPTION.** Provide and use Intelligent Compaction (IC) Rollers for compaction of Aggregate bases, stabilized subgrades, soil, and soil rock mixtures.

**2.0 MATERIALS AND EQUIPMENT.** The Contractor shall supply sufficient numbers of rollers and other associated equipment necessary to complete the compaction requirements for the specific materials. The Contractor will determine the number of IC rollers to use depending on the scope of the project. The IC roller(s) may be utilized during production with other standard compaction equipment and shall be used for the evaluation of the compaction operations. Provide at least one (1) roller to be used on the project with the following minimum characteristics:

1. Are self propelled vibratory rollers equipped with machine drive power and/or accelerometers mounted in or about the drum to measure the interactions between the rollers and compacted materials in order to evaluate the applied Compactive effort. [www.IntelligentCompaction.com](http://www.IntelligentCompaction.com) contains a list of acceptable rollers equipped with IC technology.
2. IC rollers can be either smooth drums or pad footed drums based on the type needed for the aggregate base or soil types to compact.
3. The output from the roller is designated as the IC-MV which represents the stiffness of the materials based on the vibration of the roller drums and the resulting response from the underlying materials, or the machine drive power value.
4. Are equipped with integrated on-board documentation systems that are capable of displaying real-time color-coded maps of IC measurement values including the stiffness response values, location of the roller, number of roller passes, machine settings, together with the speed, the frequency and amplitude of roller drums. Ensure the display unit is capable of transferring the data by means of a cloud based near real time system with a USB port backup data transfer.
5. Are equipped with a mounted Global Positioning System GPS radio and receiver either a Real Time Kinematic (RTK-GPS) or Global Navigational Satellite System (GNSS) units that monitor the location and track the number of passes of the rollers. Accuracy of the positioning system must be within 12 inches.

**3.0 WORK PLAN.** Submit to the Engineer an IC Work Plan at the Preconstruction Conference and/or at least 2 weeks prior to beginning the corresponding construction activities. Describe in the work plan the following:

1. Compaction equipment to be used including:
  - Vendor(s)
  - Roller model(s),
  - Roller dimensions and weights,
  - Description of IC measurement system,
  - GPS capabilities,
  - Documentation system,
  - Software.
2. Roller data collection methods including sampling rates and intervals and data file types.
3. Transfer of data to the Engineer including method, timing, and personnel responsible. **Data transfer shall be provided by a real time cloud data collecting and distribution system (ex. Visionlink). The Contractor will provide the Cabinet with any vendor specific software, user id, passwords, etc. needed to access the data through this service, cost of this access is incidental to the IC bid item(s).**
4. Training plan and schedule for roller operators, project foreman, project surveyors, and Cabinet personnel; including both classroom and field training from the equipment manufacturer. Training should be conducted at least 1 week before beginning IC construction. The training is to be performed by a qualified representative(s) from the IC Roller manufacture(s) to be used on the project.

**4.0 CONSTRUCTION.** Prior to the start of production, ensure the proper setup of the GPS, IC roller(s) and the rover(s) by conducting joint GPS correlation and verification testing between the Contractor, GPS representative



and IC roller manufacturer using the same datum. Use the project datum system (Northing, Easting and Elevation) when applicable.

1. Ensure GPS correlation and verification testing includes the following minimum processes:
  - a. Establish the GPS system to be used either one with a base station or one with mobile receivers only. Ensure all components in the system are set to the correct coordinate system; then,
  - b. Verify that the roller and rover are working properly and that there is a connection with the base station; then,
  - c. Record the coordinates of the two edges where the front drum of the roller is in contact with the ground from the on-board, color-coded display; then,
  - d. Mark the locations of the roller drum edges and move the roller, and place the mobile receiver at each mark and record the readings; then; then,
2. Compare coordinates between the roller and rover receivers. If the coordinates are within 12.0 in. of each other, the comparison is acceptable. If the coordinates are not within 12.0 in., diagnose and perform necessary corrections and repeat the above steps until verification is acceptable.
3. Do not begin work until acceptable GPS correlation and verification has been obtained. The Contractor and the Department should conduct random GPS verification testing during production to ensure data locations are accurate. The recommended rate is once per day with a requirement of at least once per week.
4. A test strip is to be used for all materials (DGA, CSB, subgrade and soil) as outlined and sized in section 302.03.04 to determine optimum rolling pattern, for all materials, and the target density for aggregate bases. A new test strip will be required anytime the material changes, equipment changes, or proper compaction has not been obtained for two (2) consecutive test locations.
5. All acceptance testing shall be as outlined in Standard Specifications sections 200 and 300.
6. Any areas a minimum of 50 square feet in area not achieving the 80% of the stiffness value determined by the latest control strip shall be tested by other means approved by the Engineer. If the material doesn't pass the testing it shall be repaired based on current standards to the satisfaction of the Engineer.

**5.0 MEASUREMENT.** The Department will measure the total tons of aggregate base (DGA and/or CSB), total square yards of stabilized subgrade, and total cubic yards of soil compacted using the IC roller(s). The use of non-IC rollers is allowed on this project, but an IC roller must be used as well.

**6.0 PAYMENT.** The Department will make payment for the completed and accepted quantities under the following:

1. All areas with a minimum of 80% pass coverage and 75% required stiffness readings.
2. Payment is full compensation for all work associated with providing IC equipped rollers, transmission of electronic data files, two copies of IC roller manufacturer software, and training.
3. Delays due to GPS satellite reception of signals to operate the IC equipment or IC roller breakdowns will not be considered justification for contract modifications or contract extensions.

<u>Code</u>	<u>Pay Item</u>	<u>Pay Unit</u>
24779EC	Intelligent Compaction for Soil	Cubic Yard
24780EC	Intelligent Compaction for Aggregate	Ton
24990EC	Intelligent Comp Subgrade Stabilization	Square Yard

March 14, 2019

## SPECIAL NOTE FOR PAVER MOUNTED TEMPERATURE PROFILES

This Special Note will apply when indicated on the plans or in the proposal. Section references herein are to the Department's Standard Specifications for Road and Bridge Construction current edition.

**1.0 DESCRIPTION.** Provide a paver mounted infrared temperature equipment to continually monitor the temperature of the asphalt mat immediately behind all paver(s) during the placement operations for all mainline pavements (including ramps for Interstates and Parkways) within the project limits. Provide thermal profiles that include material temperature and measurement locations.

**2.0 MATERIALS AND EQUIPMENT.** In addition to the equipment specified in Subsection 403.02 Utilize a thermal equipment supplier that can provide a qualified representative for on-site technical assistance during the initial setup, pre-construction verification, and data management and processing as needed during the Project to maintain equipment within specifications and requirements.

Provide operator settings, user manuals, required viewing/export software for analysis. Ensure the temperature equipment will meet the following:

- A. A device with one or more infrared sensors that is capable of measuring in at least 1 foot intervals across the paving width, with a minimum width of 12 feet, or extending to the recording limits of the equipment, whichever is greater. A **Maximum of two (2)** brackets are allowed in the influence area under the sensors. A temperature profile must be made on at least 1 foot intervals longitudinally down the road:
- B. Infrared sensor(s):
  1. Measuring from 32°F to 400°F with an accuracy of  $\pm 2.0\%$  of the sensor reading.
- C. Ability to measure the following:
  1. The placement distance using a Global Positioning System (GPS) or a Distance Measuring Instrument (DMI) and a Global Positioning System (GPS).
  2. Stationing
- D. GPS: Accuracy  $\pm 4$  feet in the X and Y Direction
- E. Latest version of software to collect, display, retain and analyze the mat temperature readings during placement. The software must have the ability to create and analyze:
  1. Full collected width of the thermal profiles,
  2. Paver speed and
  3. Paver stops and duration for the entire Project.
- F. Ability to export data automatically to a remote data server ("the cloud").

At the preconstruction meeting, provide the Cabinet with rights to allow for web access to the data file location. Access to the data is not to be hindered in any way. The Contractor will provide the Cabinet with any vendor specific software, user id, passwords, etc. needed to access the data through this service, cost of this access is incidental to the thermal profile bid item. The Cabinet is to have access to all data as it is being collected. If a third party is used for collecting and distributing the data the Cabinet is to have the same access rights and time as the Contractor.

This web-based software must also provide the Department with the ability to download the raw files and software and to convert them into the correct format.
- G. The thermal profile data files must provide the following data in a neat easy to read table format.
  1. Project information including Road Name and Number, PCN, Beginning and Ending MPs.
  2. IR Bar Manufacturer and Model number
  3. Number of Temperature Sensors (N)
  4. Spacing between sensors and height of sensors above the asphalt mat
  5. Total number of individual records taken each day (DATA BLOCK)
    - a. Date and Time reading taken
    - b. Latitude and Longitude
    - c. Distance paver has moved from last test location
    - d. Direction and speed of the paver
    - e. Surface temperature of each of the sensors

**3.0 CONSTRUCTION.** Provide the Engineer with all required documentation at the pre-construction conference.

- A. Install and operate equipment in accordance with the manufacturer’s specifications.
- B. Verify that the temperature sensors are within ± 2.0% using an independent temperature device on a material of known temperature. Collect and compare the GPS coordinates from the equipment with an independent measuring device.
  - 1. Ensure the independent survey grade GPS measurement device is calibrated to the correct coordinate system (using a control point), prior to using these coordinates to validate the equipment GPS.
  - 2. The comparison is considered acceptable if the coordinates are within 4 feet of each other in the X and Y direction.
- C. Collect thermal profiles on all mainline pavements during the paving operation and transfer the data to the “cloud” network or if automatic data transmission is not available, transfer the data to the Engineer at the end of daily paving.
- D. Contact the Department immediately when System Failure occurs. Daily Percent Coverage will be considered zero when the repairs are not completed within two (2) working days of System Failure. The start of this two (2) working day period begins the next working day after System Failure.
- E. Evaluate thermal profile segments, every 150 feet, and summarize the segregation of temperature results. Results are to be labeled as Minimal 0°-25°F, Moderate 25.1°-50°F and Severe >50°. Severe readings over 3 consecutive segments or over 4 or more segments in a day warrant investigation on the cause of the differential temperature distribution.

**4.0 MEASUREMENT.** The Department will measure the total area of the pavement lanes mapped by the infrared scanners. Full payment will be provided for all lanes with greater than 85% coverage. Partial payment will be made for all areas covered from 50% coverage to 85% coverage at the following rate Coverage area percentage X Total bid amount. And area with less than 50% coverage will not be measured for payment.

**5.0 PAYMENT.** The Department will make payment for the completed and accepted quantities under the following:

- 1. Payment is full compensation for all work associated with providing all required equipment, training, and documentation.
- 2. Delays due to GPS satellite reception of signals or equipment breakdowns will not be considered justification for contract modifications or contract extensions.

<u>Code</u>	<u>Pay Item</u>	<u>Pay Unit</u>
24891EC	Pave Mount Infrared Temp Equipment	Square Foot

March 14, 2019

### **Special Note for Bridge Demolition, Renovation and Asbestos Abatement**

**If the project includes any bridge demolition or renovation, the successful bidder is required to notify Kentucky Division for Air Quality (KDAQ) via filing of form (DEP 7036) a minimum of 10 days prior to commencement of any bridge demolition or renovation work.**

**Any available information regarding possible asbestos containing materials (ACM) on or within bridges to be affected by the project has been included in the bid documents. These are to be included with the Contractor's notification filed with the KDAQ. If not included in the bid documents, the Department will provide that information to the successful bidder for inclusion in the KDAQ notice as soon as possible. If there are no documents stating otherwise, the bidders should assume there are no asbestos containing materials that will in any way affect the work.**



## TRANSPORTATION CABINET

Frankfort, Kentucky 40622  
www.transportation.ky.gov

**Steven L. Beshear**  
Governor

**Michael W. Hancock, P.E.**  
Secretary

# Memorandum

**To:** Brandon Baker  
**CC:** Tony Vinegar  
**From:** O'Dail Lawson  
Environmental Scientist II  
Division of Environmental Analysis  
**Date:** 7/21/2014  
**Re:** Asbestos Inspection Report for Magoffin 10-126.40

---

**This report is prepared to accompany the 10-Day NOI for Demolition to the Division of Air Quality. Please include all pages with submittal.**

### **Project and Structure Information**

**Project #** 10-126.40

**Bridge #** 077B00045N

**Description:** The concrete and paint samples collected were negative for asbestos. The Joint Compound and Guardrail Mastic samples were pointed counted below 1%. No abatement necessary.

**Inspection Date:** July 8<sup>th</sup>, 2014

### **Results**

The results show no ACM abatement is required.



***MRS, INC.***      *MRS, Inc. Analytical Laboratory Division*

332 West Broadway, Suite 613  
Louisville, Kentucky 40202

(502) 495-1212  
Fax: (502) 491-7111

**BULK SAMPLE ASBESTOS ANALYSIS**

Analysis N# 2107192A      Address: Magoffin Co./ Item # 10-126.40  
Client Name: KYTC      Bridge # 077 B00044N  
Sampled By: O'Dail Lawson

				% FIBROUS ASBESTOS				% NON-ASBESTOS FIBERS			
Number	Color	Layered	Fibrous	Chrysotile	Amosite	crocidolite	Others	Cellulose	Fiberglass	Syn. Fiber	Other/Mat.
M44-1	Gray	Yes	No				None				100%
M44-2	Gray	Yes	No				None				100%
M44-3	Black	Yes	No	3%	(To Be	Point Counted)		2%			95%
M44-4	Gray	Yes	No	3%	(To Be	Point Counted)		2%			95%
M44-5	Gray	Yes	No	3%	(To Be	Point Counted)		2%			95%
M44-6	Yellow	Yes	No				None				100%
M44-7	Gray	Yes	No				None				100%

Methodology : EPA Method 600/R-93-116  
Date Analyzed : 19-Jul-14  
Analyst : Winterford Mensah

Reviewed By:   
Signature

The test relates only to the items tested. This report does not represent endorsement by NVLAP or any agency of the U.S Government. Partial Reproduction of any part of this report is strictly prohibited. Samples shall be retained for (30) days.

***MRS, INC.*** *MRS, Inc. Analytical Laboratory Division*

332 West Broadway, Suite 613  
Louisville, Kentucky 40202

(502) 495-1212  
Fax: (502) 491-7111

<b>Client:</b>	<u>KY Transportation Cabinet</u>	<b>Project No:</b>	<u>2107192B</u>
<b>Address:</b>	<u>200 Mero Street</u>	<b>Sample ID:</b>	<u>M44 - 3</u>
	<u>Frankfort, KY</u>	<b>Sampled:</b>	<u>8-Jul-14</u>
	<u>40601</u>	<b>Received:</b>	<u>10-Jul-14</u>
	<u>Attention O'Dail Lawson</u>	<b>Analyzed:</b>	<u>19-Jul-14 - Point Count -</u>

**Bulk Sample Analysis**

**Sampled by:** O'Dail Lawson

**Facility/Location:** Magoffin County / Item # 10 - 126.40 / 077 B00044N

**Field Description:** Joint Compound

**Laboratory Description:**  
Thick Black Material

**Asbestos Materials:**  
Chrysotile = 2/400 = 0.50 % ( < 1 % ) Sample Is Negative

**Non-asbestos Fibrous Materials & Matrix Materials:**

<u>Cellulose</u>	<u>0.25 %</u>
<u>Binders</u>	<u>99.25 %</u>

**Remarks:** The sample was analyzed for asbestos content following the EPA Methodology (600/R-93/116). The test relates only to the items tested. This report does not represent endorsement by NVLAP or any agency of the U.S. Government.

**Analyst:** Winterford Mensah      **Reviewed By:**   
Signature

***MRS, INC.*** *MRS, Inc. Analytical Laboratory Division*

332 West Broadway, Suite 613  
Louisville, Kentucky 40202

(502) 495-1212  
Fax: (502) 491-7111

<b>Client:</b>	<u>KY Transportation Cabinet</u>	<b>Project No:</b>	<u>2107192B</u>
<b>Address:</b>	<u>200 Mero Street</u>	<b>Sample ID:</b>	<u>M44 - 4</u>
	<u>Frankfort, KY</u>	<b>Sampled:</b>	<u>8-Jul-14</u>
	<u>40601</u>	<b>Received:</b>	<u>10-Jul-14</u>
	<u>Attention O'Dail Lawson</u>	<b>Analyzed:</b>	<u>19-Jul-14 - Point Count -</u>

**Bulk Sample Analysis**

**Sampled by:** O'Dail Lawson

**Facility/Location:** Magoffin County / Item # 10 - 126.40 / 077 B00044N

**Field Description:** Guard Rail Mastic

**Laboratory Description:**  
Gray Material

**Asbestos Materials:**  
Chrysotile = 2/400 = 0.50 % ( < 1 % ) Sample Is Negative

**Non-asbestos Fibrous Materials & Matrix Materials:**

<u>Cellulose</u>	<u>0.25 %</u>
<u>Binders</u>	<u>99.25 %</u>

**Remarks:** The sample was analyzed for asbestos content following the EPA Methodology (600/R-93/116). The test relates only to the items tested. This report does not represent endorsement by NVLAP or any agency of the U.S. Government.

**Analyst:** Winterford Mensah      **Reviewed By:**   
Signature



***MRS, INC.*** *MRS, Inc. Analytical Laboratory Division*

332 West Broadway, Suite 613  
Louisville, Kentucky 40202

(502) 495-1212  
Fax: (502) 491-7111

<b>Client:</b>	<u>KY Transportation Cabinet</u>	<b>Project No:</b>	<u>2107192B</u>
<b>Address:</b>	<u>200 Mero Street</u>	<b>Sample ID:</b>	<u>M44-5</u>
	<u>Frankfort, KY</u>	<b>Sampled:</b>	<u>8-Jul-14</u>
	<u>40601</u>	<b>Received:</b>	<u>10-Jul-14</u>
	<u>Attention O'Dail Lawson</u>	<b>Analyzed:</b>	<u>19-Jul-14 - Point Count -</u>

**Bulk Sample Analysis**

**Sampled by:** O'Dail Lawson

**Facility/Location:** Magoffin County / Item # 10 - 126.40 / 077 B00044N

**Field Description:** Concrete Sealant

**Laboratory Description:**  
Gray Material

**Asbestos Materials:**  
Chrysotile = 2/400 = 0.50 % ( < 1 % ) Sample Is Negative

**Non-asbestos Fibrous Materials & Matrix Materials:**

<u>Cellulose</u>	<u>0.25 %</u>
<u>Binders</u>	<u>99.25 %</u>

**Remarks:** The sample was analyzed for asbestos content following the EPA Methodology (600/R-93/116). The test relates only to the items tested. This report does not represent endorsement by NVLAP or any agency of the U.S. Government.

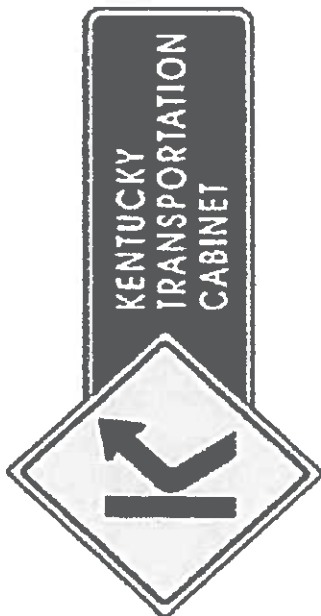

**Analyst:** Winterford Mensah      **Reviewed By:**   
Signature



# Chain of Custody Record

Kentucky Transportation Cabinet

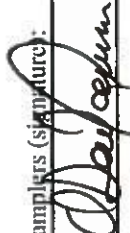
200 Metro Street, 5th Floor West  
Frankfort, Kentucky 40622  
(502) 564-7250 fax (502) 564-5655

O'Dail Lawson <a href="mailto:odail.lawson@ky.gov">odail.lawson@ky.gov</a> KYTC Address: 200 Metro Street Frankfort KY Phone: 502-782-5020 Fax: 502-564-5655 PO#:		Client Information KY TRANSPORTATION CABINET Results Code: ND = None Detected FTD = Filter Tampering or Damaged N/A = Not Applicable		077300045N			
Project or Subject Reference Magoffin		B00045N		10-126.40			
Samplers (signature): 		Analysis Requested Asbestos					
Sample ID	Sample Description	Collected		Matrix	Color	Cont. Type	Preservative
		Date	Time				
M45-1	Guard Rail Mastic	7-8-14	12:05	Mastic	Grey		N/A
M45-2	Joint Compound			Compound	Black		
M45-3	Paint Chip			Paint	Black		
M45-4	Concrete Spar			Concrete	Black		
M45-5	Concrete Abutment			Concrete	Grey		
M45-6	Concrete Rail			Concrete	Grey		
Relinquished By:		Date/Time:					
Received By: 		Date/Time: 7/10/14					
Relinquished By:		Date/Time:					
Received at Lab By:		Date/Time:					

# The EI Group, Inc.

This certifies that

## Tilmon O'Dail Lawson

Student Address: 132 Old Fort Drive, Georgetown, KY 40324

Has attended and satisfactorily passed an examination covering the contents of an EPA/AHERA approved course entitled

### Asbestos Inspector Refresher (4-Hour) Training Course

7213080011

Certificate Number

7910

Social Security Number

August 23, 2013

Course Dates

August 23, 2013

Exam Date

August 23, 2014

Expiration Date



Louisville, KY

Location

*Berry A. Maxwell*  
Berry Maxwell, Training Manager

*Kerri Boddy*  
Kerri Boddy, Principal Instructor

*Kerri Boddy*  
Kerri Boddy, Exam Administrator

3240 Office Point Place, Suite 200  
Louisville, KY 40220  
888-372-5859

Approved by:  
Indiana Department of Environmental Management



## TRANSPORTATION CABINET

Frankfort, Kentucky 40622  
www.transportation.ky.gov

**Steven L. Beshear**  
Governor

**Michael W. Hancock, P.E.**  
Secretary

# Memorandum

**To:** Brandon Baker  
**CC:** Tony Vinegar  
**From:** O'Dail Lawson  
Environmental Scientist II  
Division of Environmental Analysis  
**Date:** 7/25/2014  
**Re:** Asbestos Inspection Report for Magoffin 10-126.40

---

**This report is prepared to accompany the 10-Day NOI for Demolition to the Division of Air Quality. Please include all pages with submittal.**

### **Project and Structure Information**

**Project #** 10-126.40

**Bridge #** 077B00054N

**Description:** The concrete and paint samples collected were negative for asbestos. The Joint Compound, Guardrail Mastic, and Reflector Glue samples were pointed counted below 1%. No abatement necessary.

**Inspection Date:** July 1<sup>st</sup>, 2014

### **Results**

The results show no ACM abatement is required.



<span style="font-size: 1.5em; font-weight: bold; font-family: serif;"><i>MRS, INC.</i></span> <span style="margin-left: 20px; font-family: serif;"><i>MRS, Inc. Analytical Laboratory Division</i></span>
--

332 West Broadway, Suite 613 (502) 495-1212  
 Louisville, Kentucky 40202 Fax: (502) 491-7111

**BULK SAMPLE ASBESTOS ANALYSIS**

Analysis N#	2107258A	Address:	Magoffin Co./Item # 10-126.40
Client Name:	KYTC		Bridge # B00054N
Sampled By:	O'Dail Lawson		

				% FIBROUS ASBESTOS				% NON-ASBESTOS FIBERS			
Number	Color	Layered	Fibrous	Chrysotile	Amosite	crocidolite	Others	Cellulose	Fiberglass	Syn. Fiber	Other/Mat.
M54-1	Yellow	Yes	No				None				100%
M54-2	Gray	Yes	No				None				100%
M54-3	Yellow	Yes	No				None				100%
M54-4	Gray	Yes	No	3%	(To Be	Point Counted)		2%			95%
M54-5	Black	Yes	No	3%	(To Be	Point Counted)		2%			95%
M54-6	Gray	Yes	No				None				100%
M54-7	Gray	Yes	No				None				100%
M54-8	Gray	Yes	No	3%	(To Be	Point Counted)		2%			95%

Methodology : EPA Method 600/R-93-116  
 Date Analyzed : 25-Jul-14  
 Analyst : Winterford Mensah

Reviewed By:   
Signature

The test relates only to the items tested. This report does not represent endorsement by NVLAP or any agency of the U.S Government. Partial Reproduction of any part of this report is strictly prohibited. Samples shall be retained for (30) days.

***MRS, INC.*** *MRS, Inc. Analytical Laboratory Division*

332 West Broadway, Suite 613  
Louisville, Kentucky 40202

(502) 495-1212  
Fax: (502) 491-7111

<b>Client:</b>	<u>KY Transportation Cabinet</u>	<b>Project No:</b>	<u>2107258B</u>
<b>Address:</b>	<u>200 Mero Street</u>	<b>Sample ID:</b>	<u>M54-4</u>
	<u>Frankfort, KY</u>	<b>Sampled:</b>	<u>15-Jul-14</u>
	<u>40601</u>	<b>Received:</b>	<u>19-Jul-14</u>
	<u>Attention O'Dail Lawson</u>	<b>Analyzed:</b>	<u>25-jul-14 - Point Count -</u>

**Bulk Sample Analysis**

**Sampled by:** O'Dail Lawson

**Facility/Location:** Magoffin County/ Item # 10-126.40 Bridge # 077 B00054N

**Field Description:** Guard Rail Mastic - East Side Of The Structure

**Laboratory Description:**  
Gray Material

**Asbestos Materials:**  
Chrysotile = 2/400 = 0.50 % ( < 1 % ) Sample Is Negative

**Non-asbestos Fibrous Materials & Matrix Materials:**

<u>Cellulose</u>	<u>0.25 %</u>
<u>Binders</u>	<u>99.25 %</u>

**Remarks:** The sample was analyzed for asbestos content following the EPA Methodology (600/R-93/116). The test relates only to the items tested. This report does not represent endorsement by NVLAP or any agency of the U.S. Government.

**Analyst:** Winterford Mensah      **Reviewed By:**   
Signature

***MRS, INC.*** *MRS, Inc. Analytical Laboratory Division*

332 West Broadway, Suite 613  
Louisville, Kentucky 40202

(502) 495-1212  
Fax: (502) 491-7111

<b>Client:</b>	<u>KY Transportation Cabinet</u>	<b>Project No:</b>	<u>2107258B</u>
<b>Address:</b>	<u>200 Mero Street</u>	<b>Sample ID:</b>	<u>M54-5</u>
	<u>Frankfort, KY</u>	<b>Sampled:</b>	<u>15-Jul-14</u>
	<u>40601</u>	<b>Received:</b>	<u>19-Jul-14</u>
	<u>Attention O'Dail Lawson</u>	<b>Analyzed:</b>	<u>25-jul-14 - Point Count -</u>

**Bulk Sample Analysis**

**Sampled by:** O'Dail Lawson

**Facility/Location:** Magoffin County/ Item # 10-126.40 Bridge # 077 B00054N

**Field Description:** Joint Compound - East Side Of The Structure

**Laboratory Description:**  
Gray Material

**Asbestos Materials:**  
Chrysotile = 2/400 = 0.50 % ( < 1 % ) Sample Is Negative

**Non-asbestos Fibrous Materials & Matrix Materials:**

<u>Cellulose</u>	<u>0.25 %</u>
<u>Binders</u>	<u>99.25 %</u>

**Remarks:** The sample was analyzed for asbestos content following the EPA Methodology (600/R-93/116). The test relates only to the items tested. This report does not represent endorsement by NVLAP or any agency of the U.S. Government.

**Analyst:** Winterford Mensah      **Reviewed By:**   
Signature

***MRS, INC.*** *MRS, Inc. Analytical Laboratory Division*

332 West Broadway, Suite 613  
Louisville, Kentucky 40202

(502) 495-1212  
Fax: (502) 491-7111

<b>Client:</b>	<u>KY Transportation Cabinet</u>	<b>Project No:</b>	<u>2107258B</u>
<b>Address:</b>	<u>200 Mero Street</u>	<b>Sample ID:</b>	<u>M54-8</u>
	<u>Frankfort, KY</u>	<b>Sampled:</b>	<u>15-Jul-14</u>
	<u>40601</u>	<b>Received:</b>	<u>19-Jul-14</u>
	<u>Attention O'Dail Lawson</u>	<b>Analyzed:</b>	<u>25-jul-14 - Point Count -</u>

**Bulk Sample Analysis**

**Sampled by:** O'Dail Lawson

**Facility/Location:** Magoffin County/ Item # 10-126.40 Bridge # 077 B00054N

**Field Description:** Glue Reflector Light - East Side Of The Structure

**Laboratory Description:**  
Gray Material

**Asbestos Materials:**  
Chrysotile = 2/400 = 0.50 % ( < 1 % ) Sample Is Negative

**Non-asbestos Fibrous Materials & Matrix Materials:**

<u>Cellulose</u>	<u>0.25 %</u>
<u>Binders</u>	<u>99.25 %</u>

**Remarks:** The sample was analyzed for asbestos content following the EPA Methodology (600/R-93/116). The test relates only to the items tested. This report does not represent endorsement by NVLAP or any agency of the U.S. Government.

**Analyst:** Winterford Mensah      **Reviewed By:**   
Signature



# Chain of Custody Record

## Kentucky Transportation Cabinet

200 Metro Street, 5th Floor West  
Frankfort, Kentucky 40622  
(502) 564-7250 fax (502) 564-5655



**KENTUCKY  
TRANSPORTATION  
CABINET**

<b>Client Information</b> KY TRANSPORTATION CABINET Results Code: <b>54</b> ND = None Detected FTD = Filler Tampering or Damaged N/A = Not Applicable		Project or Subject Reference: <b>10-126.4 B00054N</b> PO#: <b>Magoffin</b>		Samplers (signature): <i>[Signature]</i>			
O'Daill Lawson KYTC 200 Metro Street Frankfort KY Phone: 502-782-5020 Fax: 502-564-5655	o'daill.lawson@ky.gov	Date: 7-15-14 Time: 12:15	Analysis Requested: <b>Asbestos - East side of Structure</b>	Matrix:	Color:	Cont. Type:	Preservative:
MS4-1	Paint Chip			Paint	Black	N/A	
MS4-2	Concrete Wing Wall			Concrete	Grey		
MS4-3	Concrete Abutment			Concrete	Grey		
MS4-4	Guard Rail Mastic			Mastic	Grey		
MS4-5	Joint Compound			Compound	Black		
MS4-6	Concrete Spn			Concrete	Grey		
MS4-7	Concrete Rail			Concrete	Grey		
MS4-8	Glue <sup>for Reflectors</sup> Compound Light			Glue	Grey		
Relinquished By:		Date/Time:					
Received By: <i>[Signature]</i>		Date/Time: 7/17/14					
Relinquished By:		Date/Time:					
Received at Lab By:		Date/Time:					

# *The EI Group, Inc.*

This certifies that

## *Tilmon O'Dail Lawson*

Student Address: 132 Old Fort Drive, Georgetown, KY 40324

Has attended and satisfactorily passed an examination covering the contents of an EPA/AHERA approved course entitled

### *Asbestos Inspector Refresher (4-Hour) Training Course*

7213080011  
Certificate Number

7910  
Social Security Number

August 23, 2013  
Course Dates

August 23, 2013  
Exam Date

August 23, 2014  
Expiration Date



Louisville,, KY  
Location

*Berry A. Maxwell*  
Berry Maxwell, Training Manager

*Kerri Boddy*  
Kerri Boddy, Principal Instructor

*Kerri Boddy*  
Kerri Boddy, Exam Administrator

3240 Office Point Place, Suite 200  
Louisville, KY 40220  
888-372-5859

Approved by:  
Indiana Department of Environmental Management



**TRANSPORTATION CABINET**

Frankfort, Kentucky 40622  
www.transportation.ky.gov

**Steven L. Beshear**  
Governor

**Michael W. Hancock, P.E.**  
Secretary

## Memorandum

**To:** Brandon Baker  
**CC:** Tony Vinegar  
**From:** O'Dail Lawson  
Environmental Scientist II  
Division of Environmental Analysis  
**Date:** 7/25/2014  
**Re:** Asbestos Inspection Report for Magoffin 10-126.40

---

**This report is prepared to accompany the 10-Day NOI for Demolition to the Division of Air Quality. Please include all pages with submittal.**

### **Project and Structure Information**

**Project #** 10-126.40

**Bridge #** 077B00050N

**Description:** The concrete and paint samples collected were negative for asbestos. The Guardrail Mastic, and Concrete Sealant samples were pointed counted below 1%. No abatement necessary.

**Inspection Date:** July 15<sup>th</sup>, 2014

### **Results**

The results show no ACM abatement is required.



***MRS, INC.***      *MRS, Inc. Analytical Laboratory Division*

332 West Broadway, Suite 613  
Louisville, Kentucky 40202

(502) 495-1212  
Fax: (502) 491-7111

**BULK SAMPLE ASBESTOS ANALYSIS**

Analysis N#      2107257A      Address: Magoffin Co. Item # 10-126.40  
 Client Name:    KYTC      Bridge # B00050N  
 Sampled By:     O'Dail Lawson

		% FIBROUS ASBESTOS						% NON-ASBESTOS FIBERS			
Number	Color	Layered	Fibrous	Chrysotile	Amosite	crocidolite	Others	Cellulose	Fiberglass	Syn. Fiber	Other/Mat.
M50-1	Yellow	Yes	No				None				100%
M50-2	Gray	Yes	No	3%	(To Be	Point Counted)		2%			95%
M50-3	Gray	Yes	No				None				100%
M50-4	Gray	Yes	No				None				100%
M50-5	Gray	Yes	No	3%	(To Be	Point Counted)		2%			95%

Methodology : EPA Method 600/R-93-116  
 Date Analyzed : 25-Jul-14  
 Analyst : Winterford Mensah

Reviewed By:   
Signature

The test relates only to the items tested. This report does not represent endorsement by NVLAP or any agency of the U.S Government. Partial Reproduction of any part of this report is strictly prohibited. Samples shall be retained for (30) days.

***MRS, INC.*** *MRS, Inc. Analytical Laboratory Division*

332 West Broadway, Suite 613  
Louisville, Kentucky 40202

(502) 495-1212  
Fax: (502) 491-7111

**Client:** KY Transportation Cabinet  
**Address:** 200 Mero Street  
Frankfort, KY  
40601  
Attention O'Dail Lawson

**Project No:** 2107257A  
**Sample ID:** M50-2  
**Sampled:** 15-Jul-14  
**Received:** 19-Jul-14  
**Analyzed:** 25-Jul-14 - Point Count -

**Bulk Sample Analysis**

**Sampled by:** O'Dail Lawson

**Facility/Location:** Magoffin County/ Item # 10 - 126.40 088 B00050N

**Field Description:** Guard Rail Mastic - North West Side Of The Structure

**Laboratory Description:**  
Gray Material

**Asbestos Materials:**  
Chrysotile = 2/400 = 0.50 % ( < 1 % ) Sample Is Negative

**Non-asbestos Fibrous Materials & Matrix Materials:**

<u>Cellulose</u>	<u>0.25 %</u>
<u>Binders</u>	<u>99.25 %</u>

**Remarks:** The sample was analyzed for asbestos content following the EPA Methodology (600/R-93/116). The test relates only to the items tested. This report does not represent endorsement by NVLAP or any agency of the U.S. Government.

**Analyst:** Winterford Mensah      **Reviewed By:**   
Signature

***MRS, INC.*** *MRS, Inc. Analytical Laboratory Division*

332 West Broadway, Suite 613  
Louisville, Kentucky 40202

(502) 495-1212  
Fax: (502) 491-7111

<b>Client:</b>	<u>KY Transportation Cabinet</u>	<b>Project No:</b>	<u>2107257A</u>
<b>Address:</b>	<u>200 Mero Street</u>	<b>Sample ID:</b>	<u>M50-5</u>
	<u>Frankfort, KY</u>	<b>Sampled:</b>	<u>15-Jul-14</u>
	<u>40601</u>	<b>Received:</b>	<u>19-Jul-14</u>
	<u>Attention O'Dail Lawson</u>	<b>Analyzed:</b>	<u>25-Jul-14 - Point Count -</u>

**Bulk Sample Analysis**

**Sampled by:** O'Dail Lawson

**Facility/Location:** Magoffin County / Item # 10 - 126.40 B00050N

**Field Description:** Concrete Sealant - North West Side Of The Structure

**Laboratory Description:**  
Gray Material

**Asbestos Materials:**  
Chrysotile = 2/400 = 0.50 % ( < 1 % ) Sample Is Negative

**Non-asbestos Fibrous Materials & Matrix Materials:**

<u>Cellulose</u>	<u>0.25 %</u>
<u>Binders</u>	<u>99.25 %</u>

**Remarks:** The sample was analyzed for asbestos content following the EPA Methodology (600/R-93/116). The test relates only to the items tested. This report does not represent endorsement by NVLAP or any agency of the U.S. Government.

**Analyst:** Winterford Mensah      **Reviewed By:**   
Signature



# Chain of Custody Record

Kentucky Transportation Cabinet

200 Mero Street, 5th Floor West  
Frankfort, Kentucky 40622  
(502) 564-7250 fax (502) 564-5655

O'Dail Lawson o'dail.lawson@ky.gov KYTC 200 Mero Street Frankfort KY Phone: 502-782-5020 Fax: 502-564-5655 PO#:		Client Information KY TRANSPORTATION CABINET Results Code: ND = None Detected FTD = Filter Tampering or Damaged N/A = Not Applicable		Project or Subject Reference Magoffin		KYTC 077 B00050N Samplers (signature): <i>[Signature]</i>			
Date/Time Collected 7/15/14 12:75		Analysis Requested Asbestos - North West Side of Skidway		Matrix Paint		Color Yellow		Cont. Type N/A	
Sample ID	Sample Description	Date	Time	Matrix	Color	Cont. Type	Preservative		
M50-1	Paint Chip	7/15/14	12:75	Paint	Yellow		N/A		
M50-2	Guard Rail Mastic			Mastic	Grey				
M50-3	Concrete Rail			Concrete	Grey				
M50-4	Concrete Wing Wall			Concrete	Grey				
M50-5	Concrete Sealant			Concrete	Grey				
Relinquished By:		Date/Time:							
Received By: <i>[Signature]</i>		Date/Time: 7/17/14							
Relinquished By:		Date/Time:							
Received at Lab By:		Date/Time:							

# The EI Group, Inc.

This certifies that

## Tilmon O'Dail Lawson

Student Address: 132 Old Fort Drive, Georgetown, KY 40324

Has attended and satisfactorily passed an examination covering the contents of an EPA/AHERA approved course entitled

### Asbestos Inspector Refresher (4-Hour) Training Course

7213080011  
Certificate Number

7910  
Social Security Number

August 23, 2013  
Course Dates

August 23, 2013  
Exam Date

August 23, 2014  
Expiration Date



Louisville, KY  
Location

*Barry A. Maxwell*  
Barry Maxwell, Training Manager

*Kerri Boddy*  
Kerri Boddy, Principal Instructor

*Kerri Boddy*  
Kerri Boddy, Exam Administrator

3240 Office Point Place, Suite 200  
Louisville, KY 40220  
888-372-5859

Approved by:  
Indiana Department of Environmental Management





## TRANSPORTATION CABINET

Frankfort, Kentucky 40622  
www.transportation.ky.gov

**Steven L. Beshear**  
Governor

**Michael W. Hancock, P.E.**  
Secretary

# Memorandum

**To:** Brandon Baker  
**CC:** Tony Vinegar  
**From:** O'Dail Lawson  
Environmental Scientist II  
Division of Environmental Analysis  
**Date:** 7/25/2014  
**Re:** Asbestos Inspection Report for Magoffin 10-126.40

---

**This report is prepared to accompany the 10-Day NOI for Demolition to the Division of Air Quality. Please include all pages with submittal.**

### **Project and Structure Information**

**Project #** 10-126.40

**Bridge #** 077B00049N

**Description:** The concrete samples collected were negative for asbestos. No abatement necessary.

**Inspection Date:** July 15<sup>th</sup>, 2014

### **Results**

The results show no ACM abatement is required.



<b style="font-size: 1.2em;">MRS, INC.</b> <i>MRS, Inc. Analytical Laboratory Division</i>
--

332 West Broadway, Suite 613  
Louisville, Kentucky 40202

(502) 495-1212  
Fax: (502) 491-7111

### BULK SAMPLE ASBESTOS ANALYSIS

Analysis N#	<u>2107256A</u>	Address:	<u>Magoffin County/ Item # 126.40</u>
Client Name:	<u>KYTC</u>		<u>Bridge # 077 B00049N</u>
Sampled By:	<u>O'Dail Lawson</u>		

				% FIBROUS ASBESTOS				% NON-ASBESTOS FIBERS			
Number	Color	Layered	Fibrous	Chrysotile	Amosite	crocidolite	Others	Cellulose	Fiberglass	Syn. Fiber	Other/Mat.
M49-1	Gray	Yes	No				None				100%
M49-2	Gray	Yes	No				None				100%
M49-3	Gray	Yes	No				None				100%

Methodology : EPA Method 600/R-93-116  
 Date Analyzed : 25-Jul-14  
 Analyst : Winterford Mensah

Reviewed By:   
Signature

The test relates only to the items tested. This report does not represent endorsement by NVLAP or any agency of the U.S Government. Partial Reproduction of any part of this report is strictly prohibited. Samples shall be retained for (30) days.

# Chain of Custody Record

## Kentucky Transportation Cabinet

200 Mero Street, 5th Floor West  
Frankfort, Kentucky 40622  
(502) 564-7250 fax (502) 564-5655



<b>O'Dail Lawson</b> o'dail.lawson@ky.gov KYTC 200 Mero Street Frankfort KY Phone: 502-782-5020 Fax: 502-564-5655 PO#:		<b>Client Information</b> KY TRANSPORTATION CABINET Results Code: ND = None Detected FTD = Filter Tampering or Damaged N/A = Not Applicable		077 B00049N				
Project or Subject Reference Magoffin		B00049N 10-126.40		Samplers (signature): 				
Sample ID	Sample Description	Collected		Analysis Requested	Matrix	Color	Cont. Type	Preservative
		Date	Time					
M49-1	Concrete <sup>Magoffin</sup> Abutment	7/15/14	12:45	Asbestos - East side of Structure	Concrete	Grey		N/A
M49-2	Concrete Wing Wall	↓	↓		Concrete	Grey		
M49-3	concrete pier	↓	↓		Concrete	Grey		
Relinquished By:		Date/Time:						
Received By:		Date/Time: 7/19/14						
Relinquished By:		Date/Time:						
Received at Lab By:		Date/Time:						

# *The EI Group, Inc.*

This certifies that

## *Tilmon O'Dail Lawson*

Student Address: 132 Old Fort Drive, Georgetown, KY 40324

Has attended and satisfactorily passed an examination covering the contents of an EPA/AHERA approved course entitled

### *Asbestos Inspector Refresher (4-Hour) Training Course*

7213080011

Certificate Number

7910

Social Security Number

August 23, 2013

Course Dates

August 23, 2013

Exam Date

August 23, 2014

Expiration Date



Louisville, KY

Location

*Barry A. Maxwell*  
Barry Maxwell, Training Manager

*Kerri Boddy*  
Kerri Boddy, Principal Instructor

*Kerri Boddy*  
Kerri Boddy, Exam Administrator

3240 Office Point Place, Suite 200  
Louisville, KY 40220  
888-372-5859

Approved by:  
Indiana Department of Environmental Management



**TRANSPORTATION CABINET**

Frankfort, Kentucky 40622  
www.transportation.ky.gov/

**Steven L. Beshear**  
Governor

**Michael W. Hancock, P.E.**  
Secretary

## Memorandum

**To:** Brandon Baker  
**CC:** Tony Vinegar  
**From:** O'Dail Lawson  
Environmental Scientist II  
Division of Environmental Analysis  
**Date:** 7/21/2014  
**Re:** Asbestos Inspection Report for Magoffin 10-126.40

---

**This report is prepared to accompany the 10-Day NOI for Demolition to the Division of Air Quality. Please include all pages with submittal.**

### **Project and Structure Information**

**Project #** 10-126.40

**Bridge #** 077B00048N

**Description:** The concrete samples collected were negative for asbestos. Samples of Concrete Sealant, Guard Rail Mastic, and Joint Compound were collected and required a point count. The results of the point counts were all negative. No abatement necessary.

**Inspection Date:** July 8<sup>th</sup>, 2014

### **Results**

The results show no ACM abatement is required.



**MRS, INC.**      *MRS, Inc. Analytical Laboratory Division*

332 West Broadway, Suite 613  
Louisville, Kentucky 40202

(502) 495-1212  
Fax: (502) 491-7111

**BULK SAMPLE ASBESTOS ANALYSIS**

Analysis N#      2107196A      Address: Magoffin Co.,/ Item # 10-126.40  
Client Name:      KYTC      Bridge # 077 B00048N  
Sampled By:      O'Dail Lawson

Number	Color	Layered	Fibrous	% FIBROUS ASBESTOS				% NON-ASBESTOS FIBERS			
				Chrysotile	Amosite	crocidolite	Others	Cellulose	Fiberglass	Syn. Fiber	Other/Mat.
M48-1	Yellow	Yes	No				None				100%
M48-2	Gray	Yes	No	3%	(To Be	Point Counted)		2%			95%
M48-3	Yellow	Yes	No	3%	(To Be	Point Counted)		2%			95%
M48-4	Gray	Yes	No	3%	(To Be	Point Counted)		2%			95%
M48-5	Black	Yes	No				None				100%
M48-6	Gray	Yes	No				None				100%
M48-7	Gray	Yes	No				None				100%

Methodology : EPA Method 600/R-93-116  
Date Analyzed : 19-Jul-14  
Analyst : Winterford Mensah

Reviewed By:   
Signature

The test relates only to the items tested. This report does not represent endorsement by NVLAP or any agency of the U.S Government. Partial Reproduction of any part of this report is strictly prohibited. Samples shall be retained for (30) days.

AIHA # 102459

AJHA #1 02459

***MRS, INC.*** *MRS, Inc. Analytical Laboratory Division*

332 West Broadway, Suite 613  
Louisville, Kentucky 40202

(502) 495-1212  
Fax: (502) 491-7111

**Client:** KY Transportation Cabinet  
**Address:** 200 Mero Street  
Frankfort, KY  
40601  
Attention O'Dail Lawson

**Project No:** 2107196B  
**Sample ID:** M48 - 4  
**Sampled:** 8-Jul-14  
**Received:** 10-Jul-14  
**Analyzed:** 19-Jul-14 - Point Count -

**Bulk Sample Analysis**

**Sampled by:** O'Dail Lawson  
**Facility/Location:** Magoffin County / Item # 10 - 126.40 B00048N  
**Field Description:** Joint Compound

**Laboratory Description:**  
Black Material

**Asbestos Materials:**  
Chrysotile = 2/400 = 0.50 % ( < 1 % ) Sample Is Negative

**Non-asbestos Fibrous Materials & Matrix Materials:**  

Cellulose	0.25 %
Binders	99.25 %

**Remarks:** The sample was analyzed for asbestos content following the EPA Methodology (600/R-93/116). The test relates only to the items tested. This report does not represent endorsement by NVLAP or any agency of the U.S. Government.

**Analyst:** Winterford Mensah

**Reviewed By:**   
Signature

***MRS, INC.*** *MRS, Inc. Analytical Laboratory Division*

332 West Broadway, Suite 613  
Louisville, Kentucky 40202

(502) 495-1212  
Fax: (502) 491-7111

<b>Client:</b>	<u>KY Transportation Cabinet</u>	<b>Project No:</b>	<u>2107196B</u>
<b>Address:</b>	<u>200 Mero Street</u>	<b>Sample ID:</b>	<u>M48 - 2</u>
	<u>Frankfort, KY</u>	<b>Sampled:</b>	<u>8-Jul-14</u>
	<u>40601</u>	<b>Received:</b>	<u>10-Jul-14</u>
	<u>Attention O'Dail Lawson</u>	<b>Analyzed:</b>	<u>19-Jul-14 - Point Count -</u>

**Bulk Sample Analysis**

**Sampled by:** O'Dail Lawson

**Facility/Location:** Magoffin County / Item # 10 - 126.40 B00048N

**Field Description:** Concrete Sealant

**Laboratory Description:**  
Gray Material

**Asbestos Materials:**  
Chrysotile = 2/400 = 0.50 % ( < 1 % ) Sample Is Negative

**Non-asbestos Fibrous Materials & Matrix Materials:**

<u>Cellulose</u>	<u>0.25 %</u>
<u>Binders</u>	<u>99.25 %</u>

**Remarks:** The sample was analyzed for asbestos content following the EPA Methodology (600/R-93/116). The test relates only to the items tested. This report does not represent endorsement by NVLAP or any agency of the U.S. Government.

**Analyst:** Winterford Mensah      **Reviewed By:**   
Signature



***MRS, INC.*** *MRS, Inc. Analytical Laboratory Division*

332 West Broadway, Suite 613  
Louisville, Kentucky 40202

(502) 495-1212  
Fax: (502) 491-7111

<b>Client:</b>	<u>KY Transportation Cabinet</u>	<b>Project No:</b>	<u>2107196B</u>
<b>Address:</b>	<u>200 Mero Street</u>	<b>Sample ID:</b>	<u>M48 - 3</u>
	<u>Frankfort, KY</u>	<b>Sampled:</b>	<u>8-Jul-14</u>
	<u>40601</u>	<b>Received:</b>	<u>10-Jul-14</u>
	<u>Attention O'Dail Lawson</u>	<b>Analyzed:</b>	<u>19-Jul-14 - Point Count -</u>

**Bulk Sample Analysis**

**Sampled by:** O'Dail Lawson

**Facility/Location:** Magoffin County / Item # 10 - 126.40 B00048N

**Field Description:** Guard Rail Mastic

**Laboratory Description:**  
Gray Material

**Asbestos Materials:**  
Chrysotile = 2/400 = 0.50 % ( < 1 % ) Sample Is Negative

**Non-asbestos Fibrous Materials & Matrix Materials:**

<u>Cellulose</u>	<u>0.25 %</u>
<u>Binders</u>	<u>99.25 %</u>

**Remarks:** The sample was analyzed for asbestos content following the EPA Methodology (600/R-93/116). The test relates only to the items tested. This report does not represent endorsement by NVLAP or any agency of the U.S. Government.

**Analyst:** Winterford Mensah      **Reviewed By:**   
Signature

# Chain of Custody Record

Kentucky Transportation Cabinet

200 Mero Street, 5th Floor West  
Frankfort, Kentucky 40622  
(502) 564-7250 fax (502) 564-5655



**KENTUCKY  
TRANSPORTATION  
CABINET**

O'Dail Lawson <a href="mailto:odail.lawson@ky.gov">odail.lawson@ky.gov</a> KYTC 200 Mero Street Frankfort KY Phone: 502-782-5020 Fax: 502-564-5655 PO#:		Client Information KY TRANSPORTATION CABINET Results Code: 027 BOOBYGN ND = None Detected FTD = Filter Tampering or Damaged N/A = Not Applicable		Samplers (signature): <i>[Signature]</i>			
Project or Subject Reference Mesof: n 10-126, #0 BOOBYGN		Analysis Requested Asbestos					
Sample ID	Sample Description	Collected		Matrix	Color	Cont. Type	Preservative
		Date	Time				
M48-1	Paint Chip	7-8-14	1:55	Paint	Yellow		N/A
M48-2	Concrete Sealant			Compound	<del>Black</del>		
M48-3	Overd Rail Mastic			Mastic	Grey		
M48-4	Joint Compound			<del>Compound</del>	Black		
				Compound			
M48-5	Curb Concrete			Concrete	Grey		
M48-6	Concrete Audit Point			Concrete	Grey		
M48-7	Concrete Wing Wall			Concrete	Grey		
Relinquished By:		Date/Time:					
Received By: <i>[Signature]</i>		Date/Time: 7/10/14					
Relinquished By:		Date/Time:					
Received at Lab By:		Date/Time:					

# The EI Group, Inc.

This certifies that

## Tilmon O'Dail Lawson

Student Address: 132 Old Fort Drive, Georgetown, KY 40324

Has attended and satisfactorily passed an examination covering the contents of an EPA/AHERA approved course entitled

### Asbestos Inspector Refresher (4-Hour) Training Course

7213080011  
Certificate Number

7910  
Social Security Number

August 23, 2013  
Course Dates

August 23, 2013  
Exam Date

August 23, 2014  
Expiration Date



Louisville, KY  
Location

*Bery A. Maxwell*  
Bery Maxwell, Training Manager

*Kerr Boddy*  
Kerr Boddy, Principal Instructor

*Kerr Boddy*  
Kerr Boddy, Exam Administrator

3240 Office Point Place, Suite 200  
Louisville, KY 40220  
888-372-5859

Approved by:  
Indiana Department of Environmental Management



## TRANSPORTATION CABINET

Frankfort, Kentucky 40622  
www.transportation.ky.gov

**Steven L. Beshear**  
Governor

**Michael W. Hancock, P.E.**  
Secretary

# Memorandum

**To:** Brandon Baker  
**CC:** Tony Vinegar  
**From:** O'Dail Lawson  
Environmental Scientist II  
Division of Environmental Analysis  
**Date:** 7/21/2014  
**Re:** Asbestos Inspection Report for Magoffin 10-126.40

---

**This report is prepared to accompany the 10-Day NOI for Demolition to the Division of Air Quality. Please include all pages with submittal.**

### **Project and Structure Information**

**Project # 10-126.40**

**Bridge # 077B00047N**

**Description:** The concrete samples collected were negative for asbestos. Samples of Concrete Sealant, Guard Rail Mastic, and Joint Compound were collected and required a point count. The results of the point counts were all negative. No abatement necessary.

**Inspection Date:** July 8<sup>th</sup>, 2014

### **Results**

The results show no ACM abatement is required.



<b style="font-size: 1.2em;">MRS, INC.</b> <i>MRS, Inc. Analytical Laboratory Division</i>
--

332 West Broadway, Suite 613  
Louisville, Kentucky 40202

(502) 495-1212  
Fax: (502) 491-7111

### BULK SAMPLE ASBESTOS ANALYSIS

Analysis N#	2107195A	Address:	Magoffin Co.,/ Item # 10-126.40
Client Name:	KYTC		Bridge # B 07700047N (44)
Sampled By:	O'Dail Lawson		

				% FIBROUS ASBESTOS				% NON-ASBESTOS FIBERS			
Number	Color	Layered	Fibrous	Chrysotile	Amosite	crocidolite	Others	Cellulose	Fiberglass	Syn. Fiber	Other/Mat.
M47-1	Gray	Yes	No				None				100%
M47-2	Gray	Yes	No				None				100%
M47-3	Yellow	Yes	No				None				100%
M47-4	Gray	Yes	No	3%	(To Be	Point Counted)		2%			95%
M47-5	Black	Yes	No	3%	(To Be	Point Counted)		2%			95%
M47-6	Gray	Yes	No				None				100%
M47-7	Gray	Yes	No	3%	(To Be	Point Counted)		2%			95%

Methodology : EPA Method 600/R-93-116  
 Date Analyzed : 19-Jul-14  
 Analyst : Winterford Mensah

Reviewed By:   
Signature

The test relates only to the items tested. This report does not represent endorsement by NVLAP or any agency of the U.S Government. Partial Reproduction of any part of this report is strictly prohibited. Samples shall be retained for (30) days.

***MRS, INC.*** *MRS, Inc. Analytical Laboratory Division*

332 West Broadway, Suite 613  
Louisville, Kentucky 40202

(502) 495-1212  
Fax: (502) 491-7111

<b>Client:</b>	<u>KY Transportation Cabinet</u>	<b>Project No:</b>	<u>2107195B</u>
<b>Address:</b>	<u>200 Mero Street</u>	<b>Sample ID:</b>	<u>M47-4</u>
	<u>Frankfort, KY</u>	<b>Sampled:</b>	<u>8-Jul-14</u>
	<u>40601</u>	<b>Received:</b>	<u>10-Jul-14</u>
	<u>Attention O'Dail Lawson</u>	<b>Analyzed:</b>	<u>19-Jul-14 - Point Count -</u>

**Bulk Sample Analysis**

**Sampled by:** O'Dail Lawson

**Facility/Location:** Magoffin County / Item # 10-126.40 . 077B00047N

**Field Description:** Guard Rail Mastic

**Laboratory Description:**  
Gray Material

---

**Asbestos Materials:**  
Chrysotile = 2/400 = 0.50 % ( < 1 % ) Sample Is Negative

---

**Non-asbestos Fibrous Materials & Matrix Materials:**

<u>Cellulose</u>	<u>0.25 %</u>
<u>Binders</u>	<u>99.25 %</u>

---

**Remarks:** The sample was analyzed for asbestos content following the EPA Methodology (600/R-93/116). The test relates only to the items tested. This report does not represent endorsement by NVLAP or any agency of the U.S. Government.

**Analyst:** Winterford Mensah      **Reviewed By:**   
Signature

***MRS, INC.*** *MRS, Inc. Analytical Laboratory Division*

332 West Broadway, Suite 613  
Louisville, Kentucky 40202

(502) 495-1212  
Fax: (502) 491-7111

**Client:** KY Transportation Cabinet  
**Address:** 200 Mero Street  
Frankfort, KY  
40601  
Attention O'Dail Lawson

**Project No:** 2107195B  
**Sample ID:** M47-5  
**Sampled:** 8-Jul-14  
**Received:** 10-Jul-14  
**Analyzed:** 19-Jul-14 - Point Count -

**Bulk Sample Analysis**

**Sampled by:** O'Dail Lawson  
**Facility/Location:** Magoffin County / Item # 10-126.40 . 077B00047N  
**Field Description:** Joint Compound

**Laboratory Description:**  
Thick Black Material

**Asbestos Materials:**  
Chrysotile = 2/400 = 0.50 % ( < 1 % ) Sample Is Negative

**Non-asbestos Fibrous Materials & Matrix Materials:**  
Cellulose 0.25 %  
Binders 99.25 %

**Remarks:** The sample was analyzed for asbestos content following the EPA Methodology (600/R-93/116). The test relates only to the items tested. This report does not represent endorsement by NVLAP or any agency of the U.S. Government.

**Analyst:** Winterford Mensah

**Reviewed By:**   
Signature

***MRS, INC.*** *MRS, Inc. Analytical Laboratory Division*

332 West Broadway, Suite 613  
Louisville, Kentucky 40202

(502) 495-1212  
Fax: (502) 491-7111

<b>Client:</b>	<u>KY Transportation Cabinet</u>	<b>Project No:</b>	<u>2107195B</u>
<b>Address:</b>	<u>200 Mero Street</u>	<b>Sample ID:</b>	<u>M47 - 7</u>
	<u>Frankfort, KY</u>	<b>Sampled:</b>	<u>8-Jul-14</u>
	<u>40601</u>	<b>Received:</b>	<u>10-Jul-14</u>
	<u>Attention O'Dail Lawson</u>	<b>Analyzed:</b>	<u>19-Jul-14 - Point Count -</u>

**Bulk Sample Analysis**

**Sampled by:** O'Dail Lawson

**Facility/Location:** Magoffin County / Item # 10-126.40 . 077B00047N

**Field Description:** Concrete Sealant

**Laboratory Description:**  
Gray Material

**Asbestos Materials:**  
Chrysotile = 2/400 = 0.50 % ( < 1 % ) Sample Is Negative

**Non-asbestos Fibrous Materials & Matrix Materials:**

<u>Cellulose</u>	<u>0.25 %</u>
<u>Binders</u>	<u>99.25 %</u>

**Remarks:** The sample was analyzed for asbestos content following the EPA Methodology (600/R-93/116). The test relates only to the items tested. This report does not represent endorsement by NVLAP or any agency of the U.S. Government.

**Analyst:** Winterford Mensah      **Reviewed By:**   
Signature





# Chain of Custody Record

## Kentucky Transportation Cabinet

200 Metro Street, 5th Floor West  
Frankfort, Kentucky 40622  
(502) 564-7250 fax (502) 564-5655

O'Dail Lawson <a href="mailto:odail.lawson@ky.gov">odail.lawson@ky.gov</a> KYTC 200 Metro Street Frankfort KY Phone: 502-782-5020 Fax: 502-564-5655 PO#:		Client Information KY TRANSPORTATION CABINET Results Code: ND = None Detected FTD = Filter Tampering or Damaged N/A = Not Applicable		Project or Subject Reference Magoffin 10-126.40 B00048N 077 B00047N 44? MISPRINTS ON SAMPLE		Sampler (signature): 		
Sample ID	Sample Description	Collected		Analysis Requested	Matrix	Color	Cont. Type	Preservative
		Date	Time					
M47-1	Concrete Pier	7-8-14	1:15	Asbestos	Concrete	Grey		N/A
M47-2	Concrete Wing Wall				Concrete	Grey		
M47-3	Paint chip				Paint	Yellow		
M47-4	Guard Rail Mastic				Mastic	Grey		
M47-5	Joint Compound				Compound	Black		
M47-6	Concrete Rail				Concrete	Grey		
M47-7	Concrete Sealant				Concrete	Grey		
Relinquished By:		Date/Time:						
Received By: <i>Miraflores</i>		Date/Time: 7/10/14						
Relinquished By:		Date/Time:						
Received at Lab By:		Date/Time:						

# The EI Group, Inc.

This certifies that

## Tilmon O'Dail Lawson

Student Address: 132 Old Fort Drive, Georgetown, KY 40324

Has attended and satisfactorily passed an examination covering the contents of an EPA/AHERA approved course entitled

### Asbestos Inspector Refresher (4-Hour) Training Course

7213080011  
Certificate Number

7910  
Social Security Number

August 23, 2013  
Course Dates

August 23, 2013  
Exam Date

August 23, 2014  
Expiration Date



Louisville, KY  
Location

*Benny A. Maxwell*  
Benny Maxwell, Training Manager

*Kerri Boddy*  
Kerri Boddy, Principal Instructor

*Kerri Boddy*  
Kerri Boddy, Exam Administrator

3240 Office Point Place, Suite 200  
Louisville, KY 40220  
888-372-5859

Approved by:  
Indiana Department of Environmental Management



## TRANSPORTATION CABINET

Frankfort, Kentucky 40622  
www.transportation.ky.gov

**Steven L. Beshear**  
Governor

**Michael W. Hancock, P.E.**  
Secretary

# Memorandum

**To:** Brandon Baker  
**CC:** Tony Vinegar  
**From:** O'Dail Lawson  
Environmental Scientist II  
Division of Environmental Analysis  
**Date:** 7/21/2014  
**Re:** Asbestos Inspection Report for Magoffin 10-126.40

---

**This report is prepared to accompany the 10-Day NOI for Demolition to the Division of Air Quality. Please include all pages with submittal.**

### **Project and Structure Information**

**Project #** 10-126.40

**Bridge #** 077B00046N

**Description:** The concrete and paint samples collected were negative for asbestos. The Concrete Sealant, Joint Compound, and Guardrail Mastic samples were pointed counted below 1%. No abatement necessary.

**Inspection Date:** July 8<sup>th</sup>, 2014

### **Results**

The results show no ACM abatement is required.



***MRS, INC.***      *MRS, Inc. Analytical Laboratory Division*

332 West Broadway, Suite 613  
Louisville, Kentucky 40202

(502) 495-1212  
Fax: (502) 491-7111

**BULK SAMPLE ASBESTOS ANALYSIS**

Analysis N#      2107194A      Address: Magoffin Co.,/ Item # 10-126.40  
 Client Name:    KYTC      Bridge # 077 B00046N  
 Sampled By:     O'Dail Lawson

				% FIBROUS ASBESTOS				% NON-ASBESTOS FIBERS			
Number	Color	Layered	Fibrous	Chrysotile	Amosite	crocidolite	Others	Cellulose	Fiberglass	Syn. Fiber	Other/Mat.
M46-1	Gray	Yes	No				None				100%
M46-2	Gray	Yes	No				None				100%
M46-3	Gray	Yes	No	3% (To Be		Point Counted)		2%			95%
M46-4	Yellow	Yes	No				None				100%
M46-5	Black	Yes	No	3% (To Be		Point Counted)		2%			95%
M46-6	Gray	Yes	No	3% (To Be		Point Counted)		2%			95%
M46-7	Gray	Yes	No				None				100%
M46-8	Gray	Yes	No				None				100%

Methodology : EPA Method 600/R-93-116  
 Date Analyzed : 19-Jul-14  
 Analyst : Winterford Mensah

Reviewed By:   
Signature

The test relates only to the items tested. This report does not represent endorsement by NVLAP or any agency of the U.S Government. Partial Reproduction of any part of this report is strictly prohibited. Samples shall be retained for (30) days.

***MRS, INC.*** *MRS, Inc. Analytical Laboratory Division*

332 West Broadway, Suite 613  
Louisville, Kentucky 40202

(502) 495-1212  
Fax: (502) 491-7111

**Client:** KY Transportation Cabinet  
**Address:** 200 Mero Street  
Frankfort, KY  
40601  
Attention O'Dail Lawson

**Project No:** 2107194B  
**Sample ID:** M46 - 3  
**Sampled:** 8-Jul-14  
**Received:** 10-Jul-14  
**Analyzed:** 19-Jul-14 - Point Count -

**Bulk Sample Analysis**

**Sampled by:** O'Dail Lawson  
**Facility/Location:** Magoffin County/ Item # 126.40 B00046N  
**Field Description:** Concrete Sealant

**Laboratory Description:**  
Gray Material

**Asbestos Materials:**  
Chrysotile = 2/400 = 0.50 % ( < 1 % ) Sample Is Negative

**Non-asbestos Fibrous Materials & Matrix Materials:**  

Cellulose	0.25 %
Binders	99.25 %

**Remarks:** The sample was analyzed for asbestos content following the EPA Methodology (600/R-93/116). The test relates only to the items tested. This report does not represent endorsement by NVLAP or any agency of the U.S. Government.

**Analyst:** Winterford Mensah      **Reviewed By:**   
Signature

***MRS, INC.*** *MRS, Inc. Analytical Laboratory Division*

332 West Broadway, Suite 613  
Louisville, Kentucky 40202

(502) 495-1212  
Fax: (502) 491-7111

<b>Client:</b>	<u>KY Transportation Cabinet</u>	<b>Project No:</b>	<u>2107194B</u>
<b>Address:</b>	<u>200 Mero Street</u>	<b>Sample ID:</b>	<u>M46-5</u>
	<u>Frankfort, KY</u>	<b>Sampled:</b>	<u>8-Jul-14</u>
	<u>40601</u>	<b>Received:</b>	<u>10-Jul-14</u>
	<u>Attention O'Dail Lawson</u>	<b>Analyzed:</b>	<u>19-Jul-14 - Point Count -</u>

**Bulk Sample Analysis**

**Sampled by:** O'Dail Lawson

**Facility/Location:** Magoffin County/ Item # 126.40 B00046N

**Field Description:** Joint Compound

**Laboratory Description:**  
Thick Black Material

**Asbestos Materials:**  
Chrysotile = 2/400 = 0.50 % ( < 1 % ) Sample Is Negative

**Non-asbestos Fibrous Materials & Matrix Materials:**

<u>Cellulose</u>	<u>0.25 %</u>
<u>Binders</u>	<u>99.25 %</u>

**Remarks:** The sample was analyzed for asbestos content following the EPA Methodology (600/R-93/116). The test relates only to the items tested. This report does not represent endorsement by NVLAP or any agency of the U.S. Government.

**Analyst:** Winterford Mensah      **Reviewed By:**   
Signature

***MRS, INC.*** *MRS, Inc. Analytical Laboratory Division*

332 West Broadway, Suite 613  
Louisville, Kentucky 40202

(502) 495-1212  
Fax: (502) 491-7111

<b>Client:</b>	<u>KY Transportation Cabinet</u>	<b>Project No:</b>	<u>2107194B</u>
<b>Address:</b>	<u>200 Mero Street</u>	<b>Sample ID:</b>	<u>M46 - 6</u>
	<u>Frankfort, KY</u>	<b>Sampled:</b>	<u>8-Jul-14</u>
	<u>40601</u>	<b>Received:</b>	<u>10-Jul-14</u>
	<u>Attention O'Dail Lawson</u>	<b>Analyzed:</b>	<u>19-Jul-14 - Point Count -</u>

**Bulk Sample Analysis**

**Sampled by:** O'Dail Lawson

**Facility/Location:** Magoffin County/ Item # 126.40 B00046N

**Field Description:** Guard Rail Mastic

**Laboratory Description:**  
Thick Black Material

**Asbestos Materials:**  
Chrysotile = 2/400 = 0.50 % ( < 1 % ) Sample Is Negative

**Non-asbestos Fibrous Materials & Matrix Materials:**

<u>Cellulose</u>	<u>0.25 %</u>
<u>Binders</u>	<u>99.25 %</u>

**Remarks:** The sample was analyzed for asbestos content following the EPA Methodology (600/R-93/116). The test relates only to the items tested. This report does not represent endorsement by NVLAP or any agency of the U.S. Government.

**Analyst:** Winterford Mensah      **Reviewed By:**   
Signature

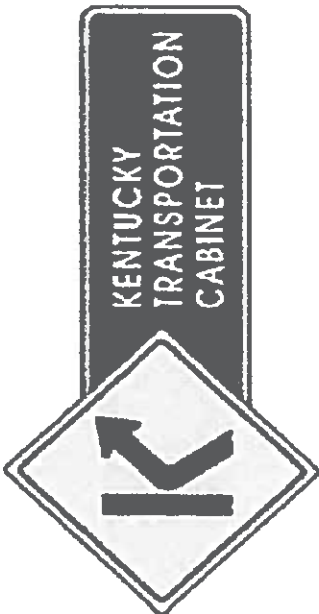

# Chain of Custody Record

## Kentucky Transportation Cabinet

200 Metro Street, 5th Floor West  
Frankfort, Kentucky 40622  
(502) 564-7250 fax (502) 564-5655

O'Dail Lawson <a href="mailto:odail.lawson@ky.gov">odail.lawson@ky.gov</a> KYTC Address: 200 Metro Street Frankfort KY Phone: 502-782-5020 Fax: 502-564-5655 PO#:		Client Information KY TRANSPORTATION CABINET Results Code: 077B00046N ND = None Detected FTD = Filler Tampering or Damaged N/A = Not Applicable		Project or Subject Reference Magoffin 10-12640 B00046N		Samplers Signature: <i>[Signature]</i>		
Sample ID	Sample Description	Collected		Analysis Requested	Matrix	Color	Cont. Type	Preservative
		Date	Time					
M46-1	Concrete Span	7-8-14	1:35	Asbestos	Concrete Grey	Grey		N/A
M46-2	Concrete Abutment				Concrete Grey	Grey		
M46-3	Concrete Sealant				Compound Grey	Grey		
M46-4	Paint Chip				Paint Yellow	Yellow		
M46-5	Joint Compound				Compound Black	Black		
M46-6	Guard Rail Masti:c				Mastic Grey	Grey		
M46-7	Concrete Curb				Concrete Grey	Grey		
M46-8	Concrete Wing Wall				Concrete Grey	Grey		

Relinquished By:	Date/Time:
Received By: <i>Michael Meadows</i>	Date/Time: 7/10/14
Relinquished By:	Date/Time:
Received at Lab By:	Date/Time:



# The EI Group, Inc.

This certifies that

## Tilmon O'Dail Lawson

Student Address: 132 Old Fort Drive, Georgetown, KY 40324

Has attended and satisfactorily passed an examination covering the contents of an EPA/AHERA approved course entitled

### Asbestos Inspector Refresher (4-Hour) Training Course

7213080011

Certificate Number

7910

Social Security Number

August 23, 2013

Course Dates

August 23, 2013

Exam Date

August 23, 2014

Expiration Date



Louisville, KY

Location

*Benny A. Maxwell*  
Benny Maxwell, Training Manager

*Kerri Boddy*  
Kerri Boddy, Principal Instructor

*Kerri Boddy*  
Kerri Boddy, Exam Administrator

3240 Office Point Place, Suite 200  
Louisville, KY 40220  
888-372-5859

Approved by:  
Indiana Department of Environmental Management



## TRANSPORTATION CABINET

Frankfort, Kentucky 40622  
www.transportation.ky.gov

**Steven L. Beshear**  
Governor

**Michael W. Hancock, P.E.**  
Secretary

# Memorandum

**To:** Brandon Baker  
**CC:** Tony Vinegar  
**From:** O'Dail Lawson  
Environmental Scientist II  
Division of Environmental Analysis  
**Date:** 7/21/2014  
**Re:** Asbestos Inspection Report for Magoffin 10-126.40

---

**This report is prepared to accompany the 10-Day NOI for Demolition to the Division of Air Quality. Please include all pages with submittal.**

### **Project and Structure Information**

**Project #** 10-126.40

**Bridge #** 077B00045N

**Description:** The concrete and paint samples collected were negative for asbestos. The Joint Compound and Guardrail Mastic samples were pointed counted below 1%. No abatement necessary.

**Inspection Date:** July 8<sup>th</sup>, 2014

### **Results**

The results show no ACM abatement is required.



***MRS, INC.***      *MRS, Inc. Analytical Laboratory Division*

332 West Broadway, Suite 613  
Louisville, Kentucky 40202

(502) 495-1212  
Fax: (502) 491-7111

**BULK SAMPLE ASBESTOS ANALYSIS**

Analysis N#      2107193A      Address: Magoffin Co.,/ Item # 10-126.40  
Client Name:      KYTC      Bridge # 077 B00045N  
Sampled By:      O'Dail Lawson

Number	Color	Layered	Fibrous	% FIBROUS ASBESTOS				% NON-ASBESTOS FIBERS			
				Chrysotile	Amosite	crocidolite	Others	Cellulose	Fiberglass	Syn. Fiber	Other/Mat.
M45-1	Gray	Yes	No	3%	(To Be	Point Counted)		2%			95%
M45-2	Black	Yes	No	3%	(To Be	Point Counted)		2%			95%
M45-3	Black	Yes	No				None				100%
M45-4	Gray	Yes	No				None				100%
M45-5	Gray	Yes	No				None				100%
M45-6	Gray	Yes	No				None				100%

Methodology : EPA Method 600/R-93-116  
Date Analyzed : 19-Jul-14  
Analyst : Winterford Mensah

Reviewed By: *Winterford Mensah*  
Signature

The test relates only to the items tested. This report does not represent endorsement by NVLAP or any agency of the U.S Government. Partial Reproduction of any part of this report is strictly prohibited. Samples shall be retained for (30) days.

***MRS, INC.*** *MRS, Inc. Analytical Laboratory Division*

332 West Broadway, Suite 613  
Louisville, Kentucky 40202

(502) 495-1212  
Fax: (502) 491-7111

<b>Client:</b>	<u>KY Transportation Cabinet</u>	<b>Project No:</b>	<u>2107193B</u>
<b>Address:</b>	<u>200 Mero Street</u>	<b>Sample ID:</b>	<u>M45-1</u>
	<u>Frankfort, KY</u>	<b>Sampled:</b>	<u>8-Jul-14</u>
	<u>40601</u>	<b>Received:</b>	<u>10-Jul-14</u>
	<u>Attention O'Dail Lawson</u>	<b>Analyzed:</b>	<u>19-Jul-14 - Point Count -</u>

**Bulk Sample Analysis**

**Sampled by:** O'Dail Lawson

**Facility/Location:** Magoffin County / Item # 10 - 126.40 - Bridge # 077 B00045N

**Field Description:** Guard Rail Mastic

**Laboratory Description:**  
Gray Material

**Asbestos Materials:**  
Chrysotile = 2/400 = 0.50 % ( < 1 % ) Sample Is Negative

**Non-asbestos Fibrous Materials & Matrix Materials:**

<u>Cellulose</u>	<u>0.25 %</u>
<u>Binders</u>	<u>99.25 %</u>

**Remarks:** The sample was analyzed for asbestos content following the EPA Methodology (600/R-93/116). The test relates only to the items tested. This report does not represent endorsement by NVLAP or any agency of the U.S. Government.

**Analyst:** Winterford Mensah      **Reviewed By:**   
Signature

<b><i>MRS, INC.</i></b>	<i>MRS, Inc. Analytical Laboratory Division</i>
-------------------------	---

332 West Broadway, Suite 613  
Louisville, Kentucky 40202

(502) 495-1212  
Fax: (502) 491-7111

<b>Client:</b> <u>KY Transportation Cabinet</u>	<b>Project No:</b> <u>2107193B</u>
<b>Address:</b> <u>200 Mero Street</u>	<b>Sample ID:</b> <u>M45 - 2</u>
<u>Frankfort, KY</u>	<b>Sampled:</b> <u>8-Jul-14</u>
<u>40601</u>	<b>Received:</b> <u>10-Jul-14</u>
<u>Attention O'Dail Lawson</u>	<b>Analyzed:</b> <u>19-Jul-14 - Point Count -</u>

Bulk Sample Analysis					
<b>Sampled by:</b>	<u>O'Dail Lawson</u>				
<b>Facility/Location:</b>	<u>Magoffin County / Item # 10 - 126.40 - Bridge # 077 B00045N</u>				
<b>Field Description:</b>	<u>Joint Compound</u>				
<b>Laboratory Description:</b>	<u>Thick Black Material</u>				
<b>Asbestos Materials:</b>	<u>Chrysotile = 2/400 = 0.50 % ( &lt; 1 % ) Sample Is Negative</u>				
<b>Non-asbestos Fibrous Materials &amp; Matrix Materials:</b>	<table style="width:100%; border-collapse: collapse;"> <tr> <td style="width:70%;"><u>Cellulose</u></td> <td style="text-align: right;"><u>0.25 %</u></td> </tr> <tr> <td><u>Binders</u></td> <td style="text-align: right;"><u>99.25 %</u></td> </tr> </table>	<u>Cellulose</u>	<u>0.25 %</u>	<u>Binders</u>	<u>99.25 %</u>
<u>Cellulose</u>	<u>0.25 %</u>				
<u>Binders</u>	<u>99.25 %</u>				
<b>Remarks:</b> The sample was analyzed for asbestos content following the EPA Methodology (600/R-93/116). The test relates only to the items tested. This report does not represent endorsement by NVLAP or any agency of the U.S. Government.					
<b>Analyst:</b> <u>Winterford Mensah</u>	<b>Reviewed By:</b> <u></u> <small>Signature</small>				

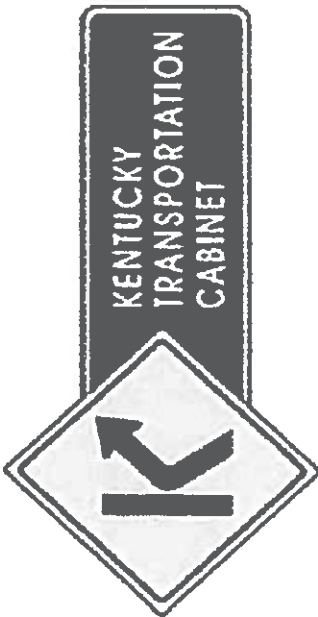

# Chain of Custody Record

## Kentucky Transportation Cabinet

200 Metro Street, 5th Floor West  
Frankfort, Kentucky 40622  
(502) 564-7250 fax (502) 564-5655

O'Dail Lawson <a href="mailto:odail.lawson@ky.gov">odail.lawson@ky.gov</a> KYTC Address: 200 Metro Street Frankfort KY Phone: 502-782-5020 Fax: 502-564-5655 PO#:		Client Information KY TRANSPORTATION CABINET Results Code: 07B00045N ND = None Detected FTD = Filter Tampering or Damaged N/A = Not Applicable						
Project or Subject Reference Magoffin 10-126-50		B00045N 10-126.40 Samplers (signature): <i>[Signature]</i>						
Sample ID	Sample Description	Collected		Analysis Requested	Matrix	Color	Cont. Type	Preservative
		Date	Time					
M45-1	Guard Rail Mastic	7-8-14	12:05	Asbestos	Mastic	Grey		N/A
M45-2	Joint Compound				Compound	Black		
M45-3	Paint Chip				Paint	Black		
M45-4	Concrete Spar				Concrete	Black		
M45-5	Concrete Abutment				Concrete	Grey		
M45-6	Concrete Rail				Concrete	Grey		
Relinquished By:		Date/Time:						
Received By: <i>[Signature]</i>		Date/Time: 7/10/14						
Relinquished By:		Date/Time:						
Received at Lab By:		Date/Time:						

# The EI Group, Inc.

This certifies that

## Tilmon O'Dail Lawson

Student Address: 132 Old Fort Drive, Georgetown, KY 40324

Has attended and satisfactorily passed an examination covering the contents of an EPA/AHERA approved course entitled

### Asbestos Inspector Refresher (4-Hour) Training Course

7213080011

Certificate Number

7910

Social Security Number

August 23, 2013

Course Dates

August 23, 2013

Exam Date

August 23, 2014

Expiration Date



Louisville, KY

Location

*Berry A. Maxwell*  
Berry Maxwell, Training Manager

*Kerri Boddy*  
Kerri Boddy, Principal Instructor

*Kerri Boddy*  
Kerri Boddy, Exam Administrator

3240 Office Point Place, Suite 200  
Louisville, KY 40220  
888-372-5859

Approved by:  
Indiana Department of Environmental Management

	KENTUCKY TRANSPORTATION CABINET Department of Highways DIVISION OF RIGHT OF WAY & UTILITIES	TC 62-226 Rev. 01/2016 Page 1 of 1
<b>RIGHT OF WAY CERTIFICATION</b>		

<input checked="" type="checkbox"/> Original	<input type="checkbox"/> Re-Certification	<b>RIGHT OF WAY CERTIFICATION</b>	
ITEM #	COUNTY	PROJECT # (STATE)	PROJECT # (FEDERAL)
10-126.40	Magoffin	12FO FD 52 121 6170840R	STP 0061 (057)

**PROJECT DESCRIPTION**  
 MOUNTAIN PARKWAY CORRIDOR: WIDEN THE MOUNTAIN PARKWAY TO 4 LANES FROM 0.3MI W OF KY 3047 (65.0) TO 0.7 MI W OF MIDDLE FORK LICKING RIVER BRIDGE (69.6). (2012BOP)(14CCR)(16CCR) KY 9009

**No Additional Right of Way Required**  
 Construction will be within the limits of the existing right of way. The right of way was acquired in accordance to FHWA regulations under the Uniform Relocation Assistance and Real Property Acquisitions Policy Act of 1970, as amended. No additional right of way or relocation assistance were required for this project.

**Condition # 1 (Additional Right of Way Required and Cleared)**  
 All necessary right of way, including control of access rights when applicable, have been acquired including legal and physical possession. Trial or appeal of cases may be pending in court but legal possession has been obtained. There may be some improvements remaining on the right-of-way, but all occupants have vacated the lands and improvements, and KYTC has physical possession and the rights to remove, salvage, or demolish all improvements and enter on all land. Just Compensation has been paid or deposited with the court. All relocations have been relocated to decent, safe, and sanitary housing or that KYTC has made available to displaced persons adequate replacement housing in accordance with the provisions of the current FHWA directive.

**Condition # 2 (Additional Right of Way Required with Exception)**  
 The right of way has not been fully acquired, the right to occupy and to use all rights-of-way required for the proper execution of the project has been acquired. Some parcels may be pending in court and on other parcels full legal possession has not been obtained, but right of entry has been obtained, the occupants of all lands and improvements have vacated, and KYTC has physical possession and right to remove, salvage, or demolish all improvements. Just Compensation has been paid or deposited with the court for most parcels. Just Compensation for all pending parcels will be paid or deposited with the court prior to AWARD of construction contract

**Condition # 3 (Additional Right of Way Required with Exception)**  
 The acquisition or right of occupancy and use of a few remaining parcels are not complete and/or some parcels still have occupants. All remaining occupants have had replacement housing made available to them in accordance with 49 CFR 24.204. KYTC is hereby requesting authorization to advertise this project for bids and to proceed with bid letting even though the necessary right of way will not be fully acquired, and/or some occupants will not be relocated, and/or the just compensation will not be paid or deposited with the court for some parcels until after bid letting. KYTC will fully meet all the requirements outlined in 23 CFR 635.309(c)(3) and 49 CFR 24.102(j) and will expedite completion of all acquisitions, relocations, and full payments after bid letting and prior to AWARD of the construction contract or force account construction.

Total Number of Parcels on Project	33	EXCEPTION (S) Parcel #	ANTICIPATED DATE OF POSSESSION WITH EXPLANATION
Number of Parcels That Have Been Acquired			
Signed Deed	29		
Condemnation	4		
Signed ROE	4		

Notes/ Comments (Use Additional Sheet if necessary)

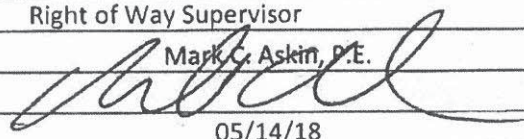
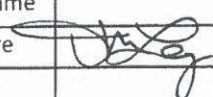
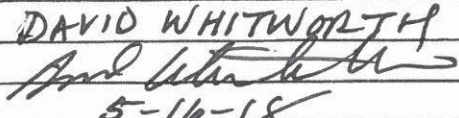
<b>LPA RW Project Manager</b>		<b>Right of Way Supervisor</b>	
Printed Name		Printed Name	Mark C. Askin, P.E.
Signature		Signature	
Date		Date	05/14/18
<b>Right of Way Director</b>		<b>FHWA</b>	
Printed Name	Dean M. Loy	Printed Name	DAVID WHITWORTH
Signature		Signature	
Date	16 MAY 2018	Date	5-16-18



## UTILITIES AND RAIL CERTIFICATION NOTE

**Magoffin County  
Widen the Mountain Parkway to 4 Lanes from 0.3 miles west of  
KY 3047 (65.0) to 0.7 miles west of Middle Fork Licking River  
Bridge (69.6)  
Item No. 10-126.40**

### GENERAL PROJECT NOTE ON UTILITY PROTECTION

Not all of the Aerial utility relocations have begun on this project. It is anticipated that the highway contractor will have productive work available through the project; however, that is for the highway contractor to determine. The highway contractor should not anticipate that any utility relocation work will be completed prior to the letting or by the award of the contract; consequently, the highway contractor should prepare the construction schedule accordingly.

### NOTE: DO NOT DISTURB THE FOLLOWING UTILITIES LOCATED WITHIN THE PROJECT DISTURB LIMITS

**AT&T** currently exists along the Mountain Parkway. They have fiber optics that run along the south side of the existing Mountain Parkway from Station 3375+00 to Station 3415+00 and from Station 3510+00 to Station 3595+00. The fiber optic line crosses the existing Mountain Parkway between Stations 3471+00 and Station 3472+00. AT&T's fiber optic line also runs along the proposed KY 3046 from Station 40+00 to Station 54+00 and lies within the limits of the proposed interchange between the proposed Mountain Parkway and the existing Mountain Parkway.

**Foothills Rural Telephone** currently exists along the Mountain Parkway on the south side from Station 3395+00 to Station 3415+00, from Station 3505+00 to Station 3515+00, and along the north side of proposed East Parkway Drive between Stations 12+75 to Station 29+55.

**Hard Rock Energy** currently exists along the Mountain Parkway from Station 3507+00 to Station 3525+00

**Jefferson Gas** currently exists along the Mountain Parkway from Station 3555+00 to Station 3568+00.

**Licking Valley RECC** currently exists along the Mountain Parkway from Station 3390+00 to Station 3412+00, Station 3502+00 to Station 3525+00, and along the proposed East Parkway Drive between Stations 12+75 to Station 29+55.

**Tackett & Sons Drilling Contractors** currently exist along the Mountain Parkway from Station 3502+00 to Station 3507+00.

This may not be a complete list of the utility companies/facilities in the project area; however, it is all that have been identified at this time.

**\*The Contractor is fully responsible for protection of all utilities listed above\***

**THE FOLLOWING COMPANIES ARE RELOCATING/ADJUSTING THEIR UTILITIES WITHIN THE PROJECT LIMITS AND WILL BE COMPLETE PRIOR TO CONSTRUCTION**

**Foothills Rural Telephone**

## UTILITIES AND RAIL CERTIFICATION NOTE

**Magoffin County**  
**Widen the Mountain Parkway to 4 Lanes from 0.3 miles west of**  
**KY 3047 (65.0) to 0.7 miles west of Middle Fork Licking River**  
**Bridge (69.6)**  
**Item No. 10-126.40**

Licking Valley RECC

**THE FOLLOWING COMPANIES HAVE FACILITIES TO BE RELOCATED/ADJUSTED BY THE COMPANY OR  
THE COMPANY'S SUBCONTRACTOR AND IS TO BE COORDINATED WITH THE ROAD CONTRACT**

**AT&T** has provided a set of relocation plans. Relocation construction activities have begun. The Company's estimated completion date is September 27, 2019.

**Hard Rock Energy** has provided a set of relocation plans. Relocation construction activities are anticipated to be done in conjunction with the roadway project. The contractor shall notify Hard Rock Energy 30 days prior to beginning construction in the area of their existing line. The relocation work will take 30 calendar days.

**Jefferson Gas** has provided a set of relocation plans. Relocation construction activities have begun. The company's estimated completion date is September 27, 2019.

**Tackett & Sons Drilling Contractors** has provided a set of relocation plans. Relocation construction activities are anticipated to begin on August 5, 2019. The company's relocation submittal has estimated approximately forty-five (45) working days to complete the relocation of their facilities. The company's estimated completion date is October 4, 2019.

The Department will consider submission of a bid as the Contractor's agreement to not make any claims for additional compensation due to delays or other conditions created by the operations of AT&T, Hard Rock Energy, Jefferson Gas, and Tackett Drilling Contractors. Working days will not be charged for those days on which work on AT&T, Hard Rock Energy, Jefferson Gas, and Tackett Drilling and Contracting facilities delay work that is outlined on the critical path of the project, as provided in the current edition of the KY Standard Specifications for Road and Bridge Construction. Should a difference of opinion arise as to the rights of the Contractor and others working within the limits of, or adjacent to the project, the KYTC Section Supervisor will decide as to the respective rights of the various parties involved in order to assure the completion of the Department's work in general harmony and in a satisfactory manner, and his decision shall be final and binding upon the Contractor.

**THE FOLLOWING COMPANIES HAVE FACILITIES TO BE RELOCATED/ADJUSTED BY THE ROAD**

## UTILITIES AND RAIL CERTIFICATION NOTE

**Magoffin County**  
**Widen the Mountain Parkway to 4 Lanes from 0.3 miles west of**  
**KY 3047 (65.0) to 0.7 miles west of Middle Fork Licking River**  
**Bridge (69.6)**  
**Item No. 10-126.40**

**CONTRACTOR AS INCLUDED IN THIS CONTRACT**

Magoffin County Water District’s relocation/adjustment of their facilities is included as a part of the Cabinet’s highway construction contract.

**THE FOLLOWING RAIL COMPANIES HAVE FACILITIES IN CONJUNCTION WITH THIS PROJECT AS NOTED**

- No Rail Involved**       **Minimal Rail Involved (See Below)**       **Rail Involved (See Below)**

**UNDERGROUND FACILITY DAMAGE PROTECTION – BEFORE YOU DIG**

The contractor shall make every effort to protect underground facilities from damage as prescribed in the Underground Facility Damage Protection Act of 1994, Kentucky Revised Statute KRS 367.4901 to 367.4917. It is the contractor’s responsibility to determine and take steps necessary to be in compliance with federal and state damage prevention directives. The contractor is instructed to contact KY 811 for the location of existing underground utilities. Contact shall be made a minimum of two (2) and no more than ten (10) business days prior to excavation.

The contractor shall submit Excavation Locate Requests to the Kentucky Contact Center (KY 811) via web ticket entry. The submission of this request does not relieve the contractor from the responsibility of contacting non-member facility owners, whom are to be contacted through their individual Protection Notification Center. It may be necessary for the contractor to contact the County Court Clerk to determine what utility companies have facilities in the area. Non-compliance with these directives can result in the enforcement of penalties.

**SPECIAL CAUTION NOTE – PROTECTION OF UTILITIES**

The contractor will be responsible for contacting all utility facility owners on the subject project to coordinate his activities. The contractor will coordinate his activities to minimize and, where possible, avoid conflicts with utility facilities. Due to the nature of the work proposed, it is unlikely to conflict with the existing utilities beyond minor facility adjustments. Where conflicts with utility facilities are unavoidable, the contractor will coordinate any necessary relocation work with the facility owner and Resident Engineer. The Kentucky Transportation Cabinet

## UTILITIES AND RAIL CERTIFICATION NOTE

**Magoffin County**  
**Widen the Mountain Parkway to 4 Lanes from 0.3 miles west of**  
**KY 3047 (65.0) to 0.7 miles west of Middle Fork Licking River**  
**Bridge (69.6)**  
**Item No. 10-126.40**

maintains the right to remove or alter portions of this contract if a utility conflict occurs.

The utility facilities as noted in the previous section(s) have been determined using data garnered by varied means and with varying degrees of accuracy: from the facility owners, a result of S.U.E., field inspections, and/or reviews of record drawings. The facilities defined may not be inclusive of all utilities in the project scope and are not Level A quality, unless specified as such. It is the contractor's responsibility to verify all utilities and their respective locations before excavating.

*Please Note: The information presented in this Utility Note is informational in nature and the information contained herein is not guaranteed.*

### AREA UTILITIES CONTACT LIST

<u>Utility Company/Agency</u>	<u>Contact Name</u>	<u>Contact Information</u>
AT&T	Jack Salyer	(606) 424-9328
Hard Rock Energy	Jerry Meade	(859) 537-5530
Foothills Rural Telephone	Patrick Fletcher	(606) 297-9140
Jefferson Gas	Jack Banks	(606) 434-6157
Licking Valley RECC	Wes McKinney	(606) 791-0082
Magoffin County Water District	Alan McCarty	(606) 367-9816
Tackett & Sons Drilling Contractors	Dave Tackett	(606)349-6811

# **GENERAL UTILITY NOTES AND INSTRUCTIONS APPLICABLE TO ALL UTILITY WORK MADE A PART OF THE ROAD CONSTRUCTION CONTRACT**

The contractor should be aware the following utility notes and KYTC Utility Bid Item Descriptions shall supersede, replace and take precedence over any and all conflicting information that may be contained in utility owner supplied specifications contained in the contract, on plans supplied by the utility owner, or any utility owner specifications or information externally referenced in this contract.

Where information may have been omitted from these notes, bid item descriptions, utility owner supplied specifications or plans; the KYTC Standard Specifications for Road and Bridge Construction shall be referenced.

## **PROTECTION OF EXISTING UTILITIES**

The existing utilities shown on the plans are shown as best known at the time the plans were developed and are to be used as a guide only by the Contractor. The Contractor shall use all means at his disposal to accurately locate all existing utilities, whether shown on the plans or not, prior to excavation. The contractor shall protect these utilities during construction. Any damage to existing utilities during construction that are shown or not shown on the plans shall be repaired at the Contractor's expense.

## **PREQUALIFIED UTILITY CONTRACTORS**

Some utility owners may require contractors that perform relocation work on their respective facilities as a part of the road contract be prequalified or preapproved by the utility owner. Those utility owners with a prequalification or preapproval requirement are as follows:

**Magoffin County Water District** (require pre-approved contractors)

The bidding contractor needs to review the above list and choose from the list of approved subcontractors at the end of these general notes as identified above before bidding. When the list of approved subcontractors is provided, only subcontractors shown on the following list(s) will be allowed to work on that utility as a part of this contract.

When the list of approved subcontractors for the utility work is not provided in these general notes, the utility work can be completed by the prime contractor. If the prime contractor chooses to subcontract the work, the subcontractor shall be prequalified with the KYTC Division of Construction Procurement in the

work type of “Utilities” (I33). Those who would like to become prequalified may contact the Division of Construction Procurement at (502) 564-3500. Please note: it could take up to 30 calendar days for prequalification to be approved. The prequalification does not have to be approved prior to the bid, but must be approved before the subcontract will be approved by KYTC and the work can be performed.

#### CONTRACT ADMINISTRATION RELATIVE TO UTILITY WORK

All utility work is being performed as a part of a contract administered by KYTC; there is not a direct contract between the utility contractor and utility owner. The KYTC Section Engineer is ultimately responsible for the administration of the road contract and any utility work included in the contract.

#### SUBMITTALS AND CORRESPONDENCE

All submittals and correspondence of any kind relative to utility work included in the road contract shall be directed to the KYTC Section Engineer, a copy of which may also be supplied to the utility owner by the contractor to expedite handling of items like material approvals and shop drawings. All approvals and correspondence generated by the utility owner shall be directed to the KYTC Section Engineer. The KYTC Section Engineer will relay any approvals or correspondence to the utility contractor as appropriate. At no time shall any direct communication between the utility owner and utility contractor without the communication flowing through the KYTC Section Engineer be considered official and binding under the contract.

#### ENGINEER

Where the word “Engineer” appears in any utility owner specifications included in this proposal, utility owner specifications included as a part of this contract by reference or on the utility relocation plans, it shall be understood the “Engineer” is the Kentucky Transportation Cabinet (KYTC) Section Engineer or designated representative and the utility owner engineer or designated representative jointly. Both engineers must mutually agree upon all decisions made with regard to the utility construction. The Transportation Cabinet, Section Engineer shall make all final decisions in all disputes.

### INSPECTOR OR RESIDENT PROJECT REPRESENTATIVE

Where the word “Inspector” or “Resident Project Representative” appears in the utility specifications included in this proposal, utility owner specifications included as a part of this contract by reference or on the utility relocation plans, it shall be understood the “Inspector” or “Resident Project Representative” is the utility owner inspector and KYTC inspector jointly. The Transportation Cabinet, Section Engineer shall make all final decisions in all disputes.

### NOTICE TO UTILITY OWNERS OF THE START OF WORK

One month before construction is to start on a utility, the utility contractor shall make notice to the KYTC Section Engineer and the utility owner of when work on a utility is anticipated to start. The utility contractor shall again make confirmation notice to the KYTC Section Engineer and the utility owner one week before utility work is to actually start.

### UTILITY SHUTDOWNS

The Contractor shall not shut down any active and in-service mains, utility lines or services for any reason unless specifically given permission to do so by the utility owner. The opening and closing of valves and operating of other active utility facilities for main, utility line or utility service shut downs are to be performed by the utility owner unless specific permission is given to the contractor by the owner to make shutdowns. If and when the utility owner gives the contractor permission to shutdown mains, utility lines or utility services, the contractor shall do so following the rules, procedures and regulations of the utility owner. Any permission given by the utility owner to the contractor to shutdown active and in-service mains, utility lines or services shall be communicated to the KYTC Section Engineer by the utility owner that such permission has been given.

Notice to customers of utility shut downs is sometimes required to be performed by the utility contractor. The contractor may be required; but, is not limited to, making notice to utility customers in a certain minimum amount of time in advance of the shut down and by whatever means of communication specified by the utility owner. The means of communication to the customer may be; but is not limited to, a door hanger, notice by newspaper ad, telephone contact, or any combination of communication methods deemed necessary, customary and appropriate by the utility owner. The contractor should refer to the utility owner specifications for requirements on customer notice.

Any procedure the utility owner may require the contractor to perform by specification or plan note and any expense the contractor may incur to comply with the utility owner’s shut down procedure and notice to customers shall be considered an incidental expense to the utility construction.

CUSTOMER SERVICE AND LATERAL ABANDONMENTS When temporary or permanent abandonment of customer water, gas, or sewer services or laterals are necessary during relocation of utilities included in the contract, the utility contractor shall perform these abandonments as part of the contract as incidental work. No separate payment will be made for service line and lateral abandonments. The contractor shall provide all labor, equipment, and materials to accomplish the temporary or permanent abandonment in accordance with the plans, specifications and/or as directed by the engineer. Abandonment may include, but is not limited to, digging down on a water or gas main at the tap to turn off the tap valve

or corporation stop and/or capping or plugging the tap, digging down on a sewer tap at the main and plugging or capping the tap, digging down on a service line or lateral at a location shown on the plans or agreeable to the engineer and capping or plugging, or performing any other work necessary to abandon the service or lateral to satisfactorily accomplish the final utility relocation.

### STATIONS AND DISTANCES

All stations and distances, when indicated for utility placement in utility relocation plans or specifications, are approximate; therefore, some minor adjustment may have to be made during construction to fit actual field conditions. Any changes in excess of 6 inches of plan location shall be reviewed and approved jointly by the KYTC Section Engineer or designated representative and utility owner engineer or designated representative. Changes in location without prior approval shall be remedied by the contractor at his own expense if the unauthorized change creates an unacceptable conflict or condition.

### RESTORATION

Temporary and permanent restoration of paved or stone areas due to utility construction shall be considered incidental to the utility work. No separate payment will be made for this work. Temporary restoration shall be as directed by the KYTC Section Engineer. Permanent restoration shall be "in-kind" as existing.

Restoration of seed and sod areas will be measured and paid under the appropriate seeding and sodding bid items established in the contract for roadway work.

---

BELOW ARE NOTES FOR WHEN "INST" ITEMS ARE IN THE CONTRACT MEANING THE UTILITY COMPANY IS PROVIDING CERTAIN MATERIALS FOR UTILITY RELOCATION

### MATERIAL

Contrary to Utility Bid Item Descriptions, those bid items that have the text "**Inst**" at the end of the bid item will have the major components of the bid item provided by the utility owner. No direct payment will be made for the major material component(s) supplied by the utility company. All remaining materials required to construct the bid item as detailed in utility bid item descriptions, in utility specifications and utility plans that are made a part of this contract will be supplied by the contractor. The contractor's bid price should reflect the difference in cost due to the provided materials.

The following utility owners have elected to provide the following materials for work under this contract:

***No materials are being supplied by the utility owner(s). All materials are to be supplied by the contractor per bid item descriptions, utility specifications and utility plans.***

### SECURITY OF SUPPLIED MATERIALS

If any utility materials are to be supplied by the utility owner, it will be the responsibility of the utility contractor to secure all utility owner supplied materials after delivery to the project site. The utility



contractor shall coordinate directly with the utility owner and their suppliers for delivery and security of the supplied materials. Any materials supplied by the utility owner and delivered to the construction site that are subsequently stolen, damaged, or vandalized and deemed unusable shall be replaced with like materials at the contractor's expense.

## **Pre-approved Utility Subcontractors**

### **Magoffin County Water District**

#### **Bear Traxx Construction**

1225 Issac Park Road  
Louisa, KY 41230  
ATN: Dwight Keeton  
Cell: 606-225-3008  
Email: BearTraxx@Live.com

#### **BOCA Enterprises Inc.**

7435 Ky RT 321  
Hager Hill, KY 41222  
ATN: Kirby Bowling  
Cell: 606-454-1694  
Email: [kirbybowling@yahoo.com](mailto:kirbybowling@yahoo.com)<<mailto:kirbybowling@yahoo.com>>

#### **Martin Contracting, Inc.**

2371 Irvine Rd.  
Richmond, KY 40475  
ATN: Shawn Martin Cell:  
606-305-6434  
Email: [shmartin1@bellsouth.net](mailto:shmartin1@bellsouth.net)<<mailto:shmartin1@bellsouth.net>>

# Standard Water Bid Item Descriptions

**W AIR RELEASE VALVE** This bid item description shall apply to all air release valve installations of every size except those defined as “Special”. This item shall include the air release valve, main to valve connecting line or piping, manhole, vault, structure, access casting or doors, tapping the main, labor, equipment, excavation, proper backfill and restoration required to install the air release valve at the location shown on the plans or as directed in accordance with the specifications and standard drawings complete and ready for use. All air release/vacuum valves on a project shall be paid under one bid item regardless of size. No separate pay items will be established for size variations. Only in the case of the uniqueness of a particular air release valve would a separate bid item be established. Please refer to the Utility Company’s Specifications. If the Company does not have specifications, KYTC’s Specifications shall be referenced. This item shall be paid EACH (EA) when complete.

**BOLLARDS** This item is for payment for furnishing and installing protective guard posts at above ground utility installations. A bollard may consist of, but not limited to, a steel post set in concrete or any other substantial post material. This item shall include all labor, equipment, and materials needed for complete installation of the bollard as specified by the utility owner specifications and plans. If the Company does not have specifications, KYTC’s Specifications shall be referenced. This item shall be paid EACH (EA) when complete.

*NOTE: A bid code for this item has been established in standard roadway bid items and shall be used for payment of this item. The bid code is 21341ND*

**W CAP EXISTING MAIN** This item shall include the specified cap, concrete blocking and/or mechanical anchoring, labor, equipment, excavation, backfill, and restoration required to install the cap at the location shown on the plans or as directed in accordance with the specifications. This item is not to be paid on new main installations. This pay item is only to be paid to cap existing mains. Caps on new mains are incidental to the new main. Any and all caps on existing mains shall be paid under one bid item included in the contract regardless of size. No separate bid items will be established for size variations. Please refer to the Utility Company’s Specifications. If the Company does not have specifications, KYTC’s Specifications shall be referenced. This item shall be paid EACH (EA) when complete.

**W DIRECTIONAL BORE** Payment under this item is made whenever the plans or specifications specifically show directional boring is to be utilized in order to minimize the impact of open cut for the installation of water main under streets, creeks, and etc. Payment under this item shall include the specified bore pipe, labor, and equipment. No separate payment shall be made for bore pipe installed in the bore whether used as a carrier pipe or an encasement of a separate carrier pipe. This item shall also include pipe anchors at each end of the bore when specified to prevent the creep or contraction of the bore pipe. Carrier pipe installed within a bore pipe shall be paid separately under pipe items. Payment under this item shall not be size specific and no separate bid items will be established for size variations. The bore pipe sizes to be included under this item shall be as shown on the plans and/or in the specifications. Any and all directional bores in each contract shall be paid under one directional bore bid item included in the contract regardless of size. Please refer to the Utility Company’s Specifications. If the Company does not have specifications, KYTC’s Specifications shall be referenced. This item shall be paid LINEAR FEET (LF) when complete.

**W ENCASUREMENT CONCRETE** Includes all labor, equipment, excavation, concrete, reinforcing steel, backfill, restoration, and etc., to construct the concrete encasement of the water main as shown on the plans, and in accordance with the specifications and standard drawings. Payment under this item shall be in addition to the carrier pipe as paid under separate bid items. Carrier pipe is not included in this bid item. Any and all concrete encasement shall be paid under one bid item included in the contract regardless of the size of the carrier pipe or the volume of concrete or steel reinforcement as specified in the plans and specifications. No separate bid items will be established for size variations. Measurement of pay quantity shall be from end of concrete to end of concrete. Please refer to the Utility Company's Specifications. If the Company does not have specifications, KYTC's Specifications shall be referenced. This item shall be paid LINEAR FEET (LF) when complete.

**W ENCASUREMENT STEEL BORED** This item shall include the steel encasement pipe size as specified on the plans and in the specifications, casing spacers, end seals, labor, and equipment to bore and install the encasement in accordance with the plans and specifications, complete and ready for use. The size shall be the measured internal diameter of the encasement pipe. The sizes of encasement to be paid under the size ranges specified in the bid items shall be as follows:

- Range 1 = All encasement sizes greater than 2 inches to and including 6 inches
- Range 2 = All encasement sizes greater than 6 inches to and including 10 inches
- Range 3 = All encasement sizes greater than 10 inches to and including 14 inches
- Range 4 = All encasement sizes greater than 14 inches to and including 18 inches
- Range 5 = All encasement sizes greater than 18 inches to and including 24 inches
- Range 6 = All encasement sizes greater than 24 inches

*(Encasement sizes of 2 inches internal diameter or less shall not be paid separately; but, shall be considered incidental to the carrier pipe.)* Payment under this bid item shall not include the carrier pipe. Carrier pipe shall be paid under a separate bid item. Please refer to the Utility Company's Specifications. If the Company does not have specifications, KYTC's Specifications shall be referenced. This item shall be paid LINEAR FEET (LF) when complete.

**W ENCASUREMENT STEEL OPEN CUT** This item shall include the steel encasement pipe size as specified on the plans and in the specifications, casing spacers, end seals, labor, and equipment to open cut and install the encasement in accordance with the plans and specifications, complete and ready for use. The size shall be the measured internal diameter of the encasement pipe. The size encasement to be paid under the size ranges specified in the bid items shall be as follows:

- Range 1 = All encasement sizes greater than 2 inches to and including 6 inches
- Range 2 = All encasement sizes greater than 6 inches to and including 10 inches
- Range 3 = All encasement sizes greater than 10 inches to and including 14 inches
- Range 4 = All encasement sizes greater than 14 inches to and including 18 inches
- Range 5 = All encasement sizes greater than 18 inches to and including 24 inches
- Range 6 = All encasement sizes greater than 24 inches

*(Encasement sizes of 2 inches internal diameter or less shall not be paid separately; but, shall be considered incidental to the carrier pipe.)* Payment under this bid item shall not include the carrier pipe. Carrier pipe shall be paid under a separate bid item. Please refer to the Utility Company's Specifications. If the Company does not have specifications, KYTC's Specifications shall be referenced. This item shall be paid LINEAR FEET (LF) when complete.

**W FIRE HYDRANT ADJUST** Includes all labor, equipment, excavation, materials, and backfill to adjust the existing fire hydrant using the fire hydrant manufacturer's extension kit for adjustments of 18" or less. Adjustments greater than 18" require anchoring couplings and vertical bends to adjust to grade. The Contractor will supply and install all anchor couplings, bends, fire hydrant extension, concrete blocking, restoration, granular drainage material, etc. needed to adjust the fire hydrant complete and ready for use as shown on the plans, and in accordance with the specifications and standard drawings. This also includes allowing for the utility owner inspector to inspect the existing fire hydrant prior to adjusting, contractor returning unusable fire hydrants to the utility owner warehouse and picking up a replacement hydrant. No additional payment will be made for rock excavation. Please refer to the Utility Company's Specifications. If the Company does not have specifications, KYTC's Specifications shall be referenced. This item shall be paid EACH (EA) when complete and ready for use.

**W FIRE HYDRANT ASSEMBLY** Includes all labor, equipment, new fire hydrant, isolating valve and valve box, concrete pad around valve box (when specified in specifications or plans), piping, anchoring tee, anchoring couplings, fire hydrant extension, excavation, concrete blocking, granular drainage material, backfill, and restoration, to install a new fire hydrant assembly as indicated on plans and on standard drawings complete and ready for use. No additional payment will be made for rock excavation. Please refer to the Utility Company's Specifications. If the Company does not have specifications, KYTC's Specifications shall be referenced. This item shall be paid EACH (EA) when complete.

**W FIRE HYDRANT RELOCATE** This item includes all labor and equipment to remove the existing fire hydrant from its existing location and reinstalling at a new location. This item shall include a new isolating valve and valve box, concrete pad around valve box (when required in specifications or plans), new piping, new anchoring tee, anchoring couplings, fire hydrant extensions, concrete blocking, restoration, granular drainage material, excavation, and backfill as indicated on plans, specifications, and on standard drawings complete and ready for use. This item shall also include allowing for utility owner inspector to inspect the existing fire hydrant prior to reuse, contractor returning unusable fire hydrants to the utility owner warehouse and picking up a replacement hydrant for use, if the existing fire hydrant is determined unfit for reuse. No additional payment will be made for rock excavation. Please refer to the Utility Company's Specifications. If the Company does not have specifications, KYTC's Specifications shall be referenced. This item shall be paid EACH (EA) when complete.

**W FIRE HYDRANT REMOVE** This bid item includes removal of an abandoned fire hydrant, isolating valve, and valve box to the satisfaction of the engineer. The removed fire hydrant, isolating valve and valve box shall become the property of the contractor for his disposal as salvage or scrap. Please refer to the Utility Company's Specifications. If the Company does not have specifications, KYTC's Specifications shall be referenced. This item shall be paid EACH (EA) when complete.

**W FLUSH HYDRANT ASSEMBLY** This item shall include the flushing hydrant assembly, service line, tapping the main, labor, equipment, excavation, backfill, and restoration required to install the flush hydrant at the location shown on the plans and in accordance with the specifications and standard drawings, complete and ready for use. Please refer to the Utility Company's Specifications. If the Company does not have specifications, KYTC's Specifications shall be referenced. This item shall be paid EACH (EA) when complete.

**W FLUSHING ASSEMBLY** This item shall include the flushing device assembly, service line, meter box and lid, tapping the main, labor, equipment, excavation, backfill, and restoration required to install the

flushing device at the location shown on the plans and in accordance with the specifications and standard drawings, complete and ready for use. Please refer to the Utility Company's Specifications. If the Company does not have specifications, KYTC's Specifications shall be referenced. This item shall be paid EACH (EA) when complete.

**W LEAK DETECTION METER** This item is for payment for installation of a water meter at main valve locations where shown on the plans for detection of water main leaks. The meter shall be of the size and type specified in the plans or specifications. This item shall include all labor, equipment, meter, meter box or vault, connecting pipes between main and meter, main taps, tapping saddles, casting, yoke, and any other associated material needed for installation of a functioning water meter in accordance with the plans and specifications, complete and ready for use. No separate payment will be made under any other contract item for connecting pipe or main taps. Any and all leak detection meters shall be paid under one bid item included in the contract regardless of size. No separate bid items will be established for size variations. Please refer to the Utility Company's Specifications. If the Company does not have specifications, KYTC's Specifications shall be referenced. This item shall be paid EACH (EA) when complete and ready for use.

**W LINE MARKER** This item is for payment for furnishing and installing a water utility line marker as specified by the utility owner specifications and plans. A line marker may consist of a post or monument of whatever materials specified and shall include markings and/or signage on same as specified by plans or specifications. This item shall include all labor, equipment, and materials needed for complete installation of the marker. This item shall be paid EACH (EA) when complete.

**W MAIN POINT RELOCATE** This item is intended for payment for horizontal and/or vertical relocation of a short length of an existing main at the locations shown on the plans. This bid item is to be used to relocate an existing water main at point locations such as to clear a conflict at a proposed drainage structure, pipe or any other similar short relocation situation, and where the existing pipe material is to be reused. The contractor shall provide any additional pipe or fitting material needed to complete the work as shown on the plans and specifications. The materials provided shall be of the same type and specification as those that exist. Substitution of alternative materials shall be approved by the engineer in advance on a case by case basis. New polyethylene wrap is to be provided (if wrap exists or is specified in the specifications to be used). If it is necessary that the pipe be disassembled for relay, payment under this item shall also include replacement of joint gaskets as needed. Bedding and backfill shall be provided and performed the same as with any other pipe installation as detailed in the plans and specifications. Payment under this item shall be for each location requiring an existing main to be relocated horizontally or vertically regardless of pipe size or relocation length. No separate pay items will be established for pipe size variations or relocation segment length variations. Water Main Relocate shall not be paid on a linear feet basis; but, shall be Paid EACH (EA) at each location when complete and placed in service. Please refer to the Utility Company's Specifications. If the Company does not have specifications, KYTC's Specifications shall be referenced.

**W METER** This item is for payment for installation of all standard water meters of all sizes 2 inches ID or less as specified on the plans. This item shall include all labor, equipment, meter, meter box, casting, yoke, and any other associated material needed for installation of a functioning water meter in accordance with the plans and specifications, complete and ready for use. This item shall include connections to the new or existing water service line. Please refer to the Utility Company's Specifications. If the Company does not have specifications, KYTC's Specifications shall be referenced. This item shall be paid EACH (EA) when complete.

**W METER ADJUST** This item includes all labor, equipment, excavation, materials, backfill, restoration, and etc., to adjust the meter casting to finished grade (whatever size exists) at the location shown on the plans or as directed in accordance with the specifications and standard drawings complete and ready for use. Please refer to the Utility Company's Specifications. If the Company does not have specifications, KYTC's Specifications shall be referenced. This item shall be paid EACH (EA) when complete.

**W METER RELOCATE** This item includes all labor, equipment, excavation, additional fittings, disinfection, testing, restoration, and etc., to relocate the existing water meter (whatever size exists), meter yoke, meter box, casting, and etc., from its old location to the location shown on the plans or as directed, in accordance with the specifications and standard drawings complete and ready for use. The new service pipe (if required) will be paid under short side or long side service bid items. Any and all meter relocations of 2 inches or less shall be paid under one bid item included in the contract regardless of size. Each individual relocation shall be paid individually under this item; however, no separate bid items will be established for meter size variations of 2 inches ID or less. Please refer to the Utility Company's Specifications. If the Company does not have specifications, KYTC's Specifications shall be referenced. This item shall be paid EACH (EA) when complete.

**W METER VAULT SIZE RANGE 1 OR 2** This item is for payment for installation of an underground structure for housing of a larger water meter, fittings, and valves as required by the plans and specifications. This item shall include all labor, equipment, excavation, concrete, manhole castings or access doors, the specified meter(s) valve(s), all piping, and fitting materials associated with installing a functioning meter and vault in accordance with the plans, standard drawings, and specifications, complete and ready for use. The size shall be the measured internal diameter of the meter and piping to be installed. The size meter vault to be paid under size 1 or 2 shall be as follows:

- Size Range 1 = All meter and piping sizes greater than 2 inches up to and including 6 inches
- Size Range 2 = All meter and piping sizes greater than 6 inches

This item shall be paid EACH (EA) when complete. Please refer to the Utility Company's Specifications. If the Company does not have specifications, KYTC's Specifications shall be referenced.

**W METER/FIRE SERVICE COMBO VAULT** This item is for payment for installation of an underground structure for housing of a water meter and fire service piping, fittings, and valves as required by the plans and specifications. This item shall include all labor, equipment, excavation, concrete, manhole castings or access doors, the specified meter(s), valve(s), all piping, and fitting materials associated with installing a functioning meter and fire service vault in accordance with the plans and specifications, complete and ready for use. Please refer to the Utility Company's Specifications. If the Company does not have specifications, KYTC's Specifications shall be referenced. This item shall be paid EACH (EA) when complete.

**W METER WITH PRESSURE REDUCING VALVE (PRV)** This item is for payment for installation of all standard water meters with pressure reducing valves (PRV) of all sizes 2 inches ID or less as specified on the plans. This item shall include all labor, equipment, meter, PRV, meter box, casting, yoke, and any other associated material needed for installation of a functioning water meter with PRV in accordance with the plans and specifications, complete and ready for use. This item shall include connections to the new or existing water service line. Please refer to the Utility Company's Specifications. If the Company does not have specifications, KYTC's Specifications shall be referenced.

This item shall be paid EACH (EA) when complete.

**W PIPE** This description shall apply to all PVC, ductile iron, and polyethylene/plastic pipe bid items of every size and type to be used as water main, except those bid items defined as “Special”. This item includes the pipe specified by the plans and specifications, all fittings (including, but not limited to, bends, tees, reducers, plugs, and caps), tracing wire with test boxes (if required by specification), polyethylene wrap (when specified), labor, equipment, excavation, bedding, restoration, testing, sanitizing, backfill, and etc., required to install the specified new pipe and new fittings at the locations shown on the plans, or as directed, in accordance with the specifications and standard drawings complete and ready for use. No additional payment will be made for rock excavation. This bid item includes material and placement of flowable fill under existing and proposed pavement, and wherever else specified on the plans or in the specifications. **This item shall include all temporary and permanent materials and equipment required to pressure test and sanitize mains including, but not limited to, pressurization pumps, hoses, tubing, gauges, main taps, saddles, temporary main end caps or plugs and blocking, main end taps for flushing, chlorine liquids or tablets for sanitizing, water for testing/sanitizing and flushing (when not supplied by the utility), chlorine neutralization equipment and materials, and any other items needed to accomplish pressure testing and sanitizing the main installation.** This item shall also include pipe anchors, at each end of polyethylene pipe runs when specified to prevent the creep or contraction of the pipe. Measurement of quantities under this item shall be through fittings, encasements, and directional bores (only when a separate carrier pipe is specified within the directional bore pipe). Measurements shall be further defined to be to the center of tie-in where new pipe contacts existing pipe at the center of connecting fittings, to the outside face of vault or structure walls, or to the point of main termination at dead ends. No separate payment will be made under pipe items when the directional bore pipe is the carrier pipe. Please refer to the Utility Company’s Specifications. If the Company does not have specifications, KYTC’s Specifications shall be referenced. This item shall be paid LINEAR FEET (LF) when complete.

**W PLUG EXISTING MAIN** This item shall include the specified plug, concrete blocking and/or anchoring, labor, equipment, excavation, backfill, and restoration required to install the plug in an existing in-service main that is to remain at the location shown on the plans or as directed in accordance with the specifications. Any and all plugs on all existing in-service mains shall be paid under one bid item included in the contract regardless of size. No separate bid items will be established for size variations. Please refer to the Utility Company’s Specifications. If the Company does not have specifications, KYTC’s Specifications shall be referenced. This item shall be paid EACH (EA) when complete.

*NOTE: This utility bid item is not to be paid on new main installations or abandoned mains. This pay item is to plug existing in-service mains only. Plugs on new mains are incidental to the new main just like all other fittings.*

*NOTE: Plugging of existing abandon mains shall be performed and paid in accordance with Section 708.03.05 of KYTC Standard Specifications For Road And Bridge Construction and paid using Bid Code 01314 Plug Pipe.*

**W PRESSURE REDUCING VALVE** This description shall apply to all pressure reducing valves (PRV) of every size required in the plans and specifications except those bid items defined as “Special”. Payment under this description is to be for PRVs being installed with new main. This item includes the PRV as specified in the plans and specifications, polyethylene wrap (if required by specification), labor, equipment, excavation, anchoring (if any), pit or vault, backfill, restoration, testing, disinfection, and etc., required to install the specified PRV at the location shown on the plans in accordance with the specifications and standard drawings complete and ready for use. If required on plans and/or proposed adjoining DIP is restrained, PRVs shall be restrained. PRV restraint shall be considered incidental to the

PRV and adjoining pipe. Please refer to the Utility Company's Specifications. If the Company does not have specifications, KYTC's Specifications shall be referenced. This item shall be paid EACH (EA) when complete.

**W PUMP STATION** This item is for payment for installation of pumps and an above or below ground structure for housing of the pumps. This item shall include all pumps, piping, fittings, valves, electrical components, building materials, concrete, any other appurtenances, labor, equipment, excavation, and backfill, to complete the pump station installation as required by the plans, standard drawings, and specifications, complete and ready for use. Please refer to the Utility Company's Specifications. If the Company does not have specifications, KYTC's Specifications shall be referenced. This item shall be paid LUMP SUM (LS) when complete.

**W REMOVE TRANSITE (AC) PIPE** This item shall include all labor, equipment, and materials needed for removal and disposal of the pipe as hazardous material. All work shall be performed by trained and certified personnel in accordance with all environmental laws and regulations. Any and all transite AC pipe removed shall be paid under one bid item included in the contract regardless of size. No separate bid items will be established for size variations. Please refer to the Utility Company's Specifications. If the Company does not have specifications, KYTC's Specifications shall be referenced. This item shall be paid LINEAR FEET (LF) when complete.

**W SERVICE LONG SIDE** This bid item description shall apply to all service line installations of every size bid up to and including 2 inch inside diameter, except those service bid items defined as "Special". This item includes the specified piping material, main tap, tapping saddle (if required), and corporation stop materials, coupling for connecting the new piping to the surviving existing piping, encasement of 2 inches or less internal diameter (if required by plan or specification), labor, equipment, excavation, backfill, testing, disinfection, and restoration, at the locations shown on the plans or as directed, in accordance with the specifications and standard drawings, complete and ready for use. This bid item is to pay for service installations where the ends of the service connection are on opposite sides of the public roadway and the service line crosses the centerline of the public roadway as shown on the plans. The length of the service line is not to be specified. Payment under this item shall not be restricted by a minimum or maximum length. The contractor shall draw his own conclusions as to the length of piping that may be needed. Payment under this item shall include boring, jacking, or excavating across the public roadway for placement. Placement of a service across a private residential or commercial entrance alone shall not be reason to make payment under this item. Private or commercial entrances shall not be considered a public roadway in defining payment under this item. This pay item does not include installation or relocation of meters. Meters will be paid separately. No additional payment will be made for rock excavation or for special bedding required in rock excavation. Please refer to the Utility Company's Specifications. If the Company does not have specifications, KYTC's Specifications shall be referenced. This item shall be paid EACH (EA) when complete.

**W SERVICE SHORT SIDE** This bid item description shall apply to all service line installations of every size up to and including 2 inch internal diameter, except those service bid items defined as "Special". This item includes installation of the specified piping material of the size specified on plans, encasement of 2 inches or less internal diameter (if required by plan or specification), main tap, tapping saddle (if required), corporation stop, coupling for connecting the new piping to the surviving existing piping, labor, equipment, excavation, backfill, testing, disinfection, and restoration, at the locations shown on the plans or as directed, in accordance with the specifications and standard drawings, complete and



ready for use. This bid item is to pay for service installations where both ends of the service connection are on the same side of the public roadway, or when an existing service crossing a public roadway will remain and is being extended, reconnected, or relocated with all work on one side of the public roadway centerline as shown on the plans. The length of the service line is not to be specified and shall not be restricted to any minimum or maximum length. Payment shall be made under this item even if the service crosses a private residential or commercial entrance; but, not a public roadway. Private or commercial entrances shall not be considered a public roadway in defining payment under this item. The contractor shall draw his own conclusions as to the length of piping that may be needed. This pay item does not include installation or relocation of meters. Meters will be paid separately. No additional payment will be made for rock excavation or for bedding required in rock excavation. Please refer to the Utility Company's Specifications. If the Company does not have specifications, KYTC's Specifications shall be referenced. This item shall be paid EACH (EA) when complete.

**W SERVICE RELOCATE** This item is for the relocation of an existing water service line where a meter is not involved, and where an existing service line can easily be adjusted by excavating alongside and moving the line horizontally and/or vertically a short distance without cutting the service line to avoid conflicts with road construction. This item shall include excavation, labor, equipment, bedding, and backfill to relocate the line in accordance with the plans and specifications complete and ready for use. Payment under this item shall be for each location requiring relocation. Payment shall be made under this item regardless of service size or relocation length. No separate pay items will be established for size or length variation. Please refer to the Utility Company's Specifications. If the Company does not have specifications, KYTC's Specifications shall be referenced. This item shall be paid EACH (EA) when complete.

**W STRUCTURE ABANDONMENT** This item is to be used to pay for abandonment of larger above or below ground water structures such as meter vaults, fire pits, pump stations, tanks, and etc. Payment under this item shall not be limited to size or scope; however structures with connecting pipes of 2 inches or less shall not be paid under this item; but, shall be considered incidental to water construction, (i.e., abandonment of standard water meters up to and including 2 inches would not be paid under this item). Payment under this item shall include all labor, equipment, and compacted fill or flowable fill for abandonment of the structure in place and restoration complete. No separate bid items will be established for size or structure variations. Please refer to the Utility Company's Specifications. If the Company does not have specifications, KYTC's Specifications shall be referenced. This item shall be paid EACH (EA) when complete.

**W STRUCTURE REMOVAL** This item is to be used to pay for removal of larger above or below ground water structures such as meter vaults, fire pits, pump stations, tanks, and etc. Payment under this item shall not be limited to size or scope; however structures with connecting pipes of 2 inches or less shall not be paid under this item; but, shall be considered incidental to water construction, (i.e., removal of standard water meters up to and including 2 inches would not be paid under this item). Payment under this item shall include all labor, equipment, and compacted backfill for removal of the structure and restoration complete. No separate bid items will be established for size or structure variations. Please refer to the Utility Company's Specifications. If the Company does not have specifications, KYTC's Specifications shall be referenced. This item shall be paid EACH (EA) when complete.

**W TAPPING SLEVE AND VALVE SIZE 1 OR 2** This item shall include the specified tapping sleeve, valve, valve box, concrete pad around valve box (when required in specifications or plans), labor, and equipment to install the specified tapping sleeve and valve, complete and ready for use in accordance with

the plans and specifications. The size shall be the measured internal diameter of the live pipe to be tapped. The size tapping sleeve and valve to be paid under sizes 1 or 2 shall be as follows:

Size 1 = All live tapped main sizes up to and including 8 inches

Size 2 = All live tapped main sizes greater than 8 inches

Please refer to the Utility Company's Specifications. If the Company does not have specifications, KYTC's Specifications shall be referenced. This item shall be paid EACH (EA) when complete.

**W TIE-IN** This bid description shall be used for all main tie-in bid items of every size except those defined as "Special". This item includes all labor, equipment, excavation, fittings, sleeves, reducers, couplings, blocking, anchoring, restoration, disinfection, testing and backfill required to make the water main tie-in as shown on the plans, and in accordance with the specifications complete and ready for use. Pipe for tie-ins shall be paid under separate bid items. This item shall be paid EACH (EA) when complete.

**W VALVE** This description shall apply to all valves of every size required in the plans and specifications except those bid items defined as "Special". Payment under this description is to be for gate or butterfly valves being installed with new main. This item includes the valve as specified in the plans and specifications, polyethylene wrap (if required by specification), labor, equipment, excavation, anchoring (if any), valve box and valve stem extensions, backfill, concrete pad around valve box (if required by specification), restoration, testing, disinfection, and etc., required to install the specified valve at the location shown on the plans in accordance with the specifications and standard drawings complete and ready for use. If required on plans and/or proposed adjoining DIP is restrained, valves shall be restrained. Valve restraint shall be considered incidental to the valve and adjoining pipe. This description does not apply to cut-in valves. Please refer to the Utility Company's Specifications. If the Company does not have specifications, KYTC's Specifications shall be referenced. This item shall be paid EACH (EA) when complete.

**W VALVE ANCHOR EXISTING** This bid item is intended to pay for installation of restraint hardware on an existing valve where no restraint exists to hold the valve in place to facilitate tie-ins and other procedures where restraint is prudent. This work shall be performed in accordance with water specifications and plans. This bid item shall include all labor equipment, excavation, materials and backfill to complete restraint of the designated valve, regardless of size, at the location shown on the plans, complete and ready for use. Materials to be provided may include, but is not limited to, retainer glands, lugs, threaded rod, concrete, reinforcing steel or any other material needed to complete the restraint. Should the associated valve box require removal to complete the restraint, the contractor shall reinstall the existing valve box, the cost of which shall be considered incidental to this bid item. No separate bid items are being provided for size variations. All sizes shall be paid under one bid item. Please refer to the Utility Company's Specifications. If the Company does not have specifications, KYTC's Specifications shall be referenced. This item shall be paid EACH (EA) when complete.

**W VALVE BOX ADJUST** Includes all labor, equipment, valve box and valve stem extensions (if required), excavation, backfill, concrete pad around valve box (when specified in specifications or plans), restoration, and etc., to adjust the top of the box to finished grade complete and ready for use. Please refer to the Utility Company's Specifications. If the Company does not have specifications, KYTC's Specifications shall be referenced. This item shall be paid EACH (EA) when complete.

**W VALVE CUT-IN** This bid description is for new cut-in valve installations of all sizes where installation is accomplished by cutting out a section of existing main. This item shall include cutting the existing pipe, supplying the specified valve, couplings or sleeves, valve box, concrete pad around valve box (when required in specifications or plans), labor, equipment, and materials to install the valve at the locations shown on the plans, or as directed by the engineer, complete and ready for use. Any pipe required for installation shall be cut from that pipe removed or supplied new by the contractor. No separate payment will be made for pipe required for cut-in valve installation. Please refer to the Utility Company's Specifications. If the Company does not have specifications, KYTC's Specifications shall be referenced. This item shall be paid EACH (EA) when complete.

**W VALVE VAULT** This item is for payment for installation of an underground structure for housing of specific valve(s) as required by the plans and specifications. This item shall include all labor, equipment, excavation, concrete, manhole castings or doors, the specified valve(s), all piping, and fitting materials associated with installing a functioning valve vault in accordance with the plans, standard drawing, and specifications, complete and ready for use. Please refer to the Utility Company's Specifications. If the Company does not have specifications, KYTC's Specifications shall be referenced. This item shall be paid EACH (EA) when complete.



KENVIRONS

**TECHNICAL SPECIFICATIONS**  
**MAGOFFIN COUNTY WATER DISTRICT**  
**MOUNTAIN PARKWAY (KY 9009) WIDENING**  
**RELOCATION ITEM NO. 10-126.40**

*Prepared By:*

**Kenvirons, Inc.**  
**452 VERSAILLES ROAD**  
**FRANKFORT, KENTUCKY 40601**

**PROJECT No. 2017135**

**NOVEMBER 2017**



## TABLE OF CONTENTS

		<u>Page No.</u>
15100	Waterlines	1 to 22
15101	Waterline Accessories	1 to 3
15102	Special Items of Construction	1 to 13
15103	Pressure Testing and Sterilization	1 to 10
15104	Meters and Services	1 to 3

## SECTION 15100

### WATERLINES

#### 1.0 GENERAL

The Contractor shall furnish all labor, materials, and equipment to install the water lines as shown on the plans and as specified herein.

The water lines may be either pressure-rated plastic pipe (PVC) using the ASTM or AWWA C-900 standard, or ductile iron (DI), all as specified hereinafter and as noted on the plans. The bid documents shall show the anticipated approximate amounts of each type and class of pipe to be provided by the Contractor.

The Owner will obtain all rights-of-way for operations through private property. Owner will also secure building permits and the permits for all pipe laid in highway rights-of-way. Any charges for inspections or other fees required will be the responsibility of the Contractor since the amounts of these are dependent upon the operation of the Contractor.

#### 1.1 KENTUCKY TRANSPORTATION CABINET BONDING

Note: This section not applicable on this project (06-0202.00 – water line relocation).

The Kentucky Transportation Cabinet will require that the Owner post a bond for all work accomplished on their right-of-way. Each contract on which work is to be performed will be a separate application and will require a separate bond. Each permit will have conditions attached and these conditions will vary depending on the area where work is to be performed. In areas where traffic control may pose a problem, working hours may be limited. A copy of the encroachment permit will be provided to the Contractor. The Contractor will be responsible for knowledge of the permit's content and conditions in order that the construction may be accomplished in accordance with the specified requirements.

Should any additional bonds or requirements be imposed by the Kentucky Transportation Cabinet, the Owner shall also be responsible for the bonding of the additional requirements.

#### 2.0 MATERIALS

#### 2.1 POLYVINYL CHLORIDE (PVC) PIPE AND FITTINGS

This specification covers rigid, pressure-rated, polyvinyl chloride pipe and fittings, hereinafter called PVC pipe and PVC fittings, for sizes 1/2 inch through 12-inch.

15100-1

Pipe shall be as manufactured by North American, Diamond, J-M, Certainteed, or approved equal.

#### 2.1.1 General.

2.1.1.1 Pipe Markings. Depending on the type of PVC pipe being used, the following shall be marked along the length of each joint of pipe: manufacturer's name, nominal pipe size and size base, material code (PVC 1120), dimension ratio or standard dimension ratio, pressure class or rating, production record code, certification seal (NSF logo), and, for C-900 PVC pipe, specification designation (i.e., AWWA C-900).

2.1.1.2 Underground Marking for PVC Pipe. Underground marking for either ASTM or C-900 PVC pipe shall be both of the following types.

2.1.1.2.1 Underground Marking Wire. At all locations where PVC pipe is utilized, a detectable underground marking wire shall be placed in the trench approximately 12-inches above the pipe. The wire used shall be No. 12 insulated copper wire. Extreme care shall be exercised in connecting and taping splices and joints to assure continuity. At each valve box the wire shall be looped to the surface extending 12-inches above the concrete valve box pad (see Std. Dwg. for valve). When the entire project or pipeline segment is complete, including meter installation and leak repairs, the locating wire system shall be checked for continuity.

2.1.1.2.2 Underground Marking Tape. At all locations where PVC pipe is utilized, a detectable underground marking tape shall be placed in the trench approximately twelve inches below the finished grade. The tape used shall be mylar encased aluminum foil with the printing "CAUTION - Buried Water Line Below". Printing shall be readable through the clear mylar and surface printing is not acceptable. Tape size shall be 2 inch width as provided by Lifeguard, Inc. or approved equal. Color of the tape shall be blue.

#### 2.1.2 Polyvinyl Chloride (PVC) Pipe—ASTM Standard.

2.1.2.1 PVC Pipe. PVC pipe shall be extruded from Type 1, Grade 1, polyvinyl chloride material with a hydrostatic design stress of 2,000 psi for water at 73.4°F, designated as PVC 1120, meeting ASTM Specifications D-1784 for material and D-2241 for pipe, latest revisions. Pipe shall also meet all applicable provisions of the Product Standards and shall bear the National Sanitation Foundation (NSF) seal of approval in compliance with NSF Standard No. 14. PVC pipe having a maximum hydrostatic working pressure of 160 psi (SDR-26), 200 psi (SDR-21), 250 psi (SDR-17), or 315 psi (SDR-13.5) shall be used as shown in the Bid Documents and Plans.

Samples of pipe and physical and chemical data sheets shall be submitted to the Engineer for review and determination of compliance with these specifications before pipe is delivered to job. The pipe shall be homogeneous throughout and free from cracks, holes, foreign inclusions or other defects.

The workmanship, pipe dimensions and tolerances, outside diameters, wall thickness, eccentricity, sustained pressures (ASTM D-1598), burst pressures (ASTM D-1599), flattening, extrusion quality (ASTM D-2152), marking and all other requirements of the Product Standard PS 22-70 shall be conformed with in all respects. No pipe, 2 inches in diameter or larger, with a wall thickness less than 0.090 inches may be used.

Pipe shall be furnished in 20 feet or 40 feet lengths. The pipe may be double plain end or with bell on one end. Male ends of pipe must be beveled on the outside. Pipe shall have a ring painted around the male end or ends in such a manner as to allow field checking of setting depth of pipe in the socket. This requirement is made to assist construction superintendents and inspectors in visual inspection of pipe installation.

Pipe must be delivered to job site by means which will adequately support it, and not subject it to undue stresses. In particular, the load shall be so supported that the bottom rows of pipe are not damaged by crushing. Pipe shall be unloaded carefully and strung or stored as close to the final point of placement as is practical. Pipe must not be exposed to the direct rays of the sun for an extended period of time. If pipe is not to be installed shortly after delivery to the job site, it must be stored in a shaded location and strung as needed.

2.1.2.2 PVC Pipe Jointing. Pipe shall be joined with slip-type joints with rubber gaskets. Pipes with bells shall have all parts of the bell, including the gasket groove, made from the same extruded piece, integral with the pipe, and shall be thickened to meet standard dimension ratios of wall thickness to outside diameter. This manufacturing procedure shall be the normal practice of the pipe manufacturer and proven by past performance of pipe in service. The gasket groove shall be constructed such that gasket rollout will not occur. Rubber gasketing shall conform to ASTM D-3139.

Joint lubricant shall be of a type recommended by the manufacturer for their pipe subject to the Engineer approval. Lubricant shall be NSF approved water soluble, non-toxic and have no objectionable properties.

Due to special requirements for special gaskets for use within 200 feet of underground fuel tanks, gas lines, and/or oil transport lines, PVC pipe shall not be used under these circumstances.



2.1.2.3 Fittings Ductile iron mechanical joint fittings with appropriate adapter as manufactured by Tyler, U.S. Pipe, Clow, Union Foundry or approved equal, shall be used with PVC pipe. All such fittings shall be approved by the pipe manufacturer, and complete data sent to the Engineer, including the manufacturer's approval, for review. Fittings shall comply with AWWA C-110 or C-153 and shall be manufactured for the size and pressure class of the line on which they are used. Use of transition gaskets will not be allowed unless specifically approved by the pipe manufacturer. Coatings and lining shall be in accordance with section 2.2.7 of the Specifications.

2.1.2.4 Service Connections. All service connections on PVC lines shall be made by means of tees, factory tapped couplings, or bronze service clamps, manufactured specifically for use with PVC pipe as manufactured by Ford or approved equal, and appropriate corporation stop. Whenever possible, corporation steps shall be installed in plastic lines before conducting hydrostatic tests.

### 2.1.3 Polyvinyl Chloride (PVC) Pipe—AWWA C-900 Standard.

This specification covers the requirements for AWWA approved Polyvinyl Chloride Pressure Pipe for water supply and distribution systems.

2.1.3.1 PVC Pipe—AWWA C-900 Standard. PVC pipe shall meet the requirements of AWWA C-900 or C-905, latest revision and shall be furnished in cast-iron pipe equivalent outside diameters with rubber gasketed joints.

C-900 PVC pipe shall be made from Class 12454-A or Class 12454-B virgin compounds as defined in ASTM D-1784. The standard code designation shall be PVC 1120. The PVC compounds shall be tested and certified as suitable for potable water products by the NSF Testing Laboratory and shall carry the NSF approval marking.

Solvent-cement couplings or joints shall not be used. PVC joints using elastomeric gaskets shall be tested as assembled joints and shall meet the laboratory performance requirements specified in ASTM D-3139.

Pipe shall be DR (Dimension Ratio) 18, or DR 14 as shown on the plans or the bid form.

Pipe and couplings shall meet or exceed the following test requirements:

Hydrostatic Integrity - Each standard and random length of pipe shall be proof-tested at four times its rated class pressure for a minimum of 5 seconds. Bells or couplings shall be tested with pipe. The pipe and couplings shall further meet or exceed the pressure test requirements of ASTM D-1598 and D-1599.

Flattening - The pipe shall not split, crack, or break when tested by the parallel-plato method as specified by ASTM D- 2241.

Extrusion quality - The pipe shall not flake or disintegrate when tested by the acetone-immersion method as specified in ASTM D-2241.

Standard length - Pipe shall be furnished in standard laying lengths of 20 ft.  $\pm$  1 in. A maximum of 15 percent of each pipe size may be furnished in random lengths of not less than 10 ft. each.

2.1.3.2 C-900 PVC Pipe Jointing. Pipe shall be joined with slip-type joints with rubber gaskets. Manufacturing and installation procedures shall be as recommended by the manufacturer and as described for PVC pipe in section 2.1.2 of this specification.

2.1.3.3 Fittings. Fittings for municipal PVC shall be ductile iron only. Fittings shall be mechanical joint. Fittings shall be manufactured for the size and pressure class of the line on which they are used and shall comply with AWWA C-110 or C-153. Coatings and lining shall be in accordance with section 2.2.7 of the Specifications. Fittings shall be as manufactured by Tyler, Clow, U.S. Pipe, Union Foundry or approved equal.

2.1.3.4 Service Connections. Service connections shall be made by means of bronze service clamps manufactured specifically for use with C-900 PVC pipe and appropriate corporation stops. Clamps shall be Mueller Catalog No. H-161 or approved equal.

#### 2.1.4 Polyvinyl Chlorine (PVC) Pipe – Restrained Joints

2.1.4.1 PVC Pipe. Products delivered under this specification shall be manufactured only from water distribution pipe conforming to ASTM D2241. The restrained joint pipe system shall also meet all short and long term pressure test requirements of ASTM D2241. Pipe and locking splines shall be completely non-metallic to eliminate corrosion problems. The pipe shall be Certa-Lok Restrained Joint Integral Bell pipe from North American Pipe Corporation or approved equal.

Pipe shall be made from unplasticized PVC compounds having a minimum cell classification of 12454, as defined in ASTM D1784. The compound shall qualify for a Hydrostatic Design Basis (HDB) of 4000 psi for water at 73.4°F, in accordance with the requirements of ASTM D2837.

Restrained joint PVC pipe products shall have been tested and approved by NSF International. 2" through 16" PVC pipe and integral bell systems up to Class 250 shall be listed in NSF14. All products intended for contact with potable water shall be evaluated, tested and certified for conformance with NSF 61 by an

acceptable certifying organization. Copies of agency approval reports or product listings shall be provided to the Engineer.

Nominal outside diameters and wall thicknesses of thrust-restrained pipe shall conform to the requirements of ASTM D2241. Thrust-restrained pipe shall be furnished in 2", 3", 4", 6", 8", 10", 12" and 16" sizes, with pressure ratings from 160 psi to 305 psi. Pipe shall be furnished in standard lengths of 20 feet.

2.1.4.2 PVC Restrained Joints. Pipe shall be joined using an integral bell system for maximum reliability and interchangeability. High-strength, flexible thermostatic splines shall be inserted into mating, precision-machined grooves in the pipe and integral bell to provide full 360° restraint with evenly distributed loading.

## 2.2 DUCTILE IRON PIPE

These specifications cover ductile iron pipe (3-inch diameter and greater) to be used in water transmission systems with mechanical joints, rubber ring slip type joints or flanged joints.

2.2.1 General. Ductile iron pipe shall be designed in accordance with AWWA and for pressures and conditions as stated in these specifications or called for on the plans. Ductile iron pipe shall conform to AWWA C-151.

2.2.2 Minimum Nominal Thickness. The specified thickness will be determined for the given internal and external loading requirements in accordance with AWWA C-150. The class of pipe, wall thickness, and coatings required will be shown on the plans or the bid form and/or as specified herein for all ductile iron pipe installation.

2.2.3 River Crossing Pipe. River crossing pipe shall be ductile iron, Flex-Lok as manufactured by the American Cast Iron Pipe company or equal conforming to the appropriate requirements of AWWA C150/ANSI A21.50 and AWWA C151/ANSI A21.5 with a minimum thickness class of 54.

2.2.4 Lengths. Pipe may be furnished in 12, 16, 16 1/2, 18 or 20 feet nominal laying lengths.

2.2.5 Marking. The net weight, class or nominal thickness and sampling period shall be marked on each pipe.

2.2.6 Pipe Joints for Ductile Iron Pipe. Joints for buried pipe shall be either mechanical joint or push-on joint conforming to the requirements of AWWA C-111. Mechanical joint bolts and nuts shall be the low-alloy steel type conforming to AWWA C-111.

Interior piping of vaults, plants, etc. shall be supplied with flanged joints meeting the requirements of AWWA C-115. Special joints, such as the "locked" or "restrained" type, shall be as shown on the plans and/or called for in the bid schedule.

Gaskets resistant to hydrocarbon penetration shall be used within 200 feet of underground fuel tanks, gas lines, and/or oil transport lines. The gaskets shall be approved by the Engineer.

**2.2.7 Coatings and Lining.** All buried ductile iron pipe shall have manufacturer's outside coal tar or asphaltic base coating and a cement lining and bituminous seal coat on the inside. Cement mortar lining and a bituminous seal coat inside shall conform to AWWA C-104 latest revision.

Where specifically called for on the plans, pipe and fittings housed and in vaults shall be lined and coated on the inside as specified herein for buried ductile iron pipe and fittings, but shall be left uncoated on the outside so that it may be painted without the use of tar stop.

**2.2.8 Fittings for Ductile Iron Pipe.** Ductile iron mechanical, push-on and flanged joints shall conform to AWWA C-110 for centrifugally cast iron water pipe. Mechanical joints shall also conform in all respects to AWWA C-111. All fittings shall be manufactured for the size and pressure class of the pipeline in which they are to be used. All fittings shall be furnished complete with all joint accessories. All ductile iron pipe fittings for water, sewer, air, gas and force main service shall be coated outside and lined on the inside the same as the line on which they are installed.

### **2.3 POLYETHYLENE PIPE**

This pipe is used primarily for stream crossings and other special applications in locations indicated on the Drawings. The required pressure class shall be as shown on the Drawings.

The pipe shall be PE 3408 high density, high molecular weight polyethylene pipe equal to DRISCOPIPE 1000 as manufactured by Phillips Driscopipe, Inc. The pipe shall meet or exceed the following specifications:

- a. ASTM 3350 having a cell classification of PE34534C
- b. ASTM F714 - Dimensions and Workmanship
- c. AWWA C901 - Potable Water Pipe
- d. ASTM D1248 - Type III, Class C, Category 5, Grade P34
- e. ASTM D3261 - Fittings Standard
- f. NSF - Listed, Standard #14

The pipe shall be joined by the butt fusion technique utilizing controlled temperatures and pressures to produce a fused, leak-free joint that has equal or greater strength than the pipe itself in both tension and hydrostatic loading. The joining system shall be equal to Phillips butt fusion joint system.

Transitions to the continuing pipeline shall be made with the appropriate fittings to maintain the integrity of the piping system as recommended by the pipe manufacturer.

Drawings showing details of the installation shall be submitted to the Engineer for approval prior to installation.

### **3.0 EXECUTION**

#### **3.1 HAULING AND STORAGE**

The Contractor shall notify the Engineer when pipe will be received on the job so that proper arrangements may be made for inspecting the unloading and stringing, as well as inspecting and examining the pipe materials.

All pipe shall be covered with tarpaulin during hauling from the manufacturer to the job site. It is acceptable for the front end only to be covered. The intent is to prevent diesel exhaust residue from coating the pipe and/or contaminating the gaskets.

Care must be exercised in the handling of all materials and equipment. The Contractor will be held responsible for all breakage or damage to items caused by his workmen, agents, or appliances for handling or moving. Pipes and other castings shall in no case be thrown or dropped from cars, trucks, or wagons to the ground, but shall be lowered gently and not allowed to roll against or strike other castings and unyielding objects violently.

Valves, castings, fabricated metal, reinforcing steel, etc. shall be yarded or housed in some convenient location by the Contractor and delivered at the construction site as required. All equipment and materials subject to damage from the weather, dampness, changes in temperature, or exposure shall be protected by a dry, weatherproof enclosure until ready for installation or use. The cost of all hauling, handling, and storage shall be included in the prices bid for equipment and materials in place. The Owner takes no risk or responsibility for fire, flood, theft, or damage until after the final acceptance of the work.

#### **3.2 LINES AND GRADES**

The Contractor will be required to accomplish any detailed layout, including that required for establishing the grade of the pipe line.

### 3.3 TRENCH EXCAVATION

3.3.1 General. This section describes the acceptable methods of trenching for the installation of pressure pipe and casing pipe in an open trench.

Trenching may be accomplished by means of a backhoe, trenching machine or by hand depending on the construction area.

At the Contractor's option, trenching, by a trenching machine or by backhoe is acceptable except as noted below:

Where the pipe line is being constructed close to other utilities, structures, building, or large trees, and it is reasonable to anticipate possible damage from the use of a backhoe, then trenching shall be made by hand methods.

The Contractor shall include in his unit price bid, all trenching necessary for installation of all pipelines as planned and specified. Trenching shall include all clearing and grubbing, including all weeds, briars, trees, stumps, etc. encountered in the trenching. The Contractor shall dispose of any such material by burning, burial, or hauling away (or as noted on the drawings), at no extra cost to the Owner. It shall be the Contractor's responsibility to notify the appropriate State and local Air Pollution Control agencies when he conducts open burning of refuse. Ornamental shrubs shall be removed, protected, and replanted. Trenching also includes such items as minor street, road, sidewalk, pipe and small creek crossings, and cutting, moving or repairing damage to fences, poles, gates and/or other surface structures regardless of whether shown on the plans.

The Contractor shall protect existing facilities against danger or damage while pipeline is being constructed and backfilled, or from damage due to settlement of this backfill. In case of damage to any existing structures, repair and restoration shall be made at once and backfill shall not be replaced until this is done. In all cases, restoration and repair shall be such that the damaged structures will be in as good condition and serve its purpose as completely as before and such restoration and repair shall be done without extra cost to the Owner. The use of trench-digging machinery will be permitted except where its operations will cause damage to trees, buildings or existing structures above or below the ground. At such locations hand methods shall be employed to avoid such damage. All excavated material shall be piled in a manner that will not endanger the work and will avoid obstructing sidewalks and driveways. Gutters shall be kept clear or other satisfactory provisions made for street drainage.

All excavation shall be open trenches, except where the drawings call for tunneling, boring, or jacking under structures, railroads, sidewalks and roads. The construction procedure for these types of excavation is described elsewhere in these specifications.

All trench excavation shall be termed unclassified and costs shall be included in the unit price bid for the pipe.

**3.3.2 Clearing.** The Contractor shall accomplish all clearing and/or grubbing as required for the construction under this contract. Clearing and grubbing shall include the cutting and removal of trees, stumps, brush, roots, logs, fences and other loose or projecting material and natural obstructions which, in the opinion of the Engineer, must be removed to properly construct and operate the facilities. Ornamental shrubs, plantings, fences, walls, etc. shall be removed and replanted or replaced or protected from the construction activity. Clearing and/or grubbing shall be incidental to the various bid items and no additional compensation will be paid for same.

**3.3.3 Trench Depth.** Trenches shall be excavated to the line and grade required for the installation of pipe at the elevations indicated on the plans. The minimum depth of cover shall be 30 inches above the top of the pipe, unless shown otherwise on the plans or on the Standard Details. When the pipe is laying in or on solid rock, the minimum depth of cover shall also be 30 inches above the top of the pipe. No additional compensation will be made for extra depth where required by the plans or due to Contractor error. Excavation, except as required for exploration, shall not begin until the proposed work has been staked out. Materials which are not required for backfill and site grading shall be removed and disposed of as directed by the Engineer. Hauling, bedding, and backfilling shall be considered incidental to the various bid items and will not be paid for directly. Excavation shall be of sufficient depth to allow the piping to be laid on the standard pipe bedding in accordance with the section 3.4. The trenches shall be excavated to a minimum of six inches below the bottom of the pipe barrel in rock. In all cases where lines are under traffic a minimum cover of forty-two inches (42") shall be provided. Should it be necessary to avoid existing utilities, culverts, outlets, or other structures, the water line shall be carried deeper at no additional expense to the Owner.

Where the plans call for extra trench depth, this extra depth shall be provided at no extra cost.

**3.3.4 Trench Width.** Trench widths shall exceed the minimum width that will provide free working space on each side of the pipe and to permit proper backfilling around the pipe as shown in the accompanying table and unless specifically authorized by the Engineer, shall not be excavated to wider than two feet (2') plus the nominal diameter of the pipe at the top of the trench. Before laying the pipe, the trench shall be opened far enough ahead to reveal any obstruction that may necessitate changing the line and grade of the pipe. Should the Contractor fail to accomplish this, and changes are required, they shall be at his sole expense. In rock, all ledge rocks, boulders and large stones shall be removed to provide six inches (6") of clearance on each side and below all pipe and fittings.

15100-10

**Minimum Trench Width**

<b>Size</b>	<b>Width</b>
Up to 4" Pipe	1'-6"
6" Pipe	2'-0"
8" Pipe	2'-0"
10" Pipe	2'-4"
12" Pipe	2'-6"
14" Pipe	2'-6"

<b>Size</b>	<b>Width</b>
15" Pipe	2'-8"
16" Pipe	2'-8"
18" Pipe	3'-0"
20" Pipe	3'-2"
21" Pipe	3'-4"
24" Pipe	3'-8"

**3.3.5 Shoring, Sheet piling, and Bracing of Excavation.** Where unstable material is encountered, or where the depth of the excavation in earth exceeds five feet (5'), the sides of the trench or excavation shall be supported by substantial sheet piling, bracing, or shoring. The design and installation of all sheet piling, sheet piling, bracing or shoring shall be based on computations of pressure exerted by the materials to be retained under retaining conditions. Adequate and proper shoring of all excavations will be the entire responsibility of the Contractor. The Standards of the Federal Occupational Safety and Health Act and the Kentucky Department of Labor shall be followed.

The Engineer will not be responsible for determining requirements for bracing or sheet piling.

**3.3.6 Removal of Water.** The Contractor shall provide for adequate removal of all water and the prevention of surface water from entering the excavation. The Contractor shall maintain dry conditions within the excavations until the backfill is placed. No additional compensation will be paid for replacement and/or stabilization of prepared excavations due to flooding and/or deterioration from extended exposure. All water pumped or drained from the excavation shall be disposed of in a suitable manner without damage to adjacent property or to other work under construction.

**3.3.7 Pavement Removal.** Pavement removal shall be as indicated on the plans or directed by the Engineer. When so required, or when directed by the Engineer, only one-half (1/2) of the street crossings or road crossings shall be excavated before placing temporary bridges over the side excavated, for the convenience of the traveling public. All backfilled ditches shall be maintained in such a manner that they will offer no hazard to the passage of traffic. The convenience of the traveling public and the property Owners abutting the improvements shall be taken into consideration. All public or private drives shall be promptly backfilled or bridged at the direction of the Engineer. Pavement replacement shall be in accordance with Section 15120 of these specifications. Excavated materials shall be disposed of so as to cause the least interference



and in every case the disposition of excavated materials shall be satisfactory to the Engineer.

**3.3.8 Traffic Maintenance.** The Contractor shall be held responsible for any damage that may occur to persons or property by reason of the failure of the Contractor to properly guard and flag all open trenches or obstructions along the routes of the water lines. The Contractor at his own expense shall maintain warning signs, barricades and watchmen or flag men to control traffic at such times as his work would interfere with the flow of traffic. No excavation shall begin that may present a safety hazard unless the signs, barricades, lights, etc. are available to protect the open excavation at the conclusion of the day. The Contractor will comply with all Federal and State Occupational Safety and Health requirements for this type of construction. The Contractor shall also comply with all local and Kentucky Department of Highways requirements for signing and traffic control.

**3.3.9 Line Location.** The location of pipelines and their appurtenances as shown are those intended for the final construction. However, conditions may present themselves before construction on any line is started that would indicate desirable changes in location. In such cases, the Owner reserves the right to make reasonable changes in line and structure locations without extra cost, except as may be determined by extra units of materials and construction actually involved. The Owner is under no obligation to locate pipelines so they can be excavated by machine.

### **3.4 BEDDING OF PIPELINE**

In all cases the foundation for pipe shall be prepared so that the entire load of the backfill on top of the pipe will be carried uniformly on the barrel of the pipe. The bells of the pipe shall not carry any of the load of the backfill. The Contractor should refer to the Standard Details for pipe bedding shown in the plans. The bedding specifications shall govern the backfill from the bottom of the trench up to the centerline or spring line of the pipe.

All ductile iron pipe shall be installed in accordance with Standard ANSI/AWWA C150-A21.50 Laying Condition Type 3 unless otherwise noted.

**3.4.1 Stable Earth Foundation.** On all PVC pipelines, the trench bottoms shall be smooth and free of frozen material, dirt clods and stones over 1/2" diameter. Bottom dirt left by trenching equipment will usually provide adequate material to level the trench bottom and provide bedding support for the pipe barrel. If the trench bottom is free of dirt, soft material may be shoveled off the side walls or shoveled under the pipe to insure proper pipe barrel bedding. In areas where the trench bottom is hard, a layer of soft backfill must be provided to insure the pipe barrel is properly cushioned. See the plans for proper bedding material depth.

If the foundation is good firm earth the pipe may be laid directly on the undisturbed earth provided the pipe barrel is supported for its full length.

Bedding of No. 9 stone, fine gravel, sand or compacted finely graded select earth shall be used to correct irregularities in the subgrade.

As an alternative to the above method, excavation may be undercut to a depth below the required invert elevation that will permit laying the pipe on a bed of granular material or finely graded select earth to provide continuous support for the pipe barrel. Bedding depth shall be as shown on the plans.

The bedding is not a separate pay item and shall be included as incidental expense in the unit price for the pipe bid per foot of pipe.

**3.4.2 Trenches In Rock.** All installation in rock will utilize the undercutting method. Bedding will be with 6 inches crushed stone or suitable earth material.

**3.4.3 Unstable Trenches.** If unstable material is encountered which may not provide a suitable foundation for the pipe, the unstable material will be removed and an adequate layer of encasement concrete or other special bedding shall be placed for the pipe foundation in accordance with the Standard Details in the plans. Such "special pipe foundation" shall only be installed if directed by the Engineer in writing or on the plans.

### **3.5 PIPE LAYING**

**3.5.1 General.** Proper instruments, tools and facilities satisfactory to the Engineer shall be provided and used by the Contractor for the safe and convenient prosecution of the work. Each pipe manufacturer shall have an experienced representative on the job for at least one day at the commencement of jointing and laying operations.

Before any length of pipe is placed in the trench, a careful inspection shall be made of the interior of the pipe to see that no foreign material is in the pipe. In order to properly remove any foreign materials, a swab of necessary length is to be available at all times.

All pipe shall be lowered carefully into the trench, properly aligned and properly jointed by use of suitable tools and equipment, in such a manner as to prevent damage to water line materials and protective coatings and linings. Excessive scratching of the exterior surface of the pipe will be cause for rejection of the pipe.

Under no circumstances shall pipeline materials be dropped or dumped into the trench. The pipe and fittings shall also be inspected for the purpose of determining if they are sound and free from cracks. Laying of pipe shall be

commenced immediately after excavation is started. Pipe shall be laid with bell ends facing in the direction of laying.

When pipe laying is not in progress, the open ends of pipe shall be closed by approved means to prevent entrance of trench water into the line. Whenever water is excluded from the interior of the pipe, adequate backfill shall be deposited on the pipe to prevent floating. Any pipe which has floated shall be removed from the trench and relaid as directed by the Engineer. No pipe shall be laid in water or on frozen trench bottom, or whenever the trench conditions or the weather are unsuitable for such work.

If any defective pipe and fittings shall be discovered after the pipeline is laid, they shall be removed and replaced with a satisfactory pipe or fitting without additional charge to the Owner. Open ends of unfinished pipe lines shall be securely plugged or closed at the end of each day's work or when the line is left temporarily at any other time.

3.5.2 Laying Ductile Iron Pipe. Ductile iron pipe shall first be thoroughly cleaned at joints, then joined according to instructions and with tools recommended by the manufacturer. Three (3) copies of instructions shall be furnished to the Engineer and one (1) copy shall be available at all times at the site of the work. The lining inside ductile iron pipe must not be damaged by handling.

All pipes must be forced and held together, or "homed" at the joints, before sealing or bolting. Pipe must be aligned as each joint is placed, so as to present as nearly true, straight lines and grades as is practical, and all curves and changes in grades must be laid in such a manner that the manufacturer's recommended maximum deflection is not exceeded at any joint.

Cutting of pipe may be done by wheeled pipe cutters or saws as the Contractor may elect, but the Contractor will be held responsible for breakage or damage caused by careless cutting or handling.

All ductile iron pipe shall be installed per AWWA C150 Laying Condition Type 3 unless otherwise noted, six inches (6") crushed stone bedding or suitable earth shall be used in rock. No pipe shall be laid resting on rock, blocking, or other unyielding objects. Jointing before placing in trench, and subsequent lowering of more than one section jointed together may be allowed, subject to the Engineer approval and direction.

When using pipe with push-on joints care must be exercised to make certain that the correct gasket is being used for the type of joint installed and that the gasket faces the proper direction. Before inserting the gasket, the groove and bell socket should be carefully cleaned of all dirt. If sand or dirt is permitted to remain in the groove, leaks may occur. Lubricant must be applied to bell socket, gasket

and plain-end of pipe as required by manufacturer. Plain-end must be beveled before joint is made. Deflection required at the joint shall be obtained after the joint is made.

**3.5.3 Laying Plastic Pipe.** The trench bottom must be smooth and uniform and the alignment must conform with the plans. Bedding and cover as specified herein and shown in the Standard Details is required.

To make a clean and unobstructed joint, it is necessary to wipe the ring, groove and pipe spigot free from all foreign materials at the time of assembly. The ring must be positioned properly in the fitting to receive the pipe by a worker who is not in contact with the lubricant. In general, the lubricant is applied to the spigot (not the ring or groove). However, the manufacturer's instructions are to be followed in all cases. Only an approved lubricant may be used in accordance with the manufacturer's recommendations. All plastic pipe shall be joined by hand.

Where good bedding conditions are obtained PVC pipe smaller than 4 inches may be assembled outside the trench in longer sections (as conditions allow) and then lowered into the trench. At any time when improper bedding is discovered or the pipe is severely deflected the pipe will be removed from the trench and the condition corrected. Pipe in sizes 4 inch and above may be assembled outside the trench but must be lowered into the trench as each joint is assembled. Regardless of installation methods all joints must be inspected after laying in trench for proper insertion and alignment. Field cuts and bevels will be allowed in accordance with the manufacturer's recommendations for these operations. A new reference mark shall be installed before joining any field cut pipe. The same requirements for clearance from rock or other objects, thrust blocking and deflections shall apply to PVC pipe as for other pipe materials.

C-900 PVC pipe of all sizes must be assembled in the trench in strict accordance with the manufacturer's requirements.

**3.5.4 Installation of River Crossing Pipe.** The ball joint pipe shall be assembled and installed in accordance with manufacturer's recommendations. Installation shall be made at time of low flow, using cofferdams as necessary to divert stream flow. The ball joint pipe shall be laid and allowed to settle before joining to the pipe on each side of the stream. The ball and joint pipes shall be tested separately once in place to detect any leaks or bad joints. After connecting to the land pipe, it shall be tested the same as specified for the other water mains. See the Drawings for additional installation requirements.

### **3.6 BACKFILLING**

Backfilling must be started as soon as practicable after pipe has been laid. The ENGINEER shall be given a minimum of 8 hours for inspection before backfilling.

The backfill shall be crushed rock, sand, or finely divided earth free from debris, organic material and stones, placed simultaneously on both sides of pipe to the same level by hand.

In backfilling of the lower part of the trench beginning at the top of the bedding, the backfill material shall be carefully selected and walked-in around the pipe in 6" layers to a point 8 inches higher than the top of the pipe. The filling of the trench and the tamping of the backfill shall be carried on simultaneously on both sides of the pipe in such a manner that the completed pipe line will not be disturbed and injurious side pressures do not occur.

After the above specified backfill is hand placed, rock may be used in the backfill in pieces no larger than 18 inches in any dimension and to an extent not greater than one-half (1/2) the backfill materials used. If additional earth is required, it must be obtained and placed by the Contractor. Filling with rock and earth shall proceed simultaneously, in order that all voids between rocks may be filled with earth. Above the hand placed backfill, machine backfilling may be employed without tamping, (if not contrary to specified conditions for the location) provided caution is used in quantity per dump and uniformity of level of backfilling. Backfill material must be uniformly ridged over trench and excess hauled away, with no excavated rock over 1-1/2 inch in diameter or pockets of crushed rock or gravel in top 6 inches of backfill. Ridged backfill shall be confined to the width of the trench and not allowed to overlap onto firm original earth and its height shall not be in excess of needs for replacement of settlement of backfill. All rock, including crushed rock or gravel from construction, must be removed from yards and fields. Streets, roadways and walks shall be swept to remove all earth and loose rock immediately following backfilling.

In the case of street, highway, railroad, sidewalk and driveway crossings or within any roadway paving or about manholes, valve and meter boxes, the backfill must be machine tamped in not over 4-inch layers, measured loose in accordance with the standard details. Where backfill is under paved driveways, streets, highways, railroads, sidewalks, paved parking areas and other areas where settlement is not allowed, flowable fill only shall be used up to the paving surface. Crushed stone shall be Kentucky Department of Highways Standard Specification No. 57. Coarse sand backfill shall be spread in layers not over 4 inches thick and thoroughly compacted. Sand may be moistened to aide compaction. Tunnels shall be backfilled in not over 3-inch layers, measured loose, with selected material suitable for mechanically tamping. If material suitable for tamping cannot be obtained, sand, gravel or crushed rock shall be blown, packed or sluiced to complete fill all void spaces.

Where local conditions permit, pavement shall not be placed until 30 days have passed since placing backfill. As appropriate for roads, parking areas and sidewalks, crushed stone or flowable fill shall temporarily be placed to the top of

trench. Backfills shall be maintained easily passable to traffic at original ground level, until acceptance of project or replacement of paving or sidewalks.

The Kentucky Transportation Cabinet requires that water and sewer lines—when placed within the limits of the roadway embankment and/or beneath the roadway itself—be backfilled with flowable fill as defined by Section 601.03.03.B(5) of their “Standard Specifications for Road and Bridge Construction”. The Cabinet typically requires that flowable fill be used to backfill the trench and/or bore pit up to the subgrade elevation and extending to the outside edge of the shoulder.

Railroad Company and Highway Department requirements in regard to backfilling will take precedence over the above general specification where they are involved.

The Contractor shall protect all sewer, gas, electric, telephone, water and drain pipes or conduits, power and telephone poles and guy wires from danger of damage while pipelines are being constructed and backfilled, or from danger due to settlement of his backfill.

In case of damage to any such existing structures, repair and restoration shall be made at once and backfill shall not be replaced until this is done. In all cases, restoration and repair shall be such that the damaged structure will be in as good condition and serve its purpose as completely as before uncovering and such restoration and repair shall be done without extra charge.

No extra charge shall be made for backfilling of any kind, except as provided in the Bid. Backfilling shall be included as a part of the unit price bid for which it is subsidiary. No extra charge shall be made for supplying outside materials for backfill.

Before completion of contract, all backfills shall be reshaped, holes filled and surplus material hauled away, and all permanent walks, street, driveway and highway paving, and sod, replaced and reseeding performed.

The line Contractor shall be responsible for clean-up, grading, seeding, sodding or otherwise restoring all areas that he disturbs.

Any deficiency in the quantity of material for backfilling the trenches or for filling depressions caused by settlement, shall be supplied by the Contractor.

### 3.7 TIE-INS TO EXISTING PIPELINES

This work shall consist of connecting new water pipes to the existing system where shown on the plans and shall include the necessary fittings, tapping sleeves, valves and necessary equipment and material required to complete the connection.

Knowledge of pipe sizes in the existing system may not be accurate, therefore, it is recommended that the Contractor check outside diameters of existing pipe and types of pipe prior to ordering the required accessories. No additional payment will be allowed for matching pipe and/or accessories when the proper size is not ordered.

Neither the Owner nor the Engineer can guarantee the location of the existing lines. The Contractor shall verify the location of all existing water mains and valves pertaining to the proposed improvements before excavation is started. The necessary regulation or operation of the valves on existing mains, to allow for the connections being made, shall be supervised by the Engineer. Before shutting down an existing water main or branch main for a proposed connection, prior approval for a specific time and time interval shall be obtained from a representative of the Owner. At no time shall an existing main be shut down without the Owner's knowledge and permission.

Excavation to existing water mains shall be carefully made, care being exercised not to damage the pipe. The excavation shall not be of excessive size or depth beneath the pipe. The sides of the excavation shall be as nearly vertical as possible.

The Contractor shall be responsible for any damage to the existing system and any such damage shall be repaired to the satisfaction of the Engineer at the Contractor's expense.

The Contractor shall verify, by field inspection, the necessary sizes, lengths and the types of fittings needed for each inter-connection. Typical connections are shown on the plans and any modifications or changes shall be subject to the approval of the Engineer. The exact length of the proposed water main needed for this work shall also be determined by field measurement as required.

The probing required to locate existing mains is not a separate pay item.

### 3.8 PIPE ENTERING STRUCTURES

Ductile iron, steel or PVC pressure pipe, 4-inch diameter or larger, entering structure below original earth level, unsupported by original earth for a distance of more than six feet (6'), shall be supported by #57 crushed stone. Costs for the support shall be included in the unit price for the pipe.

### 3.9 OWNERSHIP OF OLD MATERIALS

Pipe – Unless otherwise indicated, all existing pipe that is to be abandoned that interferes with construction or is easily removed shall become the property of the

Contractor. All pipe that is not easily removed or not required to be removed as a result of the new construction, shall be abandoned in place by this Contractor.

Pipe Line Fittings and Appurtenances – All pipe line fittings, valves, hydrants and other like appurtenances that are removed as a result of new construction shall be removed by this Contractor but shall become the property of the Owner. All such fittings and appurtenances shall be delivered to a point by the Contractor. Said point shall be on the Owner's property and shall be designated by the Engineer.

Other Materials – All other materials or items that are to be removed, demolished, or abandoned as a part of this contract shall become the property of the Contractor and shall be disposed of by him.

### 3.10 THRUST BLOCKS AND ANCHORAGE

Thrust blocks shall be installed whenever the pipe line changes direction, as at tees, bends, crosses, stops, as at a dead end; or at valves. The locations of thrust blocks depend on the direction of thrust and type of fitting. Their size and type depends on pressure, pipe size, kind of soil, and the type of fitting. Where thrusts act upward (as at vertical curves) the weight of the pipe, the water in the pipe and the weight of the soil over the pipe should be determined to make certain that the total weight is sufficient to resist upward movement. If there is not enough soil or if it will not compact over the pipe or it is too soft to resist movement, then ballast or concrete may be placed around the pipe in sufficient weight and volume to counteract the thrust. Where a fitting is used to make a vertical bend, the fitting may be anchored to a concrete thrust block designed to key in to undisturbed soil and to have enough weight to resist upward and outward thrust, since the newplaced backfill may not have sufficient holding power.

Thrust blocks shall be constructed of not less than Class B concrete conforming to KTC Specification 601 and placed between the fitting and the trench wall. It is important to place the concrete so it extends to undisturbed (freshly cut) trench wall.

### 3.11 MAINTENANCE OF FLOW OF DRAINS AND SEWERS

Adequate provision shall be made for the flow of sewers, drains and water courses encountered during construction. Any structures which are disturbed shall be satisfactorily restored by the Contractor.

### 3.12 INTERRUPTION OF UTILITY SERVICES

No valve, switch or other control on any existing utility system shall be operated for any purpose by the Contractor without approval of the Engineer and the



Utility. All consumers affected by such operations shall be notified by the Contractor as directed by the Engineer and utility before the operation and advised of the probable time when service will be restored.

### 3.13 FENCING

Where water supply line is being constructed in fields where stock is being grazed, Contractor shall provide temporary fence as approved by the Engineer around open trenches to prevent stock from falling in trenches. Where trenching operations should isolate grazing stock from their source of water, Contractor will either provide temporary bridging over trench or else provide water for such stock.

Where trench crosses near sound existing corner posts and existing fence is in good condition, fence may be taken loose, rolled back and stored until pipe line is completed at this point, then replaced by stretching tightly and thoroughly stapling. Additional posts will be provided and additional new fence shall be provided when it is necessary to place the fence crossed by the water line in a condition equal to existing fence before water line was constructed.

Where it is necessary to cut existing fence, new end posts shall be installed on each side of the water line and the old fence thoroughly stapled to these new posts before cutting. After pipe line is completed at this point, a new fence of galvanized wire (No. 9 gauge with No. 11 filler wires) shall be stretched between these new end posts and thoroughly stapled to existing posts and any new intermediate posts necessary to provide a good fence. Replacement of fences shall be on a replacement in-kind basis, and shall be considered incidental to laying of the lines and any additional cost shall be included in the unit price bid per lineal foot of pipe.

### 3.14 PROTECTION OF ADJACENT LANDSCAPE

Reasonable care shall be taken during construction of the water lines to avoid damage to vegetation. Ornamental shrubbery and tree branches shall be temporarily tied back, where appropriate, to minimize damage. Trees which receive damage to branches shall be trimmed of those branches to improve the appearance of the tree. Tree trunks receiving damage from equipment shall be treated with a tree dressing.

In the course of construction, the Contractor may deflect horizontal alignment of the water line to avoid trees and to keep from damaging their roots. The Contractor shall be fully responsible for settling all claims by private property owners concerning damage to trees and shrubs.

### 3.15 COORDINATION WITH UTILITIES

The Plans show the general location of existing utilities such information having been determined from the utilities. However, such information shall be considered general and is not guaranteed by Owner, Engineer or the Utility.

Prior to construction, the Contractor shall arrange to meet with representatives of all utilities, and provide them with his anticipated work schedule. The Contractor shall have the utilities make their best determination of utility locations in the areas in which he is working. Throughout the progress of the work, such field markings of utilities shall be kept current.

Repairs to any utilities damaged by the Contractor shall normally be performed by the utility at the Contractor's expense, unless the Contractor and the utility negotiate other understandings and/or procedures.

### 3.16 BLASTING AND ROCK EXCAVATION

The Contractor shall make his own investigation as he deems necessary to ascertain the sub-surface conditions to be encountered in the work.

All blasting operations shall be conducted in accordance with municipal ordinances, state and federal laws and Section 9, Explosives, of the "Manual of Accident Prevention in Construction", published by the Associated General Contractors of America, Inc. Soil particle velocity shall not exceed limit set by Kentucky law. All explosives shall be stored in conformity with said ordinances, laws and safety regulations. No blasting shall be done within five feet of any water mains, sewer lines, natural or manufactured gas lines, liquid petroleum product lines or other utilities. Any damage done by blasting is the responsibility of the Contractor and shall be promptly and satisfactorily repaired by him.

The Contractor shall use delay caps or other approved methods to reduce earth vibrations and noise. Mud capping, as defined in the above manual, will not be permitted as a method of breaking boulders. No blasting shall be permitted on Sundays or after dark.

Prior to commencing with the work, the Contractor shall, during a preconstruction conference with the Owner and the Engineer, state clearly his approach to performing the excavations on the project. He shall be familiar with the laws and ordinances covering blasting and shall also give consideration to the use of hydraulically operated rock breaking devices in lieu of blasting where considered necessary. If blasting is not handled in an expert manner at all times, the Engineer reserves the right to suspend blasting and require the work to proceed without it.

Prior to blasting, the Contractor shall make his own detailed preblast survey of adjacent walks, curbs, retaining walls, house foundations, etc. to determine conditions prior to the work. Such a file of information, including photographs, may be certified in such a manner as the Contractor believes necessary since this information that may stand in his defense.

#### **4.0 PAYMENT**

Payment for supplying, transporting and storing pipe, trenching, bedding, pipe installation, fittings, thrust-blocking, pipe locating wire and tape, testing, backfilling (including flowable fill, if required), disinfection, seeding, crop damage, regular stream crossings, clean-up, tie-ins to other structures and other incidental items in this section shall be made on the basis of the unit price per lineal foot for the type and size of pipe installed. Payment will include all those items not specifically covered by another proposal. Pipe will be measured along the centerline of the pipe as installed with no deduction for valves and fittings.

**END OF SECTION 15100**

15100-22

## SECTION 15101

### WATERLINE ACCESSORIES

#### 1.0 GENERAL

The Contractor is to supply and install all valves, hydrants, blow-offs and other equipment at the locations shown on the plans in complete accordance with these specifications.

#### 2.0 GATE VALVES

All gate valves shall be the resilient seat-type, iron body, non-rising stem, fully bronze mounted, and suitable for working water pressures of not less than 200 psi for installations on PVC pipe and not less than 250 psi for installations on DI pipe. Valves shall be of standard manufacture and of the highest quality both of materials and workmanship and shall conform to the latest revision of AWWA C-509 Standard. Valves shall be furnished with flanged connections for exposed piping and push-on or mechanical joint connections for buried service. Gate valves shall have a clear water way equal to the nominal diameter, and shall be opened by turning counter-clockwise. The operating nut or wheel shall have an arrow cast in the middle, indicating the direction of opening. Each valve shall have the maker's initials, pressure rating and the year in which manufactured, cast on the body. Prior to shipment from the factory each valve shall be tested by hydraulic pressure of at least 300 pounds per square inch. The valves shall be Mueller or Kennedy brand or approved equal.

Underground valves shall be nut operated, unless otherwise shown on the plans. Valve supplier shall furnish two standard stem iron wrenches for turning nut operated valves. All underground valves which have nuts deeper than thirty inches (30") below the top of valve box shall have extended stems with nuts located within two feet (2') of valve box cap. Buried service valves shall have either epoxy-coated or tar-coated exteriors.

The valve maker is to supply the Engineer, through the bidder, within one week after award is made, complete catalogs or other material giving complete details and dimensions of valves and accessories.

Gate valves installed in underground piping systems may be installed in the vertical position for sizes to 12-inch. Gate valves 14-inch and larger shall be installed in the horizontal position with bevel gear operators unless otherwise noted on the drawings. Gear operators shall be the totally enclosed type, oil filled and designed for buried and submerged service. Gear housing shall be ductile iron. Gears shall be steel. Pinion shafts shall be stainless steel. Shaft bearings shall be Teflon with "O"-Ring bearings.

15101-1

### **3.0 VALVE BOXES**

All valves (gate, air release, check, etc.) installed underground shall be installed in an approved valve box. Each gate valve shall be installed in a vertical position with a valve box. Valve boxes shall be of a cast iron, two or three-piece, slip-type consisting of a base, a center section and a top section with a cover marked "water". Where valve box is constructed in a paved area the box shall be a screw type box. The entire assembly shall be adjustable for elevation and shall be set vertically and be properly adjusted so that the cover will be in the same plane as the finished street surface (no more than 1/2" above ground in yards or pastures or 2" in unsodded areas). The assembly must provide for the required cover over the pipe at the installation site and shall rest on concrete pads as shown in the Standard Details.

### **4.0 BLOW-OFF ASSEMBLY**

Blow-off assembly shall be installed in accordance with the details and the specifications at locations shown on the plans and in other locations as directed by the Engineer. The gate valve is included in the unit bid price for blow-off assembly. The Contractor should refer to the Standard Details for blow-off installation.

The blowoff pipe from the main to the flush valve shall be connected to the main by means of a tee. Do not use a corporation stop for this connection. The gate valve included in the blow-off connection shall be a resilient seat gate valves in conformance with AWWA C509.

### **5.0 TAPPING SLEEVE AND VALVE**

Tapping sleeves shall be as manufactured by Mueller or approved equal, and shall be rated for a minimum working water pressure of 250 psi. Contractor shall ascertain the type and size of pipe to which the connection is to be made prior to selection. The valve shall be as specified under section 2.0 of this specification.

### **6.0 TIE IN CONNECTIONS**

All tie in connections shall include any fittings suitable to make the required connection. The fittings shall be mechanical joint, ductile iron type as specified in other sections.

### **7.0 END CAPS**

All end caps installed to deaden existing lines shall be installed in accordance with the details shown on the plans as appropriate.

## **8.0 MEASUREMENT AND PAYMENT**

Payment for gate valves, check valves and other special valves installed underground shall include all work necessary for a complete installation and shall include all valve stem boxes or other valve boxes and box covers. Payment will be made at the unit price bid for the type and size of valve installation. The unit price bid for blow-off assemblies shall constitute full compensation for the furnishing and installation of the complete blow-off assembly which includes the gate valve. Tapping sleeve and valve, tie-in connections, and end caps shall be paid as indicated in the bid schedule.

**END OF SECTION 15101**

15101-3

## SECTION 15102

### SPECIAL ITEMS OF CONSTRUCTION

#### 1.0 GENERAL

These specifications govern special crossings, installations and construction procedures required to deal with unusual construction items or special requirements of governing agencies.

##### 1.1 BUY AMERICA

All iron and steel products and their coatings that are to be permanently incorporated into the project must meet the Buy America requirements as specified in federal laws and regulations (23 U.S.C. 313 and 23 CFR 635.410).

#### 2.0 STATE HIGHWAY CROSSINGS

In all cases, these crossings will be made in compliance with the requirements of the State Highway Department. Such requirements will normally be described by the appropriate District Highway Office. In general, unless otherwise shown on the plans or directed otherwise by the ENGINEER, the crossing of all State Highways shall be accomplished by boring under the roadway. In addition, the crossing of service lines 1-1/2 inches and greater under rigid and flexible surfaced paved roads shall be accomplished by boring and jacking a casing pipe under said roadway. In certain cases, as shown on the plans, service lines of all sizes will require casing pipe installed with the crossing.

##### 2.1 OPEN TRENCH CROSSINGS

The trench shall be excavated to a minimum width that will allow the pipe installation. The trench walls shall be kept as nearly vertical as possible. The minimum specified cover above the pipe shall be maintained. The Miscellaneous Detail Drawings show the requirements for open trench crossings.

The backfill in the trench under any roads, driveways, or parking areas where the open trench method is used shall be of the type shown in the Miscellaneous Details and shall be deposited and compacted in uniform layers not to exceed the depth shown in the Miscellaneous Details.

The surface of the road, driveway, or parking area shall be replaced with the same type of material as specified under pavement replacement.

## 2.2 BORING AND JACKING

The work is herein defined as the operations in which both the boring by auger and the jacking of the casing pipe are done mechanically and in which the diameter of the casing pipe is too small to permit hand working at the heading of the casing pipe. Two basic methods are; (1) pushing the casing pipe into the fill or earth simultaneously as the boring auger drills out the ground; and (2) drilling the hole through the fill or earth and pushing the casing or carrying pipe into the hole after the drill auger has completed the bore.

A suitable approach trench shall be opened adjacent to the slope of the embankment, or adjacent to point of bored and jacked section as shown on the plans. The approach trench shall be long enough to accommodate the selected working room. Guide timbers or rails for keeping the casing pipe on line and grade shall be accurately set and maintained in the bottom of the approach trench and with heavy timber back-stop supports installed at the rear of the approach trench to adequately take thrust of the jacks without any movement or distortion. It is paramount to the securing of acceptable tolerance limits of workmanship in the boring and jacking operation that extreme care be taken in the setting of all guides, rails and jacks to the end that the casing pipe in final position be within the limits of acceptability for the placing and laying of the carrier pipe. The minimum cover of forty-two inches (42") under the roadway must be maintained. Additional depth may be required as shown on the plans.

In general, the diameter, thickness, style, joints and materials selected for casing pipe shall be as shown on the plans and shall be considered as "minimum" requirements, all subject to prior approval of the Engineer. In all cases, the approval for construction by agreement with the private company and/or construction permit issued by the State, County, or Municipal agency will be required before construction starts.

Steel casing pipe for road and railroad crossings using the boring and jacking method shall be steel, plain end, uncoated and unwrapped, and shall be furnished in at least 18-foot lengths. Steel pipe shall meet the requirements of ASTM Specification A-120 and AWWA C200. Pipes up to and including 4 inches in diameter shall be Schedule 40. Pipe larger than 4 inches shall have a wall thickness equal to or greater than 0.312 inches under railroads and 0.250 for all other uses. The inside diameter of all casing pipes shall be a minimum of four (4") inches greater than the largest outside diameter of the carrier pipe, joint or coupling.

The steel casing pipe shall be bored and/or jacked in place at the locations as shown on the plans or as directed by the Engineer. All joints between lengths shall be solidly welded with a smooth non-obstructing joint inside. Any field welding shall be performed by a certified welder and shall be in accordance with AWWA C206. The casing pipe may be extended beyond the boring limits by



open trenching as shown in the Standard Details. This would apply when the casing is required from right-of-way to right-of-way or ditch line to ditch line. Open trenching at jacked or bored locations will be allowed no closer than 3 feet from edge of pavement.

Positioning guides (insulators) shall be utilized on all carrier pipe which is within the casing pipe. Positioning shall be accomplished by the use of prebuilt spacers such as those manufactured by Calpico, Advanced Products and Systems, Inc. (APS), or an approved equal. The Contractor shall submit the type of position guide proposed for use for the approval of the Engineer. Spacing of the positioning guides shall be in accordance with the Standard Drawings.

The ends of the casing pipe shall be plugged and made watertight in a manner acceptable to the Engineer prior to backfilling. Casing seals as manufactured by Pipeline Seal & Insulator, Inc. (PSI), Advance Products & Systems, Inc. (APS) or equal shall be used.

Where road crossings are made using plastic pipe or copper, the location of joints under the roadway should be avoided by using lengths of adequate dimension for the crossing. This principle also applies to other types of pipe where sufficiently long lengths are available.

### **3.0 RAILROAD CROSSINGS**

At all railroad crossings, cover pipe (casing) for water lines (carrier pipe) shall be jacked or pushed beneath tracks and the carrier pipe jointed and pushed through the cover pipe. Detailed drawings of railroad crossings including the length of casing and depth below track are shown in the plans. Contractor shall obtain and pay for services of a representative of the railroad to direct the Contractor's operations while on the railroad property when required by the railroad.

### **4.0 STREAM CROSSINGS**

#### **4.1 NO-FLOW CONDITION**

Where required on the plans or instructed by the Engineer, the Contractor shall construct a special creek crossing as shown in the Miscellaneous Detail Drawings. Crossings shall be scheduled for construction in times of no flow or very low flow, if practicable, otherwise the stream shall be directional bored. Concrete shall not be placed under water and Contractor shall provide suitable pumps to keep water out of trench excavation during stream crossing construction. Special creek crossings shall be designated as Type A or Type B as contained in the Miscellaneous Detail Drawings.

#### 4.2 NORMAL EARTHEN STREAM CROSSING

Where the stream crossing is made in earth or other beds which are stable (no casing or anchorage required), then the pipe will be laid in a narrow trench at the depth specified in the Miscellaneous Details to maintain the required cover between pipe and stream bed. Initial backfill will be mechanically compacted. Trench backfill in any stream crossing area from one foot (1') above the top of the pipe shall consist of trench excavated rock, if available. No extra payment will be made above normal construction for this type of creek crossing.

#### 4.3 BLUE LINE STREAM CROSSINGS

All crossing of streams that appear as a blue line on a USGS 7.5 minute topographical map shall be accomplished in accordance with:

##### GENERAL CERTIFICATION NATIONWIDE PERMIT #12 UTILITY LINE BACKFILL AND BEDDING

This document is bound in front of the specifications. The Contractor shall read, understand and comply with the requirements and procedures.

Stream size, for purposes of this specification, is differentiated as large or small. A stream is classified as small when the distance across the stream channel at top of banks is 15 L.F. or less. A stream is classified as large when this measurement is greater than 15 L.F.

It is the intent of the plans to identify a stream crossing at each blue line stream. Small stream crossings may frequently be accomplished by trenching when the stream is in a no-flow condition. If the stream is in a flow condition, irregardless of the size classification, the crossing shall be accomplished by directional boring or other method that complies with the General Certification and is approved by the Engineer. Specific details for stream crossings are contained in the Miscellaneous Detail Drawings.

See Section 15 for Basis of Payment.

#### 4.4 BYPASS TEST METER

At locations as indicated on the plans, where a new creek crossing is installed, a bypass test meter shall be installed. The meter shall be installed as a normal water meter with taps on each side of a valve, as shown in the Miscellaneous Detail Drawings.

## **5.0 RIVER OR LAKE CROSSINGS**

Crossings in rivers or lakes where the pipe cannot be laid in a trench shall normally be made with ductile iron pipe having ball and socket joints or polyethylene pipe or directional bored as indicated on the Drawings. Details for any required installations of this type including pipe required; number, size and location of anchors; and, installation technique are shown in the plans and Miscellaneous Detail Drawings. See Section 15100 for installation requirements.

## **6.0 BRIDGE CROSSINGS**

Wherever possible bridges will not be utilized for stream crossings. However, where it is necessary for the water line to be attached to bridges, the pipe shall be securely fastened to bridge stringers or beams using supports as dimensioned and located in the plans. The carrier pipe shall be insulated with Vermiculite or other approved material to prevent freezing. Expansion joints to allow for movement of the bridge will be required as shown on the plans.

## **7.0 FREE BORE**

### **7.1 WORK INCLUDED**

Under this item, the Contractor shall provide all labor, tools, equipment and materials to install the free bore at all bituminous and concrete driveways and/or county road unless otherwise directed by the Engineer.

### **7.2 INSTALLATION**

The Contractor shall provide a jacking pit and bore through the earth at the proper line and grade. The augured hole shall be as small as practical to allow the carrier pipe to pass through.

This bid item does not apply to service tubing.

### **7.3 MEASUREMENT AND PAYMENT**

The unit price bid per linear foot for free boring, as measured from edge of pavement to edge of pavement, regardless of size of bore, shall constitute full compensation for the work specified.

## **8.0 WATER LINE AND SEWER LINE SEPARATION**

### **8.1 GENERAL**

Wherever sewer lines cross, or are adjacent to, each other, special precautions shall be taken.

15102-5

## 8.2 PARALLEL WATER AND SEWER LINES

Water lines must, if possible, be located a minimum lateral distance of 10 feet from any existing or future sewer lines measured from outside diameters. Where water lines and sewer lines must be placed in the same trench, the water line must be located on a shelf, 2 feet above and 2 feet to the side of the sewer line. Whenever this condition cannot be met, and upon direction from the Engineer, the water line shall be uncovered and encased with concrete per the standard encasement detail.

## 8.3 CROSSING WATER AND SEWER LINES

Wherever sewer lines and water lines cross, it is desirable, if practical, that the sewer line be at least 24 inches below the water line.

Where it is not practical to provide such a separation, care shall be taken to ascertain that the existing water line or existing sewer line is in good sound condition and that no evidence of joint leakage is known in that vicinity. If any such evidence does exist, the existing line shall be exposed by the Contractor at least 10 feet each side of the new pipe crossing, carefully examined and any defects positively corrected. The Owner will arrange for examining and correcting any defects in the existing lines, but the Contractor shall cooperate in every way possible.

When the water line must be below or less than 2 feet above the sewer line, the Contractor shall encase the water line 5 feet in each direction from the crossing as directed by the Engineer. This encasement should only be accomplished when directed by the Engineer and shall be accomplished in accordance with the details shown on the drawings. The encasement is a separate pay item.

## 9.0 **CLEANUP, SEEDING AND SODDING**

### 9.1 GENERAL

Upon completion of the installation of the work, the Contractor shall remove all debris and surplus construction materials resulting from the work. The Contractor shall fine grade all the disturbed surfaces around the area of the work in a uniform and neat manner leaving the construction area in a condition as near as possible to the original ground line or to the lines as directed by the Engineer. The Contractor shall provide effective cleanup of the work as it progresses. Procrastination of cleanup will not be tolerated.

### 9.2 ROUGH GRADE WORK AND CLEANUP

Rough Grade Work and Cleanup (Rough Cleanup) shall be defined to include the final backfill and windrowing of the ditch line, disposal of excess excavated

material, level grading of the disturbed areas adjacent to the ditch line, filling and leveling street and driveway cuts, cleaning up and removal of rubbish, repair of fences and structures, and any other such work that may be required to result in a neat, orderly project area. Rough Cleanup shall be performed as other construction progresses and must be completed within **one week** of the adjacent pipeline construction.

Rough Cleanup is not a separate pay item. The cost for this work shall be included in the unit bid price for water lines. If Rough Cleanup is not performed as specified, the Owner, after notification to the Contractor, will refuse payment for additional pipeline installation until the Rough Cleanup is accomplished.

### 9.3 FINAL CLEANUP

Final cleanup, grade work and seeding shall be performed on each line when backfilled trenches have had adequate time to settle, but at least within **30 days** from the date each line is constructed. Final grade work and seeding on Kentucky Transportation Cabinet rights-of-way shall be done in accordance with said Cabinet's specifications and the permit granted to the Owner specifically for this project.

Where work was performed on private property in lawns, earth of good quality, free from rock shall be spread over the disturbed area and graded and compacted to match adjacent ground contours. The graded and seed bed area shall be prepared with a power landscape rake and further hand raked if necessary, until smooth and free from rock, potholes, and bumps. The disturbed area shall then be seeded with the seed variety used on the original lawn (e.g., a bluegrass lawn shall be reseeded with bluegrass seed). In the case of no preference by the Owner, the mixture of grasses shall consist of one-third (1/3) Rye grass, one-third (1/3) Kentucky Fescue and one-third (1/3) Kentucky Bluegrass by weight and shall be applied in accordance with the supplier's recommendations. The area shall be fertilized with 12-12-12 fertilizer applied at a rate of 6 pounds per 1,000 square feet of area. After the seed and fertilizer have been applied, the Contractor shall then lightly cover the seed by use of a drag or other approved device. The seeded area shall then be covered with clean straw to a depth of approximately one (1) inch.

Where work was performed on private property and not in lawns the trench line shall be graded and filled if necessary to match adjacent contours. All rock larger than 1-1/2" in diameter shall be removed from the disturbed area. In general, pasture and fallow land shall be fertilized and seeded with Kentucky 31 Fescue and plowed fields shall be left unseeded, however, the desire of each property owner shall govern regarding seeding. The entire pipeline length that is seeded shall be strawed.

In all cases on private property the rate of seed and fertilizer application shall be that recommended by the material supplier or the University of Kentucky Cooperative Extension Service for new plantings of the variety of grass seed used.

If the trench line settles following final grade work or if grass seed fails to germinate within a reasonable time, the Contractor shall regrade or reseed the area in question as specified above and as directed by the Engineer.

Final cleanup will not constitute a separate pay item and shall be included in the unit bid price for pipe.

## **10.0 PAVEMENT AND OTHER STRUCTURE REPLACEMENT**

The Contractor shall replace all pavement cut or disturbed, with pavement similar in all respects to existing pavement in accordance with the Standard Details and at those locations approved by the Engineer. Every effort shall be made to avoid cutting the pavement. In restoring pavement, new pavement is required, except that granite paving blocks, sound brick or sound asphalt paving blocks may be reused. No permanent paving shall be placed within thirty (30) days after the backfilling has been completed. All concrete and asphalt paving materials shall be in conformance with the Miscellaneous Details shown in the plans. The pipeline trench through all paved areas (parking lots, driveways, roads, etc.) shall be fully backfilled with crushed stone.

### **10.1 CLASSIFICATIONS OF PAYMENTS**

- A. Concrete Pavement Replacement - This pavement replacement shall be Portland cement concrete construction in accordance with the requirements shown in the Standard Details. It shall include all pavement replacement on concrete surfaced roads, concrete driveways, concrete sidewalks and concrete parking areas, both public and private.
- B. Heavy-Duty Bituminous Pavement Replacement - This type of asphalt pavement replacement shall be bituminous concrete surface over concrete base in accordance with the details. This type of pavement replacement shall be used on all heavily trafficked roads having an existing pavement greater than 2", whether public or private, or in other locations as directed by the Engineer.
- C. Light-Duty Bituminous Pavement Replacement - This type of pavement replacement shall be bituminous concrete constructed in accordance with the details. This item shall include all light-duty bituminous concrete roadways, bituminous driveways and bituminous parking lots, both public and private.

D. Crushed Stone Surface Replacement - This type of surface replacement shall include all graveled roadways, driveways, parking areas, or other gravel surfaced areas, both private and public. This type of surfacing may also be required as a base course for other pavement replacement.

## 10.2 MATERIALS

The crushed stone backfill as noted on the drawings shall be dense graded aggregate per Kentucky Department of Highways Specifications or as noted on the Drawings. The Contractor shall continuously be responsible for the maintenance of the aggregate and the surface of the trenches until the pavement replacement is completed.

Portland cement concrete for pavement replacement shall contain a minimum of 6 sacks of cement per cubic yard, the maximum free water content shall be 6 gallons per sack of cement, the slump shall be between 2 and 4 inches, and the concrete shall have minimum 28-day compression strength of at least 3,500 PSI. Cement, aggregate and water shall be described in these specifications for Class "A" concrete. A set of cylinders shall be made and tested for each 25 cubic yards of concrete placed, or fraction thereof, to supply representative sampling and testing of the concrete, upon the direction of the Engineer. The Contractor shall produce a broomed, or burlaped uniformly smooth and nonskid surface, consistent with the existing pavement.

Bituminous materials and mixes shall be consistent with the recommended practice of the asphalt institute and it shall conform to the requirements of the Kentucky Department of Highways for prime coat and Class 1 bituminous concrete. The bituminous concrete shall consist of a binder or base course and a surface course.

## 10.3 INSTALLATION OF PAVEMENT REPLACEMENT

The Contractor shall cut back the surfacing adjacent to the trench for 12 inches on both sides of the trench and shall cut down the dense graded aggregate he has placed to a depth required for either type of pavement replacement. The resulting surface shall be rolled to yield a smooth, dense surface and a uniform depth.

The concrete shall be placed in accordance with standard practice, with the welded wire mesh if required in proper position and thoroughly vibrated into place. The Contractor shall produce a surface consistent with the existing pavement. The Contractor shall apply a liquid curing component, sprayed on the surface of the concrete, and shall provide adequate protection to the pavement until it has set.

For bituminous concrete, the Contractor shall clean and broom the prepared surface, then apply the prime coat at the rate of 0.20 to 0.25 gallons per square yard, with a pressure distributor or approved pressure spray method. When the prime coat has become tacky but not dry and hard, the bituminous binder course, or base course, whichever applies, shall be placed and compacted. The Contractor shall then apply the surface course. It is recommended, but not required, that the base course remain in place for approximately one week before placing the surface course. The finished course shall be compacted and the completed surface shall match the grades and slopes of the adjacent existing surfacing and be free of offsets, depressions, raised places and all other irregular surfaces.

#### 10.4 SEASONAL AND WEATHER LIMITATIONS FOR PAVEMENT REPLACEMENT

In the event the progress and scheduling of the work is such that the bituminous pavement replacement would occur in the winter months, during adverse cold weather and/or during such times the asphalt plants are not in operation, then the final pavement replacement shall be postponed until favorable weather occurs in the spring and the asphalt plants resume normal operations. No bituminous concrete shall be laid when the temperature is below 40°F except by written permission of the Engineer.

Concrete pavement shall not be placed when the temperature is such that the pavement placed will freeze before it has had adequate time to set and shall be placed in conformance with the temperature conditions approved by the Engineer.

The Contractor shall be responsible for replacement of pavement which he has placed which has been damaged by cold weather or freezing without additional compensation.

In the meantime, the Contractor will be required to maintain the temporary surfacing until the permanent pavement is placed. Such labor, materials and equipment as is required for temporary maintenance of the streets, roadways and driveways shall be provided at the Contractor's expense and is not a pay item. The Contractor will be required to use a cold mix asphaltic concrete as a temporary surface for trenches under heavy traffic use.

#### 10.5 GUARANTEE

The one year guarantee as specified in the contract documents is also applicable to trench settlement and pavement replacement.



## **11.0 SIDEWALK AND DRIVEWAY REPLACEMENT**

Sidewalks and driveways will be replaced if damaged by the Contractor in any way. Payment will be made for those pavements necessarily damaged by the line installation in accordance with the Standard Details. No pavements are to be replaced over a backfilled trench for at least 30 days after filling. Pavements damaged otherwise are to be replaced immediately at the Contractor's expense.

Materials and dimensions are to be at least equal to existing pavement and are to conform to the Standard Details.

## **12.0 PAYMENT FOR WATER**

All water used from the Utility shall be metered with meters supplied by the Contractor. The Contractor shall pay for such water monthly at the rates published by the water utility. Unmetered water lost through water line breakage shall also be paid at the rates published by the water utility. The quantity lost shall be computed on the basis of a discharge velocity of 7 feet/second, the diameter of the line, and the estimate duration of free uncontrolled discharge.

## **13.0 FINAL CLEAN-UP**

The Contractor shall provide effective cleanup of the work as it progresses. Procrastination of cleanup will not be tolerated. At the time of final inspection, no trenches shall show any undue evidence of the previous construction. All areas shall be left free of ruts due to construction equipment and shall have a clean and neat appearance without rubble or debris. The areas shall not be mounded up and shall be completely restored, and all yards and fields shall be reseeded so land may be cultivated, mowed, etc. Straw and fertilizing shall accompany the seeding in accordance with Item 9 - Cleanup, Seeding and Sodding of this section. If necessary to hasten proper restoration of terraces, principally along ditch lines, the Contractor shall sod such areas at the Engineer's direction. For all line segments, final cleanup shall be performed within 30 days from day of installation.

## **14.0 PROTECTION OF ADJACENT LANDSCAPE**

Reasonable care shall be taken during construction of the water lines to avoid damage to vegetation. Ornamental shrubbery and tree branches shall be temporarily tied back, where appropriate, to minimize damage. Trees which receive damage to branches shall be trimmed of those branches to improve the appearance of the tree. Tree trunks receiving damage from equipment shall be treated with a tree dressing.

In the course of construction, the Contractor may deflect horizontal alignment of the water line to avoid trees and to keep from damaging their roots. The

Contractor shall be fully responsible for settling all claims by private property owners concerning damage to trees and shrubs.

## **15.0 MEASUREMENT AND PAYMENT**

15.1 Payment for crushed stone, black top and concrete pavement replacement will not be based on the quantities purchased by the Contractor. Payment for surfacing will be paid on the basis of linear feet installed in accordance with the Standard Drawings with a maximum width of pipe diameter plus 24 inches. Crushed stone or concrete sub-grade under paving and crushed stone trench backfill shall be included in paving price and not paid for separately. Any additional cost estimated by the Contractor must be included in the cost of pipe in place.

### **15.2 STREAM CROSSINGS**

15.2.1 No-Flow Crossings. Payment for no-flow stream crossings delineated on the plans (excluding directional bores) will be at the unit price bid per lineal foot for that item and shall include encasement pipe, crushed stone, concrete, solid rock excavation and all other work necessary for a satisfactory installation. The carrier pipe installed in the casing shall be paid separately under the unit price bid for pipe installed.

15.2.2 Directional Bores. Payment shall be "Lump Sum" for specific individual Bid Items for Directional Bores of large stream crossings and/or some streams classified as small where the physical crossing characteristics differ significantly from the other small streams in the project. Determination of the required length to accomplish the bore is the responsibility of the Contractor.

Payment shall be "Each" for directional bores of small stream crossings with the exception of individual small streams covered in a specific bid item. All small stream crossings in the project shall be considered the same for payment regardless of width (up to 15 L.F.) or depth. It is the responsibility of the Contractor to determine an average unit price that will be used for payment in each instance a blue line stream is crossed. Small stream crossings may be added, for extended lines beyond those shown on the plans, at the same unit price providing the crossings are reasonably similar to those in the initial project. Stream crossings may be deleted, without affecting the unit price, if a line is deleted or shortened.

Payment shall include the directional bore, encasement pipe if specified on the plans, the carrier pipe as specified on the plans and the transition fittings. Payment limits are shown on the Miscellaneous Drawing for Directional Bore for Stream Crossings.

Payment for Bypass Test Meter or Leak Detection Test Meter shall include a meter setting (5/8" x 3/4") and taps on both sides of a gate valve. The gate valve, sized for the line, is a separate pay item, covered in Section 15101.

15.3 Additional costs for normal earth creek crossings shall be included in the unit price bid for pipe installation and no special payment will be made for these crossings.

15.4 Casing pipe unit price bids shall include the cost of boring or jacking under railroads and highways and shall include the cost of steel casing pipe. Carrier pipe will be paid for under the unit price bid for installing lines as described in Article 2.2 of this section.

15.5 Sidewalk /driveway crossings when included as a bid item shall include the extra cost of free-boring or the removal and disposal of existing pavement and replacement with new construction. Payment for pavement replacement will be on the basis of linear feet installed. Width for payment for a standard trench crossing is shown in the Standard Details. When sidewalk/driveway crossings or replacement are not included as a bid item, their costs shall be considered subsidiary to the bid for pipe installation.

#### **END OF SECTION 15102**

## SECTION 15103

### PRESSURE TESTING AND STERILIZATION

#### 1.0 TESTING

1.01 After the pipe has been laid, all newly laid pipe or any valved section thereof shall be subjected to a hydrostatic pressure test of at least 1.5 times the working pressure at the point of testing, but in no case less than that required by other Sections herein. In addition, a leakage test shall be conducted concurrently with the pressure test.

#### 1.02 PRESSURE TEST

A. Test pressure shall:

1. Not be less than 1.25 times the working pressure at the highest point along the test section.
2. Not exceed pipe or thrust restraint design pressures at the lowest point along the test section.
3. Be of at least six (6) hour duration unless otherwise stipulated by Owner.
4. Not vary by more than plus or minus 5 psi.
5. Not exceed twice the rated pressure of the valves or hydrants when the pressure of the test section includes closed gate valves or hydrants.
6. Not exceed the rated pressure of resilient seat butterfly valves when used.

B. Each valved section of pipe shall be filled with water slowly and the specified test pressure, based on the elevation of the lowest point of the line or section under test and corrected to the elevation of the test gauge, shall be applied by means of a pump connected to the pipe in a manner satisfactory to the Engineer.

C. Before applying the specified test pressure, air shall be expelled completely from the pipe, valves, and hydrants. If permanent air vents are not located at all high points, the contractor shall install corporation cocks at such points so that the air can be expelled as the line is filled with water. After all the air has been expelled, the corporation cocks shall be closed and the test pressure applied. At the conclusion of the pressure test, the corporation cocks shall be removed and plugged, or left in place at the discretion of the Engineer.

- D. All exposed pipe, fittings, valves, hydrants, and joints shall be examined carefully during the test. Any damage or defective pipe, fittings, valves, hydrants or other appurtenances that are discovered during or following the pressure test shall be repaired or replaced with sound equipment and materials, and the test shall be repeated until all test results are satisfactory in the opinion of the Engineer.

### 1.03 LEAKAGE TESTING

- A. Leakage shall be defined as the quantity of water that must be supplied into the newly laid pipe, or any valved section thereof, to maintain pressure within 5 psi of the specified test pressure after the air in the pipeline has been expelled and the pipe has been filled with water.
- B. No pipe installation will be accepted if the leakage is greater than that determined by the following formula:

$$L = ND(P \text{ exp } 1/2)/133,200$$

in which L is the allowable leakage, in gallons per hour; N is the length of pipeline tested in feet; D is the nominal diameter of the pipe, in inches; and P is the average test pressure during the leakage test, in pounds per square inch gauge.

1. Allowable leakage at various pressures is shown in TABLE K-1.
  2. When testing against closed metal-seated valves, an additional leakage per closed valve of 0.0078 gal/hr/in of nominal valve size shall be allowed.
  3. When hydrants are in the test section, the test shall be made through the open isolation valve and against the closed hydrant valve.
- C. Acceptance shall be determined on the basis of allowable leakage. If any test of pipe laid discloses leakage greater than that specified in Section 1.03.B the Contractor shall, at his own expense, locate and repair the defective material until the leakage is within the specified allowance.

All visible leaks are to be repaired regardless of the amount of leakage.

(continued)

**Table K-1**  
**Allowable Leakage Per 1,000 Ft. Of Pipeline (GPH)**

Avg. Test Pressure psi	Nominal Pipe Diameter (Inches)								
	2	3	4	6	8	10	12	14	16
450	0.32	0.48	0.64	0.95	1.27	1.59	1.91	2.23	2.55
400	0.30	0.45	0.60	0.90	1.20	1.50	1.80	2.10	2.40
350	0.28	0.42	0.56	0.84	1.12	1.40	1.69	1.97	2.25
300	0.26	0.39	0.52	0.78	1.04	1.30	1.56	1.82	2.08
275	0.25	0.37	0.50	0.75	1.00	1.24	1.49	1.74	1.99
250	0.24	0.36	0.47	0.71	0.95	1.19	1.42	1.66	1.90
225	0.23	0.34	0.45	0.68	0.90	1.13	1.35	1.58	1.80
200	0.21	0.32	0.43	0.64	0.85	1.06	1.28	1.48	1.70
175	0.20	0.30	0.40	0.59	0.80	0.99	1.19	1.39	1.59
150	0.19	0.28	0.37	0.55	0.74	0.92	1.10	1.29	1.47
125	0.17	0.25	0.34	0.50	0.67	0.84	0.01	1.18	1.34
100	0.15	0.23	0.30	0.45	0.60	0.75	0.90	1.05	1.20

Avg. Test Pressure psi	Nominal Pipe Diameter (Inches)							
	18	20	24	30	36	42	48	54
450	2.87	3.18	3.82	4.78	5.73	6.69	7.65	8.60
400	2.70	3.00	3.60	4.50	5.41	6.31	7.21	8.11
350	2.53	2.81	3.37	4.21	5.06	5.90	6.74	7.58
300	2.34	2.60	3.12	3.90	4.68	5.46	6.24	7.02
275	2.24	2.49	2.99	3.73	4.48	5.23	5.98	6.72
250	2.14	2.37	2.85	3.56	4.27	4.99	5.70	6.41
225	2.03	2.35	2.70	3.38	4.05	4.73	5.41	6.03
200	1.91	2.12	2.55	3.19	3.82	4.46	5.09	5.73
175	1.79	1.98	2.38	2.98	3.58	4.17	4.77	5.36
150	1.66	1.84	2.21	2.76	3.31	3.86	4.41	4.97
125	1.51	1.68	2.01	2.52	3.02	3.53	4.03	4.53
100	1.35	1.50	1.80	2.25	2.70	3.15	3.60	4.05

## 2.0 STERILIZATION

### 2.01 GENERAL

It is the intent of this Section to present essential procedures for disinfecting new and repaired water mains. This Section is patterned after AWWA C651. The basic procedure comprises:

- A. Preventing contaminating materials from entering the water mains during construction or repair and removing by flushing materials that may have entered the water main.
- B. Disinfecting any residual contamination that may remain.
- C. Determining the bacteriologic quality by laboratory test after disinfection.

### 2.02 PREVENTIVE MEASURES DURING CONSTRUCTION

- A. Precautions shall be taken to protect pipe interiors, fittings, and valves against contamination. Pipe delivered for construction shall be strung so as to minimize entrance of foreign material. When pipe laying is not in progress, for example at the close of the day's Work, all openings in the pipe line shall be closed by water tight plugs. Joints of all pipe in the trench shall be completed before Work is stopped. If water accumulates in the trench, the plugs shall remain in place until the trench is dry.

If dirt that, in the opinion of the Engineer, will not be removed by the flushing operation (Section 2.3) enters the pipe, the interior of the pipe shall be cleaned and swabbed as necessary, with a five (5%) percent hypochlorite disinfecting solution.

- B. Packing Materials and Joints—No contaminated material or any material capable of supporting prolific growth of micro-organisms shall be used for sealing joints. Packing material shall be handled in such a manner as to avoid contamination. Where applicable, packing materials must conform to AWWA standards. Packing material for cast iron pipe must conform to AWWA C600. Yarning or packing material shall consist of molded or tubular rubber rings, rope of asbestos or treated paper. Materials such as jute or hemp shall not be used. The lubricant used in the installation of sealing gaskets shall be suitable for use in potable water. It shall be delivered to the job in enclosed containers and shall be kept clean.

## 2.03 PRELIMINARY FLUSHING

The main shall be flushed prior to disinfection unless disinfected by the method in Section 2.04.B.1. It is recommended that the flushing velocity be not less than 2.5 ft/sec. The rate of flow required to produce this velocity in various diameters is shown in Table K-2. No site for flushing should be chosen unless it has been determined that drainage is adequate at the site.

**Table K-2  
Required Openings To Flush Pipelines  
(40-PSI Residual Pressure)**

Pipe Size (in)	Flow Required to Produce 2.5 fps Velocity (gpm)	Orifice Size (in)	Hydrants Required	
			Number of Hydrants	Nozzle Size (In)
4	100	15/16	1	2 1/2
6	220	1 3/8	1	2 1/2
8	390	1 7/8	1	2 1/2
10	610	2 5/16	1	2 1/2
12	880	2 13/16	1	2 1/2
14	1,200	3 1/4	2	2 1/2
16	1,565	3 5/8	2	2 1/2
18	1,980	4 3/16	2	2 1/2

## 2.04 FORM OF CHLORINE FOR DISINFECTION

The most common forms of chlorine used in the disinfecting solutions are liquid chlorine (gas at atmospheric pressure), calcium hypochlorite granules, sodium hypochlorite solutions.

### A. Liquid Chlorine

1. Use: Liquid chlorine shall be used only when suitable equipment is available and only under the direct supervision of a person familiar with the physiological, chemical, and physical properties of this element and who is properly trained and equipped to handle any emergency that may arise. Introduction of chlorine-gas directly from the supply cylinder is unsafe and shall not be permitted.

NOTE: The preferred equipment consists of a solution fed chlorinator in combination with a booster pump for injecting the chlorine-gas water mixture into the main to be disinfected. Direct feed chlorinators are not recommended because their use is limited



to situations where the water pressure is lower than the chlorine cylinder pressure.

## B. Hypochlorites

1. Calcium Hypochlorite: Calcium hypochlorite contains seventy (70%) percent available chlorine by weight. It is either granular or tabular in form. The tablets, 6-8 to the ounce, are designed to dissolve slowly in water. Calcium hypochlorite is packaged in containers of various types and sizes ranging from small plastic bottles to one hundred (100) pound drums.

A chlorine-water solution is prepared by dissolving the granules in water in the proportion requisite for the desired concentration.

2. Sodium Hypochlorite: Sodium hypochlorite is supplied in strengths from five and one-quarter (5.25%) to sixteen (16%) percent available chlorine. It is packaged in liquid form in glass, rubber, or plastic containers ranging in size from one (1) quart bottles to five (5) gallon carboys. It may also be purchased in bulk for delivery by tank truck.

The chlorine-water solution is prepared by adding hypochlorite to water. Product deterioration must be reckoned with in computing the quantity of sodium hypochlorite required for the desired concentration.

3. Application: The hypochlorite solutions shall be applied to the water main with a gasoline or electrically powered chemical feed pump designed for feeding chlorine solutions. For small applications, the solutions may be fed with a hand pump, for example, a hydraulic test pump. Feed lines shall be of such material and strength as to withstand safely the maximum pressures that may be created by the pumps. All connections shall be checked for tightness before the hypochlorite solution is applied to the main.

## 2.05 METHODS OF CHLORINE APPLICATION

- A Continuous Feed Method: This method is suitable for general application.

1. Water from the existing distribution system or other approved sources of supply shall be made to flow at a constant, measured rate into the newly-laid pipe line. The water shall receive a dose of chlorine, also fed at a constant, measured rate. The two rates shall be proportioned so that the chlorine concentration in the water in the pipe is maintained at a minimum of 50 mg/L available chlorine.

To assure that this concentration is maintained, the chlorine residual should be measured at regular intervals in accordance with the procedures described in the current edition of Standard Methods and AWWA M12—Simplified Procedures for Water Examination.

NOTE: In the absence of a meter, the rate may be determined either by placing a pitot gauge at the discharge or by measuring the time to fill a container of known volume.

TABLE K-3 gives the amount of chlorine residual required for each one hundred (100) feet of pipe of various diameters. Solutions of one (1%) percent chlorine may be prepared with sodium hypochlorite or calcium hypochlorite. The latter solution requires approximately one pound (1 lb.) of calcium hypochlorite in eight and five tenths (8.5) gallons of water.

**Table K-3**  
**Chlorine Required To Produce 50 mg/L Concentration**  
**In 100 Ft. Of Pipe (By Diameter)**

Pipe Size (in)	100 Percent Chlorine (lb)	1 Percent Chlorine Solutions (gal)
4	0.027	0.33
6	0.061	0.73
8	0.108	1.30
10	0.170	2.04
12	0.240	2.88

2. During the application of the chlorine, valves shall be manipulated to prevent the treatment dosage from flowing back into the line supplying the water. Chlorine application shall not cease until the entire main is filled with the chlorine solution. The chlorinated water shall be retained in the main for at least twenty-four (24) hours during which time all valves and hydrants in the section treated shall be operated in order to disinfect the appurtenances. At the end of this twenty-four (24) hour period, the treated water shall contain no less than 25 mg/L chlorine throughout the length of the main.

B. Slug Method: This method is suitable for use with mains of large diameter for which, because of the volumes of water involved, the continuous feed method is not practical.

1. Water from the existing distribution system or other approved source of supply shall be made to flow at a constant, measured rate (see section 2.5.1.1) into the newly laid pipe line. The water shall receive a dose of chlorine also fed at a constant, measured rate. The two rates shall be proportioned so that the concentration in the water entering the pipe line is maintained at no less than 300 mg/L. The chlorine shall be applied continuously and for a sufficient period to develop a solid column or "slug" of chlorinated water that will, as it passes along the line, expose all interior surfaces to a concentration of at least 300 mg/L for at least three (3) hours. The application shall be checked at a tap near the upstream end of the line by chlorine residual measurements.
2. As the chlorinated water flows past tees and crosses, related valves and hydrants shall be operated as to disinfect appurtenances.

## 2.06 FINAL FLUSHING

After the applicable retention period, the heavily chlorinated water shall be flushed from the main until the chlorine concentration in the water leaving the main is no higher than that generally prevailing in the system, or less than 1 mg/L. Chlorine residual determination shall be made to ascertain that the heavily chlorinated water has been removed from the pipe line.

## 2.07 BACTERIOLOGIC TESTS

1. After final flushing, and before the water main is placed in service, a sample or samples shall be collected from the end of the line and tested for bacteriologic quality and shall show the absence of coliform organisms. If the number and frequency of samples is not prescribed by the public health authority having jurisdiction, at least one (1) sample shall be collected from chlorinated supplies where a chlorine residual is maintained throughout the new main. From unchlorinated supplies at least two (2) samples shall be collected at least twenty-four (24) hours apart.
2. Samples for bacteriologic analysis shall be collected in sterile bottles treated with sodium thiosulphate. No hose or fire hydrant shall be used in collection of samples. A suggested sampling tap consists of a standard corporation cock installed in the main with a copper tube gooseneck assembly. After samples have been collected, the gooseneck assembly may be removed, and retained for future use.

## 2.08 REPETITION OF PROCEDURE

If the initial disinfection fails to produce satisfactory samples, disinfection shall be repeated until satisfactory samples have been obtained. The tablet method

15103-8

cannot be used in these subsequent disinfections. When the sample tests indicate that disinfection has been effective, the main may be placed in service.

## 2.09 PROCEDURE AFTER CUTTING INTO OR REPAIRING EXISTING MAINS

The procedures outlined in this Section apply primarily when mains are wholly or partially dewatered. Leaks or breaks that are repaired with clamping devices while the mains remain full of water under pressure present little danger of contamination and require no disinfection.

- A. Trench "Treatment": When an old line is opened, either by accident or by design, the excavation will likely be wet and may be badly contaminated from nearby sewers. Liberal quantities of hypochlorite applied to open trench areas will lessen the danger from such pollution. Tablets have the advantage in such a situation because they dissolve slowly and continue to release hypochlorite as water is pumped from the excavation.
- B. Main Disinfection: The following procedure is considered as a minimum that may be used.
  1. Swabbing With Hypochlorite Solution: The interior of all pipe and fittings used in making the repair (particularly couplings and tapping sleeves) shall be swabbed with a five (5%) percent hypochlorite solution before they are installed.
  2. Flushing: Thorough flushing is the most practical means of removing contamination introduced during repairs. If valving and hydrant locations permit, flushing from both directions is recommended. Flushing shall be started as soon as the repairs are completed and continued until discolored water is eliminated.
  3. Slug Method: Where practicable, in addition to the procedures of section 2.9.2.1, a section of main in which the break is located shall be isolated, all service connections shut off, and the section flushed and chlorinated as described in section 2.5.2, except that the dose may be increased to as much as 500 mg/L, and the contact time reduced to as little as one-half (1/2) hour. After chlorination, flushing shall be resumed and continued until discolored water is eliminated.
- C. Sampling: Bacteriologic samples shall be taken after repairs to provide a record by which the effectiveness of the procedures used can be determined. If the direction of flow is unknown, samples shall be taken on each side of the main break.

### **3.0 PAYMENT**

No separate payment shall be made for testing and sterilization of water lines. Items described in this Section shall be incidental to the cost of installing the water line.

**END OF SECTION 15103**

15103-10

## SECTION 15104

### METERS AND SERVICES

#### 1.0 GENERAL

The CONTRACTOR shall furnish all labor, tools, equipment, and materials necessary for installing meter services as shown on the plans and as directed.

#### 2.0 MATERIALS

##### 2.1 METERS

The meters shall be AMR Hersey "Hot Rod" Series IIS magnetic drive positive displacement disc meters. This meter is a proprietary item for synchronization with the existing water system.

##### 2.2 CORPORATION STOPS, SETTERS AND SADDLES

The corporation stops, setters and saddles shall be manufactured by The Ford Meter Box Company, Mueller Water Products or approved equal.

##### 2.3 METER SETTINGS

The existing Meter settings (preferred) for 5/8" x 3/4" meters consist of the following: 18" x 24" white corrugated box, Vestal WM-18 18" cast iron flat lid, Ford VB HH142-7W resetter, Ford C38-2-8.5 meter coupling; Ford C14-33-G 3/4" FPT x coupling; 1/2" sch. 40 cap and 1/2" x 2' sch. 40 brace pipe. Alternate manufacturers include Mueller Water Products and J.R. Hoe and Sons.

##### 2.4 INDIVIDUAL PRESSURE REGULATING VALVE

Individual pressure regulating valves will not be required on this project.

##### 2.5 SERVICE LINES

Unless indicated otherwise on the plans, all Service Lines shall be 3/4" polyethylene plastic tubing using a corporation stop in accordance with the Standard Details. Service pipe shall meet all AWWA Specifications with a minimum pressure rating of 200 psi. Polyethylene service tubing shall be ultra high density type equal to DRISCOPIPE Series 5100, CTS, JM Eagle "Pure-core" series or approved equal. Stainless steel stiffeners will be used with the tubing at all corp. stops, meter tie-ins, etc. Tracer wire as specified in Section 15100 shall be laid with all service tubing.

### **3.0 EXECUTION**

#### **3.1 RECONNECT METER SERVICE**

This item covers meter settings, which can remain in place, but need to be connected to a new water line. The Contractor shall supply all items to connect the meter to the new line. The Contractor shall locate and close the corporation stop at the existing line if the existing line is not abandoned.

#### **3.2 RELOCATE METER SERVICE**

Meter settings shall be made in a workmanlike manner with backfill neatly compacted in place. In yards, pastures and other grassed areas, top of meter box may be placed no higher than 1/2 inch above original ground and no lower than flush with original ground. Boxes in sidewalks or other concrete areas shall be flush with surface. In areas which have not been sodded top of box shall be two inches (2") above grade. The service line must meet the same cover requirements as the main line as described in these specifications except that the service line may be brought up to a depth of approximately twenty-four inches (24") within five feet (5') of each side of the meter installation when a twenty-four inch (24") deep meter box is used. In all other cases the service pipe will be brought up to a depth which accommodates installation at the bottom of the meter box in accordance with the Standard Details. As shown in the Details, after five feet (5') from box, service pipe must return to thirty inch (30") cover (forty-two inches (42") in traffic). If meter box area is subject to traffic a deeper box will be required to maintain forty-two (42") inches of cover over the service pipe.

**3.2.1 Existing Line Connection.** If the meter installation is a replacement for an existing meter, the Contractor shall locate and close the corporation stop at the existing line if the existing line is not abandoned.

#### **3.3 SERVICE LINES**

Service lines shall be installed from the water main to the reconnection with existing service line. Any service tubing installed on the customer's side of the meter shall be performed by a licensed plumber with appropriate permit.

**3.3.1 Service Lines Crossing a Road.** Services on the opposite side of the road shall be provided as stated above. In general, all pipe shall be jacked beneath paved or blacktopped city streets or county roads, unless solid rock prevents using this method, in which case the open trench method may be used. The open trench method generally will be used on all unpaved city streets, county roads and private driveways. In general, blacktopped and concrete private driveways shall also be jacked under. In all cases where lines are under traffic, a

minimum cover of forty-two inches (42") shall be provided. All backfill shall be compacted in layers no greater than six inches (6") deep. In cases of open trench construction, crushed stone, blacktop and concrete paving shall be replaced according to the Standard Drawings. All service lines crossing a road shall be cased with PVC casing pipe. Open trench construction will not be permitted through state or federal highways.

#### **4.0 PAYMENT**

Service Tubing shall be paid at the Unit Price Bid for each foot of service tubing installed and shall include all labor, materials, tracer wire, equipment incidentals, etc. No extra shall be paid for service tubing bored, jacked and/or encased.

The Unit Price Bid for Reconnect Existing Meter Service shall constitute full compensation for all labor, materials, equipment, etc. required in reconnecting the existing meter setting, to the new water line including locating and shutting off corporation stops for any existing meter services when necessary.

The Unit Price Bid for Relocate Existing Meter Service shall constitute full compensation for furnishing and installing the saddle, corporation stop, meter pit, etc. as shown and specified. This shall include locating and shutting off corporation stops for any existing meter services when necessary and appropriate permitting.

All new materials will be used for all items under this specification.

**END OF SECTION 15104**

15104-3





MATTHEW G. BEVIN  
GOVERNOR

CHARLES G. SNAVELY  
SECRETARY

**ENERGY AND ENVIRONMENT CABINET**  
DEPARTMENT FOR ENVIRONMENTAL PROTECTION

AARON B. KEATLEY  
COMMISSIONER

300 SOWER BOULEVARD  
FRANKFORT, KENTUCKY 40601

October 10, 2017

David Waldner  
Kentucky Transportation Cabinet (KYTC)  
200 Mero St  
Frankfort, KY 40622

Re: Letter of Permission No.: 2017-042-7-R1  
AI No.: 123262; Activity ID: APE20170001  
KYTC Item No.: 10-126.4  
USACE ID No.: LRL-2017-00525-cdb  
Cow Creek, Johnson Creek, Patton Branch, and  
Unnamed Tributaries  
Magoffin County, Kentucky

Dear Mr. Waldner:

This letter transmits to you a copy of our General Water Quality Certification for the Letter of Permission Authorizing Transportation Projects for the Kentucky Transportation Cabinet – Mountain Parkway widening in Magoffin, County, Kentucky, in accordance with plans included in the “Application for Permit to Construct Across or Along a Stream and/or Water Quality Certification” received June 6, 2017, and the revised jurisdictional map, impacts table, stream forms, and photos submitted via email on July 13, 2017 including impacts to 6,302 linear feet of ephemeral stream, 13,479 linear feet of intermittent stream, and 3,582 linear feet of perennial stream and 3.194 acres of wetland. Compensatory mitigation will be accomplished through permittee-responsible mitigation at the KYTC Stonewall Branch Mitigation Site.

An individual Water Quality Certification is not necessary for this activity provided that this project has satisfied the Transportation Letter of Permission from the U.S. Army Corps of Engineers (Letter of Permission for Transportation Projects, Corps ID No. LRL-2006-259, issued October 03, 2007 and revised October 28, 2010) and all conditions of the attached General Water Quality Certification - Letter of Permission Authorizing Transportation Projects are met.

Although an Individual WQC is not needed, other permits from the Division of Water may be required. If the project will disturb one acre or more of land, or is part of a larger common plan of development or sale that will ultimately disturb one acre or more of land, a Kentucky Pollution Discharge Elimination System (KPDES) stormwater permit shall be required from the Surface Water Permits Branch. This permit requires the development of a Stormwater Pollution Prevention Plan (SWPPP). The SWPPP must include erosion prevention and sediment control measures. Contact: Surface Water Permits Branch (SWPB) Support (502-564-3410 or [SWPBsupport@ky.gov](mailto:SWPBsupport@ky.gov))

All future correspondence on this project must reference **AI No. 123262**. If you should have any questions concerning this letter, please contact Samantha Vogeler of my staff, at (502) 782-6995 or [Samantha.Vogelerr@ky.gov](mailto:Samantha.Vogelerr@ky.gov).

Sincerely,

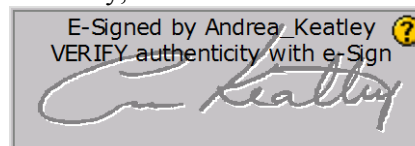

**Andrea Keatley, Branch Manager**  
Water Quality Branch  
Kentucky Division of Water

**Attachment**

- cc: John Purdy, KYTC: Frankfort (via email: JPURDY@ky.gov)  
Tyler Reynolds, KYTC: Frankfort (via email Tyler.Reynolds@ky.gov)  
Danny Peake, KYTC: Frankfort (via email: Danny.Peake@ky.gov)  
Dave Harmon, KYTC: Frankfort (via email: Dave.Harmon@ky.gov)  
Crystal Byrd, USACE: Louisville (via email: Crystal.D.Byrd@usace.army.mil)  
Lee Andrews, USFWS: Frankfort (via email: Teresa\_Hyatt@fws.gov)  
Malissa McAlister, Kentucky River Basin Coordinator (via email: mlmal2@uky.edu)  
Steve Rice, HMB Professional Engineers, Inc. (via email: srice@hmbpe.com)



**Matthew G. Bevin**  
Governor

**Charles G. Snavely**  
Secretary

**ENERGY AND ENVIRONMENTAL PROTECTION CABINET**

DEPARTMENT FOR ENVIRONMENTAL PROTECTION

DIVISION OF WATER

200 FAIR OAKS LANE

FRANKFORT, KENTUCKY 40601

[www.kentucky.gov](http://www.kentucky.gov)

**General Certification -- Letter of Permission Authorizing Transportation  
Projects (LRL-2006-259-pgj- Date: 28 Oct 2010)**

This general certification is issued February 26, 2016, by the Kentucky Division of Water, 401 Water Quality Certification Program in conformity with the requirements of Sections 301, 302, 304, 306 and 401, as amended (33 U.S.C. §1341), of the Clean Water Act, as well as Kentucky Statute KRS 224.16-050 and Kentucky Administrative Regulations Title 401, Chapter 9 and 10.

For this and all general permits, the definition of surface water is as per 401 KAR 10:001 Chapter 10, Section 1(80): Surface Waters mean those waters having well-defined banks and beds, either constantly or intermittently flowing; lakes and impounded waters; marshes and wetlands; and any subterranean waters flowing in well-defined channels and having a demonstrable hydrologic connection with the surface. Lagoons used for waste treatment and effluent ditches that are situated on property owned, leased, or under valid easement by a permitted discharger are not considered surface waters of the commonwealth.

In addition to all the restrictions and conditions of the U.S. Army Corps of Engineers, Louisville District Letter of Permission Issuance (LRL-2006-259-pgj) hereby incorporated into this general certification (included herein), the following 401 Water Quality Certification criteria applies to all transportation projects certified under a Certified Letter of Permission issued by the Kentucky Division of Water, 401 Water Quality Certification Program:

1. The activity will not qualify for this general certification if it is proposed to occur within surface waters of the Commonwealth identified by the Kentucky Division of Water as Outstanding State or National Resource Water, Cold Water Aquatic Habitat, or Exceptional Water.
2. The activity will not qualify for this general certification if it is proposed to occur within surface waters of the Commonwealth identified as perpetually-protected (e.g. deed restriction, conservation easement) stream and/or wetland mitigation sites permitted by the U.S. Army Corps of Engineers under Section 404 of the Clean Water Act.

## Certification of Transportation Letter of Permission

### Page 2

3. The Kentucky Division of Water may require an individual certification for any project if the project is likely to have adverse impacts to water quality or degrade the waters of the Commonwealth so that existing uses of the water body or downstream waters are precluded.
4. Activities qualifying for coverage under this General Water Quality Certification are subject to the following conditions:
  - The proposed relocation of an existing stream or channel will be designed and constructed to ensure the stability of the relocated stream or channel. Stream habitat enhancements, such as bioengineering methods and/or best management practices for protecting water quality will be considered, on a case-by-case basis, during the design process. Documentation must be provided if stream habitat enhancements will not be used for the proposed stream relocation.
  - Erosion and sedimentation pollution control plans and Best Management Practices must be designed, installed, and maintained in effective operating condition at all times during construction activities so that state water quality are maintained (401 KAR Chapter 10).
  - Sediment and erosion control measures, such as check-dams constructed of any material, silt fencing, hay bales, etc., shall not be placed within surface waters of the Commonwealth, either temporarily or permanently, without notifying the Kentucky Division of Water. If placement of sediment and erosion control measures in surface waters is unavoidable, design and placement of temporary erosion control measures shall not be conducted in such a manner that may result in instability of streams that are adjacent to, upstream, or downstream of the structures. All sediment and erosion control devices shall be removed and the natural grade restored within the completion timeline of the activities.
  - Measures shall be taken to prevent or control spills of fuels, lubricants, or other toxic materials used in construction from entering the watercourse.
  - Removal of riparian vegetation in the right-of-way shall be limited to that necessary.
  - To the maximum extent practicable, all in-stream work under this certification shall be performed under low-flow conditions.
  - Heavy equipment, e.g. bulldozers, backhoes, draglines, etc., if required for this project, should not be used or operated within the stream channel. In those instances in which such in-stream work is unavoidable, then it should be performed in low-flow or no-flow instances or in such a manner and duration as to minimize turbidity and disturbance to substrates and bank or riparian vegetation.

**Page 3**

- Fill shall not be of such composition that it will adversely affect the biological, chemical, or physical properties of the receiving waters and associated water quality standards. If rip-rap is utilized, it should be of such weight and size that bank stress or slump conditions will not be created because of its placement.
- If there are water supply intakes located downstream that may be affected by increased turbidity and suspended solids, the permittee shall notify the public supply system when such work will be done.
- Should evidence of stream and/or wetland pollution impairment and/or violations of water quality standards occur as a result of this activity (either from a spill or other forms of water pollution), the Environmental Response Team (ERT) shall be notified immediately by calling 1-800-928-2380 or 502-564-2380.

This general certification does not have an expiration date, however if the need for changes develop or if the U.S. Army Corps of Engineers, Louisville District makes modifications to the Letter of Permission (LRL-2006-259-pgj- Date: 28 Oct 2010) then a certification modification may be issued. Non-compliance with the conditions of this general certification or failure to maintain Kentucky state water quality standards may result in civil penalties.

## **GENERAL CONDITIONS FOR WATER QUALITY CERTIFICATION**

1. The Kentucky Division of Water may require submission of a formal application for an Individual Certification for any project if the project has been determined to likely have a significant adverse effect upon water quality or degrade the waters of the Commonwealth so that existing uses of the water body or downstream waters are precluded.
2. Nationwide permits issued by the U.S. Army Corps of Engineers for projects in Outstanding State Resource Waters, Cold Water Aquatic Habitats, and Exceptional Waters as defined by 401 KAR 10:026 shall require individual water quality certifications.
3. Projects requiring in-stream stormwater detention/retention basins shall require individual water quality certifications.
4. Erosion and sedimentation pollution control plans and Best Management Practices must be designed, installed, and maintained in effective operating condition at all times during construction activities so that violations of state water quality standards do not occur.
5. Sediment and erosion control measures (e.g., check-dams, silt fencing, or hay bales) shall not be placed within surface waters of the Commonwealth, either temporarily or permanently, without prior approval by the Kentucky Division of Water's Water Quality Certification Section. If placement of sediment and erosion control measures in surface waters is unavoidable, placement shall not be conducted in such a manner that may cause instability of streams that are adjacent to, upstream, or downstream of the structures. All sediment and erosion control measures shall be removed and the natural grade restored prior to withdrawal from the site.
6. Measures shall be taken to prevent or control spills of fuels, lubricants, or other toxic materials used in construction from entering the watercourse.
7. To the maximum extent practicable, all in-stream work under this certification shall be performed during low flow.
8. Heavy equipment (e.g. bulldozers, backhoes, draglines, etc.), if required for this project, should not be used or operated within the stream channel. In those instances where such in-stream work is unavoidable, then it shall be performed in such a manner and duration as to minimize re-suspension of sediments and disturbance to the channel, banks, or riparian vegetation.
9. If there are water supply intakes located downstream that may be affected by increased turbidity, the permittee shall notify the operator when work will be performed.
10. Removal of existing riparian vegetation should be restricted to the minimum necessary for project construction.

11. Should stream pollution, wetland impairment, and/or violations of water quality standards occur as a result of this activity (either from a spill or other forms of water pollution), the Kentucky Division of Water shall be notified immediately by calling 800/564-2380.

KyTC BMP Plan for Project Construction ID (CID) 181019



**Kentucky Transportation Cabinet**

**Highway District 10**

**And**

\_\_\_\_\_ **(2), Construction**

**Kentucky Pollutant Discharge Elimination System**

**Permit KYR10**

**Best Management Practices (BMP) plan**

**Groundwater protection plan**

**For Highway Construction Activities**

**For**

**Widening of the Mountain Parkway**

**Project 10-126.40**



## KyTC BMP Plan for Project Construction ID (CID) 181019

### Project information

Note – (1) = Design (2) = Construction (3) = Contractor

1. Owner – **Kentucky Transportation Cabinet, District 10 (1)**
2. Resident Engineer: (2)
3. Contractor name: (2)  
Address: (2)  
  
Phone number: (2)  
Contact: (2)  
Contractors agent responsible for compliance with the KPDES permit requirements (3):
4. Project Control Number (2)
5. Route (Address) **Mountain Parkway (KY 9009) (1)**
6. Latitude/Longitude (project mid-point) **37°45'01"N, 83°10'19"W (1)**
7. County (project mid-point) **MAGOFFIN COUNTY (1)**
8. Project start date (date work will begin): (2)
9. Projected completion date: (2)

### A. Site description:

1. Nature of Construction Activity (from letting project description) (1)  
**MAJOR WIDENING/RECONSTRUCTION**
2. Order of major soil disturbing activities (2) and (3)
3. Projected volume of material to be moved (1)  
**5,591,850 CU. YDS.**
4. Estimate of total project area (acres) (1)  
**199 ACRES**

## KyTC BMP Plan for Project Construction ID (CID) 181019

5. Estimate of area to be disturbed (acres) (1)  
**199 ACRES**
6. Post construction runoff coefficient will be included in the project drainage folder. Persons needing information pertaining to the runoff coefficient will contact the resident engineer to request this information. (1)
7. Data describing existing soil condition (1) & (2)
8. Data describing existing discharge water quality (if any) (1) & (2)
9. Receiving water name (1)  
**JOHNSON CREEK, COW CREEK, AND PATTON BRANCH**
10. TMDLs and Pollutants of Concern in Receiving Waters: (1 DEA)
11. Site map – Project layout sheet plus the erosion control sheets in the project plans that depict Disturbed Drainage Areas (DDAs) and related information. These sheets depict the existing project conditions with areas delineated by DDA (drainage area bounded by watershed breaks and right of way limits), the storm water discharge locations (either as a point discharge or as overland flow) and the areas that drain to each discharge point. These plans define the limits of areas to be disturbed and the location of control measures. Controls will be either site specific as designated by the designer or will be annotated by the contractor and resident engineer before disturbance commences. The project layout sheet shows the surface waters and wetlands.
12. Potential sources of pollutants:  
  
The primary source of pollutants is solids that are mobilized during storm events. Other sources of pollutants include oil/fuel/grease from servicing and operating construction equipment, concrete washout water, sanitary wastes and trash/debris. (3)

## **B. Sediment and Erosion Control Measures:**

1. Plans for highway construction projects will include erosion control sheets that depict Disturbed Drainage Areas (DDAs) and related information. These plan sheets will show the existing project conditions with areas delineated by DDA within the right of way limits, the discharge points and the areas that drain to each discharge point. Project managers and

## KyTC BMP Plan for Project Construction ID (CID) 181019

designers will analyze the DDAs and identify Best Management Practices (BMPs) that are site specific. The balance of the BMPs for the project will be listed in the bid documents for selection and use by the contractor on the project with approval by the resident engineer.

Projects that do not have DDAs annotated on the erosion control sheets will employ the same concepts for development and managing BMP plans.

2. Following award of the contract, the contractor and resident engineer will annotate the erosion control sheets showing location and type of BMPs for each of the DDAs that will be disturbed at the outset of the project. This annotation will be accompanied by an order of work that reflects the order or sequence of major soil moving activities. The remaining DDAs are to be designated as “Do Not Disturb” until the contractor and resident engineer prepare the plan for BMPs to be employed. The initial BMP’s shall be for the first phase (generally Clearing and Grubbing) and shall be modified as needed as the project changes phases. The BMP Plan will be modified to reflect disturbance in additional DDA’s as the work progresses. All DDA’s will have adequate BMP’s in place before being disturbed.
  
3. As DDAs are prepared for construction, the following will be addressed for the project as a whole or for each DDA as appropriate:
  - Construction Access – This is the first land-disturbing activity. As soon as construction begins, bare areas will be stabilized with gravel and temporary mulch and/or vegetation.
  - At the beginning of the project, all DDAs for the project will be inspected for areas that are a source of storm water pollutants. Areas that are a source of pollutants will receive appropriate cover or BMPs to arrest the introduction of pollutants into storm water. Areas that have not been opened by the contractor will be inspected periodically (once per month) to determine if there is a need to employ BMPs to keep pollutants from entering storm water.
  - Clearing and Grubbing – The following BMP’s will be considered and used where appropriate.
    - Leaving areas undisturbed when possible.
    - Silt basins to provide silt volume for large areas.
    - Silt Traps Type A for small areas.
    - Silt Traps Type C in front of existing and drop inlets which are to be saved
    - Diversion ditches to catch sheet runoff and carry it to basins or traps or to divert it around areas to be disturbed.

## KyTC BMP Plan for Project Construction ID (CID) 181019

- Brush and/or other barriers to slow and/or divert runoff.
- Silt fences to catch sheet runoff on short slopes. For longer slopes, multiple rows of silt fence may be considered.
- Temporary Mulch for areas which are not feasible for the fore mentioned types of protections.
- Non-standard or innovative methods.
- Cut & Fill and placement of drainage structures - The BMP Plan will be modified to show additional BMP's such as:
  - Silt Traps Type B in ditches and/or drainways as they are completed
  - Silt Traps Type C in front of pipes after they are placed
  - Channel Lining
  - Erosion Control Blanket
  - Temporary mulch and/or seeding for areas where construction activities will be ceased for 21 days or more.
  - Non-standard or innovative methods
- Profile and X-Section in place – The BMP Plan will be modified to show elimination of BMP's which had to be removed and the addition of new BMP's as the roadway was shaped. Probably changes include:
  - Silt Trap Type A, Brush and/or other barriers, Temporary Mulch, and any other BMP which had to be removed for final grading to take place.
  - Additional Silt Traps Type B and Type C to be placed as final drainage patterns are put in place.
  - Additional Channel Lining and/or Erosion Control Blanket.
  - Temporary Mulch for areas where Permanent Seeding and Protection cannot be done within 21 days.
  - Special BMP's such as Karst Policy
- Finish Work (Paving, Seeding, Protect, etc.) – A final BMP Plan will result from modifications during this phase of construction. Probably changes include:
  - Removal of Silt Traps Type B from ditches and drainways if they are protected with other BMP's which are sufficient to control erosion, i.e. Erosion Control Blanket or Permanent Seeding and Protection on moderate grades.
  - Permanent Seeding and Protection
  - Placing Sod
  - Planting trees and/or shrubs where they are included in the project
- BMP's including Storm Water Management Devices such as velocity dissipation devices and Karst policy BMP's to be installed during construction to control the pollutants in storm water discharges that will occur after construction has been completed are: (1)

## KyTC BMP Plan for Project Construction ID (CID) 181019

### C. Other Control Measures

1. No solid materials, including building materials, shall be discharged to waters of the commonwealth, except as authorized by a Section 404 permit.
2. Waste Materials

All waste materials that may leach pollutants (paint and paint containers, caulk tubes, oil/grease containers, liquids of any kind, soluble materials, etc.) will be collected and stored in appropriate covered waste containers. Waste containers shall be removed from the project site on a sufficiently frequent basis as to not allow wastes to become a source of pollution. All personnel will be instructed regarding the correct procedure for waste disposal. Wastes will be disposed in accordance with appropriate regulations. Notices stating these practices will be posted in the office.

3. Hazardous Waste

All hazardous waste materials will be managed and disposed of in the manner specified by local or state regulation. The contractor shall notify the Resident Engineer if there any hazardous wastes being generated at the project site and how these wastes are being managed. Site personnel will be instructed with regard to proper storage and handling of hazardous wastes when required. The Transportation Cabinet will file for generator, registration when appropriate, with the Division of Waste Management and advise the contractor regarding waste management requirements.

4. Spill Prevention

The following material management practices will be used to reduce the risk of spills or other exposure of materials and substances to the weather and/or runoff.

➤ **Good Housekeeping:**

The following good housekeeping practices will be followed onsite during the construction project.

- An effort will be made to store only enough product required to do the job
- All materials stored onsite will be stored in a neat, orderly manner in their appropriate containers and, if possible, under a roof or other enclosure
- Products will be kept in their original containers with the original manufacturer's label

## KyTC BMP Plan for Project Construction ID (CID) 181019

- Substances will not be mixed with one another unless recommended by the manufacturer
- Whenever possible, all of the product will be used up before disposing of the container
- Manufacturers' recommendations for proper use and disposal will be followed
- The site contractor will inspect daily to ensure proper use and disposal of materials onsite

### ➤ **Hazardous Products:**

These practices will be used to reduce the risks associated with any and all hazardous materials.

- Products will be kept in original containers unless they are not resealable.
- Original labels and material safety data sheets (MSDS) will be reviewed and retained
- Contractor will follow procedures recommended by the manufacturer when handling hazardous materials
- If surplus product must be disposed of, manufacturers' or state/local recommended methods for proper disposal will be followed

### **The following product-specific practices will be followed onsite:**

#### ➤ **Petroleum Products:**

Vehicles and equipment that are fueled and maintained on site will be monitored for leaks, and receive regular preventative maintenance to reduce the chance of leakage. Petroleum products onsite will be stored in tightly sealed containers, which are clearly labeled and will be protected from exposure to weather.

The contractor shall prepare an Oil Pollution Spill Prevention Control and Countermeasure plan when the project that involves the storage of petroleum products in 55 gallon or larger containers with a total combined storage capacity of 1,320 gallons. This is a requirement of 40 CFR 112.

This project (will / will not) (3) have over 1,320 gallons of petroleum products with a total capacity, sum of all containers 55-gallon capacity and larger.

#### ➤ **Fertilizers:**

Fertilizers will be applied at rates prescribed by the contract, standard specifications or as directed by the resident engineer. Once applied, fertilizer will be covered with mulch or blankets or worked into the soil to limit exposure to

## KyTC BMP Plan for Project Construction ID (CID) 181019

storm water. Storage will be in a covered shed. The contents of any partially used bags of fertilizer will be transferred to a sealable plastic bin to avoid spills.

### ➤ **Paints:**

All containers will be tightly sealed and stored indoors or under roof when not being used. Excess paint or paint wash water will not be discharged to the drainage or storm sewer system but will be properly disposed of according to manufacturers' instructions or state and local regulations.

### ➤ **Concrete Truck Washout:**

Concrete truck mixers and chutes will not be washed on pavement, near storm drain inlets, or within 75 feet of any ditch, stream, wetland, lake, or sinkhole. Where possible, excess concrete and wash water will be discharged to areas prepared for pouring new concrete, flat areas to be paved that are away from ditches or drainage system features, or other locations that will not drain off site. Where this approach is not possible, a shallow earthen wash basin will be excavated away from ditches to receive the wash water

### ➤ **Spill Control Practices**

In addition to the good housekeeping and material management practices discussed in the previous sections of this plan, the following practices will be followed for spill prevention and cleanup:

- Manufacturers' recommended methods for spill cleanup will be clearly posted. All personnel will be made aware of procedures and the location of the information and cleanup supplies.
- Materials and equipment necessary for spill cleanup will be kept in the material storage area. Equipment and materials will include as appropriate, brooms, dust pans, mops, rags, gloves, oil absorbents, sand, sawdust, and plastic and metal trash containers.
- All spills will be cleaned up immediately after discovery.
- The spill area will be kept well ventilated and personnel will wear appropriate protective clothing to prevent injury from contact with a hazardous substance.
- Spills of toxic or hazardous material will be reported to the appropriate state/local agency as required by KRS 224 and applicable federal law.
- The spill prevention plan will be adjusted as needed to prevent spills from reoccurring and improve spill response and cleanup.
- Spills of products will be cleaned up promptly. Wastes from spill clean-up will be disposed in accordance with appropriate regulations.

## KyTC BMP Plan for Project Construction ID (CID) 181019

### D. Other State and Local Plans

This BMP plan shall include any requirements specified in sediment and erosion control plans, storm water management plans or permits that have been approved by other state or local officials. Upon submittal of the NOI, other requirements for surface water protection are incorporated by reference into and are enforceable under this permit (even if they are not specifically included in this BMP plan). This provision does not apply to master or comprehensive plans, non-enforceable guidelines or technical guidance documents that are not identified in a specific plan or permit issued for the construction site by state or local officials. (1)

### E. Maintenance

1. The BMP plan shall include a clear description of the maintenance procedures necessary to keep the control measures in good and effective operating condition.
  - Maintenance of BMPs during construction shall be a result of weekly and post rain event inspections with action being taken by the contractor to correct deficiencies.
  - Post Construction maintenance will be a function of normal highway maintenance operations. Following final project acceptance by the cabinet, district highway crews will be responsible for identification and correction of deficiencies regarding ground cover and cleaning of storm water BMPs. The project manager shall identify any BMPs that will be for the purpose of post construction storm water management with specific guidance for any non-routine maintenance. (1)

### F. Inspections

Inspection and maintenance practices that will be used to maintain erosion and sediment controls:

- All erosion prevention and sediment control measures will be inspected at least once each week and following any rain of one-half inch or more.
- Inspections will be conducted by individuals that have received KyTC Grade Level II training or other qualification as prescribed by the cabinet that includes instruction concerning sediment and erosion control.
- Inspection reports will be written, signed, dated, and kept on file.



## KyTC BMP Plan for Project Construction ID (CID) 181019

- Areas at final grade will be seeded and mulched within 14 days.
- Areas that are not at final grade where construction has ceased for a period of 21 days or longer and soil stock piles shall receive temporary mulch no later than 14 days from the last construction activity in that area.
- All measures will be maintained in good working order; if a repair is necessary, it will be initiated within 24 hours of being reported.
- Built-up sediment will be removed from behind the silt fence before it has reached halfway up the height of the fence.
- Silt fences will be inspected for bypassing, overtopping, undercutting, depth of sediment, tears, and to ensure attachment to secure posts.
- Sediment basins will be inspected for depth of sediment, and built-up sediment will be removed when it reaches 70 percent of the design capacity and at the end of the job.
- Diversion dikes and berms will be inspected and any breaches promptly repaired. Areas that are eroding or scouring will be repaired and re-seeded / mulched as needed.
- Temporary and permanent seeding and mulching will be inspected for bare spots, washouts, and healthy growth. Bare or eroded areas will be repaired as needed.
- All material storage and equipment servicing areas that involve the management of bulk liquids, fuels, and bulk solids will be inspected weekly for conditions that represent a release or possible release of pollutants to the environment.

## **G. Non – Storm Water discharges**

It is expected that non-storm water discharges may occur from the site during the construction period. Examples of non-storm water discharges include:

- Water from water line flushings.
- Water from cleaning concrete trucks and equipment.
- Pavement wash waters (where no spills or leaks of toxic or hazardous materials have occurred).
- Uncontaminated groundwater and rain water (from dewatering during excavation).

All non-storm water discharges will be directed to the sediment basin or to a filter fence enclosure in a flat vegetated infiltration area or be filtered via another approved commercial product.

KyTC BMP Plan for Project Construction ID (CID) 181019

## H. Groundwater Protection Plan (3)

This plan serves as the groundwater protection plan as required by 401 KAR 5:037.

➤ Contractors statement: (3)

The following activities, as enumerated by 401 KAR 5:037 Section 2 that require the preparation and implementation of a groundwater protection plan, will or may be may be conducted as part of this construction project:

\_\_\_\_\_ 2. (e) land treatment or land disposal of a pollutant;

\_\_\_\_\_ 2. (f) Storing, ..., or related handling of hazardous waste, solid waste or special waste, ..., in tanks, drums, or other containers, or in piles, (This does not include wastes managed in a container placed for collection and removal of municipal solid waste for disposal off site);

\_\_\_\_\_ 2. (g) .... Handling of materials in bulk quantities (equal or greater than 55 gallons or 100 pounds net dry weight transported held in an individual container) that, if released to the environment, would be a pollutant;

\_\_\_\_\_ 2. (j) Storing or related handling of road oils, dust suppressants, ....., at a central location;

\_\_\_\_\_ 2. (k) Application or related handling of road oils, dust suppressants or deicing materials, (does not include use of chloride-based deicing materials applied to roads or parking lots);

\_\_\_\_\_ 2. (m) Installation, construction, operation, or abandonment of wells, bore holes, or core holes, (this does not include bore holes for the purpose of explosive demolition);

Or, check the following only if there are no qualifying activities

\_\_\_\_\_ There are no activities for this project as listed in 401 KAR 5:037 Section 2 that require the preparation and implementation of a groundwater protection plan.

The contractor is responsible for the preparation of a plan that addresses the

401 KAR 5:037 Section 3. (3) Elements of site specific groundwater protection plan:

(a) General information about this project is covered in the Project information;

## KyTC BMP Plan for Project Construction ID (CID) 181019

- (b) Activities that require a groundwater protection plan have been identified above;
- (c) Practices that will protect groundwater from pollution are addressed in section C. Other control measures.
- (d) Implementation schedule – all practices required to prevent pollution of groundwater are to be in place prior to conducting the activity;
- (e) Training is required as a part of the ground water protection plan. All employees of the contractor, sub-contractor and resident engineer personnel will be trained to understand the nature and requirements of this plan as they pertain to their job function(s). Training will be accomplished within one week of employment and annually thereafter. A record of training will be maintained by the contractor with a copy provide to the resident engineer.
- (f) Areas of the project and groundwater plan activities will be inspected as part of the weekly sediment and erosion control inspections
- (g) Certification (see signature page.)





## ***SPECIAL NOTE***

### **Filing of eNOI for KPDES Construction Stormwater Permit**

**County: Magoffin**

**Route: KY 9009  
Mountain Parkway**

**Item No.: 10-126.40**

**CID No.: 181019**

**KDOW ID: 123262**

**Project Description:** WIDEN THE MOUNTAIN PARKWAY TO FOUR LANES FROM 0.3 MI W OF KY 3047 TO 0.7 MI W OF MIDDLE FORK LICKING RIVER BRIDGE

**A Notice of Intent for obtaining coverage under the Kentucky Pollutant Discharge Elimination System (KPDES) General Permit for Stormwater Discharges Associated with Construction Activities (KYR10) has been drafted, copy of which is attached. Upon award, the Contractor will be identified in Section III of the form as the “Building Contractor” and it will be submitted for approval to the Kentucky Division of Water. The Contractor shall be responsible for advancing the work in a manner that is compliant with all applicable and appropriate KYTC specifications for sediment and erosion control as well as meeting the requirements of the KYR10 permit and the KDOW.**

**If there are any questions regarding this note, please contact the Division of Environmental Analysis, TCOB, 200 Mero Street, Frankfort, KY 40622, Phone: (502) 564-7250.**

**KPDES FORM NOI-SW**

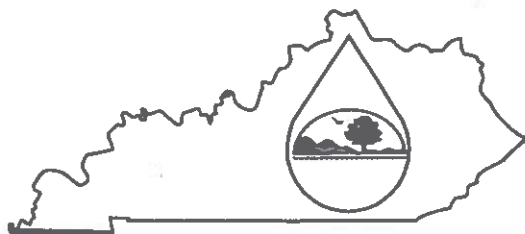

**Kentucky Pollutant Discharge Elimination System  
(KPDES)  
Notice of Intent (NOI)  
for Storm Water Discharges  
Associated with Industrial Activity Under the  
KPDES General Permit**

Submission of this Notice of Intent constitutes notice that the party identified in Section I of this form intends to be authorized by a KPDES permit issued for storm water discharges associated with industrial activity. Becoming a permittee obligates such discharger to comply with the terms and conditions of the permit.

**ALL NECESSARY INFORMATION MUST BE PROVIDED ON THIS FORM (See Instructions on back)**

**I. Facility Operator Information**

<b>Name:</b>	KyTC District 10, Jackson Office	<b>Phone:</b>	(606) 666-8841
<b>Address:</b>	P.O. Box 621, 473 Highway 15 South	<b>Status of Owner/Operator:</b>	State Government
<b>City, State, Zip Code:</b>	Jackson, KY 41339		

**II. Facility/Site Location Information**

<b>Name:</b>	KyTC CID 181019		
<b>Address:</b>	KY 9009 Bert T Combs Mountain Parkway		
<b>City, State, Zip Code:</b>	USPS, 330 E. Maple St., Salyersville, KY 41465		
<b>County:</b>	Magoffin County		
<b>Site Latitude: (degrees/minutes/seconds)</b>	37° 45' 01" North	<b>Site Longitude: (degrees/minutes/seconds)</b>	83° 10' 19" West

**III. Site Activity Information**

<b>MS4 Operator Name:</b>							
<b>Receiving Water Body:</b>	Johnson Creek Cow Creek Patton Branch						
<b>Are there existing quantitative data?</b>	Yes <input type="checkbox"/> If Yes, submit with this form. No <input checked="" type="checkbox"/>						
<b>SIC or Designated Activity Code Primary</b>	1611	2nd	1622	3rd		4th	

**If this facility is a member of a Group Application, enter Group Application Number:**

**If you have other existing KPDES Permits, enter Permit Numbers:**

**IV. Additional Information Required FOR CONSTRUCTION ACTIVITIES ONLY**

<b>Project Start Date:</b>	8/1/2018	<b>Completion Date:</b>	10/1/2021
<b>Estimated Area to be disturbed (in acres):</b>	199		
<b>Is the Storm Water Pollution Prevention Plan in Compliance with State and/or Local Sediment and Erosion Plans?</b>	Yes <input checked="" type="checkbox"/> No <input type="checkbox"/>		

**V. Certification:** I certify under penalty of law that this document and all attachments were prepared under my direction or supervision in accordance with a system designed to assure that qualified personnel properly gather and evaluate the information submitted. Based on my inquiry of the person or persons who manage the system, or those persons directly responsible for gathering the information, the information submitted is, to the best of my knowledge and belief, true, accurate, and complete. I am aware that there are significant penalties for submitting false information, including the possibility of fine and imprisonment for knowing violations.

<b>Printed or Typed Name:</b>	Marshall Carrier <i>[Signature]</i>
-------------------------------	-------------------------------------

Signature: 	Date: 5/17/18	
---	---------------	--



**Kentucky Pollutant Discharge Elimination System (KPDES)  
Instructions  
Notice of Intent (NOI) for Storm Water Discharges Associated with Industrial Activity  
To Be Covered Under The KPDES General Permit**

**WHO MUST FILE A NOTICE OF INTENT (NOI) FORM**

Federal law at 40 CFR Part 122 prohibits point source discharges of stormwater associated with industrial activity to a water body of the Commonwealth of Kentucky without a Kentucky Pollutant Discharge Elimination System (KPDES) permit. The operator of an industrial activity that has such a storm water discharge must submit a NOI to obtain coverage under the KPDES Storm Water General Permit. If you have questions about whether you need a permit under the KPDES Storm Water program, or if you need information as to whether a particular program is administered by the state agency, call the **Storm Water Contact, Industrial Section, Kentucky Division of Water at (502) 564-3410.**

**WHERE TO FILE NOI FORM**

NOIs must be sent to the following address:

**Section Supervisor  
Inventory & Data Management Section  
KPDES Branch, Division of Water  
Frankfort Office Park  
14 Reilly Road  
Frankfort, KY 40601**

**COMPLETING THE FORM**

Type or print legibly in the appropriate areas only. If you have any questions regarding the completion of this form call the **Storm Water Contact, Industrial Section, at (502) 564-3410.**

**SECTION I - FACILITY OPERATOR INFORMATION**

Give the legal name of the person, firm, public organization, or any other entity that operates the facility or site described in this application. The name of the operator may or may not be the same as the name of the facility. The responsible party is the legal entity that controls the facility's operation, rather than the plant or site manager. Do not use a colloquial name. Enter the complete address and telephone number of the operator.

Enter the appropriate letter to indicate the legal status of the operator of the facility.

F = Federal                      M = Public (other than federal or state)  
S = State                        P = Private

**SECTION II - FACILITY/SITE LOCATION INFORMATION**

Enter the facility's or site's official or legal name and complete street address, including city, state, and ZIP code.

**SECTION III - SITE ACTIVITY INFORMATION**

If the storm water discharges to a municipal separate storm sewer system (MS4), enter the name of the operator of the MS4 (e.g., municipality name, county name) and the receiving water of the discharge from the MS4. (A MS4 is defined as a conveyance or system of conveyances (including roads with drainage systems, municipal streets, catch basins, curbs, gutters, ditches, man-made channels, or storm drains) that is owned or operated by a state, city, town, borough, county, parish, district, association, or other public body which is designed or used for collecting or conveying storm water.)

If the facility discharges storm water directly to receiving water(s), enter the name of the receiving water.

Indicate whether or not the owner or operator of the facility has existing quantitative data that represent the characteristics and concentration of pollutants in storm water discharges. If data is available submit with this form.

List, in descending order of significance, up to four 4-digit standard industrial classification (SIC) codes that best describe the principal products or services provided at the facility or site identified in Section II of this application.

If the facility listed in Section II has participated in Part 1 of an approved storm water group application and a group number has been assigned, enter the group application number in the space provided.

If there are other KPDES permits presently issued for the facility or site listed in Section II, list the permit numbers.

**SECTION IV - ADDITIONAL INFORMATION REQUIRED FOR CONSTRUCTION ACTIVITIES ONLY**

Construction activities must complete Section IV in addition of Sections I through III. Only construction activities need to complete Section IV.

Enter the project start date and the estimated completion date for the entire development plan.

Provide an estimate of the total number of acres of the site on which soil will be disturbed (round to the nearest acre).

Indicate whether the storm water pollution prevention plan for the site is in compliance with approved state and/or local sediment and erosion plans, permits, or storm water management plans.

**SECTION V - CERTIFICATION**

Federal statutes provide for severe penalties for submitting false information on this application form. Federal regulations require this application to be signed as follows:

*For a corporation:* by a responsible corporate officer, which means: (i) president, secretary, treasurer, or vice-president of the corporation in charge of a principal business function, or any other person who performs similar policy or decision making functions, or (ii) the manager of one or more manufacturing, production, or operating facilities employing more than 250 persons or having gross annual sales or expenditures exceeding \$25 million (in second-quarter 1980 dollars), if authority to sign documents has been assigned or delegated to the manager in accordance with corporate procedures;

*For a partnership or sole proprietorship:* by a general partner or the proprietor; or

*For a municipality, state, Federal, or other public facility:* by either a principal executive officer or ranking elected official.

## CAPS

### Parcel 04

1) Owners agree to sign mineral rights for \$0 consideration.

### Parcel 27

1) As part of construction, KYTC agrees to construct a 10' farm entrance near approximate station number 21+50.00 off of the proposed East Parkway Drive.

# GUARDRAIL DELIVERY VERIFICATION SHEET

Contract Id: \_\_\_\_\_

Contractor: \_\_\_\_\_

Section Engineer: \_\_\_\_\_

District & County: \_\_\_\_\_

<u>DESCRIPTION</u>	<u>UNIT</u>	<u>QTY LEAVING PROJECT</u>	<u>QTY RECEIVED@BB YARD</u>
GUARDRAIL (Includes End treatments & crash cushions)	LF	_____	_____
STEEL POSTS	EACH	_____	_____
STEEL BLOCKS	EACH	_____	_____
WOOD OFFSET BLOCKS	EACH	_____	_____
BACK UP PLATES	EACH	_____	_____
CRASH CUSHION	EACH	_____	_____
NUTS, BOLTS, WASHERS	BAG/BCKT	_____	_____
DAMAGED RAIL TO MAINT. FACILITY	LF	_____	_____
DAMAGED POSTS TO MAINT. FACILITY	EACH	_____	_____

**\*Required Signatures before Leaving Project Site**

Printed Section Engineer's Representative \_\_\_\_\_ & Date \_\_\_\_\_

Signature Section Engineer's Representative \_\_\_\_\_ & Date \_\_\_\_\_

Printed Contractor's Representative \_\_\_\_\_ & Date \_\_\_\_\_

Signature Contractor's Representative \_\_\_\_\_ & Date \_\_\_\_\_

**\*Required Signatures after Arrival at Bailey Bridge Yard (All material on truck must be counted & the quantity received column completed before signatures)**

Printed Bailey Bridge Yard Representative \_\_\_\_\_ & Date \_\_\_\_\_

Signature Bailey Bridge Yard Representative \_\_\_\_\_ & Date \_\_\_\_\_

Printed Contractor's Representative \_\_\_\_\_ & Date \_\_\_\_\_

Signature Contractor's Representative \_\_\_\_\_ & Date \_\_\_\_\_

\*\*Payment for the bid item remove guardrail will be based upon the quantities shown in the Bailey Bridge Yard received column. Payment will not be made for guardrail removal until the guardrail verification sheets are electronically submitted to the Section Engineer by the Bailey Bridge Yard Representative.

Completed Form Submitted to Section Engineer Date: \_\_\_\_\_ By: \_\_\_\_\_

**PART II**  
**SPECIFICATIONS AND STANDARD DRAWINGS**

### **SPECIFICATIONS REFERENCE**

Any reference in the plans or proposal to previous editions of the *Standard Specifications for Road and Bridge Construction* and *Standard Drawings* are superseded by *Standard Specifications for Road and Bridge Construction, Edition of 2019* and *Standard Drawings, Edition of 2016*.

## **SUPPLEMENTAL SPECIFICATIONS**

The contractor shall use the Supplemental Specifications that are effective at the time of letting.  
The Supplemental Specifications can be found at the following link:

<http://transportation.ky.gov/Construction/Pages/Kentucky-Standard-Specifications.aspx>

### **SPECIAL NOTE FOR PORTABLE CHANGEABLE MESSAGE SIGNS**

This Special Note will apply when indicated on the plans or in the proposal.

**1.0 DESCRIPTION.** Furnish, install, operate, and maintain variable message signs at the locations shown on the plans or designated by the Engineer. Remove and retain possession of variable message signs when they are no longer needed on the project.

#### **2.0 MATERIALS.**

**2.1 General.** Use LED Variable Message Signs Class I, II, or III, as appropriate, from the Department's List of Approved Materials.

Unclassified signs may be submitted for approval by the Engineer. The Engineer may require a daytime and nighttime demonstration. The Engineer will make a final decision within 30 days after all required information is received.

**2.2 Sign and Controls.** All signs must:

- 1) Provide 3-line messages with each line being 8 characters long and at least 18 inches tall. Each character comprises 35 pixels.
- 2) Provide at least 40 preprogrammed messages available for use at any time. Provide for quick and easy change of the displayed message; editing of the message; and additions of new messages.
- 3) Provide a controller consisting of:
  - a) Keyboard or keypad.
  - b) Readout that mimics the actual sign display. (When LCD or LCD type readout is used, include backlighting and heating or otherwise arrange for viewing in cold temperatures.)
  - c) Non-volatile memory or suitable memory with battery backup for storing pre-programmed messages.
  - d) Logic circuitry to control the sequence of messages and flash rate.
- 4) Provide a serial interface that is capable of supporting complete remote control ability through land line and cellular telephone operation. Include communication software capable of immediately updating the message, providing complete sign status, and allowing message library queries and updates.
- 5) Allow a single person easily to raise the sign to a satisfactory height above the pavement during use, and lower the sign during travel.
- 6) Be Highway Orange on all exterior surfaces of the trailer, supports, and controller cabinet.
- 7) Provide operation in ambient temperatures from -30 to + 120 degrees Fahrenheit during snow, rain and other inclement weather.
- 8) Provide the driver board as part of a module. All modules are interchangeable, and have plug and socket arrangements for disconnection and reconnection. Printed circuit boards associated with driver boards have a conformable coating to protect against moisture.
- 9) Provide a sign case sealed against rain, snow, dust, insects, etc. The lens is UV stabilized clear plastic (polycarbonate, acrylic, or other approved material) angled to prevent glare.
- 10) Provide a flat black UV protected coating on the sign hardware, character PCB, and appropriate lens areas.
- 11) Provide a photocell control to provide automatic dimming.

- 12) Allow an on-off flashing sequence at an adjustable rate.
- 13) Provide a sight to aim the message.
- 14) Provide a LED display color of approximately 590 nm amber.
- 15) Provide a controller that is password protected.
- 16) Provide a security device that prevents unauthorized individuals from accessing the controller.
- 17) Provide the following 3-line messages preprogrammed and available for use when the sign unit begins operation:

/KEEP/RIGHT/=>=>=>/	/MIN/SPEED/**MPH/
/KEEP/LEFT/<=<=</	/ICY/BRIDGE/AHEAD/ /ONE
/LOOSE/GRAVEL/AHEAD/	LANE/BRIDGE/AHEAD/
/RD WORK/NEXT/**MILES/	/ROUGH/ROAD/AHEAD/
/TWO WAY/TRAFFIC/AHEAD/	/MERGING/TRAFFIC/AHEAD/
/PAINT/CREW/AHEAD/	/NEXT/***/MILES/
/REDUCE/SPEED/**MPH/	/HEAVY/TRAFFIC/AHEAD/
/BRIDGE/WORK/***0 FT/	/SPEED/LIMIT/**MPH/
/MAX/SPEED/**MPH/	/BUMP/AHEAD/
/SURVEY/PARTY/AHEAD/	/TWO/WAY/TRAFFIC/

\*Insert numerals as directed by the Engineer.  
Add other messages during the project when required by the Engineer.

**2.3 Power.**

- 1) Design solar panels to yield 10 percent or greater additional charge than sign consumption. Provide direct wiring for operation of the sign or arrow board from an external power source to provide energy backup for 21 days without sunlight and an on-board system charger with the ability to recharge completely discharged batteries in 24 hours.

**3.0 CONSTRUCTION.** Furnish and operate the variable message signs as designated on the plans or by the Engineer. Ensure the bottom of the message panel is a minimum of 7 feet above the roadway in urban areas and 5 feet above in rural areas when operating. Use Class I, II, or III signs on roads with a speed limit less than 55 mph. Use Class I or II signs on roads with speed limits 55 mph or greater.

Maintain the sign in proper working order, including repair of any damage done by others, until completion of the project. When the sign becomes inoperative, immediately repair or replace the sign. Repetitive problems with the same unit will be cause for rejection and replacement.

Use only project related messages and messages directed by the Engineer, unnecessary messages lessen the impact of the sign. Ensure the message is displayed in either one or 2 phases with each phase having no more than 3 lines of text. When no message is needed, but it is necessary to know if the sign is operable, flash only a pixel.

When the sign is not needed, move it outside the clear zone or where the Engineer directs. Variable Message Signs are the property of the Contractor and shall be removed from the project when no longer needed. The Department will not assume ownership of these signs.

**4.0 MEASUREMENT.** The final quantity of Variable Message Sign will be



11

the actual number of individual signs acceptably furnished and operated during the project. The Department will not measure signs replaced due to damage or rejection.

**5.0 PAYMENT.** The Department will pay for the Variable Message Signs at the unit price each. The Department will not pay for signs replaced due to damage or rejection. Payment is full compensation for furnishing all materials, labor, equipment, and service necessary to, operate, move, repair, and maintain or replace the variable message signs. The Department will make payment for the completed and accepted quantities under the following:

<u>Code</u>	<u>Pay Item</u>	<u>Pay Unit</u>
02671	Portable Changeable Message Sign	Each

Effective June 15, 2012

6U

### **SPECIAL NOTE FOR STRUCTURAL MASS CONCRETE**

This Special Note will apply when indicated on the plans or in the proposal. Section references herein are to the Department's 2019 Standard Specifications for Road and Bridge Construction.

**1.0 DESCRIPTION.** This Special Note covers requirements for structural mass concrete placement. The Department considers mass concrete to be any concrete placement, excluding drilled shafts, with its least plan dimension being 6 feet or greater.

#### **2.0 MATERIALS AND EQUIPMENT.**

**2.1 Cement.** Conform to Section 801 or ASTM C595 for blended cements, Type IS or Type I(SM), except the slag constituent in Type IS is limited to 50 percent of the mass of the portland blast furnace slag.

**2.2 Mineral Admixtures.** Conform to Section 844 except the Department will permit fly ash Class F and Grade 100 ground granular blast furnace slag (GGBF) in addition to Grade 120.

**2.3 Aggregate.** Use coarse aggregate conforming to the freeze-thaw expansion requirements of Subsection 805.04.01 for use in all classes of structural mass concrete, excluding seal concrete.

**2.4 Temperature Sensing Equipment.** Use thermistor type temperature sensing devices, or an approved equal, capable of indicating temperatures over a range of 50 to 200 °F, with an accuracy of  $\pm 1$  °F and a precision of 1 °F. Connect the sensors to a device that continuously records and displays temperatures at intervals no greater than 4 hours, and produces a record that can be detached and filed.

**3.0 CONSTRUCTION.** When placing the mixture, do not allow its temperature to exceed 70 °F. Insulate the concrete until the thermal control is finished. Do not allow the concrete to exceed the maximum temperature of 160 °F at any time during the curing period.

**3.1 Thermal Control Plan.** Submit for approval a written Thermal Control Plan describing the procedures to be used to minimize temperature differentials within the concrete. Include all items required by this note, and other items deemed necessary or prudent.

Submit the Thermal Control Plan at least 30 calendar days before the first intended structural mass concrete placement. The Engineer will respond within 21 calendar days after receipt of the plan. Make any changes required by the Engineer and resubmit the plan. Continue this process until the Engineer approves the Thermal Control Plan.

Do not place structural mass concrete before receiving written approval of the Thermal Control Plan and having all equipment and materials necessary to facilitate the plan on the site and ready for use.

Approval of the Thermal Control Plan is independent of the submission of the trial mixtures.

The Department will allow the inclusion of the following items in the Thermal Control Plan.

6U

- 1) Reduction of the total cement content by the use of mineral admixtures. Mineral admixtures derived from blended cements, used as processing additions, or as ingredient materials will apply toward stated maximums.
  - a. Substitution of Class F fly ash for cement at the rate of 25 to 30 percent, by mass, applying a substitution rate of 1.0 to 1.25 pounds of fly ash added.
  - b. Substitution of GGBF for cement up to a maximum of 50 percent, by mass, applying a substitution rate of one pound of GGBF for each one pound of cement.
  - c. Mixes with both GGBF and Class F fly ash, permit up to but no more than 20 percent of the 50 percent GGBF maximum as Class F fly ash.
- 2) Sprinkle the mixer trucks' drums for cooling.
- 3) Arrange with supplier to avoid delivery of hot cement.
- 4) Cooling of aggregate stockpiles.
- 5) Use of a nitrogen gas cooling system to cool the concrete mass before placement.
- 6) Use of shaved, flaked, or chipped ice as part of the mixing water.
- 7) Embedment in the structural mass concrete of a cooling system, approved by the Engineer, consisting of non-corrosive piping and circulating fresh water. Filling of the pipe with concrete or grout after its usefulness has ended is required.
- 8) Placing concrete during the coolest part of the day, or during cooler weather.
- 9) Use of special cements or additives that will reduce heat of hydration without affecting strength or durability.

### **3.2 Thermal Control.**

**3.2.1 Temperature Differential Restrictions.** Ensure that the temperature differential between the geometric center of each placement and the geometric surface does not exceed 35 °F at any time. Maintain thermal control of each placement until the temperature at the center is within 35 °F of the average outside air temperature. Determine the average outside air temperature by averaging the daily high and low temperatures over the preceding 7 calendar days.

**3.2.2 Temperature Sensing and Recording.** For each placement of structural mass concrete, install 4 temperature sensors, 2 at separate locations near the geometric center of each concrete placement and 2 at the approximate center of the exterior face that has the least sun exposure with the longest distance to the interior sensors. Place the exterior side sensors two inches below the exterior surface. The Department requires 2 sensors at each location in order to have a primary and secondary backup.

**3.2.3 Failure to Comply.** If the temperature differential within any structural mass concrete placement exceeds 35 °F, take immediate corrective action, suspend future placement of structural mass concrete, and submit a revised Thermal Control Plan to the Engineer for approval. Do not resume placing mass concrete without written approval from the Engineer.

**3.3 Trial Mixtures.** At least 30 calendar days prior to concrete placement, for each class of concrete used in structural mass concrete, make trial batches according to Subsection 601.03.02 G).

6U

**3.4 Seal Concrete.** Conform to all requirements herein this note for underwater placement of concrete seals, with the following exceptions.

- 1) The Department will not require thermistor devices.
- 2) The Department will not require insulation.
- 3) The Department will not require monitoring of the differential between interior and exterior temperatures.
- 4) When placing the mixture, do not allow its temperature to exceed 60° F.
- 5) Ensure seal concrete has the following properties:

Cementitious Content	564 lbs/cy
Maximum Free Water	0.47 lb water/lb cement
Slump	4-8 inches
Air Content	0-5%
28-day Compressive Strength	3,500 psi

**3.5 Acceptance Testing.** Conform to the specified 28-day compressive strength requirements for each class of concrete. The Department will make extra cylinders at the rate of one set per 100 cubic yards, except seal concrete shall be one set per 200 cubic yards, and will test them at an age of 7 days. The Department will cure the extra cylinders, after the first 24 hours, at a temperature between 60 °F and 80 °F. The extra cylinders will be expected to achieve a minimum 7-day compressive strength of 2,600 psi. If the 2,600 psi is not consistently achieved, take corrective action on future pours.

**4.0 MEASUREMENT.** The Department will not measure the work required by this Special Note as a separate pay unit and will consider it incidental to the various concrete bid items.

**5.0 PAYMENT.** When the temperature differential exceeds 35 °F during the thermal control period, the Department will adjust payment for the concrete within the affected placement by multiplying the contract unit price by the appropriate factor in the following table:

<u>Temperature Differential</u>	<u>Pay Factor</u>
36 to 40 °F	0.96
41 to 45 °F	0.90
46 °F or higher	0.80

When the 35 °F differential is exceeded for more than one 24-hour period, the Department will apply the pay factor for the maximum differential that occurs. Begin measuring temperature differential 12 hours after the last concrete placement.

June 15, 2012

11C

### **SPECIAL NOTE FOR DRILLED SHAFTS**

**1.0 DESCRIPTION.** Furnish all equipment, materials and labor necessary for constructing reinforced concrete drilled shafts in cylindrically excavated holes according to the details shown on the plans or as the Engineer directs. Construct the shaft to the lines and dimensions shown on the plans, or as the Engineer directs. Section references herein are to the Department's 2019 Standard Specifications for Road and Bridge Construction.

#### **2.0 MATERIALS.**

**2.1 Concrete.** Use Class A Modified concrete unless otherwise shown on the plans. The slump at the time of placement shall be 6.5 to 9.5 inches, the coarse aggregate shall be size 67, 68, 78, 8 or 9M, and the water/cementitious material ratio shall not exceed 0.45. Include water reducing and retarding admixtures. Type F high range water reducers used in combination with retarding admixtures or Type G high range water reducers fully meeting trial batch requirements are permitted and Class F fly ash is permitted in conformance with Section 601. Design the mix such that the concrete slump exceeds 4 inches at 4 hours after batching. If the estimated concrete transport, plus time to complete placement, exceeds 4 hours, design the concrete to have a slump that exceeds 4 inches or more for the greater time after batching and demonstrate that the slump requirement can be achieved after the extended time period using a trial batch.

Perform trial batches prior to beginning drilled shaft construction in order to demonstrate the adequacy of the proposed concrete mix. Demonstrate that the mix to be used will meet the requirements for temperature, slump, air content, water/cementitious material ratio, and compressive strength. Use the ingredients, proportions and equipment (including batching, mixing, and delivery) to be used on the project. Make at least 2 independent consecutive trial batches of 3 cubic yards each using the same mix proportions and meeting all specification requirements for mix design approval. Submit a report containing these results for slump, air content, water/cement ratio, temperature, and compressive strength and mix proportions for each trial batch to the Engineer for review and approval. Failure to demonstrate the adequacy of the concrete mix, methods, or equipment to the Engineer is cause for the Engineer to require appropriate alterations in concrete mix, equipment, and/or method by the Contractor to eliminate unsatisfactory results. Perform additional trial batches required to demonstrate the adequacy of the concrete mix, method, or equipment.

**2.2 Steel Reinforcement.** Provide Grade 60 deformed bars conforming to Section 811 of the Standard Specifications. Rail steel is permitted for straight bars only. Place according to Section 602 of the Standard Specifications, this Special Note, and the plans. Use non-corrosive centering devices and feet to maintain the specified reinforcement clearances.

**2.3 Casings.** Provide casing meeting the requirements of ASTM A 252 Grade 2 or better unless otherwise specified. Ensure casing is smooth, clean, watertight, true and straight, and of ample strength to withstand handling, installation, and extraction stresses and the pressure of both concrete and the surrounding earth materials. Ensure the outside diameter of casing is not less than the specified diameter of shaft.

Use only continuous casings. Cut off the casing at the prescribed elevation and trim to within tolerances prior to acceptance. Extend casing into bedrock a sufficient distance to stabilize the shaft excavation against collapse, excessive deformation, and/or flow of water if required and/or shown on the plans.

Install from the work platform continuous casing meeting the design thickness requirements, but not less than 3/8 inch, to the elevations shown on the plans. When drilled

11C

shafts are located in open water areas, extend casings above the water elevation to the plan tip elevation to protect the shaft concrete from water action during concrete placement and curing. All casing is permanent unless temporary casing is specified in the contract drawings or documents. Permanent casing is incidental to the applicable drilled shaft unit bid price unless noted otherwise in the contract. Temporary casing may be required for drilled shafts not socketed into bedrock. If temporary surface casings are used, extend each casing up to the work platform. Remove all temporary surface casing prior to final acceptance unless otherwise permitted by the Central Office Construction Engineer.

Ensure casing splices have full penetration butt welds conforming to the current edition of AWS D1.1 with no exterior or interior splice plates and produce true and straight casing.

**2.4 Slurry.** When slurry is to be used for installation of the Drilled Shaft, submit a detailed plan for its use and disposal. The plan should include, but not be limited to the following:

- 1) Material properties
- 2) Mixing requirements and procedures
- 3) Testing requirements
- 4) Placement procedures
- 5) Disposal techniques

Obtain the Central Office Division of Construction's approval for the slurry use and disposal plan before installing drilled shafts.

**2.5 Tremies.** Provide tremies of sufficient length, weight, and diameter to discharge concrete at the shaft base elevation. Ensure the tremie diameter is least 6 times the maximum size coarse aggregate to be used in the concrete mix and no less than 10 inches. Provide adequate wall thickness to prevent crimping or sharp bends that restrict concrete placement. Support tremies used for depositing concrete in a dry drilled shaft excavation so that the free fall of the concrete does not cause the shaft excavation to cave or slough. Maintain a clean and smooth tremie surface to permit both flow of concrete and unimpeded withdrawal during concrete placement. Do not allow any aluminum parts to contact the concrete. Construct tremies used to deposit concrete for wet excavations so that they are watertight and will readily discharge concrete.

**2.6 Concrete Pumps.** Provide pump lines with a minimum diameter of 5 inches and watertight joints.

**2.7 Drop Chutes.** Do not use aluminum drop chutes.

### **3.0 CONSTRUCTION.**

#### **3.1 Preconstruction.**

**3.1.1 Prequalification.** The Department will require prequalification by the Division of Construction Procurement before accepting a bid for the construction of Drilled Shafts.

**3.1.2 Pre-Bid Inspection.** Inspect both the project site and all subsurface information, including any soil or rock samples, prior to submitting a bid. Contact the Geotechnical Branch (502-564-2374) to schedule a viewing of the subsurface information. Failure to inspect the project site and view the

11C

subsurface information will result in the forfeiture of the right to file a claim based on site conditions and may result in disqualification from the project.

**3.1.3 Drilled Shaft Installation Plan.** Upon request, the Department will review a Drilled Shaft Installation Plan. Submit the plan no later than 45 calendar days prior to constructing drilled shafts. Items covered in this plan should include, but not be limited to the following:

- 1) Name and experience record of jobsite drilled shaft superintendent and foremen in charge of drilled shaft operations for each shift.
- 2) List and size of proposed equipment including cranes, drills, augers, bailing buckets, final cleaning equipment, de-sanding equipment, slurry pumps, core sampling equipment, tremies or concrete pumps, casings, etc.
- 3) Details of overall construction operation sequence and the sequence of shaft construction in the bents or groups.
- 4) Details of shaft excavation methods including methods to over-ream or roughen shaft walls, if necessary.
- 5) Details of slurry when the use of slurry is anticipated. Include methods to mix, circulate, and de-sand the proposed slurry. Provide details of proposed testing, test methods, sampling methods, and test equipment.
- 6) Details of proposed methods to clean shaft and inside of casing after initial excavation.
- 7) Details of reinforcement handling, lifting, and placement including support and method to center in shaft. Also include rebar cage support during concrete placement and temporary casing removal.
- 8) Details of concrete placement including procedures for concrete tremie or pump. Include initial placement, raising during placement, and overfilling of the shaft to expel contaminated concrete.
- 9) Required submittals including shop drawings and concrete design mixes.
- 10) Other information shown in the plans or requested by the Engineer.
- 11) Special considerations for wet construction.
- 12) Details of environmental control procedures to protect the environment from discharge of excavation spoil, slurry (natural and mineral), and concrete over-pour.

The Division of Construction will review the submitted procedure and provide comments and recommendations. The Contractor is responsible for satisfactory construction and ultimate performance of the Drilled Shaft.

**3.2 General Construction.** Construct drilled shafts as indicated in the plans or described in this Special Note by either the dry or wet method. When the plans describe a particular method of construction, use this method unless the Engineer permits otherwise. When the plans do not describe a particular method, propose a method on the basis of its suitability to the site conditions. Approval of this proposed method is contingent upon the satisfactory results of the technique shaft.

The construction of the first drilled shaft or technique shaft will be used to determine if the methods and equipment used by the contractor are sufficient to produce a completed shaft meeting the requirements of the plans and specifications. Ability to control dimensions and alignment of excavations within tolerances; to seal the casing into impervious materials; to prevent caving or deterioration of subsurface materials by the use of slurry or other means; to

11C

properly clean the completed shaft excavation; to construct excavations in open water areas when required by the plans; to establish methods for boring or over-reaming when required by the plans; to determine the elevation of ground water; to satisfactorily handle, lift, place, and support the reinforcement cage; to satisfactorily place concrete meeting the specifications within the prescribed time frame; and to satisfactorily execute any other necessary construction operations will be evaluated during construction of the first shaft(s). Revise the methods and equipment as necessary at any time during the construction of the first shaft when unable to satisfactorily carry out any of the necessary operations described above or unable to control the dimensions and alignment of the shaft excavation within tolerances. Accurately locate technique so they may be used in the finished structure unless directed otherwise in the contract document or by the Engineer.

If at any time the Contractor fails to satisfactorily demonstrate, to the satisfaction of the Engineer, the adequacy of methods or equipment and alterations are required, additional technique shafts will be required at no additional cost to the Department and with no extension of contract time. Additional technique shafts shall be located as near as possible to the proposed production shafts but in a location as not to interfere with other construction activities. Once approval has been given to construct production shafts, no changes will be permitted in the methods or equipment used to construct the satisfactory shaft without written approval of the Engineer.

Do not make a claim against the Department for costs of construction delays, or any materials, labor, or equipment that may be necessary due to the Contractor's failure to furnish drilled shafts of a length sufficient to obtain the required bearing values, or for variations in length due to subsurface conditions that may be encountered. Soundings, boring logs, soil profiles, or other subsurface data included in the Contract documents are used by the Department for design and making preliminary estimates of quantities and should be used only at the risk of the Contractor for determining equipment, materials, or labor necessary for drilling shafts as required by the contract.

When necessary, set temporary removable surface casing. Use surface casing of sufficient length to prevent caving of the surface soils and to aid in maintaining shaft position and alignment. Pre-drilling with slurry and/or over-reaming to the outside diameter of the casing may be required to install the surface casing at some sites.

Provide equipment capable of constructing shafts to the deepest shaft depth shown in the plans plus 15 feet, 20 percent greater than the longest shaft (measured from the ground or water surface to the tip of the shaft), or 3 times the shaft diameter, whichever is greater. Blasting excavation methods are not permitted.

Use permanent casing unless otherwise noted in the Contract. Place casing as shown on the plans before beginning excavation. If full penetration cannot be attained, the Engineer may direct that excavation through the casing be accomplished and the casing advanced until reaching the plan tip elevation. In some cases, over-reaming to the outside diameter of the casing may be required before placing the casing. Cut off the casing at the prescribed elevation and leave the remainder of the casing in place. Do not use vibratory hammers for casing installation within 50 feet of shafts that have been completed less than 24 hours.

**3.2.1 Dry Construction Method.** Use the dry construction method only at sites where the ground water table and soil conditions (generally stiff to hard clays or rock above the water table) make it feasible to construct the shaft in a relatively dry excavation and where the sides and bottom of the shaft are stable and may be visually inspected by the Engineer prior to placing the concrete. The dry construction method consists of drilling the shaft excavation, removing accumulated seepage water and loose material from the excavation, and placing the shaft concrete in a relatively dry excavation.



11C

**3.2.2 Wet Construction Method.** Use the wet construction method at all sites where it is impractical to excavate by the dry method. The wet construction method consists of drilling the shaft excavation below the water table, keeping the shaft filled with water (including natural slurry formed during the drilling process) or slurry as defined in part 2.4 of this Special Note, desanding and cleaning the slurry as required, final cleaning of the excavation by means of a bailing bucket, air lift, submersible pump or other approved devices and placing the shaft concrete (with a tremie or concrete pump beginning at the shaft bottom) which displaces the water or slurry as concrete is placed.

Where drilled shafts are located in open water areas, construct the shafts by the wet method using casings extending from above water elevation to the plan casing tip elevation to protect the shaft concrete from water action during placement and curing. Install the casing in a manner that will produce a positive seal at the bottom of the casing.

**3.3 Slurry.** When the Contractor elects to use slurry, adjust construction operations so that the slurry is in contact with the bottom 5 feet of the shaft for less than 4 hours unless the Engineer approves otherwise. If the 4-hour limit is exceeded, over-ream the bottom 5 feet of shaft.

**3.4 Cleaning.** Over-reaming, cleaning, or wire brushing the sidewalls of the shaft excavation and permanent casings may be necessary to remove the depth of softening or to remove excessive slurry cake buildup as indicated by sidewall samples or other test methods employed by the Engineer. Over-ream around the perimeter of the excavation a minimum depth of 1/2 inch and maximum depth of 3 inches.

**3.5 Subsurface Exploration.** Take subsurface exploration borings when shown on the plans or as the Engineer directs to determine the character of the material that the shaft extends through and the material directly below the shaft excavation. Complete subsurface exploration borings prior to beginning excavation for any drilled shaft in a group. Unless directed otherwise, extend subsurface exploration borings a minimum depth of 3 shaft diameters but not less than 10 feet below the bottom of the anticipated tip of drilled shaft excavation as shown on the plans. For subsurface exploration borings where soil sampling is required use thin-wall tube samples and perform standard penetration tests according to the Department's current Geotechnical Manual. When shafts extend into bedrock, soil samples are not required unless otherwise specified. Perform rock core drilling according to the Department's Geotechnical Manual. When the Engineer directs, perform additional subsurface exploration borings prior to drilled shaft construction. Measure soil samples and/or rock cores and visually identify and describe them on the subsurface log according to the Department's current Geotechnical Manual. Subsurface exploration borings must be performed by contractors/consultants prequalified by the Department's Division of Professional Services for Geotechnical Drilling Services at the time that field work begins.

The Engineer or geotechnical branch representative may be on-site during the subsurface exploration process to evaluate the soil and/or rock core samples. The Engineer or geotechnical branch representative will determine the need to extend the borings to depths greater than the depths previously specified. Handle, label, identify, and store soil and/or rock samples according to the Department's current Geotechnical Manual and deliver them with the subsurface logs to the geotechnical branch's rock core lab in Frankfort within 24-hours of completing the borings, unless directed otherwise.

The Engineer will inspect the soil samples and/or cores and determine the final depth of required excavation (final drilled shaft tip elevation) based on evaluation of the material's suitability. The Engineer will establish the final tip elevations for shaft locations, other than

11C

those for which subsurface exploration borings have been performed, based on the results of the subsurface exploration. Within 15 calendar days after completion of the subsurface exploration borings, the Engineer will notify the contractor of the final tip elevations for shaft locations.

**3.6 Excavations.** The plans indicate the expected depths, the top of shaft elevations, and the estimated bottom of shaft elevations between which the drilled shaft are to be constructed. Drilled shafts may be extended deeper when the Engineer determines that the material encountered while drilling the shaft excavation is unsuitable and/or is not the same as anticipated in the design of the drilled shaft. Drilled shafts may be shortened when the Engineer determines the material encountered is better than that anticipated.

Begin drilled shaft excavation the excavation, excavation inspection, reinforcement placement, and concrete placement can be completed as one continuous operation. Do not construct new shafts within 24 hours adjacent to recently completed shafts if the center-to-center spacing is less than 3 shaft diameters.

Dispose of excavated material removed from the shaft according to the Standard Specifications or the contract documents.

Do not allow workmen to enter the shaft excavation for any reason unless both a suitable casing has been installed and adequate safety equipment and procedures have been provided to the workmen entering the excavation. Recommended Procedures for the Entry of Drilled Shaft Foundation Excavations, prepared by ADSC: The International Association of Foundation Drilling provides guideline recommendations for down-hole entry of drilled excavations.

**3.7 Obstructions.** Remove subsurface obstructions at drilled shaft locations. Such obstructions may include man-made materials such as old concrete foundations or natural materials such as boulders. Blasting is not permitted.

**3.8 Inspections of Excavations.** Provide equipment for checking the dimensions and alignment of each shaft excavation. Determine the dimensions and alignment of the shaft excavation under the observation and direction of the Engineer. Provide equipment necessary to verify shaft cleanliness for the method of inspection selected by the Engineer.

Measure final shaft depths with a weighted tape or other approved methods after final cleaning. Ensure the base of each shaft has less than ½ inch of sediment at the time of concrete placement. For dry excavations, do not allow the depth of water to exceed 3 inches for tremie or pump methods of concrete placement. Verify shaft cleanliness to the Engineer using direct visual inspection or other method the Engineers determines acceptable. Video camera or underwater inspection procedures may be used if specified in the plans. Inspect the side surfaces of rock sockets to ensure they are rough and of such condition to ensure bond between the shaft concrete and the rock. Calipers, bent rods, or other devices may be used to inspect the diameter and roughness of rock sockets. When the Engineer directs, mechanically roughen surfaces found to be smooth.

**3.9 Reinforcing Steel Cage Fabrication and Placement.** Assemble the reinforcing steel cage, consisting of longitudinal bars, ties, spirals, cage stiffener bars, spacers, centering devices, and other necessary appurtenances and place as a prefabricated unit immediately after the shaft excavation is inspected and accepted, and just prior to concrete placement.

Tie the reinforcing steel with 100 percent double-wire ties and provide support so that it will remain within allowable tolerances for position. Locate splices as shown on the plans. Splice no more than 50 percent of the longitudinal reinforcing within 2-lap splice lengths of any location or within 3 feet of the splice location if approved mechanical connectors are used. All splices are to be in accordance with plan details. Use bands, temporary cross ties,

11C

etc. as required to provide a reinforcement cage of sufficient rigidity to prevent racking, permanent deformations, etc. during installation.

Use concrete centering devices or other approved non-corrosive centering devices at sufficient intervals along the length of the reinforcement cage to ensure concentric spacing for the entire cage length. As a minimum, provide a set of non-corrosive centering devices at intervals not exceeding 5 feet throughout the length of the shaft. When the size of the longitudinal reinforcement exceeds one inch in diameter the minimum spacing may be increased to 10 feet. As a minimum, provide a set of centering devices within 2 feet of the top and 2 feet of the bottom of the shaft. In addition provide one set of centering devices 2 feet above and 2 feet below each change in shaft diameter. Provide feet (bottom supports) at the bottom of the shaft on vertical bars. As a minimum, provide non-corrosive centering devices at 60 degree intervals around the circumference of the shaft to maintain the required reinforcement clearances. Ensure the centering devices maintain the specified annular clearance between the outside of the reinforcing cage and the side of the excavated hole or casing.

Concrete centering devices and feet will be constructed of concrete equal in quality and durability to the concrete specified for the shaft. Use epoxy coated centering devices fabricated from reinforcing steel. Use feet (bottom supports) of adequate size and number to assure the rebar cage is the proper distance above the bottom as determined by part 3.11 3) of this Special Note. The feet are not intended to support the weight of the cage. In the event that the shaft has been excavated below the anticipated tip elevation, extend the reinforcing cage at the tip (low) end by lap splices, mechanical connectors, or welded splices conforming to the Standard Specifications. In this instance, splices need not be staggered and 100 percent of the reinforcing bars may be spliced at a given location. The bottom 12 inches of the shaft may not be reinforced when below plan tip elevation.

During concrete placement, support the reinforcing cage at or near the top of shaft such that the concrete feet are positioned approximately one inch above the bottom of shaft excavation. Not sooner than 24 hours after the completion of concrete placement, remove temporary supports. Provide the needed equipment, including extra cranes if necessary, to provide this cage support.

Prior to placing the reinforcement cage, demonstrate to the satisfaction of the Engineer that the fabrication and handling methods to be used will result in a reinforcing cage placed in the proper position, with the proper clearances, and without permanent bending, squashing, or racking of the reinforcement cage. During this demonstration bring the cage to an upright position, lower into a shaft excavation, and support as if for concrete placement.

Check the elevation of the top of the reinforcing cage before and after the concrete is placed. If the reinforcing cage is not maintained within the specified tolerances, correct to the satisfaction of the Engineer. Do not construct additional shafts until the contractor has modified his reinforcing cage support to obtain the required tolerances.

**3.10 Concrete Placement.** Place concrete according to the applicable portions of the Standard Specifications and with the requirements set forth herein. Do not apply the provisions of the Special Note 6U for Structural Mass Concrete.

Place concrete as soon as practical after reinforcing steel placement but no later than 4 hours after completion of the shaft excavation. Place concrete continuously from the bottom to above the top elevation of the shaft. For shafts that extend above ground or water surface, place concrete continuously after the shaft is full until good quality concrete is evident at the top of the shaft. Form any portion of the shaft above ground with a removable form or other approved method to the dimensions shown on the plans.

For shafts constructed in the wet with the top of the shaft below the water surface and below top of casing, place concrete to approximately one shaft diameter but no less than 2 feet above the top of shaft elevation. Remove contaminated concrete and deleterious material, as

11C

determined by the Engineer, accumulated above the top of shaft elevation immediately after completing concrete placement. Deleterious material and contaminated concrete may be airlifted under a head of water or slurry provided that the head is maintained at or near the exterior water surface elevation. Carefully remove any concrete remaining above plan top of shaft after curing and excess casing removal.

Place concrete either by free fall, through a tremie, or concrete pump. Use the free fall placement method in dry holes only. The maximum height of free fall placement is 20 feet. Do not allow concrete placed by free fall to contact either the reinforcing cage or hole sidewall. Drop chutes may be used to direct concrete to the base during free fall placement.

Place concrete in the shaft in one continuous operation. Maintain a minimum slump of 4 inches or more throughout the placement for 4 hours after batching. Adjust approved admixtures in the concrete mix for the conditions encountered on the job so that the concrete remains in a workable plastic state throughout the placement. Perform slump loss tests to demonstrate that the concrete will maintain a 4-inch or greater slump for a period of time equal to the estimated transport plus the 2-hour placement time, but not less than 4 hours.

When the Engineer determines the concrete placement methods and/or equipment during construction of any technique and/or production shafts to be inadequate, make appropriate alterations to eliminate unsatisfactory results.

Drilled shafts not meeting the concrete placement requirements of this Special Note or contract plans are unacceptable. Correct all unacceptable completed shafts to the satisfaction of the Engineer.

**3.10.1 Tremie Placement.** Tremies may be used for concrete placement in either wet or dry holes. Extend the tremie to the shaft base elevation before starting underwater placement. Valves, bottom plates, or plugs may be used only if concrete discharge can begin approximately 2 inches above the excavation bottom. Remove plugs from the excavation unless otherwise approved by the Engineer. Maintain tremie discharge at or near the bottom of excavation as long as practical during concrete placement. Immerse tremie discharge end as deep as practical in the concrete but not less than 10 feet.

If at any time during the concrete pour the tremie line orifice is removed from the fluid concrete column and discharges concrete above the rising concrete surface, the entire drilled shaft is considered defective. In such case, remove the reinforcing cage and concrete, complete any necessary sidewall cleaning or over-reaming as directed by the Engineer, and repour the shaft.

**3.10.2 Pumped Concrete.** Concrete pumps and lines may be used for concrete placement in either wet or dry excavations. Do not begin concrete placement until the pump line discharge orifice is at the shaft base elevation.

For wet excavations, use a plug or similar device to separate the concrete from the fluid in the hole until pumping begins. Remove the plug unless otherwise approved by the engineer.

Ensure the discharge orifice remains at least 10 feet below the surface of the fluid concrete. When lifting the pump line during concrete placement, reduce the line pressure until the orifice has been repositioned at a higher level in the excavation.

If at any time during the concrete pour the pump line orifice is removed from the fluid concrete column and discharges concrete above the rising concrete level, the Department will consider the shaft defective. In such case, remove the reinforcing cage and concrete, complete any necessary sidewall cleaning or over-reaming as the Engineer directs, and repour the shaft.

11C

**3.10.3 Drop Chutes.** Drop chutes may be used to direct placement of free fall concrete in excavations where the maximum depth of water does not exceed one inch. Do not use the free fall method of placement in wet excavations. Concrete may be placed through either a hopper at the top of the tube or side openings as the drop chute is retrieved during concrete placement. Reduce the height of free fall and/or reduce the rate of concrete flow into the excavation if the concrete placement causes the shaft excavation to cave or slough, or if the concrete strikes the reinforcing cage or sidewall. When the Engineer determines free fall placement cannot be accomplished satisfactorily, use either tremie or pumping to accomplish the pour.

**3.11 Construction Tolerances.** The following construction tolerances apply to drilled shafts unless otherwise stated in the contract document:

- 1) Construct drilled shaft within 3 inches of plan position in the horizontal plane at the top of the shaft.
- 2) Do not vary the vertical alignment of a shaft excavation from the plan alignment by more than 1/4 inch per foot of depth or 6 inches total.
- 3) Maintain the top of the reinforcing steel cage no more than 6 inches above and no more than 3 inches below plan position.
- 4) All casing diameters shown on the plans refer to O.D. (outside diameter) dimensions. The casing dimensions are subject to American Pipe Institute tolerances applicable to regular steel pipe. A casing larger in diameter than shown in the plans may be used, at no additional cost, with prior approval by the Department.
- 5) Maintain the top of shaft concrete within  $\pm 3$  inches from the plan top of shaft elevation, measured after excess shaft concrete has been removed.
- 6) Design excavation equipment and methods so that the completed shaft excavation will have a planar bottom. Maintain the cutting edges of excavation equipment normal to the vertical axis of the equipment within a tolerance of  $\pm 3/8$  inch per foot of diameter. The tip elevation of the shaft has a tolerance of  $\pm 6$  inches from final shaft tip elevation unless otherwise specified in the plans.

Drilled shaft excavations and completed shafts not constructed within the required tolerances are unacceptable. Correct all unacceptable shaft excavations and completed shafts to the satisfaction of the Engineer. When a shaft excavation is completed with unacceptable tolerances, present corrective measures designed by a registered Professional Engineer for approval.

#### **4.0 MEASUREMENT.**

**4.1 Drilled Shafts.** The Department will not measure for payment any trial batches required to demonstrate the adequacy of the concrete mix, method, or equipment; concrete required to fill an oversized casing or oversized excavation; obstruction removal; over-reaming or sidewall cleaning; inspection work or inspection equipment; materials or work necessary, including engineering analyses and redesign, to alter unacceptable work methods or to complete corrections for unacceptable work; and will consider them incidental to the Drilled Shaft. Unless noted otherwise in the contract documents, casing is incidental to the drilled shaft.

**4.1.1 Drilled Shaft, Common.** The Department will measure the length, in linear feet, of drilled shaft above the top of rock elevation shown on the plans. The

11C

Department will consider this quantity Drilled Shaft, Common regardless of the character of material actually encountered.

**4.1.2 Drilled Shafts, Solid Rock.** The Department will measure the length, in linear feet, of drilled shaft below the top of rock elevation shown on plans. The Department will consider this quantity Drilled Shafts, Solid Rock regardless of the character of material actually encountered during excavation.

**4.2 Technique Shaft.** The Department will pay for technique shaft at the contract unit price per each as detailed on the plans or as directed by the Engineer. This will constitute full compensation for all costs incurred during installation as described herein for 'Drilled Shaft' or in the contract documents. No additional compensation beyond the number of technique shafts allowed for in the plans will be permitted for additional technique shafts required because of failure to demonstrate adequacy of methods.

**4.3 Rock Coring and Rock Sounding.** The Department will measure Rock Sounding and Rock Coring shown on the plans, as specified in part 3.5 of this Special Note, and as the Engineer directs, in linear feet to the nearest 0.1-foot. If soil samples are specified in the contract documents they will be incidental to the unit price bid for Rock Sounding. The Department will not measure or pay for subsurface exploration performed deeper than the elevations indicated on the plans and/or in this Special Note, unless directed by the Engineer, and will consider it incidental to these items of work. Additionally, the Department will consider all mobilization, equipment, labor, incidental items, and operations necessary to complete the boring operations incidental to these items of work.

**5.0 PAYMENT.** The Department will make payment for the completed and accepted quantities under the following:

<u>Code</u>	<u>Pay Item</u>	<u>Pay Unit</u>
----	Drilled Shaft, Diameter*, Common	Linear Foot
----	Drilled Shaft, Diameter*, Solid Rock	Linear Foot
----	Technique Shaft	Each
20745ED	Rock Sounding	Linear Foot
20746ED	Rock Coring	Linear Foot

\* See Plan Sheets for sizes of shafts.

The Department will consider payment as full compensation for all work required in this note.

June 15, 2012

## SPECIAL NOTE FOR ROCK BLASTING

This Special Note will apply when indicated on the plans or in the proposal. Section references herein are to the Department's 2019 Standard Specifications for Road and Bridge Construction.

**1.0 DESCRIPTION.** This work consists of fracturing rock and constructing stable final rock cut faces using presplit blasting and production blasting techniques.

**2.0 MATERIALS.** Deliver, store, and use explosives according to the manufacturer's recommendations and applicable laws. Do not use explosives outside their recommended use date. Verify date of manufacture and provide copies of the technical data sheets (TDS) and material safety data sheets (MSDS) to the Engineer. Explosives and initiating devices include, but are not necessarily limited to, dynamite and other high explosives, slurries, water gels, emulsions, blasting agents, initiating explosives, detonators, blasting caps, and detonating cord.

**3.0 CONSTRUCTION.** Furnish copies or other proof of all-applicable permits and licenses. Comply with Federal, State, and local regulations on the purchase, transportation, storage, and use of explosives through 1990. Regulations include but are not limited to the following:

- 1) 805 KAR 4:005 through 4:165
- 2) 805 KAR 4:005 through 4:165
- 3) Applicable rules and regulations issued by the Office of Mine Safety and Licensing.
- 4) Safety and health. OSHA, 29 CFR Part 1926, Subpart U.
- 5) Storage, security, and accountability. Bureau of Alcohol, Tobacco, and Firearms (BATF), 27 CFR Part 181.
- 6) Shipment. DOT, 49 CFR Parts 171-179, 390-397.

**3.1 Blaster-in-Charge.** Designate in writing a blaster-in-charge and any proposed alternates for the position. Submit documentation showing the blaster-in-charge, and alternates, have a valid Kentucky blaster's license. Ensure the blaster-in-charge or approved alternate is present at all times during blasting operations.

**3.2 Blasting Plans.** Blasting plans and reports are for quality control and record keeping purposes. Blasting reports are to be signed by the blaster-in-charge or the alternate blaster-in-charge. The general review and acceptance of blasting plans does not relieve the Contractor of the responsibility whatsoever for conformance to regulations or for obtaining the required results. All blasting plans shall be submitted to the Engineer. The Engineer will be responsible for submitting the plan to the Central Office Division of Construction and the Division of Mine Reclamation and Enforcement, Explosives and Blasting Branch at the following address: 2 Hudson Hollow, Frankfort, Kentucky, 40601.

- A) General Blasting Plan.** Submit a general blasting plan for acceptance at least 15 working days before drilling operations begin. Include, as a minimum, the following safety and procedural details:

- 1) Working procedures and safety precautions for storing, transporting, handling, detonating explosives. Include direction on pre and post blast audible procedures, methods of addressing misfires, and methods of addressing inclement weather, including lightning.
  - 2) Proposed product selection for both dry and wet holes. Furnish Manufacturer's TDS and MSDS for all explosives, primers, initiators, and other blasting devices.
  - 3) Proposed initiation and delay methods.
  - 4) Proposed format for providing all the required information for the site specific blasting shot reports.
- B) Preblast Meeting.** Prior to drilling operations, conduct a preblast meeting to discuss safety and traffic control issues and any site specific conditions that will need to be addressed. Ensure, at a minimum, that the Engineer or lead inspector, Superintendent, blaster-in-charge, and all personnel involved in the blasting operation are present. Site specific conditions include blast techniques; communication procedures; contingency plans and equipment for dealing with errant blast material. The conditions of the General Blasting plan will be discussed at this meeting. Record all revisions and additions made to the blasting plan and obtain written concurrence by the blaster-in-charge. Provide a copy of the signed blast plan to the Engineer along with the sign in sheet from the preblast meeting.

**3.3 Preblast Condition Survey and Vibration Monitoring and Control.** Before blasting, arrange for a preblast condition survey of nearby buildings, structures, or utilities, within 500 feet of the blast or that could be at risk from blasting damage. Provide the Engineer a listing of all properties surveyed and any owners denying entry or failing to respond. Notify the Engineer and occupants of buildings at risk at least 24 hours before blasting.

Limit ground vibrations and airblast to levels that will not exceed limits of 805 KAR 4:005 through 4:165. More restrictive levels may be specified in the Contract.

Size all blast designs based on vibration, distance to nearest building or utility, blast site geometry, atmospheric conditions and other factors. Ground vibrations are to be controlled according to the blasting standards and scaled distance formulas in 805 KAR 4:020 or by the use of seismographs as allowed in 805 KAR 4:030. The Department will require seismographs at the nearest allowable location to the protected site when blasting occurs within 500 feet of buildings, structures, or utilities.

**3.4 Blasting.** Drill and blast at the designated slope lines according to the blasting plan. Perform presplitting to obtain smooth faces in the rock and shale formations. Perform the presplitting before blasting and excavating the interior portion of the specified cross section at any location. The Department may allow blasting for fall benches and haul roads prior to presplitting when blasting is a sufficient distance from the final slope and results are satisfactory to the Engineer. Use the types of explosives and blasting accessories necessary to obtain the required results.

Free blast holes of obstructions for their entire depth. Place charges without caving the blast hole walls. Stem the upper portion of all blast holes with dry sand or other granular material passing the 3/8-inch sieve. Dry drill cuttings are acceptable for stemming when blasts are more than 800 feet from the nearest dwelling.



11D

Stop traffic during blasting operations when blasting near any road and ensure traffic does not pass through the Danger Zone. The blaster-in-charge will define the Danger Zone prior to each blast. Ensure traffic is stopped outside the Danger Zone, and in no case within 800 feet of the blast location.

Following a blast, stop work in the entire blast area, and check for misfires before allowing worker to return to excavate the rock.

Remove or stabilize all cut face rock that is loose, hanging, or potentially dangerous. Leave minor irregularities or surface variations in place if they do not create a hazard. Drill the next lift only after the cleanup work and stabilization work is complete.

When blasting operations cause fracturing of the final rock face, repair or stabilize it in an approved manner at no cost to the Department.

Halt blasting operations in areas where any of the following occur:

- 1) Slopes are unstable;
- 2) Slopes exceed tolerances or overhangs are created;
- 3) Backslope damage occurs;
- 4) Safety of the public is jeopardized;
- 5) Property or natural features are endangered;
- 6) Fly rock is generated; or
- 7) Excessive ground or airblast vibrations occur in an area where damage to buildings, structures, or utilities is possible.
- 8) The Engineer determines that materials have become unsuitable for blasting

Blasting operations may continue at a reasonable distance from the problem area or in areas where the problems do not exist. Make the necessary modifications to the blasting operations and perform a test blast to demonstrate resolution of the problem.

**A) Drill Logs.** Maintain a layout drawing designating hole numbers with corresponding drill logs and provide a copy of this information to the blaster prior to loading the hole. Ensure the individual hole logs completed by the driller(s) show their name; date drilled; total depth drilled; and depths and descriptions of significant conditions encountered during drilling that may affect loading such as water, voids, changes in rock type.

**B) Presplitting.** Conduct presplitting operations in conformance with Subsection 204.03.04 of the Standard Specifications for Road and Bridge Construction.

**3.5 Shot Report.** Maintain all shot reports on site for review by the Department. Within one day after a blast, complete a shot report according to the record keeping requirements of 805 KAR 4:050. Include all results from airblast and seismograph monitoring.

**3.6 Unacceptable Blasting.** When unacceptable blasting occurs, the Department will halt all blasting operations. Blasting will not resume until the Department completes its investigation and all concerns are addressed. A blast is unacceptable when it results in fragmentation beyond the final rock face, fly rock, excessive vibration or airblast, overbreak, damage to the final rock face or overhang. Assume the cost for all resulting damages to private and public property and hold the Department harmless.

11D

When an errant blast or fly rock causes damage to or blocks a road or conveyance adjacent to the roadway, remove all debris from the roadway as quickly as practicable and perform any necessary repairs. Additionally, when specified in the Contract, the Department will apply a penalty.

Report all blasting accidents to the Division of Mine Reclamation and Enforcement, Explosives and Blasting Branch at 502-564-2340.

**4.0 MEASUREMENT AND PAYMENT.** The Department will not measure this work for payment and will consider all items contained in this note to be incidental to either Roadway Excavation or Embankment-in-Place, as applicable. However, if the Engineer directs in writing slope changes, then the Department will pay for the second presplitting operation as Extra Work.

The Department will measure for payment material lying outside the typical section due to seams, broken formations, or earth pockets, including any earth overburden removed with this material, only when the work is performed under authorized adjustments.

The Department will not measure for payment any extra material excavated because of the drill holes being offset outside the designated slope lines.

The Department will not measure for payment any material necessary to be removed due to the inefficient or faulty blasting practices.

June 15, 2012

11E

**SPECIAL NOTE FOR BORING AND JACKING STEEL PIPE  
WITHOUT CARRIER PIPE**

This Special Note will apply where indicated on the plans or in the proposal. Section references herein are to the Department’s 2019 Standard Specifications for Road and Bridge Construction.

**1.0 DESCRIPTION.** Bore and jack steel pipe. Use this note when no carrier pipe will be encased.

**2.0 MATERIALS.**

**2.1 Pipe.** Provide plain end steel pipe with a specific minimum yield strength, SMYS, of at least 35,000 psi and tensile strength of 60,000 psi per API-5L grade B material. The steel pipe supplied shall be manufactured by the seamless, electric-weld, submerged-arc weld or gas metal-arc well process as specified in API –5L. Certification of 35,000 psi SMYS shall be furnished by the supplier through the Contractor to the Engineer to retain 3 copies.

MINIMUM WALL THICKNESS FOR STEEL PIPE	
Nominal Diameter (Inches)	Wall Thickness (Inches)
18 or less	0.375
24	0.500
30	0.500
36	0.532
42	0.625

**2.2 Grout.** Conform to Subsection 601.03.03.

**2.3 High Grade Bentonite.** Conform to the following:

API 13A Section 4		
Requirement	Specification	Result
Viscometer Dial Reading at 600 rpm	30, minimum	40
Yield Point/Plastic Viscosity Ratio	3, maximum	3.00 maximum
Filtrate Volume	15 cm <sup>3</sup> , maximum	14.50 maximum
Residue greater than 75 micrometers	4.0 wt percent maximum	1.0-1.5 %
Moisture	10.0 wt percent maximum	9.0-9.5%

**3.0 CONSTRUCTION.** Perform the following:

1. Locate a suitable pit and obtain the Engineer’s approval.
2. Excavate the pit or trenches for the BORE AND JACK operation and for placing the end joints of pipe, when required. Securely sheet and brace the pits or trenches to prevent caving, where necessary.

11E

3. When installing pipe under railroads, highways, streets, or other facilities by Bore and Jack, perform construction without interfering with the facility operation or weakening the roadbed or structure.
4. Place excavated material near the top of the working pit and dispose of it as required. Use water or other fluids with the boring operation to lubricate the cuttings. Do not perform jetting.
5. In unconsolidated soil formations, use a gel-forming colloidal drilling fluid with at least 10 percent of high grade bentonite to consolidate excavated material, seal the walls of the hole, and lubricate subsequent removal of material and immediate pipe installation.
6. Ensure that the diameter of the excavation conforms to the outside diameter of the pipe as closely as possible.
7. Pressure grout voids that develop during the installation operation and that the Engineer determines are detrimental to the Work.
8. To force the pipe through the roadbed into the bored space, use a jack with a head constructed to apply uniform pressure around the ring of the pipe, which shall be square cut.
9. Set the pipe to be jacked on guides, braced together to properly support the pipe section and to direct it to the proper line and grade.
10. When the installation is made by concurrent boring and jacking, solidly weld all joints. Ensure the weld is strong enough to withstand the forces exerted from the boring and jacking operations as well as the vertical loading imposed on the pipe after installation and that it provides a smooth, non-obstructing joint in the interior of the pipe.
11. When the pipe is installed in open trench, bed and backfill according to Section 701.
12. The line and grade from the pipe's final position, as shown on plans, may vary no more than 2 percent in lateral alignment and one percent in vertical grade. Ensure that the final grade of the flow line is in the direction indicated on the Plans.
13. Use a cutting edge around the head end. Extend it a short distance beyond the pipe end with inside angles or lugs to keep the cutting edge from slipping back into the pipe.
14. Once the pipe installation begins, proceed with the operation without interruption to prevent the pipe from becoming firmly set in the embankment.
15. Remove and replace pipe damaged in jacking operations.
16. After completing the installation, backfill the excavated pits and trenches with flowable fill according to Section 601.03.03 B) 5 a) if the pit is in median area where it will have pavement over it.

**4.0 MEASUREMENT.** The Department will measure the completed length of Bore and Jacked pipe through the flowline from end to end in linear feet. The Department will not measure pressure grouting voids or removal and replacement of pipe damaged in jacking operations for payment and will consider it incidental to Bore and Jack. When abandoning a bore hole due to mechanical malfunction, improper alignment, or other problems due to construction operations, the Department will not measure the backfill and relocation for payment and will consider it incidental to this item of work. When abandoning a bore hole due to an unforeseen physical obstruction or situation, the Department will measure the work according to a negotiated supplemental agreement.

**5.0 PAYMENT.** The Department will make payment for the completed and accepted quantities under the following:

11E

<u>Code</u>	<u>Pay Item</u>	<u>Pay Unit</u>
----	Bore and Jack, Size Pipe	Linear Foot

The Department will consider payment as full compensation for all materials, earthwork, shoring, pipe and work required under this section.

June 15, 2012

## SPECIAL NOTE FOR TURF REINFORCING MAT

**1.0 DESCRIPTION.** Install turf reinforcement mat at locations specified in the Contract or as the Engineer directs. Section references herein are to the Department's 2019 Standard Specifications for Road and Bridge Construction.

### 2.0 MATERIALS.

**2.1 Turf Reinforcement Mat (TRM).** Use a Turf Reinforcement Mat defined as permanent rolled erosion control product composed of non-degradable synthetic fibers, filaments, nets, wire mesh and/or other elements, processed into a three-dimensional matrix of sufficient thickness and from the Department's List of Approved Materials. Mats must be 100% UV stabilized materials. For TRMs containing degradable components, all physical property values must be obtained on the non-degradable portion of the matting exclusively. Ensure product labels clearly show the manufacturer or supplier name, style name, and roll number. Ensure labeling, shipment and storage follows ASTM D-4873. The Department will require manufacturer to provide TRMs that are machine constructed web of mechanically or melt bonded nondegradable fibers entangled to form a three dimensional matrix. The Department will require all long term performance property values in table below to be based on non degradable portion of the matting alone. Approved methods include polymer welding, thermal or polymer fusion, or placement of fibers between two high strength biaxially oriented nets mechanically bound by parallel stitching with polyolefin thread. Ensure that mats designated in the plans as Type 4 mats, are not to be manufactured from discontinuous or loosely held together by stitching or glued netting or composites. Type 4 mats shall be composed of geosynthetic matrix that exhibits a very high interlock and reinforcement capacities with both soil and root systems and with high tensile modulus. The Department will require manufacturer to use materials chemically and biologically inert to the natural soil environments conditions. Ensure the blanket is smolder resistant without the use of chemical additives. When stored, maintain the protective wrapping and elevate the mats off the ground to protect them from damage. The Department will not specify these materials for use in heavily acidic coal seam areas or other areas with soil problems that would severally limit vegetation growth.

- A) Dimensions. Ensure TRMs are furnished in strips with a minimum width of 4 feet and length of 50 feet.
- B) Weight. Ensure that all mat types have a minimum mass per unit area of 7 ounces per square yard according to ASTM D 6566.
- C) Performance Testing: The Department will require AASHTO's NTPEP index testing. The Department will also require the manufacturer to perform internal MARV testing at a Geosynthetic Accreditation Institute – Laboratory Accreditation Program (GAI-LAP) accredited laboratory for tensile strength, tensile elongation, mass per unit area, and thickness once every 24,000 yds of production or whatever rate is required to ensure 97.7% confidence under ASTM D4439& 4354. The Department will require Full scale testing for slope and channel applications shear stress shall be done under ASTM D 6459, ASTM D 6460-07 procedures.

### 2.2 Classifications

The basis for selection of the type of mat required will be based on the long term shear stress level of the mat of the channel in question or the degree of slope to protect and will be designated in the contract. The Type 4 mats are to be used at structural backfills protecting critical

structures, utility cuts, areas where vehicles may be expected to traverse the mat, channels with large heavy drift, and where higher factors of safety, very steep slopes and/or durability concerns are needed as determined by project team and designer and will be specified in the plans by designer.

Turf Reinforcement Matting					
Properties <sup>1</sup>	Type 1	Type 2	Type 3	Type 4	Test Method
Minimum tensile Strength lbs/ft	125	150	175	3000 by 1500	ASTM D6818 <sup>2</sup>
UV stability (minimum % tensile retention)	80	80	80	90	ASTM D4355 <sup>3</sup> (1000-hr exposure)
Minimum thickness (inches)	0.25	0.25	0.25	0.40	ASTM D6525
Slopes applications	2H:1V or flatter	1.5H:1V or flatter	1H:1V or flatter	1 H: 1V or greater	
Shear stress lbs/ft <sup>2</sup> Channel applications	6.0 <sup>4</sup>	8.0 <sup>4</sup>	10.0 <sup>4</sup>	12.0 <sup>4</sup>	ASTM D6459 ASTM D6460-07

<sup>1</sup> For TRMs containing degradable components, all physical property values must be obtained on the non-degradable portion of the matting alone.

<sup>2</sup>Minimum Average Roll Values for tensile strength of sample material machine direction.

<sup>3</sup>Tensile Strength percentage retained after stated 1000 hr duration of exposure under ASTM D4355 testing. Based on nondegradable components exclusively.

<sup>4</sup>Maximum permissible shear design values based on short-term (0.5 hr) vegetated data obtained by full scale flume testing ASTM D6459, D6460-07. Based on nondegradable components exclusively. Testing will be done at Independent Hydraulics Facility such as Colorado State University hydraulics laboratory, Utah State University hydraulics laboratory, Texas Transportation Institute (TTI) hydraulics and erosion control laboratory.

### 2.3 Quality Assurance Sampling, Testing, and Acceptance

- A) Provide TRM listed on the Department’s List of Approved Materials. Prior to inclusion on the LAM, the manufacturer of TRM must meet the physical and performance criteria as outlined in the specification and submit a Letter Certifying compliance of the product under the above ASTM testing procedures and including a copy of report from Full Scale Independent Hydraulics Facility that Fully Vegetated Shear Stress meets shear stress requirements tested under D6459 and D6460-07.
- B) Contractors will provide a Letter of Certification from Manufacturer stating the product name, manufacturer, and that the product MARV product unit testing results meets Department criteria. Provide Letters once per project and for each product.
- C) Acceptance shall be in accordance with ASTM D-4759 based on testing performed by a Geosynthetic Accreditation Institute – Laboratory Accreditation Program (GAI-LAP) accredited laboratory using Procedure A of ASTM D-4354.

Current mats meeting the above criteria are shown on the Department's List of Approved Materials.

**2.4 Fasteners.** When the mat manufacturer does not specify a specific fastener, use steel wire U-shaped staples with a minimum diameter of 0.09 inches (11 gauge), a minimum width of one inch and a minimum length of 12 inches. Use a heavier gauge when working in rocky or clay soils and longer lengths in sandy soils as directed by Engineer or Manufacturer's Representative. Provide staples with colored tops when requested by the Engineer.

**3.0 CONSTRUCTION.** When requested by the Engineer, provide a Manufacturer's Representative on-site to oversee and approve the initial installation of the mat. When requested by the Engineer, provide a letter from the Manufacturer approving the installation. When there is a conflict between the Department's criteria and the Manufacturer's criteria, construct using the more restrictive. The Engineer and Manufacturer's Representative must approve all alternate installation methods prior to execution. Construct according to the Manufacturer's recommendations and the following as minimum installation technique:

**3.1 Site Preparation.** Grade areas to be treated with matting and compact. Remove large rocks, soil clods, vegetation, roots, and other sharp objects that could keep the mat from intimate contact with subgrade. Prepare seedbed by loosening the top 2 to 3 inch of soil.

**3.2 Installation.** Install mats according to Standard Drawing Sepias "Turf Mat Channel Installation" and "Turf Mat Slope Installation." Install mats at the specified elevation and alignment. Anchor the mats with staples with a minimum length of 12 inches. Use longer anchors for installations in sandy, loose, or wet soils as directed by the Engineer or Manufacturer's Representative. The mat should be in direct contact with the soil surface.

**4.0 MEASUREMENT.** The Department will measure the quantity of Turf Reinforcement Mat by the square yard of surface covered. The Department will not measure preparation of the bed, providing a Manufacturer's Representative, topsoil, or seeding for payment and will consider them incidental to the Turf Reinforcement Mat. The Department will not measure any reworking of slopes or channels for payment as it is considered corrective work and incidental to the Turf Reinforcement Mat. Seeding and protection will be an incidental item.

**5.0 PAYMENT.** The Department will make payment for the completed and accepted quantities under the following:

<u>Code</u>	<u>Pay Item</u>	<u>Pay Unit</u>
23274EN11F	Turf Reinforcement Mat 1	Square Yard
23275EN11F	Turf Reinforcement Mat 2	Square Yard
23276EN11F	Turf Reinforcement Mat 3	Square Yard
23277EN11F	Turf Reinforcement Mat 4	Square Yard

June 15, 2012



### SPECIAL NOTE FOR BARCODE LABEL ON PERMANENT SIGNS

**1.0 DESCRIPTION.** Install barcode label on sheeting signs. Section references herein are to the Department’s Standard Specifications for Road and Bridge Construction, current edition.

**2.0 MATERIALS.** The Department will provide the Contractor with a 2 inch x 1 inch foil barcode label for each permanent sheeting sign. A unique number will be assigned to each barcode label.

The Contractor shall contact the Operations and Pavement Management Branch in the Division of Maintenance at (502) 564-4556 to obtain the barcode labels.

**3.0 CONSTRUCTION.** Apply foil barcode label in the lower right quadrant of the sign back. Signs where the bottom edge is not parallel to the ground, the lowest corner of the sign shall serve as the location to place the barcode label. The barcode label shall be placed no less than one-inch and no more than three inches from any edge of the sign. The barcode must be placed so that the sign post does not cover the barcode label.

Barcodes shall be applied in an indoor setting with a minimum air temperature of 50°F or higher. Prior to application of the barcode label, the back of the sign must be clean and free of dust, oil, etc. If the sign is not clean, an alcohol swab shall be used to clean the area. The area must be allowed to dry prior to placement of the barcode label.

Data for each sign shall include the barcode number, MUTCD reference number, sheeting manufacturer, sheeting type, manufacture date, color of primary reflective surface, installation date, latitude and longitude using the North American Datum of 1983 (NAD83) or the State Plane Coordinates using an x and y ordinate of the installed location.

Data should be provided electronically on the TC 71-229 Sign Details Information and TC 71-230 Sign Assembly Information forms. The Contractor may choose to present the data in a different format provided that the information submitted to the Department is equivalent to the information required on the Department TC forms. The forms must be submitted in electronic format regardless of which type of form is used. The Department will not accept PDF or handwritten forms. These completed forms must be submitted to the Department prior to final inspection of the signs. The Department will not issue formal acceptance for the project until the TC 71-229 and TC-230 electronic forms are completed for all signs and sign assemblies on the project.

**4.0 MEASUREMENT.** The Department will measure all work required for the installation of the barcode label and all work associated with completion and submission of the sign inventory data (TC 71-229 and TC 71-230).

The installation of the permanent sign will be measured in accordance to Section 715.

**5.0 PAYMENT.** The Department will make payment for the completed and accepted quantities under the following:

<u>Code</u>	<u>Pay Item</u>	<u>Pay Unit</u>
24631EC	Barcode Sign Inventory	Each

The Department will not make payment for this item until all barcodes are installed and sign inventory is complete on every permanent sign installed on the project. The Department will make payment for installation of the permanent sign in accordance to Section 715. The Department will consider payment as full compensation for all work required under this special note.

### One Sign Post



↑  
2" Wide Post

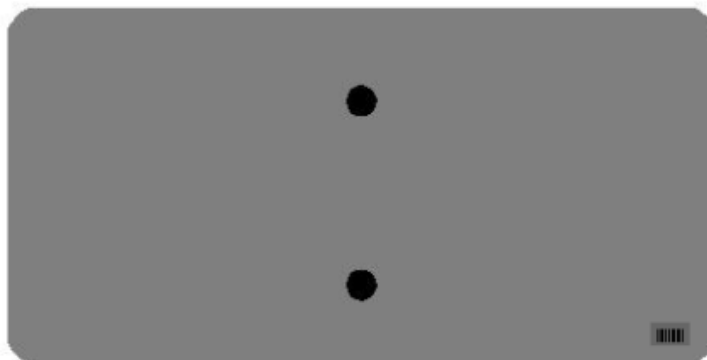
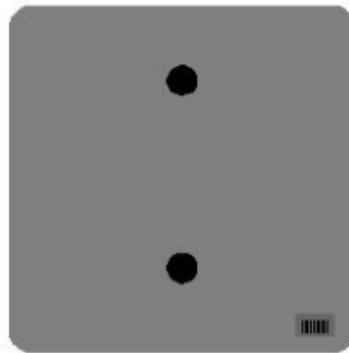

### One Sign Post

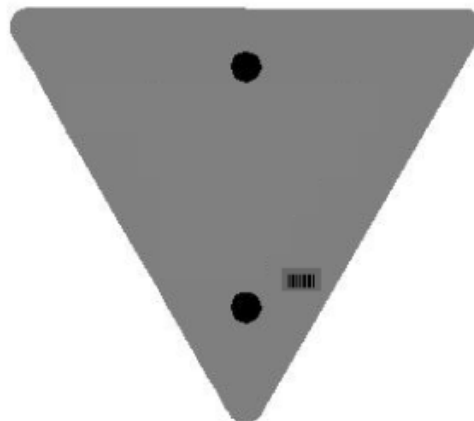
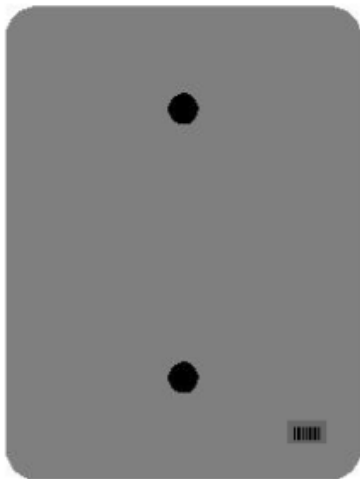
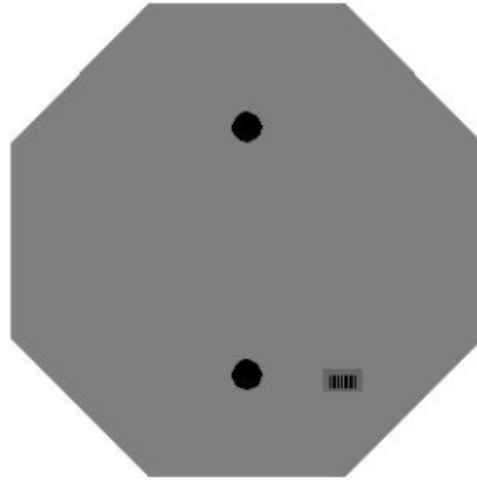
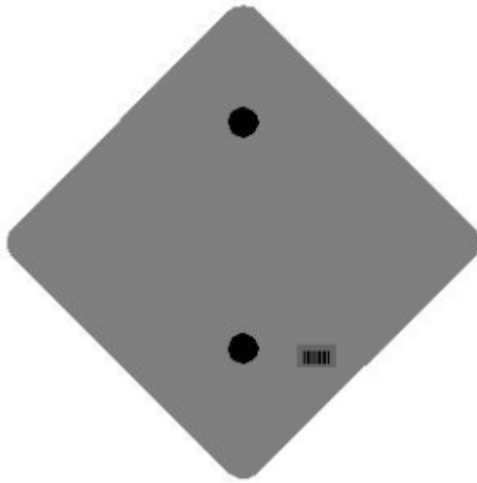

### One Sign Post

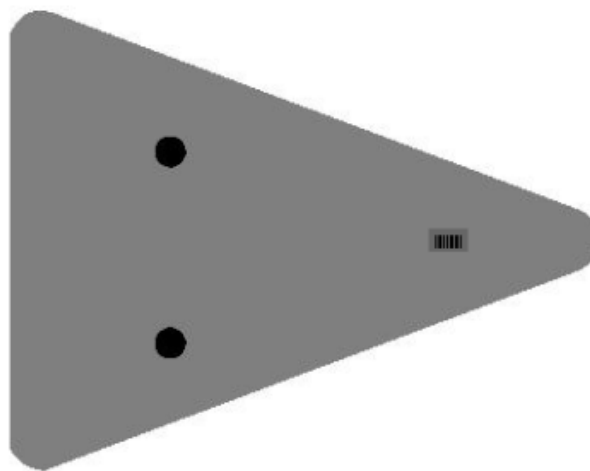
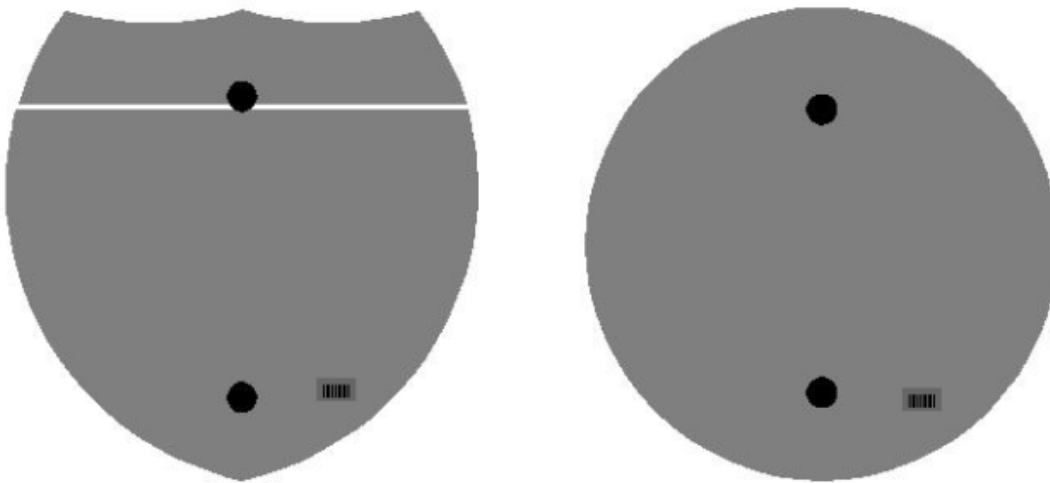

### Double Sign Post

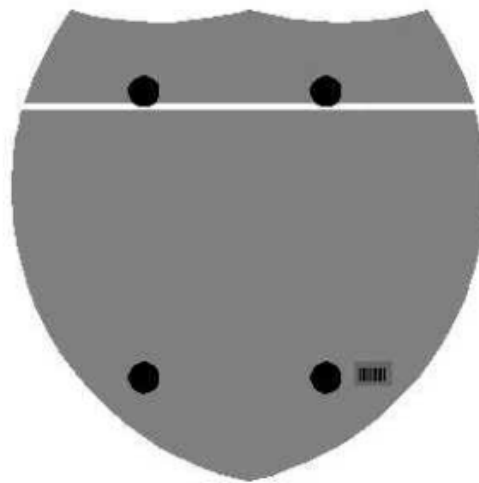

Interstate  
Shield

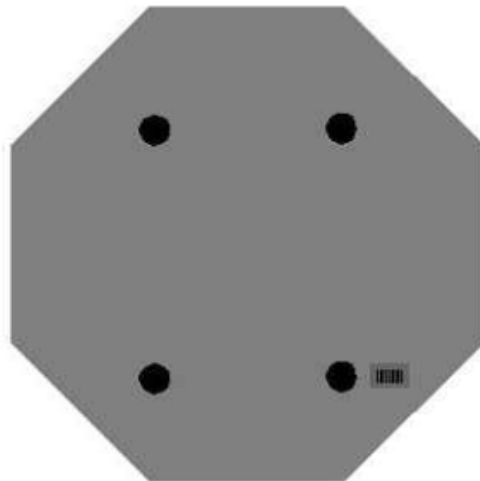

48" Stop

### 2 Post Signs



↑  
2" Wide Post

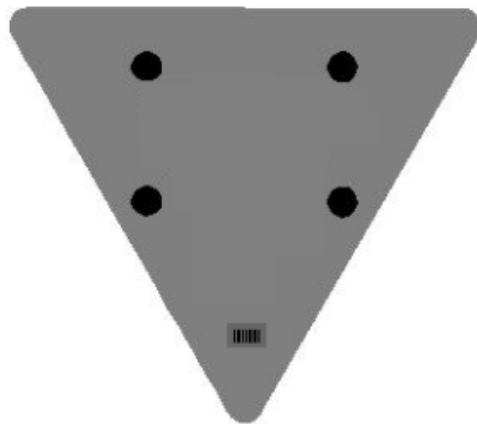

### **SPECIAL PROVISION FOR EMBANKMENT AT BRIDGE END BENT STRUCTURES**

This Special Provision will apply when indicated on the plans or in the proposal. Section references herein are to the Department's Standard Specifications for Road and Bridge Construction, Current Edition.

**1.0 DESCRIPTION.** Construct a soil, granular, or rock embankment with soil, granular or cohesive pile core and place structure granular backfill, as the Plans require. Construct the embankment according to the requirements of this Special Provision, the Plans, Standard Drawing RGX 100 and 105, and the Standard Specifications, Current Edition.

#### **2.0 MATERIALS.**

**2.1 Granular Embankment.** Conform to Subsection 805.10. When Granular Embankment materials are erodible or unstable according to Subsection 805.03.04, use the Special Construction Methods found in 3.2 of the Special Provision.

**2.2 Rock Embankment.** Provide durable rock from roadway excavation that consists principally of Unweathered Limestone, Durable Shale (SDI equal to or greater than 95 according to KM 64-513), or Durable Sandstone.

**2.3 Pile Core.** Provide a pile core in the area of the embankments where deep foundations are to be installed unless otherwise specified. The Pile Core is the zone indicated on Standard Drawings RGX 100 and 105 designated as Pile Core. Material control of the pile core area during embankment construction is always required. Proper Pile Core construction is required for installation of foundation elements such as drilled or driven piles or drilled shafts. The type of material used to construct the pile core is as directed in the plans or below. Typically, the pile core area will be constructed from the same material used to construct the surrounding embankment. Pile Core can be classified as one of three types:

**A) Pile Core -** Conform to Section 206 of the Standard Specifications. Provide pile core material consisting of the same material as the adjacent embankment except the material in the pile core area shall be free of boulders or particle sizes larger than 4 inches in any dimension or any other obstructions that may hinder pile driving operations. If the pile core material hinders pile driving operations, take the appropriate means necessary to reach the required pile tip elevation, at no expense to the Department.

**B) Granular Pile Core.** Granular pile core is required only when specified in the plans. Select a gradation of durable rock to facilitate pile driving that conforms to Subsection 805.11. If granular pile core material hinders pile driving operations, take appropriate means necessary to reach the required pile tip elevation, at no expense to the Department.

**C) Cohesive Pile Core.** Cohesive Pile Core is required only when specified in the plans. Conform to Section 206 of the Standard Specifications and use soil with at least 50 percent passing a No. 4 sieve having a minimum Plasticity Index (PI) of 10. In addition, keep the cohesive pile core free of boulders, larger than 4 inches in any dimension, or any other obstructions, which would interfere with drilling operations. If cohesive pile core material interferes with drilling operations, take appropriate means necessary to maintain

excavation stability, at no expense to the Department.

**2.4 Structure Granular Backfill.** Conform to Subsection 805.11

**2.5 Geotextile Fabric.** Conform to Type I or Type IV in Section 214 and 843.

### **3.0 CONSTRUCTION.**

**3.1 General.** Construct roadway embankments at end bents according to Section 206 and in accordance with the Special Provision, the Plans, and Standard Drawings for the full embankment section. In some instances, granular or rock embankment will be required for embankment construction for stability purposes, but this special provision does not prevent the use of soil when appropriate. Refer to the plans for specific details regarding material requirements for embankment construction.

Place and compact the pile core and structure granular backfill according to the applicable density requirements for the project. If the embankment and pile core are dissimilar materials (i.e., a granular pile core is used with a soil embankment or a cohesive pile core is used with a granular embankment), a Geotextile Fabric, Type IV, will be required between the pile core and embankment in accordance with Sections 214 and 843 of the Standard Specifications.

When granular or rock embankment is required for embankment construction, conform to the general requirements of Subsection 206.03.02 B. In addition, place the material in no greater than 2-foot loose lifts and compact with a vibrating smooth wheel roller capable of producing a minimum centrifugal force of 15 tons. Apply these requirements to the full width of the embankment for a distance of half the embankment height or 50 feet, whichever is greater, as shown on Standard Drawing RGX-105.

When using granular pile core, install 8-inch perforated underdrain pipe at or near the elevation of the original ground in the approximate locations depicted on the standard drawing, and as the Engineer directs, to ensure positive drainage of the embankment. Wrap the perforated pipe with a fabric of a type recommended by the pipe manufacturer.

After constructing the embankment, excavate for the end bent cap, drive piling, install shafts or other foundation elements, place the mortar bed, construct the end bent, and complete the embankment to finish grade according to the construction sequence shown on the Plans or Standard Drawings and as specified hereinafter.

Certain projects may require widening of existing embankments and the removal of substructures. Construct embankment according to the plans. Substructure removal shall be completed according to the plans and Section 203. Excavation may be required at the existing embankment in order to place the structure granular backfill as shown in the Standard Drawings.

After piles are driven or shafts installed (see design drawings), slope the bottom of the excavation towards the ends of the trench as noted on the plans for drainage. Using a separate pour, place concrete mortar, or any class concrete, to provide a base for forming and placing the cap. Place side forms for the end bent after the mortar has set sufficiently to support workmen and forms without being disturbed.

Install 4-inch perforated pipe in accordance with the plans and Standard Drawings. In the event slope protection extends above the elevation of the perforated pipe, extend the pipe through the slope protection.

After placing the end bent cap and achieving required concrete cylinder strengths, remove adjacent forms and fill the excavation with compacted structure granular backfill material (maximum 1' loose lifts) to the level of the berm prior to placing beams for the bridge. Place Type IV geotextile fabric between embankment material and structure granular backfill. After completing the end bent backwall, or after completing the span end



wall, place the compacted structure granular backfill (maximum 1' loose lifts) to subgrade elevation. If the original excavation is enlarged, fill the entire volume with compacted structure granular backfill (maximum 1' loose lifts) at no expense to the Department. Do not place backfill before removing adjacent form work. Place structure granular backfill material in trench ditches at the ends of the excavation. Place Geotextile Fabric, Type IV over the surface of the compacted structure granular backfill prior to placing aggregate base course.

Tamp the backfill with hand tampers, pneumatic tampers, or other means approved by the Engineer. Thoroughly compact the backfill under the overhanging portions of the structure to ensure that the backfill is in intimate contact with the sides of the structure.

Do not apply seeding, sodding, or other vegetation to the exposed granular embankment.

**3.2 Special Construction Methods.** Erodible or unstable materials may erode even when protected by riprap or channel lining; use the special construction method described below when using these materials.

Use fine aggregates or friable sandstone granular embankment at "dry land" structures only. Do not use them at stream crossings or locations subject to flood waters.

For erodible or unstable materials having 50 percent or more passing the No. 4 sieve, protect with geotextile fabric. Extend the fabric from the original ground to the top of slope over the entire area of the embankment slopes on each side of, and in front of, the end bent. Cover the fabric with at least 12 inches of non-erodible material.

For erodible or unstable materials having less than 50 percent passing a No. 4 sieve, cover with at least 12 inches of non-erodible material.

Where erodible or unstable granular embankment will be protected by riprap or channel lining, place Type IV geotextile fabric between the embankment and the specified slope protection.

#### **4.0 MEASUREMENT.**

**4.1 Granular Embankment.** The Department will measure the quantity in cubic yards using the plan quantity, increased or decreased by authorized adjustments as specified in Section 204. The Department will not measure for payment any Granular Embankment that is not called for in the plans.

The Department will not measure for payment any special construction caused by using erodible or unstable materials and will consider it incidental to the Granular Embankment regardless of whether the erodible or unstable material was specified or permitted.

**4.2 Rock Embankment.** The Department will not measure for payment any rock embankment and will consider it incidental to roadway excavation or embankment in place, as applicable. Rock embankments will be constructed using granular embankment on projects where there is no available rock present within the excavation limits of the project.

**4.3 Pile Core.** Pile core will be measured and paid under roadway excavation or embankment in place, as applicable. The Department will not measure the pile core for separate payment. The Department will not measure for payment the 8-inch perforated underdrain pipe and will consider it incidental to the Pile Core.

**4.4 Structure Granular Backfill.** The Department will measure the quantity in cubic yards using the plan quantity, increased or decreased by authorized adjustments as specified in Section 204. The Department will not measure any additional material required for backfill outside the limits shown on the Plans and Standard Drawings for payment and will

consider it incidental to the work.

The Department will not measure for payment the 4-inch perforated underdrain pipe and will consider it incidental to the Structure Granular Backfill.

**4.5 Geotextile Fabric.** The Department will not measure the quantity of fabric used for separating dissimilar materials when constructing the embankment and pile core and will consider it incidental to embankment construction.

The Department will not measure for payment the Geotextile Fabric used to separate the Structure Granular Backfill from the embankment and aggregate base course and will consider it incidental to Structure Granular Backfill.

The Department will not measure for payment the Geotextile Fabric required for construction with erodible or unstable materials and will consider it incidental to embankment construction.

**4.6 End Bent.** The Department will measure the quantities according to the Contract. The Department will not measure furnishing and placing the 2-inch mortar or concrete bed for payment and will consider it incidental to the end bent construction.

**4.7 Structure Excavation.** The Department will not measure structure excavation on new embankments for payment and will consider it incidental to the Structure Granular Backfill or Concrete as applicable.

**5.0 PAYMENT.** The Department will make payment for the completed and accepted quantities under the following:

<u>Code</u>	<u>Pay Item</u>	<u>Pay Unit</u>
02223	Granular Embankment	Cubic Yards
02231	Structure Granular Backfill	Cubic Yards

The Department will consider payment as full compensation for all work required in this provision.

September 16, 2016

## **PART III**

### **EMPLOYMENT, WAGE AND RECORD REQUIREMENTS**

FHWA-1273 -- Revised May 1, 2012

**REQUIRED CONTRACT PROVISIONS  
FEDERAL-AID CONSTRUCTION CONTRACTS**

- I. General
- II. Nondiscrimination
- III. Nonsegregated Facilities
- IV. Davis-Bacon and Related Act Provisions
- V. Contract Work Hours and Safety Standards Act Provisions
- VI. Subletting or Assigning the Contract
- VII. Safety: Accident Prevention
- VIII. False Statements Concerning Highway Projects
- IX. Implementation of Clean Air Act and Federal Water Pollution Control Act
- X. Compliance with Governmentwide Suspension and Debarment Requirements
- XI. Certification Regarding Use of Contract Funds for Lobbying

3. A breach of any of the stipulations contained in these Required Contract Provisions may be sufficient grounds for withholding of progress payments, withholding of final payment, termination of the contract, suspension / debarment or any other action determined to be appropriate by the contracting agency and FHWA.

4. Selection of Labor: During the performance of this contract, the contractor shall not use convict labor for any purpose within the limits of a construction project on a Federal-aid highway unless it is labor performed by convicts who are on parole, supervised release, or probation. The term Federal-aid highway does not include roadways functionally classified as local roads or rural minor collectors.

**ATTACHMENTS**

A. Employment and Materials Preference for Appalachian Development Highway System or Appalachian Local Access Road Contracts (included in Appalachian contracts only)

**II. NONDISCRIMINATION**

The provisions of this section related to 23 CFR Part 230 are applicable to all Federal-aid construction contracts and to all related construction subcontracts of \$10,000 or more. The provisions of 23 CFR Part 230 are not applicable to material supply, engineering, or architectural service contracts.

**I. GENERAL**

1. Form FHWA-1273 must be physically incorporated in each construction contract funded under Title 23 (excluding emergency contracts solely intended for debris removal). The contractor (or subcontractor) must insert this form in each subcontract and further require its inclusion in all lower tier subcontracts (excluding purchase orders, rental agreements and other agreements for supplies or services).

In addition, the contractor and all subcontractors must comply with the following policies: Executive Order 11246, 41 CFR 60, 29 CFR 1625-1627, Title 23 USC Section 140, the Rehabilitation Act of 1973, as amended (29 USC 794), Title VI of the Civil Rights Act of 1964, as amended, and related regulations including 49 CFR Parts 21, 26 and 27; and 23 CFR Parts 200, 230, and 633.

The applicable requirements of Form FHWA-1273 are incorporated by reference for work done under any purchase order, rental agreement or agreement for other services. The prime contractor shall be responsible for compliance by any subcontractor, lower-tier subcontractor or service provider.

The contractor and all subcontractors must comply with: the requirements of the Equal Opportunity Clause in 41 CFR 60-1.4(b) and, for all construction contracts exceeding \$10,000, the Standard Federal Equal Employment Opportunity Construction Contract Specifications in 41 CFR 60-4.3.

Form FHWA-1273 must be included in all Federal-aid design-build contracts, in all subcontracts and in lower tier subcontracts (excluding subcontracts for design services, purchase orders, rental agreements and other agreements for supplies or services). The design-builder shall be responsible for compliance by any subcontractor, lower-tier subcontractor or service provider.

Note: The U.S. Department of Labor has exclusive authority to determine compliance with Executive Order 11246 and the policies of the Secretary of Labor including 41 CFR 60, and 29 CFR 1625-1627. The contracting agency and the FHWA have the authority and the responsibility to ensure compliance with Title 23 USC Section 140, the Rehabilitation Act of 1973, as amended (29 USC 794), and Title VI of the Civil Rights Act of 1964, as amended, and related regulations including 49 CFR Parts 21, 26 and 27; and 23 CFR Parts 200, 230, and 633.

Contracting agencies may reference Form FHWA-1273 in bid proposal or request for proposal documents, however, the Form FHWA-1273 must be physically incorporated (not referenced) in all contracts, subcontracts and lower-tier subcontracts (excluding purchase orders, rental agreements and other agreements for supplies or services related to a construction contract).

The following provision is adopted from 23 CFR 230, Appendix A, with appropriate revisions to conform to the U.S. Department of Labor (US DOL) and FHWA requirements.

2. Subject to the applicability criteria noted in the following sections, these contract provisions shall apply to all work performed on the contract by the contractor's own organization and with the assistance of workers under the contractor's immediate superintendence and to all work performed on the contract by piecework, station work, or by subcontract.

**1. Equal Employment Opportunity:** Equal employment opportunity (EEO) requirements not to discriminate and to take affirmative action to assure equal opportunity as set forth under laws, executive orders, rules, regulations (28 CFR 35, 29 CFR 1630, 29 CFR 1625-1627, 41 CFR 60 and 49 CFR 27) and orders of the Secretary of Labor as modified by the provisions prescribed herein, and imposed pursuant to 23 U.S.C. 140 shall constitute the EEO and specific affirmative action standards for the contractor's project activities under

this contract. The provisions of the Americans with Disabilities Act of 1990 (42 U.S.C. 12101 et seq.) set forth under 28 CFR 35 and 29 CFR 1630 are incorporated by reference in this contract. In the execution of this contract, the contractor agrees to comply with the following minimum specific requirement activities of EEO:

a. The contractor will work with the contracting agency and the Federal Government to ensure that it has made every good faith effort to provide equal opportunity with respect to all of its terms and conditions of employment and in their review of activities under the contract.

b. The contractor will accept as its operating policy the following statement:

"It is the policy of this Company to assure that applicants are employed, and that employees are treated during employment, without regard to their race, religion, sex, color, national origin, age or disability. Such action shall include: employment, upgrading, demotion, or transfer; recruitment or recruitment advertising; layoff or termination; rates of pay or other forms of compensation; and selection for training, including apprenticeship, pre-apprenticeship, and/or on-the-job training."

**2. EEO Officer:** The contractor will designate and make known to the contracting officers an EEO Officer who will have the responsibility for and must be capable of effectively administering and promoting an active EEO program and who must be assigned adequate authority and responsibility to do so.

**3. Dissemination of Policy:** All members of the contractor's staff who are authorized to hire, supervise, promote, and discharge employees, or who recommend such action, or who are substantially involved in such action, will be made fully cognizant of, and will implement, the contractor's EEO policy and contractual responsibilities to provide EEO in each grade and classification of employment. To ensure that the above agreement will be met, the following actions will be taken as a minimum:

a. Periodic meetings of supervisory and personnel office employees will be conducted before the start of work and then not less often than once every six months, at which time the contractor's EEO policy and its implementation will be reviewed and explained. The meetings will be conducted by the EEO Officer.

b. All new supervisory or personnel office employees will be given a thorough indoctrination by the EEO Officer, covering all major aspects of the contractor's EEO obligations within thirty days following their reporting for duty with the contractor.

c. All personnel who are engaged in direct recruitment for the project will be instructed by the EEO Officer in the contractor's procedures for locating and hiring minorities and women.

d. Notices and posters setting forth the contractor's EEO policy will be placed in areas readily accessible to employees, applicants for employment and potential employees.

e. The contractor's EEO policy and the procedures to implement such policy will be brought to the attention of employees by means of meetings, employee handbooks, or other appropriate means.

**4. Recruitment:** When advertising for employees, the contractor will include in all advertisements for employees the notation: "An Equal Opportunity Employer." All such advertisements will be placed in publications having a large circulation among minorities and women in the area from which the project work force would normally be derived.

a. The contractor will, unless precluded by a valid bargaining agreement, conduct systematic and direct recruitment through public and private employee referral sources likely to yield qualified minorities and women. To meet this requirement, the contractor will identify sources of potential minority group employees, and establish with such identified sources procedures whereby minority and women applicants may be referred to the contractor for employment consideration.

b. In the event the contractor has a valid bargaining agreement providing for exclusive hiring hall referrals, the contractor is expected to observe the provisions of that agreement to the extent that the system meets the contractor's compliance with EEO contract provisions. Where implementation of such an agreement has the effect of discriminating against minorities or women, or obligates the contractor to do the same, such implementation violates Federal nondiscrimination provisions.

c. The contractor will encourage its present employees to refer minorities and women as applicants for employment. Information and procedures with regard to referring such applicants will be discussed with employees.

**5. Personnel Actions:** Wages, working conditions, and employee benefits shall be established and administered, and personnel actions of every type, including hiring, upgrading, promotion, transfer, demotion, layoff, and termination, shall be taken without regard to race, color, religion, sex, national origin, age or disability. The following procedures shall be followed:

a. The contractor will conduct periodic inspections of project sites to insure that working conditions and employee facilities do not indicate discriminatory treatment of project site personnel.

b. The contractor will periodically evaluate the spread of wages paid within each classification to determine any evidence of discriminatory wage practices.

c. The contractor will periodically review selected personnel actions in depth to determine whether there is evidence of discrimination. Where evidence is found, the contractor will promptly take corrective action. If the review indicates that the discrimination may extend beyond the actions reviewed, such corrective action shall include all affected persons.

d. The contractor will promptly investigate all complaints of alleged discrimination made to the contractor in connection with its obligations under this contract, will attempt to resolve such complaints, and will take appropriate corrective action within a reasonable time. If the investigation indicates that the discrimination may affect persons other than the complainant, such corrective action shall include such other persons. Upon completion of each investigation, the contractor will inform every complainant of all of their avenues of appeal.

**6. Training and Promotion:**

a. The contractor will assist in locating, qualifying, and increasing the skills of minorities and women who are

applicants for employment or current employees. Such efforts should be aimed at developing full journey level status employees in the type of trade or job classification involved.

b. Consistent with the contractor's work force requirements and as permissible under Federal and State regulations, the contractor shall make full use of training programs, i.e., apprenticeship, and on-the-job training programs for the geographical area of contract performance. In the event a special provision for training is provided under this contract, this subparagraph will be superseded as indicated in the special provision. The contracting agency may reserve training positions for persons who receive welfare assistance in accordance with 23 U.S.C. 140(a).

c. The contractor will advise employees and applicants for employment of available training programs and entrance requirements for each.

d. The contractor will periodically review the training and promotion potential of employees who are minorities and women and will encourage eligible employees to apply for such training and promotion.

**7. Unions:** If the contractor relies in whole or in part upon unions as a source of employees, the contractor will use good faith efforts to obtain the cooperation of such unions to increase opportunities for minorities and women. Actions by the contractor, either directly or through a contractor's association acting as agent, will include the procedures set forth below:

a. The contractor will use good faith efforts to develop, in cooperation with the unions, joint training programs aimed toward qualifying more minorities and women for membership in the unions and increasing the skills of minorities and women so that they may qualify for higher paying employment.

b. The contractor will use good faith efforts to incorporate an EEO clause into each union agreement to the end that such union will be contractually bound to refer applicants without regard to their race, color, religion, sex, national origin, age or disability.

c. The contractor is to obtain information as to the referral practices and policies of the labor union except that to the extent such information is within the exclusive possession of the labor union and such labor union refuses to furnish such information to the contractor, the contractor shall so certify to the contracting agency and shall set forth what efforts have been made to obtain such information.

d. In the event the union is unable to provide the contractor with a reasonable flow of referrals within the time limit set forth in the collective bargaining agreement, the contractor will, through independent recruitment efforts, fill the employment vacancies without regard to race, color, religion, sex, national origin, age or disability; making full efforts to obtain qualified and/or qualifiable minorities and women. The failure of a union to provide sufficient referrals (even though it is obligated to provide exclusive referrals under the terms of a collective bargaining agreement) does not relieve the contractor from the requirements of this paragraph. In the event the union referral practice prevents the contractor from meeting the obligations pursuant to Executive Order 11246, as amended, and these special provisions, such contractor shall immediately notify the contracting agency.

**8. Reasonable Accommodation for Applicants / Employees with Disabilities:** The contractor must be familiar

with the requirements for and comply with the Americans with Disabilities Act and all rules and regulations established there under. Employers must provide reasonable accommodation in all employment activities unless to do so would cause an undue hardship.

**9. Selection of Subcontractors, Procurement of Materials and Leasing of Equipment:** The contractor shall not discriminate on the grounds of race, color, religion, sex, national origin, age or disability in the selection and retention of subcontractors, including procurement of materials and leases of equipment. The contractor shall take all necessary and reasonable steps to ensure nondiscrimination in the administration of this contract.

a. The contractor shall notify all potential subcontractors and suppliers and lessors of their EEO obligations under this contract.

b. The contractor will use good faith efforts to ensure subcontractor compliance with their EEO obligations.

**10. Assurance Required by 49 CFR 26.13(b):**

a. The requirements of 49 CFR Part 26 and the State DOT's U.S. DOT-approved DBE program are incorporated by reference.

b. The contractor or subcontractor shall not discriminate on the basis of race, color, national origin, or sex in the performance of this contract. The contractor shall carry out applicable requirements of 49 CFR Part 26 in the award and administration of DOT-assisted contracts. Failure by the contractor to carry out these requirements is a material breach of this contract, which may result in the termination of this contract or such other remedy as the contracting agency deems appropriate.

**11. Records and Reports:** The contractor shall keep such records as necessary to document compliance with the EEO requirements. Such records shall be retained for a period of three years following the date of the final payment to the contractor for all contract work and shall be available at reasonable times and places for inspection by authorized representatives of the contracting agency and the FHWA.

a. The records kept by the contractor shall document the following:

(1) The number and work hours of minority and non-minority group members and women employed in each work classification on the project;

(2) The progress and efforts being made in cooperation with unions, when applicable, to increase employment opportunities for minorities and women; and

(3) The progress and efforts being made in locating, hiring, training, qualifying, and upgrading minorities and women;

b. The contractors and subcontractors will submit an annual report to the contracting agency each July for the duration of the project, indicating the number of minority, women, and non-minority group employees currently engaged in each work classification required by the contract work. This information is to be reported on [Form FHWA-1391](#). The staffing data should represent the project work force on board in all or any part of the last payroll period preceding the end of July. If on-the-job training is being required by special provision, the contractor

will be required to collect and report training data. The employment data should reflect the work force on board during all or any part of the last payroll period preceding the end of July.

**III. NONSEGREGATED FACILITIES**

This provision is applicable to all Federal-aid construction contracts and to all related construction subcontracts of \$10,000 or more.

The contractor must ensure that facilities provided for employees are provided in such a manner that segregation on the basis of race, color, religion, sex, or national origin cannot result. The contractor may neither require such segregated use by written or oral policies nor tolerate such use by employee custom. The contractor's obligation extends further to ensure that its employees are not assigned to perform their services at any location, under the contractor's control, where the facilities are segregated. The term "facilities" includes waiting rooms, work areas, restaurants and other eating areas, time clocks, restrooms, washrooms, locker rooms, and other storage or dressing areas, parking lots, drinking fountains, recreation or entertainment areas, transportation, and housing provided for employees. The contractor shall provide separate or single-user restrooms and necessary dressing or sleeping areas to assure privacy between sexes.

**IV. DAVIS-BACON AND RELATED ACT PROVISIONS**

This section is applicable to all Federal-aid construction projects exceeding \$2,000 and to all related subcontracts and lower-tier subcontracts (regardless of subcontract size). The requirements apply to all projects located within the right-of-way of a roadway that is functionally classified as Federal-aid highway. This excludes roadways functionally classified as local roads or rural minor collectors, which are exempt. Contracting agencies may elect to apply these requirements to other projects.

The following provisions are from the U.S. Department of Labor regulations in 29 CFR 5.5 "Contract provisions and related matters" with minor revisions to conform to the FHWA-1273 format and FHWA program requirements.

**1. Minimum wages**

a. All laborers and mechanics employed or working upon the site of the work, will be paid unconditionally and not less often than once a week, and without subsequent deduction or rebate on any account (except such payroll deductions as are permitted by regulations issued by the Secretary of Labor under the Copeland Act (29 CFR part 3)), the full amount of wages and bona fide fringe benefits (or cash equivalents thereof) due at time of payment computed at rates not less than those contained in the wage determination of the Secretary of Labor which is attached hereto and made a part hereof, regardless of any contractual relationship which may be alleged to exist between the contractor and such laborers and mechanics.

Contributions made or costs reasonably anticipated for bona fide fringe benefits under section 1(b)(2) of the Davis-Bacon Act on behalf of laborers or mechanics are considered wages paid to such laborers or mechanics, subject to the provisions

of paragraph 1.d. of this section; also, regular contributions made or costs incurred for more than a weekly period (but not less often than quarterly) under plans, funds, or programs which cover the particular weekly period, are deemed to be constructively made or incurred during such weekly period. Such laborers and mechanics shall be paid the appropriate wage rate and fringe benefits on the wage determination for the classification of work actually performed, without regard to skill, except as provided in 29 CFR 5.5(a)(4). Laborers or mechanics performing work in more than one classification may be compensated at the rate specified for each classification for the time actually worked therein: Provided, That the employer's payroll records accurately set forth the time spent in each classification in which work is performed. The wage determination (including any additional classification and wage rates conformed under paragraph 1.b. of this section) and the Davis-Bacon poster (WH-1321) shall be posted at all times by the contractor and its subcontractors at the site of the work in a prominent and accessible place where it can be easily seen by the workers.

b.(1) The contracting officer shall require that any class of laborers or mechanics, including helpers, which is not listed in the wage determination and which is to be employed under the contract shall be classified in conformance with the wage determination. The contracting officer shall approve an additional classification and wage rate and fringe benefits therefore only when the following criteria have been met:

- (i) The work to be performed by the classification requested is not performed by a classification in the wage determination; and
- (ii) The classification is utilized in the area by the construction industry; and
- (iii) The proposed wage rate, including any bona fide fringe benefits, bears a reasonable relationship to the wage rates contained in the wage determination.

(2) If the contractor and the laborers and mechanics to be employed in the classification (if known), or their representatives, and the contracting officer agree on the classification and wage rate (including the amount designated for fringe benefits where appropriate), a report of the action taken shall be sent by the contracting officer to the Administrator of the Wage and Hour Division, Employment Standards Administration, U.S. Department of Labor, Washington, DC 20210. The Administrator, or an authorized representative, will approve, modify, or disapprove every additional classification action within 30 days of receipt and so advise the contracting officer or will notify the contracting officer within the 30-day period that additional time is necessary.

(3) In the event the contractor, the laborers or mechanics to be employed in the classification or their representatives, and the contracting officer do not agree on the proposed classification and wage rate (including the amount designated for fringe benefits, where appropriate), the contracting officer shall refer the questions, including the views of all interested parties and the recommendation of the contracting officer, to the Wage and Hour Administrator for determination. The Wage and Hour Administrator, or an authorized representative, will issue a determination within 30 days of receipt and so advise the contracting officer or

will notify the contracting officer within the 30-day period that additional time is necessary.

(4) The wage rate (including fringe benefits where appropriate) determined pursuant to paragraphs 1.b.(2) or 1.b.(3) of this section, shall be paid to all workers performing work in the classification under this contract from the first day on which work is performed in the classification.

c. Whenever the minimum wage rate prescribed in the contract for a class of laborers or mechanics includes a fringe benefit which is not expressed as an hourly rate, the contractor shall either pay the benefit as stated in the wage determination or shall pay another bona fide fringe benefit or an hourly cash equivalent thereof.

d. If the contractor does not make payments to a trustee or other third person, the contractor may consider as part of the wages of any laborer or mechanic the amount of any costs reasonably anticipated in providing bona fide fringe benefits under a plan or program, Provided, That the Secretary of Labor has found, upon the written request of the contractor, that the applicable standards of the Davis-Bacon Act have been met. The Secretary of Labor may require the contractor to set aside in a separate account assets for the meeting of obligations under the plan or program.

## 2. Withholding

The contracting agency shall upon its own action or upon written request of an authorized representative of the Department of Labor, withhold or cause to be withheld from the contractor under this contract, or any other Federal contract with the same prime contractor, or any other federally-assisted contract subject to Davis-Bacon prevailing wage requirements, which is held by the same prime contractor, so much of the accrued payments or advances as may be considered necessary to pay laborers and mechanics, including apprentices, trainees, and helpers, employed by the contractor or any subcontractor the full amount of wages required by the contract. In the event of failure to pay any laborer or mechanic, including any apprentice, trainee, or helper, employed or working on the site of the work, all or part of the wages required by the contract, the contracting agency may, after written notice to the contractor, take such action as may be necessary to cause the suspension of any further payment, advance, or guarantee of funds until such violations have ceased.

## 3. Payrolls and basic records

a. Payrolls and basic records relating thereto shall be maintained by the contractor during the course of the work and preserved for a period of three years thereafter for all laborers and mechanics working at the site of the work. Such records shall contain the name, address, and social security number of each such worker, his or her correct classification, hourly rates of wages paid (including rates of contributions or costs anticipated for bona fide fringe benefits or cash equivalents thereof of the types described in section 1(b)(2)(B) of the Davis-Bacon Act), daily and weekly number of hours worked, deductions made and actual wages paid. Whenever the Secretary of Labor has found under 29 CFR 5.5(a)(1)(iv) that the wages of any laborer or mechanic include the amount of any costs reasonably anticipated in providing benefits under a plan or program described in section 1(b)(2)(B) of the Davis-

Bacon Act, the contractor shall maintain records which show that the commitment to provide such benefits is enforceable, that the plan or program is financially responsible, and that the plan or program has been communicated in writing to the laborers or mechanics affected, and records which show the costs anticipated or the actual cost incurred in providing such benefits. Contractors employing apprentices or trainees under approved programs shall maintain written evidence of the registration of apprenticeship programs and certification of trainee programs, the registration of the apprentices and trainees, and the ratios and wage rates prescribed in the applicable programs.

b.(1) The contractor shall submit weekly for each week in which any contract work is performed a copy of all payrolls to the contracting agency. The payrolls submitted shall set out accurately and completely all of the information required to be maintained under 29 CFR 5.5(a)(3)(i), except that full social security numbers and home addresses shall not be included on weekly transmittals. Instead the payrolls shall only need to include an individually identifying number for each employee ( e.g. , the last four digits of the employee's social security number). The required weekly payroll information may be submitted in any form desired. Optional Form WH-347 is available for this purpose from the Wage and Hour Division Web site at <http://www.dol.gov/esa/whd/forms/wh347instr.htm> or its successor site. The prime contractor is responsible for the submission of copies of payrolls by all subcontractors. Contractors and subcontractors shall maintain the full social security number and current address of each covered worker, and shall provide them upon request to the contracting agency for transmission to the State DOT, the FHWA or the Wage and Hour Division of the Department of Labor for purposes of an investigation or audit of compliance with prevailing wage requirements. It is not a violation of this section for a prime contractor to require a subcontractor to provide addresses and social security numbers to the prime contractor for its own records, without weekly submission to the contracting agency..

(2) Each payroll submitted shall be accompanied by a "Statement of Compliance," signed by the contractor or subcontractor or his or her agent who pays or supervises the payment of the persons employed under the contract and shall certify the following:

(i) That the payroll for the payroll period contains the information required to be provided under §5.5 (a)(3)(ii) of Regulations, 29 CFR part 5, the appropriate information is being maintained under §5.5 (a)(3)(i) of Regulations, 29 CFR part 5, and that such information is correct and complete;

(ii) That each laborer or mechanic (including each helper, apprentice, and trainee) employed on the contract during the payroll period has been paid the full weekly wages earned, without rebate, either directly or indirectly, and that no deductions have been made either directly or indirectly from the full wages earned, other than permissible deductions as set forth in Regulations, 29 CFR part 3;

(iii) That each laborer or mechanic has been paid not less than the applicable wage rates and fringe benefits or cash equivalents for the classification of work performed, as specified in the applicable wage determination incorporated into the contract.



(3) The weekly submission of a properly executed certification set forth on the reverse side of Optional Form WH-347 shall satisfy the requirement for submission of the "Statement of Compliance" required by paragraph 3.b.(2) of this section.

(4) The falsification of any of the above certifications may subject the contractor or subcontractor to civil or criminal prosecution under section 1001 of title 18 and section 231 of title 31 of the United States Code.

c. The contractor or subcontractor shall make the records required under paragraph 3.a. of this section available for inspection, copying, or transcription by authorized representatives of the contracting agency, the State DOT, the FHWA, or the Department of Labor, and shall permit such representatives to interview employees during working hours on the job. If the contractor or subcontractor fails to submit the required records or to make them available, the FHWA may, after written notice to the contractor, the contracting agency or the State DOT, take such action as may be necessary to cause the suspension of any further payment, advance, or guarantee of funds. Furthermore, failure to submit the required records upon request or to make such records available may be grounds for debarment action pursuant to 29 CFR 5.12.

#### 4. Apprentices and trainees

##### a. Apprentices (programs of the USDOL).

Apprentices will be permitted to work at less than the predetermined rate for the work they performed when they are employed pursuant to and individually registered in a bona fide apprenticeship program registered with the U.S. Department of Labor, Employment and Training Administration, Office of Apprenticeship Training, Employer and Labor Services, or with a State Apprenticeship Agency recognized by the Office, or if a person is employed in his or her first 90 days of probationary employment as an apprentice in such an apprenticeship program, who is not individually registered in the program, but who has been certified by the Office of Apprenticeship Training, Employer and Labor Services or a State Apprenticeship Agency (where appropriate) to be eligible for probationary employment as an apprentice.

The allowable ratio of apprentices to journeymen on the job site in any craft classification shall not be greater than the ratio permitted to the contractor as to the entire work force under the registered program. Any worker listed on a payroll at an apprentice wage rate, who is not registered or otherwise employed as stated above, shall be paid not less than the applicable wage rate on the wage determination for the classification of work actually performed. In addition, any apprentice performing work on the job site in excess of the ratio permitted under the registered program shall be paid not less than the applicable wage rate on the wage determination for the work actually performed. Where a contractor is performing construction on a project in a locality other than that in which its program is registered, the ratios and wage rates (expressed in percentages of the journeyman's hourly rate) specified in the contractor's or subcontractor's registered program shall be observed.

Every apprentice must be paid at not less than the rate specified in the registered program for the apprentice's level of progress, expressed as a percentage of the journeymen hourly

rate specified in the applicable wage determination. Apprentices shall be paid fringe benefits in accordance with the provisions of the apprenticeship program. If the apprenticeship program does not specify fringe benefits, apprentices must be paid the full amount of fringe benefits listed on the wage determination for the applicable classification. If the Administrator determines that a different practice prevails for the applicable apprentice classification, fringes shall be paid in accordance with that determination.

In the event the Office of Apprenticeship Training, Employer and Labor Services, or a State Apprenticeship Agency recognized by the Office, withdraws approval of an apprenticeship program, the contractor will no longer be permitted to utilize apprentices at less than the applicable predetermined rate for the work performed until an acceptable program is approved.

##### b. Trainees (programs of the USDOL).

Except as provided in 29 CFR 5.16, trainees will not be permitted to work at less than the predetermined rate for the work performed unless they are employed pursuant to and individually registered in a program which has received prior approval, evidenced by formal certification by the U.S. Department of Labor, Employment and Training Administration.

The ratio of trainees to journeymen on the job site shall not be greater than permitted under the plan approved by the Employment and Training Administration.

Every trainee must be paid at not less than the rate specified in the approved program for the trainee's level of progress, expressed as a percentage of the journeyman hourly rate specified in the applicable wage determination. Trainees shall be paid fringe benefits in accordance with the provisions of the trainee program. If the trainee program does not mention fringe benefits, trainees shall be paid the full amount of fringe benefits listed on the wage determination unless the Administrator of the Wage and Hour Division determines that there is an apprenticeship program associated with the corresponding journeyman wage rate on the wage determination which provides for less than full fringe benefits for apprentices. Any employee listed on the payroll at a trainee rate who is not registered and participating in a training plan approved by the Employment and Training Administration shall be paid not less than the applicable wage rate on the wage determination for the classification of work actually performed. In addition, any trainee performing work on the job site in excess of the ratio permitted under the registered program shall be paid not less than the applicable wage rate on the wage determination for the work actually performed.

In the event the Employment and Training Administration withdraws approval of a training program, the contractor will no longer be permitted to utilize trainees at less than the applicable predetermined rate for the work performed until an acceptable program is approved.

c. Equal employment opportunity. The utilization of apprentices, trainees and journeymen under this part shall be in conformity with the equal employment opportunity requirements of Executive Order 11246, as amended, and 29 CFR part 30.

d. Apprentices and Trainees (programs of the U.S. DOT).

Apprentices and trainees working under apprenticeship and skill training programs which have been certified by the Secretary of Transportation as promoting EEO in connection with Federal-aid highway construction programs are not subject to the requirements of paragraph 4 of this Section IV. The straight time hourly wage rates for apprentices and trainees under such programs will be established by the particular programs. The ratio of apprentices and trainees to journeymen shall not be greater than permitted by the terms of the particular program.

**5. Compliance with Copeland Act requirements.** The contractor shall comply with the requirements of 29 CFR part 3, which are incorporated by reference in this contract.

**6. Subcontracts.** The contractor or subcontractor shall insert Form FHWA-1273 in any subcontracts and also require the subcontractors to include Form FHWA-1273 in any lower tier subcontracts. The prime contractor shall be responsible for the compliance by any subcontractor or lower tier subcontractor with all the contract clauses in 29 CFR 5.5.

**7. Contract termination: debarment.** A breach of the contract clauses in 29 CFR 5.5 may be grounds for termination of the contract, and for debarment as a contractor and a subcontractor as provided in 29 CFR 5.12.

**8. Compliance with Davis-Bacon and Related Act requirements.** All rulings and interpretations of the Davis-Bacon and Related Acts contained in 29 CFR parts 1, 3, and 5 are herein incorporated by reference in this contract.

**9. Disputes concerning labor standards.** Disputes arising out of the labor standards provisions of this contract shall not be subject to the general disputes clause of this contract. Such disputes shall be resolved in accordance with the procedures of the Department of Labor set forth in 29 CFR parts 5, 6, and 7. Disputes within the meaning of this clause include disputes between the contractor (or any of its subcontractors) and the contracting agency, the U.S. Department of Labor, or the employees or their representatives.

**10. Certification of eligibility.**

a. By entering into this contract, the contractor certifies that neither it (nor he or she) nor any person or firm who has an interest in the contractor's firm is a person or firm ineligible to be awarded Government contracts by virtue of section 3(a) of the Davis-Bacon Act or 29 CFR 5.12(a)(1).

b. No part of this contract shall be subcontracted to any person or firm ineligible for award of a Government contract by virtue of section 3(a) of the Davis-Bacon Act or 29 CFR 5.12(a)(1).

c. The penalty for making false statements is prescribed in the U.S. Criminal Code, 18 U.S.C. 1001.

**V. CONTRACT WORK HOURS AND SAFETY STANDARDS ACT**

The following clauses apply to any Federal-aid construction contract in an amount in excess of \$100,000 and subject to the overtime provisions of the Contract Work Hours and Safety Standards Act. These clauses shall be inserted in addition to the clauses required by 29 CFR 5.5(a) or 29 CFR 4.6. As used in this paragraph, the terms laborers and mechanics include watchmen and guards.

**1. Overtime requirements.** No contractor or subcontractor contracting for any part of the contract work which may require or involve the employment of laborers or mechanics shall require or permit any such laborer or mechanic in any workweek in which he or she is employed on such work to work in excess of forty hours in such workweek unless such laborer or mechanic receives compensation at a rate not less than one and one-half times the basic rate of pay for all hours worked in excess of forty hours in such workweek.

**2. Violation; liability for unpaid wages; liquidated damages.** In the event of any violation of the clause set forth in paragraph (1.) of this section, the contractor and any subcontractor responsible therefor shall be liable for the unpaid wages. In addition, such contractor and subcontractor shall be liable to the United States (in the case of work done under contract for the District of Columbia or a territory, to such District or to such territory), for liquidated damages. Such liquidated damages shall be computed with respect to each individual laborer or mechanic, including watchmen and guards, employed in violation of the clause set forth in paragraph (1.) of this section, in the sum of \$10 for each calendar day on which such individual was required or permitted to work in excess of the standard workweek of forty hours without payment of the overtime wages required by the clause set forth in paragraph (1.) of this section.

**3. Withholding for unpaid wages and liquidated damages.** The FHWA or the contracting agency shall upon its own action or upon written request of an authorized representative of the Department of Labor withhold or cause to be withheld, from any moneys payable on account of work performed by the contractor or subcontractor under any such contract or any other Federal contract with the same prime contractor, or any other federally-assisted contract subject to the Contract Work Hours and Safety Standards Act, which is held by the same prime contractor, such sums as may be determined to be necessary to satisfy any liabilities of such contractor or subcontractor for unpaid wages and liquidated damages as provided in the clause set forth in paragraph (2.) of this section.

**4. Subcontracts.** The contractor or subcontractor shall insert in any subcontracts the clauses set forth in paragraph (1.) through (4.) of this section and also a clause requiring the subcontractors to include these clauses in any lower tier subcontracts. The prime contractor shall be responsible for compliance by any subcontractor or lower tier subcontractor with the clauses set forth in paragraphs (1.) through (4.) of this section.

## VI. SUBLETTING OR ASSIGNING THE CONTRACT

This provision is applicable to all Federal-aid construction contracts on the National Highway System.

1. The contractor shall perform with its own organization contract work amounting to not less than 30 percent (or a greater percentage if specified elsewhere in the contract) of the total original contract price, excluding any specialty items designated by the contracting agency. Specialty items may be performed by subcontract and the amount of any such specialty items performed may be deducted from the total original contract price before computing the amount of work required to be performed by the contractor's own organization (23 CFR 635.116).

a. The term "perform work with its own organization" refers to workers employed or leased by the prime contractor, and equipment owned or rented by the prime contractor, with or without operators. Such term does not include employees or equipment of a subcontractor or lower tier subcontractor, agents of the prime contractor, or any other assignees. The term may include payments for the costs of hiring leased employees from an employee leasing firm meeting all relevant Federal and State regulatory requirements. Leased employees may only be included in this term if the prime contractor meets all of the following conditions:

(1) the prime contractor maintains control over the supervision of the day-to-day activities of the leased employees;

(2) the prime contractor remains responsible for the quality of the work of the leased employees;

(3) the prime contractor retains all power to accept or exclude individual employees from work on the project; and

(4) the prime contractor remains ultimately responsible for the payment of predetermined minimum wages, the submission of payrolls, statements of compliance and all other Federal regulatory requirements.

b. "Specialty Items" shall be construed to be limited to work that requires highly specialized knowledge, abilities, or equipment not ordinarily available in the type of contracting organizations qualified and expected to bid or propose on the contract as a whole and in general are to be limited to minor components of the overall contract.

2. The contract amount upon which the requirements set forth in paragraph (1) of Section VI is computed includes the cost of material and manufactured products which are to be purchased or produced by the contractor under the contract provisions.

3. The contractor shall furnish (a) a competent superintendent or supervisor who is employed by the firm, has full authority to direct performance of the work in accordance with the contract requirements, and is in charge of all construction operations (regardless of who performs the work) and (b) such other of its own organizational resources (supervision, management, and engineering services) as the contracting officer determines is necessary to assure the performance of the contract.

4. No portion of the contract shall be sublet, assigned or otherwise disposed of except with the written consent of the contracting officer, or authorized representative, and such consent when given shall not be construed to relieve the contractor of any responsibility for the fulfillment of the contract. Written consent will be given only after the contracting agency has assured that each subcontract is

evidenced in writing and that it contains all pertinent provisions and requirements of the prime contract.

5. The 30% self-performance requirement of paragraph (1) is not applicable to design-build contracts; however, contracting agencies may establish their own self-performance requirements.

## VII. SAFETY: ACCIDENT PREVENTION

This provision is applicable to all Federal-aid construction contracts and to all related subcontracts.

1. In the performance of this contract the contractor shall comply with all applicable Federal, State, and local laws governing safety, health, and sanitation (23 CFR 635). The contractor shall provide all safeguards, safety devices and protective equipment and take any other needed actions as it determines, or as the contracting officer may determine, to be reasonably necessary to protect the life and health of employees on the job and the safety of the public and to protect property in connection with the performance of the work covered by the contract.

2. It is a condition of this contract, and shall be made a condition of each subcontract, which the contractor enters into pursuant to this contract, that the contractor and any subcontractor shall not permit any employee, in performance of the contract, to work in surroundings or under conditions which are unsanitary, hazardous or dangerous to his/her health or safety, as determined under construction safety and health standards (29 CFR 1926) promulgated by the Secretary of Labor, in accordance with Section 107 of the Contract Work Hours and Safety Standards Act (40 U.S.C. 3704).

3. Pursuant to 29 CFR 1926.3, it is a condition of this contract that the Secretary of Labor or authorized representative thereof, shall have right of entry to any site of contract performance to inspect or investigate the matter of compliance with the construction safety and health standards and to carry out the duties of the Secretary under Section 107 of the Contract Work Hours and Safety Standards Act (40 U.S.C.3704).

## VIII. FALSE STATEMENTS CONCERNING HIGHWAY PROJECTS

This provision is applicable to all Federal-aid construction contracts and to all related subcontracts.

In order to assure high quality and durable construction in conformity with approved plans and specifications and a high degree of reliability on statements and representations made by engineers, contractors, suppliers, and workers on Federal-aid highway projects, it is essential that all persons concerned with the project perform their functions as carefully, thoroughly, and honestly as possible. Willful falsification, distortion, or misrepresentation with respect to any facts related to the project is a violation of Federal law. To prevent any misunderstanding regarding the seriousness of these and similar acts, Form FHWA-1022 shall be posted on each Federal-aid highway project (23 CFR 635) in one or more places where it is readily available to all persons concerned with the project:

18 U.S.C. 1020 reads as follows:

"Whoever, being an officer, agent, or employee of the United States, or of any State or Territory, or whoever, whether a person, association, firm, or corporation, knowingly makes any false statement, false representation, or false report as to the character, quality, quantity, or cost of the material used or to be used, or the quantity or quality of the work performed or to be performed, or the cost thereof in connection with the submission of plans, maps, specifications, contracts, or costs of construction on any highway or related project submitted for approval to the Secretary of Transportation; or

Whoever knowingly makes any false statement, false representation, false report or false claim with respect to the character, quality, quantity, or cost of any work performed or to be performed, or materials furnished or to be furnished, in connection with the construction of any highway or related project approved by the Secretary of Transportation; or

Whoever knowingly makes any false statement or false representation as to material fact in any statement, certificate, or report submitted pursuant to provisions of the Federal-aid Roads Act approved July 1, 1916, (39 Stat. 355), as amended and supplemented;

Shall be fined under this title or imprisoned not more than 5 years or both."

#### **IX. IMPLEMENTATION OF CLEAN AIR ACT AND FEDERAL WATER POLLUTION CONTROL ACT**

This provision is applicable to all Federal-aid construction contracts and to all related subcontracts.

By submission of this bid/proposal or the execution of this contract, or subcontract, as appropriate, the bidder, proposer, Federal-aid construction contractor, or subcontractor, as appropriate, will be deemed to have stipulated as follows:

1. That any person who is or will be utilized in the performance of this contract is not prohibited from receiving an award due to a violation of Section 508 of the Clean Water Act or Section 306 of the Clean Air Act.

2. That the contractor agrees to include or cause to be included the requirements of paragraph (1) of this Section X in every subcontract, and further agrees to take such action as the contracting agency may direct as a means of enforcing such requirements.

#### **X. CERTIFICATION REGARDING DEBARMENT, SUSPENSION, INELIGIBILITY AND VOLUNTARY EXCLUSION**

This provision is applicable to all Federal-aid construction contracts, design-build contracts, subcontracts, lower-tier subcontracts, purchase orders, lease agreements, consultant contracts or any other covered transaction requiring FHWA approval or that is estimated to cost \$25,000 or more – as defined in 2 CFR Parts 180 and 1200.

##### **1. Instructions for Certification – First Tier Participants:**

a. By signing and submitting this proposal, the prospective first tier participant is providing the certification set out below.

b. The inability of a person to provide the certification set out below will not necessarily result in denial of participation in this

covered transaction. The prospective first tier participant shall submit an explanation of why it cannot provide the certification set out below. The certification or explanation will be considered in connection with the department or agency's determination whether to enter into this transaction. However, failure of the prospective first tier participant to furnish a certification or an explanation shall disqualify such a person from participation in this transaction.

c. The certification in this clause is a material representation of fact upon which reliance was placed when the contracting agency determined to enter into this transaction. If it is later determined that the prospective participant knowingly rendered an erroneous certification, in addition to other remedies available to the Federal Government, the contracting agency may terminate this transaction for cause of default.

d. The prospective first tier participant shall provide immediate written notice to the contracting agency to whom this proposal is submitted if any time the prospective first tier participant learns that its certification was erroneous when submitted or has become erroneous by reason of changed circumstances.

e. The terms "covered transaction," "debarred," "suspended," "ineligible," "participant," "person," "principal," and "voluntarily excluded," as used in this clause, are defined in 2 CFR Parts 180 and 1200. "First Tier Covered Transactions" refers to any covered transaction between a grantee or subgrantee of Federal funds and a participant (such as the prime or general contract). "Lower Tier Covered Transactions" refers to any covered transaction under a First Tier Covered Transaction (such as subcontracts). "First Tier Participant" refers to the participant who has entered into a covered transaction with a grantee or subgrantee of Federal funds (such as the prime or general contractor). "Lower Tier Participant" refers any participant who has entered into a covered transaction with a First Tier Participant or other Lower Tier Participants (such as subcontractors and suppliers).

f. The prospective first tier participant agrees by submitting this proposal that, should the proposed covered transaction be entered into, it shall not knowingly enter into any lower tier covered transaction with a person who is debarred, suspended, declared ineligible, or voluntarily excluded from participation in this covered transaction, unless authorized by the department or agency entering into this transaction.

g. The prospective first tier participant further agrees by submitting this proposal that it will include the clause titled "Certification Regarding Debarment, Suspension, Ineligibility and Voluntary Exclusion-Lower Tier Covered Transactions," provided by the department or contracting agency, entering into this covered transaction, without modification, in all lower tier covered transactions and in all solicitations for lower tier covered transactions exceeding the \$25,000 threshold.

h. A participant in a covered transaction may rely upon a certification of a prospective participant in a lower tier covered transaction that is not debarred, suspended, ineligible, or voluntarily excluded from the covered transaction, unless it knows that the certification is erroneous. A participant is responsible for ensuring that its principals are not suspended, debarred, or otherwise ineligible to participate in covered transactions. To verify the eligibility of its principals, as well as the eligibility of any lower tier prospective participants, each participant may, but is not required to, check the Excluded Parties List System website (<https://www.epls.gov/>), which is compiled by the General Services Administration.

i. Nothing contained in the foregoing shall be construed to require the establishment of a system of records in order to render in good faith the certification required by this clause. The knowledge and information of the prospective participant is not required to exceed that which is normally possessed by a prudent person in the ordinary course of business dealings.

j. Except for transactions authorized under paragraph (f) of these instructions, if a participant in a covered transaction knowingly enters into a lower tier covered transaction with a person who is suspended, debarred, ineligible, or voluntarily excluded from participation in this transaction, in addition to other remedies available to the Federal Government, the department or agency may terminate this transaction for cause or default.

\*\*\*\*\*

**2. Certification Regarding Debarment, Suspension, Ineligibility and Voluntary Exclusion – First Tier Participants:**

a. The prospective first tier participant certifies to the best of its knowledge and belief, that it and its principals:

(1) Are not presently debarred, suspended, proposed for debarment, declared ineligible, or voluntarily excluded from participating in covered transactions by any Federal department or agency;

(2) Have not within a three-year period preceding this proposal been convicted of or had a civil judgment rendered against them for commission of fraud or a criminal offense in connection with obtaining, attempting to obtain, or performing a public (Federal, State or local) transaction or contract under a public transaction; violation of Federal or State antitrust statutes or commission of embezzlement, theft, forgery, bribery, falsification or destruction of records, making false statements, or receiving stolen property;

(3) Are not presently indicted for or otherwise criminally or civilly charged by a governmental entity (Federal, State or local) with commission of any of the offenses enumerated in paragraph (a)(2) of this certification; and

(4) Have not within a three-year period preceding this application/proposal had one or more public transactions (Federal, State or local) terminated for cause or default.

b. Where the prospective participant is unable to certify to any of the statements in this certification, such prospective participant shall attach an explanation to this proposal.

**2. Instructions for Certification - Lower Tier Participants:**

(Applicable to all subcontracts, purchase orders and other lower tier transactions requiring prior FHWA approval or estimated to cost \$25,000 or more - 2 CFR Parts 180 and 1200)

a. By signing and submitting this proposal, the prospective lower tier is providing the certification set out below.

b. The certification in this clause is a material representation of fact upon which reliance was placed when this transaction was entered into. If it is later determined that the prospective lower tier participant knowingly rendered an erroneous certification, in addition to other remedies available to the Federal Government, the department, or agency with which

this transaction originated may pursue available remedies, including suspension and/or debarment.

c. The prospective lower tier participant shall provide immediate written notice to the person to which this proposal is submitted if at any time the prospective lower tier participant learns that its certification was erroneous by reason of changed circumstances.

d. The terms "covered transaction," "debarred," "suspended," "ineligible," "participant," "person," "principal," and "voluntarily excluded," as used in this clause, are defined in 2 CFR Parts 180 and 1200. You may contact the person to which this proposal is submitted for assistance in obtaining a copy of those regulations. "First Tier Covered Transactions" refers to any covered transaction between a grantee or subgrantee of Federal funds and a participant (such as the prime or general contract). "Lower Tier Covered Transactions" refers to any covered transaction under a First Tier Covered Transaction (such as subcontracts). "First Tier Participant" refers to the participant who has entered into a covered transaction with a grantee or subgrantee of Federal funds (such as the prime or general contractor). "Lower Tier Participant" refers any participant who has entered into a covered transaction with a First Tier Participant or other Lower Tier Participants (such as subcontractors and suppliers).

e. The prospective lower tier participant agrees by submitting this proposal that, should the proposed covered transaction be entered into, it shall not knowingly enter into any lower tier covered transaction with a person who is debarred, suspended, declared ineligible, or voluntarily excluded from participation in this covered transaction, unless authorized by the department or agency with which this transaction originated.

f. The prospective lower tier participant further agrees by submitting this proposal that it will include this clause titled "Certification Regarding Debarment, Suspension, Ineligibility and Voluntary Exclusion-Lower Tier Covered Transaction," without modification, in all lower tier covered transactions and in all solicitations for lower tier covered transactions exceeding the \$25,000 threshold.

g. A participant in a covered transaction may rely upon a certification of a prospective participant in a lower tier covered transaction that is not debarred, suspended, ineligible, or voluntarily excluded from the covered transaction, unless it knows that the certification is erroneous. A participant is responsible for ensuring that its principals are not suspended, debarred, or otherwise ineligible to participate in covered transactions. To verify the eligibility of its principals, as well as the eligibility of any lower tier prospective participants, each participant may, but is not required to, check the Excluded Parties List System website (<https://www.epls.gov/>), which is compiled by the General Services Administration.

h. Nothing contained in the foregoing shall be construed to require establishment of a system of records in order to render in good faith the certification required by this clause. The knowledge and information of participant is not required to exceed that which is normally possessed by a prudent person in the ordinary course of business dealings.

i. Except for transactions authorized under paragraph e of these instructions, if a participant in a covered transaction knowingly enters into a lower tier covered transaction with a person who is suspended, debarred, ineligible, or voluntarily excluded from participation in this transaction, in addition to other remedies available to the Federal Government, the

department or agency with which this transaction originated may pursue available remedies, including suspension and/or debarment.

\* \* \* \* \*

**Certification Regarding Debarment, Suspension, Ineligibility and Voluntary Exclusion--Lower Tier Participants:**

1. The prospective lower tier participant certifies, by submission of this proposal, that neither it nor its principals is presently debarred, suspended, proposed for debarment, declared ineligible, or voluntarily excluded from participating in covered transactions by any Federal department or agency.

2. Where the prospective lower tier participant is unable to certify to any of the statements in this certification, such prospective participant shall attach an explanation to this proposal.

\* \* \* \* \*

**XI. CERTIFICATION REGARDING USE OF CONTRACT FUNDS FOR LOBBYING**

This provision is applicable to all Federal-aid construction contracts and to all related subcontracts which exceed \$100,000 (49 CFR 20).

1. The prospective participant certifies, by signing and submitting this bid or proposal, to the best of his or her knowledge and belief, that:

a. No Federal appropriated funds have been paid or will be paid, by or on behalf of the undersigned, to any person for influencing or attempting to influence an officer or employee of any Federal agency, a Member of Congress, an officer or employee of Congress, or an employee of a Member of Congress in connection with the awarding of any Federal contract, the making of any Federal grant, the making of any Federal loan, the entering into of any cooperative agreement, and the extension, continuation, renewal, amendment, or modification of any Federal contract, grant, loan, or cooperative agreement.

b. If any funds other than Federal appropriated funds have been paid or will be paid to any person for influencing or attempting to influence an officer or employee of any Federal agency, a Member of Congress, an officer or employee of Congress, or an employee of a Member of Congress in connection with this Federal contract, grant, loan, or cooperative agreement, the undersigned shall complete and submit Standard Form-LLL, "Disclosure Form to Report Lobbying," in accordance with its instructions.

2. This certification is a material representation of fact upon which reliance was placed when this transaction was made or entered into. Submission of this certification is a prerequisite for making or entering into this transaction imposed by 31 U.S.C. 1352. Any person who fails to file the required certification shall be subject to a civil penalty of not less than \$10,000 and not more than \$100,000 for each such failure.

3. The prospective participant also agrees by submitting its bid or proposal that the participant shall require that the language of this certification be included in all lower tier subcontracts, which exceed \$100,000 and that all such recipients shall certify and disclose accordingly.

**ATTACHMENT A - EMPLOYMENT AND MATERIALS  
PREFERENCE FOR APPALACHIAN DEVELOPMENT  
HIGHWAY SYSTEM OR APPALACHIAN LOCAL ACCESS  
ROAD CONTRACTS**

This provision is applicable to all Federal-aid projects funded under the Appalachian Regional Development Act of 1965.

1. During the performance of this contract, the contractor undertaking to do work which is, or reasonably may be, done as on-site work, shall give preference to qualified persons who regularly reside in the labor area as designated by the DOL wherein the contract work is situated, or the subregion, or the Appalachian counties of the State wherein the contract work is situated, except:

a. To the extent that qualified persons regularly residing in the area are not available.

b. For the reasonable needs of the contractor to employ supervisory or specially experienced personnel necessary to assure an efficient execution of the contract work.

c. For the obligation of the contractor to offer employment to present or former employees as the result of a lawful collective bargaining contract, provided that the number of nonresident persons employed under this subparagraph (1c) shall not exceed 20 percent of the total number of employees employed by the contractor on the contract work, except as provided in subparagraph (4) below.

2. The contractor shall place a job order with the State Employment Service indicating (a) the classifications of the laborers, mechanics and other employees required to perform the contract work, (b) the number of employees required in each classification, (c) the date on which the participant estimates such employees will be required, and (d) any other pertinent information required by the State Employment Service to complete the job order form. The job order may be placed with the State Employment Service in writing or by telephone. If during the course of the contract work, the information submitted by the contractor in the original job order is substantially modified, the participant shall promptly notify the State Employment Service.

3. The contractor shall give full consideration to all qualified job applicants referred to him by the State Employment Service. The contractor is not required to grant employment to any job applicants who, in his opinion, are not qualified to perform the classification of work required.

4. If, within one week following the placing of a job order by the contractor with the State Employment Service, the State Employment Service is unable to refer any qualified job applicants to the contractor, or less than the number requested, the State Employment Service will forward a certificate to the contractor indicating the unavailability of applicants. Such certificate shall be made a part of the contractor's permanent project records. Upon receipt of this certificate, the contractor may employ persons who do not normally reside in the labor area to fill positions covered by the certificate, notwithstanding the provisions of subparagraph (1c) above.

5. The provisions of 23 CFR 633.207(e) allow the contracting agency to provide a contractual preference for the use of mineral resource materials native to the Appalachian region.

6. The contractor shall include the provisions of Sections 1 through 4 of this Attachment A in every subcontract for work which is, or reasonably may be, done as on-site work.

**KENTUCKY TRANSPORTATION CABINET  
DEPARTMENT OF HIGHWAYS**

**EMPLOYMENT REQUIREMENTS  
RELATING TO  
NONDISCRIMINATION OF EMPLOYEES  
(APPLICABLE TO FEDERAL-AID SYSTEM CONTRACTS)**

**AN ACT OF THE KENTUCKY GENERAL ASSEMBLY  
TO PREVENT DISCRIMINATION IN EMPLOYMENT**

**KRS CHAPTER 344  
EFFECTIVE JUNE 16, 1972**

The contract on this project, in accordance with KRS Chapter 344, provides that during the performance of this contract, the contractor agrees as follows:

4. The contractor will send to each labor union or representative of workers with which he has a collective bargaining agreement or other contract or understanding, a notice to be provided advising the said labor union or workers' representative of the contractor's commitments under this section, and shall post copies of the notice in conspicuous places available to employees and applicants for employment. The contractor will take such action with respect to any subcontract or purchase order as the administering agency may direct as a means of enforcing such provisions, including sanctions for non-compliance.

Revised: January 25, 2017

1. The contractor shall not fail or refuse to hire, or shall not discharge any individual, or otherwise discriminate against an individual with respect to his compensation, terms, conditions, or privileges of employment, because of such individual's race, color, religion, national origin, sex, disability or age (forty and above); or limit, segregate, or classify his employees in any way which would deprive or tend to deprive an individual of employment opportunities or otherwise adversely affect his status as an employee, because of such individual's race, color, religion, national origin, sex, disability or age forty (40) and over. The contractor agrees to post in conspicuous places, available to employees and applicants for employment, notices to be provided setting forth the provisions of this nondiscrimination clause.

2. The contractor shall not print or publish or cause to be printed or published a notice or advertisement relating to employment by such an employer or membership in or any classification or referral for employment by the employment agency, indicating any preference, limitation, specification, or discrimination, based on race, color, religion, national origin, sex, or age forty (40) and over, or because the person is a qualified individual with a disability, except that such a notice or advertisement may indicate a preference, limitation, or specification based on religion, national origin, sex, or age forty (40) and over, or because the person is a qualified individual with a disability, when religion, national origin, sex, or age forty (40) and over, or because the person is a qualified individual with a disability, is a bona fide occupational qualification for employment.

3. If the contractor is in control of apprenticeship or other training or retraining, including on-the-job training programs, he shall not discriminate against an individual because of his race, color, religion, national origin, sex, disability or age forty (40) and over, in admission to, or employment in any program established to provide apprenticeship or other training.



### Standard Title VI/Non-Discrimination Assurances

During the performance of this contract, the contractor, for itself, its assignees, and successors in interest (hereinafter referred to as the "contractor") agrees as follows:

1. **Compliance with Regulations:** The contractor (hereinafter includes consultants) will comply with the Acts and the Regulations relative to Non-discrimination in Federally-assisted programs of the U.S. Department of Transportation, **Federal Highway Administration**, as they may be amended from time to time, which are herein incorporated by reference and made a part of this contract.
2. **Non-discrimination:** The contractor, with regard to the work performed by it during the contract, will not discriminate on the grounds of race, color, or national origin in the selection and retention of subcontractors, including procurements of materials and leases of equipment. The contractor will not participate directly or indirectly in the discrimination prohibited by the Acts and the Regulations, including employment practices when the contract covers any activity, project, or program set forth in Appendix B of 49 CFR Part 21.
3. **Solicitations for Subcontracts, Including Procurements of Materials and Equipment:** In all solicitations, either by competitive bidding, or negotiation made by the contractor for work to be performed under a subcontract, including procurements of materials, or leases of equipment, each potential subcontractor or supplier will be notified by the contractor of the contractor's obligations under this contract and the Acts and the Regulations relative to Non-discrimination on the grounds of race, color, or national origin.
4. **Information and Reports:** The contractor will provide all information and reports required by the Acts, the Regulations, and directives issued pursuant thereto and will permit access to its books, records, accounts, other sources of information, and its facilities as may be determined by the Recipient or the **Federal Highway Administration** to be pertinent to ascertain compliance with such Acts, Regulations, and instructions. Where any information required of a contractor is in the exclusive possession of another who fails or refuses to furnish the information, the contractor will so certify to the Recipient or the **Federal Highway Administration**, as appropriate, and will set forth what efforts it has made to obtain the information.
5. **Sanctions for Noncompliance:** In the event of a contractor's noncompliance with the Non-discrimination provisions of this contract, the Recipient will impose such contract sanctions as it or the **Federal Highway Administration** may determine to be appropriate, including, but not limited to:
  - a. withholding payments to the contractor under the contract until the contractor complies; and/or
  - b. cancelling, terminating, or suspending a contract, in whole or in part.
6. **Incorporation of Provisions:** The contractor will include the provisions of paragraphs one through six in every subcontract, including procurements of materials and leases of equipment, unless exempt by the Acts, the Regulations and directives issued pursuant thereto. The contractor will take action with respect to any subcontract or procurement as the Recipient or the **Federal Highway Administration** may direct as a means of enforcing such provisions including sanctions for noncompliance. Provided, that if the contractor becomes involved in, or is threatened with litigation by a subcontractor, or supplier because of such direction, the contractor may request the Recipient to enter into any litigation to protect the interests of the Recipient. In addition, the contractor may request the United States to enter into the litigation to protect the interests of the United States.

### **Standard Title VI/Non-Discrimination Statutes and Authorities**

During the performance of this contract, the contractor, for itself, its assignees, and successors in interest (hereinafter referred to as the “contractor”) agrees to comply with the following non-discrimination statutes and authorities; including but not limited to:

- Title VI of the Civil Rights Act of 1964 (42 U.S.C. § 2000d *et seq.*, 78 stat. 252), (prohibits discrimination on the basis of race, color, national origin); and 49 CFR Part 21;
- The Uniform Relocation Assistance and Real Property Acquisition Policies Act of 1970, (42 U.S.C. § 4601), (prohibits unfair treatment of persons displaced or whose property has been acquired because of Federal or Federal-aid programs and projects);
- Federal-Aid Highway Act of 1973, (23 U.S.C. § 324 *et seq.*), (prohibits discrimination on the basis of sex);
- Section 504 of the Rehabilitation Act of 1973, (29 U.S.C. § 794 *et seq.*), as amended, (prohibits discrimination on the basis of disability); and 49 CFR Part 27;
- The Age Discrimination Act of 1975, as amended, (42 U.S.C. § 6101 *et seq.*), (prohibits discrimination on the basis of age);
- Airport and Airway Improvement Act of 1982, (49 USC § 471, Section 47123), as amended, (prohibits discrimination based on race, creed, color, national origin, or sex);
- The Civil Rights Restoration Act of 1987, (PL 100-209), (Broadened the scope, coverage and applicability of Title VI of the Civil Rights Act of 1964, The Age Discrimination Act of 1975 and Section 504 of the Rehabilitation Act of 1973, by expanding the definition of the terms “programs or activities” to include all of the programs or activities of the Federal-aid recipients, sub-recipients and contractors, whether such programs or activities are Federally funded or not);
- Titles II and III of the Americans with Disabilities Act, which prohibit discrimination on the basis of disability in the operation of public entities, public and private transportation systems, places of public accommodation, and certain testing entities (42 U.S.C. §§ 12131 -- 12189) as implemented by Department of Transportation regulations at 49 C.F.R. parts 37 and 38;
- The Federal Aviation Administration’s Non-discrimination statute (49 U.S.C. § 47123) (prohibits discrimination on the basis of race, color, national origin, and sex);
- Executive Order 12898, Federal Actions to Address Environmental Justice in Minority Populations and Low-Income Populations, which ensures non-discrimination against minority populations by discouraging programs, policies, and activities with disproportionately high and adverse human health or environmental effects on minority and low-income populations;
- Executive Order 13166, Improving Access to Services for Persons with Limited English Proficiency, and resulting agency guidance, national origin discrimination includes discrimination because of limited English proficiency (LEP). To ensure compliance with Title VI, you must take reasonable steps to ensure that LEP persons have meaningful access to your programs (70 Fed. Reg. at 74087 to 74100);
- Title IX of the Education Amendments of 1972, as amended, which prohibits you from discriminating because of sex in education programs or activities (20 U.S.C. 1681 *et seq.*)

## EXECUTIVE BRANCH CODE OF ETHICS

In the 1992 regular legislative session, the General Assembly passed and Governor Brereton Jones signed Senate Bill 63 (codified as KRS 11A), the Executive Branch Code of Ethics, which states, in part:

KRS 11A.040 (7) provides:

No present or former public servant shall, within six (6) months following termination of his office or employment, accept employment, compensation, or other economic benefit from any person or business that contracts or does business with, or is regulated by, the state in matters in which he was directly involved during the last thirty-six (36) months of his tenure. This provision shall not prohibit an individual from returning to the same business, firm, occupation, or profession in which he was involved prior to taking office or beginning his term of employment, or for which he received, prior to his state employment, a professional degree or license, provided that, for a period of six (6) months, he personally refrains from working on any matter in which he was directly involved during the last thirty-six (36) months of his tenure in state government. This subsection shall not prohibit the performance of ministerial functions, including but not limited to filing tax returns, filing applications for permits or licenses, or filing incorporation papers, nor shall it prohibit the former officer or public servant from receiving public funds disbursed through entitlement programs.

KRS 11A.040 (9) states:

A former public servant shall not represent a person or business before a state agency in a matter in which the former public servant was directly involved during the last thirty-six (36) months of his tenure, for a period of one (1) year after the latter of:

- a) The date of leaving office or termination of employment; or
- b) The date the term of office expires to which the public servant was elected.

This law is intended to promote public confidence in the integrity of state government and to declare as public policy the idea that state employees should view their work as a public trust and not as a way to obtain private benefits.

If you have worked for the executive branch of state government within the past six months, you may be subject to the law's prohibitions. The law's applicability may be different if you hold elected office or are contemplating representation of another before a state agency.

Also, if you are affiliated with a firm which does business with the state and which employs former state executive-branch employees, you should be aware that the law may apply to them.

In case of doubt, the law permits you to request an advisory opinion from the Executive Branch Ethics Commission, 3 Fountain Place, Frankfort, Kentucky 40601; telephone (502) 564-7954.

Revised: January 27, 2017

KENTUCKY TRANSPORTATION CABINET  
DEPARTMENT OF HIGHWAYS  
**TRAINING SPECIAL PROVISIONS**

This Training Special Provision supersedes subparagraph 7b of the Special Provision entitled "Specific Equal Employment Opportunity Responsibilities," (Attachment 1), and is in implementation of 23 U.S.C. 140(a).

As part of the contractor's equal employment opportunity affirmative action program training shall be provided as follows:

The contractor shall provide on-the-job training aimed at developing full journeymen in the type of trade or job classification involved.

The number of trainees to be trained under these special provisions and in this contract is shown in "Special Notes Applicable to Project" in the bid proposal.

In the event that a contractor subcontracts a portion of the contract work, he shall determine how many, if any, of the trainees are to be trained by the subcontractor, provided, however, that the contractor shall retain the primary responsibility for meeting the training requirements imposed by this special provision. The contractor shall also insure that this training special provision is made applicable to such subcontract. Where feasible, 25 percent of apprentices or trainees in each occupation shall be in their first year of apprenticeship or training.

The number of trainees shall be distributed among the work classifications on the basis of the contractor's needs and the availability of journeymen in the various classifications within a reasonable area of recruitment. Prior to commencing construction the contractor shall submit to the Kentucky Transportation Cabinet, Department of Highways for its approval, an acceptable training program on forms provided by the Cabinet indicating the number of trainees to be trained in each selected classification. Failure to provide the Cabinet with the proper documentation evidencing an acceptable training program prior to commencing construction shall cause the Cabinet to suspend the operations of the contractor with (if applicable) working days being charged as usual against the contract time or (if applicable), no additional contract time being granted for the suspension period. The Cabinet will not be liable for the payment of any work performed during the suspension period due to the failure of the contractor to provide an acceptable training program. Said suspension period shall be terminated when an acceptable training program is received by the Cabinet. Furthermore, the contractor shall specify the starting time for training in each of the classifications. The contractor will be credited for each trainee employed by him on the contract work who is currently enrolled or becomes enrolled in an approved program and will be reimbursed for such trainees as provided hereinafter.

Training and upgrading of minorities and women toward journeymen status is a primary objective of this Training Special Provision. Accordingly, the contractor shall make every effort to enroll minority trainees and women (e.g., by conducting systematic and direct recruitment through public and private sources likely to yield minority and women trainees) to the extent that such persons are available within a reasonable area of recruitment. The contractor will be responsible for demonstrating the steps that he has taken in pursuance thereof, prior to a determination as to whether the contractor is in compliance with this Training Special Provision. This training commitment is not intended, and shall not be used, to discriminate against any applicant for training, whether a member of a minority group or not.

No employee shall be employed as a trainee in any classification in which he has successfully completed a training course leading to journeyman status or in which he has been employed as a journeyman. The contractor should satisfy this requirement by including appropriate questions in the employee application or by other suitable means. Regardless of the method used the contractor's records should document the findings in each case. The minimum length and type of training for each classification will be as established in the training program selected by the contractor and approved by the Kentucky Transportation Cabinet, Department of Highways and the Federal Highway Administration shall approve a program if it is reasonably calculated to meet the equal employment opportunity obligations of the contractor and to qualify the average trainee for journeyman status in the classification concerned by the end of the training period. Furthermore, apprenticeship programs

registered with the U.S. Department of Labor, Bureau of Apprenticeship and Training, or with a State apprenticeship agency recognized by the Bureau and training programs approved but not necessarily sponsored by the U.S. Department of Labor, Manpower Administration, Bureau of Apprenticeship and Training shall also be considered acceptable provided it is being administered in a manner consistent with the equal employment obligations of Federal-aid highway construction contracts. Approval or acceptance of a training program shall be obtained from the State prior to commencing work on the classification covered by the program. It is the intention of these provisions that training is to be provided in the construction crafts rather than clerk-typists or secretarial-type positions. Training is permissible in lower level management positions such as office engineers, estimators, timekeepers, etc., where the training is oriented toward construction applications. Training in the laborer classification may be permitted provided that significant and meaningful training is provided and approved by the division office. Some offsite training is permissible as long as the training is an integral part of an approved training program and does not comprise a significant part of the overall training.

Except as otherwise noted below, the contractor will be reimbursed for each hour of training given an employee on this contract in accordance with an approved training program. As approved by the engineer, reimbursement will be made for training persons in excess of the number specified herein. This reimbursement will be made even though the contractor receives additional training program funds from other sources, provided such other source does not specifically prohibit the contractor from receiving other reimbursement. Reimbursement for offsite training indicated above may only be made to the contractor where he does one or more of the following and the trainees are concurrently employed on a Federal-aid project; contributes to the cost of the training, provides the instruction to the trainee or pays the trainee's wages during the offsite training period.

No payment shall be made to the contractor if either the failure to provide the required training, or the failure to hire the trainee as a journeyman, is caused by the contractor and evidences a lack of good faith on the part of the contractor in meeting the requirements of this Training Special Provision. It is normally expected that a trainee will begin his training on the project as soon as feasible after start of work utilizing the skill involved and remain on the project as long as training opportunities exist in his work classification or until he has completed his training program. It is not required that all trainees be on board for the entire length of the contract. A contractor will have fulfilled his responsibilities under this Training Special Provision if he has provided acceptable training to the number of trainees specified. The number trained shall be determined on the basis of the total number enrolled on the contract for a significant period.

Trainees will be paid at least 60 percent of the appropriate minimum journeyman's rate specified in the contract for the first half of the training period, 75 percent for the third quarter of the training period, and 90 percent for the last quarter of the training period, unless apprentices or trainees in an approved existing program are enrolled as trainees on this project. In that case, the appropriate rates approved by the Departments of Labor or Transportation in connection with the existing program shall apply to all trainees being trained for the same classification who are covered by this Training Special Provision.

The contractor shall furnish the trainee a copy of the program he will follow in providing the training. The contractor shall provide each trainee with a certification showing the type and length of training satisfactorily completed.

The contractor will provide for the maintenance of records and furnish periodic reports documenting his performance under this Training Special Provision.



Stone Mason.....	\$ 21.50	8.50
CARPENTER		
Carpenter.....	\$ 24.90	14.50
Piledriver.....	\$ 24.55	14.50

CEMENT MASON.....	\$ 21.25	8.50
-------------------	----------	------

ELECTRICIAN		
Electrician.....	\$ 29.36	10.55
Equipment Operator.....	\$ 26.90	10.31
Groundsman.....	\$ 17.79	8.51
Lineman.....	\$ 30.09	10.94

When workmen are required to work from bosum chairs, trusses, stacks, tanks, scaffolds, catwalks, radio and T.V. towers, structural steel (open, unprotected, unfloored raw steel), and bridges or similar hazardous locations where workmen are subject to fall, except where using JLG's and bucket trucks up to 75 feet: Add 25% to workman's base rate for 50 to 75 feet, and add 50% to workman's base rate for over 75 feet.

IRONWORKER.....	\$ 27.56	20.57
-----------------	----------	-------

LABORER		
Group 1.....	\$ 21.80	12.36
Group 2.....	\$ 22.05	12.36
Group 3.....	\$ 22.10	12.36
Group 4.....	\$ 22.70	12.36

GROUP 1: Aging and Curing of Concrete (Any Mode or Method), Asbestos Abatement Worker, Asphalt Plant Laborers, Asphalt Laborers, Batch Truck Dumpers, Carpenter Tenders, Cement Mason Tenders, Cleaning of Machines, Concrete Laborers, Demolition Laborers, Dredging Laborers, Drill Tender, Environmental Laborer - Nuclear, Radiation, Toxic and Hazardous Waste - Level D, Flagmen, Grade Checkers, All Hand Digging and Hand Back Filling, Highway Marker Placers, Landscaping Laborers, Mesh Handlers and Placers, Puddler, Railroad Laborers, Rip-rap and Grouters, Right of Way Laborers, Sign, Guard Rail and Fence Installers (All Types), Signalmen, Sound Barrier Installer, Storm and Sanitary Sewer Laborers, Swampers, Truck Spotters and Dumpers, Wrecking of Concrete Forms, General Cleanup

GROUP 2: Batter Board Men (Sanitary and Storm Sewer), Brickmason Tenders, Mortar Mixer Operator, Scaffold Builders, Burner and Welder, Bushammers, Chain Saw Operator, Concrete Saw Operators, Deckhand Scow Man, Dry Cement Handlers, Environmental Laborers - Nuclear, Radiation, Toxic and Hazardous Waste - Level C, Forklift Operators for Masonry, Form Setters, Green Concrete Cutting, Hand Operated Grouter and Grinder Machine Operator, Jack Hammers, Lead Paint Abatement, Pavement Breakers, Paving Joint Machine, Pipe Layers - Laser Operators (Non-metallic), Plastic Pipe Fusion, Power Driven Georgia Buggy and Wheel Barrow, Power Post Hole Diggers, Precast Manhole Setters, Walk-behind Tampers, Walk-behind Trenchers, Sand Blasters, Concrete Chippers, Surface Grinders, Vibrator Operators, Wagon Drillers

GROUP 3: Air Track Driller (All Types), Asphalt Luteman and Rakers, Gunnite Nozzleman, Gunnite Operators and Mixers, Grout

Pump Operator, Powderman and Blaster, Side Rail Setters, Rail Paved Ditches, Screw Operators, Tunnel Laborers (Free Air), Water Blasters

GROUP 4: Caisson Workers (Free Air), Cement Finishers, Environmental Laborer - Nuclear, Radiation, Toxic and Hazardous Waste - Level A and B, miners and Drillers (Free Air), Tunnel Blasters, and Tunnel Mockers (Free Air), Directional and Horizontal Boring, Air Track Drillers (All Types), Powder Man and Blasters, Troxler and Concrete Tester if Laborer is Utilized

PAINTER

All Excluding Bridges.....\$ 19.92	9.57
Bridges.....\$ 23.92	10.07

PLUMBER.....\$ 22.52 7.80

POWER EQUIPMENT OPERATOR:

Group 1.....\$ 29.95	14.40
Group 2.....\$ 29.95	14.40
Group 3.....\$ 27.26	14.40
Group 4.....\$ 26.96	14.40

GROUP 1: Auto Patrol, Batch Plant, Bituminous Paver, Cable-Way, Clamshell, Concrete Mixer (21 cu ft or over), Concrete Pump, Crane, Crusher Plant, Derrick, Derrick Boat, Ditching and Trenching Machine, Dragline, Dredge Engineer, Elevator (regardless of ownership when used for hoisting any building material), Elevating Grader and all types of Loaders, Hoe-type Machine, Hoisting Engine, Locomotive, LeTourneau or Carry-all Scoop, Bulldozer, Mechanic, Orangepeel Bucket, Piledriver, Power Blade, Roller (Bituminous), Roller (Earth), Roller (Rock), Scarifier, Shovel, Tractor Shovel, Truck Crane, Well Point, Winch Truck, Push Dozer, Grout Pump, High Lift, Fork Lift (regardless of lift height), all types of Boom Cats, Multiple Operator, Core Drill, Tow or Push Boat, A-Frame Winch Truck, Concrete Paver, Grade-All, Hoist, Hyster, Material Pump, Pumpcrete, Ross Carrier, Sheepfoot, Sideboom, Throttle-Valve Man, Rotary Drill, Power Generator, Mucking Machine, Rock Spreader attached to Equipment, Scoopmobile, KeCal Loader, Tower Cranes, (French, German and other types), Hydrocrane, Tugger, Backfiller Gurries, Self-propelled Compactor, Self-Contained Hydraulic Percussion Drill

GROUP 2: All Air Compressors (200 cu ft/min or greater), Bituminous Mixer, Concrete Mixer (21 cu. ft. or over), Welding Machine, Form Grader, Tractor (50 hp and over), Bull Float, Finish Machine, Outboard Motor Boat, Brakeman, Mechanic Tender, Whirly Oiler, Tract-air, Road Widening Trencher, Articulating Trucks

GROUP 3: Greaser on Grease Facilities servicing Heavy Equipment

GROUP 4: Bituminous Distributor, Cement Gun, Conveyor, Mud Jack, Paving Joint Machine, Pump, Tamping Machine, Tractor (under 50 hp), Vibrator, Oiler, Air Compressor (under 200 cu ft per minute), Concrete Saw, Burlap and Curing Machine, Hydro Seeder, Power Form Handling Equipment, Deckhand Oiler, Hydraulic Post Driver

SHEET METAL WORKER.....	\$ 20.40	7.80
TRUCK DRIVER		
Driver (3 Tons and Over), Driver (Truck Mounted Rotary Drill).....	\$ 23.74	14.50
Driver (3 Tons and Under), Tire Changer and Truck Mechanic Tender.....	\$ 23.53	14.50
Driver (Semi-Trailer or Pole Trailer), Driver (Dump Truck, Tandem Axle), Driver of Distributor.....	\$ 23.40	14.50
Driver on Mixer Trucks (All Types).....	\$ 23.45	14.50
Driver on Pavement Breakers.	\$ 23.55	14.50
Driver, Euclid and Other Heavy Earth Moving Equipment and Low Boy.....	\$ 24.31	14.50
Driver, Winch Truck and A- Frame when used in Transporting Materials.....	\$ 23.30	14.50
Greaser on Greasing Facilities.....	\$ 24.40	14.50
Truck Mechanic.....	\$ 23.50	14.50
Truck Tender and Warehouseman.....	\$ 23.20	14.50

-----  
WELDERS - Receive rate prescribed for craft performing  
operation to which welding is incidental.

=====  
Note: Executive Order (EO) 13706, Establishing Paid Sick Leave  
for Federal Contractors applies to all contracts subject to the  
Davis-Bacon Act for which the contract is awarded (and any  
solicitation was issued) on or after January 1, 2017. If this  
contract is covered by the EO, the contractor must provide  
employees with 1 hour of paid sick leave for every 30 hours  
they work, up to 56 hours of paid sick leave each year.  
Employees must be permitted to use paid sick leave for their  
own illness, injury or other health-related needs, including  
preventive care; to assist a family member (or person who is  
like family to the employee) who is ill, injured, or has other  
health-related needs, including preventive care; or for reasons  
resulting from, or to assist a family member (or person who is  
like family to the employee) who is a victim of, domestic  
violence, sexual assault, or stalking. Additional information  
on contractor requirements and worker protections under the EO  
is available at [www.dol.gov/whd/govcontracts](http://www.dol.gov/whd/govcontracts).

Unlisted classifications needed for work not included within  
the scope of the classifications listed may be added after  
award only as provided in the labor standards contract clauses  
(29CFR 5.5 (a) (1) (ii)).



The body of each wage determination lists the classification and wage rates that have been found to be prevailing for the cited type(s) of construction in the area covered by the wage determination. The classifications are listed in alphabetical order of "identifiers" that indicate whether the particular rate is a union rate (current union negotiated rate for local), a survey rate (weighted average rate) or a union average rate (weighted union average rate).

#### Union Rate Identifiers

A four letter classification abbreviation identifier enclosed in dotted lines beginning with characters other than "SU" or "UAVG" denotes that the union classification and rate were prevailing for that classification in the survey. Example: PLUM0198-005 07/01/2014. PLUM is an abbreviation identifier of the union which prevailed in the survey for this classification, which in this example would be Plumbers. 0198 indicates the local union number or district council number where applicable, i.e., Plumbers Local 0198. The next number, 005 in the example, is an internal number used in processing the wage determination. 07/01/2014 is the effective date of the most current negotiated rate, which in this example is July 1, 2014.

Union prevailing wage rates are updated to reflect all rate changes in the collective bargaining agreement (CBA) governing this classification and rate.

#### Survey Rate Identifiers

Classifications listed under the "SU" identifier indicate that no one rate prevailed for this classification in the survey and the published rate is derived by computing a weighted average rate based on all the rates reported in the survey for that classification. As this weighted average rate includes all rates reported in the survey, it may include both union and non-union rates. Example: SULA2012-007 5/13/2014. SU indicates the rates are survey rates based on a weighted average calculation of rates and are not majority rates. LA indicates the State of Louisiana. 2012 is the year of survey on which these classifications and rates are based. The next number, 007 in the example, is an internal number used in producing the wage determination. 5/13/2014 indicates the survey completion date for the classifications and rates under that identifier.

Survey wage rates are not updated and remain in effect until a new survey is conducted.

#### Union Average Rate Identifiers

Classification(s) listed under the UAVG identifier indicate that no single majority rate prevailed for those classifications; however, 100% of the data reported for the classifications was union data. EXAMPLE: UAVG-OH-0010 08/29/2014. UAVG indicates that the rate is a weighted union average rate. OH indicates the state. The next number, 0010 in the example, is an internal number used in producing the wage

determination. 08/29/2014 indicates the survey completion date for the classifications and rates under that identifier.

A UAVG rate will be updated once a year, usually in January of each year, to reflect a weighted average of the current negotiated/CBA rate of the union locals from which the rate is based.

---

WAGE DETERMINATION APPEALS PROCESS

1.) Has there been an initial decision in the matter? This can be:

- \* an existing published wage determination
- \* a survey underlying a wage determination
- \* a Wage and Hour Division letter setting forth a position on a wage determination matter
- \* a conformance (additional classification and rate) ruling

On survey related matters, initial contact, including requests for summaries of surveys, should be with the Wage and Hour Regional Office for the area in which the survey was conducted because those Regional Offices have responsibility for the Davis-Bacon survey program. If the response from this initial contact is not satisfactory, then the process described in 2.) and 3.) should be followed.

With regard to any other matter not yet ripe for the formal process described here, initial contact should be with the Branch of Construction Wage Determinations. Write to:

Branch of Construction Wage Determinations  
Wage and Hour Division  
U.S. Department of Labor  
200 Constitution Avenue, N.W.  
Washington, DC 20210

2.) If the answer to the question in 1.) is yes, then an interested party (those affected by the action) can request review and reconsideration from the Wage and Hour Administrator (See 29 CFR Part 1.8 and 29 CFR Part 7). Write to:

Wage and Hour Administrator  
U.S. Department of Labor  
200 Constitution Avenue, N.W.  
Washington, DC 20210

The request should be accompanied by a full statement of the interested party's position and by any information (wage payment data, project description, area practice material, etc.) that the requestor considers relevant to the issue.

3.) If the decision of the Administrator is not favorable, an interested party may appeal directly to the Administrative Review Board (formerly the Wage Appeals Board). Write to:

Administrative Review Board  
U.S. Department of Labor  
200 Constitution Avenue, N.W.  
Washington, DC 20210

4.) All decisions by the Administrative Review Board are final.

=====

END OF GENERAL DECISION

Fringe benefit amounts are applicable for all hours worked except when otherwise noted.

No laborer, workman or mechanic shall be paid at a rate less than that of a Journeyman except those classified as bona fide apprentices.

Apprentices or trainees shall be permitted to work as such subject to Administrative Regulations adopted by the Commissioner of Workplace Standards. Copies of these regulations will be furnished upon request from any interested person.

Before using apprentices on the job the contractor shall present to the Contracting Officer written evidence of registration of such employees in a program of a State apprenticeship and training agency approved and recognized by the U. S. Bureau of Apprenticeship and Training. In the absence of such a State agency, the contractor shall submit evidence of approval and registration by the U. S. Bureau of Apprenticeship and Training.

The contractor shall submit to the Contracting Officer, written evidence of the established apprenticeship-journeyman ratios and wage rates in the project area, which will be the basis for establishing such ratios and rates for the project under the applicable contract provisions.

**TO: EMPLOYERS/EMPLOYEES**

**PREVAILING WAGE SCHEDULE:**

**The wages indicated on this wage schedule are the least permitted to be paid for the occupations indicated. When an employee works in more than one classification, the employer must record the number of hours worked in each classification at the prescribed hourly base rate.**

**OVERTIME:**

**Overtime is to be paid to an employee at a rate not less than one and one-half times the basic rate of pay for all hours worked in excess of forty (40) hours in such workweek. Wage violations or questions should be directed to the designated Engineer or the undersigned.**

Director  
Division of Construction Procurement  
Frankfort, Kentucky 40622  
502-564-3500

**NOTICE OF REQUIREMENT FOR AFFIRMATIVE ACTION  
TO ENSURE EQUAL EMPLOYMENT OPPORTUNITY  
(Executive Order 11246)**

1. The Offeror's or Bidder's attention is called to the "Equal Opportunity Clause" and the "Standard Federal Equal Employment Specifications" set forth herein.
2. The goals and timetables for minority and female participation, expressed in percentage terms for the Contractor's aggregate work force in each trade on all construction work in the covered area, are as follows:

<b>GOALS FOR MINORITY PARTICIPATION IN EACH TRADE</b>	<b>GOALS FOR FEMALE PARTICIPATION IN EACH TRADE</b>
7.0%	6.9%

These goals are applicable to all the Contractor's construction work (whether or not it is Federal or federally-assisted) performed in the covered area. If the contractor performs construction work in a geographical area located outside of the covered area, it shall apply the goals established for such geographical area where the work is actually performed. With regard to this second area, the contractor also is subject to the goals for both its federally involved and non-federally involved construction.

The Contractor's compliance with the Executive Order and the regulations in CFR Part 60-4 shall be based on its implementation of the Equal Opportunity Clause, specific affirmative action obligations required by the specifications set forth in 41 CFR 60-4, 3(a), and its efforts to meet the goals. The hours of minority and female employment and training must be substantially uniform throughout the length of the contract, and in each trade, and the contractor shall make a good faith effort to employ minorities and women evenly on each of its projects. The transfer of minority or female employees or trainees from Contractor to Contractor or from project to project for the sole purpose of meeting the Contractor's goals shall be a violation of the contract, the Executive Order and the regulations in 41 CFR Part 60-4. Compliance with the goals will be measured against the total work hours performed.

3. The Contractor shall provide written notification to the Director of the Office of Federal Contract Compliance Programs within ten (10) working days of award of any construction subcontract in excess of \$10,000.00 at any tier for construction work under the contract resulting from this solicitation. The notification shall list the name, address and telephone number of the subcontractor; employer identification number of the subcontractor; estimated dollar amount of the subcontract; estimated starting and completion dates of the subcontract; and the geographical area in which the subcontract is to be performed. The notification shall be mailed to:

**Evelyn Teague, Regional Director  
Office of Federal Contract Compliance Programs  
61 Forsyth Street, SW, Suite 7B75  
Atlanta, Georgia 30303-8609**

4. As used in this Notice, and in the contract resulting from this solicitation, the "**covered area**" is Magoffin County.

**PART IV**  
**INSURANCE**

Refer to  
*Kentucky Standard Specifications for Road and Bridge Construction,*  
current edition

**PART V**  
**BID ITEMS**

## PROPOSAL BID ITEMS

191048

Page 1 of 8

Report Date 7/31/19

## Section: 0001 - PAVING

LINE	BID CODE	ALT	DESCRIPTION	QUANTITY	UNIT	UNIT PRIC	FP	AMOUNT
0010	00003		CRUSHED STONE BASE	99,389.00	TON		\$	
0020	00100		ASPHALT SEAL AGGREGATE	2,059.00	TON		\$	
0030	00103		ASPHALT SEAL COAT	247.00	TON		\$	
0040	00190		LEVELING & WEDGING PG64-22	3,633.00	TON		\$	
0050	00212		CL2 ASPH BASE 1.00D PG64-22	16,556.00	TON		\$	
0060	00214		CL3 ASPH BASE 1.00D PG64-22	68,309.00	TON		\$	
0070	00301		CL2 ASPH SURF 0.38D PG64-22	4,538.00	TON		\$	
0080	00356		ASPHALT MATERIAL FOR TACK	290.00	TON		\$	
0090	00388		CL3 ASPH SURF 0.38B PG64-22	11,589.00	TON		\$	

## Section: 0002 - ROADWAY

LINE	BID CODE	ALT	DESCRIPTION	QUANTITY	UNIT	UNIT PRIC	FP	AMOUNT
0100	00078		CRUSHED AGGREGATE SIZE NO 2	88.00	TON		\$	
0110	01000		PERFORATED PIPE-4 IN	13,171.00	LF		\$	
0120	01001		PERFORATED PIPE-6 IN	140.00	LF		\$	
0130	01002		PERFORATED PIPE-8 IN	2,400.00	LF		\$	
0140	01010		NON-PERFORATED PIPE-4 IN	3,276.00	LF		\$	
0150	01020		PERF PIPE HEADWALL TY 1-4 IN	51.00	EACH		\$	
0160	01022		PERF PIPE HEADWALL TY 1-8 IN	48.00	EACH		\$	
0170	01024		PERF PIPE HEADWALL TY 2-4 IN	1.00	EACH		\$	
0180	01028		PERF PIPE HEADWALL TY 3-4 IN	1.00	EACH		\$	
0190	01740		CORED HOLE DRAINAGE BOX CON-4 IN	4.00	EACH		\$	
0200	01741		CORED HOLE DRAINAGE BOX CON-6 IN	14.00	EACH		\$	
0210	01825		ISLAND CURB AND GUTTER	90.00	LF		\$	
0220	01891		ISLAND HEADER CURB TYPE 2	90.00	LF		\$	
0230	01982		DELINEATOR FOR GUARDRAIL MONO DIRECTIONAL WHITE	421.00	EACH		\$	
0240	01983		DELINEATOR FOR GUARDRAIL MONO DIRECTIONAL YELLOW	30.00	EACH		\$	
0250	01987		DELINEATOR FOR GUARDRAIL BI DIRECTIONAL WHITE	32.00	EACH		\$	
0260	01990		DELINEATOR FOR BARRIER WALL-B/W	921.00	EACH		\$	
0270	02014		BARRICADE-TYPE III	14.00	EACH		\$	
0280	02091		REMOVE PAVEMENT	811.00	SQYD		\$	
0290	02159		TEMP DITCH	11,277.00	LF		\$	
0300	02160		CLEAN TEMP DITCH	5,489.00	LF		\$	
0310	02200		ROADWAY EXCAVATION	5,853,721.00	CUYD		\$	
0320	02242		WATER	1,000.00	MGAL		\$	
0330	02262		FENCE-WOVEN WIRE TYPE 1	41,319.00	LF		\$	
0340	02268		REMOVE & REPLACE FENCE	7,533.00	LF		\$	
0350	02351		GUARDRAIL-STEEL W BEAM-S FACE	30,237.50	LF		\$	
0360	02352		GUARDRAIL-STEEL W BEAM-D FACE	825.00	LF		\$	
0370	02360		GUARDRAIL TERMINAL SECTION NO 1	9.00	EACH		\$	
0380	02363		GUARDRAIL CONNECTOR TO BRIDGE END TY A	12.00	EACH		\$	
0390	02365		CRASH CUSHION TYPE IX-A	6.00	EACH		\$	



**PROPOSAL BID ITEMS**

191048

Page 2 of 8

Report Date 7/31/19

LINE	BID CODE	ALT	DESCRIPTION	QUANTITY	UNIT	UNIT PRIC	FP	AMOUNT
0400	02367		GUARDRAIL END TREATMENT TYPE 1	47.00	EACH		\$	
0410	02369		GUARDRAIL END TREATMENT TYPE 2A	7.00	EACH		\$	
0420	02371		GUARDRAIL END TREATMENT TYPE 7	1.00	EACH		\$	
0430	02373		GUARDRAIL END TREATMENT TYPE 3	1.00	EACH		\$	
0440	02378		GUARDRAIL CONNECTOR TO BRIDGE END TY D	2.00	EACH		\$	
0450	02381		REMOVE GUARDRAIL	22,112.00	LF		\$	
0460	02391		GUARDRAIL END TREATMENT TYPE 4A	2.00	EACH		\$	
0470	02397		TEMP GUARDRAIL	2,913.00	LF		\$	
0480	02429		RIGHT-OF-WAY MONUMENT TYPE 1	102.00	EACH		\$	
0490	02431		WITNESS R/W MONUMENT TYPE 2	3.00	EACH		\$	
0500	02432		WITNESS POST	3.00	EACH		\$	
0510	02482		CHANNEL LINING CLASS IA	2,574.00	TON		\$	
0520	02483		CHANNEL LINING CLASS II	11,267.00	TON		\$	
0530	02488		CHANNEL LINING CLASS IV	14,821.00	CUYD		\$	
0540	02545		CLEARING AND GRUBBING 176 ACRES	1.00	LS		\$	
0550	02555		CONCRETE-CLASS B	149.00	CUYD		\$	
0560	02562		TEMPORARY SIGNS	3,500.00	SQFT		\$	
0570	02585		EDGE KEY	105.00	LF		\$	
0580	02599		FABRIC-GEOTEXTILE TYPE IV	199,217.00	SQYD		\$	
0590	02600		FABRIC GEOTEXTILE TY IV FOR PIPE	15,332.00	SQYD	\$2.00	\$	\$30,664.00
0600	02650		MAINTAIN & CONTROL TRAFFIC	1.00	LS		\$	
0610	02651		DIVERSIONS (BY-PASS DETOURS) KY 9009 DIVERSION 2 - STA. 3524+62.35	1.00	LS		\$	
0620	02651		DIVERSIONS (BY-PASS DETOURS) KY 9009 DIVERSION 3 - STA. 3400+00	1.00	LS		\$	
0630	02651		DIVERSIONS (BY-PASS DETOURS) KY 9009 DIVERSION I - STA. 3394+55.56	1.00	LS		\$	
0640	02655		CROSSOVER CROSSOVER 1- STA. 3360+26	1.00	LS		\$	
0650	02655		CROSSOVER CROSSOVER 2 - STA. 3584+86	1.00	LS		\$	
0660	02655		CROSSOVER CROSSOVER 3 - STA. 3593+26	1.00	LS		\$	
0670	02671		PORTABLE CHANGEABLE MESSAGE SIGN	14.00	EACH		\$	
0680	02676		MOBILIZATION FOR MILL & TEXT	1.00	LS		\$	
0690	02677		ASPHALT PAVE MILLING & TEXTURING	1,700.00	TON		\$	
0700	02690		SAFELoading	537.00	CUYD		\$	
0710	02692		SETTLEMENT PLATFORM	2.00	EACH		\$	
0720	02696		SHOULDER RUMBLE STRIPS	91,890.00	LF		\$	
0730	02701		TEMP SILT FENCE	10,977.00	LF		\$	
0740	02703		SILT TRAP TYPE A	176.00	EACH		\$	
0750	02704		SILT TRAP TYPE B	176.00	EACH		\$	
0760	02705		SILT TRAP TYPE C	176.00	EACH		\$	
0770	02706		CLEAN SILT TRAP TYPE A	176.00	EACH		\$	
0780	02707		CLEAN SILT TRAP TYPE B	176.00	EACH		\$	
0790	02708		CLEAN SILT TRAP TYPE C	176.00	EACH		\$	
0800	02711		SEDIMENTATION BASIN	100.00	CUYD		\$	
0810	02712		CLEAN SEDIMENTATION BASIN	100.00	CUYD		\$	
0820	02726		STAKING	1.00	LS		\$	

**PROPOSAL BID ITEMS**

191048

Page 3 of 8

Report Date 7/31/19

LINE	BID CODE	ALT	DESCRIPTION	QUANTITY	UNIT	UNIT PRIC	FP	AMOUNT
0830	02731		REMOVE STRUCTURE BRIDGE - STA. 3388+64	1.00	LS		\$	
0840	02731		REMOVE STRUCTURE BRIDGE OVER KY 9009 - STA. 3507+00	1.00	LS		\$	
0850	02775		ARROW PANEL	6.00	EACH		\$	
0860	02898		RELOCATE CRASH CUSHION	4.00	EACH		\$	
0870	03340		STEEL PIPE-2 1/2 IN	131.25	LF		\$	
0880	03343		STEEL PIPE-4 IN	126.25	LF		\$	
0890	05950		EROSION CONTROL BLANKET	194,189.00	SQYD		\$	
0900	05952		TEMP MULCH	567,893.00	SQYD		\$	
0910	05953		TEMP SEEDING AND PROTECTION	425,920.00	SQYD		\$	
0920	05963		INITIAL FERTILIZER	8.00	TON		\$	
0930	05964		MAINTENANCE FERTILIZER	36.00	TON		\$	
0940	05985		SEEDING AND PROTECTION	509,582.00	SQYD		\$	
0950	05992		AGRICULTURAL LIMESTONE	316.00	TON		\$	
0960	06401		FLEXIBLE DELINEATOR POST-M/W	361.00	EACH		\$	
0970	06404		FLEXIBLE DELINEATOR POST-M/Y	95.00	EACH		\$	
0980	06510		PAVE STRIPING-TEMP PAINT-4 IN	9,950.00	LF		\$	
0990	06511		PAVE STRIPING-TEMP PAINT-6 IN	199,220.00	LF		\$	
1000	06514		PAVE STRIPING-PERM PAINT-4 IN	4,627.00	LF		\$	
1010	06515		PAVE STRIPING-PERM PAINT-6 IN	175,691.00	LF		\$	
1020	06517		PAVE STRIPING-PERM PAINT-12 IN	1,584.00	LF		\$	
1030	06568		PAVE MARKING-THERMO STOP BAR-24IN	127.00	LF		\$	
1040	06572		PAVE MARKING-DOTTED LANE EXTEN	940.00	LF		\$	
1050	06588		PAVEMENT MARKER TY IVA-BY TEMP	2,503.00	EACH		\$	
1060	08903		CRASH CUSHION TY VI CLASS BT TL3	22.00	EACH		\$	
1070	10020NS		FUEL ADJUSTMENT	1,078,771.00	DOLL	\$1.00	\$	\$1,078,771.00
1080	10030NS		ASPHALT ADJUSTMENT	406,383.00	DOLL	\$1.00	\$	\$406,383.00
1090	20071EC		JOINT ADHESIVE	48,289.00	LF		\$	
1100	20191ED		OBJECT MARKER TY 3	10.00	EACH		\$	
1110	20318ES508		RELOCATE CONC BARRIER WALL	10,120.00	LF		\$	
1120	22664EN		WATER BLASTING EXISTING STRIPE	1,000.00	LF		\$	
1130	23007EN		CONC MEDIAN BARRIER TY 9T	11,280.00	LF		\$	
1140	23139EN		STRIPING REMOVAL	5,000.00	LF		\$	
1150	23274EN11F		TURF REINFORCEMENT MAT 1	1,299.00	SQYD		\$	
1160	23496EC		MEDIAN CROSSOVER REMOVAL STA. 3360+25.68	1.00	EACH		\$	
1170	24489EC		INLAID PAVEMENT MARKER	853.00	EACH		\$	
1180	24540		R/W MONUMENT TYPE 3	7.00	EACH		\$	
1190	24543EC		CLEAN (CHANNEL CHANGE)	920.00	LF		\$	
1200	24663ED		WITNESS R/W MONUMENT TYPE 4	1.00	EACH		\$	
1210	24780EC		INTELLIGENT COMPACTION FOR AGGREGATE	25,339.00	TON		\$	
1220	24781EC		INTELLIGENT COMPACTION FOR ASPHALT	71,326.00	TON		\$	
1230	24891EC		PAVE MOUNT INFRARED TEMP EQUIPMENT	1,021,041.00	SF		\$	

**Section: 0003 - DRAINAGE**

LINE	BID CODE	ALT	DESCRIPTION	QUANTITY	UNIT	UNIT PRIC	FP	AMOUNT
------	----------	-----	-------------	----------	------	-----------	----	--------

**PROPOSAL BID ITEMS**

191048

Page 4 of 8

Report Date 7/31/19

LINE	BID CODE	ALT	DESCRIPTION	QUANTITY	UNIT	UNIT PRIC	FP	AMOUNT
1240	00441		ENTRANCE PIPE-18 IN	27.00	LF		\$	
1250	00462		CULVERT PIPE-18 IN	2,166.00	LF		\$	
1260	00464		CULVERT PIPE-24 IN	999.00	LF		\$	
1270	00466		CULVERT PIPE-30 IN	357.00	LF		\$	
1280	00468		CULVERT PIPE-36 IN	450.00	LF		\$	
1290	00469		CULVERT PIPE-42 IN	129.00	LF		\$	
1300	00472		CULVERT PIPE-60 IN	259.00	LF		\$	
1310	00474		CULVERT PIPE-72 IN	74.00	LF		\$	
1320	00522		STORM SEWER PIPE-18 IN	1,046.00	LF		\$	
1330	00524		STORM SEWER PIPE-24 IN	708.00	LF		\$	
1340	01204		PIPE CULVERT HEADWALL-18 IN	22.00	EACH		\$	
1350	01208		PIPE CULVERT HEADWALL-24 IN	12.00	EACH		\$	
1360	01210		PIPE CULVERT HEADWALL-30 IN	4.00	EACH		\$	
1370	01212		PIPE CULVERT HEADWALL-36 IN	5.00	EACH		\$	
1380	01214		PIPE CULVERT HEADWALL-42 IN	3.00	EACH		\$	
1390	01220		PIPE CULVERT HEADWALL-60 IN	4.00	EACH		\$	
1400	01310		REMOVE PIPE	8.00	LF		\$	
1410	01433		SLOPED BOX OUTLET TYPE 1-18 IN	11.00	EACH		\$	
1420	01434		SLOPED BOX OUTLET TYPE 1-24 IN	1.00	EACH		\$	
1430	01451		S & F BOX INLET-OUTLET-24 IN	4.00	EACH		\$	
1440	01452		S & F BOX INLET-OUTLET-30 IN	2.00	EACH		\$	
1450	01480		CURB BOX INLET TYPE B	10.00	EACH		\$	
1460	01490		DROP BOX INLET TYPE 1	4.00	EACH		\$	
1470	01505		DROP BOX INLET TYPE 5B	16.00	EACH		\$	
1480	01517		DROP BOX INLET TYPE 5F	22.00	EACH		\$	
1490	01653		JUNCTION BOX-SPECIAL	6.00	EACH		\$	
1500	01767		MANHOLE TYPE C	1.00	EACH		\$	
1510	01771		FRAME AND LID TY 1	1.00	EACH		\$	
1520	02625		REMOVE HEADWALL	2.00	EACH		\$	
1530	20211ES706		BORE & JACK PIPE 60 IN	140.00	LF		\$	
1540	21799EN		BORE AND JACK PIPE-24 IN	75.00	LF		\$	
1550	23124EN		BORE AND JACK PIPE-48 IN	480.00	LF		\$	
1560	23126EN		BORE AND JACK PIPE-18 IN	77.00	LF		\$	
1570	24025EC		PIPE CULVERT HEADWALL-72 IN	2.00	EACH		\$	
1580	24186EC		BORE AND JACK PIPE-36 IN	240.00	LF		\$	
1590	24814EC		PIPELINE INSPECTION	7,145.00	LF		\$	

**Section: 0004 - BRIDGE- #27712 PCIB TYPE III TWIN SPANS**

LINE	BID CODE	ALT	DESCRIPTION	QUANTITY	UNIT	UNIT PRIC	FP	AMOUNT
1600	02231		STRUCTURE GRANULAR BACKFILL	780.00	CUYD		\$	
1610	02998		MASONRY COATING	1,434.00	SQYD		\$	
1620	03299		ARMORED EDGE FOR CONCRETE	175.00	LF		\$	
1630	08020		CRUSHED AGGREGATE SLOPE PROT	467.00	TON		\$	
1640	08033		TEST PILES	148.00	LF		\$	
1650	08046		PILES-STEEL HP12X53	930.00	LF		\$	
1660	08094		PILE POINTS-12 IN	28.00	EACH		\$	
1670	08100		CONCRETE-CLASS A	313.90	CUYD		\$	

**PROPOSAL BID ITEMS**

191048

Page 5 of 8

Report Date 7/31/19

LINE	BID CODE	ALT	DESCRIPTION	QUANTITY	UNIT	UNIT PRIC	FP	AMOUNT
1680	08104		CONCRETE-CLASS AA	693.30	CUYD		\$	
1690	08150		STEEL REINFORCEMENT	48,524.00	LB		\$	
1700	08151		STEEL REINFORCEMENT-EPOXY COATED	148,409.00	LB		\$	
1710	08633		PRECAST PC I BEAM TYPE 3	2,391.70	LF		\$	
1720	20637ED		DRILLED SHAFT-ROCK 48 IN	144.00	LF		\$	
1730	20746ED		ROCK CORINGS	288.00	LF		\$	
1740	21084ED		SOUNDINGS	258.00	LF		\$	
1750	21532ED		RAIL SYSTEM TYPE III	974.00	LF		\$	
1760	22417EN		DRILLED SHAFT-54 IN-COMMON	258.00	LF		\$	

**Section: 0005 - BRIDGE- #27713 PCIB TYPE IV TWIN BRIDGE**

LINE	BID CODE	ALT	DESCRIPTION	QUANTITY	UNIT	UNIT PRIC	FP	AMOUNT
1770	02231		STRUCTURE GRANULAR BACKFILL	504.00	CUYD		\$	
1780	02998		MASONRY COATING	1,244.00	SQYD		\$	
1790	03299		ARMORED EDGE FOR CONCRETE	177.00	LF		\$	
1800	08001		STRUCTURE EXCAVATION-COMMON	558.00	CUYD		\$	
1810	08002		STRUCTURE EXCAV-SOLID ROCK	519.00	CUYD		\$	
1820	08019		CYCLOPEAN STONE RIP RAP	868.00	TON		\$	
1830	08020		CRUSHED AGGREGATE SLOPE PROT	301.00	TON		\$	
1840	08033		TEST PILES	150.00	LF		\$	
1850	08039		PRE-DRILLING FOR PILES	140.00	LF		\$	
1860	08050		PILES-STEEL HP14X73	771.00	LF		\$	
1870	08095		PILE POINTS-14 IN	28.00	EACH		\$	
1880	08100		CONCRETE-CLASS A	689.20	CUYD		\$	
1890	08104		CONCRETE-CLASS AA	1,119.20	CUYD		\$	
1900	08150		STEEL REINFORCEMENT	159,193.00	LB		\$	
1910	08151		STEEL REINFORCEMENT-EPOXY COATED	159,303.00	LB		\$	
1920	08634		PRECAST PC I BEAM TYPE 4	3,786.00	LF		\$	
1930	20743ED		DRILLED SHAFT 54 IN-SOLID ROCK	162.00	LF		\$	
1940	20744ED		DRILLED SHAFT 60 IN-COMMON	310.50	LF		\$	
1950	21532ED		RAIL SYSTEM TYPE III	1,534.00	LF		\$	

**Section: 0006 - BRIDGE- #27714 PCIB TYPE III 3 SPANS-WB**

LINE	BID CODE	ALT	DESCRIPTION	QUANTITY	UNIT	UNIT PRIC	FP	AMOUNT
1960	02231		STRUCTURE GRANULAR BACKFILL	206.00	CUYD		\$	
1970	02998		MASONRY COATING	1,106.00	SQYD		\$	
1980	03299		ARMORED EDGE FOR CONCRETE	83.00	LF		\$	
1990	08001		STRUCTURE EXCAVATION-COMMON	6.00	CUYD		\$	
2000	08020		CRUSHED AGGREGATE SLOPE PROT	255.00	TON		\$	
2010	08033		TEST PILES	248.00	LF		\$	
2020	08050		PILES-STEEL HP14X73	1,838.00	LF		\$	
2030	08095		PILE POINTS-14 IN	38.00	EACH		\$	
2040	08100		CONCRETE-CLASS A	361.20	CUYD		\$	
2050	08104		CONCRETE-CLASS AA	271.00	CUYD		\$	
2060	08150		STEEL REINFORCEMENT	51,538.00	LB		\$	

**PROPOSAL BID ITEMS**

191048

Page 6 of 8

Report Date 7/31/19

LINE	BID CODE	ALT	DESCRIPTION	QUANTITY	UNIT	UNIT PRIC	FP	AMOUNT
2070	08151		STEEL REINFORCEMENT-EPOXY COATED	52,148.00	LB		\$	
2080	08633		PRECAST PC I BEAM TYPE 3	817.40	LF		\$	
2090	21532ED		RAIL SYSTEM TYPE III	334.00	LF		\$	

**Section: 0007 - BRIDGE- #27714 PCIB TYPE III 3 SPANS-EB**

LINE	BID CODE	ALT	DESCRIPTION	QUANTITY	UNIT	UNIT PRIC	FP	AMOUNT
2100	02231		STRUCTURE GRANULAR BACKFILL	206.00	CUYD		\$	
2110	02998		MASONRY COATING	1,026.00	SQYD		\$	
2120	03299		ARMORED EDGE FOR CONCRETE	83.00	LF		\$	
2130	08001		STRUCTURE EXCAVATION-COMMON	47.00	CUYD		\$	
2140	08020		CRUSHED AGGREGATE SLOPE PROT	360.00	TON		\$	
2150	08033		TEST PILES	227.00	LF		\$	
2160	08050		PILES-STEEL HP14X73	1,700.00	LF		\$	
2170	08095		PILE POINTS-14 IN	38.00	EACH		\$	
2180	08100		CONCRETE-CLASS A	350.60	CUYD		\$	
2190	08104		CONCRETE-CLASS AA	257.10	CUYD		\$	
2200	08150		STEEL REINFORCEMENT	50,480.00	LB		\$	
2210	08151		STEEL REINFORCEMENT-EPOXY COATED	46,769.00	LB		\$	
2220	08633		PRECAST PC I BEAM TYPE 3	757.40	LF		\$	
2230	21532ED		RAIL SYSTEM TYPE III	310.00	LF		\$	

**Section: 0008 - BRIDGE- #27715 - RFBC - KY 9009 STA.3424+29.29**

LINE	BID CODE	ALT	DESCRIPTION	QUANTITY	UNIT	UNIT PRIC	FP	AMOUNT
2240	08002		STRUCTURE EXCAV-SOLID ROCK	85.00	CUYD		\$	
2250	08003		FOUNDATION PREPARATION	1.00	LS		\$	
2260	08100		CONCRETE-CLASS A	763.90	CUYD		\$	
2270	08150		STEEL REINFORCEMENT	137,720.00	LB		\$	

**Section: 0009 - BRIDGE- #27716 - RFBC - KY 9009 STA.3433+85**

LINE	BID CODE	ALT	DESCRIPTION	QUANTITY	UNIT	UNIT PRIC	FP	AMOUNT
2280	08002		STRUCTURE EXCAV-SOLID ROCK	115.00	CUYD		\$	
2290	08003		FOUNDATION PREPARATION	1.00	LS		\$	
2300	08100		CONCRETE-CLASS A	890.40	CUYD		\$	
2310	08150		STEEL REINFORCEMENT	206,844.00	LB		\$	

**Section: 0010 - BRIDGE- #27717 - RFBC - KY 9009 STA.3451+70.98**

LINE	BID CODE	ALT	DESCRIPTION	QUANTITY	UNIT	UNIT PRIC	FP	AMOUNT
2320	08002		STRUCTURE EXCAV-SOLID ROCK	320.00	CUYD		\$	
2330	08003		FOUNDATION PREPARATION	1.00	LS		\$	
2340	08100		CONCRETE-CLASS A	1,931.30	CUYD		\$	
2350	08150		STEEL REINFORCEMENT	382,052.00	LB		\$	

**PROPOSAL BID ITEMS**

191048

Page 7 of 8

Report Date 7/31/19

**Section: 0011 - BRIDGE- #27718 - RFBC - KY 9009 STA. 3479+21**

LINE	BID CODE	ALT	DESCRIPTION	QUANTITY	UNIT	UNIT PRIC	FP	AMOUNT
2360	02223		GRANULAR EMBANKMENT	29,927.00	CUYD		\$	
2370	02599		FABRIC-GEOTEXTILE TYPE IV	18,832.00	SQYD		\$	
2380	08001		STRUCTURE EXCAVATION-COMMON	5.00	CUYD		\$	
2390	08100		CONCRETE-CLASS A	1,529.00	CUYD		\$	
2400	08150		STEEL REINFORCEMENT	170,676.00	LB		\$	

**Section: 0012 - BRIDGE- #27719 - DOUBLE RFBC - KY 9009 STA. 3503+70**

LINE	BID CODE	ALT	DESCRIPTION	QUANTITY	UNIT	UNIT PRIC	FP	AMOUNT
2410	02223		GRANULAR EMBANKMENT	21,336.00	CUYD		\$	
2420	02599		FABRIC-GEOTEXTILE TYPE IV	5,970.00	SQYD		\$	
2430	08001		STRUCTURE EXCAVATION-COMMON	3,393.00	CUYD		\$	
2440	08100		CONCRETE-CLASS A	5,671.00	CUYD		\$	
2450	08150		STEEL REINFORCEMENT	615,334.00	LB		\$	

**Section: 0013 - BRIDGE- #27720 - RCBC - KY 3046 STA.46+65**

LINE	BID CODE	ALT	DESCRIPTION	QUANTITY	UNIT	UNIT PRIC	FP	AMOUNT
2460	02223		GRANULAR EMBANKMENT	615.00	CUYD		\$	
2470	02599		FABRIC-GEOTEXTILE TYPE IV	914.00	SQYD		\$	
2480	08001		STRUCTURE EXCAVATION-COMMON	1,265.00	CUYD		\$	
2490	08100		CONCRETE-CLASS A	193.00	CUYD		\$	
2500	08150		STEEL REINFORCEMENT	30,169.00	LB		\$	

**Section: 0014 - SIGNING**

LINE	BID CODE	ALT	DESCRIPTION	QUANTITY	UNIT	UNIT PRIC	FP	AMOUNT
2510	06400		GMSS GALV STEEL TYPE A	2,331.00	LB		\$	
2520	06405		SBM ALUMINUM PANEL SIGNS	934.60	SQFT		\$	
2530	06406		SBM ALUM SHEET SIGNS .080 IN	108.00	SQFT		\$	
2540	06407		SBM ALUM SHEET SIGNS .125 IN	304.50	SQFT		\$	
2550	06410		STEEL POST TYPE 1	473.50	LF		\$	
2560	06412		STEEL POST MILE MARKERS	8.00	EACH		\$	
2570	06441		GMSS GALV STEEL TYPE C	3,150.00	LB		\$	
2580	06490		CLASS A CONCRETE FOR SIGNS	9.30	CUYD		\$	
2590	06491		STEEL REINFORCEMENT FOR SIGNS	385.00	LB		\$	
2600	20419ND		ROADWAY CROSS SECTION	7.00	EACH		\$	
2610	21373ND		REMOVE SIGN	13.00	EACH		\$	
2620	21596ND		GMSS TYPE D	4.00	EACH		\$	
2630	24631EC		BARCODE SIGN INVENTORY	70.00	EACH		\$	

### PROPOSAL BID ITEMS

191048

Page 8 of 8

Report Date 7/31/19

#### Section: 0015 - WATERLINE

LINE	BID CODE	ALT	DESCRIPTION	QUANTITY	UNIT	UNIT PRIC	FP	AMOUNT
2640	02220		FLOWABLE FILL	400.00	CUYD		\$	
2650	14003		W CAP EXISTING MAIN	2.00	EACH		\$	
2660	14006		W ENCASMENT STEEL BORED RANGE 1	20.00	LF		\$	
2670	14012		W ENCASMENT STEEL OPEN CUT RANGE 1	790.00	LF		\$	
2680	14023		W FLUSHING ASSEMBLY	2.00	EACH		\$	
2690	14028		W METER 3/4 INCH	1.00	EACH		\$	
2700	14057		W PIPE PVC 03 INCH	1,285.00	LF		\$	
2710	14058		W PIPE PVC 04 INCH	770.00	LF		\$	
2720	14080		W SERV PE/PLST LONG SIDE 3/4 IN	1.00	EACH		\$	
2730	14089		W TAPPING SLEEVE AND VALVE SIZE 1	2.00	EACH		\$	
2740	14092		W TIE-IN 03 INCH	2.00	EACH		\$	
2750	14103		W VALVE 03 INCH	2.00	EACH		\$	
2760	14153		W LEAK DETECTION METER	1.00	EACH		\$	

#### Section: 0016 - TRAINEES

LINE	BID CODE	ALT	DESCRIPTION	QUANTITY	UNIT	UNIT PRIC	FP	AMOUNT
2770	02742		TRAINEE PAYMENT REIMBURSEMENT (1 GROUP 2, 3 OR 4 OPERATOR)	1,400.00	HOUR		\$	
2780	02742		TRAINEE PAYMENT REIMBURSEMENT (1 IRONWORKER)	1,400.00	HOUR		\$	

#### Section: 0017 - DEMOBILIZATION &/OR MOBILIZATION

LINE	BID CODE	ALT	DESCRIPTION	QUANTITY	UNIT	UNIT PRIC	FP	AMOUNT
2790	02568		MOBILIZATION	1.00	LS		\$	
2800	02569		DEMOBILIZATION	1.00	LS		\$	