



CALL NO. 100

CONTRACT ID. 172612

JEFFERSON COUNTY

FED/STATE PROJECT NUMBER NHPP IM 0642 (194)

DESCRIPTION I-64 (MP 1.029) WB RAMP TO I-264 EB

WORK TYPE BRIDGE REPAIRS

PRIMARY COMPLETION DATE 11/15/2017

LETTING DATE: September 29,2017

Sealed Bids will be received electronically through the Bid Express bidding service until 10:00 AM EASTERN DAYLIGHT TIME September 29,2017. Bids will be publicly announced at 10:00 AM EASTERN DAYLIGHT TIME.

NO PLANS ASSOCIATED WITH THIS PROJECT.

DBE CERTIFICATION REQUIRED - 0%

REQUIRED BID PROPOSAL GUARANTY: Not less than 5% of the total bid.

TABLE OF CONTENTS

PART I	SCOPE OF WORK
	<ul style="list-style-type: none">• PROJECT(S), COMPLETION DATE(S), & LIQUIDATED DAMAGES• CONTRACT NOTES• FEDERAL CONTRACT NOTES• EXPEDITE WORK ORDER• SPECIAL NOTE(S) APPLICABLE TO PROJECT• LIQUIDATED DAMAGES• TRAFFIC CONTROL PLAN• SKETCH MAP(S)• BRIDGE DRAWINGS
PART II	SPECIFICATIONS AND STANDARD DRAWINGS
	<ul style="list-style-type: none">• SPECIFICATIONS REFERENCE• SUPPLEMENTAL SPECIFICATION• STANDARD DRAWINGS THAT APPLY
PART III	EMPLOYMENT, WAGE AND RECORD REQUIREMENTS
	<ul style="list-style-type: none">• FEDERAL-AID CONSTRUCTION CONTRACTS - FHWA 1273• NONDISCRIMINATION OF EMPLOYEES• EXECUTIVE BRANCH CODE OF ETHICS• PROJECT WAGE RATES LOCALITY 3 / FEDERAL• NOTICE OF REQUIREMENT FOR AFFIRMATIVE ACTION TO ENSURE EEO JEFFERSON
PART IV	INSURANCE
PART V	BID ITEMS

PART I
SCOPE OF WORK

ADMINISTRATIVE DISTRICT - 05

CONTRACT ID - 172612

NHPP IM 0642 (194)

COUNTY - JEFFERSON

PCN - MB05600641703

NHPP IM 0642 (194)

I-64 (MP 1.029) WB RAMP TO I-264 EB BRIDGE OVER I-64 EBBRIDGE REPAIRS SYP NO. 05-01086.00.

GEOGRAPHIC COORDINATES LATITUDE 38:16:34.00 LONGITUDE 85:48:33.00

COMPLETION DATE(S):

COMPLETED BY 11/15/2017

APPLIES TO ENTIRE CONTRACT

CONTRACT NOTES

PROPOSAL ADDENDA

All addenda to this proposal must be applied when calculating bid and certified in the bid packet submitted to the Kentucky Department of Highways. Failure to use the correct and most recent addenda may result in the bid being rejected.

BID SUBMITTAL

Bidder must use the Department's Expedite Bidding Program available on the Internet web site of the Department of Highways, Division of Construction Procurement. (www.transportation.ky.gov/construction-procurement)

The Bidder must download the bid file located on the Bid Express website (www.bidx.com) to prepare a bid packet for submission to the Department. The bidder must submit electronically using Bid Express.

JOINT VENTURE BIDDING

Joint venture bidding is permissible. All companies in the joint venture must be prequalified in one of the work types in the Qualifications for Bidders for the project. The bidders must get a vendor ID for the joint venture from the Division of Construction Procurement and register the joint venture as a bidder on the project. Also, the joint venture must obtain a digital ID from Bid Express to submit a bid. A joint bid bond of 5% may be submitted for both companies or each company may submit a separate bond of 5%.

UNDERGROUND FACILITY DAMAGE PROTECTION

The contractor shall make every effort to protect underground facilities from damage as prescribed in the Underground Facility Damage Protection Act of 1994, Kentucky Revised Statute KRS 367.4901 to 367.4917. It is the contractor's responsibility to determine and take steps necessary to be in compliance with federal and state damage prevention directives. When prescribed in said directives, the contractor shall submit Excavation Locate Requests to the Kentucky Contact Center (KY811) via web ticket entry. The submission of this request does not relieve the contractor from the responsibility of contacting non-member facility owners, whom shall be contacted through their individual Protection Notification Center. Non-compliance with these directives can result in the enforcement of penalties.

SPECIAL NOTE FOR COMPOSITE OFFSET BLOCKS

Contrary to the Standard Drawings (2016 edition) the Cabinet will allow 6" composite offset blocks in lieu of wooden offset blocks, except as specified on proprietary end treatments and crash cushions. The composite blocks shall be selected from the Cabinet's List of Approved Materials.

REGISTRATION WITH THE SECRETARY OF STATE BY A FOREIGN ENTITY

Pursuant to KRS 176.085(1)(b), an agency, department, office, or political subdivision of the Commonwealth of Kentucky shall not award a state contract to a person that is a foreign entity required by [KRS 14A.9-010](#) to obtain a certificate of authority to transact business in the Commonwealth (“certificate”) from the Secretary of State under [KRS 14A.9-030](#) unless the person produces the certificate within fourteen (14) days of the bid or proposal opening. If the foreign entity is not required to obtain a certificate as provided in [KRS 14A.9-010](#), the foreign entity should identify the applicable exception. Foreign entity is defined within [KRS 14A.1-070](#).

For all foreign entities required to obtain a certificate of authority to transact business in the Commonwealth, if a copy of the certificate is not received by the contracting agency within the time frame identified above, the foreign entity’s solicitation response shall be deemed non-responsive or the awarded contract shall be cancelled.

Businesses can register with the Secretary of State at <https://secure.kentucky.gov/sos/ftbr/welcome.aspx>.

SPECIAL NOTE FOR PROJECT QUESTIONS DURING ADVERTISEMENT

Questions about projects during the advertisement should be submitted in writing to the Division of Construction Procurement. This may be done by fax (502) 564-7299 or email to kytc.projectquestions@ky.gov. The Department will attempt to answer all submitted questions. The Department reserves the right not to answer if the question is not pertinent or does not aid in clarifying the project intent.

The deadline for posting answers will be 3:00 pm Eastern Daylight Time, the day preceding the Letting. Questions may be submitted until this deadline with the understanding that the later a question is submitted, the less likely an answer will be able to be provided.

The questions and answers will be posted for each Letting under the heading “Questions & Answers” on the Construction Procurement website (www.transportation.ky.gov/contract). The answers provided shall be considered part of this Special Note and, in case of a discrepancy, will govern over all other bidding documents.

HARDWOOD REMOVAL RESTRICTIONS

The US Department of Agriculture has imposed a quarantine in Kentucky and several surrounding states, to prevent the spread of an invasive insect, the emerald ash borer. Hardwood cut in conjunction with the project may not be removed from the state. Chipping or burning on site is the preferred method of disposal.

INSTRUCTIONS FOR EXCESS MATERIAL SITES AND BORROW SITES

Identification of excess material sites and borrow sites shall be the responsibility of the Contractor. The Contractor shall be responsible for compliance with all applicable state and federal laws and may wish to consult with the US Fish and Wildlife Service to seek protection under Section 10 of the Endangered Species Act for these activities.

ACCESS TO RECORDS

The contractor, as defined in KRS 45A.030 (9) agrees that the contracting agency, the Finance and Administration Cabinet, the Auditor of Public Accounts, and the Legislative Research Commission, or their duly authorized representatives, shall have access to any books, documents, papers, records, or other evidence, which are directly pertinent to this contract for the purpose of financial audit or program review. Records and other prequalification information confidentially disclosed as part of the bid process shall not be deemed as directly pertinent to the contract and shall be exempt from disclosure as provided in KRS 61.878(1)(c). The contractor also recognizes that any books, documents, papers, records, or other evidence, received during a financial audit or program review shall be subject to the Kentucky Open Records Act, KRS 61.870 to 61.884.

In the event of a dispute between the contractor and the contracting agency, Attorney General, or the Auditor of Public Accounts over documents that are eligible for production and review, the Finance and Administration Cabinet shall review the dispute and issue a determination, in accordance with Secretary's Order 11-004.

06/01/16

FEDERAL CONTRACT NOTES

The Kentucky Department of Highways, in accordance with the Regulations of the United States Department of Transportation 23 CFR 635.112 (h), hereby notifies all bidders that failure by a bidder to comply with all applicable sections of the current Kentucky Standard Specifications, including, but not limited to the following, may result in a bid not being considered responsive and thus not eligible to be considered for award:

102.02 Current Capacity Rating 102.10 Delivery of Proposals
102.8 Irregular Proposals 102.14 Disqualification of Bidders
102.9 Proposal Guaranty

CIVIL RIGHTS ACT OF 1964

The Kentucky Department of Highways, in accordance with the provisions of Title VI of the Civil Rights Act of 1964 (78 Stat. 252) and the Regulations of the Federal Department of Transportation (49 C.F.R., Part 21), issued pursuant to such Act, hereby notifies all bidders that it will affirmatively insure that the contract entered into pursuant to this advertisement will be awarded to the lowest responsible bidder without discrimination on the ground of race, color, or national origin.

NOTICE TO ALL BIDDERS

To report bid rigging activities call: 1-800-424-9071.

The U.S. Department of Transportation (DOT) operates the above toll-free "hotline" Monday through Friday, 8:00 a.m. to 5:00 p.m. eastern time. Anyone with knowledge of possible bid rigging, bidder collusion, or other fraudulent activities should use the "hotline" to report such activities.

The "hotline" is part of the DOT's continuing effort to identify and investigate highway construction contract fraud and abuse and is operated under the direction of the DOT Inspector General. All information will be treated confidentially and caller anonymity will be respected.

SECOND TIER SUBCONTRACTS

Second Tier subcontracts on federally assisted projects shall be permitted. However, in the case of DBE's, second tier subcontracts will only be permitted where the other subcontractor is also a DBE. All second tier subcontracts shall have the consent of both the Contractor and the Engineer.

DISADVANTAGED BUSINESS ENTERPRISE PROGRAM

It is the policy of the Kentucky Transportation Cabinet (“the Cabinet”) that Disadvantaged Business Enterprises (“DBE”) shall have the opportunity to participate in the performance of highway construction projects financed in whole or in part by Federal Funds in order to create a level playing field for all businesses who wish to contract with the Cabinet. To that end, the Cabinet will comply with the regulations found in 49 CFR Part 26, and the definitions and requirements contained therein shall be adopted as if set out verbatim herein.

The Cabinet, contractors, subcontractors, and sub-recipients shall not discriminate on the basis of race, color, national origin, or sex in the performance of work performed pursuant to Cabinet contracts. The contractor shall carry out applicable requirements of 49 CFR 26 in the award and administration of federally assisted highway construction projects. The contractor will include this provision in all its subcontracts and supply agreements pertaining to contracts with the Cabinet.

Failure by the contractor to carry out these requirements is a material breach of its contract with the Cabinet, which may result in the termination of the contract or such other remedy as the Cabinet deems necessary.

DBE GOAL

The Disadvantaged Business Enterprise (DBE) goal established for this contract, as listed on the front page of the proposal, is the percentage of the total value of the contract.

The contractor shall exercise all necessary and reasonable steps to ensure that Disadvantaged Business Enterprises participate in a least the percent of the contract as set forth above as goals for this contract.

OBLIGATION OF CONTRACTORS

Each contractor prequalified to perform work on Cabinet projects shall designate and make known to the Cabinet a liaison officer who is assigned the responsibility of effectively administering and promoting an active program for utilization of DBEs.

If a formal goal has not been designated for the contract, all contractors are encouraged to consider DBEs for subcontract work as well as for the supply of material and services needed to perform this work.

Contractors are encouraged to use the services of banks owned and controlled by minorities and women.

CERTIFICATION OF CONTRACT GOAL

Contractors shall include the following certification in bids for projects for which a DBE goal has been established. BIDS SUBMITTED WHICH DO NOT INCLUDE CERTIFICATION OF DBE PARTICIPATION WILL NOT BE ACCEPTED. These bids will not be considered for award by the Cabinet and they will be returned to the bidder.

“The bidder certifies that it has secured participation by Disadvantaged Business Enterprises (“DBE”) in the amount of ____ percent of the total value of this contract and that the DBE participation is in compliance with the requirements of 49 CFR 26 and the policies of the Kentucky Transportation Cabinet pertaining to the DBE Program.”

The certification statement is located in the electronic bid file. All contractors must certify their DBE participation on that page. DBEs utilized in achieving the DBE goal must be certified and prequalified for the work items at the time the bid is submitted.

DBE PARTICIPATION PLAN

Lowest responsive bidders must submit the *DBE Plan/ Subcontractor Request*, form TC 14-35 DBE, within **5** days of the letting. This is necessary before the Awards Committee will review and make a recommendation. **The project will not be considered for award prior to submission and approval of the apparent low bidder’s DBE Plan/Subcontractor Request.**

The DBE Participation Plan shall include the following:

- 1 Name and address of DBE Subcontractor(s) and/or supplier(s) intended to be used in the proposed project;
- 2 Description of the work each is to perform including the work item , unit, quantity, unit price and total amount of the work to be performed by the individual DBE. The Project Code Number (PCN), Category Number, and the Project Line Number can be found in the “material listing” on the Construction Procurement website under the specific letting;
- 3 The dollar value of each proposed DBE subcontract and the percentage of total project contract value this represents. DBE participation may be counted as follows; a) If DBE suppliers and manufactures assume actual and contractual responsibility, the dollar value of materials to be furnished will be counted toward the goal as follows:
 - The entire expenditure paid to a DBE manufacturer;
 - 60 percent of expenditures to DBE suppliers that are not manufacturers provided the supplier is a regular dealer in the product involved. A regular dealer must be engaged in, as its principal business and in its own name, the sale of products to the public, maintain an inventory and own and operate distribution equipment; and
 - The amount of fees or commissions charged by the DBE firms for a bona fide service, such as professional, technical, consultant, or managerial services and assistance in the procurement of essential personnel, facilities, equipment, materials, supplies, delivery of materials and supplies or for furnishing bonds, or insurance, providing such fees or commissions are determined to be reasonable and customary.

- b) The dollar value of services provided by DBEs such as quality control testing, equipment repair and maintenance, engineering, staking, etc.;
 - c) The dollar value of joint ventures. DBE credit for joint ventures will be limited to the dollar amount of the work actually performed by the DBE in the joint venture;
- 4 Written and signed documentation of the bidder's commitment to use a DBE contractor whose participation is being utilized to meet the DBE goal; and
- 5 Written and signed confirmation from the DBE that it is participating in the contract as provided in the prime contractor's commitment.

UPON AWARD AND BEFORE A WORK ORDER WILL BE ISSUED

Contractors must submit the signed subcontract between the contractor and the DBE contractor, the DBE's certificate of insurance, and an affidavit for bidders, offerors, and contractors from the DBE to the Division of Construction Procurement. The affidavit can be found on the Construction Procurement website. If the DBE is a supplier of materials for the project, a signed purchase order and an affidavit for bidders, offerors, and contractors must be submitted to the Division of Construction Procurement.

Changes to DBE Participation Plans must be approved by the Cabinet. The Cabinet may consider extenuating circumstances including, but not limited to, changes in the nature or scope of the project, the inability or unwillingness of a DBE to perform the work in accordance with the bid, and/or other circumstances beyond the control of the prime contractor.

CONSIDERATION OF GOOD FAITH EFFORTS REQUESTS

If the DBE participation submitted in the bid by the apparent lowest responsive bidder does not meet or exceed the DBE contract goal, the apparent lowest responsive bidder must submit a Good Faith Effort Package to satisfy the Cabinet that sufficient good faith efforts were made to meet the contract goals prior to submission of the bid. Efforts to increase the goal after bid submission will not be considered in justifying the good faith effort, unless the contractor can show that the proposed DBE was solicited prior to the letting date. DBEs utilized in achieving the DBE goal must be certified and prequalified for the work items at the time the bid is submitted. One complete set and nine (9) copies of this information must be received in the office of the Division of Contract Procurement no later than 12:00 noon of the tenth calendar day after receipt of notification that they are the apparent low bidder.

Where the information submitted includes repetitious solicitation letters it will be acceptable to submit a sample representative letter along with a distribution list of the firms solicited. Documentation of DBE quotations shall be a part of the good faith effort submittal as necessary to demonstrate compliance with the factors listed below which the Cabinet considers in judging good faith efforts. This documentation may include written subcontractors' quotations, telephone log notations of verbal quotations, or other types of quotation documentation.

The Good Faith Effort Package shall include, but may not be limited to information showing evidence of the following:

- 1 Whether the bidder attended any pre-bid meetings that were scheduled by the Cabinet to inform DBEs of subcontracting opportunities;
- 2 Whether the bidder provided solicitations through all reasonable and available means;
- 3 Whether the bidder provided written notice to all DBEs listed in the DBE directory at the time of the letting who are prequalified in the areas of work that the bidder will be subcontracting;
- 4 Whether the bidder followed up initial solicitations of interest by contacting DBEs to determine with certainty whether they were interested. If a reasonable amount of DBEs within the targeted districts do not provide an intent to quote or no DBEs are prequalified in the subcontracted areas, the bidder must notify the DBE Liaison in the Office of Minority Affairs to give notification of the bidder's inability to get DBE quotes;
- 5 Whether the bidder selected portions of the work to be performed by DBEs in order to increase the likelihood of meeting the contract goals. This includes, where appropriate, breaking out contract work items into economically feasible units to facilitate DBE participation, even when the prime contractor might otherwise perform these work items with its own forces;
- 6 Whether the bidder provided interested DBEs with adequate and timely information about the plans, specifications, and requirements of the contract;
- 7 Whether the bidder negotiated in good faith with interested DBEs not rejecting them as unqualified without sound reasons based on a thorough investigation of their capabilities. Any rejection should be so noted in writing with a description as to why an agreement could not be reached;
- 8 Whether quotations were received from interested DBE firms but were rejected as unacceptable without sound reasons why the quotations were considered unacceptable. The fact that the DBE firm's quotation for the work is not the lowest quotation received will not in itself be considered as a sound reason for rejecting the quotation as unacceptable. The fact that the bidder has the ability and/or desire to perform the contract work with its own forces will not be considered a sound reason for rejecting a DBE quote. Nothing in this provision shall be construed to require the bidder to accept unreasonable quotes in order to satisfy DBE goals;
- 9 Whether the bidder specifically negotiated with subcontractors to assume part of the responsibility to meet the contract DBE goal when the work to be subcontracted includes potential DBE participation;
- 10 Whether the bidder made any efforts and/or offered assistance to interested DBEs in obtaining the necessary equipment, supplies, materials, insurance and/or bonding to satisfy the work requirements of the bid proposal; and
- 11 Any other evidence that the bidder submits which may show that the bidder has made reasonable good faith efforts to include DBE participation.

FAILURE TO MEET GOOD FAITH REQUIREMENT

Where the apparent lowest responsive bidder fails to submit sufficient participation by DBE firms to meet the contract goal and upon a determination by the Good Faith Committee based upon the information submitted that the apparent lowest responsive bidder failed to make sufficient reasonable efforts to meet the contract goal, the bidder will be offered the opportunity to meet in person for administrative reconsideration. The bidder will be notified of the Committee's decision within 24 hours of its decision. The bidder will have 24 hours to request reconsideration of the Committee's decision. The reconsideration meeting will be held within two days of the receipt of a request by the bidder for reconsideration.

The request for reconsideration will be heard by the Office of the Secretary. The bidder will have the opportunity to present written documentation or argument concerning the issue of whether it met the goal or made an adequate good faith effort. The bidder will receive a written decision on the reconsideration explaining the basis for the finding that the bidder did or did not meet the goal or made adequate Good Faith efforts to do so.

The result of the reconsideration process is not administratively appealable to the Cabinet or to the United States Department of Transportation.

The Cabinet reserves the right to award the contract to the next lowest responsive bidder or to rebid the contract in the event that the contract is not awarded to the low bidder as the result of a failure to meet the good faith requirement.

SANCTIONS FOR FAILURE TO MEET DBE REQUIREMENTS OF THE PROJECT

Failure by the prime contractor to fulfill the DBE requirements of a project under contract or to demonstrate good faith efforts to meet the goal constitutes a breach of contract. When this occurs, the Cabinet will hold the prime contractor accountable, as would be the case with all other contract provisions. Therefore, the contractor's failure to carry out the DBE contract requirements shall constitute a breach of contract and as such the Cabinet reserves the right to exercise all administrative remedies at its disposal including, but not limited to the following:

- Disallow credit toward the DBE goal;
- Withholding progress payments;
- Withholding payment to the prime in an amount equal to the unmet portion of the contract goal; and/or
- Termination of the contract.

PROMPT PAYMENT

The prime contractor will be required to pay the DBE within seven (7) working days after he or she has received payment from the Kentucky Transportation Cabinet for work performed or materials furnished.

CONTRACTOR REPORTING

All contractors must keep detailed records and provide reports to the Cabinet on their progress in meeting the DBE requirement on any highway contract. These records may include, but shall not be limited to payroll, lease agreements, cancelled payroll checks, executed subcontracting agreements, etc. Prime contractors will be required to complete and submit a signed and notarized affidavit (TC 18-7) and copies of checks for any monies paid to each DBE subcontractor or supplier utilized to meet a DBE goal. **These documents must be submitted within 10 days of being paid by the Cabinet.**

Payment information that needs to be reported includes date the payment is sent to the DBE, check number, Contract ID, amount of payment and the check date. Before Final Payment is made on this contract, the Prime Contractor will certify that all payments were made to the DBE subcontractor and/or DBE suppliers.

The Prime Contractor should supply the payment information at the time the DBE is compensated for their work. Form to use is located at:

<http://transportation.ky.gov/Construction/Pages/Subcontracts.aspx>

The prime contractor should notify the KYTC Office of Civil Rights and Small Business Development seven (7) days prior to DBE contractors commencing work on the project. The contact is Melvin Byne and the telephone number is (502) 564-3601.

Photocopied payments and completed, signed and notarized affidavit must be submitted by the Prime Contractor to: Office of Civil Rights and Small Business Development
6th Floor West 200 Mero Street
Frankfort, KY 40622

DEFAULT OR DECERTIFICATION OF THE DBE

If the DBE subcontractor or supplier is decertified or defaults in the performance of its work, and the overall goal cannot be credited for the uncompleted work, the prime contractor may utilize a substitute DBE or elect to fulfill the DBE goal with another DBE on a different work item. If after exerting good faith effort in accordance with the Cabinet's Good Faith Effort policies and procedures, the prime contractor is unable to replace the DBE, then the unmet portion of the goal may be waived at the discretion of the Cabinet.

1/27/2017

LEGAL REQUIREMENTS AND RESPONSIBILITY TO THE PUBLIC – CARGO PREFERENCE ACT (CPA).

(REV 12-17-15) (1-16)

SECTION 7 is expanded by the following new Article:

102.10 **Cargo Preference Act – Use of United States-flag vessels.**

Pursuant to Title 46CFR Part 381, the Contractor agrees

- To utilize privately owned United States-flag commercial vessels to ship at least 50 percent of the gross tonnage (computed separately for dry bulk carriers, dry cargo liners, and tankers) involved, whenever shipping any equipment, material, or commodities pursuant to this contract, to the extent such vessels are available at fair and reasonable rates for United States-flag commercial vessels.

- To furnish within 20 days following the date of loading for shipments originating within the United States or within 30 working days following the date of loading for shipments originating outside the United States, a legible copy of a rated, 'on-board' commercial ocean bill-of-lading in English for each shipment of cargo described in paragraph 1 of this section to both the Contracting Officer (through the prime contractor in the case of subcontractor bills-of-lading) and to the Division of National Cargo, Office of Market Development, Maritime Administration, Washington, DC 20590.

- To insert the substance of the provisions of this clause in all subcontracts issued pursuant to this contract.

EXPEDITE PROJECT WORK ORDER

The Contractor may request that the Department expedite the work order for this project to allow for maximization of time to complete the work. In order for the Department to accomplish this task, the Contractor may be required to “hand carry” all required project documentation to facilitate the process. Immediately UPON NOTIFICATION OF AWARD OF THE CONTRACT, deliver required project documentation to:

Division of Construction Procurement
200 Mero St.
Frankfort, KY 40602

INTERSTATE 64 RAMP – I-64 WB TO I-264 EB
BRIDGE DECK RESTORATION AND PIER CAP PATCHING
CID 172612, JEFFERSON COUNTY
TYPICAL BARRIER WALL ARRANGEMENT (Fast Lane Closure Shown)

BRIDGE	LENGTH (FT)
056B00278N	216

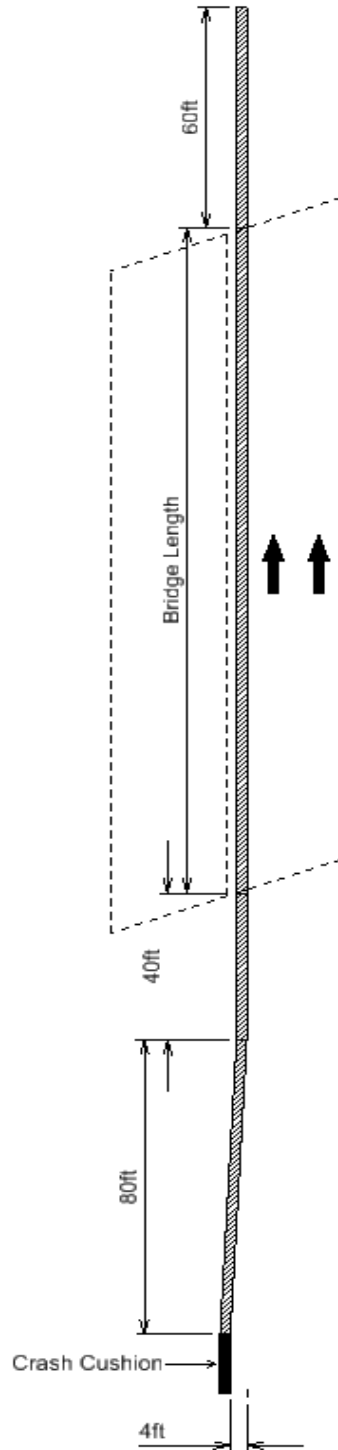

SPECIAL NOTE FOR ELIMINATING TRANSVERSE JOINTS ON BRIDGES

- I. DESCRIPTION.** Perform all work in accordance with the Kentucky Transportation Cabinet, Department of Highway's 2012 Standard Specifications for Road and Bridge Construction.
- Remove existing concrete and existing joint material to eliminate the transverse joint. Install additional reinforcing steel and place concrete.
- II. MATERIALS.**
- A. Class "M" Concrete.** Use either "M1" or "M2". See Section 601.
 - B. Steel Reinforcement.** Use Grade 60. See Section 602.
 - C. Epoxy Bond Coat.** See Section 511.
- III. EQUIPMENT.**
- A. Hammers.** See Section 606.02.10 B.
 - B. Sawing Equipment.** See Section 606.02.10 C.
 - C. Hydraulic Impact Equipment.** See Section 606.02.10 D.
- IV. CONSTRUCTION.**
- A. Remove Existing Materials.** Remove the existing transverse joints, joint filler, and specified areas of concrete as shown on the plans, in accordance with Section 606.02.10 and 606.03.03, and as directed by the Engineer. Clean and leave all existing steel reinforcement encountered in place. Damaged steel reinforcement will be repaired/replaced as directed by the Engineer at no additional cost to the Department. Dispose of all removed material entirely away from the job site. This work is incidental to the contract unit price for "Eliminate Transverse Joint".
 - B. Additional Steel Reinforcement.** Furnish for this work steel reinforcing bars as shown on the plans. Splice these bars to the existing longitudinal reinforcement in the deck and curb/sidewalk in the areas of removed concrete to tie the slabs together as shown on the plans. Ensure that all exposed steel reinforcement is tied in accordance with Section 602.03.04 prior to pouring the new Class "M" concrete.
 - C. Place New Concrete.** Blast clean all areas of existing concrete and structural steel to come in contact with new concrete until free of all laitance and deleterious substances immediately prior to the placement of the Class "M" Concrete. The surface areas of existing concrete to come in contact with the new Class "M" Concrete are to be coated with an epoxy bond coat immediately prior to placing new concrete in accordance with Section 511. The interfaces of the new and old concrete shall be as nearly vertical and horizontal as possible.
Place new Class "M" Concrete to the specified grade and finish to receive the new overlay or as shown on the plans. On the sidewalk and curb, place the new concrete to original grade and finish to match the existing curb/sidewalk.
- V. MEASUREMENT.**
- A. Eliminate Transverse Joint.** The Department will measure the quantity in linear feet from plinth to plinth perpendicular to the centerline of the bridge.

B. Steel Reinforcement. See Section 602.

VI. PAYMENT.

A. Eliminate Transverse Joint. Payment at the contract unit price per linear foot is full compensation for furnishing equipment, labor, tools and materials needed to complete removal and disposal of the specified existing materials, cleaning and straightening of existing steel reinforcement, furnishing and installing the concrete, and all incidental items necessary to complete the work (except the overlay material if specified elsewhere in the contract) within the specified pay limits as indicated on the drawings.

B. Steel Reinforcement. See Section 602.

Residual lead paint may still be on bridge. The Contractor is advised to take all necessary protective measures including worker safety and environmental regulations when executing this work. The Department will not consider any claims based on residual lead paint.

SPECIAL NOTE FOR REPLACING EXPANSION DAMS AND/OR INSTALLING ARMORED EDGES FOR CONCRETE ON BRIDGES

I. DESCRIPTION. Perform all work in accordance with the Kentucky Transportation Cabinet, Department of Highway's 2012 Standard Specifications for Road and Bridge Construction and applicable Supplemental Specifications, the Standard Drawings, this Note, and the attached detail drawings. Section references are to the Standard Specifications.

This work consists of the following: (1) Furnish all labor, materials, tools, and equipment; (2) Remove existing concrete and expansion device(s) and/or bridge ends; (3) Install armored edges and new concrete as specified and in accordance with the attached detail drawings; (4) Install new joint seals (where required); (5) Maintain and control traffic; and (6) Any other work specified as part of this contract.

II. MATERIALS.

A. Class "M" Concrete. Use either "M1" or "M2". See Section 601.

B. Structural Steel. Use new, commercial grade steel suitable for welding. The Engineer will base acceptance on visual inspection.

C. Stud Anchors. The armored edge stud anchors are ¾" embedded stud shear connectors conforming to ASTM A108, Grade 1015 (Nelson Studs or equal).

D. Steel Reinforcement. Use Grade 60. See Section 602.

E. Epoxy Bond Coat. See Section 511.

F. (2" / 2 ½", etc.) Expansion Joint System. It shall have a cellular, or micro-cell, polyurethane foam impregnated with a hydrophobic acrylic emulsion, or a hydrophobic polymer. The polyurethane foam external facing shall be factory coated and cured with highway-grade, fuel resistant silicone or a highway-grade elastomeric coating at a width greater than the maximum joint expansion.

III. EQUIPMENT.

A. Hammers. See Section 606.02.10 B.

B. Sawing Equipment. See Section 606.02.10 C.

C. Hydraulic Impact Equipment. See Section 606.02.10 D.

IV. CONSTRUCTION.

A. Remove Existing Materials. Remove existing Expansion Dam, Bridge End, Armored Edges and specified areas of concrete as shown on the attached sketches. Remove debris and/or expansion joint filler as directed by the Engineer. Clean and leave all existing steel reinforcement encountered in place. Damaged steel reinforcement will be repaired/replaced as directed by the Engineer at no additional cost to the Department.

Dispose of all removed material entirely away from the job site. This work is incidental to the contract unit price for "Expansion Joint Replacement" or "Armored Edge for Concrete".

B. Place New Concrete and Armored Edges. After all specified existing materials have been removed; place new armored edges to match the grade of the proposed overlay or to match the original grade (See attached detail drawings). Place the new Class "M"

concrete to the scarified grade and finish to receive the new overlay or place the new Class "M" concrete to the original grade and finish with broom strokes drawn transversely from curb to curb.

All new structural steel shall be cleaned and painted in accordance with requirements of Section 607.03.23, except that surfaces to come in contact with concrete are not to be painted.

Blast clean all areas of existing concrete and structural steel to come in contact with new concrete until free of all laitance and deleterious substances immediately prior to the placement of the Class "M" Concrete. The surface areas of existing concrete to come in contact with the new Class "M" Concrete are to be coated with an epoxy bond coat immediately prior to placing new concrete in accordance with Section 511. The interfaces of the new and old concrete shall be as nearly vertical and horizontal as possible.

- C. Additional Steel Reinforcement.** Furnish for replacement, as directed by the Engineer, 534.4 linear feet of #4 steel reinforcing bars in 20' lengths. Place these bars in areas deemed by the Engineer to require additional reinforcement. Field cutting and bending is permitted. Do not place any additional steel reinforcement above the height of the top row of Nelson Studs on the armored edges. Ensure that all exposed steel reinforcement is tied in accordance with Section 602.03.04 prior to pouring the new Class "M" concrete. Deliver unused bars to the Local County Maintenance Barn. Payment will be made in accordance with Section 602.
- D. Stage Construction.** Installation of concrete and armored edges in two (or more if specified) stages is necessary. Join the armored edges at or near the centerline of the roadway or lane line, field weld and grind smooth.
- E. (2" / 2 1/2" / etc.) Expansion Joint System.** System shall be installed in accordance with manufacturer's recommendations concerning approved adhesives, welds between sticks and appurtenances, and adhesion to concrete deck or armored edges. Joint seal is to be installed 1/2" recessed from the surface.
- F Shop Plans.** Shop plans will not be required. The Contractor is responsible for obtaining field measurements and supplying properly sized materials to complete the work.

V. MEASUREMENT.

- A. Expansion Joint Replacement – 2".** The Department will measure the quantity in linear feet from gutterline to gutterline along the centerline of the joint.
- B. Armored Edge for Concrete.** The Department will measure the quantity in linear feet from gutterline to gutterline along the face of the bridge end.
- C. Steel Reinforcement.** See Section 602.

VI. PAYMENT.

- A. Expansion Joint Replacement – 2".** Payment at the contract unit price per linear foot is full compensation for removing specified existing materials, furnishing and installing the new armored edges, concrete, neoprene strip seal or pre-compressed horizontal expansion joint system, and all incidental items necessary to complete the work (except the overlay material) within the specified pay limits as specified by this note and as shown on the attached detail drawings.

- B. Armored Edge for Concrete.** Payment at the contract unit price per linear foot is full compensation for removing specified existing materials, furnishing and installing the new armored edges, concrete and all incidental items necessary to complete the work (except the overlay material) within the specified pay limits as specified by this note and as shown on the attached detail drawings.
- C. Steel Reinforcement.** See Section 602.

Residual lead paint may still be on bridge. The Contractor is advised to take all necessary protective measures including worker safety and environmental regulations when executing this work. The Department will not consider any claims based on residual lead paint.

SPECIAL NOTE FOR JACKING AND SUPPORTING BRIDGE SPAN

- I. DESCRIPTION.** Perform all work in accordance with the Kentucky Transportation Cabinet, Department of Highway's 2012 Standard Specifications for Road and Bridge Construction and applicable Supplemental Specifications, the Standard Drawings, this Note, and the attached detail drawing(s). Section references are to the Standard Specifications.

This work consists of the following: (1) Furnish all labor, materials, tools, and equipment; (2) Submit for approval jacking plans, procedures, drawings, and details prepared by a Professional Engineer licensed to practice in the Commonwealth of Kentucky; (3) Jack the entire structure or portions as shown on the detail drawings and provide temporary supports for the duration of the remaining work; (4) Remove jacking and temporary supports when no longer required; (5) Maintain and control traffic; and (6) Any other work specified as part of this contract.

II. CONSTRUCTION.

- A. Working Drawings.** Prior to preparation of jacking plans and working drawings, the Contractor shall verify in the field, conditions and dimensions as necessary to perform the work. The Contractor shall submit to the Engineer for approval, jacking plans, working drawings and design calculations for the jacking and temporary supports. Such plans, drawings, and design calculations shall be prepared, sealed, and signed by an engineer who is licensed to practice in the Commonwealth of Kentucky. The content and number of sets of drawings and design calculations and times for review for temporary supports shall be the same as shown in the Standard Specifications for falsework working drawings. The jacking plan is to provide for a jacking scheme that will limit the load in the jacks to specified loads plus or minus 5%. Jacks are to be sized to provide a safe working load of 1.5 times the required working or jacking load. In addition to a minimum horizontal force of 2% of the dead load reaction of the structure, the Contractor's jacking plan is to include provisions for resisting horizontal loads that may occur as a result of the jacking operations and clearly show methods to resist those loads. The jacking plan is to take into consideration the longitudinal movement of the centerline of bearings as the superstructure is raised. The jacking locations and loads, if shown on the detail drawings, may be revised by the contractor. If not shown on the detail drawings, the contractor shall select jacking locations and/or loads consistent with his proposed jacking plans and procedures. Jacking loads and jack locations required by the Contractor's jacking method shall be shown on the jacking and supporting plan submitted for approval. The contractor is permitted to temporarily remove existing bracing as necessary and to replace said bracing with contractor provided jacking frames, to install contractor provided jacking stiffeners, or otherwise modify the structure, as necessary to implement his jacking plan, with the written approval of the Engineer. If loads are transferred to or if the spans are supported at locations other than those already having appropriate stiffeners or as shown in the detail drawings, the contractor shall provide steel plate or angle jacking stiffeners designed by a

Professional Engineer which meet current AASHTO requirements for bearing stiffeners and which may remain in place at the conclusion of the construction. Jacking stiffeners may be welded or bolted to the beam webs, but must be milled to bear on the top flange at the piers and may be close fit and welded to the flange at other locations. Jacking schemes which require modifications to the structure shall be considered permanent and shall remain in the structure unless otherwise shown in the contract documents or directed by the Engineer. All steel which will remain in the finished structure shall be painted in accordance with the Specifications and notes excepting that paint coats may be shop applied.

B. Jacking and Temporary Support. The jacking operation is to be performed in such a manner that the vertical position of the members supported by the bearings will remain in approximately the same relative position throughout the jacking operation. A maximum of 1/8" relative difference in position is allowed in a lift between any of the jacks and between jacked and unjacked girders. Traffic shall remain on the portion of the structure to be jacked at all times unless otherwise approved by the Engineer. A redundant system of supports shall be provided during the entire jacking operation for backup should any of the jacks fail. The redundant system shall include stacks of steel plates or other steel sections added as necessary to maintain the redundant supports at each jack location within 1/4" of the jacking sill or corbels.

Each jack shall be equipped with either a pressure gage or a load cell for determining the jacking force. Pressure gages shall have an accurately reading dial at least 6" in diameter. Each jack shall be calibrated by a private laboratory within 6 months prior to use. Each jack and its gage shall be calibrated as a unit with the cylinder extension in the approximate position that it will be in at final jacking force and shall be accompanied by a certified calibration chart. Load cells shall be calibrated and provided with an indicator by which the jacking force is determined.

Vandal-resistant displacement monitoring equipment shall be provided and maintained. Vertical and horizontal displacements of the temporary supports and the existing structure shall be monitored continuously during jacking operations and shall be accurately measured and recorded at least weekly during removal and reconstruction work. As a minimum, elevations shall be taken prior to the start of jacking operations, immediately after jacking is complete, before permanently re-connecting the superstructure to the substructure, and after the temporary supports have been removed. As a minimum, the existing structure shall be monitored at the abutments, piers, and at mid-point of spans. Control points at each location shall be located near the center and the superstructure gutterlines. The records of vertical and horizontal displacement shall be delivered to the Engineer at the completion of the work described herein.

A force equal to the initial jacking load or the dead load shown on the plans shall be applied to the structure by the temporary support system and the force held until all initial compression and settlement of the system is complete. The structure shall then be lifted by the jacks to the final position and the force held until the temporary

support system is installed and the system is stable, before remaining work at the location being supported is begun.

Jacking operations shall be carefully controlled and monitored to ensure that the jacking loads are applied in a manner to prevent distortion and excessive stresses that would damage the structure. The superstructure shall be jacked as necessary to maintain the total vertical displacements at control points to less than 1/4" from the elevations recorded prior to jacking plus the desired jacking height as shown on the plans or as modified by the Engineer. For bearing replacements and when no other desired jacking height is shown in the plans, detail drawings, or notes, the superstructure shall be jacked only as necessary to facilitate removal and replacement of the bearings and in no case more than 1/4" if traffic is to remain on the structure during the work.

Should unanticipated displacements, cracking or other damage occur, the construction shall be discontinued until corrective measures satisfactory to the Engineer are performed. Damage to the structure as a result of the Contractor's operations shall be repaired by the Contractor at no expense to the Department.

Following completion of the reconstruction, the monitored control points shall not deviate from the vertical position by more than 1/4" from the initial survey elevations or the elevations as modified by the Engineer or detail drawing(s).

IV MEASUREMENT.

A. Jacking and Supporting Bridge Span. The Department will not measure the quantity.

V. PAYMENT.

A. Jacking and Supporting Bridge Span. Payment at the contract lump sum price is for any and all jacking and support operations required by this project unless otherwise noted, including all labor, materials, manufactured assemblies, furnishing and operating jacks, plates, jacking stiffeners, jacking beams, painting, etc. and all incidental items necessary to complete the work in accordance with this Note, the Standard Specifications, and as shown on the attached detail drawing(s) or as directed by the Engineer.

SPECIAL NOTE FOR BRIDGE RESTORATION AND WATERPROOFING WITH CONCRETE OVERLAYS

- I. DESCRIPTION.** Perform all work in accordance with the Kentucky Transportation Cabinet, Department of Highway's 2012 Standard Specifications for Road and Bridge Construction and applicable Supplemental Specifications, the Standard Drawings, this Note, and the attached detail drawings. Section references are to the Standard Specifications.

This work consists of the following: (1) Furnish all labor, materials, tools, and equipment; (2) Remove the existing overlay; (3) Complete full-depth and partial depth repairs as directed by the Engineer; (4) Repair/replace damaged and corroded reinforcing bars; (5) Place new concrete overlay and epoxy-sand slurry in accordance with Section 606; (6) Complete asphalt/concrete approach pavement for the north side only; (7) Maintain and control traffic; and (8) Any other work specified as part of this contract.

All construction will be in accordance with Section 606 unless otherwise specified.

II. MATERIALS.

- A. Latex Concrete.** See Section 606.03.17.
- B. Class "M" Concrete.** Use either "M1" or "M2". See Section 601.
- C. Bituminous Asphalt.** Use CL2 ASPH SURF 0.38D PG64-22.
- D. Epoxy-Sand Slurry.** See Section 606.03.10.

III. CONSTRUCTION.

- A. Remove Existing Overlay.** In addition to Section 606.03.03, totally remove the existing concrete overlay by milling.
- B. Partial Depth Slab Repair and Latex Overlay.** Remove areas determined to be unsound by the Engineer via hydrodemolition or via hand held jackhammers weighing less than 45lbs in accordance with Section 606.02.10 D. Repair/Replace all damaged or severely corroded reinforcing bars prior to partial depth repair operation. The Department will not measure material removal and will consider this work incidental to the bid item "PARTIAL DEPTH PATCHING". Mix and place Latex Modified Concrete Overlay in accordance with Sections 606.03.08 and 606.03.17.
- C. Asphalt/Concrete Approach Pavement.** Mill only the north side existing asphalt approach for a distance of 50' from the bridge end. For the rigid approach (south), repair any damaged rigid approach with Class M concrete. Remove the bituminous material uniformly by making an edge key, so as to provide a smooth transition to the finished bridge when a new bituminous overlay of compacted depth of approximately 1½" is added to the approaches. The grinding depth may vary depending of the condition of the existing approach and final elevation of bridge end. Dispose of all removed material away from the site.
- D. Surface Texturing.** Texture the concrete surface of the overlay in accordance with Section 609.03.10.

IV. MEASUREMENT. See Section 606 and the following:

A. Latex Modified Concrete for Overlay. The Department will measure the quantity in cubic yards using the theoretical volume as follows for each bridge:

$$056B00278N \quad (216' \times 28' \times 1.5') = 28.0 \text{ cuyd}$$

B. Latex Modified Concrete for Partial Depth Patching and variable thickness of Overlay. The Department will measure the quantity in cubic yards by deducting the theoretical volume of bridge deck overlay (LMC) from the total volume (as indicated by the batch quantity tickets) of Concrete required to obtain the finished grade shown on the Plans or established by the Engineer.

C. Remove Existing Overlay. The Department will measure the removal of the existing overlay in square yards, which shall include all labor, equipment, and material needed to complete this work.

D. Steel Reinforcement. The Department will measure any reinforcing steel necessary for the partial or full depth patch in pounds, which shall include all labor, equipment, and material needed to complete this work.

E. Asphalt/Concrete Approach Pavement. The Department will measure the quantity in square yards, which shall include all labor, equipment, and material needed to complete this work.

V. PAYMENT. See Section 606 and the following:

A. Latex Modified Concrete for Overlay. The Department will make payment for the Latex Modified Concrete under bid item #08534 "CONCRETE OVERLAY – LATEX" for the theoretical quantity.

B. Latex Modified Concrete for Partial Depth Patching and variable thickness of Overlay. The Department will make payment for the Partial Depth Patching under bid item #24094EC "PARTIAL DEPTH PATCHING". Payment will be for the quantity per cubic yard complete in place.

C. Remove Existing Overlay. The Department will make payment for the removal of the existing overlay under the bid item #08510 "REM EPOXY BIT FOREIGN OVERLAY". Payment will be for the square yard complete.

D. Steel Reinforcement. The Department will make payment for steel reinforcement, if necessary, under bid item #08150 "STEEL REINFORCEMENT". Payment will be at the unit price per pound.

E. Asphalt/Concrete Approach Pavement. The Department will make payment for the completed and accepted quantity of this work under the bid item #03304 "BRIDGE OVERLAY APPROACH PAVEMENT".

SPECIAL NOTE FOR CONTRACT COMPLETION DATE AND LIQUIDATED DAMAGES ON BRIDGE REPAIR CONTRACTS

- I. COMPLETION DATE.** The Contractor has the option of selecting the starting date for this Contract. Once selected, notify the Department in writing of the date selected at least two weeks prior to beginning work. All work is to be completed by November 15, 2017. An allotted number of Calendar days are assigned to each structure in this contract as shown below.

<u>TYPE OF WORK</u>	<u>ALLOTTED TIME</u>	<u>COMPLETION DATE</u>
Overlay/Deck work	One weekend (57 hours)	November 15, 2017
Pier cap end work	n/a	November 15, 2017

Contrary to Section 108.07.02, the Engineer will begin charging calendar days for a structure on the day the Contractor starts work or sets up traffic control on that particular structure.

- II. LIQUIDATED DAMAGES.** Liquidated damages will be assessed the Contractor in accordance with the Transportation Cabinet, Department of Highway’s 2012 Standard Specifications for Road and Bridge Construction, Section 108.09, when either the allotted number of calendar days or the November 15, 2017 date is exceeded.

Contrary to the Standard Specifications, liquidated damages will be assessed to the Contractor during the months of December, January, February and March when the contract time has expired on any individual bridge or bridges. Contract time will be charged during these months.

All construction must be completed in accordance with the weather limitations specified in Section 606 and/or Section 601 as applicable. No extension of Contract time will be granted due to inclement weather or temperature limitations that occur due to starting work on the Contract or a structure late in the construction season.

SPECIAL NOTE FOR TRAFFIC CONTROL ON BRIDGE REPAIR CONTRACTS

I. TRAFFIC CONTROL GENERAL

Except as provided herein, traffic shall be maintained in accordance with the 2012 Standard Specifications, Section 112. Except for the roadway and traffic control bid items listed, all items of work necessary to maintain and control traffic will be paid at the lump sum bid price to "Maintain and Control Traffic".

Contrary to Section 106.01, traffic control devices used on this project may be new or used in new condition, at the beginning of the work and maintained in like new condition until completion of the work.

II. TRAFFIC COORDINATOR

Furnish a Traffic Coordinator as per Section 112. The Traffic Coordinator shall inspect the project maintenance of traffic, at least three times daily, or as directed by the Engineer, during the Contractor's operations and at any time a lane closure is in place. The personnel shall have access on the project to a radio or telephone to be used in case of emergencies or accidents.

The Traffic Coordinator shall report all incidents throughout the work zone to the Engineer on the project. The Contractor shall furnish the name and telephone number where the Traffic Coordinator can be contacted at all times.

III. SIGNS

Contrary to Section 112.04.02, only long term signs (sign intended to be continuously in place for more than 3 days) will be measured for payment; short term signs (signs intended to be left in place for 3 days or less) will not be measured for payment but will be incidental to Maintain and Control Traffic.

The contractor is to install warning signs for wide loads in advance of the bridge under the direction of the Engineer. The Department will not measure installation, maintenance, or removal for payment, and will consider these incidentals to Maintain and Control Traffic.

IV. TEMPORARY PAVEMENT STRIPING

Skip lines and/or solid lines through the length of the tapers for lane closures and other striping as directed by the Engineer shall be temporarily covered with 6" black removable tape. Permanent removal of all other pavement striping for traffic control shall be considered incidental to Maintain and Control Traffic. Temporary pavement striping shall be paid only once per course in accordance with Section 112.04.07. The Contractor shall replace any temporary striping that becomes damaged or fails to adhere to the pavement before dark on the day of the notification. Liquidated damages shall be assessed to the Contractor at a rate of \$500 per day for failing to replace temporary striping within this time limit.

V. PROJECT PHASING & CONSTRUCTION PROCEDURES

The Contractor shall maintain one lane of traffic on the I-64 westbound ramp to I-264 eastbound and the intersecting I-64 eastbound road at all times in accordance with Standard Drawing No. TTC-120.

All work to repair the pier cap end shall be completed in lane closures from 6:00pm to 6:00am. Lane closure on I-64 eastbound is only permitted during the “12 hour lane closure” periods. Lane and shoulder closures on I-64 eastbound will not be permitted at any other times.

All work on the bridge deck shall be completed during weekend lane closures from 8:00pm on Friday to 5:00am the following Monday (57 hours). Lane and shoulder closures for deck work will not be permitted at any other times.

The Contractor may extend the barrier wall length for additional buffer zones for construction activities at no cost to the Department.

The clear lane width required is:

<u>Structure</u>	<u>Clear Lane Width</u>
056B000278N	<u>11.5 feet</u>
Intersecting I-64 EB	<u>12 feet</u>

VI. BARRIER WALL

Barrier wall shall only be used on 056B000278N (I-64 WB ramp to I-264 EB). Payment of the contract unit price per linear foot for "CONCRETE BARRIER WALL TYPE 9T" shall be full compensation for furnishing, installing, maintaining, adjusting alignment as needed, removing the barrier when no longer needed, and all incidental items necessary to complete the work.

Provide one side mounted barrier wall delineator per each section of barrier. See Standard Drawing RBM-020 for types. No direct payment allowed for delineators.

VII. CRASH CUSHION / END TREATMENTS

To the satisfaction of the Engineer extend Barrier wall out of the clear zone. If Barrier wall is not extended out of the clear zone to the satisfaction of the engineer provide crash cushions / end treatments for the barrier wall.

Provide Barrier end treatments that comply with NCHRP 350 LEVEL 3.

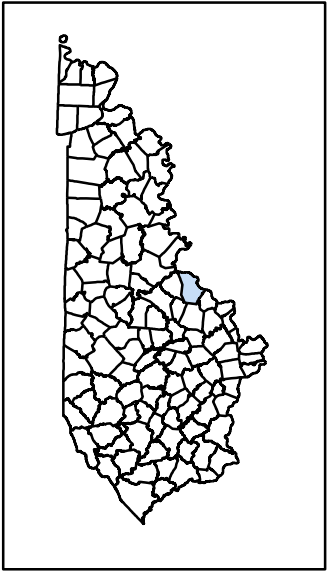

JEFFERSON COUNTY

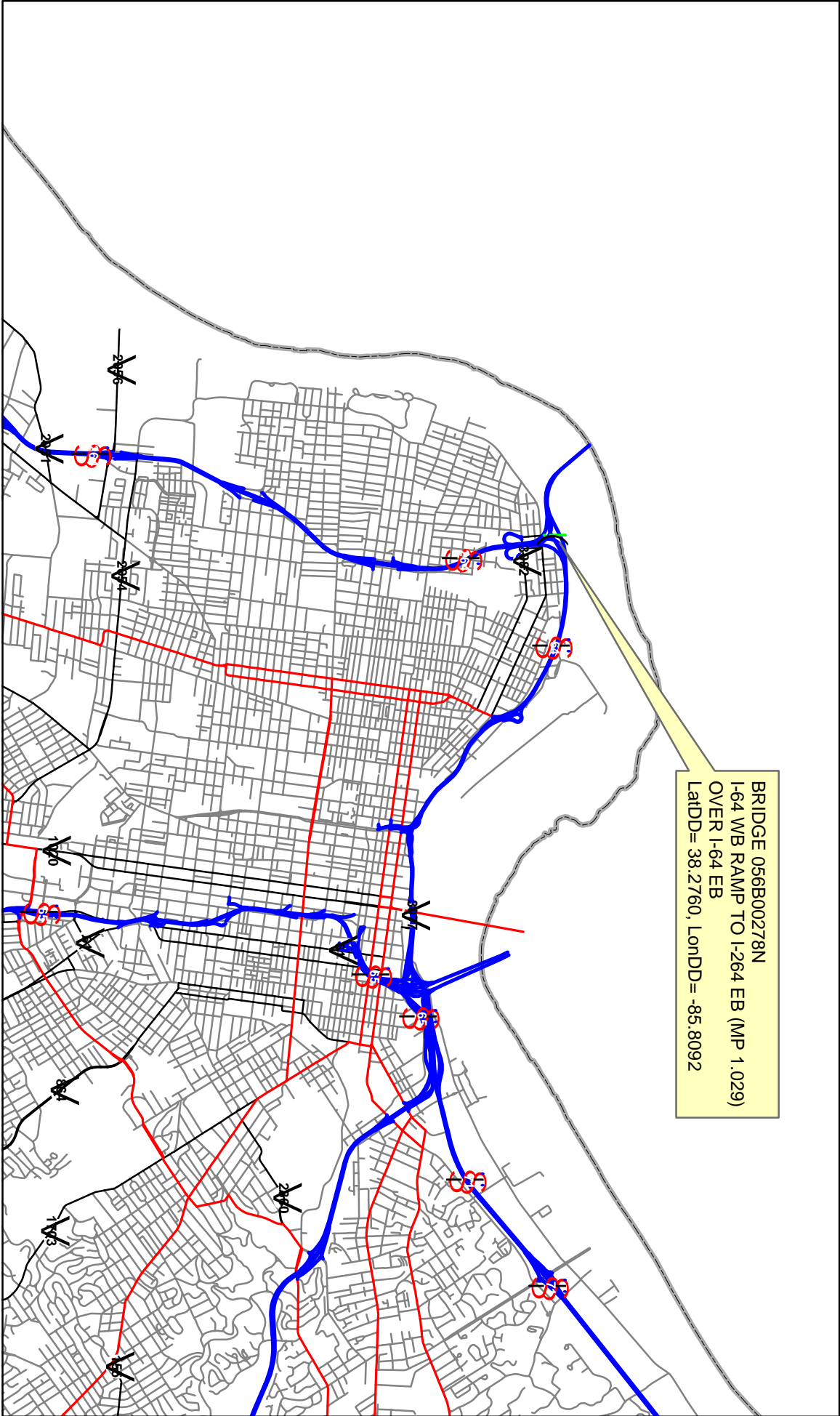

BRIDGE 056B00278N
I-64 WB RAMP TO I-264 EB (MP 1.029)
OVER I-64 EB
LatDD= 38.2760, LonDD= -85.8092

NEW ALBANY BRIDGE APPROACH INTERCHANGE
 E - S RAMP OVER W - E RAMP

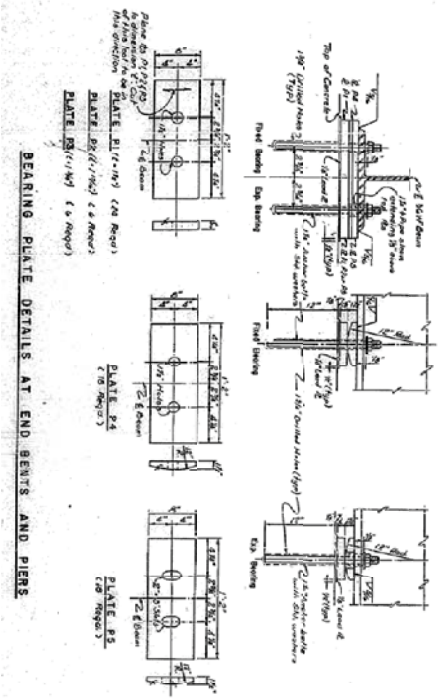
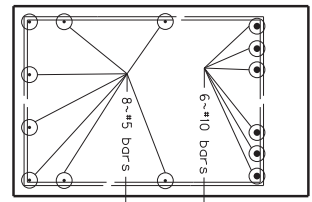
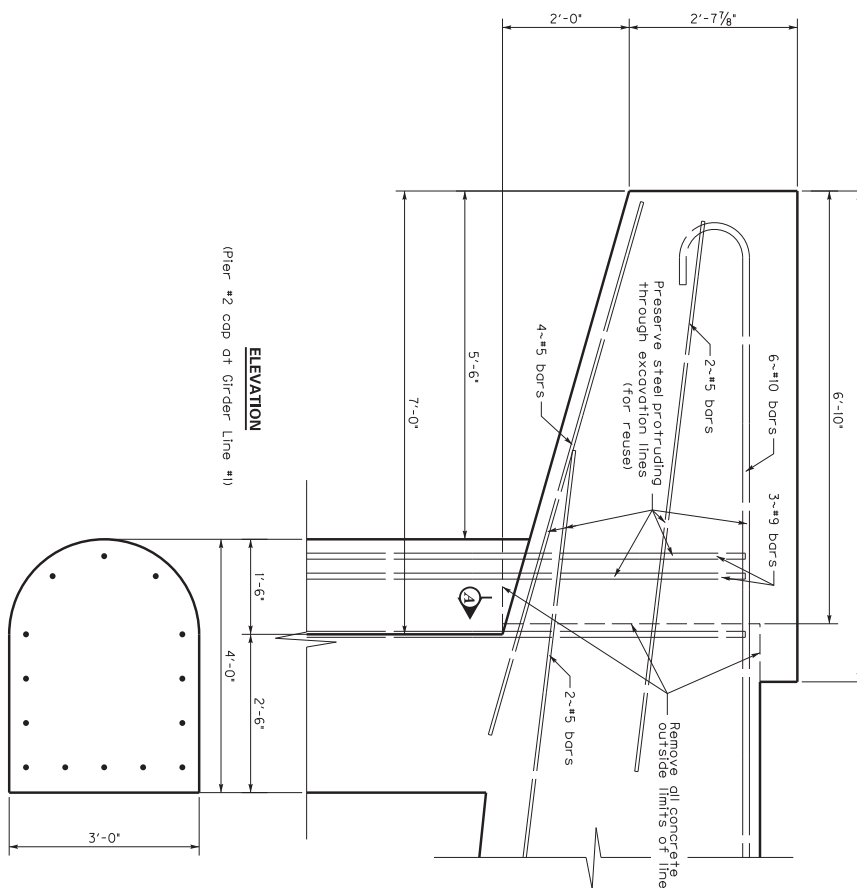
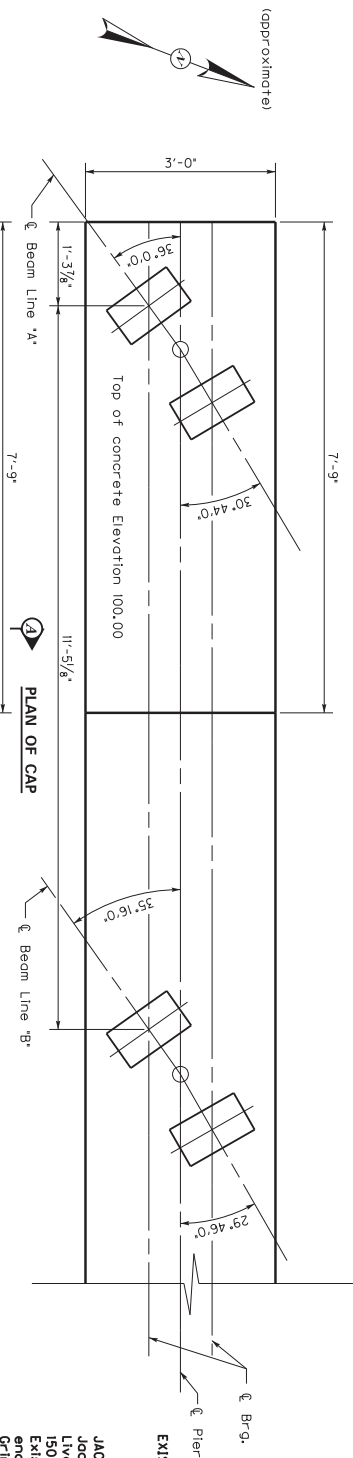

NOTES

EXISTING PLANS: Are on Drawing Number 14612. See for more details.

JACK AND SUPPORT: The ends of the beams at pier #2 for beam line #A jacks need to be able to support 150% of the dead load. Live load is to be kept off this portion of the bridge. 150% of the dead load is approximately 33 tons. Existing anchor bolts and bearing plates at pier #2 beam line #A beam ends are to be trashed. Remove the nuts from the 1/4" anchor bolts. Grind off the 3/8" fillet welds attaching plate P5. Jack the beam ends enough to get the weight off the end of the pier cap, but not so much that you tear something up. 1/8" vertically is probably adequate.

CONCRETE REMOVAL: Sawcut the concrete 1/2" to 1" deep at the line limits shown on the elevation view. Then hammer out all the concrete outside the limits of those cut lines. Take care to preserve the steel passing through the line limits labeled on the elevation view and detailed in the existing plans.

If any of these bars are damaged such that their structural integrity is compromised, they must be replaced in kind by drilling and grouting. Method of full tensile capacity of bar at existing concrete interfaces.

span 2, Pier 2 Br-g. Ht. is 1.5' + 1.75' + 0.125' = 3 3/8' (3.375')
 span 3, Pier 2 Br-g. Ht. is 1.5' + 1.5' + 0.125' = 3 1/8' (3.125')

DATE	REVISION	CHECKED BY	DATE

DESIGNED BY: _____
 CHECKED BY: _____
 DETAILED BY: _____

COMMUNICABLE of Kentucky
 DEPARTMENT OF HIGHWAYS
 COUNTY

ROUTE _____ CROSSING _____

ITEM NUMBER	PREPARED BY	SHEET NO.
	Division of Structural Design	

MicroStation v8.11.7.443 USER: sssuser DATE PLOTTED: sssDATE sss FILE NAME: sssdesignfile\specification sss

BEAM END BEARING ASSEMBLIES
(Span 2 and Span 3 bearing at pier 2)

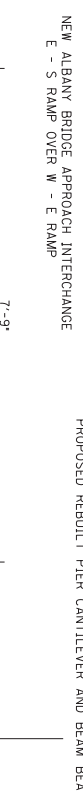
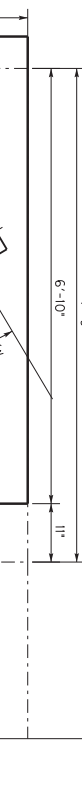
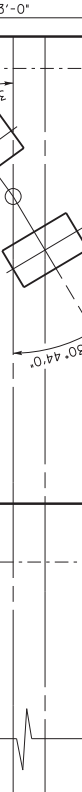
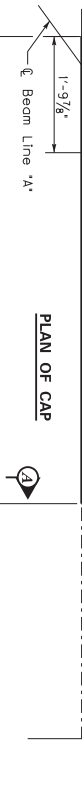
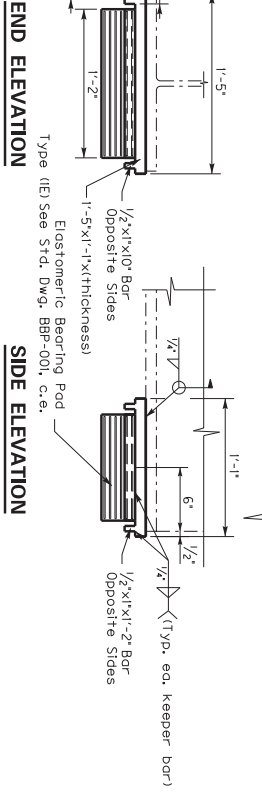

PROPOSED REBUILT PIER CANTILEVER AND BEAM BEARINGS

New Br-g. Assembly Heights
 span 2, Pier 2 Br-g. Ht. is 1.25' (top plate) + 3.18' (type 1E Br-g. pod) = 4.43'
 span 3, Pier 2 Br-g. Ht. is 1' (top plate) + 3.18' (type 1E Br-g. pod) = 4.18'
 See Std. Dwg. BBP-001-12 c.e.
 New seat elevation is 4.43'-3.375' = 1.055' (0.088') lower than existing.
 New seat elevation is 100.00' - 0.088' = 99.912'.

Note: P16 bars are detailed for 1'-0' embedment into existing concrete. Method of drilling and grouting must allow full tensile capacity of bar. If method requires more or less than 1'-0' embedment adjust order of bar accordingly.

NOTE: Distances to bars shown are clear dimensions unless otherwise

MATERIAL SPECIFICATIONS:
 Concrete, Class 'A' = 3500 psi
 Steel Reinforcement = Grade 60

BILL OF REINFORCEMENT

MARK	TYPE	NO.	SIZE	LENGTH	A	B
P1	14S	1	5	11'-5"	2'-9 7/8"	2'-8"
P2	14S	1	3	11'-7"	2'-10 7/8"	2'-8"
P3	14S	1	3	12'-10"	3'-10"	2'-8"
P4	14S	1	3	12'-0"	3'-2 1/4"	2'-8"
P5	14S	1	5	12'-0"	3'-2 1/4"	2'-8"
P6	14S	1	5	12'-5"	3'-3 1/4"	2'-8"
P7	14S	1	5	12'-7"	3'-4 1/4"	2'-8"
P8	14S	1	5	12'-10"	3'-6"	2'-8"
P9	14S	1	5	13'-0"	3'-7 1/4"	2'-8"
P10	14S	1	5	13'-2"	3'-8 1/4"	2'-8"
P11	14S	1	5	13'-5"	3'-9 1/4"	2'-8"
P12	14S	1	5	13'-7"	3'-10 1/4"	2'-8"
P13	14S	1	5	13'-10"	4'-0"	2'-8"
P14	14S	1	5	14'-0"	4'-1 1/4"	2'-8"
P15	Str.	5	5	6'-11"	8'-3"	2'-8"
P16	2s	5	5	18'-11"	8'-3"	2'-8"

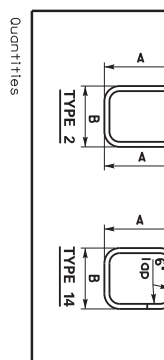

Quantities
 Remove Concrete Masonry - 2.85 cu. yd
 Steel Reinforcement 321lbs.
 Concrete Class 'A' - 3.12 cu. yd
 2 Bearing assemblies

DATE:	DESIGNED BY:	CHECKED BY:	DATE:
DETAILED BY:	Commonwealth of Kentucky DEPARTMENT OF HIGHWAYS COUNTY		
ROUTE:			
CONTRACT:	DIVISION OF Structural Design		
SHEET NO.	DRAWING NO.		

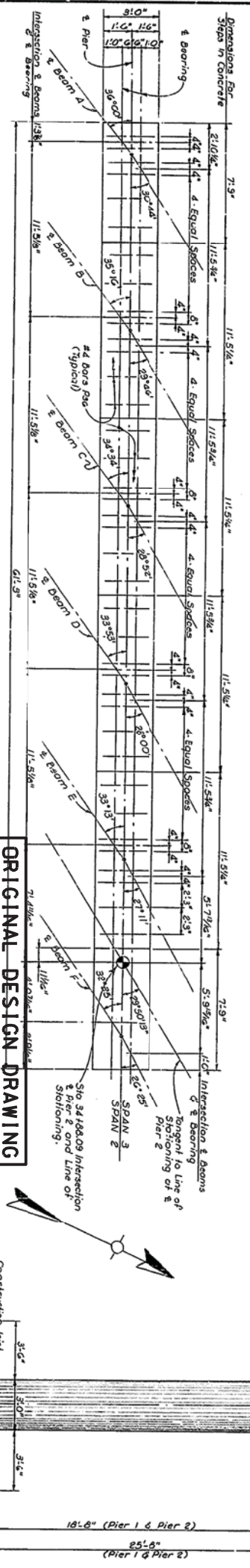
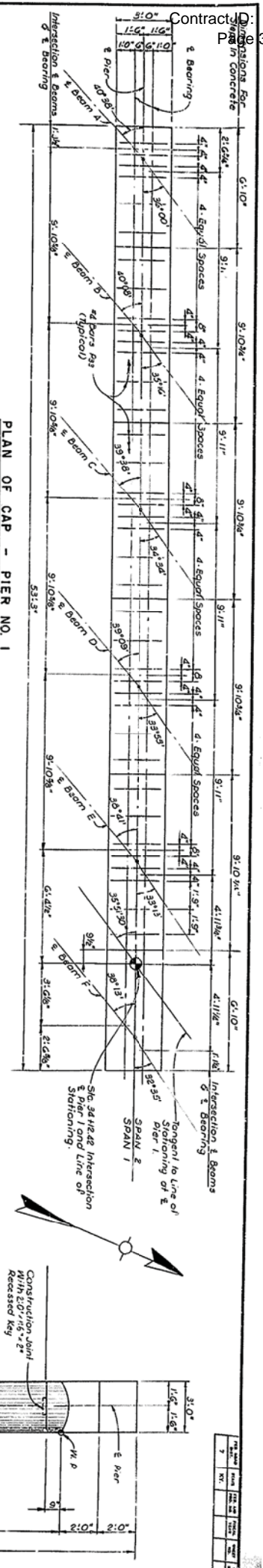

ORIGINAL DESIGN DRAWING
14672 - SHEET 8
FOR REFERENCE ONLY

PLAN OF CAP - PIER NO. 2

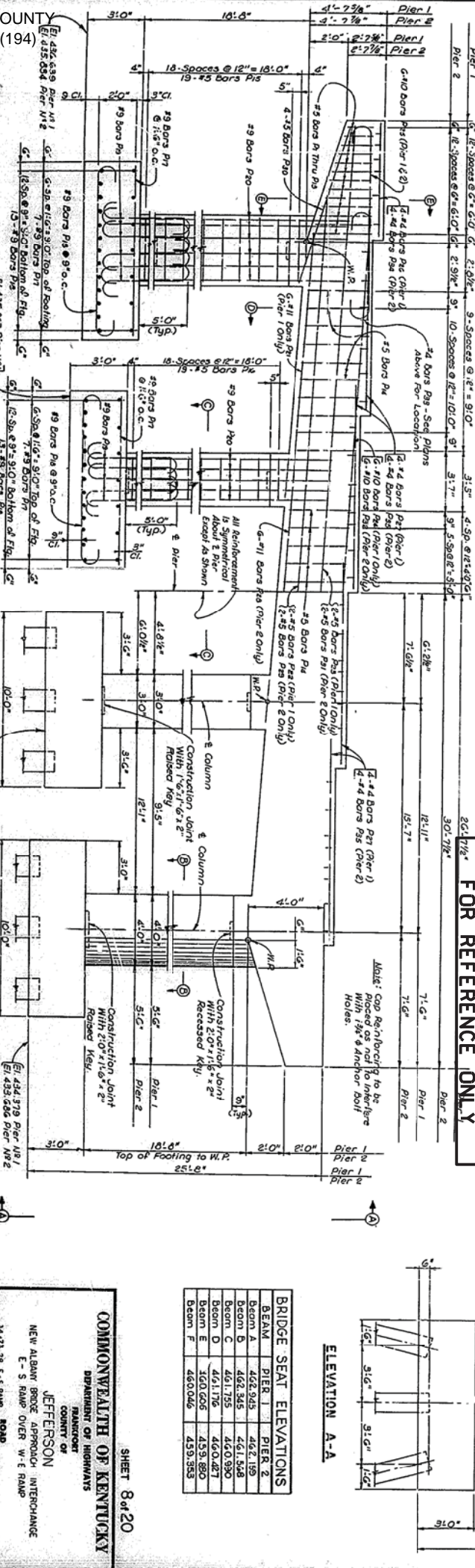

ELEVATION

PIERS 1 & 2

BEAM	PIER 1	PIER 2
Beam A	462.945	462.158
Beam B	462.345	461.548
Beam C	461.755	460.950
Beam D	461.176	460.487
Beam E	460.606	459.880
Beam F	460.046	459.383

ELEVATION A-A

COMMONWEALTH OF KENTUCKY
DEPARTMENT OF HIGHWAYS
JEFFERSON COUNTY
NEW ALBANY BRIDGE APPROACH INTERCHANGE
E - S RAMP OVER W. E. ROAD

SHEET 8 of 20
BRIDGE NUMBER: 34 073.28 E - S RAMP
PROJECT NO.: 14672

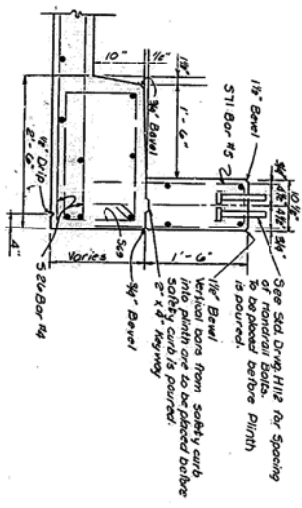
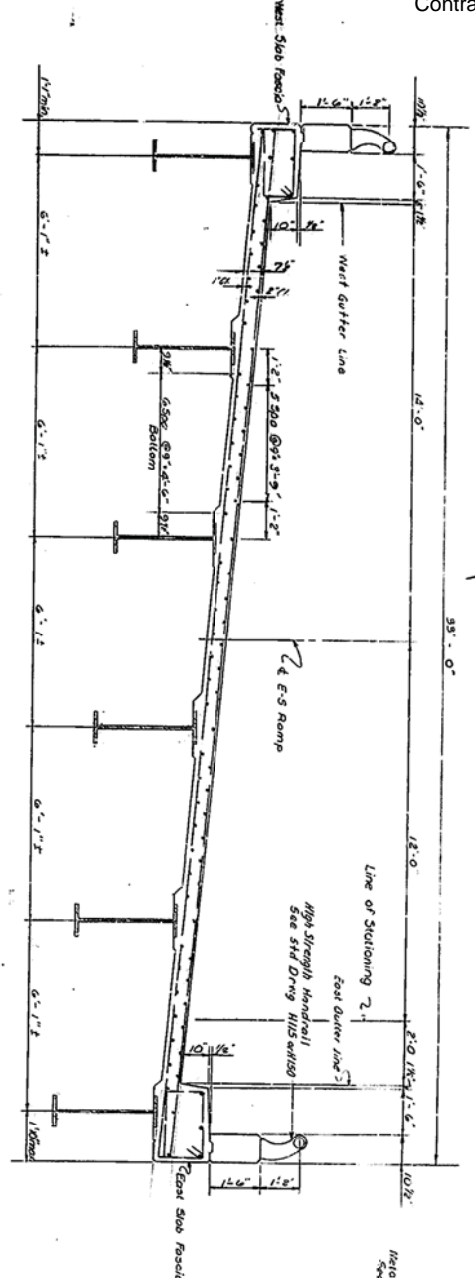

ORIGINAL DESIGN DRAWING
14672- SHEET 13
FOR REFERENCE ONLY

MARK	TYPE	NO.	SIZE	LENGTH	LOCATION	FT. IN	FT. IN
3.54	1	0	1/2	34	3		
3.55	1	8	1/2	34	7		
3.56	1	14	1/2	34	11		
3.57	1	19	1/2	34	15		
3.58	1	14	1/2	34	19		
3.59	1	14	1/2	34	23		
3.60	1	14	1/2	34	27		
3.61	1	14	1/2	34	31		
3.62	1	14	1/2	34	35		
3.63	1	14	1/2	34	39		
3.64	1	14	1/2	34	43		
3.65	1	14	1/2	34	47		
3.66	1	14	1/2	34	51		
3.67	1	14	1/2	34	55		
3.68	1	14	1/2	34	59		
3.69	1	14	1/2	34	63		
3.70	1	14	1/2	34	67		
3.71	1	14	1/2	34	71		
3.72	1	14	1/2	34	75		
3.73	1	14	1/2	34	79		
3.74	1	14	1/2	34	83		
3.75	1	14	1/2	34	87		
3.76	1	14	1/2	34	91		
3.77	1	14	1/2	34	95		
3.78	1	14	1/2	34	99		
3.79	1	14	1/2	34	103		
3.80	1	14	1/2	34	107		
3.81	1	14	1/2	34	111		
3.82	1	14	1/2	34	115		
3.83	1	14	1/2	34	119		
3.84	1	14	1/2	34	123		
3.85	1	14	1/2	34	127		
3.86	1	14	1/2	34	131		
3.87	1	14	1/2	34	135		
3.88	1	14	1/2	34	139		
3.89	1	14	1/2	34	143		
3.90	1	14	1/2	34	147		
3.91	1	14	1/2	34	151		
3.92	1	14	1/2	34	155		
3.93	1	14	1/2	34	159		
3.94	1	14	1/2	34	163		
3.95	1	14	1/2	34	167		
3.96	1	14	1/2	34	171		
3.97	1	14	1/2	34	175		
3.98	1	14	1/2	34	179		
3.99	1	14	1/2	34	183		
3.100	1	14	1/2	34	187		

SECTION AT PIER 1

SECTION AT ABUTMENT

SECTION AT PIER 2

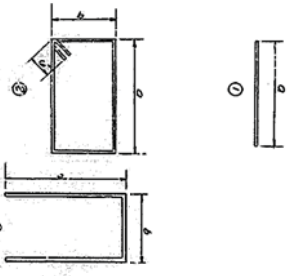

MARK	TYPE	NO.	SIZE	LENGTH	LOCATION	FT. IN	FT. IN
3.1	1	100	1/2	34	3		
3.2	1	92	1/2	34	7		
3.3	1	84	1/2	34	11		
3.4	1	76	1/2	34	15		
3.5	1	68	1/2	34	19		
3.6	1	60	1/2	34	23		
3.7	1	52	1/2	34	27		
3.8	1	44	1/2	34	31		
3.9	1	36	1/2	34	35		
3.10	1	28	1/2	34	39		
3.11	1	20	1/2	34	43		
3.12	1	12	1/2	34	47		
3.13	1	4	1/2	34	51		
3.14	1	100	1/2	34	55		
3.15	1	92	1/2	34	59		
3.16	1	84	1/2	34	63		
3.17	1	76	1/2	34	67		
3.18	1	68	1/2	34	71		
3.19	1	60	1/2	34	75		
3.20	1	52	1/2	34	79		
3.21	1	44	1/2	34	83		
3.22	1	36	1/2	34	87		
3.23	1	28	1/2	34	91		
3.24	1	20	1/2	34	95		
3.25	1	12	1/2	34	99		
3.26	1	4	1/2	34	103		
3.27	1	100	1/2	34	107		
3.28	1	92	1/2	34	111		
3.29	1	84	1/2	34	115		
3.30	1	76	1/2	34	119		
3.31	1	68	1/2	34	123		
3.32	1	60	1/2	34	127		
3.33	1	52	1/2	34	131		
3.34	1	44	1/2	34	135		
3.35	1	36	1/2	34	139		
3.36	1	28	1/2	34	143		
3.37	1	20	1/2	34	147		
3.38	1	12	1/2	34	151		
3.39	1	100	1/2	34	155		
3.40	1	92	1/2	34	159		
3.41	1	84	1/2	34	163		
3.42	1	76	1/2	34	167		
3.43	1	68	1/2	34	171		
3.44	1	60	1/2	34	175		
3.45	1	52	1/2	34	179		
3.46	1	44	1/2	34	183		
3.47	1	36	1/2	34	187		
3.48	1	28	1/2	34	191		
3.49	1	20	1/2	34	195		
3.50	1	12	1/2	34	199		
3.51	1	100	1/2	34	203		
3.52	1	92	1/2	34	207		
3.53	1	84	1/2	34	211		

ESTIMATE OF QUANTITIES
Reinforcement 55,598
Concrete Class 241- 210.7 CY

SLAB DETAILS

COMMONWEALTH OF KENTUCKY
DEPARTMENT OF HIGHWAYS
REINFORCEMENT COUNTY OF
JEFFERSON
NEW ALBANY BRIDGE APPROX. INTERCHANGE
E-S RAMP OVER W-E RAMP
241-12.28 E-S RAMP
241-12.73 W-E RAMP
PRODUCTION NO. 14672

SHEET 13 OF 20

BRIDGE NUMBERS 14672

ELIMINATE TRANSVERSE JOINT DETAIL

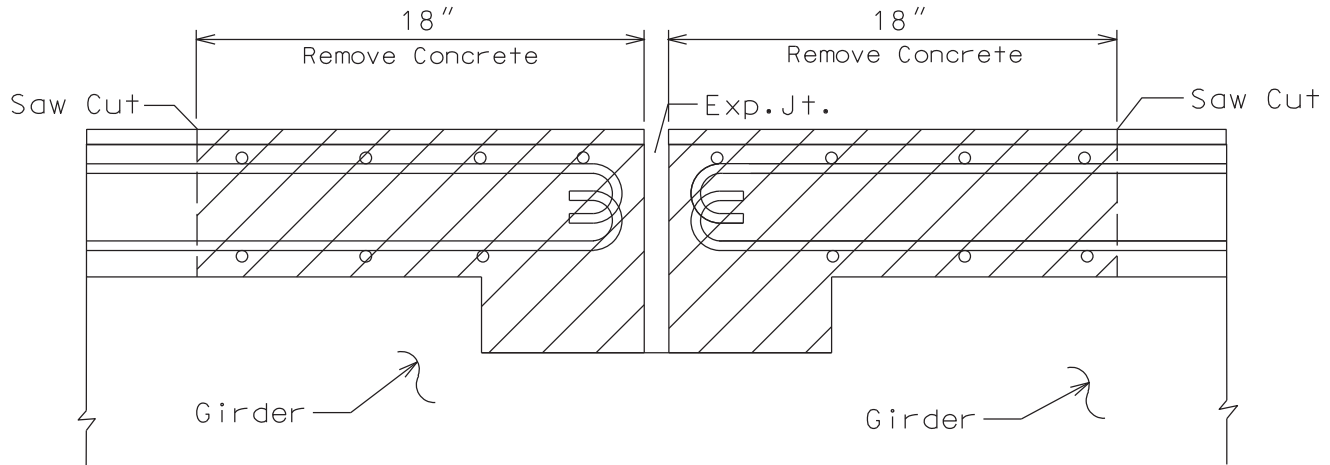

NOTE: Do not disturb existing Steel Reinforcement

EXISTING SECTION @ Transverse Joint

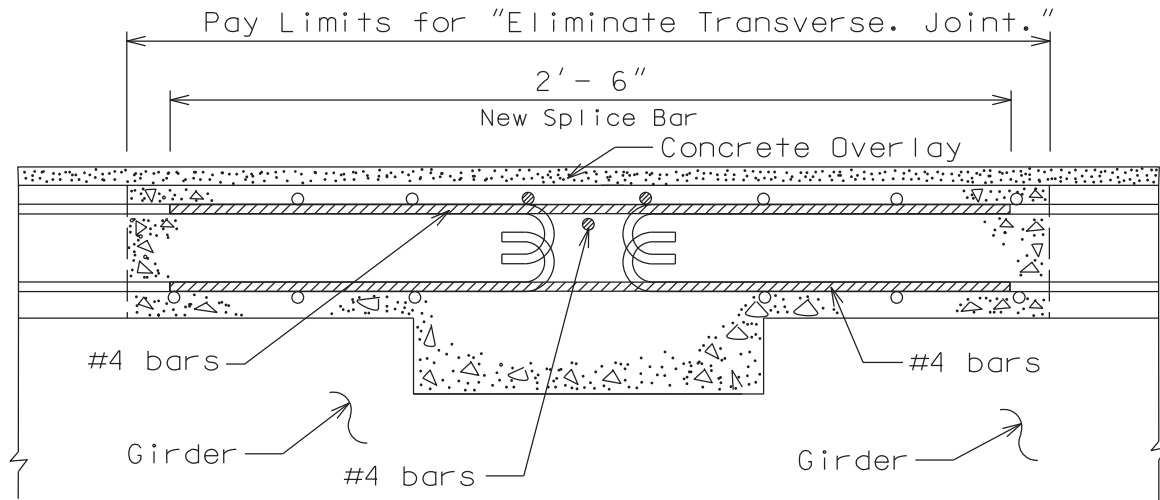

PROPOSED SECTION @ Transverse Joint

ELIMINATE TRANSVERSE JOINT DETAIL

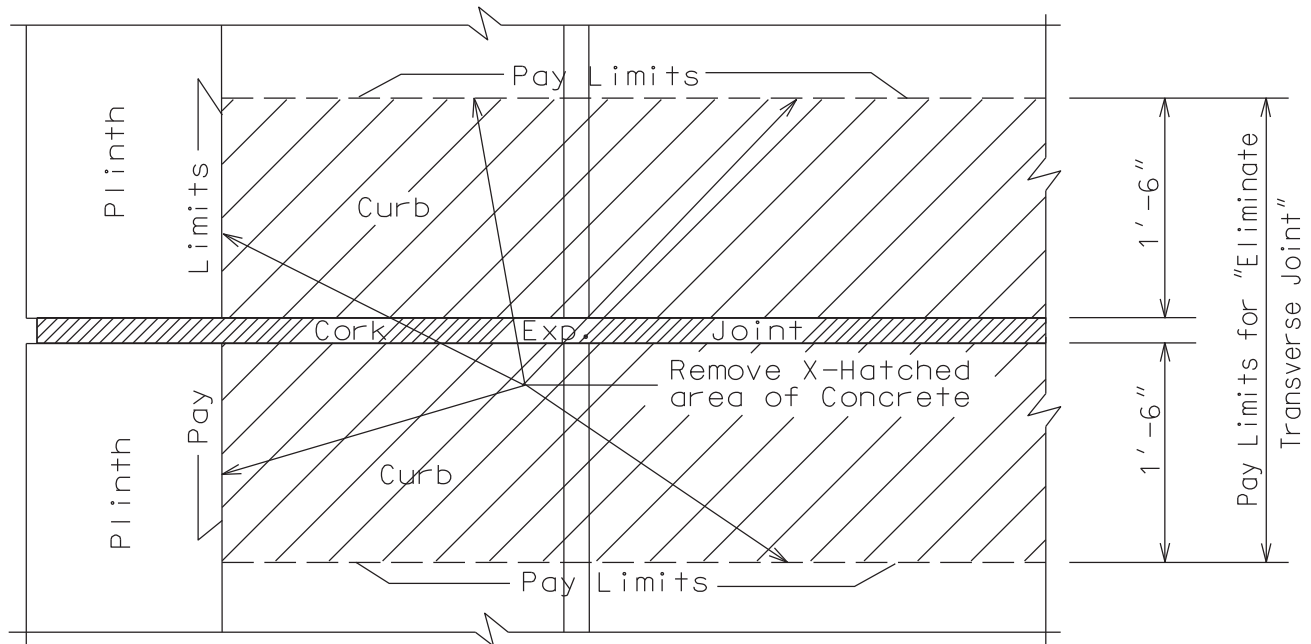

EXISTING PLAN VIEW @ CURB

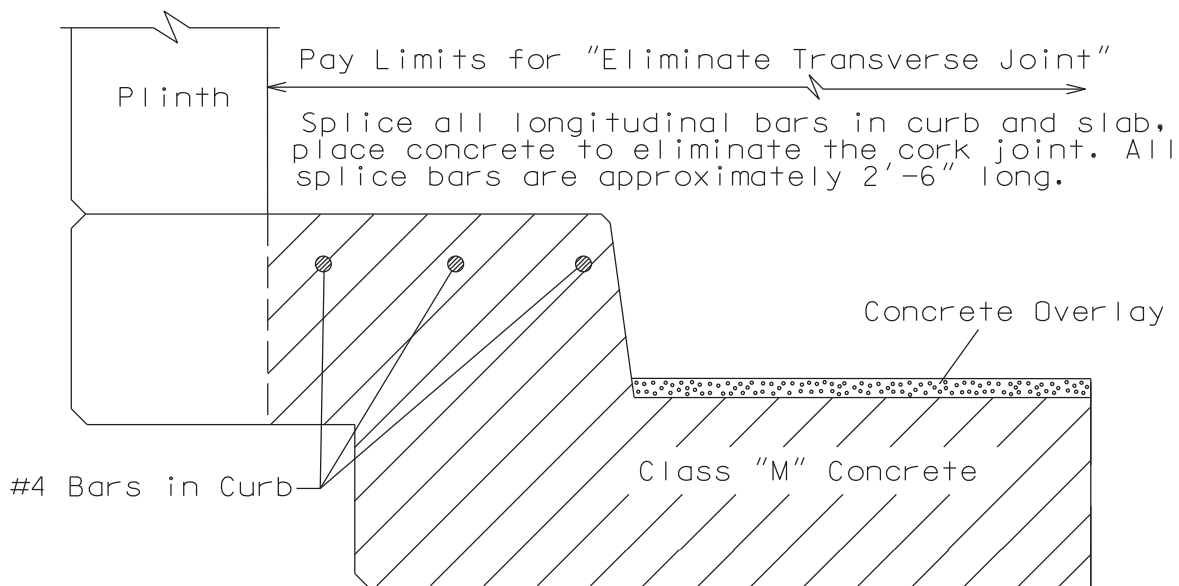

PROPOSED SECTION @ CURB

EXPANSION DAM DETAIL

Abutments #1 and #2

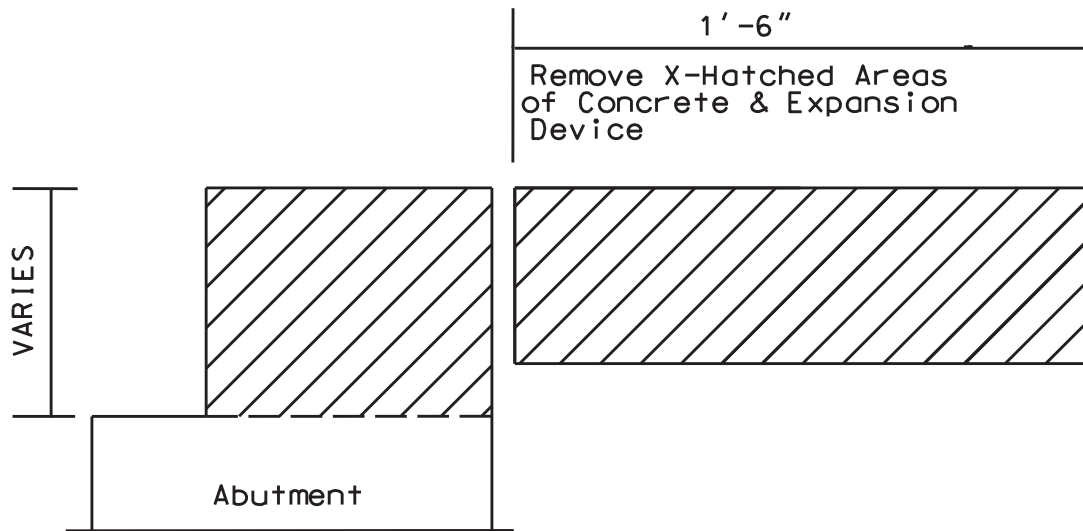

Clean & Leave
Steel Reinf.
in place.

EXISTING SECTION

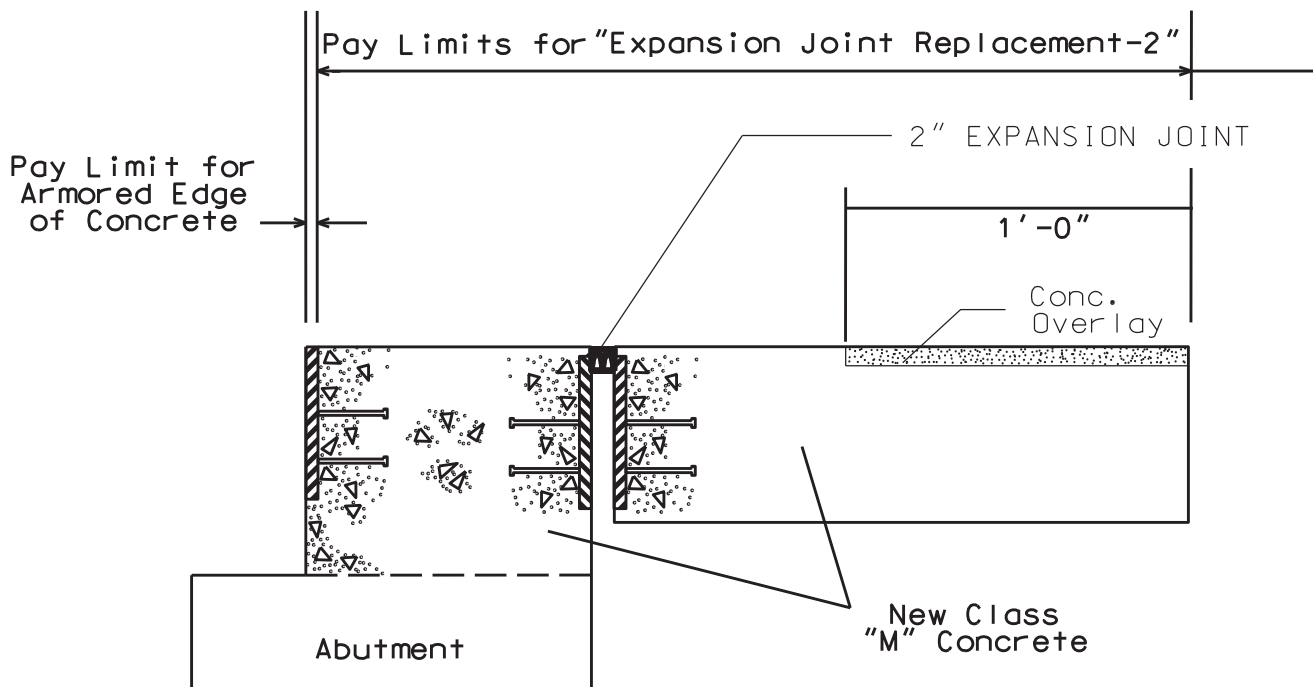

PROPOSED SECTION

056B00278N

CURB SECTION

END BENTS

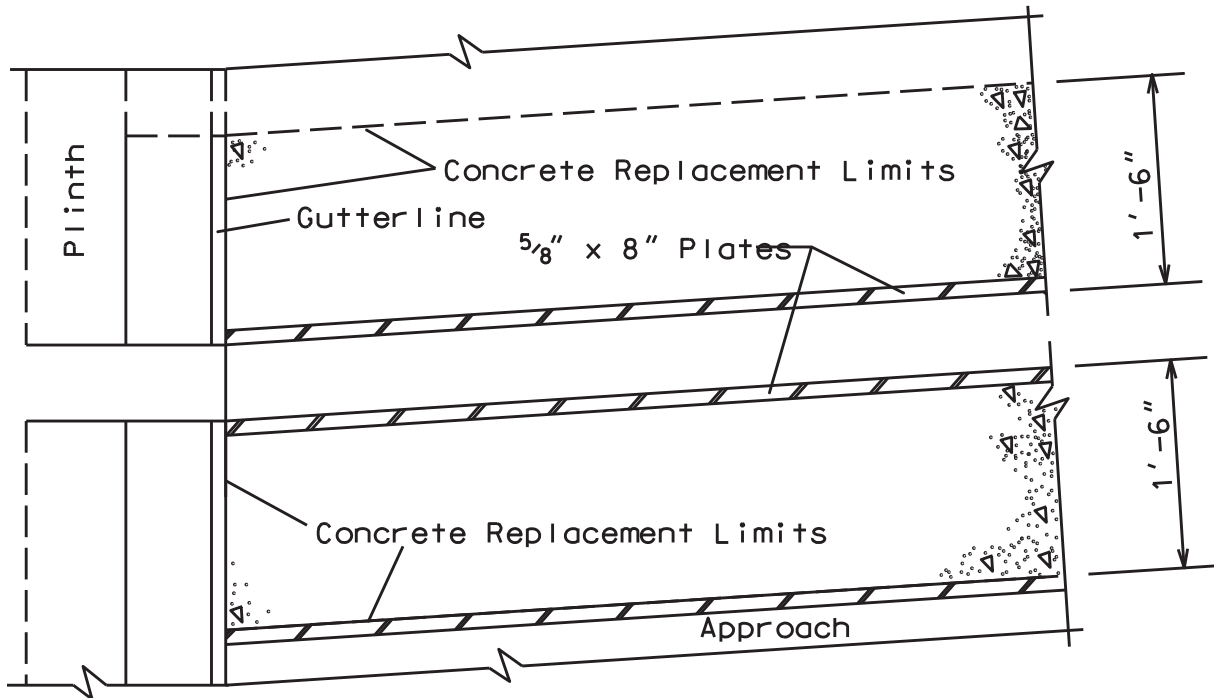

PLAN VIEW @ CURB

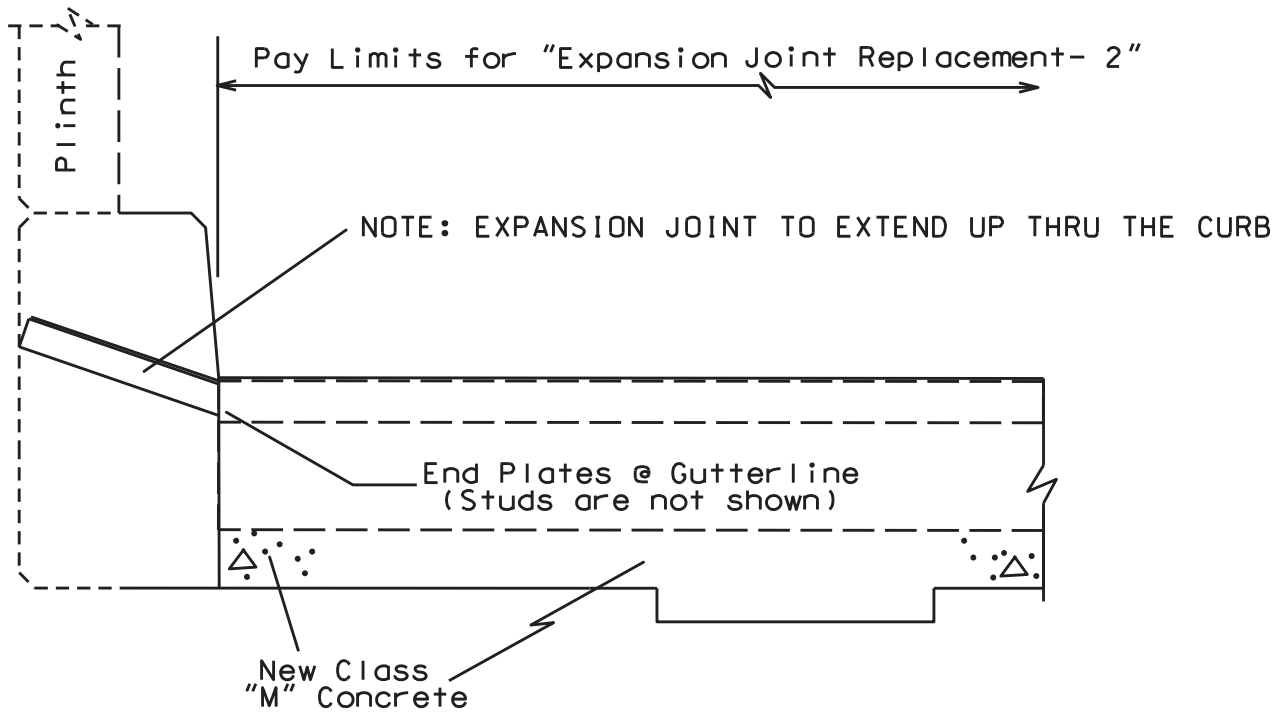

PROPOSED SECTION @ CURB

PART II

SPECIFICATIONS AND STANDARD DRAWINGS

SPECIFICATIONS REFERENCE

Any reference in the plans or proposal to previous editions of the *Standard Specifications for Road and Bridge Construction* and *Standard Drawings* are superseded by *Standard Specifications for Road and Bridge Construction, Edition of 2012* and *Standard Drawings, Edition of 2016*.

SUPPLEMENTAL SPECIFICATIONS

The contractor shall use the Supplemental Specifications that are effective at the time of letting.
The Supplemental Specifications can be found at the following link:

<http://transportation.ky.gov/Construction/Pages/Kentucky-Standard-Specifications.aspx>

STANDARD DRAWINGS THAT APPLY

ROADWAY

~ BARRIERS ~

CONCRETE MEDIAN BARRIERS

DELINEATORS FOR CONCRETE BARRIERS (Payment Incidental to Barrier Wall 9T)	RBM-020-08
CONCRETE BARRIER WALL 9T	RBM-115-08
CRASH CUSHION IX-T	RBE-100-09

TRAFFIC

~ TEMPORARY ~

TRAFFIC CONTROL

LANE CLOSURE MULTI-LANE HIGHWAY CASE II	TTC-120
---	---------

DEVICES

POST SPLICING DETAIL	TTD-110
ARROW PANEL	TTD-115

BRIDGES

MISCELLANEOUS STANDARDS

BRIDGE RESTORATION AND WATERPROOFING WITH CONCRETE OVERLAYS	BGX-009-04
---	------------

JOINTS

NEOPRENE EXPANSION DAMS AND ARMORED EDGES	BJE-001-11
---	------------

PART III

EMPLOYMENT, WAGE AND RECORD REQUIREMENTS

FHWA-1273 -- Revised May 1, 2012

**REQUIRED CONTRACT PROVISIONS
FEDERAL-AID CONSTRUCTION CONTRACTS**

- I. General
- II. Nondiscrimination
- III. Nonsegregated Facilities
- IV. Davis-Bacon and Related Act Provisions
- V. Contract Work Hours and Safety Standards Act Provisions
- VI. Subletting or Assigning the Contract
- VII. Safety: Accident Prevention
- VIII. False Statements Concerning Highway Projects
- IX. Implementation of Clean Air Act and Federal Water Pollution Control Act
- X. Compliance with Governmentwide Suspension and Debarment Requirements
- XI. Certification Regarding Use of Contract Funds for Lobbying

3. A breach of any of the stipulations contained in these Required Contract Provisions may be sufficient grounds for withholding of progress payments, withholding of final payment, termination of the contract, suspension / debarment or any other action determined to be appropriate by the contracting agency and FHWA.

4. Selection of Labor: During the performance of this contract, the contractor shall not use convict labor for any purpose within the limits of a construction project on a Federal-aid highway unless it is labor performed by convicts who are on parole, supervised release, or probation. The term Federal-aid highway does not include roadways functionally classified as local roads or rural minor collectors.

ATTACHMENTS

A. Employment and Materials Preference for Appalachian Development Highway System or Appalachian Local Access Road Contracts (included in Appalachian contracts only)

II. NONDISCRIMINATION

The provisions of this section related to 23 CFR Part 230 are applicable to all Federal-aid construction contracts and to all related construction subcontracts of \$10,000 or more. The provisions of 23 CFR Part 230 are not applicable to material supply, engineering, or architectural service contracts.

I. GENERAL

1. Form FHWA-1273 must be physically incorporated in each construction contract funded under Title 23 (excluding emergency contracts solely intended for debris removal). The contractor (or subcontractor) must insert this form in each subcontract and further require its inclusion in all lower tier subcontracts (excluding purchase orders, rental agreements and other agreements for supplies or services).

In addition, the contractor and all subcontractors must comply with the following policies: Executive Order 11246, 41 CFR 60, 29 CFR 1625-1627, Title 23 USC Section 140, the Rehabilitation Act of 1973, as amended (29 USC 794), Title VI of the Civil Rights Act of 1964, as amended, and related regulations including 49 CFR Parts 21, 26 and 27; and 23 CFR Parts 200, 230, and 633.

The applicable requirements of Form FHWA-1273 are incorporated by reference for work done under any purchase order, rental agreement or agreement for other services. The prime contractor shall be responsible for compliance by any subcontractor, lower-tier subcontractor or service provider.

The contractor and all subcontractors must comply with: the requirements of the Equal Opportunity Clause in 41 CFR 60-1.4(b) and, for all construction contracts exceeding \$10,000, the Standard Federal Equal Employment Opportunity Construction Contract Specifications in 41 CFR 60-4.3.

Form FHWA-1273 must be included in all Federal-aid design-build contracts, in all subcontracts and in lower tier subcontracts (excluding subcontracts for design services, purchase orders, rental agreements and other agreements for supplies or services). The design-builder shall be responsible for compliance by any subcontractor, lower-tier subcontractor or service provider.

Note: The U.S. Department of Labor has exclusive authority to determine compliance with Executive Order 11246 and the policies of the Secretary of Labor including 41 CFR 60, and 29 CFR 1625-1627. The contracting agency and the FHWA have the authority and the responsibility to ensure compliance with Title 23 USC Section 140, the Rehabilitation Act of 1973, as amended (29 USC 794), and Title VI of the Civil Rights Act of 1964, as amended, and related regulations including 49 CFR Parts 21, 26 and 27; and 23 CFR Parts 200, 230, and 633.

Contracting agencies may reference Form FHWA-1273 in bid proposal or request for proposal documents, however, the Form FHWA-1273 must be physically incorporated (not referenced) in all contracts, subcontracts and lower-tier subcontracts (excluding purchase orders, rental agreements and other agreements for supplies or services related to a construction contract).

The following provision is adopted from 23 CFR 230, Appendix A, with appropriate revisions to conform to the U.S. Department of Labor (US DOL) and FHWA requirements.

2. Subject to the applicability criteria noted in the following sections, these contract provisions shall apply to all work performed on the contract by the contractor's own organization and with the assistance of workers under the contractor's immediate superintendence and to all work performed on the contract by piecework, station work, or by subcontract.

1. Equal Employment Opportunity: Equal employment opportunity (EEO) requirements not to discriminate and to take affirmative action to assure equal opportunity as set forth under laws, executive orders, rules, regulations (28 CFR 35, 29 CFR 1630, 29 CFR 1625-1627, 41 CFR 60 and 49 CFR 27) and orders of the Secretary of Labor as modified by the provisions prescribed herein, and imposed pursuant to 23 U.S.C. 140 shall constitute the EEO and specific affirmative action standards for the contractor's project activities under

this contract. The provisions of the Americans with Disabilities Act of 1990 (42 U.S.C. 12101 et seq.) set forth under 28 CFR 35 and 29 CFR 1630 are incorporated by reference in this contract. In the execution of this contract, the contractor agrees to comply with the following minimum specific requirement activities of EEO:

a. The contractor will work with the contracting agency and the Federal Government to ensure that it has made every good faith effort to provide equal opportunity with respect to all of its terms and conditions of employment and in their review of activities under the contract.

b. The contractor will accept as its operating policy the following statement:

"It is the policy of this Company to assure that applicants are employed, and that employees are treated during employment, without regard to their race, religion, sex, color, national origin, age or disability. Such action shall include: employment, upgrading, demotion, or transfer; recruitment or recruitment advertising; layoff or termination; rates of pay or other forms of compensation; and selection for training, including apprenticeship, pre-apprenticeship, and/or on-the-job training."

2. EEO Officer: The contractor will designate and make known to the contracting officers an EEO Officer who will have the responsibility for and must be capable of effectively administering and promoting an active EEO program and who must be assigned adequate authority and responsibility to do so.

3. Dissemination of Policy: All members of the contractor's staff who are authorized to hire, supervise, promote, and discharge employees, or who recommend such action, or who are substantially involved in such action, will be made fully cognizant of, and will implement, the contractor's EEO policy and contractual responsibilities to provide EEO in each grade and classification of employment. To ensure that the above agreement will be met, the following actions will be taken as a minimum:

a. Periodic meetings of supervisory and personnel office employees will be conducted before the start of work and then not less often than once every six months, at which time the contractor's EEO policy and its implementation will be reviewed and explained. The meetings will be conducted by the EEO Officer.

b. All new supervisory or personnel office employees will be given a thorough indoctrination by the EEO Officer, covering all major aspects of the contractor's EEO obligations within thirty days following their reporting for duty with the contractor.

c. All personnel who are engaged in direct recruitment for the project will be instructed by the EEO Officer in the contractor's procedures for locating and hiring minorities and women.

d. Notices and posters setting forth the contractor's EEO policy will be placed in areas readily accessible to employees, applicants for employment and potential employees.

e. The contractor's EEO policy and the procedures to implement such policy will be brought to the attention of employees by means of meetings, employee handbooks, or other appropriate means.

4. Recruitment: When advertising for employees, the contractor will include in all advertisements for employees the notation: "An Equal Opportunity Employer." All such advertisements will be placed in publications having a large circulation among minorities and women in the area from which the project work force would normally be derived.

a. The contractor will, unless precluded by a valid bargaining agreement, conduct systematic and direct recruitment through public and private employee referral sources likely to yield qualified minorities and women. To meet this requirement, the contractor will identify sources of potential minority group employees, and establish with such identified sources procedures whereby minority and women applicants may be referred to the contractor for employment consideration.

b. In the event the contractor has a valid bargaining agreement providing for exclusive hiring hall referrals, the contractor is expected to observe the provisions of that agreement to the extent that the system meets the contractor's compliance with EEO contract provisions. Where implementation of such an agreement has the effect of discriminating against minorities or women, or obligates the contractor to do the same, such implementation violates Federal nondiscrimination provisions.

c. The contractor will encourage its present employees to refer minorities and women as applicants for employment. Information and procedures with regard to referring such applicants will be discussed with employees.

5. Personnel Actions: Wages, working conditions, and employee benefits shall be established and administered, and personnel actions of every type, including hiring, upgrading, promotion, transfer, demotion, layoff, and termination, shall be taken without regard to race, color, religion, sex, national origin, age or disability. The following procedures shall be followed:

a. The contractor will conduct periodic inspections of project sites to insure that working conditions and employee facilities do not indicate discriminatory treatment of project site personnel.

b. The contractor will periodically evaluate the spread of wages paid within each classification to determine any evidence of discriminatory wage practices.

c. The contractor will periodically review selected personnel actions in depth to determine whether there is evidence of discrimination. Where evidence is found, the contractor will promptly take corrective action. If the review indicates that the discrimination may extend beyond the actions reviewed, such corrective action shall include all affected persons.

d. The contractor will promptly investigate all complaints of alleged discrimination made to the contractor in connection with its obligations under this contract, will attempt to resolve such complaints, and will take appropriate corrective action within a reasonable time. If the investigation indicates that the discrimination may affect persons other than the complainant, such corrective action shall include such other persons. Upon completion of each investigation, the contractor will inform every complainant of all of their avenues of appeal.

6. Training and Promotion:

a. The contractor will assist in locating, qualifying, and increasing the skills of minorities and women who are

applicants for employment or current employees. Such efforts should be aimed at developing full journey level status employees in the type of trade or job classification involved.

b. Consistent with the contractor's work force requirements and as permissible under Federal and State regulations, the contractor shall make full use of training programs, i.e., apprenticeship, and on-the-job training programs for the geographical area of contract performance. In the event a special provision for training is provided under this contract, this subparagraph will be superseded as indicated in the special provision. The contracting agency may reserve training positions for persons who receive welfare assistance in accordance with 23 U.S.C. 140(a).

c. The contractor will advise employees and applicants for employment of available training programs and entrance requirements for each.

d. The contractor will periodically review the training and promotion potential of employees who are minorities and women and will encourage eligible employees to apply for such training and promotion.

7. Unions: If the contractor relies in whole or in part upon unions as a source of employees, the contractor will use good faith efforts to obtain the cooperation of such unions to increase opportunities for minorities and women. Actions by the contractor, either directly or through a contractor's association acting as agent, will include the procedures set forth below:

a. The contractor will use good faith efforts to develop, in cooperation with the unions, joint training programs aimed toward qualifying more minorities and women for membership in the unions and increasing the skills of minorities and women so that they may qualify for higher paying employment.

b. The contractor will use good faith efforts to incorporate an EEO clause into each union agreement to the end that such union will be contractually bound to refer applicants without regard to their race, color, religion, sex, national origin, age or disability.

c. The contractor is to obtain information as to the referral practices and policies of the labor union except that to the extent such information is within the exclusive possession of the labor union and such labor union refuses to furnish such information to the contractor, the contractor shall so certify to the contracting agency and shall set forth what efforts have been made to obtain such information.

d. In the event the union is unable to provide the contractor with a reasonable flow of referrals within the time limit set forth in the collective bargaining agreement, the contractor will, through independent recruitment efforts, fill the employment vacancies without regard to race, color, religion, sex, national origin, age or disability; making full efforts to obtain qualified and/or qualifiable minorities and women. The failure of a union to provide sufficient referrals (even though it is obligated to provide exclusive referrals under the terms of a collective bargaining agreement) does not relieve the contractor from the requirements of this paragraph. In the event the union referral practice prevents the contractor from meeting the obligations pursuant to Executive Order 11246, as amended, and these special provisions, such contractor shall immediately notify the contracting agency.

8. Reasonable Accommodation for Applicants / Employees with Disabilities: The contractor must be familiar

with the requirements for and comply with the Americans with Disabilities Act and all rules and regulations established there under. Employers must provide reasonable accommodation in all employment activities unless to do so would cause an undue hardship.

9. Selection of Subcontractors, Procurement of Materials and Leasing of Equipment: The contractor shall not discriminate on the grounds of race, color, religion, sex, national origin, age or disability in the selection and retention of subcontractors, including procurement of materials and leases of equipment. The contractor shall take all necessary and reasonable steps to ensure nondiscrimination in the administration of this contract.

a. The contractor shall notify all potential subcontractors and suppliers and lessors of their EEO obligations under this contract.

b. The contractor will use good faith efforts to ensure subcontractor compliance with their EEO obligations.

10. Assurance Required by 49 CFR 26.13(b):

a. The requirements of 49 CFR Part 26 and the State DOT's U.S. DOT-approved DBE program are incorporated by reference.

b. The contractor or subcontractor shall not discriminate on the basis of race, color, national origin, or sex in the performance of this contract. The contractor shall carry out applicable requirements of 49 CFR Part 26 in the award and administration of DOT-assisted contracts. Failure by the contractor to carry out these requirements is a material breach of this contract, which may result in the termination of this contract or such other remedy as the contracting agency deems appropriate.

11. Records and Reports: The contractor shall keep such records as necessary to document compliance with the EEO requirements. Such records shall be retained for a period of three years following the date of the final payment to the contractor for all contract work and shall be available at reasonable times and places for inspection by authorized representatives of the contracting agency and the FHWA.

a. The records kept by the contractor shall document the following:

(1) The number and work hours of minority and non-minority group members and women employed in each work classification on the project;

(2) The progress and efforts being made in cooperation with unions, when applicable, to increase employment opportunities for minorities and women; and

(3) The progress and efforts being made in locating, hiring, training, qualifying, and upgrading minorities and women;

b. The contractors and subcontractors will submit an annual report to the contracting agency each July for the duration of the project, indicating the number of minority, women, and non-minority group employees currently engaged in each work classification required by the contract work. This information is to be reported on [Form FHWA-1391](#). The staffing data should represent the project work force on board in all or any part of the last payroll period preceding the end of July. If on-the-job training is being required by special provision, the contractor

will be required to collect and report training data. The employment data should reflect the work force on board during all or any part of the last payroll period preceding the end of July.

III. NONSEGREGATED FACILITIES

This provision is applicable to all Federal-aid construction contracts and to all related construction subcontracts of \$10,000 or more.

The contractor must ensure that facilities provided for employees are provided in such a manner that segregation on the basis of race, color, religion, sex, or national origin cannot result. The contractor may neither require such segregated use by written or oral policies nor tolerate such use by employee custom. The contractor's obligation extends further to ensure that its employees are not assigned to perform their services at any location, under the contractor's control, where the facilities are segregated. The term "facilities" includes waiting rooms, work areas, restaurants and other eating areas, time clocks, restrooms, washrooms, locker rooms, and other storage or dressing areas, parking lots, drinking fountains, recreation or entertainment areas, transportation, and housing provided for employees. The contractor shall provide separate or single-user restrooms and necessary dressing or sleeping areas to assure privacy between sexes.

IV. DAVIS-BACON AND RELATED ACT PROVISIONS

This section is applicable to all Federal-aid construction projects exceeding \$2,000 and to all related subcontracts and lower-tier subcontracts (regardless of subcontract size). The requirements apply to all projects located within the right-of-way of a roadway that is functionally classified as Federal-aid highway. This excludes roadways functionally classified as local roads or rural minor collectors, which are exempt. Contracting agencies may elect to apply these requirements to other projects.

The following provisions are from the U.S. Department of Labor regulations in 29 CFR 5.5 "Contract provisions and related matters" with minor revisions to conform to the FHWA-1273 format and FHWA program requirements.

1. Minimum wages

a. All laborers and mechanics employed or working upon the site of the work, will be paid unconditionally and not less often than once a week, and without subsequent deduction or rebate on any account (except such payroll deductions as are permitted by regulations issued by the Secretary of Labor under the Copeland Act (29 CFR part 3)), the full amount of wages and bona fide fringe benefits (or cash equivalents thereof) due at time of payment computed at rates not less than those contained in the wage determination of the Secretary of Labor which is attached hereto and made a part hereof, regardless of any contractual relationship which may be alleged to exist between the contractor and such laborers and mechanics.

Contributions made or costs reasonably anticipated for bona fide fringe benefits under section 1(b)(2) of the Davis-Bacon Act on behalf of laborers or mechanics are considered wages paid to such laborers or mechanics, subject to the provisions

of paragraph 1.d. of this section; also, regular contributions made or costs incurred for more than a weekly period (but not less often than quarterly) under plans, funds, or programs which cover the particular weekly period, are deemed to be constructively made or incurred during such weekly period. Such laborers and mechanics shall be paid the appropriate wage rate and fringe benefits on the wage determination for the classification of work actually performed, without regard to skill, except as provided in 29 CFR 5.5(a)(4). Laborers or mechanics performing work in more than one classification may be compensated at the rate specified for each classification for the time actually worked therein: Provided, That the employer's payroll records accurately set forth the time spent in each classification in which work is performed. The wage determination (including any additional classification and wage rates conformed under paragraph 1.b. of this section) and the Davis-Bacon poster (WH-1321) shall be posted at all times by the contractor and its subcontractors at the site of the work in a prominent and accessible place where it can be easily seen by the workers.

b.(1) The contracting officer shall require that any class of laborers or mechanics, including helpers, which is not listed in the wage determination and which is to be employed under the contract shall be classified in conformance with the wage determination. The contracting officer shall approve an additional classification and wage rate and fringe benefits therefore only when the following criteria have been met:

- (i) The work to be performed by the classification requested is not performed by a classification in the wage determination; and
- (ii) The classification is utilized in the area by the construction industry; and
- (iii) The proposed wage rate, including any bona fide fringe benefits, bears a reasonable relationship to the wage rates contained in the wage determination.

(2) If the contractor and the laborers and mechanics to be employed in the classification (if known), or their representatives, and the contracting officer agree on the classification and wage rate (including the amount designated for fringe benefits where appropriate), a report of the action taken shall be sent by the contracting officer to the Administrator of the Wage and Hour Division, Employment Standards Administration, U.S. Department of Labor, Washington, DC 20210. The Administrator, or an authorized representative, will approve, modify, or disapprove every additional classification action within 30 days of receipt and so advise the contracting officer or will notify the contracting officer within the 30-day period that additional time is necessary.

(3) In the event the contractor, the laborers or mechanics to be employed in the classification or their representatives, and the contracting officer do not agree on the proposed classification and wage rate (including the amount designated for fringe benefits, where appropriate), the contracting officer shall refer the questions, including the views of all interested parties and the recommendation of the contracting officer, to the Wage and Hour Administrator for determination. The Wage and Hour Administrator, or an authorized representative, will issue a determination within 30 days of receipt and so advise the contracting officer or

will notify the contracting officer within the 30-day period that additional time is necessary.

(4) The wage rate (including fringe benefits where appropriate) determined pursuant to paragraphs 1.b.(2) or 1.b.(3) of this section, shall be paid to all workers performing work in the classification under this contract from the first day on which work is performed in the classification.

c. Whenever the minimum wage rate prescribed in the contract for a class of laborers or mechanics includes a fringe benefit which is not expressed as an hourly rate, the contractor shall either pay the benefit as stated in the wage determination or shall pay another bona fide fringe benefit or an hourly cash equivalent thereof.

d. If the contractor does not make payments to a trustee or other third person, the contractor may consider as part of the wages of any laborer or mechanic the amount of any costs reasonably anticipated in providing bona fide fringe benefits under a plan or program. Provided, That the Secretary of Labor has found, upon the written request of the contractor, that the applicable standards of the Davis-Bacon Act have been met. The Secretary of Labor may require the contractor to set aside in a separate account assets for the meeting of obligations under the plan or program.

2. Withholding

The contracting agency shall upon its own action or upon written request of an authorized representative of the Department of Labor, withhold or cause to be withheld from the contractor under this contract, or any other Federal contract with the same prime contractor, or any other federally-assisted contract subject to Davis-Bacon prevailing wage requirements, which is held by the same prime contractor, so much of the accrued payments or advances as may be considered necessary to pay laborers and mechanics, including apprentices, trainees, and helpers, employed by the contractor or any subcontractor the full amount of wages required by the contract. In the event of failure to pay any laborer or mechanic, including any apprentice, trainee, or helper, employed or working on the site of the work, all or part of the wages required by the contract, the contracting agency may, after written notice to the contractor, take such action as may be necessary to cause the suspension of any further payment, advance, or guarantee of funds until such violations have ceased.

3. Payrolls and basic records

a. Payrolls and basic records relating thereto shall be maintained by the contractor during the course of the work and preserved for a period of three years thereafter for all laborers and mechanics working at the site of the work. Such records shall contain the name, address, and social security number of each such worker, his or her correct classification, hourly rates of wages paid (including rates of contributions or costs anticipated for bona fide fringe benefits or cash equivalents thereof of the types described in section 1(b)(2)(B) of the Davis-Bacon Act), daily and weekly number of hours worked, deductions made and actual wages paid. Whenever the Secretary of Labor has found under 29 CFR 5.5(a)(1)(iv) that the wages of any laborer or mechanic include the amount of any costs reasonably anticipated in providing benefits under a plan or program described in section 1(b)(2)(B) of the Davis-

Bacon Act, the contractor shall maintain records which show that the commitment to provide such benefits is enforceable, that the plan or program is financially responsible, and that the plan or program has been communicated in writing to the laborers or mechanics affected, and records which show the costs anticipated or the actual cost incurred in providing such benefits. Contractors employing apprentices or trainees under approved programs shall maintain written evidence of the registration of apprenticeship programs and certification of trainee programs, the registration of the apprentices and trainees, and the ratios and wage rates prescribed in the applicable programs.

b.(1) The contractor shall submit weekly for each week in which any contract work is performed a copy of all payrolls to the contracting agency. The payrolls submitted shall set out accurately and completely all of the information required to be maintained under 29 CFR 5.5(a)(3)(i), except that full social security numbers and home addresses shall not be included on weekly transmittals. Instead the payrolls shall only need to include an individually identifying number for each employee (e.g., the last four digits of the employee's social security number). The required weekly payroll information may be submitted in any form desired. Optional Form WH-347 is available for this purpose from the Wage and Hour Division Web site at <http://www.dol.gov/esa/whd/forms/wh347instr.htm> or its successor site. The prime contractor is responsible for the submission of copies of payrolls by all subcontractors. Contractors and subcontractors shall maintain the full social security number and current address of each covered worker, and shall provide them upon request to the contracting agency for transmission to the State DOT, the FHWA or the Wage and Hour Division of the Department of Labor for purposes of an investigation or audit of compliance with prevailing wage requirements. It is not a violation of this section for a prime contractor to require a subcontractor to provide addresses and social security numbers to the prime contractor for its own records, without weekly submission to the contracting agency..

(2) Each payroll submitted shall be accompanied by a "Statement of Compliance," signed by the contractor or subcontractor or his or her agent who pays or supervises the payment of the persons employed under the contract and shall certify the following:

(i) That the payroll for the payroll period contains the information required to be provided under §5.5 (a)(3)(ii) of Regulations, 29 CFR part 5, the appropriate information is being maintained under §5.5 (a)(3)(i) of Regulations, 29 CFR part 5, and that such information is correct and complete;

(ii) That each laborer or mechanic (including each helper, apprentice, and trainee) employed on the contract during the payroll period has been paid the full weekly wages earned, without rebate, either directly or indirectly, and that no deductions have been made either directly or indirectly from the full wages earned, other than permissible deductions as set forth in Regulations, 29 CFR part 3;

(iii) That each laborer or mechanic has been paid not less than the applicable wage rates and fringe benefits or cash equivalents for the classification of work performed, as specified in the applicable wage determination incorporated into the contract.

(3) The weekly submission of a properly executed certification set forth on the reverse side of Optional Form WH-347 shall satisfy the requirement for submission of the "Statement of Compliance" required by paragraph 3.b.(2) of this section.

(4) The falsification of any of the above certifications may subject the contractor or subcontractor to civil or criminal prosecution under section 1001 of title 18 and section 231 of title 31 of the United States Code.

c. The contractor or subcontractor shall make the records required under paragraph 3.a. of this section available for inspection, copying, or transcription by authorized representatives of the contracting agency, the State DOT, the FHWA, or the Department of Labor, and shall permit such representatives to interview employees during working hours on the job. If the contractor or subcontractor fails to submit the required records or to make them available, the FHWA may, after written notice to the contractor, the contracting agency or the State DOT, take such action as may be necessary to cause the suspension of any further payment, advance, or guarantee of funds. Furthermore, failure to submit the required records upon request or to make such records available may be grounds for debarment action pursuant to 29 CFR 5.12.

4. Apprentices and trainees

a. Apprentices (programs of the USDOL).

Apprentices will be permitted to work at less than the predetermined rate for the work they performed when they are employed pursuant to and individually registered in a bona fide apprenticeship program registered with the U.S. Department of Labor, Employment and Training Administration, Office of Apprenticeship Training, Employer and Labor Services, or with a State Apprenticeship Agency recognized by the Office, or if a person is employed in his or her first 90 days of probationary employment as an apprentice in such an apprenticeship program, who is not individually registered in the program, but who has been certified by the Office of Apprenticeship Training, Employer and Labor Services or a State Apprenticeship Agency (where appropriate) to be eligible for probationary employment as an apprentice.

The allowable ratio of apprentices to journeymen on the job site in any craft classification shall not be greater than the ratio permitted to the contractor as to the entire work force under the registered program. Any worker listed on a payroll at an apprentice wage rate, who is not registered or otherwise employed as stated above, shall be paid not less than the applicable wage rate on the wage determination for the classification of work actually performed. In addition, any apprentice performing work on the job site in excess of the ratio permitted under the registered program shall be paid not less than the applicable wage rate on the wage determination for the work actually performed. Where a contractor is performing construction on a project in a locality other than that in which its program is registered, the ratios and wage rates (expressed in percentages of the journeyman's hourly rate) specified in the contractor's or subcontractor's registered program shall be observed.

Every apprentice must be paid at not less than the rate specified in the registered program for the apprentice's level of progress, expressed as a percentage of the journeymen hourly

rate specified in the applicable wage determination. Apprentices shall be paid fringe benefits in accordance with the provisions of the apprenticeship program. If the apprenticeship program does not specify fringe benefits, apprentices must be paid the full amount of fringe benefits listed on the wage determination for the applicable classification. If the Administrator determines that a different practice prevails for the applicable apprentice classification, fringes shall be paid in accordance with that determination.

In the event the Office of Apprenticeship Training, Employer and Labor Services, or a State Apprenticeship Agency recognized by the Office, withdraws approval of an apprenticeship program, the contractor will no longer be permitted to utilize apprentices at less than the applicable predetermined rate for the work performed until an acceptable program is approved.

b. Trainees (programs of the USDOL).

Except as provided in 29 CFR 5.16, trainees will not be permitted to work at less than the predetermined rate for the work performed unless they are employed pursuant to and individually registered in a program which has received prior approval, evidenced by formal certification by the U.S. Department of Labor, Employment and Training Administration.

The ratio of trainees to journeymen on the job site shall not be greater than permitted under the plan approved by the Employment and Training Administration.

Every trainee must be paid at not less than the rate specified in the approved program for the trainee's level of progress, expressed as a percentage of the journeyman hourly rate specified in the applicable wage determination. Trainees shall be paid fringe benefits in accordance with the provisions of the trainee program. If the trainee program does not mention fringe benefits, trainees shall be paid the full amount of fringe benefits listed on the wage determination unless the Administrator of the Wage and Hour Division determines that there is an apprenticeship program associated with the corresponding journeyman wage rate on the wage determination which provides for less than full fringe benefits for apprentices. Any employee listed on the payroll at a trainee rate who is not registered and participating in a training plan approved by the Employment and Training Administration shall be paid not less than the applicable wage rate on the wage determination for the classification of work actually performed. In addition, any trainee performing work on the job site in excess of the ratio permitted under the registered program shall be paid not less than the applicable wage rate on the wage determination for the work actually performed.

In the event the Employment and Training Administration withdraws approval of a training program, the contractor will no longer be permitted to utilize trainees at less than the applicable predetermined rate for the work performed until an acceptable program is approved.

c. Equal employment opportunity. The utilization of apprentices, trainees and journeymen under this part shall be in conformity with the equal employment opportunity requirements of Executive Order 11246, as amended, and 29 CFR part 30.

d. Apprentices and Trainees (programs of the U.S. DOT).

Apprentices and trainees working under apprenticeship and skill training programs which have been certified by the Secretary of Transportation as promoting EEO in connection with Federal-aid highway construction programs are not subject to the requirements of paragraph 4 of this Section IV. The straight time hourly wage rates for apprentices and trainees under such programs will be established by the particular programs. The ratio of apprentices and trainees to journeymen shall not be greater than permitted by the terms of the particular program.

5. Compliance with Copeland Act requirements. The contractor shall comply with the requirements of 29 CFR part 3, which are incorporated by reference in this contract.

6. Subcontracts. The contractor or subcontractor shall insert Form FHWA-1273 in any subcontracts and also require the subcontractors to include Form FHWA-1273 in any lower tier subcontracts. The prime contractor shall be responsible for the compliance by any subcontractor or lower tier subcontractor with all the contract clauses in 29 CFR 5.5.

7. Contract termination: debarment. A breach of the contract clauses in 29 CFR 5.5 may be grounds for termination of the contract, and for debarment as a contractor and a subcontractor as provided in 29 CFR 5.12.

8. Compliance with Davis-Bacon and Related Act requirements. All rulings and interpretations of the Davis-Bacon and Related Acts contained in 29 CFR parts 1, 3, and 5 are herein incorporated by reference in this contract.

9. Disputes concerning labor standards. Disputes arising out of the labor standards provisions of this contract shall not be subject to the general disputes clause of this contract. Such disputes shall be resolved in accordance with the procedures of the Department of Labor set forth in 29 CFR parts 5, 6, and 7. Disputes within the meaning of this clause include disputes between the contractor (or any of its subcontractors) and the contracting agency, the U.S. Department of Labor, or the employees or their representatives.

10. Certification of eligibility.

a. By entering into this contract, the contractor certifies that neither it (nor he or she) nor any person or firm who has an interest in the contractor's firm is a person or firm ineligible to be awarded Government contracts by virtue of section 3(a) of the Davis-Bacon Act or 29 CFR 5.12(a)(1).

b. No part of this contract shall be subcontracted to any person or firm ineligible for award of a Government contract by virtue of section 3(a) of the Davis-Bacon Act or 29 CFR 5.12(a)(1).

c. The penalty for making false statements is prescribed in the U.S. Criminal Code, 18 U.S.C. 1001.

V. CONTRACT WORK HOURS AND SAFETY STANDARDS ACT

The following clauses apply to any Federal-aid construction contract in an amount in excess of \$100,000 and subject to the overtime provisions of the Contract Work Hours and Safety Standards Act. These clauses shall be inserted in addition to the clauses required by 29 CFR 5.5(a) or 29 CFR 4.6. As used in this paragraph, the terms laborers and mechanics include watchmen and guards.

1. Overtime requirements. No contractor or subcontractor contracting for any part of the contract work which may require or involve the employment of laborers or mechanics shall require or permit any such laborer or mechanic in any workweek in which he or she is employed on such work to work in excess of forty hours in such workweek unless such laborer or mechanic receives compensation at a rate not less than one and one-half times the basic rate of pay for all hours worked in excess of forty hours in such workweek.

2. Violation; liability for unpaid wages; liquidated damages. In the event of any violation of the clause set forth in paragraph (1.) of this section, the contractor and any subcontractor responsible therefor shall be liable for the unpaid wages. In addition, such contractor and subcontractor shall be liable to the United States (in the case of work done under contract for the District of Columbia or a territory, to such District or to such territory), for liquidated damages. Such liquidated damages shall be computed with respect to each individual laborer or mechanic, including watchmen and guards, employed in violation of the clause set forth in paragraph (1.) of this section, in the sum of \$10 for each calendar day on which such individual was required or permitted to work in excess of the standard workweek of forty hours without payment of the overtime wages required by the clause set forth in paragraph (1.) of this section.

3. Withholding for unpaid wages and liquidated damages. The FHWA or the contracting agency shall upon its own action or upon written request of an authorized representative of the Department of Labor withhold or cause to be withheld, from any moneys payable on account of work performed by the contractor or subcontractor under any such contract or any other Federal contract with the same prime contractor, or any other federally-assisted contract subject to the Contract Work Hours and Safety Standards Act, which is held by the same prime contractor, such sums as may be determined to be necessary to satisfy any liabilities of such contractor or subcontractor for unpaid wages and liquidated damages as provided in the clause set forth in paragraph (2.) of this section.

4. Subcontracts. The contractor or subcontractor shall insert in any subcontracts the clauses set forth in paragraph (1.) through (4.) of this section and also a clause requiring the subcontractors to include these clauses in any lower tier subcontracts. The prime contractor shall be responsible for compliance by any subcontractor or lower tier subcontractor with the clauses set forth in paragraphs (1.) through (4.) of this section.

VI. SUBLETTING OR ASSIGNING THE CONTRACT

This provision is applicable to all Federal-aid construction contracts on the National Highway System.

1. The contractor shall perform with its own organization contract work amounting to not less than 30 percent (or a greater percentage if specified elsewhere in the contract) of the total original contract price, excluding any specialty items designated by the contracting agency. Specialty items may be performed by subcontract and the amount of any such specialty items performed may be deducted from the total original contract price before computing the amount of work required to be performed by the contractor's own organization (23 CFR 635.116).

a. The term "perform work with its own organization" refers to workers employed or leased by the prime contractor, and equipment owned or rented by the prime contractor, with or without operators. Such term does not include employees or equipment of a subcontractor or lower tier subcontractor, agents of the prime contractor, or any other assignees. The term may include payments for the costs of hiring leased employees from an employee leasing firm meeting all relevant Federal and State regulatory requirements. Leased employees may only be included in this term if the prime contractor meets all of the following conditions:

(1) the prime contractor maintains control over the supervision of the day-to-day activities of the leased employees;

(2) the prime contractor remains responsible for the quality of the work of the leased employees;

(3) the prime contractor retains all power to accept or exclude individual employees from work on the project; and

(4) the prime contractor remains ultimately responsible for the payment of predetermined minimum wages, the submission of payrolls, statements of compliance and all other Federal regulatory requirements.

b. "Specialty Items" shall be construed to be limited to work that requires highly specialized knowledge, abilities, or equipment not ordinarily available in the type of contracting organizations qualified and expected to bid or propose on the contract as a whole and in general are to be limited to minor components of the overall contract.

2. The contract amount upon which the requirements set forth in paragraph (1) of Section VI is computed includes the cost of material and manufactured products which are to be purchased or produced by the contractor under the contract provisions.

3. The contractor shall furnish (a) a competent superintendent or supervisor who is employed by the firm, has full authority to direct performance of the work in accordance with the contract requirements, and is in charge of all construction operations (regardless of who performs the work) and (b) such other of its own organizational resources (supervision, management, and engineering services) as the contracting officer determines is necessary to assure the performance of the contract.

4. No portion of the contract shall be sublet, assigned or otherwise disposed of except with the written consent of the contracting officer, or authorized representative, and such consent when given shall not be construed to relieve the contractor of any responsibility for the fulfillment of the contract. Written consent will be given only after the contracting agency has assured that each subcontract is

evidenced in writing and that it contains all pertinent provisions and requirements of the prime contract.

5. The 30% self-performance requirement of paragraph (1) is not applicable to design-build contracts; however, contracting agencies may establish their own self-performance requirements.

VII. SAFETY: ACCIDENT PREVENTION

This provision is applicable to all Federal-aid construction contracts and to all related subcontracts.

1. In the performance of this contract the contractor shall comply with all applicable Federal, State, and local laws governing safety, health, and sanitation (23 CFR 635). The contractor shall provide all safeguards, safety devices and protective equipment and take any other needed actions as it determines, or as the contracting officer may determine, to be reasonably necessary to protect the life and health of employees on the job and the safety of the public and to protect property in connection with the performance of the work covered by the contract.

2. It is a condition of this contract, and shall be made a condition of each subcontract, which the contractor enters into pursuant to this contract, that the contractor and any subcontractor shall not permit any employee, in performance of the contract, to work in surroundings or under conditions which are unsanitary, hazardous or dangerous to his/her health or safety, as determined under construction safety and health standards (29 CFR 1926) promulgated by the Secretary of Labor, in accordance with Section 107 of the Contract Work Hours and Safety Standards Act (40 U.S.C. 3704).

3. Pursuant to 29 CFR 1926.3, it is a condition of this contract that the Secretary of Labor or authorized representative thereof, shall have right of entry to any site of contract performance to inspect or investigate the matter of compliance with the construction safety and health standards and to carry out the duties of the Secretary under Section 107 of the Contract Work Hours and Safety Standards Act (40 U.S.C.3704).

VIII. FALSE STATEMENTS CONCERNING HIGHWAY PROJECTS

This provision is applicable to all Federal-aid construction contracts and to all related subcontracts.

In order to assure high quality and durable construction in conformity with approved plans and specifications and a high degree of reliability on statements and representations made by engineers, contractors, suppliers, and workers on Federal-aid highway projects, it is essential that all persons concerned with the project perform their functions as carefully, thoroughly, and honestly as possible. Willful falsification, distortion, or misrepresentation with respect to any facts related to the project is a violation of Federal law. To prevent any misunderstanding regarding the seriousness of these and similar acts, Form FHWA-1022 shall be posted on each Federal-aid highway project (23 CFR 635) in one or more places where it is readily available to all persons concerned with the project:

18 U.S.C. 1020 reads as follows:

"Whoever, being an officer, agent, or employee of the United States, or of any State or Territory, or whoever, whether a person, association, firm, or corporation, knowingly makes any false statement, false representation, or false report as to the character, quality, quantity, or cost of the material used or to be used, or the quantity or quality of the work performed or to be performed, or the cost thereof in connection with the submission of plans, maps, specifications, contracts, or costs of construction on any highway or related project submitted for approval to the Secretary of Transportation; or

Whoever knowingly makes any false statement, false representation, false report or false claim with respect to the character, quality, quantity, or cost of any work performed or to be performed, or materials furnished or to be furnished, in connection with the construction of any highway or related project approved by the Secretary of Transportation; or

Whoever knowingly makes any false statement or false representation as to material fact in any statement, certificate, or report submitted pursuant to provisions of the Federal-aid Roads Act approved July 1, 1916, (39 Stat. 355), as amended and supplemented;

Shall be fined under this title or imprisoned not more than 5 years or both."

IX. IMPLEMENTATION OF CLEAN AIR ACT AND FEDERAL WATER POLLUTION CONTROL ACT

This provision is applicable to all Federal-aid construction contracts and to all related subcontracts.

By submission of this bid/proposal or the execution of this contract, or subcontract, as appropriate, the bidder, proposer, Federal-aid construction contractor, or subcontractor, as appropriate, will be deemed to have stipulated as follows:

1. That any person who is or will be utilized in the performance of this contract is not prohibited from receiving an award due to a violation of Section 508 of the Clean Water Act or Section 306 of the Clean Air Act.

2. That the contractor agrees to include or cause to be included the requirements of paragraph (1) of this Section X in every subcontract, and further agrees to take such action as the contracting agency may direct as a means of enforcing such requirements.

X. CERTIFICATION REGARDING DEBARMENT, SUSPENSION, INELIGIBILITY AND VOLUNTARY EXCLUSION

This provision is applicable to all Federal-aid construction contracts, design-build contracts, subcontracts, lower-tier subcontracts, purchase orders, lease agreements, consultant contracts or any other covered transaction requiring FHWA approval or that is estimated to cost \$25,000 or more – as defined in 2 CFR Parts 180 and 1200.

1. Instructions for Certification – First Tier Participants:

a. By signing and submitting this proposal, the prospective first tier participant is providing the certification set out below.

b. The inability of a person to provide the certification set out below will not necessarily result in denial of participation in this

covered transaction. The prospective first tier participant shall submit an explanation of why it cannot provide the certification set out below. The certification or explanation will be considered in connection with the department or agency's determination whether to enter into this transaction. However, failure of the prospective first tier participant to furnish a certification or an explanation shall disqualify such a person from participation in this transaction.

c. The certification in this clause is a material representation of fact upon which reliance was placed when the contracting agency determined to enter into this transaction. If it is later determined that the prospective participant knowingly rendered an erroneous certification, in addition to other remedies available to the Federal Government, the contracting agency may terminate this transaction for cause of default.

d. The prospective first tier participant shall provide immediate written notice to the contracting agency to whom this proposal is submitted if any time the prospective first tier participant learns that its certification was erroneous when submitted or has become erroneous by reason of changed circumstances.

e. The terms "covered transaction," "debarred," "suspended," "ineligible," "participant," "person," "principal," and "voluntarily excluded," as used in this clause, are defined in 2 CFR Parts 180 and 1200. "First Tier Covered Transactions" refers to any covered transaction between a grantee or subgrantee of Federal funds and a participant (such as the prime or general contract). "Lower Tier Covered Transactions" refers to any covered transaction under a First Tier Covered Transaction (such as subcontracts). "First Tier Participant" refers to the participant who has entered into a covered transaction with a grantee or subgrantee of Federal funds (such as the prime or general contractor). "Lower Tier Participant" refers any participant who has entered into a covered transaction with a First Tier Participant or other Lower Tier Participants (such as subcontractors and suppliers).

f. The prospective first tier participant agrees by submitting this proposal that, should the proposed covered transaction be entered into, it shall not knowingly enter into any lower tier covered transaction with a person who is debarred, suspended, declared ineligible, or voluntarily excluded from participation in this covered transaction, unless authorized by the department or agency entering into this transaction.

g. The prospective first tier participant further agrees by submitting this proposal that it will include the clause titled "Certification Regarding Debarment, Suspension, Ineligibility and Voluntary Exclusion-Lower Tier Covered Transactions," provided by the department or contracting agency, entering into this covered transaction, without modification, in all lower tier covered transactions and in all solicitations for lower tier covered transactions exceeding the \$25,000 threshold.

h. A participant in a covered transaction may rely upon a certification of a prospective participant in a lower tier covered transaction that is not debarred, suspended, ineligible, or voluntarily excluded from the covered transaction, unless it knows that the certification is erroneous. A participant is responsible for ensuring that its principals are not suspended, debarred, or otherwise ineligible to participate in covered transactions. To verify the eligibility of its principals, as well as the eligibility of any lower tier prospective participants, each participant may, but is not required to, check the Excluded Parties List System website (<https://www.epls.gov/>), which is compiled by the General Services Administration.

i. Nothing contained in the foregoing shall be construed to require the establishment of a system of records in order to render in good faith the certification required by this clause. The knowledge and information of the prospective participant is not required to exceed that which is normally possessed by a prudent person in the ordinary course of business dealings.

j. Except for transactions authorized under paragraph (f) of these instructions, if a participant in a covered transaction knowingly enters into a lower tier covered transaction with a person who is suspended, debarred, ineligible, or voluntarily excluded from participation in this transaction, in addition to other remedies available to the Federal Government, the department or agency may terminate this transaction for cause or default.

2. Certification Regarding Debarment, Suspension, Ineligibility and Voluntary Exclusion – First Tier Participants:

a. The prospective first tier participant certifies to the best of its knowledge and belief, that it and its principals:

(1) Are not presently debarred, suspended, proposed for debarment, declared ineligible, or voluntarily excluded from participating in covered transactions by any Federal department or agency;

(2) Have not within a three-year period preceding this proposal been convicted of or had a civil judgment rendered against them for commission of fraud or a criminal offense in connection with obtaining, attempting to obtain, or performing a public (Federal, State or local) transaction or contract under a public transaction; violation of Federal or State antitrust statutes or commission of embezzlement, theft, forgery, bribery, falsification or destruction of records, making false statements, or receiving stolen property;

(3) Are not presently indicted for or otherwise criminally or civilly charged by a governmental entity (Federal, State or local) with commission of any of the offenses enumerated in paragraph (a)(2) of this certification; and

(4) Have not within a three-year period preceding this application/proposal had one or more public transactions (Federal, State or local) terminated for cause or default.

b. Where the prospective participant is unable to certify to any of the statements in this certification, such prospective participant shall attach an explanation to this proposal.

2. Instructions for Certification - Lower Tier Participants:

(Applicable to all subcontracts, purchase orders and other lower tier transactions requiring prior FHWA approval or estimated to cost \$25,000 or more - 2 CFR Parts 180 and 1200)

a. By signing and submitting this proposal, the prospective lower tier is providing the certification set out below.

b. The certification in this clause is a material representation of fact upon which reliance was placed when this transaction was entered into. If it is later determined that the prospective lower tier participant knowingly rendered an erroneous certification, in addition to other remedies available to the Federal Government, the department, or agency with which

this transaction originated may pursue available remedies, including suspension and/or debarment.

c. The prospective lower tier participant shall provide immediate written notice to the person to which this proposal is submitted if at any time the prospective lower tier participant learns that its certification was erroneous by reason of changed circumstances.

d. The terms "covered transaction," "debarred," "suspended," "ineligible," "participant," "person," "principal," and "voluntarily excluded," as used in this clause, are defined in 2 CFR Parts 180 and 1200. You may contact the person to which this proposal is submitted for assistance in obtaining a copy of those regulations. "First Tier Covered Transactions" refers to any covered transaction between a grantee or subgrantee of Federal funds and a participant (such as the prime or general contract). "Lower Tier Covered Transactions" refers to any covered transaction under a First Tier Covered Transaction (such as subcontracts). "First Tier Participant" refers to the participant who has entered into a covered transaction with a grantee or subgrantee of Federal funds (such as the prime or general contractor). "Lower Tier Participant" refers any participant who has entered into a covered transaction with a First Tier Participant or other Lower Tier Participants (such as subcontractors and suppliers).

e. The prospective lower tier participant agrees by submitting this proposal that, should the proposed covered transaction be entered into, it shall not knowingly enter into any lower tier covered transaction with a person who is debarred, suspended, declared ineligible, or voluntarily excluded from participation in this covered transaction, unless authorized by the department or agency with which this transaction originated.

f. The prospective lower tier participant further agrees by submitting this proposal that it will include this clause titled "Certification Regarding Debarment, Suspension, Ineligibility and Voluntary Exclusion-Lower Tier Covered Transaction," without modification, in all lower tier covered transactions and in all solicitations for lower tier covered transactions exceeding the \$25,000 threshold.

g. A participant in a covered transaction may rely upon a certification of a prospective participant in a lower tier covered transaction that is not debarred, suspended, ineligible, or voluntarily excluded from the covered transaction, unless it knows that the certification is erroneous. A participant is responsible for ensuring that its principals are not suspended, debarred, or otherwise ineligible to participate in covered transactions. To verify the eligibility of its principals, as well as the eligibility of any lower tier prospective participants, each participant may, but is not required to, check the Excluded Parties List System website (<https://www.epls.gov/>), which is compiled by the General Services Administration.

h. Nothing contained in the foregoing shall be construed to require establishment of a system of records in order to render in good faith the certification required by this clause. The knowledge and information of participant is not required to exceed that which is normally possessed by a prudent person in the ordinary course of business dealings.

i. Except for transactions authorized under paragraph e of these instructions, if a participant in a covered transaction knowingly enters into a lower tier covered transaction with a person who is suspended, debarred, ineligible, or voluntarily excluded from participation in this transaction, in addition to other remedies available to the Federal Government, the

department or agency with which this transaction originated may pursue available remedies, including suspension and/or debarment.

* * * * *

Certification Regarding Debarment, Suspension, Ineligibility and Voluntary Exclusion--Lower Tier Participants:

1. The prospective lower tier participant certifies, by submission of this proposal, that neither it nor its principals is presently debarred, suspended, proposed for debarment, declared ineligible, or voluntarily excluded from participating in covered transactions by any Federal department or agency.

2. Where the prospective lower tier participant is unable to certify to any of the statements in this certification, such prospective participant shall attach an explanation to this proposal.

* * * * *

XI. CERTIFICATION REGARDING USE OF CONTRACT FUNDS FOR LOBBYING

This provision is applicable to all Federal-aid construction contracts and to all related subcontracts which exceed \$100,000 (49 CFR 20).

1. The prospective participant certifies, by signing and submitting this bid or proposal, to the best of his or her knowledge and belief, that:

a. No Federal appropriated funds have been paid or will be paid, by or on behalf of the undersigned, to any person for influencing or attempting to influence an officer or employee of any Federal agency, a Member of Congress, an officer or employee of Congress, or an employee of a Member of Congress in connection with the awarding of any Federal contract, the making of any Federal grant, the making of any Federal loan, the entering into of any cooperative agreement, and the extension, continuation, renewal, amendment, or modification of any Federal contract, grant, loan, or cooperative agreement.

b. If any funds other than Federal appropriated funds have been paid or will be paid to any person for influencing or attempting to influence an officer or employee of any Federal agency, a Member of Congress, an officer or employee of Congress, or an employee of a Member of Congress in connection with this Federal contract, grant, loan, or cooperative agreement, the undersigned shall complete and submit Standard Form-LLL, "Disclosure Form to Report Lobbying," in accordance with its instructions.

2. This certification is a material representation of fact upon which reliance was placed when this transaction was made or entered into. Submission of this certification is a prerequisite for making or entering into this transaction imposed by 31 U.S.C. 1352. Any person who fails to file the required certification shall be subject to a civil penalty of not less than \$10,000 and not more than \$100,000 for each such failure.

3. The prospective participant also agrees by submitting its bid or proposal that the participant shall require that the language of this certification be included in all lower tier subcontracts, which exceed \$100,000 and that all such recipients shall certify and disclose accordingly.

**ATTACHMENT A - EMPLOYMENT AND MATERIALS
PREFERENCE FOR APPALACHIAN DEVELOPMENT
HIGHWAY SYSTEM OR APPALACHIAN LOCAL ACCESS
ROAD CONTRACTS**

This provision is applicable to all Federal-aid projects funded under the Appalachian Regional Development Act of 1965.

1. During the performance of this contract, the contractor undertaking to do work which is, or reasonably may be, done as on-site work, shall give preference to qualified persons who regularly reside in the labor area as designated by the DOL wherein the contract work is situated, or the subregion, or the Appalachian counties of the State wherein the contract work is situated, except:

a. To the extent that qualified persons regularly residing in the area are not available.

b. For the reasonable needs of the contractor to employ supervisory or specially experienced personnel necessary to assure an efficient execution of the contract work.

c. For the obligation of the contractor to offer employment to present or former employees as the result of a lawful collective bargaining contract, provided that the number of nonresident persons employed under this subparagraph (1c) shall not exceed 20 percent of the total number of employees employed by the contractor on the contract work, except as provided in subparagraph (4) below.

2. The contractor shall place a job order with the State Employment Service indicating (a) the classifications of the laborers, mechanics and other employees required to perform the contract work, (b) the number of employees required in each classification, (c) the date on which the participant estimates such employees will be required, and (d) any other pertinent information required by the State Employment Service to complete the job order form. The job order may be placed with the State Employment Service in writing or by telephone. If during the course of the contract work, the information submitted by the contractor in the original job order is substantially modified, the participant shall promptly notify the State Employment Service.

3. The contractor shall give full consideration to all qualified job applicants referred to him by the State Employment Service. The contractor is not required to grant employment to any job applicants who, in his opinion, are not qualified to perform the classification of work required.

4. If, within one week following the placing of a job order by the contractor with the State Employment Service, the State Employment Service is unable to refer any qualified job applicants to the contractor, or less than the number requested, the State Employment Service will forward a certificate to the contractor indicating the unavailability of applicants. Such certificate shall be made a part of the contractor's permanent project records. Upon receipt of this certificate, the contractor may employ persons who do not normally reside in the labor area to fill positions covered by the certificate, notwithstanding the provisions of subparagraph (1c) above.

5. The provisions of 23 CFR 633.207(e) allow the contracting agency to provide a contractual preference for the use of mineral resource materials native to the Appalachian region.

6. The contractor shall include the provisions of Sections 1 through 4 of this Attachment A in every subcontract for work which is, or reasonably may be, done as on-site work.

**KENTUCKY TRANSPORTATION CABINET
DEPARTMENT OF HIGHWAYS**

**EMPLOYMENT REQUIREMENTS
RELATING TO
NONDISCRIMINATION OF EMPLOYEES
(APPLICABLE TO FEDERAL-AID SYSTEM CONTRACTS)**

**AN ACT OF THE KENTUCKY GENERAL ASSEMBLY
TO PREVENT DISCRIMINATION IN EMPLOYMENT**

**KRS CHAPTER 344
EFFECTIVE JUNE 16, 1972**

The contract on this project, in accordance with KRS Chapter 344, provides that during the performance of this contract, the contractor agrees as follows:

1. The contractor shall not fail or refuse to hire, or shall not discharge any individual, or otherwise discriminate against an individual with respect to his compensation, terms, conditions, or privileges of employment, because of such individual's race, color, religion, national origin, sex, disability or age (forty and above); or limit, segregate, or classify his employees in any way which would deprive or tend to deprive an individual of employment opportunities or otherwise adversely affect his status as an employee, because of such individual's race, color, religion, national origin, sex, disability or age forty (40) and over. The contractor agrees to post in conspicuous places, available to employees and applicants for employment, notices to be provided setting forth the provisions of this nondiscrimination clause.

2. The contractor shall not print or publish or cause to be printed or published a notice or advertisement relating to employment by such an employer or membership in or any classification or referral for employment by the employment agency, indicating any preference, limitation, specification, or discrimination, based on race, color, religion, national origin, sex, or age forty (40) and over, or because the person is a qualified individual with a disability, except that such a notice or advertisement may indicate a preference, limitation, or specification based on religion, national origin, sex, or age forty (40) and over, or because the person is a qualified individual with a disability, when religion, national origin, sex, or age forty (40) and over, or because the person is a qualified individual with a disability, is a bona fide occupational qualification for employment.

3. If the contractor is in control of apprenticeship or other training or retraining, including on-the-job training programs, he shall not discriminate against an individual because of his race, color, religion, national origin, sex, disability or age forty (40) and over, in admission to, or employment in any program established to provide apprenticeship or other training.

4. The contractor will send to each labor union or representative of workers with which he has a collective bargaining agreement or other contract or understanding, a notice to be provided advising the said labor union or workers' representative of the contractor's commitments under this section, and shall post copies of the notice in conspicuous places available to employees and applicants for employment. The contractor will take such action with respect to any subcontract or purchase order as the administering agency may direct as a means of enforcing such provisions, including sanctions for non-compliance.

Revised: January 25, 2017

EXECUTIVE BRANCH CODE OF ETHICS

In the 1992 regular legislative session, the General Assembly passed and Governor Brereton Jones signed Senate Bill 63 (codified as KRS 11A), the Executive Branch Code of Ethics, which states, in part:

KRS 11A.040 (7) provides:

No present or former public servant shall, within six (6) months following termination of his office or employment, accept employment, compensation, or other economic benefit from any person or business that contracts or does business with, or is regulated by, the state in matters in which he was directly involved during the last thirty-six (36) months of his tenure. This provision shall not prohibit an individual from returning to the same business, firm, occupation, or profession in which he was involved prior to taking office or beginning his term of employment, or for which he received, prior to his state employment, a professional degree or license, provided that, for a period of six (6) months, he personally refrains from working on any matter in which he was directly involved during the last thirty-six (36) months of his tenure in state government. This subsection shall not prohibit the performance of ministerial functions, including but not limited to filing tax returns, filing applications for permits or licenses, or filing incorporation papers, nor shall it prohibit the former officer or public servant from receiving public funds disbursed through entitlement programs.

KRS 11A.040 (9) states:

A former public servant shall not represent a person or business before a state agency in a matter in which the former public servant was directly involved during the last thirty-six (36) months of his tenure, for a period of one (1) year after the latter of:

- a) The date of leaving office or termination of employment; or
- b) The date the term of office expires to which the public servant was elected.

This law is intended to promote public confidence in the integrity of state government and to declare as public policy the idea that state employees should view their work as a public trust and not as a way to obtain private benefits.

If you have worked for the executive branch of state government within the past six months, you may be subject to the law's prohibitions. The law's applicability may be different if you hold elected office or are contemplating representation of another before a state agency.

Also, if you are affiliated with a firm which does business with the state and which employs former state executive-branch employees, you should be aware that the law may apply to them.

In case of doubt, the law permits you to request an advisory opinion from the Executive Branch Ethics Commission, 3 Fountain Place, Frankfort, Kentucky 40601; telephone (502) 564-7954.

Revised: January 27, 2017

General Decision Number: KY170100 09/08/2017 KY100

Superseded General Decision Number: KY20160100

State: Kentucky

Construction Type: Highway

Counties: Anderson, Bath, Bourbon, Boyd, Boyle, Bracken, Breckinridge, Bullitt, Carroll, Carter, Clark, Elliott, Fayette, Fleming, Franklin, Gallatin, Grant, Grayson, Greenup, Hardin, Harrison, Henry, Jefferson, Jessamine, Larue, Lewis, Madison, Marion, Mason, Meade, Mercer, Montgomery, Nelson, Nicholas, Oldham, Owen, Robertson, Rowan, Scott, Shelby, Spencer, Trimble, Washington and Woodford Counties in Kentucky.

HIGHWAY CONSTRUCTION PROJECTS (excluding tunnels, building structures in rest area projects & railroad construction; bascule, suspension & spandrel arch bridges designed for commercial navigation, bridges involving marine construction; and other major bridges).

Note: Under Executive Order (EO) 13658, an hourly minimum wage of \$10.20 for calendar year 2017 applies to all contracts subject to the Davis-Bacon Act for which the contract is awarded (and any solicitation was issued) on or after January 1, 2015. If this contract is covered by the EO, the contractor must pay all workers in any classification listed on this wage determination at least \$10.20 (or the applicable wage rate listed on this wage determination, if it is higher) for all hours spent performing on the contract in calendar year 2017. The EO minimum wage rate will be adjusted annually. Additional information on contractor requirements and worker protections under the EO is available at www.dol.gov/whd/govcontracts.

Modification Number	Publication Date
0	01/06/2017
1	01/13/2017
2	02/03/2017
3	03/10/2017
4	05/19/2017
5	07/14/2017
6	08/04/2017
7	08/11/2017
8	09/08/2017

BRIN0004-003 06/01/2016

BRECKENRIDGE COUNTY

	Rates	Fringes
BRICKLAYER.....	\$ 25.96	11.38

BRKY0001-005 06/01/2016

BULLITT, CARROLL, GRAYSON, HARDIN, HENRY, JEFFERSON, LARUE,

MARION, MEADE, NELSON, OLDHAM, SHELBY, SPENCER, & TRIMBLE
 COUNTIES:

	Rates	Fringes
BRICKLAYER.....	\$ 25.96	11.38

BRKY0002-006 06/01/2016		

BRACKEN, GALLATIN, GRANT, MASON & ROBERTSON COUNTIES:

	Rates	Fringes
BRICKLAYER.....	\$ 27.01	11.38

BRKY0007-004 06/01/2016		

BOYD, CARTER, ELLIOT, FLEMING, GREENUP, LEWIS & ROWAN COUNTIES:

	Rates	Fringes
BRICKLAYER.....	\$ 32.20	18.78

BRKY0017-004 06/01/2016		

ANDERSON, BATH, BOURBON, BOYLE, CLARK, FAYETTE, FRANKLIN,
 HARRISON, JESSAMINE, MADISON, MERCER, MONTGOMERY, NICHOLAS,
 OWEN, SCOTT, WASHINGTON & WOODFORD COUNTIES:

	Rates	Fringes
BRICKLAYER.....	\$ 25.64	11.38

CARP0064-001 05/01/2015		

	Rates	Fringes
CARPENTER.....	\$ 27.50	16.06
Diver.....	\$ 41.63	16.06
PILEDRIVERMAN.....	\$ 27.75	16.06

ELEC0212-008 06/05/2017		

BRACKEN, GALLATIN and GRANT COUNTIES

	Rates	Fringes
ELECTRICIAN.....	\$ 27.90	17.56

ELEC0212-014 12/01/2014		

BRACKEN, GALLATIN & GRANT COUNTIES:

	Rates	Fringes
Sound & Communication Technician.....	\$ 22.75	10.08

ELEC0317-012 06/01/2016

BOYD, CARTER, ELLIOT & ROWAN COUNTIES:

	Rates	Fringes
ELECTRICIAN (Wiremen)		
Cable Splicer.....	\$ 32.68	18.13
Electrician.....	\$ 33.31	22.98

ELEC0369-007 06/01/2016

ANDERSON, BATH, BOURBON, BOYLE, BRECKINRIDGE, BULLITT, CARROLL,
CLARK, FAYETTE, FRAONKLIN, GRAYSON, HARDIN, HARRISON, HENRY,
JEFFERSON, JESSAMINE, LARUE, MADISON, MARION, MEADE, MERCER,
MONTGOMERY, NELSON, NICHOLAS, OLDHAM, OWEN, ROBERTSON, SCOTT,
SHELBY, SPENCER, TRIMBLE, WASHINGTON, & WOODFORD COUNTIES:

	Rates	Fringes
ELECTRICIAN.....	\$ 30.56	16.10

* ELEC0575-002 05/29/2017

FLEMING, GREENUP, LEWIS & MASON COUNTIES:

	Rates	Fringes
ELECTRICIAN.....	\$ 32.15	15.77

ENGI0181-018 07/01/2017

	Rates	Fringes
POWER EQUIPMENT OPERATOR		
GROUP 1.....	\$ 31.95	15.15
GROUP 2.....	\$ 29.09	15.15
GROUP 3.....	\$ 29.54	15.15
GROUP 4.....	\$ 28.77	15.15

OPERATING ENGINEER CLASSIFICATIONS

GROUP 1 - A-Frame Winch Truck; Auto Patrol; Backfiller;
Batcher Plant; Bituminous Paver; Bituminous Transfer
Machine; Boom Cat; Bulldozer; Mechanic; Cableway; Carry-All
Scoop; Carry Deck Crane; Central Compressor Plant; Cherry
Picker; Clamshell; Concrete Mixer (21 cu. ft. or Over);
Concrete Paver; Truck-Mounted Concrete Pump; Core Drill;
Crane; Crusher Plant; Derrick; Derrick Boat; Ditching &
Trenching Machine; Dragline; Dredge Operator; Dredge
Engineer; Elevating Grader & Loaders; Grade-All; Gurries;
Heavy Equipment Robotics Operator/Mechanic; High Lift;
Hoe-Type Machine; Hoist (Two or More Drums); Hoisting
Engine (Two or More Drums); Horizontal Directional Drill
Operator; Hydrocrane; Hyster; KeCal Loader; LeTourneau;
Locomotive; Mechanic; Mechanically Operated Laser Sceded;
Mechanic Welder; Mucking Machine; Motor Scraper; Orangepeel
Bucket; Overhead Crane; Piledriver; Power Blade; Pumpcrete;
Push Dozer; Rock Spreader, attached to equipment; Rotary

Drill; Roller (Bituminous); Rough Terrain Crane; Scarifier;
Scoopmobile; Shovel; Side Boom; Subgrader; Tailboom;
Telescoping Type Forklift; Tow or Push Boat; Tower Crane
(French, German & other types); Tractor Shovel; Truck
Crane; Tunnel Mining Machines, including Moles, Shields or
similar types of Tunnel Mining Equipment

GROUP 2 - Air Compressor (Over 900 cu. ft. per min.);
Bituminous Mixer; Boom Type Tamping Machine; Bull Float;
Concrete Mixer (Under 21 cu. ft.); Dredge Engineer;
Electric Vibrator; Compactor/Self-Propelled Compactor;
Elevator (One Drum or Buck Hoist); Elevator (When used to
Hoist Building Material); Finish Machine; Firemen & Hoist
(One Drum); Flexplane; Forklift (Regardless of Lift
Height); Form Grader; Joint Sealing Machine; Outboard Motor
Boat; Power Sweeper (Riding Type); Roller (Rock); Ross
Carrier; Skid Mounted or Trailer Mounted Concrete Pump; Skid
Steer Machine with all Attachments; Switchman or Brakeman;
Throttle Valve Person; Tractair & Road Widening Trencher;
Tractor (50 H.P. or Over); Truck Crane Oiler; Tugger;
Welding Machine; Well Points; & Whirley Oiler

GROUP 3 - All Off Road Material Handling Equipment,
including Articulating Dump Trucks; Greaser on Grease
Facilities servicing Heavy Equipment

GROUP 4 - Bituminous Distributor; Burlap & Curing Machine;
Cement Gun; Concrete Saw; Conveyor; Deckhand Oiler; Grout
Pump; Hydraulic Post Driver; Hydro Seeder; Mud Jack; Oiler;
Paving Joint Machine; Power Form Handling Equipment; Pump;
Roller (Earth); Steerman; Tamping Machine; Tractor (Under
50 H.P.); & Vibrator

CRANES - with booms 150 ft. & Over (Including JIB), and where
the length of the boom in combination with the length of
the piling leads equals or exceeds 150 ft. - \$1.00 over
Group 1 rate

EMPLOYEES ASSIGNED TO WORK BELOW GROUND LEVEL ARE TO BE PAID
10%
ABOVE BASIC WAGE RATE. THIS DOES NOT APPLY TO OPEN CUT WORK.

IRON0044-009 06/01/2017

BRACKEN, GALLATIN, GRANT, HARRISON, ROBERTSON,
BOURBON (Northern third, including Townships of Jackson,
Millersburg, Ruddel Mills & Shawhan);
CARROLL (Eastern third, including the Township of Ghent);
FLEMING (Western part, excluding Townships of Beechburg, Colfax,
Elizaville, Flemingsburg, Flemingsburg Junction, Foxport,
Grange City, Hillsboro, Hilltop, Mount Carmel, Muses Mills,
Nepton, Pecksridge, Plummers Landing, Plummers Mill, Poplar
Plains, Ringos Mills, Tilton & Wallingford);
MASON (Western two-thirds, including Townships of Dover,
Lewisburg, Mays Lick, Maysville, Minerva, Moranburg,
Murphysville, Ripley, Sardis, Shannon, South Ripley &
Washington);
NICHOLAS (Townships of Barefoot, Barterville, Carlisle,
Ellisville, Headquarters, Henryville, Morningglory, Myers &

Oakland Mills);
OWEN (Townships of Beechwood, Bromley, Fairbanks, Holbrook, Jonesville, Long Ridge, Lusby's Mill, New, New Columbus, New Liberty, Owenton, Poplar Grove, Rockdale, Sanders, Teresita & Wheatley);
SCOTT (Northern two-thirds, including Townships of Biddle, Davis, Delaplain, Elmville, Longlick, Muddy Ford, Oxford, Rogers Gap, Sadieville, Skinnersburg & Stonewall)

	Rates	Fringes
IRONWORKER		
Fence Erector.....	\$ 23.76	19.15
Structural.....	\$ 27.60	20.10

IRON0070-006 06/01/2017

ANDERSON, BOYLE, BRECKINRIDGE, BULLITT, FAYETTE, FRANKLIN, GRAYSON, HARDIN, HENRY, JEFFERSON, JESSAMINE, LARUE, MADISON, MARION, MEADE, MERCER, NELSON, OLDHAM, SHELBY, SPENCER, TRIMBLE, WASHINGTON & WOODFORD
BOURBON (Southern two-thirds, including Townships of Austerlity, Centerville, Clintonville, Elizabeth, Hutchison, Littlerock, North Middletown & Paris);
CARROLL (Western two-thirds, including Townships of Carrollton, Easterday, English, Locust, Louis, Prestonville & Worthville);
CLARK (Western two-thirds, including Townships of Becknerville, Flanagan, Ford, Pine Grove, Winchester & Wyandotte);
OWEN (Eastern eighth, including Townships of Glenmary, Gratz, Monterey, Perry Park & Tacketts Mill);
SCOTT (Southern third, including Townships of Georgetown, Great Crossing, Newtown, Stampling Ground & Woodlake);

	Rates	Fringes
IRONWORKER.....	\$ 28.30	21.85

IRON0372-006 07/15/2016

BRACKEN, GALLATIN, GRANT, HARRISON and ROBERTSON
BOURBON (Northern third, including Townships of Jackson, Millersburg, Ruddel Mills & Shawhan);
CARROLL (Eastern third, including the Township of Ghent);
FLEMING (Western part, Excluding Townships of Beechburg, Colfax, Elizaville, Flemingsburg, Flemingsburg Junction, Foxport, Grange City, Hillsboro, Hilltop, Mount Carmel, Muses Mills, Nepton, Pecksridge, Plummers Landing, Plummers Mill, Poplar Plains, Ringos Mills, Tilton & Wallingford);
MASON (Western two-thirds, including Townships of Dover, Lewisburg, Mays Lick, Maysville, Minerva, Moranburg, Murphysville, Ripley, Sardis, Shannon, South Ripley & Washington);
NICHOLAS (Townships of Barefoot, Barterville, Carlisle, Ellisville, Headquarters, Henryville, Morningglory, Myers & Oakland Mills);
OWEN (Townships of Beechwood, Bromley, Fairbanks, Holbrook, Jonesville, Long Ridge, Lusby's Mill, New, New Columbus, New

Liberty, Owenton, Poplar Grove, Rockdale, Sanders, Teresita & Wheatley);
 SCOTT (Northern two-thirds, including Townships of Biddle, Davis, Delaplain, Elmvilleville, Longlick, Muddy Ford, Oxford, Rogers Gap, Sadieville, Skinnersburg & Stonewall) COUNTIES

	Rates	Fringes
IRONWORKER, REINFORCING.....	\$ 27.15	20.33

 IRON0769-007 06/01/2017

BATH, BOYD, CARTER, ELLIOTT, GREENUP, LEWIS, MONTGOMERY & ROWAN CLARK (Eastern third, including townships of Bloomingdale, Hunt, Indian Fields, Kiddville, Loglick, Rightangele & Thomson); FLEMING (Townships of Beechburg, Colfax, Elizaville, Flemingsburg, Flemingsburg Junction, Foxport, Grange City, Hillsboro, Hilltop, Mount Carmel, Muses Mills, Nepton, Pecksville, Plummers Landing, Plummers Mill, Poplar Plains, Ringos Mills, Tilton & Wallingford); MASON (Eastern third, including Townships of Helena, Marshall, Orangeburg, Plumville & Springdale); NICHOLAS (Eastern eighth, including the Township of Moorefield Sprout)

	Rates	Fringes
IRONWORKER		
ZONE 1.....	\$ 31.33	23.97
ZONE 2.....	\$ 31.73	23.97
ZONE 3.....	\$ 33.33	23.97

ZONE 1 - Up to 10 mile radius of Union Hall, Ashland, Ky.,
 1643 Greenup Ave.

ZONE 2 - 10 to 50 mile radius of Union Hall, Ashland, Ky.,
 1643 Greenup Ave.

ZONE 3 - 50 mile radius & over of Union Hall, Ashland, Ky.,
 1643 Greenup Ave.

 LABO0189-003 07/01/2016

BATH, BOURBON, BOYD, BOYLE, BRACKEN, CARTER, CLARK, ELLIOTT, FAYETTE, FLEMING, FRANKLIN, GALLATIN, GRANT, GREENUP, HARRISON, JESSAMINE, LEWIS, MADISON, MASON, MERCER, MONTGOMERY, NICHOLAS, OWEN, ROBERTSON, ROWAN, SCOTT, & WOOLFORD COUNTIES

	Rates	Fringes
Laborers:		
GROUP 1.....	\$ 23.14	13.29
GROUP 2.....	\$ 23.39	13.29
GROUP 3.....	\$ 23.44	13.29
GROUP 4.....	\$ 24.04	13.29

LABORERS CLASSIFICATIONS

GROUP 1 - Aging & Curing of Concrete; Asbestos Abatement Worker; Asphalt Plant; Asphalt; Batch Truck Dump; Carpenter Tender; Cement Mason Tender; Cleaning of Machines; Concrete; Demolition; Dredging; Environmental - Nuclear, Radiation, Toxic & Hazardous Waste - Level D; Flagperson; Grade Checker; Hand Digging & Hand Back Filling; Highway Marker Placer; Landscaping, Mesh Handler & Placer; Puddler; Railroad; Rip-rap & Grouter; Right-of-Way; Sign, Guard Rail & Fence Installer; Signal Person; Sound Barrier Installer; Storm & Sanitary Sewer; Swamper; Truck Spotter & Dumper; Wrecking of Concrete Forms; General Cleanup

GROUP 2 - Batter Board Man (Sanitary & Storm Sewer); Brickmason Tender; Mortar Mixer Operator; Scaffold Builder; Burner & Welder; Bushhammer; Chain Saw Operator; Concrete Saw Operator; Deckhand Scow Man; Dry Cement Handler; Environmental - Nuclear, Radiation, Toxic & Hazardous Waste - Level C; Forklift Operator for Masonary; Form Setter; Green Concrete Cutting; Hand Operated Grouter & Grinder Machine Operator; Jackhammer; Pavement Breaker; Paving Joint Machine; Pipelayer; Plastic Pipe Fusion; Power Driven Georgia Buggy & Wheel Barrow; Power Post Hole Digger; Precast Manhole Setter; Walk-Behind Tamper; Walk-Behind Trencher; Sand Blaster; Concrete Chipper; Surface Grinder; Vibrator Operator; Wagon Driller

GROUP 3 - Asphalt Luteman & Raker; Gunnite Nozzleman; Gunnite Operator & Mixer; Grout Pump Operator; Side Rail Setter; Rail Paved Ditches; Screw Operator; Tunnel (Free Air); Water Blaster

GROUP 4 - Caisson Worker (Free Air); Cement Finisher; Environmental - Nuclear, Radiation, Toxic & Hazardous Waste - Levels A & B; Miner & Driller (Free Air); Tunnel Blaster; & Tunnel Mucker (Free Air); Directional & Horizontal Boring; Air Track Drillers (All Types); Powdermen & Blasters; Troxler & Concrete Tester if Laborer is Utilized

LABO0189-008 07/01/2017

ANDERSON, BULLITT, CARROLL, HARDIN, HENRY, JEFFERSON, LARUE, MARION, MEADE, NELSON, OLDHAM, SHELBY, SPENCER, TRIMBLE & WASHINGTON COUNTIES

	Rates	Fringes
Laborers:		
GROUP 1.....	\$ 23.14	13.29
GROUP 2.....	\$ 23.39	13.29
GROUP 3.....	\$ 23.44	13.29
GROUP 4.....	\$ 24.04	13.29

LABORERS CLASSIFICATIONS

GROUP 1 - Aging & Curing of Concrete; Asbestos Abatement Worker; Asphalt Plant; Asphalt; Batch Truck Dump; Carpenter

Tender; Cement Mason Tender; Cleaning of Machines;
Concrete; Demolition; Dredging; Environmental - Nuclear,
Radiation, Toxic & Hazardous Waste - Level D; Flagperson;
Grade Checker; Hand Digging & Hand Back Filling; Highway
Marker Placer; Landscaping, Mesh Handler & Placer; Puddler;
Railroad; Rip-rap & Grouter; Right-of-Way; Sign, Guard Rail
& Fence Installer; Signal Person; Sound Barrier Installer;
Storm & Sanitary Sewer; Swamper; Truck Spotter & Dumper;
Wrecking of Concrete Forms; General Cleanup

GROUP 2 - Batter Board Man (Sanitary & Storm Sewer);
Brickmason Tender; Mortar Mixer Operator; Scaffold Builder;
Burner & Welder; Bushhammer; Chain Saw Operator; Concrete
Saw Operator; Deckhand Scow Man; Dry Cement Handler;
Environmental - Nuclear, Radiation, Toxic & Hazardous Waste
- Level C; Forklift Operator for Masonary; Form Setter;
Green Concrete Cutting; Hand Operated Grouter & Grinder
Machine Operator; Jackhammer; Pavement Breaker; Paving
Joint Machine; Pipelayer; Plastic Pipe Fusion; Power Driven
Georgia Buggy & Wheel Barrow; Power Post Hole Digger;
Precast Manhole Setter; Walk-Behind Tamper; Walk-Behind
Trencher; Sand Blaster; Concrete Chipper; Surface Grinder;
Vibrator Operator; Wagon Driller

GROUP 3 - Asphalt Luteman & Raker; Gunnite Nozzleman;
Gunnite Operator & Mixer; Grout Pump Operator; Side Rail
Setter; Rail Paved Ditches; Screw Operator; Tunnel (Free
Air); Water Blaster

GROUP 4 - Caisson Worker (Free Air); Cement Finisher;
Environmental - Nuclear, Radiation, Toxic & Hazardous Waste
- Levels A & B; Miner & Driller (Free Air); Tunnel Blaster;
& Tunnel Mucker (Free Air); Directional & Horizontal
Boring; Air Track Drillers (All Types); Powdermen &
Blasters; Troxler & Concrete Tester if Laborer is Utilized

LABO0189-009 07/01/2014

BRECKINRIDGE & GRAYSON COUNTIES

	Rates	Fringes
Laborers:		
GROUP 1.....	\$ 22.66	11.10
GROUP 2.....	\$ 22.91	11.10
GROUP 3.....	\$ 22.96	11.10
GROUP 4.....	\$ 23.56	11.10

LABORERS CLASSIFICATIONS

GROUP 1 - Aging & Curing of Concrete; Asbestos Abatement
Worker; Asphalt Plant; Asphalt; Batch Truck Dump; Carpenter
Tender; Cement Mason Tender; Cleaning of Machines;
Concrete; Demolition; Dredging; Environmental - Nuclear,
Radiation, Toxic & Hazardous Waste - Level D; Flagperson;
Grade Checker; Hand Digging & Hand Back Filling; Highway
Marker Placer; Landscaping, Mesh Handler & Placer; Puddler;
Railroad; Rip-rap & Grouter; Right-of-Way; Sign, Guard Rail
& Fence Installer; Signal Person; Sound Barrier Installer;

Storm & Sanitary Sewer; Swamper; Truck Spotter & Dumper;
Wrecking of Concrete Forms; General Cleanup

GROUP 2 - Batter Board Man (Sanitary & Storm Sewer);
Brickmason Tender; Mortar Mixer Operator; Scaffold Builder;
Burner & Welder; Bushhammer; Chain Saw Operator; Concrete
Saw Operator; Deckhand Scow Man; Dry Cement Handler;
Environmental - Nuclear, Radiation, Toxic & Hazardous Waste
- Level C; Forklift Operator for Masonary; Form Setter;
Green Concrete Cutting; Hand Operated Grouter & Grinder
Machine Operator; Jackhammer; Pavement Breaker; Paving
Joint Machine; Pipelayer; Plastic Pipe Fusion; Power Driven
Georgia Buggy & Wheel Barrow; Power Post Hole Digger;
Precast Manhole Setter; Walk-Behind Tamper; Walk-Behind
Trencher; Sand Blaster; Concrete Chipper; Surface Grinder;
Vibrator Operator; Wagon Driller

GROUP 3 - Asphalt Luteman & Raker; Gunnite Nozzleman;
Gunnite Operator & Mixer; Grout Pump Operator; Side Rail
Setter; Rail Paved Ditches; Screw Operator; Tunnel (Free
Air); Water Blaster

GROUP 4 - Caisson Worker (Free Air); Cement Finisher;
Environmental - Nuclear, Radiation, Toxic & Hazardous Waste
- Levels A & B; Miner & Driller (Free Air); Tunnel Blaster;
& Tunnel Mucker (Free Air); Directional & Horizontal
Boring; Air Track Drillers (All Types); Powdermen &
Blasters; Troxler & Concrete Tester if Laborer is Utilized

PAIN0012-005 06/11/2005

BATH, BOURBON, BOYLE, CLARK, FAYETTE, FLEMING, FRANKLIN,
HARRISON, JESSAMINE, MADISON, MERCER, MONTGOMERY, NICHOLAS,
ROBERTSON, SCOTT & WOODFORD COUNTIES:

	Rates	Fringes
PAINTER		
Bridge/Equipment Tender and/or Containment Builder..\$	18.90	5.90
Brush & Roller.....\$	21.30	5.90
Elevated Tanks; Steeplejack Work; Bridge & Lead Abatement.....\$	22.30	5.90
Sandblasting & Waterblasting.....\$	22.05	5.90
Spray.....\$	21.80	5.90

PAIN0012-017 05/01/2015

BRACKEN, GALLATIN, GRANT, MASON & OWEN COUNTIES:

	Rates	Fringes
PAINTER (Heavy & Highway Bridges - Guardrails - Lightpoles - Striping) Bridge Equipment Tender		

and Containment Builder.....	\$ 20.73	9.06
Brush & Roller.....	\$ 23.39	9.06
Elevated Tanks; Steeplejack Work; Bridge & Lead Abatement.....	\$ 24.39	9.06
Sandblasting & Water Blasting.....	\$ 24.14	9.06
Spray.....	\$ 23.89	9.06

PAIN0118-004 06/01/2014

ANDERSON, BRECKINRIDGE, BULLITT, CARROLL, GRAYSON, HARDIN,
HENRY, JEFFERSON, LARUE, MARION, MEADE, NELSON, OLDHAM, SHELBY,
SPENCER, TRIMBLE & WASHINGTON COUNTIES:

	Rates	Fringes
PAINTER		
Brush & Roller.....	\$ 18.50	11.97
Spray, Sandblast, Power Tools, Waterblast & Steam Cleaning.....	\$ 19.50	11.97

PAIN1072-003 12/01/2016

BOYD, CARTER, ELLIOTT, GREENUP, LEWIS and ROWAN COUNTIES

	Rates	Fringes
Painters:		
Bridges; Locks; Dams; Tension Towers & Energized Substations.....	\$ 32.98	16.15
Power Generating Facilities.....	\$ 29.74	16.15

PLUM0248-003 06/01/2017

BOYD, CARTER, ELLIOTT, GREENUP, LEWIS & ROWAN COUNTIES:

	Rates	Fringes
Plumber and Steamfitter.....	\$ 35.00	25.12

PLUM0392-007 06/01/2014

BRACKEN, CARROLL (Eastern Half), GALLATIN, GRANT, MASON, OWEN &
ROBERTSON COUNTIES:

	Rates	Fringes
Plumbers and Pipefitters.....	\$ 29.80	17.79

PLUM0502-003 08/01/2016

BRECKINRIDGE, BULLITT, CARROLL (Western Half), FRANKLIN
(Western three-fourths), GRAYSON, HARDIN, HENRY, JEFFERSON,
LARUE, MARION, MEADE, NELSON, OLDHAM, SHELBY, SPENCER, TRIMBLE &
WASHINGTON COUNTIES

	Rates	Fringes
PLUMBER.....	\$ 32.00	20.13

SUKY2010-160 10/08/2001

	Rates	Fringes
Truck drivers:		
GROUP 1.....	\$ 16.57	7.34
GROUP 2.....	\$ 16.68	7.34
GROUP 3.....	\$ 16.86	7.34
GROUP 4.....	\$ 16.96	7.34

TRUCK DRIVER CLASSIFICATIONS

GROUP 1 - Mobile Batch Truck Tender

GROUP 2 - Greaser; Tire Changer; & Mechanic Tender

GROUP 3 - Single Axle Dump; Flatbed; Semi-trailer or Pole Trailer when used to pull building materials and equipment; Tandem Axle Dump; Distributor; Mixer; & Truck Mechanic

GROUP 4 - Euclid & Other Heavy Earthmoving Equipment & Lowboy; Articulator Cat; 5-Axle Vehicle; Winch & A-Frame when used in transporting materials; Ross Carrier; Forklift when used to transport building materials; & Pavement Breaker

WELDERS - Receive rate prescribed for craft performing operation to which welding is incidental.
=====

Note: Executive Order (EO) 13706, Establishing Paid Sick Leave for Federal Contractors applies to all contracts subject to the Davis-Bacon Act for which the contract is awarded (and any solicitation was issued) on or after January 1, 2017. If this contract is covered by the EO, the contractor must provide employees with 1 hour of paid sick leave for every 30 hours they work, up to 56 hours of paid sick leave each year. Employees must be permitted to use paid sick leave for their own illness, injury or other health-related needs, including preventive care; to assist a family member (or person who is like family to the employee) who is ill, injured, or has other health-related needs, including preventive care; or for reasons resulting from, or to assist a family member (or person who is like family to the employee) who is a victim of, domestic violence, sexual assault, or stalking. Additional information on contractor requirements and worker protections under the EO is available at www.dol.gov/whd/govcontracts.

Unlisted classifications needed for work not included within the scope of the classifications listed may be added after award only as provided in the labor standards contract clauses

(29CFR 5.5 (a) (1) (ii)).

The body of each wage determination lists the classification and wage rates that have been found to be prevailing for the cited type(s) of construction in the area covered by the wage determination. The classifications are listed in alphabetical order of "identifiers" that indicate whether the particular rate is a union rate (current union negotiated rate for local), a survey rate (weighted average rate) or a union average rate (weighted union average rate).

Union Rate Identifiers

A four letter classification abbreviation identifier enclosed in dotted lines beginning with characters other than "SU" or "UAVG" denotes that the union classification and rate were prevailing for that classification in the survey. Example: PLUM0198-005 07/01/2014. PLUM is an abbreviation identifier of the union which prevailed in the survey for this classification, which in this example would be Plumbers. 0198 indicates the local union number or district council number where applicable, i.e., Plumbers Local 0198. The next number, 005 in the example, is an internal number used in processing the wage determination. 07/01/2014 is the effective date of the most current negotiated rate, which in this example is July 1, 2014.

Union prevailing wage rates are updated to reflect all rate changes in the collective bargaining agreement (CBA) governing this classification and rate.

Survey Rate Identifiers

Classifications listed under the "SU" identifier indicate that no one rate prevailed for this classification in the survey and the published rate is derived by computing a weighted average rate based on all the rates reported in the survey for that classification. As this weighted average rate includes all rates reported in the survey, it may include both union and non-union rates. Example: SULA2012-007 5/13/2014. SU indicates the rates are survey rates based on a weighted average calculation of rates and are not majority rates. LA indicates the State of Louisiana. 2012 is the year of survey on which these classifications and rates are based. The next number, 007 in the example, is an internal number used in producing the wage determination. 5/13/2014 indicates the survey completion date for the classifications and rates under that identifier.

Survey wage rates are not updated and remain in effect until a new survey is conducted.

Union Average Rate Identifiers

Classification(s) listed under the UAVG identifier indicate that no single majority rate prevailed for those classifications; however, 100% of the data reported for the

classifications was union data. EXAMPLE: UAVG-OH-0010
08/29/2014. UAVG indicates that the rate is a weighted union
average rate. OH indicates the state. The next number, 0010 in
the example, is an internal number used in producing the wage
determination. 08/29/2014 indicates the survey completion date
for the classifications and rates under that identifier.

A UAVG rate will be updated once a year, usually in January of
each year, to reflect a weighted average of the current
negotiated/CBA rate of the union locals from which the rate is
based.

WAGE DETERMINATION APPEALS PROCESS

1.) Has there been an initial decision in the matter? This can
be:

- * an existing published wage determination
- * a survey underlying a wage determination
- * a Wage and Hour Division letter setting forth a position on
a wage determination matter
- * a conformance (additional classification and rate) ruling

On survey related matters, initial contact, including requests
for summaries of surveys, should be with the Wage and Hour
Regional Office for the area in which the survey was conducted
because those Regional Offices have responsibility for the
Davis-Bacon survey program. If the response from this initial
contact is not satisfactory, then the process described in 2.)
and 3.) should be followed.

With regard to any other matter not yet ripe for the formal
process described here, initial contact should be with the
Branch of Construction Wage Determinations. Write to:

Branch of Construction Wage Determinations
Wage and Hour Division
U.S. Department of Labor
200 Constitution Avenue, N.W.
Washington, DC 20210

2.) If the answer to the question in 1.) is yes, then an
interested party (those affected by the action) can request
review and reconsideration from the Wage and Hour Administrator
(See 29 CFR Part 1.8 and 29 CFR Part 7). Write to:

Wage and Hour Administrator
U.S. Department of Labor
200 Constitution Avenue, N.W.
Washington, DC 20210

The request should be accompanied by a full statement of the
interested party's position and by any information (wage
payment data, project description, area practice material,
etc.) that the requestor considers relevant to the issue.

3.) If the decision of the Administrator is not favorable, an interested party may appeal directly to the Administrative Review Board (formerly the Wage Appeals Board). Write to:

Administrative Review Board
U.S. Department of Labor
200 Constitution Avenue, N.W.
Washington, DC 20210

4.) All decisions by the Administrative Review Board are final.

=====

END OF GENERAL DECISION

Fringe benefit amounts are applicable for all hours worked except when otherwise noted.

No laborer, workman or mechanic shall be paid at a rate less than that of a Journeyman except those classified as bona fide apprentices.

Apprentices or trainees shall be permitted to work as such subject to Administrative Regulations adopted by the Commissioner of Workplace Standards. Copies of these regulations will be furnished upon request from any interested person.

Before using apprentices on the job the contractor shall present to the Contracting Officer written evidence of registration of such employees in a program of a State apprenticeship and training agency approved and recognized by the U. S. Bureau of Apprenticeship and Training. In the absence of such a State agency, the contractor shall submit evidence of approval and registration by the U. S. Bureau of Apprenticeship and Training.

The contractor shall submit to the Contracting Officer, written evidence of the established apprenticeship-journeyman ratios and wage rates in the project area, which will be the basis for establishing such ratios and rates for the project under the applicable contract provisions.

TO: EMPLOYERS/EMPLOYEES

PREVAILING WAGE SCHEDULE:

The wages indicated on this wage schedule are the least permitted to be paid for the occupations indicated. When an employee works in more than one classification, the employer must record the number of hours worked in each classification at the prescribed hourly base rate.

OVERTIME:

Overtime is to be paid after an employee works eight (8) hours a day or forty (40) hours a week, whichever gives the employee the greater wages. At least time and one-half the base rate is required for all overtime. A laborer, workman or mechanic and an employer may enter into a written agreement or a collective bargaining agreement to work more than eight (8) hours a calendar day but not more than ten (10) hours a calendar day for the straight time hourly rate. Wage violations or questions should be directed to the designated Engineer or the undersigned.

Director
Division of Construction Procurement
Frankfort, Kentucky 40622
502-564-3500

**NOTICE OF REQUIREMENT FOR AFFIRMATIVE ACTION
TO ENSURE EQUAL EMPLOYMENT OPPORTUNITY
(Executive Order 11246)**

1. The Offeror's or Bidder's attention is called to the "Equal Opportunity Clause" and the "Standard Federal Equal Employment Specifications" set forth herein.
2. The goals and timetables for minority and female participation, expressed in percentage terms for the Contractor's aggregate work force in each trade on all construction work in the covered area, are as follows:

GOALS FOR MINORITY PARTICIPATION IN EACH TRADE	GOALS FOR FEMALE PARTICIPATION IN EACH TRADE
11.2%	6.9%

These goals are applicable to all the Contractor's construction work (whether or not it is Federal or federally-assisted) performed in the covered area. If the contractor performs construction work in a geographical area located outside of the covered area, it shall apply the goals established for such geographical area where the work is actually performed. With regard to this second area, the contractor also is subject to the goals for both its federally involved and non-federally involved construction.

The Contractor's compliance with the Executive Order and the regulations in CFR Part 60-4 shall be based on its implementation of the Equal Opportunity Clause, specific affirmative action obligations required by the specifications set forth in 41 CFR 60-4, 3(a), and its efforts to meet the goals. The hours of minority and female employment and training must be substantially uniform throughout the length of the contract, and in each trade, and the contractor shall make a good faith effort to employ minorities and women evenly on each of its projects. The transfer of minority or female employees or trainees from Contractor to Contractor or from project to project for the sole purpose of meeting the Contractor's goals shall be a violation of the contract, the Executive Order and the regulations in 41 CFR Part 60-4. Compliance with the goals will be measured against the total work hours performed.

3. The Contractor shall provide written notification to the Director of the Office of Federal Contract Compliance Programs within ten (10) working days of award of any construction subcontract in excess of \$10,000.00 at any tier for construction work under the contract resulting from this solicitation. The notification shall list the name, address and telephone number of the subcontractor; employer identification number of the subcontractor; estimated dollar amount of the subcontract; estimated starting and completion dates of the subcontract; and the geographical area in which the subcontract is to be performed. The notification shall be mailed to:

**Evelyn Teague, Regional Director
Office of Federal Contract Compliance Programs
61 Forsyth Street, SW, Suite 7B75
Atlanta, Georgia 30303-8609**

4. As used in this Notice, and in the contract resulting from this solicitation, the "**covered area**" is Jefferson County.

PART IV
INSURANCE

INSURANCE

The Contractor shall procure and maintain the following insurance in addition to the insurance required by law:

- 1) Commercial General Liability-Occurrence form – not less than \$2,000,000 General aggregate, \$2,000,000 Products & Completed Aggregate, \$1,000,000 Personal & Advertising, \$1,000,000 each occurrence.
- 2) Automobile Liability- \$1,000,000 per accident
- 3) Employers Liability:
 - a) \$100,000 Each Accident Bodily Injury
 - b) \$500,000 Policy limit Bodily Injury by Disease
 - c) \$100,000 Each Employee Bodily Injury by Disease
- 4) The insurance required above must be evidenced by a Certificate of Insurance and this Certificate of Insurance must contain one of the following statements:
 - a) "policy contains no deductible clauses."
 - b) "policy contains _____ (amount) deductible property damage clause but company will pay claim and collect the deductible from the insured."
- 5) **KENTUCKY WORKMEN'S COMPENSATION INSURANCE.** The contractor shall furnish evidence of coverage of all his employees or give evidence of self-insurance by submitting a copy of a certificate issued by the Workmen's Compensation Board.

The cost of insurance is incidental to all contract items. All subcontractors must meet the same minimum insurance requirements.

PART V
BID ITEMS

PROPOSAL BID ITEMS

172612

Page 1 of 1

Report Date 9/6/17

Section: 0001 - BRIDGE

LINE	BID CODE	ALT	DESCRIPTION	QUANTITY	UNIT	UNIT PRIC	FP	AMOUNT
0010	02003		RELOCATE TEMP CONC BARRIER	400.00	LF		\$	
0020	02403		REMOVE CONCRETE MASONRY	2.85	CUYD		\$	
0030	02562		TEMPORARY SIGNS	149.00	SQFT		\$	
0040	02650		MAINTAIN & CONTROL TRAFFIC APPLIES TO 056B00278N	1.00	LS		\$	
0050	02653		LANE CLOSURE	3.00	EACH		\$	
0060	02671		PORTABLE CHANGEABLE MESSAGE SIGN	1.00	EACH		\$	
0070	02775		ARROW PANEL	1.00	EACH		\$	
0080	02898		RELOCATE CRASH CUSHION	1.00	EACH		\$	
0090	02900		INSTALL TEMP CRASH CUSHION	1.00	EACH		\$	
0100	03171		CONCRETE BARRIER WALL TYPE 9T	400.00	LF		\$	
0110	03295		EXPAN JOINT REPLACE 2 IN	108.70	LF		\$	
0120	03299		ARMORED EDGE FOR CONCRETE	108.70	LF		\$	
0130	03300		ELIMINATE TRANSVERSE JOINT	108.70	LF		\$	
0140	03304		BRIDGE OVERLAY APPROACH PAVEMENT	155.56	SQYD		\$	
0150	06514		PAVE STRIPING-PERM PAINT-4 IN	738.00	LF		\$	
0160	06549		PAVE STRIPING-TEMP REM TAPE-B	500.00	LF		\$	
0170	06550		PAVE STRIPING-TEMP REM TAPE-W	2,000.00	LF		\$	
0180	06551		PAVE STRIPING-TEMP REM TAPE-Y	2,000.00	LF		\$	
0190	08150		STEEL REINFORCEMENT	855.40	LB		\$	
0200	08435		JACK & SUPPORT BRIDGE SPAN	1.00	LS		\$	
0210	08504		EPOXY SAND SLURRY	160.00	SQYD		\$	
0220	08510		REM EPOXY BIT FOREIGN OVERLAY	672.00	SQYD		\$	
0230	08526		CONC CLASS M FULL DEPTH PATCH	5.00	CUYD		\$	
0240	08534		CONCRETE OVERLAY-LATEX	28.00	CUYD		\$	
0250	08549		BLAST CLEANING	832.00	SQYD		\$	
0260	21969NN		BEARING REPLACEMENT	2.00	EACH		\$	
0270	24094EC		PARTIAL DEPTH PATCHING	19.00	CUYD		\$	
0280	24134EC		CONC CLASS A-FIBER REINFORCED	3.12	CUYD		\$	

Section: 0002 - DEMOBILIZATION

LINE	BID CODE	ALT	DESCRIPTION	QUANTITY	UNIT	UNIT PRIC	FP	AMOUNT
0290	02569		DEMOBILIZATION	1.00	LS		\$	