

TYPICAL SUBGRADE DRAINAGE LOCATIONS

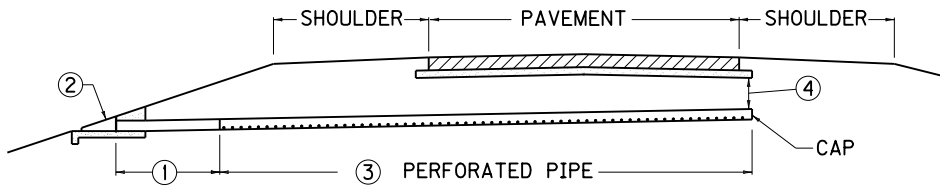

TANGENT SECTION - TWO LANE

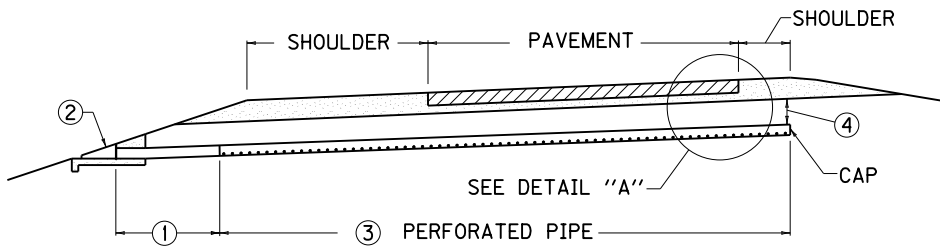

TANGENT SECTION - MULTI LANE

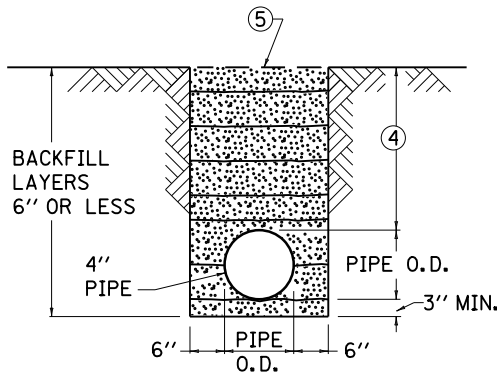

TRENCH DETAIL

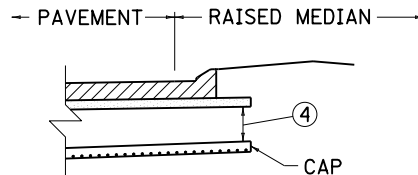

RAISED MEDIAN  
DETAIL "A"

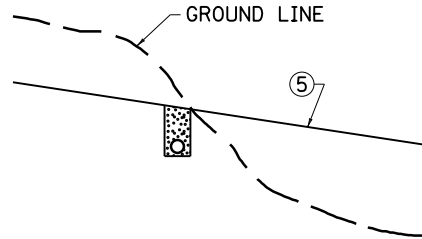

CUT TO FILL

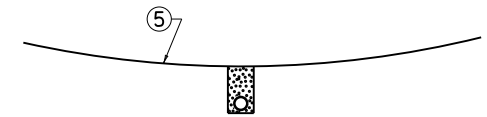

SAG VERTICAL CURVES

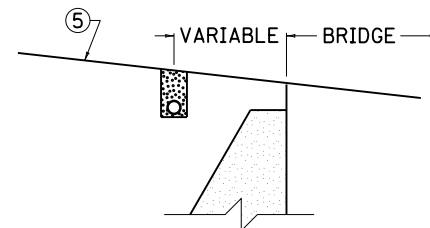

SUBGRADE DRAINAGE SHALL BE INSTALLED AT UPGRADE END OF BRIDGE ONLY.

BRIDGES

NOTES

SUBGRADE DRAINAGE, AS DEPICTED, IS INTENDED FOR USE WITH THE SURFACING PHASE OF CONSTRUCTION, AND SHALL BE INSTALLED ONLY AFTER THE SUBGRADE HAS BEEN COMPLETED, AND PRIOR TO CONSTRUCTING PAVING MATERIALS.

SUBGRADE DRAINAGE WILL NOT BE REQUIRED WHEN:  
 a. ROCK SUBGRADE OR NATURAL BANK GRAVEL IS SPECIFIED.  
 b. POROUS OR FREE DRAINING SUBGRADES ARE EVIDENT.  
 c. DIRECTED BY THE ENGINEER.

THE CAP SHALL BE A STANDARD MANUFACTURED ITEM FURNISHED BY PIPE SUPPLIER.

- ① APPROXIMATELY 8 TO 12 FEET OF PIPE AT THE OUTLET SHALL BE NON-PERFORATED PIPE MEETING THE REQUIREMENTS OF THE PERFORATED PIPE, EXCEPT FOR PERFORATIONS.
- ② PERFORATED PIPE HEADWALL REQUIRED AT OUTLET. SEE CUR. STD. DWG. RDP-O10.
- ③ SEE CURRENT STANDARD DRAWING RDP-001 FOR ALTERNATES.
- ④ PIPE COVER: 2'-0" DESIREABLE MINIMUM, 1'-0" ABSOLUTE MINIMUM.  
FLOW SHALL BE DIRECTED TOWARD THE FILL SIDE OF THE ROADWAY WHEN POSSIBLE.
- ⑤ SUBGRADE ELEVATION.

USE WITH CUR. STD. DWGS. RDP-001 AND RDP-O10

KENTUCKY DEPARTMENT OF HIGHWAYS	
PERFORATED PIPE FOR SUBGRADE DRAINAGE ON TWO-LANE (CLASS 2) AND MULTI-LANE ROADS	
STANDARD DRAWING NO. RDP-005-04	
SUBMITTED: <i>John B. Sackett</i> DIRECTOR, DIVISION OF DESIGN	12-1-99 DATE
APPROVED: <i>J. M. [Signature]</i> STATE HIGHWAY ENGINEER	12-1-99 DATE