



**CALL NO. 402**

**CONTRACT ID. 242155**

**ESTILL COUNTY**

**FED/STATE PROJECT NUMBER 033GR24P020-FD05**

**DESCRIPTION RIVER DRIVE (KY 52)**

**WORK TYPE ASPHALT RESURFACING**

**PRIMARY COMPLETION DATE 11/15/2024**

**LETTING DATE: April 25,2024**

Sealed Bids will be received electronically through the Bid Express bidding service until 10:00 AM EASTERN DAYLIGHT TIME April 25,2024. Bids will be publicly announced at 10:00 AM EASTERN DAYLIGHT TIME.

**NO PLANS ASSOCIATED WITH THIS PROJECT.**

**DEFERRED PAYMENT**

**REQUIRED BID PROPOSAL GUARANTY:** Not less than 5% of the total bid.

## TABLE OF CONTENTS

PART I	SCOPE OF WORK
	<ul style="list-style-type: none"><li>• PROJECT(S), COMPLETION DATE(S), &amp; LIQUIDATED DAMAGES</li><li>• CONTRACT NOTES</li><li>• STATE CONTRACT NOTES</li><li>• DEFERRED PAYMENT</li><li>• SURFACING AREAS</li><li>• ASPHALT MIXTURE</li><li>• INCIDENTAL SURFACING</li><li>• FUEL AND ASPHALT PAY ADJUSTMENT</li><li>• COMPACTION OPTION A</li><li>• COMPACTION OPTION B</li><li>• AWARD OF CONTRACT</li><li>• NON-TRACKING TACK COAT</li><li>• ELECTRONIC DELIVERY MANAGEMENT SYSTEM (E-TICKETING)</li><li>• EXPERIMENTAL KYCT AND HAMBURG TESTING</li><li>• ASPHALT MIXTURE FOR PAVEMENT WEDGE</li><li>• ASPHALT MIX PAVEMENT WEDGE MONOLITHIC OPERATION</li><li>• EDGE KEY (BY TON)</li><li>• ASPHALT MILLING AND TEXTURING</li><li>• BASE FAILURE REPAIR</li><li>• TYPICAL SECTION DIMENSIONS</li><li>• TRAFFIC CONTROL PLAN 4 LANE</li><li>• DURABLE PAVEMENT EDGE DETAILS</li><li>• INSTALL RADAR PRESENCE DETECTOR TYPE A</li><li>• SKETCH MAP(S)</li><li>• MATERIAL SUMMARY</li><li>• SUMMARY SHEET(S)</li><li>• TYPICAL SECTION(S)</li><li>• DETAIL SHEET(S)</li><li>• BRIDGE DETAIL FOR PAVING PROJECT</li></ul>
PART II	SPECIFICATIONS AND STANDARD DRAWINGS
	<ul style="list-style-type: none"><li>• STANDARD AND SUPPLEMENTAL SPECIFICATIONS</li><li>• [SN-1I] PORTABLE CHANGEABLE SIGNS</li><li>• 2020 STANDARD DRAWINGS THAT APPLY</li></ul>
PART III	EMPLOYMENT, WAGE AND RECORD REQUIREMENTS
	<ul style="list-style-type: none"><li>• LABOR AND WAGE REQUIREMENTS</li><li>• EXECUTIVE BRANCH CODE OF ETHICS</li><li>• KENTUCKY EQUAL EMPLOYMENT OPPORTUNITY ACT OF 1978 LOCALITY / STATE</li><li>• PROJECT WAGE RATES / STATE FUNDED</li></ul>
PART IV	INSURANCE
PART V	BID ITEMS

**PART I**  
**SCOPE OF WORK**

## ADMINISTRATIVE DISTRICT - 10

**CONTRACT ID - 242155**

**033GR24P020-FD05**

**COUNTY - ESTILL**

**PCN - MP03300522401**

**FD05 033 0052 007-010**

RIVER DRIVE (KY 52) (MP 7.550) FROM EAST END OF KY RIVER BRIDGE, EXTENDING EAST TO KY 1571 (MP 9.480), A DISTANCE OF 01.93 MILES.ASPHALT RESURFACING

GEOGRAPHIC COORDINATES LATITUDE 37:41:27.12 LONGITUDE 83:57:49.46

ADT 6,439

**PCN - MP03315712401**

**FD05 033 1571 000-006**

RIVER ROAD (KY 1571) (MP 0.000) FROM KY 52, EXTENDING EAST TO KY 52 (MP 5.580), A DISTANCE OF 05.58 MILES.ASPHALT RESURFACING

GEOGRAPHIC COORDINATES LATITUDE 37:40:32.62 LONGITUDE 83:54:19.01

ADT 1,287

**COMPLETION DATE(S):**

COMPLETED BY 11/15/2024

APPLIES TO ENTIRE CONTRACT

## **CONTRACT NOTES**

### **PROPOSAL ADDENDA**

All addenda to this proposal must be applied when calculating bid and certified in the bid packet submitted to the Kentucky Department of Highways. Failure to use the correct and most recent addenda may result in the bid being rejected.

### **BID SUBMITTAL**

Bidder must use the Department's electronic bidding software. The Bidder must download the bid file located on the Bid Express website ([www.bidx.com](http://www.bidx.com)) to prepare a bid packet for submission to the Department. The bidder must submit electronically using Bid Express.

### **JOINT VENTURE BIDDING**

Joint venture bidding is permissible. All companies in the joint venture must be prequalified in one of the work types in the Qualifications for Bidders for the project. The bidders must get a vendor ID for the joint venture from the Division of Construction Procurement and register the joint venture as a bidder on the project. Also, the joint venture must obtain a digital ID from Bid Express to submit a bid. A joint bid bond of 5% may be submitted for both companies or each company may submit a separate bond of 5%.

### **UNDERGROUND FACILITY DAMAGE PROTECTION**

The contractor shall make every effort to protect underground facilities from damage as prescribed in the Underground Facility Damage Protection Act of 1994, Kentucky Revised Statute KRS 367.4901 to 367.4917. It is the contractor's responsibility to determine and take steps necessary to be in compliance with federal and state damage prevention directives. When prescribed in said directives, the contractor shall submit Excavation Locate Requests to the Kentucky Contact Center (KY811) via web ticket entry. The submission of this request does not relieve the contractor from the responsibility of contacting non-member facility owners, whom shall be contacted through their individual Protection Notification Center. Non-compliance with these directives can result in the enforcement of penalties.

### **REGISTRATION WITH THE SECRETARY OF STATE BY A FOREIGN ENTITY**

Pursuant to KRS 176.085(1)(b), an agency, department, office, or political subdivision of the Commonwealth of Kentucky shall not award a state contract to a person that is a foreign entity required by [KRS 14A.9-010](#) to obtain a certificate of authority to transact business in the Commonwealth ("certificate") from the Secretary of State under [KRS 14A.9-030](#) unless the person produces the certificate within fourteen (14) days of the bid or proposal opening. If the foreign entity is not required to obtain a certificate as provided in [KRS 14A.9-010](#), the foreign entity should identify the applicable exception. Foreign entity is defined within [KRS 14A.1-070](#).

**For all foreign entities required to obtain a certificate of authority to transact business in the Commonwealth, if a copy of the certificate is not received by the contracting agency within the time frame identified above, the foreign entity's solicitation response shall be deemed non-responsive or the awarded contract shall be cancelled.**

Businesses can register with the Secretary of State at <https://secure.kentucky.gov/sos/ftbr/welcome.aspx>.

### **SPECIAL NOTE FOR PROJECT QUESTIONS DURING ADVERTISEMENT**

Questions about projects during the advertisement should be submitted in writing to the Division of Construction Procurement. This may be done by email to [kytc.projectquestions@ky.gov](mailto:kytc.projectquestions@ky.gov). The Department will attempt to answer all submitted questions. The Department reserves the right not to answer if the question is not pertinent or does not aid in clarifying the project intent.

The deadline for posting answers will be 3:00 pm Eastern Daylight Time, the day preceding the Letting. Questions may be submitted until this deadline with the understanding that the later a question is submitted, the less likely an answer will be able to be provided.

The questions and answers will be posted for each Letting under the heading "Questions & Answers" on the Construction Procurement website ([www.transportation.ky.gov/construction-procurement](http://www.transportation.ky.gov/construction-procurement)). The answers provided shall be considered part of this Special Note and, in case of a discrepancy, will govern over all other bidding documents.

### **HARDWOOD REMOVAL RESTRICTIONS**

The US Department of Agriculture has imposed a quarantine in Kentucky and several surrounding states, to prevent the spread of an invasive insect, the emerald ash borer. Hardwood cut in conjunction with the project may not be removed from the state. Chipping or burning on site is the preferred method of disposal.

### **INSTRUCTIONS FOR EXCESS MATERIAL SITES AND BORROW SITES**

Identification of excess material sites and borrow sites shall be the responsibility of the Contractor. The Contractor shall be responsible for compliance with all applicable state and federal laws and may wish to consult with the US Fish and Wildlife Service to seek protection under Section 10 of the Endangered Species Act for these activities.

### **ACCESS TO RECORDS**

The contractor, as defined in KRS 45A.030 (9) agrees that the contracting agency, the Finance and Administration Cabinet, the Auditor of Public Accounts, and the Legislative Research Commission, or their duly authorized representatives, shall have access to any books, documents, papers, records, or other evidence, which are directly pertinent to this contract for the purpose of financial audit or program review. Records and other prequalification information confidentially disclosed as part of the bid process shall not be deemed as directly pertinent to the contract and

shall be exempt from disclosure as provided in KRS 61.878(1)(c). The contractor also recognizes that any books, documents, papers, records, or other evidence, received during a financial audit or program review shall be subject to the Kentucky Open Records Act, KRS 61.870 to 61.884.

In the event of a dispute between the contractor and the contracting agency, Attorney General, or the Auditor of Public Accounts over documents that are eligible for production and review, the Finance and Administration Cabinet shall review the dispute and issue a determination, in accordance with Secretary's Order 11-004.

### **BOYCOTT PROVISIONS**

If applicable, the contractor represents that, pursuant to [KRS 45A.607](#), they are not currently engaged in, and will not for the duration of the contract engage in, the boycott of a person or an entity based in or doing business with a jurisdiction with which Kentucky can enjoy open trade.

**Note:** The term Boycott does not include actions taken for bona fide business or economic reasons, or actions specifically required by federal or state law.

If applicable, the contractor verifies that, pursuant to KRS 41.480, they do not engage in, and will not for the duration of the contract engage in, in energy company boycotts as defined by KRS 41.472.

### **LOBBYING PROHIBITIONS**

The contractor represents that they, and any subcontractor performing work under the contract, have not violated the agency restrictions contained in [KRS 11A.236](#) during the previous ten (10) years, and pledges to abide by the restrictions set forth in such statute for the duration of the contract awarded.

The contractor further represents that, pursuant to [KRS 45A.328](#), they have not procured an original, subsequent, or similar contract while employing an executive agency lobbyist who was convicted of a crime related to the original, subsequent, or similar contract within five (5) years of the conviction of the lobbyist.

## **1.0 BUY AMERICA REQUIREMENT.**

Follow the “Buy America” provisions as required by 23 U.S.C. § 313 and 23 C.F.R. § 635.410. Except as expressly provided herein all manufacturing processes of steel or iron materials including but not limited to structural steel, guardrail materials, corrugated steel, culvert pipe, structural plate, prestressing strands, and steel reinforcing bars shall occur in the United States of America, including the application of:

- Coating,
- Galvanizing,
- Painting, and
- Other coating that protects or enhances the value of steel or iron products.

The following are exempt, unless processed or refined to include substantial amounts of steel or iron material, and may be used regardless of source in the domestic manufacturing process for steel or iron material:

- Pig iron,
- Processed, pelletized, and reduced iron ore material, or
- Processed alloys.

The Contractor shall submit a certification stating that all manufacturing processes involved with the production of steel or iron materials occurred in the United States.

Produce, mill, fabricate, and manufacture in the United States of America all aluminum components of bridges, tunnels, and large sign support systems, for which either shop fabrication, shop inspection, or certified mill test reports are required as the basis of acceptance by the Department.

Use foreign materials only under the following conditions:

- 1) When the materials are not permanently incorporated into the project; or
- 2) When the delivered cost of such materials used does not exceed 0.1 percent of the total Contract amount or \$2,500.00, whichever is greater.

The Contractor shall submit to the Engineer the origin and value of any foreign material used.

## **2.0 – BUILD AMERICA, BUY AMERICA (BABA)**

Contractor shall comply with the Federal Highway Administration (FHWA) Buy America Requirement in 23 C.F.R. § 635.410 and all relevant provisions of the Build America, Buy America Act (BABA), contained within the Infrastructure Investment and Jobs Act, Pub. L. No. 117-58, §§ 70901-52 enacted November 15, 2021. The BABA requires iron, steel, manufactured products, and construction materials used in infrastructure projects funded by federal financial assistance to be produced in the United States. Comply with 2 C.F.R § 184.

BABA permits FHWA participation in the Contract only if domestic steel and iron will be used on the Project. To be considered domestic, all steel and iron used, and all products manufactured from steel and iron must be produced in the United States and all manufacturing processes, including application of a coating, for these materials must occur in the United States. Coating includes all processes that protect or enhance the value of the material to which the coating is applied. This requirement does not preclude a minimal use of foreign steel and iron materials, provided the cost of such materials does not exceed 0.1% of the total contract amount under the Contract or \$2,500.00 whichever is greater.

BABA permits FHWA participation in the Contract only if all “construction materials” as defined in the Act are made in the United States. The Buy America preference applies to the following construction materials



incorporated into infrastructure projects: non-ferrous metals; plastic and polymer-based products (including polyvinylchloride, composite building materials, and polymers used in fiber optic cables); glass (including optic glass); Fiber optic cable; optical fiber; lumber; engineered wood; and drywall. Contractor will be required to use construction materials produced in the United States on this Project. The Contractor shall submit a certification stating that all construction materials are certified to be BABA compliant.

Finally, BABA permits the continuation of FHWA's current general applicability waivers for manufactured products, raw materials, and ferryboat parts, but these waivers are subject to reevaluation, specifically the general applicability waiver for manufactured products.

The Contractor has completed and submitted, or shall complete and submit, to the Cabinet a Buy America/Build America, Buy America Certificate prior to the Cabinet issuing the notice to proceed, in the format below. After submittal, the Contractor is bound by its original certification.

A false certification is a criminal act in violation of 18 U.S.C. § 1001. The Contractor has the burden of proof to establish that it is in compliance.

At the Contractor's request, the Cabinet may, but is not obligated to, seek a waiver of Buy America requirements if grounds for the waiver exist under 23 C.F.R. § 635.410(c) or will comply with the applicable Buy America requirements if a waiver of those requirements is not available or not pursued by the Cabinet.

Please refer to the Federal Highway Administration's Buy America webpage for more information.

[Buy America - Construction Program Guide - Contract Administration - Construction - Federal Highway Administration \(dot.gov\)](#)

October 26, 2023 Letting

SPECIAL NOTE – BUY AMERICA REQUIREMENTS AND BUILD AMERICA, BUY AMERICA (BABA) ACT

10/26/2023

**BUY AMERICA / BUILD AMERICA, BUY AMERICA (ACT) MATERIALS CERTIFICATE OF COMPLIANCE**

The Contractor hereby certifies that it will comply with all relevant provisions of the Build America, Buy America Act, contained within the Infrastructure Investment and Jobs Act, Pub. L. NO. 117-58, §§ 70901-52, the requirements of 23 U.S.C. § 313, 23 C.F.R. § 635.410 and 2 C.F.R § 184.

Date Submitted: \_\_\_\_\_

Contractor: \_\_\_\_\_

Signature: \_\_\_\_\_

Printed Name: \_\_\_\_\_

Title: \_\_\_\_\_

**NOTE: THIS CERTIFICATION IS IN ADDITION TO ANY AND ALL REQUIREMENTS OUTLINED IN THE CURRENT EDITION OF THE STANDARD SPECIFICATIONS FOR ROAD AND BRIDGE CONSTRUCTION AND/OR SPECIAL NOTES CONTAINED IN THE PROJECT PROPOSAL.**

## **SPECIAL NOTE FOR RECIPROCAL PREFERENCE**

### **RECIPROCAL PREFERENCE TO BE GIVEN BY PUBLIC AGENCIES TO RESIDENT BIDDERS**

By reference, KRS 45A.490 to 45A.494 are incorporated herein and in compliance regarding the bidders residency. Bidders who want to claim resident bidder status should complete the Affidavit for Claiming Resident Bidder Status along with their bid in the electronic bidding software. Submittal of the Affidavit should be done along the bid in Bid Express.

April 30, 2018

### **DEFERRED PAYMENT**

The successful bidder on this project has the distinct understanding that payment for any work may be delayed until July 15, 2024. Work Order/Notice to Proceed will be issued in accordance the Standard Specifications for Road and Bridge Construction, current edition.

### **FD05 033 0052 007-010**

#### **SURFACING AREAS**

The Department estimates the mainline surfacing width to be varied 24-36 feet.

The Department estimates the total mainline area to be surfaced to be 42,058 square yards.

The Department estimates the shoulder width to be varied 0-10 feet on each side.

The Department estimates the total shoulder area to be surfaced to be 4,987 square yards.

FD05 033 1571 000-006

#### **SURFACING AREAS**

The Department estimates the mainline surfacing width to be 20 feet.

The Department estimates the total mainline area to be surfaced to be 72,020 square yards.

The Department estimates the shoulder width to be 1 foot on each side.

The Department estimates the total shoulder area to be surfaced to be 6,548 square yards.

### **ASPHALT MIXTURE**

Unless otherwise noted, the Department estimates the rate of application for all asphalt mixtures to be 110 lbs/sy per inch of depth.

### **INCIDENTAL SURFACING**

The Department has included in the quantities of asphalt mixtures established in the proposal estimated quantities required for resurfacing or surfacing mailbox turnouts, farm field entrances, residential and commercial entrances, curve widening, ramp gores and tapers, and road and street approaches, as applicable. Pave these areas to the limits as shown on Standard Drawing RPM-110-06 or as directed by the Engineer. In the event signal detectors are present in the intersecting streets or roads, pave the crossroads to the right of way limit or back of the signal detector, whichever is the farthest back of the mainline. Surface or resurface these areas as directed by the Engineer. The Department will not measure placing and compacting for separate payment but shall be incidental to the Contract unit price for the asphalt mixtures.

### **FUEL AND ASPHALT PAY ADJUSTMENT**

The Department has included the Contract items Asphalt Adjustment and Fuel Adjustment for possible future payments at an established Contract unit price of \$1.00. The Department will calculate actual adjustment quantities after work is completed. If existing Contract amount is insufficient to pay all items on the contract with the adjustments, the Department will establish additional monies with a change order.

### **FD05 033 0052 007-010**

#### **OPTION A**

Be advised that the Department will accept compaction of asphalt mixtures furnished for driving lanes and ramps, at 1 inch (25mm) or greater, on this project according to OPTION A in accordance with Section 402 and Section 403 of the current Standard Specifications. The Department will require joint cores as described in Section 402.03.02 for surface mixtures only. The Department will accept compaction of all other asphalt mixtures according to OPTION B.

### **FD05 033 1571 000-006**

**OPTION B**

Be advised that the Department will control and accept compaction of asphalt mixtures furnished on this project under OPTION B in accordance with Sections 402 and 403.

### **SPECIAL NOTE FOR AWARD OF CONTRACT**

Contrary to Section 103.02, the Department may hold the Bid Proposals of any or all bidders for a period not to exceed 90 calendar days for final disposition of award. The Department may hold the Bid Proposal of the lowest bidder longer than 90 calendar days if the bidder concurs.

Contrary to Section 103.04, The Department will hold the Proposal Guaranty of the lowest bidder and the Proposal Guaranty of the second lowest bidder, as determined by the Commissioner, until the Department awards the Contract and executes and approves the Contract and bond of the successful bidder, or until the Department rejects all Bid Proposals. If the Department does not make an award within 90 calendar days, the Department will return all Proposal Guaranties.

Except as provided in this note or elsewhere in the proposal, the Department will apply all other applicable portions of Section 103.

1-3002 Award of Contract  
01/02/2012

### SPECIAL NOTE FOR NON-TRACKING TACK COAT

1. DESCRIPTION AND USEAGE. This specification covers the requirements and practices for applying a non-tracking tack asphalt coating. Place this material on the existing pavement course, prior to placement of a new asphalt pavement layer. Use when expedited paving is necessary or when asphalt tracking would negatively impact the surrounding area. This material is not suitable for other uses. Ensure material can “break” within 15 minutes under conditions listed in 3.2.

2. MATERIALS, EQUIPMENT, AND PERSONNEL.

2.1 Non-Tracking Tack. Provide material conforming to Subsection 2.1.1.

2.1.1 Provide a tack conforming to the following material requirements:

Property	Specification	Test Procedure
Viscosity, SFS, 77 ° F	20 – 100	AASHTO T 72
Sieve, %	0.3 max.	AASHTO T 59
Asphalt Residue <sup>1</sup> , %	50 min.	AASHTO T 59
Oil Distillate, %	1.0 max.	AASHTO T 59
Residue Penetration, 77 ° F	0 - 30	AASHTO T 49
Original Dynamic Shear (G*/sin δ), 82 ° C	1.0 min.	AASHTO T 315
Softening Point, ° F	149 min.	AASHTO T 53
Solubility, %	97.5 min.	AASHTO T 44

<sup>1</sup> Bring sample to 212 °F over a 10-15 minute period. Maintain 212 °F for 15-20 minutes or until 30-40 mL of water has distilled. Continue distillation as specified in T59.

2.2. Equipment. Provide a distributor truck capable of heating, circulating, and spraying the tack between 170 °F and 180 °F. Do not exceed 180 °F. Circulate the material while heating. Provide the correct nozzles that is recommend by the producer to ensure proper coverage of tack is obtained. Ensure the bar can be raised to between 14” and 18” from the roadway.

2.3. Personnel. Ensure the tack supplier has provided training to the contractor on the installation procedures for this product. Make a technical representative from the supplier available at the request of the Engineer.

3. CONSTRUCTION.

3.1 Surface Preparation. Prior to the application of the non-tracking tack, ensure the pavement surface is thoroughly dry and free from dust or any other debris that would inhibit adhesion. Clean the surface by scraping, sweeping, and the use of compressed air. Ensure this preparation process occurs shortly before application to prevent the return of debris on to the pavement. If rain is expected within one hour after application, do not apply material. Apply material only when the surface is dry, and no precipitation is expected.

- 3.2 Non-tracking Tack Application. Placement of non-tracking tack is not permitted from October 1<sup>st</sup> to May 15<sup>th</sup>. When applying material, ensure the roadway temperature is a minimum of 40°F and rising. Prior to application, demonstrate competence in applying the tack according to this note to the satisfaction of the Engineer. Heat the tack in the distributor to between 170 – 180 °F. After the initial heating, between 170 – 180 °F, the material may be sprayed between 165 °F and 180 °F. Do not apply outside this temperature range. Apply material at a minimum rate of 0.70 pounds (0.08 gallons) per square yard. Ensure full coverage of the material on the pavement surface. Full coverage of this material is critical. Increase material application rate if needed to achieve full coverage. Schedule the work so that, at the end of the day's production, all non-tracking tack is covered with the asphalt mixture. If for some reason the non-tracking tack cannot be covered by an asphalt mixture, ensure the non-tracking tack material is clean and reapply the non-tracking tack prior to placing the asphalt mixture. Do not heat material more than twice in one day.
- 3.3 Non-tracking Tack Certification. Furnish the tack certification to the Engineer stating the material conforms to all requirements herein prior to use.
- 3.4 Sampling and Testing. The Department will require a sample of non-tracking tack be taken from the distributor at a rate of one sample per 15,000 tons of mix. Take two 1 gallon samples of the heated material and forward the sample to the Division of Materials for testing within 7 days. Ensure the product temperature is between 170 and 180 °F at the time of sampling.
4. MEASUREMENT. The Department will measure the quantity of non-tracking tack in tons. The Department will not measure for payment any extra materials, labor, methods, equipment, or construction techniques used to satisfy the requirements of this note. The Department will not measure for payment any trial applications of non-tracking tack, the cleaning of the pavement surface, or furnishing and placing the non-tracking tack. The Department will consider all such items incidental to the non-tracking tack.
5. PAYMENT. The Department will pay for the non-tracking tack at the Contract unit bid price and apply an adjustment for each manufacturer's lot of material based on the degree of compliance as defined in the following schedule. Non-tracking tack will not be permitted for use from October 1<sup>st</sup> to May 15<sup>th</sup>. During this timeframe, the department will allow the use of an approved asphalt emulsion in lieu of a non-tracking tack product but will not adjust the unit bid price of the material. When a sample fails on two or more tests, the Department may add the deductions, but the total deduction will not exceed 100 percent.



Non-Tracking Tack Price Adjustment Schedule						
Test	Specification	100% Pay	90% Pay	80% Pay	50% Pay	0% Pay
Viscosity, SFS, 77 ° F	20 – 100	19 - 102	17 - 18	15 - 16	14	≤13
			103 - 105	106 - 107	108 - 109	≥ 110
Sieve, %	0.30 max.	≤ 0.40	0.41 - 0.50	0.51 - 0.60	0.61 - 0.70	≥ 0.71
Asphalt Residue, %	50 min.	≥49.0	48.5 – 48.9	48.0 – 48.4	47.5-47.9	≤ 47.4
Oil Distillate, %	1.0 max.	≤1.0	1.1-1.5	1.6 - 1.7	1.8-1.9	>2.0
Residue Penetration, 77 ° F.	30 max.	≤ 31	32 - 33	34 - 35	36 - 37	≥ 38
Original Dynamic Shear (G*/sin δ), 82 ° C	1.0 min.	≥0.95	0.92 – 0.94	0.90 – 0.91	0.85 - 0.89	≤ 0.84
Softening Point, ° F	149 min.	≥145	142 - 144	140 - 141	138 - 139	≤ 137
Solubility, %	97.5 min.	≥ 97.0	96.8 – 96.9	96.6 – 96.7	96.4 – 96.5	≤ 96.3

<u>Code</u>	<u>Pay Item</u>	<u>Pay Unit</u>
24970EC	Asphalt Material for Tack Non-Tracking	Ton

Revised: May 23, 2022

### **SPECIAL NOTE FOR ELECTRONIC DELIVERY MANAGEMENT SYSTEM (e-Ticketing)**

This Special Note will apply when indicated on the plans or in the proposal. Section references herein are to the Department's Standard Specifications for Road and Bridge Construction current edition.

**1.0 DESCRIPTION.** Incorporate an e-Ticketing Delivery Software for weighed asphalt material delivered to the project to report loads and provide daily running totals of weighed asphalt material for pay items and incidental work during the construction processes from the point of measurement and loading to the point of incorporation to the project.

**2.0 MATERIALS AND EQUIPMENT.** Contractor shall supply material data in JavaScript Object Notation (JSON) documents to the KYTC e-Ticketing Delivery Software (KYTC e-Ticketing Portal) via Application Programming Interface (API) or direct connection. Test and verify that ticket data can be shared from the original source no fewer than 30 days prior to material placement activities. An e-Ticketing Delivery Software supplier can provide a qualified representative for on-site technical assistance during the initial setup, pre-construction verifications, and data management and processing as needed during the Project to maintain material data delivery capabilities. Virtual meetings may be hosted in lieu of on-site meetings when deemed appropriate by the Engineer.

Provide e-Ticketing Delivery Software that will meet the following:

1. The e-Ticketing Delivery Software shall be fully integrated with the Contractor's Load Read-Out scale system at the material source location.
2. The e-Ticketing Delivery Software shall provide real-time delivery to KYTC e-Ticketing Portal.
3. Transmit any updates to the ticket data within 5 minutes of a change.

**3.0 CONSTRUCTION.** Provide the Engineer with the manufacturer's specifications and all required documentation for data access at the pre-construction conference.

**A. Construction Requirements**

1. Install and operate software in accordance with the manufacturer's specifications.
2. Verify that all pertinent information is provided by the software within the requirements of this Special Note.

**B. Data Deliverables**

Provide to the Engineer a means in which to gather report summaries by way of iOS apps, web pages, or any other method at the disposal of the Engineer. The Engineer may request data at any time during the project.

**1. Asphalt Material**

**a. Real-time Continuous Data Items**

Provide the Engineer access to JSON documents capable of being transmitted through the KYTC's e-Ticketing Portal that displays the following information in real-time with a web-based system compatible with iOS and Windows environments.

- Each Truck
  - Supplier Name
  - Supplier Address
  - Supplier Phone
  - Plant location
  - Date
  - Time at source
  - Project Location

- Contract ID#
- Carrier Name
- Unique Truck ID
- Description of Material
- Mix Design Number
- Gross, Tare and Net Weight
- Weighmaster

**4.0 MEASUREMENT.** The Department will measure the electronic delivery management system as a lump sum item.

**5.0 PAYMENT.** The Department will make payment for the completed and accepted quantities under the following:

1. Payment is full compensation for all work associated with providing all required equipment, training, and documentation.
2. Payment will be full compensation for costs related to providing the e-Ticketing Delivery Software, including integration with plant load-out systems, and report viewing/exporting process. All quality control procedures including the software representative's technical support and on-site training shall be included in the Contract lump sum price.

<u>Code</u>	<u>Pay Item</u>	<u>Pay Unit</u>
26228EC	ELECTRONIC DELIVERY MGMT SYSTEM	LS

January 2024

## SPECIAL NOTE FOR EXPERIMENTAL KYCT AND HAMBURG TESTING

### 1.0 General

**1.1 Description.** The KYCT (Kentucky Method for Cracking Test) and the Hamburg test results will help determine if the mixture is susceptible to cracking and rutting. During the experimental phase, data will be gathered and analyzed by the Department to determine the durability of the bituminous mixes. Additionally, the data will help the Department to create future performance-based specifications which will include the KYCT and Hamburg test methods.

### 2.0 Equipment

**2.1 KYCT Testing Equipment.** The Department will require a Marshall Test Press with digital recordation capabilities. Other CT testing equipment may be used for testing with prior approval by the Department.

**2.2 Water Baths.** One or more water baths will be required that can maintain a temperature of 77° +/- 1.8° F with a digital thermometer showing the water bath temperature. Also, one water bath shall have the ability to suspend gyratory specimen fully submerged in water in accordance with AASHTO T-166, current edition.

**2.3 Hamburg Wheel Track Testing.** The department encourages the use of the PTI APA/Hamburg Jr. test equipment to perform the loaded wheel testing. The Department will allow different equipment for the Hamburg testing, but the testing device must be approved by the Department prior to testing.

**2.4 Gyratory Molds.** Gyratory molds will be required to assist in the production of gyratory specimens in accordance with AASHTO T-312, current edition.

**2.5 Ovens.** Adequate (minimum of two ovens) will be required to accommodate the additional molds and asphalt mixture necessary to perform the acceptance testing as outlined in Section 402 of the Kentucky Standard Specifications for Road and Bridge Construction, current edition.

**2.6 Department Equipment.** The Department will provide gyratory molds, PINE 850 Test Press with digital recordation, and CT testing equipment to assist during this experimental phase so data can be gathered. Hamburg test specimens will be submitted to the Division of Materials for testing on the PTI APA/Hamburg Jr if the asphalt contractor or district materials office does not have an approved Hamburg testing device.

### 3.0 Testing Requirements

**3.1 Acceptance Testing.** Perform all acceptance testing and aggregate gradation as according with Section 402 and Section 403 of the Kentucky Standard Specifications for Road and Bridge Construction, current edition.

**3.2 KYCT Testing.** Perform crack resistance analysis (KYCT) in accordance with the current Kentucky Method for KYCT Index Testing during the mix design phase and during the plant production of all surface mixtures. For mix design approvals, submit KYCT results on the Department MixPack. For Class 4 mixtures, submit ingredient materials to the Division of Materials for verification.

**3.2.1 KYCT Frequency.** Obtain an adequate sample of hot mix asphalt to ensure the acceptance testing, gradation, and KYCT gyratory samples can be fabricated and is representative of the bituminous mixture. Acceptance specimens shall be fabricated first, then immediately after, fabricate the KYCT samples with the gyratory compactor in accordance with Section 2.4 of this Special Note. Analysis of the KYCT specimens and gradation will be required one per subplot produced from the same asphalt material and at the same time as the acceptance specimen is sampled and tested.

**3.2.2 Number of Specimens and Conditioning.** Fabricate specimens in accordance with the Kentucky Method for KYCT Index Testing. Contrary to the method, for field specimens, fabricate a minimum of 3 and up to 6 test specimens. The specimens shall be compacted at the temperature in accordance with KM 64-411. KYCT mix design specimens shall be short-term conditioned uncovered for four hours at compaction temperature in accordance with KM 64-411. Contrary to the Kentucky Method, plant produced bituminous material shall be short-term conditioned immediately after sampling for two hours uncovered in the oven at compaction temperature in accordance with KM 64-411. Additionally, fabricated specimens shall be allowed to cool in air (fan is permissible) for 30 minutes +/- 5 minutes and conditioned in a 77 °F water bath for 30 minutes +/- 5 minutes. To ensure confidence and reliability of the test results provided by KYCT testing and Hamburg testing, reheating of the asphalt mixture is prohibited.

**3.2.3 Record Times.** For each subplot, record the time required between drying aggregates in the plant to KYCT specimen fabrication. The production time may vary due to the time that the bituminous material is held in the silo. Record the preconditioning time when the time exceeds the one-hour specimen cool down time as required in accordance with The Kentucky Method for KYCT Index Testing. The preconditioning time may exceed an hour if the technician is unable to complete the test on the same day or within the specified times as outlined in The Kentucky Method for KYCT Index Testing. The production time and the preconditioning time shall be recorded on the AMAW.

**3.2.4 File Name.** As according to section 7.12 of The Kentucky Method for KYCT Index Testing, save the filename with the following format: "CID\_Approved Mix Number\_Lot Number\_Sublot Number\_Date"

**3.3 Hamburg Testing.** Perform the rut resistance analysis (Hamburg) in accordance with AASTHO T-324, not to exceed 20,000 passes for all bituminous mixtures during the mix design phase and production. For mix design approvals, submit Hamburg results on the Department MixPack. For Class 4 mixtures, submit ingredient materials to the Division of Materials for informational verification.

**3.3.1 Hamburg Testing Frequency.** Perform testing and analysis per lot of material. The plant produced bituminous material sampled for the Hamburg test does not have to be obtained at the same time as the acceptance and KYCT sample. If the Hamburg test sample is not obtained at the same time as the KYCT sample, determine the Maximum Specific Gravity of the KYCT sample in accordance with AASHTO T-209 coinciding with the Hamburg specimens.

**3.3.2 Record Times.** Record the production time as according to section 3.2.3 in this special note. Also record the time that the specimens were fabricated and the time the Hamburg testing was started. All times shall be recorded on the AMAW.

**3.3.3 File Name.** Save the Excel spreadsheet with the following file name; “Hamburg\_CID\_Approved Mix Number\_Lot Number\_Sublot Number\_Date” and upload the file into the AMAW.

#### **4.0 Data**

Submit the AMAW and all test data that was obtained for acceptance, gradation, KYCT, and Hamburg testing within five working days once all testing has been completed for a lot to Central Materials Lab and the District Materials Engineer. Also, any data and or comments that the asphalt contractor or district personnel deem informational during this experimental phase, shall also be submitted to the Central Materials Lab and the District Materials Engineer. Any questions or comments regarding any item in this Special Note can be directed to the Central Office, Division of Materials, Asphalt Branch.

#### **5.0 Payment**

Any additional labor and testing equipment that is required to fabricate and test the KYCT and Hamburg specimens shall be considered incidental to the asphalt surface line item. The Department will perform the testing for the KYCT and Hamburg specimens if a producer does not possess the proper equipment.

June 15<sup>th</sup>, 2022

**FD05 033 0052 007-010**  
**SPECIAL NOTE FOR PAVEMENT WEDGE AND SHOULDER**  
**SEPARATE OPERATION**

**1.0 MATERIALS.** Provide an Asphalt Mixture for Pavement Wedge conforming to Section 407 of the Standard Specifications or an Asphalt Surface Mixture conforming to Section 403 of the Standard Specifications, as applicable to the project, for the pavement wedge.

**2.0 CONSTRUCTION.** Place the Asphalt Mixture for Pavement Wedge or Asphalt Surface Mixture as a separate operation from the driving lane. Prime the existing shoulder with tack material as the Engineer directs before placing the wedge. Construct according to Sections 407.03 and 403.03 as applicable.

When the Engineer deems it appropriate to pave both the driving lane and the adjoining wedge monolithically, equip the paver with a modified screed that extends the full width of the wedge being placed and is tapered to produce a wedge. Obtain the Engineer's approval of the modified screed before placing shoulder wedge monolithically with the driving lane.

The wedge may vary in thickness at the edge of the driving lanes. Where existing site conditions permit, limit the outside edge thickness of the new paving limits to one inch above the existing shoulder wedge elevation. If an Asphalt Surface Mixture is furnished for the pavement wedge, texture according to Section 403.03.08.

The following sketch is primarily for the computation of quantities; however, the wedge will result in a similar cross-section where sufficient width exists. Do not construct a shoulder for placing the wedge unless specified elsewhere in the Contract.

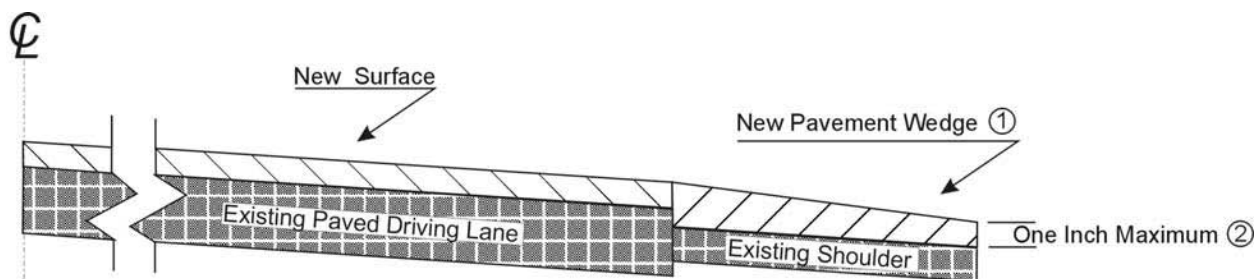

- ① Slope varies, but is down from the driving lanes except on outside of some curves where superelevation controls.
- ② Where existing site conditions permit.

**3.0 MEASUREMENT.** The Department will measure Asphalt Mixture for Pavement Wedge or Asphalt Surface Mixture placed as the pavement wedge according to Sections 403 and 407 as applicable.

**4.0 PAYMENT.** The Department will make payment for the completed and accepted quantities of Asphalt Surface Mixtures placed as pavement wedge according to Section 403. The Department will make payment for the completed and accepted quantities of Asphalt Mixture for Pavement Wedge according to Section 407.

**FD05 033 1571 000-006**  
**SPECIAL NOTE FOR PAVEMENT WEDGE AND SHOULDER**  
**MONOLITHIC OPERATION**

**1.0 MATERIALS.** Provide an Asphalt Surface Mixture conforming to Section 403 of the Standard Specifications, as applicable to the project, for the pavement wedge.

**2.0 CONSTRUCTION.** Place the specified Asphalt Surface Mixture on shoulders monolithically with the driving lane. Prime the existing shoulder with tack material as the Engineer directs before placing the wedge. Construct according to Section 403.03 of the Standard Specifications.

Equip the paver with a modified screed that extends the full width of the wedge being placed and is tapered to produce a wedge. Obtain the Engineer's approval of the modified screed before placing shoulder wedge monolithically with the driving lane.

The wedge may vary in thickness at the edge of the milled area in the shoulder. If the area to receive the shoulder wedge is milled prior to placement, during rolling operations pinch the outside edge of the new inlay wedge to match the existing shoulder elevation not being resurfaced. Unless required otherwise by the Contract, construct rolled or sawed rumble strips according to Section 403.03.08, as applicable.

The following sketch is primarily for the computation of quantities; however, the wedge will result in a similar cross-section where sufficient width exists. Do not construct a shoulder for placing the wedge unless specified elsewhere in the Contract.

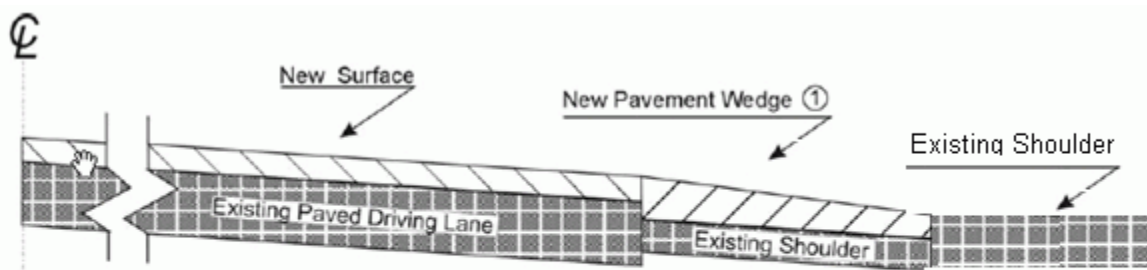

① Slope varies, but is down from the driving lanes except on outside of some curves where superelevation controls.

**3.0 MEASUREMENT.** The Department will measure Asphalt Surface Mixture placed as the pavement wedge according to Section 403.

**4.0 PAYMENT.** The Department will make payment for the completed and accepted quantities of Asphalt Surface Mixtures on pavement wedges according to Section 403.



### SPECIAL NOTE FOR EDGE KEY

Construct Edge Keys at the beginning of project, end of project, at railroad crossings, and at ramps, as applicable. Unless specified in the Contract or directed by the Engineer, do not construct edge keys at intersecting streets, roads, alleys, or entrances. Cut out the existing asphalt surface to the required depth and width shown on the drawing and heel the new surface into the existing surface. The Department will make payment for this work at the Contract unit price per ton for Asphalt Pavement Milling and Texturing, which shall be full compensation for all labor, materials, equipment, and incidentals for removal and disposal of the existing asphalt surface required to construct the edge key.

### EDGE KEY

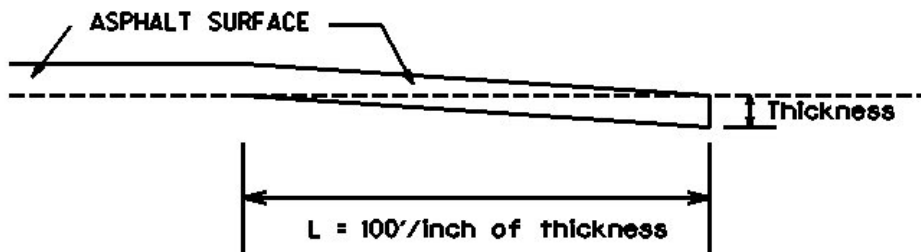

**FD05 033 0052 007-010**  
**Thickness = 1.25 Inches**

**L = 125 LF**

**L= Length of Edge Key**

**FD05 033 1571 000-006**  
**Thickness = 1.00 Inches**

**L = 100 LF**

**L= Length of Edge Key**

**SPECIAL NOTE FOR  
ASPHALT MILLING AND TEXTURING**

Begin paving operations within **48 hours** of commencement of the milling operation. Continue paving operations continuously until completed. If paving operations are not begun within this time period, the Department will assess liquidated damages at the rate prescribed by Section 108.09 until such time as paving operations are begun.

Take possession of the millings and recycle the millings or dispose of the millings off the Right-of-Way at sites obtained by the Contractor at no additional cost to the Department.

1-3520 48 hours Contractor keeps millings  
01/2/2012

## **SPECIAL NOTE FOR BASE FAILURE REPAIR KY 1571**

Repair locations listed on the summary are approximate only. The Engineer will determine actual repair locations and dimensions at the time of construction. Prior to overall milling and/or leveling and wedging, excavate the designated base failure areas by milling to a depth 6 inches below the existing asphalt pavement surface level. Dispose of the excavated materials at waste sites off the Right-of-Way obtained by the Contractor at no additional cost to the Department. See Special Note for Waste and Borrow.

Backfill the excavated areas with Class 2 Asphalt Base 1.00D PG64-22. Compact the asphalt base to the compaction required in Section 403.03.10. Seal the asphalt base with leveling and wedging. Perform all base failure repairs in such a manner that removal and replacement are completed on the same day. Do this work as one of the Contractor's first operations in order to allow further compaction by traffic. Do not mill or place new asphalt surface over repaired base failure areas until a minimum of 7 calendar days have elapsed after placement of the asphalt base. After a minimum of 7 calendar days and when the Engineer determines the base failure repair areas have sufficiently stabilized, begin milling and/or resurfacing operations. Prior to milling and/or constructing the new asphalt surface, level and wedge any settlement of the repair areas.

The bidder must draw conclusions as to the conditions encountered. The Department does not give any guarantee as to the accuracy of the data and will not consider any claim for additional compensation if the materials encountered that are not in accord with the classification shown.

Accept payment at the Contract unit prices per ton for Asphalt Milling and Texturing, Asphalt Base, and Leveling and Wedging as full compensation for all labor, materials, equipment, and incidentals for removing pavement and disposing of the materials, furnishing and placing asphalt base, leveling and wedging, and all other items necessary to complete the work according to these notes to the satisfaction of the Engineer.

1-3605 basefailurerepairmillinlaypayton  
01/02/2012

### **SPECIAL NOTE FOR TYPICAL SECTION DIMENSIONS**

Consider the dimensions shown on the typical sections for pavement and shoulder widths and thickness' to be nominal or typical dimensions. The Engineer may direct or approve varying the actual dimensions to be constructed to fit existing conditions. Do not widen existing pavement or shoulders unless specified elsewhere in this proposal or directed by the engineer.

1-3725 Typical Section Dimensions  
01/02/2012

## TRAFFIC CONTROL PLAN

---

### TRAFFIC CONTROL GENERAL

Except as provided herein, maintain and control traffic in accordance with the Standard and Supplemental Specifications and the Standard and Sepia Drawings, current editions. Except for the roadway and traffic control bid items listed, all items of work necessary to maintain and control traffic will be paid at the lump sum bid price to "Maintain and Control Traffic".

Contrary to Section 106.01, furnish new, or used in like new condition, traffic control devices at the beginning of the work and maintain in like new condition until completion of the work.

### PROJECT PHASING & CONSTRUCTION PROCEDURES

Do not erect lane closures on the following days:

- Good Friday through Easter (March 29 - 31)
- Memorial Day (May 27)
- Independence Day (July 4)
- Labor Day (September 2)
- Thanksgiving (November 28 - Dec 1)

The Engineer may specify additional days and hours when lane closures will not be allowed.

At locations with three or more lanes, maintain one lane of traffic in each direction at all times during construction. At locations with two lanes, maintain alternating one way traffic during construction. Provide a minimum clear lane width of 10 feet, for both KY 52 and KY 1571; however, provide for passage of vehicles of up to 16 feet in width. If traffic should be stopped due to construction operations, and a school bus on an official run arrives on the scene, make provisions for the passage of the bus as quickly as possible.

### LANE CLOSURES

Do not leave lane closures in place during non-working hours.

### SIGNS

Sign posts and splices shall be compliant with NCHRP 350 or MASH. Manufacturer's documentation validating this compliance shall be provided to the Engineer prior to installation. Signs, including any splices, shall be installed according to manufacturer's specifications and installation recommendations. Contrary to section 112.04.02, only long-term signs (signs intended to be continuously in place for more than 3 days) will be measured for payment. Short-term signs

## Traffic Control Plan

Page 2 of 11

(signs intended to be left in place for 3 days or less) will not be measured for payment but will be incidental to Maintain and Control Traffic.

### **CHANGEABLE MESSAGE SIGNS**

Provide changeable message signs in advance of and within the project at locations determined by the Engineer. If work is in progress concurrently in both directions or if more than one lane closure is in place in the same direction of travel, provide additional changeable message signs as directed by the Engineer. Place changeable message signs one mile in advance of the anticipated queue at each lane closure. As the actual queue lengthens and/or shortens, relocate or provide additional changeable message signs so that traffic has warning of slowed or stopped traffic at least one mile but not more than two miles before reaching the end of the actual queue. The Engineer may vary the designated locations as the work progresses. The Engineer will determine the messages to be displayed. In the event of damage or mechanical/electrical failure, repair or replace the Changeable Message Sign within 24 hours. The Department will measure for payment the maximum number of Changeable Message Signs in concurrent use at the same time on a single day on all sections of the contract. The Department will measure individual Changeable Message Signs only once for payment, regardless of how many times they are set, reset, removed, and relocated during the duration of the project. The Department will not measure replacements for damaged Changeable Message Signs or for signs the Engineer directs be replaced due to poor condition or readability. Retain possession of the Changeable Message Signs upon completion of the work.

### **ARROW PANELS**

Use arrow panels as shown on the Standard Drawings or as directed by the Engineer. The Department will measure for payment the maximum number of arrow panels in concurrent use at the same time on a single day on all sections of the contract. The Department will measure for payment the maximum number of Arrow Panels in concurrent use at the same time on a single day on all sections of the contract. The Department will measure individual Arrow Panels only once for payment, regardless of how many times they are set, reset, removed, and relocated during the duration of the project. The Department will not measure replacements for damaged Arrow Panels or for panels signs the Engineer directs be replaced due to poor condition or readability for payment. Retain possession of the Arrow Panels upon completion of the work.

## **TEMPORARY ENTRANCES**

The Engineer will not require the Contractor to provide continuous access to farms, single family, duplex, or triplex residential properties during working hours; however, provide reasonable egress and ingress to each such property when actual operations are not in progress at that location. Limit the time during which a farm or residential entrance is blocked to the minimum length of time required for actual operations, not extended for the Contractor's convenience, and in no case exceeding six (6) hours. Notify all residents twenty-four hours in advance of any driveway or entrance closings and make any accommodations necessary to meet the access needs of disabled residents.

Except as allowed by the Phasing as specified above, maintain direct access to all side streets and roads, schools, churches, commercial properties and apartments or apartment complexes of four or more units at all times.

The Department will measure asphalt materials required to construct and maintain any temporary entrances which may be necessary to provide temporary access; however, the Department will not measure aggregates, excavation, and/or embankment, but shall be incidental to Maintain and Control Traffic. The Engineer will determine the type of surfacing material, asphalt or aggregate, to be used at each entrance.

## **THERMOPLASTIC INTERSECTION MARKINGS**

Consider the locations listed on the summary as approximate only. Prior to milling and/or resurfacing, locate and document the locations of the existing markings. After resurfacing, replace the markings at their approximate existing locations or as directed by Engineer. Place markings not existing prior to resurfacing as directed by the Engineer.

## **BARRICADES**

The Department will not measure barricades used in lieu of barrels and cones for channelization or delineation, but shall be incidental to Maintain and Control Traffic according to Section 112.04.01.

The Department will measure barricades used to protect pavement removal areas in individual units Each. The Department will measure for payment the maximum number of barricades in concurrent use at the same time on a single day on all sections of the contract. The Department will measure individual barricades only once for payment, regardless of how many times they are set, reset, removed, and relocated during the duration of the project. The Department will not measure replacements for damaged barricades the Engineer directs to be replaced due to poor condition or reflectivity. Retain possession of the Barricades upon completion of the work.

## **PAVEMENT MARKINGS**

If there is to be a deviation from the existing striping plan, the Engineer will furnish the Contractor a striping plan prior to placement of the final surface course. Install Temporary Striping according to Section 112 with the following exceptions:

1. Include edge lines in Temporary Striping; and
2. Place Temporary or Permanent Striping before opening a lane to traffic; and
3. If the Contractor's operations or phasing requires temporary markings that must subsequently be removed from the final surface course, use an approved removable lane tape; however, the Department will not measure removable lane tape for separate payment, but will measure and pay for removable lane tape as temporary striping.

## **PAVEMENT EDGE DROP-OFFS**

Do not allow a pavement edge between opposing directions of traffic or lanes that traffic is expected to cross in a lane change situation with an elevation difference greater than 1½". Place Warning signs (MUTCD W8-11 or W8-9A) in advance of and at 1500' intervals throughout the drop-off area. Dual post the signs on both sides of the traveled way. Wedge all transverse transitions between resurfaced and unresurfaced areas which traffic may cross with asphalt mixture for leveling and wedging. Remove the wedges prior to placement of the final surface course.

Protect pavement edges that traffic is not expected to cross, except accidentally, as follows:

Less than 2" - No protection required.

2" to 4" - Place plastic drums, vertical panels, or barricades every 50 feet. During daylight working hours only, the Engineer will allow the Contractor to use cones in lieu of plastic drums, panels, and barricades. Wedge the drop-off with DGA or asphalt mixture for leveling and wedging with a 1:1 or flatter slope in daylight hours, or 3:1 or flatter slope during nighttime hours, when work is not active in the drop-off area.

Greater than 4" - Protect drop-offs greater than 4 inches within 10 feet of traffic by placing drums, vertical panels, or barricades every 25 feet. The Engineer will not allow the use of cones in lieu of drums, vertical panels, or barricades for drop-offs greater than 4". Place Type III Barricades directly in front of the drop-off facing on coming traffic in both directions of travel. Provide warning signs as shown on the Standard Drawings or as directed by the Engineer



Traffic Control Plan  
Page 5 of 11

**Pedestrians & Bicycles - Protect pedestrian and bicycle traffic as directed by the engineer.**

1-3840 Traffic Control Plan 3 or More Lanes High ADT  
7/28/2017

## **USE AND PLACEMENT OF CHANGEABLE MESSAGE SIGNS**

The following policy is based upon current Changeable Message Signs (CMS) standards and practice from many sources, including the Federal Highway Administration (FHWA), other State Departments of Transportation, and Traffic Safety Associations. It is understood that each CMS installation or use requires individual consideration due to the specific location or purpose. However, there will be elements that are constant in nearly all applications. Accordingly these recommended guidelines bring a level of uniformity, while still being open to regional experience and engineering judgment.

### **Application**

The primary purpose of CMS is to advise the driver of unexpected traffic and routing situations. Examples of applications where CMS can be effective include:

- Closures (road, lane, bridge, ramp, shoulder, interstate)
- Changes in alignment or surface conditions
- Significant delays, congestion
- Construction/maintenance activities (delays, future activities)
- Detours/alternative routes
- Special events with traffic and safety implications
- Crash/incidents
- Vehicle restrictions (width, height, weight, flammable)
- Advance notice of new traffic control devices
- Real-time traffic conditions (must be kept up to date)
- Weather /driving conditions, environmental conditions, Roadway Weather Information Systems
- Emergency Situations
- Referral to Highway Advisory Radio (if available)
- Messages as approved by the County Engineer's Office

### **CMS should not be used for:**

- Replacement of static signs (e.g. road work ahead), regulatory signage (e.g. speed limits), pavement markings, standard traffic control devices, conventional warning or guide signs.
- Replacement of lighted arrow board
- Advertising (Don't advertise the event unless clarifying "action" to be taken by driver – e.g. Speedway traffic next exit)
- Generic messages
- Test messages (portable signs only)
- Describe recurrent congestion (e.g. rush hour)
- Public service announcements (not traffic related)

Traffic Control Plan  
Page 7 of 11

**Messages**

Basic principles that are important to providing proper messages and insuring the proper operation of a CMS are:

- Visible for at least ½ mile under ideal daytime and nighttime conditions
- Legible from all lanes a minimum of 650 feet
- Entire message readable twice while traveling at the posted speed
- Nor more than two message panels should be used (three panels may be used on roadways where vehicles are traveling less than 45 mph). A panel is the message that fits on the face of the sign without flipping or scrolling.
- Each panel should convey a single thought; short and concise
- Do not use two unrelated panels on a sign
- Do not use the sign for two unrelated messages
- Should not scroll text horizontally or vertically
- Should not contain both the words left and right
- Use standardized abbreviations and messages
- Should be accurate and timely
- Avoid filler/unnecessary words and periods (hazardous, a, an, the)
- Avoid use of speed limits
- Use words (not numbers) for dates

**Placement**

Placement of the CMS is important to insure that the signs is visible to the driver and provides ample time to take any necessary action. Some of the following principles may only be applicable to controlled access roadways. The basic principles of placement for a CMS are:

- When 2 signs are needed, place on same side of roadway and at least 1,000 feet apart
- Place behind semi-rigid/rigid protection (guardrail, barrier) or outside of the clear zone
- Place 1,000 feet in advance of work zone; at least one mile ahead of decision point
- Normally place on right side of roadway; but should be placed closest to the affected lane so that either side is acceptable
- Signs should not be dual mounted (one on each side of roadway facing same direction)
- Point trailer hitch downstream
- Secure to immovable object to prevent thief (if necessary)
- Do not place in sags or just beyond crest
- Check for reflection of sun to prevent the blinding of motorist
- Should be turned ~3 degrees outward from perpendicular to the edge of pavement
- Bottom of sign should be 7 feet above the elevation of edge of roadway
- Should be removed when not in use
-

### Standard Abbreviations

The following is a list of standard abbreviations to be used on CMS.

<b><u>Word</u></b>	<b><u>Abbrev.</u></b>	<b><u>Example</u></b>
Access	ACCS	ACCIDENT AHEAD/USE ACCS RD NEXT RIGHT
Alternate	ALT	ACCIDENT AHEAD/USE ALT RTE NEXT RIGHT
Avenue	AVE	FIFTH AVE CLOSED/DETOUR NEXT LEFT
Blocked	BLKD	FIFTH AVE BLKD/MERGE LEFT
Boulevard	BLVD	MAIN BLVD CLOSED/USE ALT RTE
Bridge	BRDG	SMITH BRDG CLOSED/USE ALT RTE
Cardinal Directions	N, S, E, W	N I75 CLOSED/ DETOUR EXIT 30
Center	CNTR	CNTR LANE CLOSED/MERGE LEFT
Commercial	COMM	OVRSZ COMM VEH/USE I275
Condition	COND	ICY COND POSSIBLE
Congested	CONG	HVY CONG NEXT 3 MI
Construction	CONST	CONST WORK AHEAD/EXPECT DELAYS
Downtown	DWNTN	DWNTN TRAF USE EX 40
Eastbound	E-BND	E-BND I64 CLOSED/DETOUR EXIT 20
Emergency	EMER	EMER VEH AHEAD/PREPARE TO STOP
Entrance, Enter	EX, EXT	DWNTN TRAF USE EX 40
Expressway	EXPWY	WTRSN EXPWY CLOSED/DETOUR EXIT 10
Freeway	FRWY, FWY	GN SYNDR FWY CLOSED/DETOUR EXIT 15
Hazardous Materials	HAZMAT	HAZMAT IN ROADWAY/ALL TRAF EXIT 25
Highway	HWY	ACCIDENT ON AA HWY/EXPECT DELAYS
Hour	HR	ACCIDENT ON AA HWY/2 HR DELAY
Information	INFO	TRAF INFO TUNE TO 1240 AM
Interstate	I	E-BND I64 CLOSED/DETOUR EXIT 20
Lane	LN	LN CLOSED/MERGE LEFT
Left	LFT	LANE CLOSED/MERGE LFT
Local	LOC	LOC TRAF USE ALT RTE
Maintenance	MAINT	MAINT WRK ON BRDG/SLOW
Major	MAJ	MAJ DELWAYS I75/USE ALT RTE

Traffic Control Plan  
Page 9 of 11

Mile	MI	ACCIDENT 3 MI AHEAD/ USE ALT RTE
Minor Minutes	MNR MIN	ACCIDENT 3 MI MNR DELAY ACCIDENT 3 MI/30 MIN DELAY
Northbound	N-BND	N-BND I75 CLOSED/ DETOUR EXIT 50
Oversized	OVRSZ	OVRSZ COMM VEH/USE I275 NEXT RIGHT
Parking Parkway	PKING PKWY	EVENT PKING NEXT RGT CUM PKWAY TRAF/DETOUR EXIT 60
Prepare Right Road Roadwork	PREP RGT RD RDWK	ACCIDENT 3 MIL/PREP TO STOP EVENT PKING NEXT RGT HAZMAT IN RD/ALL TRAF EXIT 25 RDWK NEXT 4 MI/POSSIBLE DELAYS
Route Shoulder Slippery Southbound	RTE SHLDR SLIP S-BND	MAJ DELAYS I75/USE ALT RTE SHLDR CLOSED NEXT 5 MI SLIP COND POSSIBLE/ SLOW SPD S-BND I75 CLOSED/DETOUR EXIT 50
Speed Street Traffic	SPD ST TRAF	SLIP COND POSSIBLE/ SLOW SPD MAIN ST CLOSED/USE ALT RTE CUM PKWAY TRAF/DETOUR EXIT 60
Vehicle	VEH	OVRSZ COMM VEH/USE I275 NEXT RIGHT
Westbound	W-BND	W-BND I64 CLOSED/DETOUR EXIT 50
Work	WRK	CONST WRK 2MI/POSSIBLE DELAYS

Certain abbreviations are prone to inviting confusion because another word is abbreviated or could be abbreviated in the same way. DO NO USE THESE ABBREVIATIONS.

<u>Abbrev.</u>	<u>Intended Word</u>	<u>Word Erroneously Given</u>
ACC	Accident	Access (Road)
CLRS	Clears	Colors
DLY	Delay	Daily
FDR	Feeder	Federal
L	Left	Lane (merge)
LOC	Local	Location
LT	Light (traffic)	Left
PARK	Parking	Park
POLL	Pollution (index)	Poll
RED	Reduce	Red
STAD	Stadium	Standard

Traffic Control Plan  
Page 10 of 11

TEMP  
WRNG

Temporary  
Warning

Temperature  
Wrong

**TYPICAL MESSAGES**

The following is a list of typical messages used on CMS. The list consists of the reason or problem that you want the driver to be aware of and the action that you want the driver to take.

**Reason/Problem**

ACCIDENT  
 ACCIDENT/XX MILES  
 XX ROAD CLOSED  
 XX EXIT CLOSED  
 BRIDGE CLOSED  
 BRIDGE/(SLIPPERY, ICE, ETC.)  
 CENTER/LANE/CLOSED  
 DELAY(S), MAJOR/DELAYS  
 DEBRIS AHEAD  
 DENSE FOG  
 DISABLED/VEHICLE  
 EMER/VEHICLES/ONLY  
 EVENT PARKING  
 EXIT XX CLOSED  
 FLAGGER XX MILES  
 FOG XX MILES  
 FREEWAY CLOSED  
 FRESH OIL  
 HAZMAT SPILL  
 ICE  
 INCIDENT AHEAD  
 LANES (NARROW, SHIFT, MERGE, ETC.)  
 LEFT LANE CLOSED  
 LEFT LANE NARROWS  
 LEFT 2 LANES CLOSED  
 LEFT SHOULDER CLOSED  
 LOOSE GRAVEL  
 MEDIAN WORK XX MILES  
 MOVING WORK ZONE, WORKERS IN ROADWAY  
 NEXT EXIT CLOSED  
 NO OVERSIZED LOADS  
 NO PASSING  
 NO SHOULDER  
 ONE LANE BRIDGE

**Action**

ALL TRAFFIC EXIT RT  
 AVOID DELAY USE XX  
 CONSIDER ALT ROUTE  
 DETOUR  
 DETOUR XX MILES  
 DO NOT PASS  
 EXPECT DELAYS  
 FOLLOW ALT ROUTE  
 KEEP LEFT  
 KEEP RIGHT  
 MERGE XX MILES  
 MERGE LEFT  
 MERGE RIGHT  
 ONE-WAY TRAFFIC  
 PASS TO LEFT  
 PASS TO RIGHT  
 PREPARE TO STOP  
 REDUCE SPEED  
 SLOW  
 SLOW DOWN  
 STAY IN LANE  
 STOP AHEAD  
 STOP XX MILES  
 TUNE RADIO 1610 AM  
 USE NN ROAD  
 USE CENTER LANE  
 USE DETOUR ROUTE  
 USE LEFT TURN LANE  
 USE NEXT EXIT  
 USE RIGHT LANE  
 WATCH FOR FLAGGER

## Traffic Control Plan

Page 11 of 11

PEOPLE CROSSING  
RAMP CLOSED  
RAMP (SLIPPERY, ICE, ETC.)  
RIGHT LANE CLOSED  
RIGHT LANE NARROWS  
RIGHT SHOULDER CLOSED  
ROAD CLOSED  
ROAD CLOSED XX MILES  
ROAD (SLIPPERY, ICE, ETC.)  
ROAD WORK  
ROAD WORK (OR CONSTRUCTION) (TONIGHT, TODAY, TOMORROW, DATE)  
ROAD WORK XX MILES  
SHOULDER (SLIPPERY, ICE, SOFT, BLOCKED, ETC.)  
NEW SIGNAL XX MILES  
SLOW 1 (OR 2) - WAY TRAFFIC  
SOFT SHOULDER  
STALLED VEHICLES AHEAD  
TRAFFIC BACKUP  
TRAFFIC SLOWS  
TRUCK CROSSING  
TRUCKS ENTERING  
TOW TRUCK AHEAD  
UNEVEN LANES  
WATER ON ROAD  
WET PAINT  
WORK ZONE XX MILES  
WORKERS AHEAD

**DURABLE PAVEMENT EDGE DETAIL**

(Resurfacing adjacent to fill slope or ditch foreslope that is 3:1 or less)

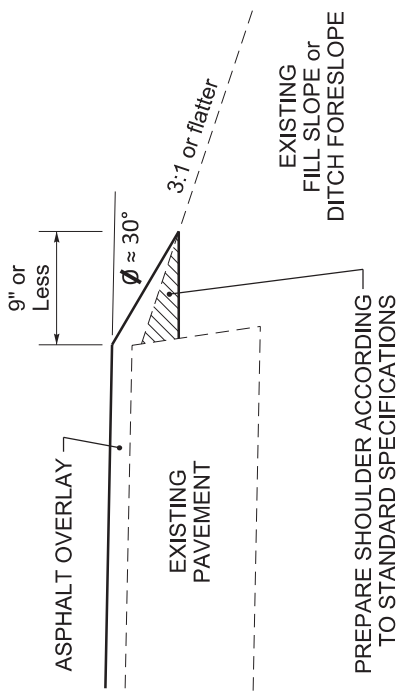

**DURABLE PAVEMENT EDGE DETAIL**

(Resurfacing adjacent to fill slope or ditch foreslope that is steeper than 3:1)

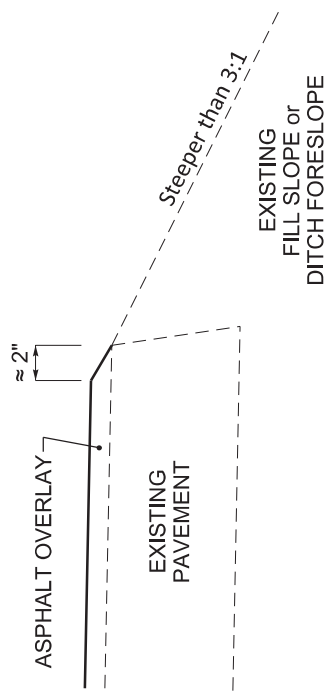

**NOTES**

1. DETAILS DO NOT APPLY TO OVERLAYS LESS THAN 1 INCH THICK.
2. THE DURABLE PAVEMENT EDGE DEVICE MAY BE DISENGAGED AT DRIVEWAYS, SIDE STREETS, HIGH SHOULDERS, AND OTHER LOCATIONS NOT FEASIBLE TO CONSTRUCT, AS APPROVED BY THE ENGINEER.

DURABLE PAVEMENT EDGE  
DETAILS

DRAWING NOT TO SCALE

**DURABLE PAVEMENT EDGE DETAIL**

(Resurfacing adjacent to low shoulder with dropoff of 5 inches or less)

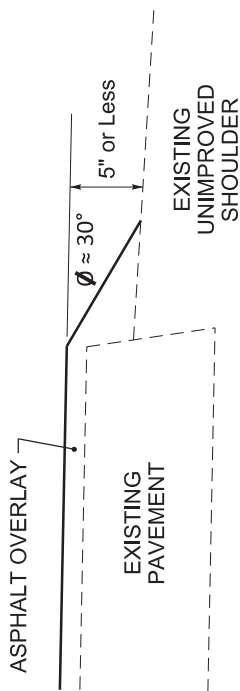

**DURABLE PAVEMENT EDGE DETAIL**

(Resurfacing adjacent to low shoulder with dropoff of more than 5 inches)

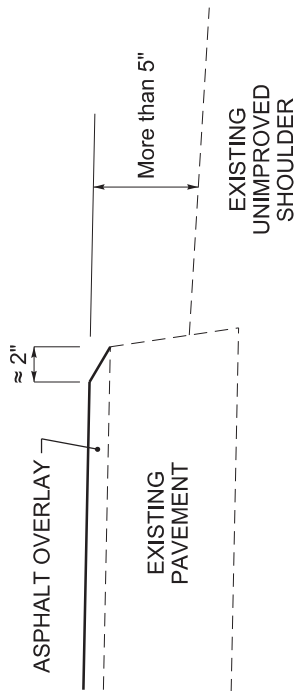

**DURABLE PAVEMENT EDGE DETAIL**

(Resurfacing adjacent to an obstruction, such as an existing headwall)

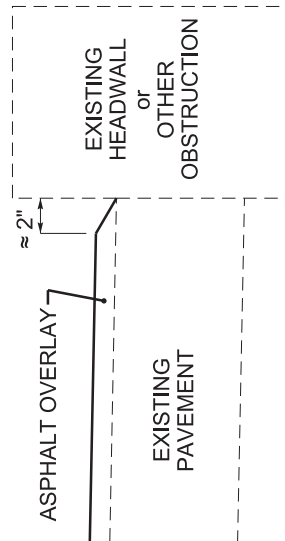



## **INSTALL RADAR PRESENCE DETECTOR TYPE A**

*Install Radar Presence Detector Type A* shall consist of installation of a pole mounted radar presence sensor, sensor mounting bracket, sensor cables, interface boxes, lead-in cable, connectors (furnished by contractor), and controller interface assembly. Radar Presence Detector Type A bid item shall include all labor required to provide a functional detection system. Radar Presence Detector Type A shall be installed and wired in accordance with the manufacturer's instructions. After the detector is installed and before the detector is powered on, the contractor shall coordinate with District Traffic Division's representatives to schedule a time to perform the detector setup. The contractor shall double check to verify that all wiring is correctly installed and connected before scheduling the setup work. Representatives from KYTC and/or the manufacturer or salesrepresentative will assist with setup and calibration. The contractor shall provide a bucket truck and operators at this time for final aiming of the sensors. The contractor shall provide individuals capable of operating the setup software and learning the setup process so that future installations may be completed without assistance from others.

October 12, 2023

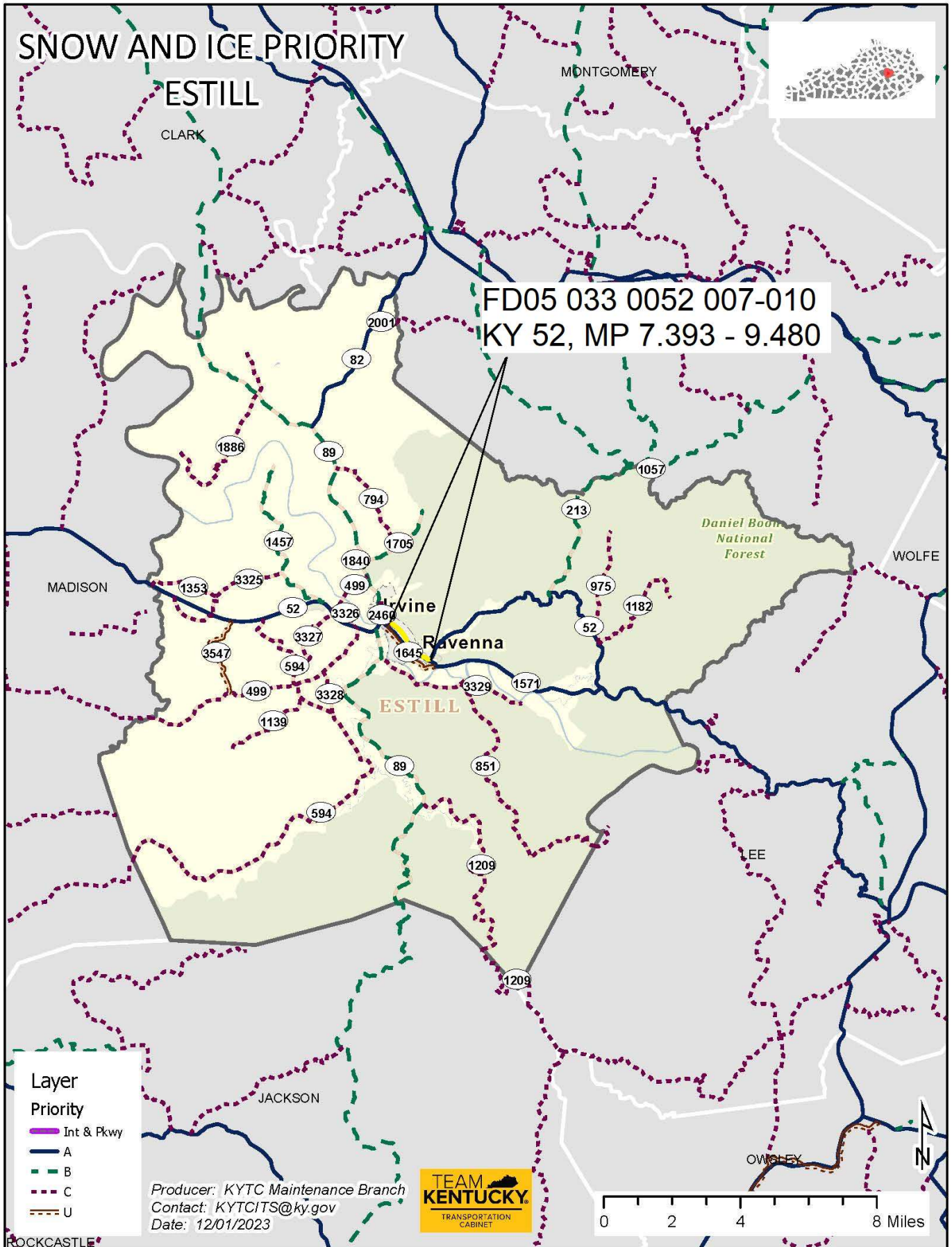

# SNOW AND ICE PRIORITY

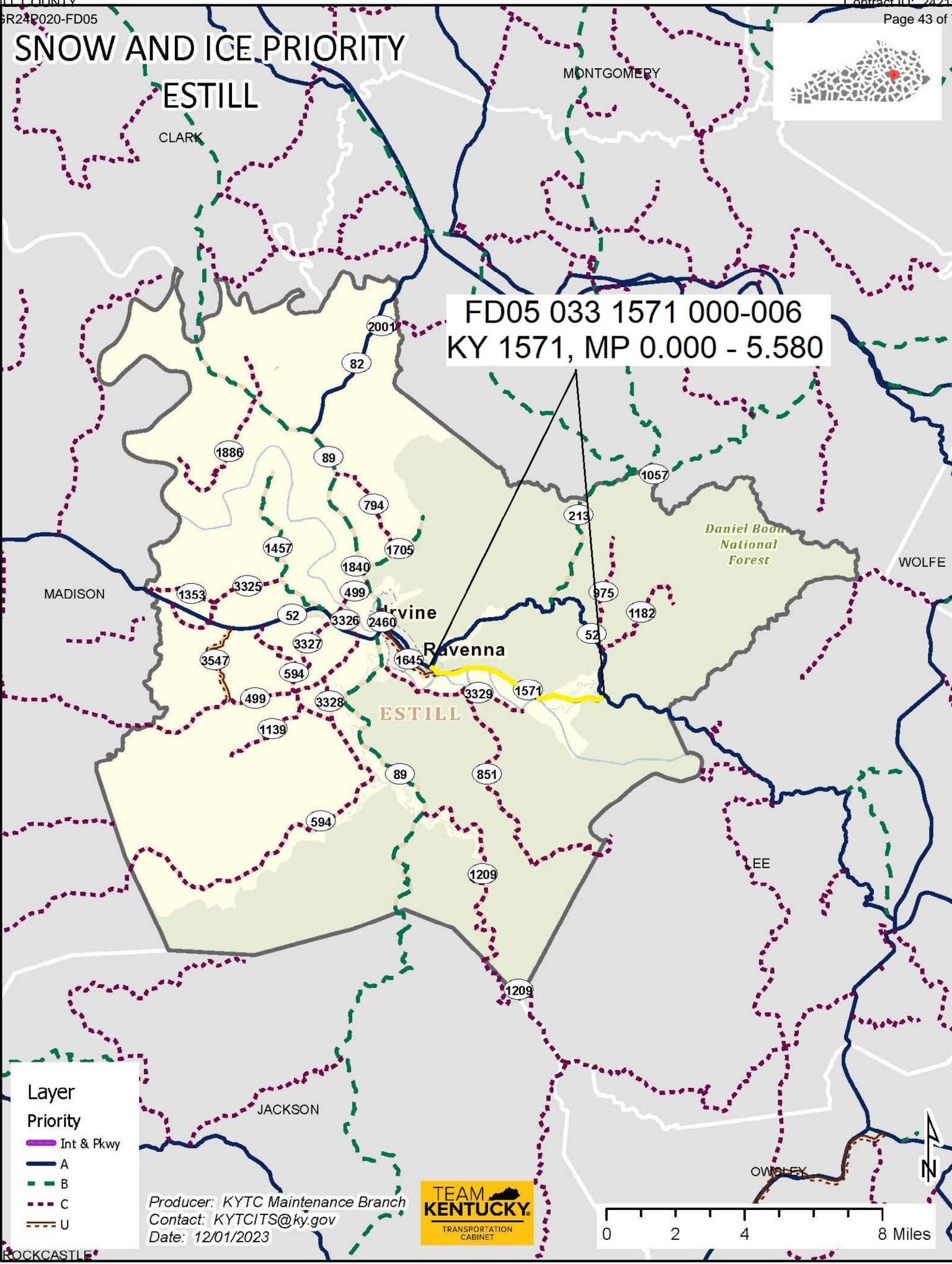
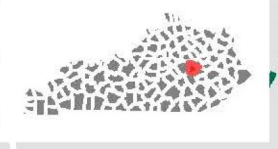

FD05 033 1571 000-006  
KY 1571, MP 0.000 - 5.580

**Layer**

**Priority**

- Int & Pkwy
- A
- B
- C
- U

Producer: KYTC Maintenance Branch  
Contact: KYTCITS@ky.gov  
Date: 12/01/2023

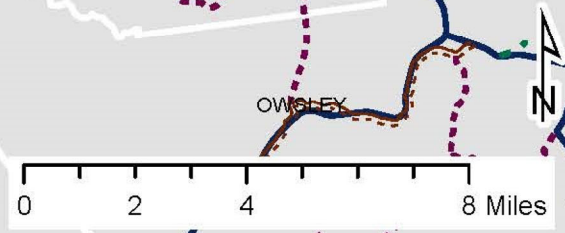

# MATERIAL SUMMARY

**CONTRACT ID: 242155**

**033GR24P020-FD05**

**MP03300522401**

RIVER DRIVE (KY 52) FROM EAST END OF KY RIVER BRIDGE, EXTENDING EAST TO KY 1571 ASPHALT RESURFACING, A DISTANCE OF 1.93 MILES.

Project Line No	Bid Code	DESCRIPTION	Quantity	Unit
0095	00190	LEVELING & WEDGING PG64-22	388.00	TON
0100	00301	CL2 ASPH SURF 0.38D PG64-22	350.00	TON
0105	00388	CL3 ASPH SURF 0.38B PG64-22	2,900.00	TON
0110	02562	TEMPORARY SIGNS	1,020.00	SQFT
0115	02650	MAINTAIN & CONTROL TRAFFIC - (KY 52)	1.00	LS
0120	02671	PORTABLE CHANGEABLE MESSAGE SIGN	4.00	EACH
0125	02676	MOBILIZATION FOR MILL & TEXT - (KY 52)	1.00	LS
0130	02677	ASPHALT PAVE MILLING & TEXTURING	3,250.00	TON
0135	06510	PAVE STRIPING-TEMP PAINT-4 IN	57,400.00	LF
0140	06542	PAVE STRIPING-THERMO-6 IN W	22,039.00	LF
0145	06543	PAVE STRIPING-THERMO-6 IN Y	35,360.00	LF
0150	06565	PAVE MARKING-THERMO X-WALK-6 IN	520.00	LF
0155	06568	PAVE MARKING-THERMO STOP BAR-24IN	148.00	LF
0160	06569	PAVE MARKING-THERMO CROSS-HATCH	283.00	SQFT
0165	06573	PAVE MARKING-THERMO STR ARROW	2.00	EACH
0170	06574	PAVE MARKING-THERMO CURV ARROW	16.00	EACH
0175	10020NS	FUEL ADJUSTMENT	5,523.00	DOLL
0180	10030NS	ASPHALT ADJUSTMENT	13,871.00	DOLL
0185	24880EC	REMOVE PAVEMENT MARKER	450.00	EACH
0190	24970EC	ASPHALT MATERIAL FOR TACK NON-TRACKING	19.00	TON
0195	26119EC	INSTALL RADAR PRESENCE DETECTOR TYPE A	6.00	EACH
0200	26228EC	ELECTRONIC DELIVERY MGMT SYSTEM - (KY 52)	1.00	LS
0205	02569	DEMOBILIZATION	1.00	LS

# MATERIAL SUMMARY

**CONTRACT ID: 242155**

**033GR24P020-FD05**

**MP03315712401**

RIVER ROAD (KY 1571) FROM KY 52, EXTENDING EAST TO KY 52 ASPHALT RESURFACING, A DISTANCE OF 5.58 MILES.

Project Line No	Bid Code	DESCRIPTION	Quantity	Unit
0005	00190	LEVELING & WEDGING PG64-22	680.00	TON
0010	00212	CL2 ASPH BASE 1.00D PG64-22	140.00	TON
0015	00301	CL2 ASPH SURF 0.38D PG64-22	4,330.00	TON
0020	02562	TEMPORARY SIGNS	580.00	SQFT
0025	02650	MAINTAIN & CONTROL TRAFFIC - (KY 1571)	1.00	LS
0030	02676	MOBILIZATION FOR MILL & TEXT - (KY 1571)	1.00	LS
0035	02677	ASPHALT PAVE MILLING & TEXTURING	270.00	TON
0040	02697	EDGE LINE RUMBLE STRIPS	58,300.00	LF
0045	06510	PAVE STRIPING-TEMP PAINT-4 IN	50,000.00	LF
0050	06515	PAVE STRIPING-PERM PAINT-6 IN	117,850.00	LF
0055	06562	PAVE MARKING-THERMO R 6 FT	4.00	EACH
0060	06563	PAVE MARKING-R/R XBUCKS 16 IN	144.00	LF
0065	06568	PAVE MARKING-THERMO STOP BAR-24IN	100.00	LF
0070	10020NS	FUEL ADJUSTMENT	8,117.00	DOLL
0075	10030NS	ASPHALT ADJUSTMENT	20,839.00	DOLL
0080	24970EC	ASPHALT MATERIAL FOR TACK NON-TRACKING	33.00	TON
0085	26228EC	ELECTRONIC DELIVERY MGMT SYSTEM - (KY 1571)	1.00	LS
0090	02569	DEMOBILIZATION	1.00	LS











**Estill County  
TYPICAL SECTION  
FD05 033 0052 007-010  
MP's 7.393 TO 9.100**

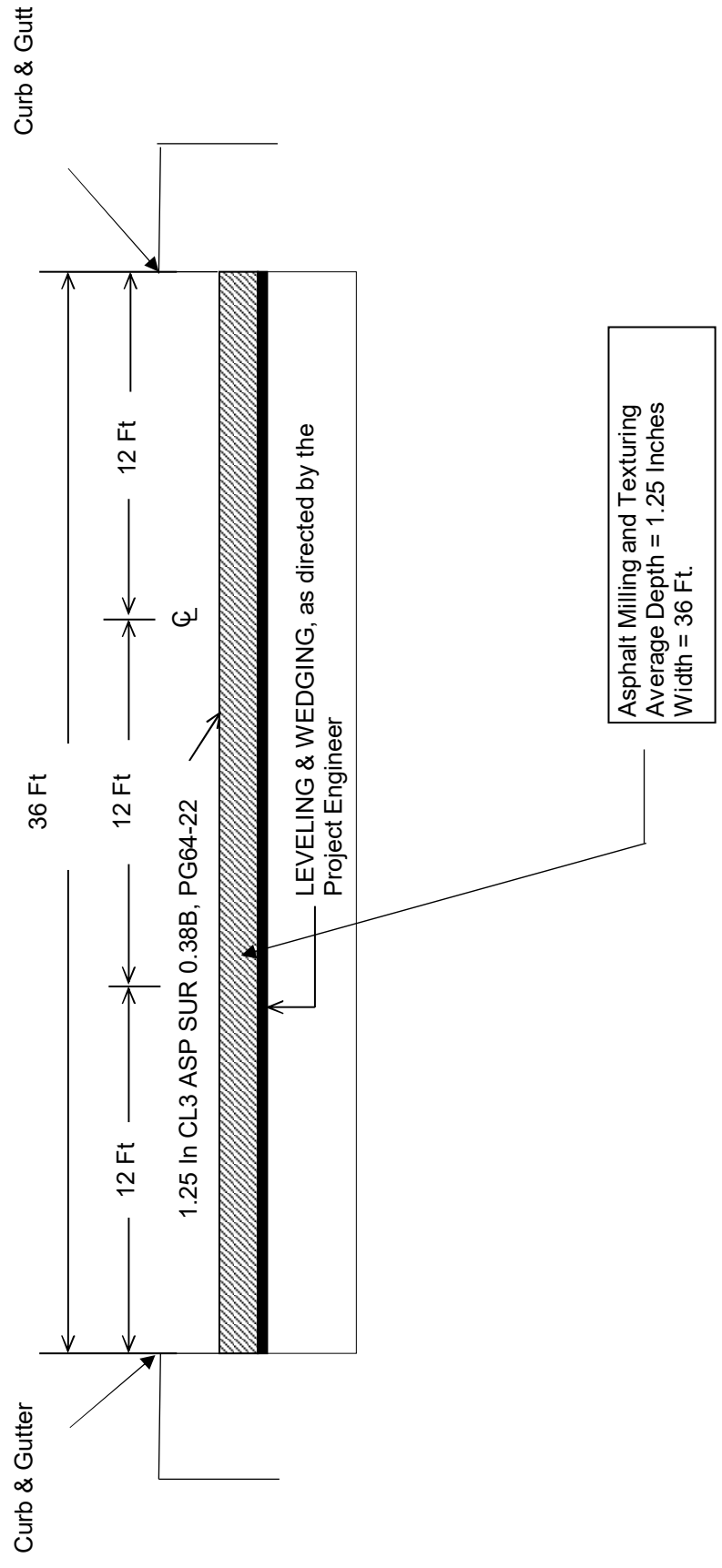

**Estill County  
TYPICAL SECTION  
FD05 033 0052 007-010  
MP's 9.100 TO 9.480**

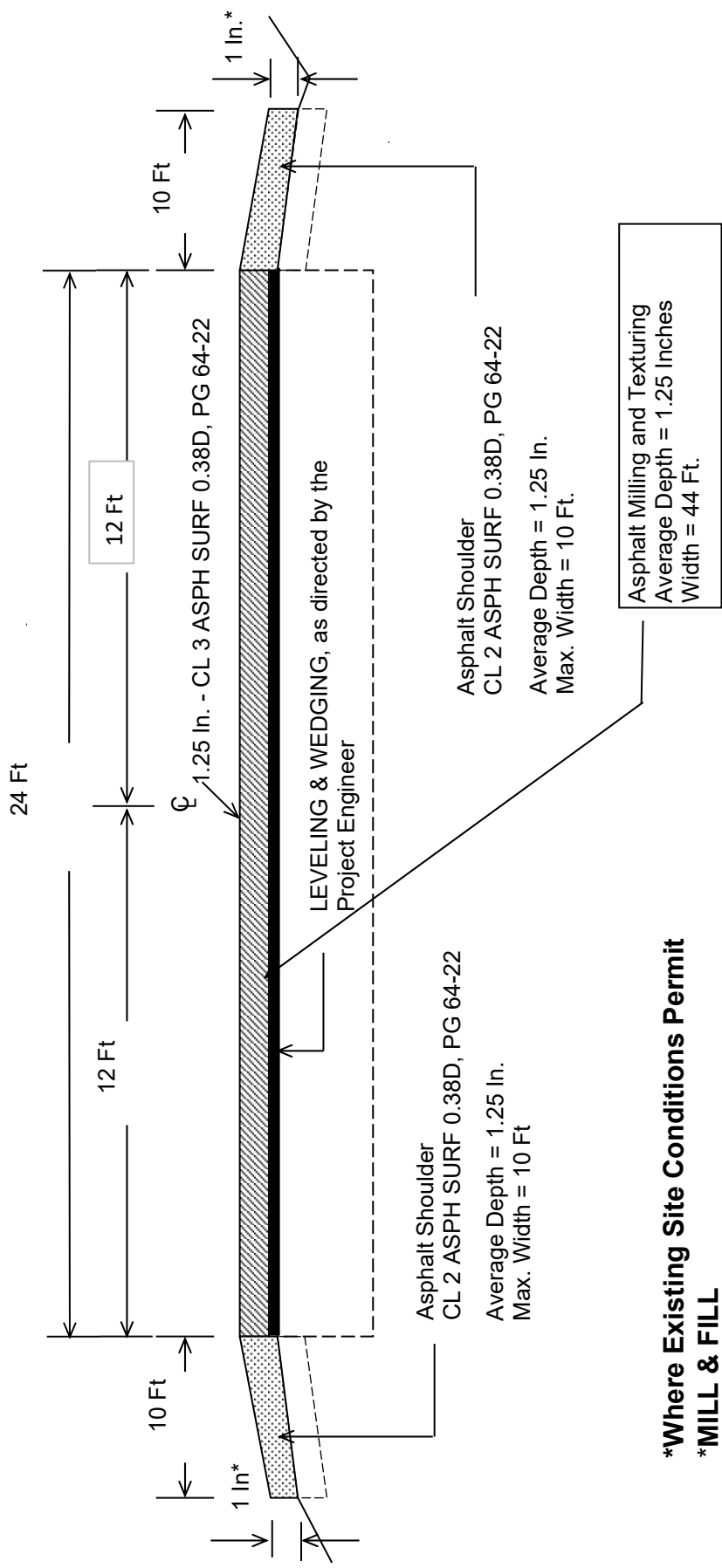

**\*Where Existing Site Conditions Permit  
\*MILL & FILL**

**ESTILL County  
TYPICAL SECTION  
FD05 033 1571 000-006  
MP's 0.000 to 5.580**

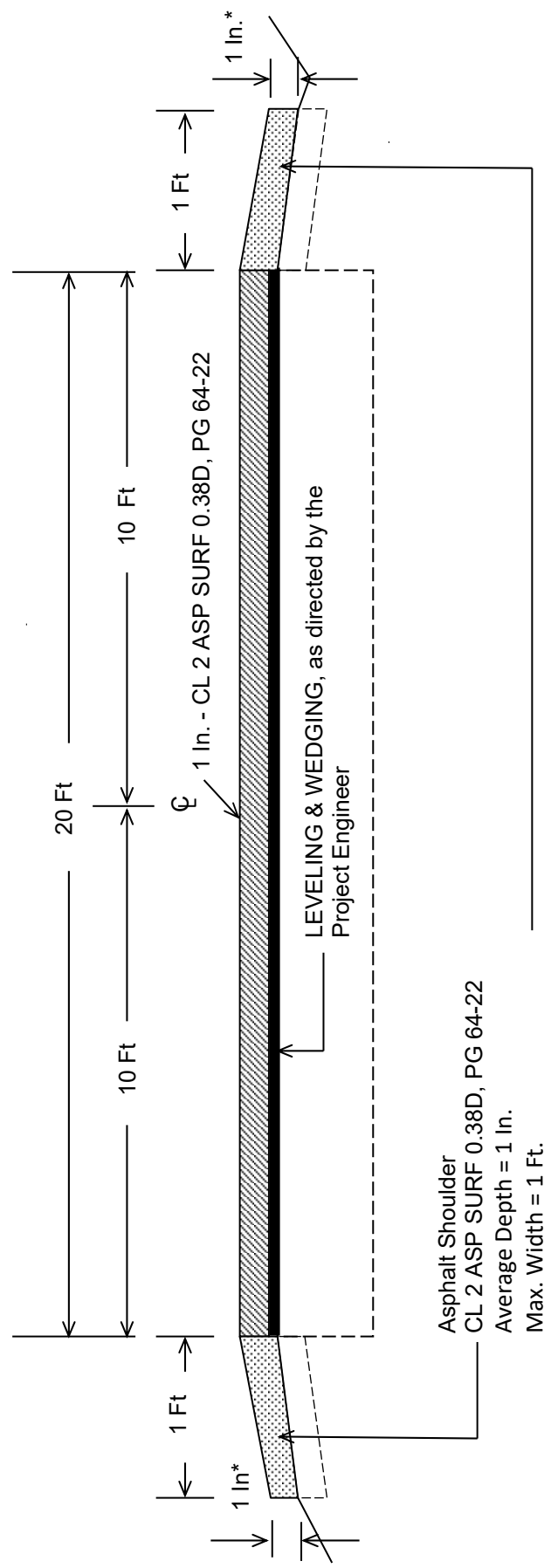

**\*Where Existing Site Conditions Permit**

County	Estill
Route	KY 52
Route	KY 89
MP	7.3
Date	3/07/2024

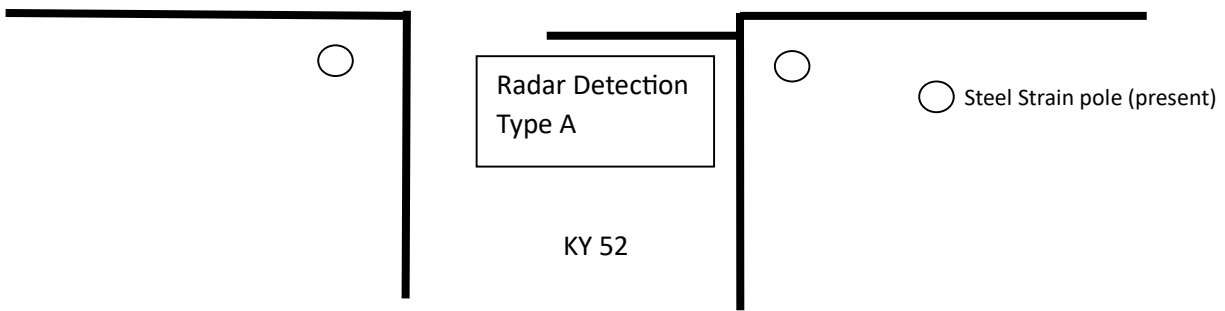
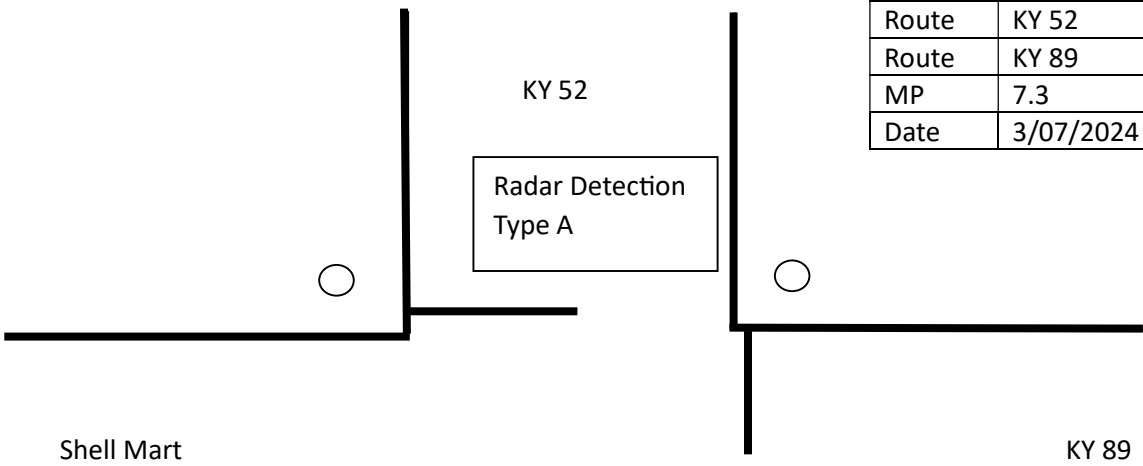

### Radar Estimates

Bid Item Code	Bid Item	Unit	EB Approach	WB Approach	NB Approach	SB Approach	Total
4830	Loop Wire	LF					0
4850	Cable No. 14/1 pair	LF					0
4895	Loop saw slot and fill	LF					0
4792	Conduit 1" (RS)	LF					0
24900EC	PVC Conduit (1 1/4") sch 80	LF					0
24901EC	PVC Conduit (2") sch 80	LF					0
4795	Conduit 2" (RS)	LF					0
4820	Trenching and Backfilling	LF					0
4821	Open cut	LF					0
21543EN	Bore and Jack Conduit	LF					0
4811	Junction Box Type B	Ea					0
24963ED	Loop Test	Ea					0
24955ED	Remove Signal Equipment	Ea					0
4960	Remove and replace sidewalk	SQYD					0
24119EC	Install Radar Presence Detector Type A	Ea	0	0	1	1	2
26120EC	Install Radar Presence Detector Type B	Ea					0

Comments:

NOTE:

- 1.) Quantities are for estimating purposes only. The Contractor shall field measure and insepect.
- 2.) Provide as-builts to District 10 Traffic.

County	Estill
Route	KY 52
Route	KY 1645
MP	7.83
Date	3/07/2024

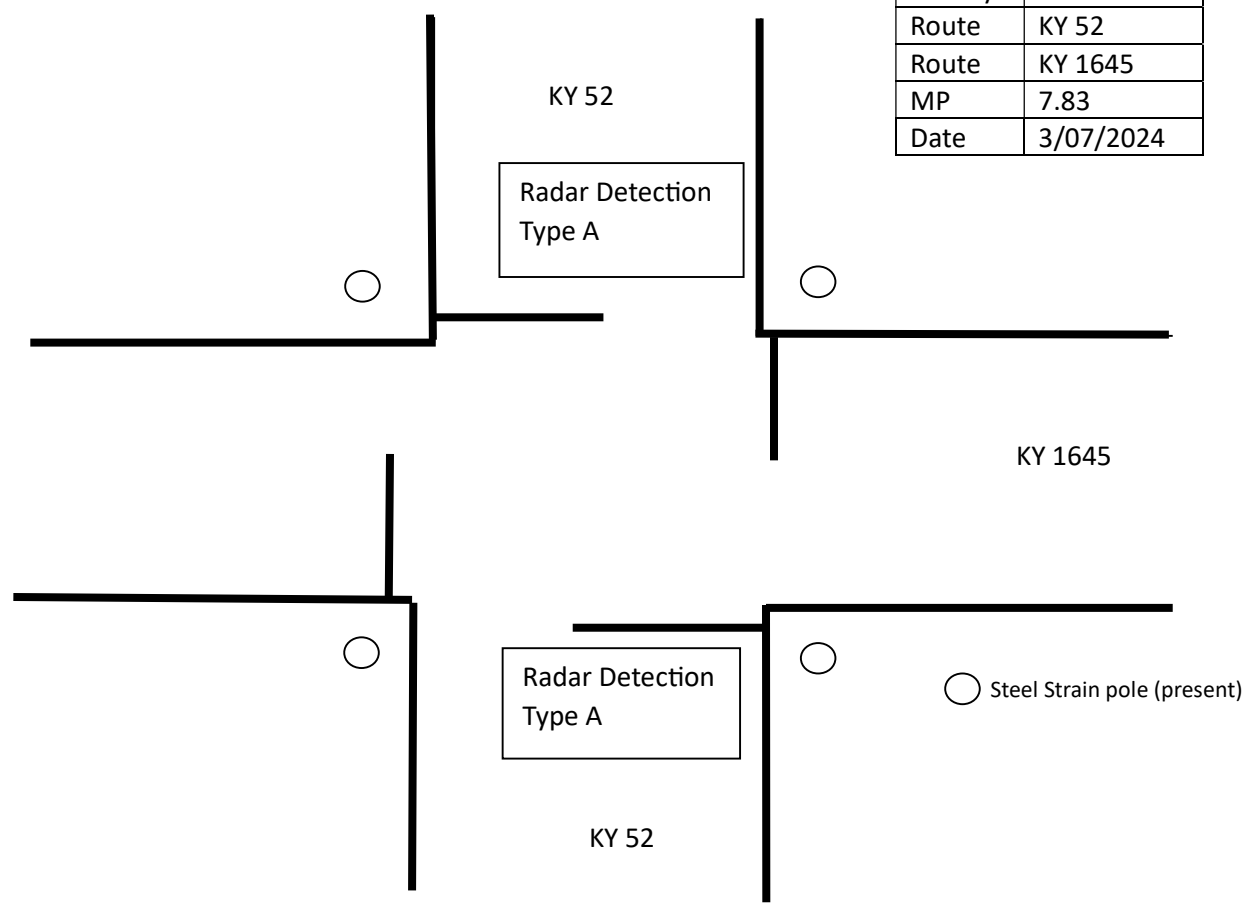

### Radar Estimates

Bid Item Code	Bid Item	Unit	EB Approach	WB Approach	NB Approach	SB Approach	Total
4830	Loop Wire	LF					0
4850	Cable No. 14/1 pair	LF					0
4895	Loop saw slot and fill	LF					0
4792	Conduit 1" (RS)	LF					0
24900EC	PVC Conduit (1 1/4") sch 80	LF					0
24901EC	PVC Conduit (2") sch 80	LF					0
4795	Conduit 2" (RS)	LF					0
4820	Trenching and Backfilling	LF					0
4821	Open cut	LF					0
21543EN	Bore and Jack Conduit	LF					0
4811	Junction Box Type B	Ea					0
24963ED	Loop Test	Ea					0
24955ED	Remove Signal Equipment	Ea					0
4960	Remove and replace sidewalk	SQYD					0
24119EC	Install Radar Presence Detector Type A	Ea	0	0	1	1	2
26120EC	Install Radar Presence Detector Type B	Ea					0

Comments:

NOTE:

- 1.) Quantities are for estimating purposes only. The Contractor shall field measure and insepect.
- 2.) Provide as-builts to District 10 Traffic.



County	Estill
Route	KY 52
Route	Madison Ave
MP	8.1
Date	3/07/2024

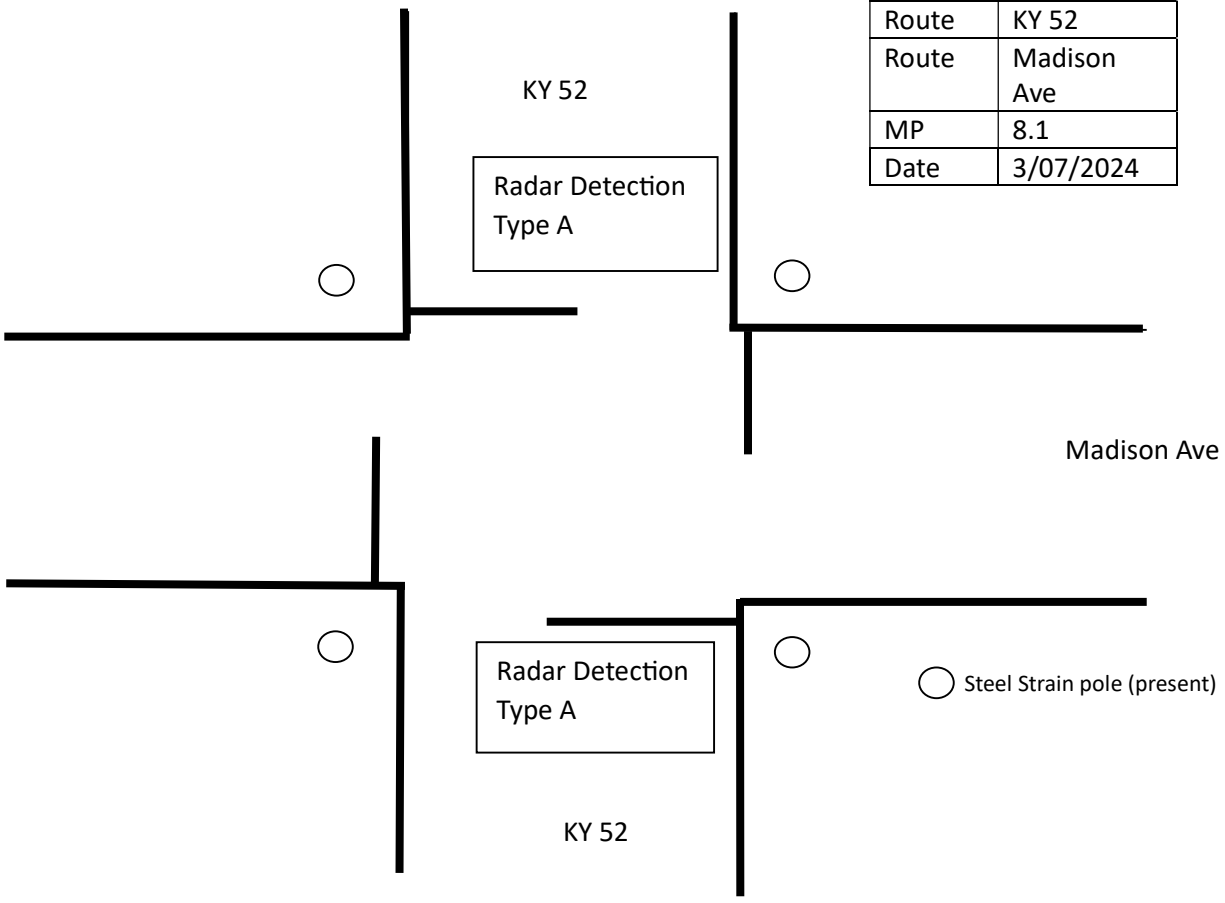

### Radar Estimates

Bid Item Code	Bid Item	Unit	EB Approach	WB Approach	NB Approach	SB Approach	Total
4830	Loop Wire	LF					0
4850	Cable No. 14/1 pair	LF					0
4895	Loop saw slot and fill	LF					0
4792	Conduit 1" (RS)	LF					0
24900EC	PVC Conduit (1 1/4") sch 80	LF					0
24901EC	PVC Conduit (2") sch 80	LF					0
4795	Conduit 2" (RS)	LF					0
4820	Trenching and Backfilling	LF					0
4821	Open cut	LF					0
21543EN	Bore and Jack Conduit	LF					0
4811	Junction Box Type B	Ea					0
24963ED	Loop Test	Ea					0
24955ED	Remove Signal Equipment	Ea					0
4960	Remove and replace sidewalk	SQYD					0
24119EC	Install Radar Presence Detector Type A	Ea	0	0	1	1	2
26120EC	Install Radar Presence Detector Type B	Ea					0

Comments:

NOTE:

- 1.) Quantities are for estimating purposes only. The Contractor shall field measure and insepect.
- 2.) Provide as-builts to District 10 Traffic.



**CONSTRUCTION DETAIL FOR BRIDGE WITHIN LIMITS OF  
PAVING PROJECT  
FD05 033 1571 000-006**

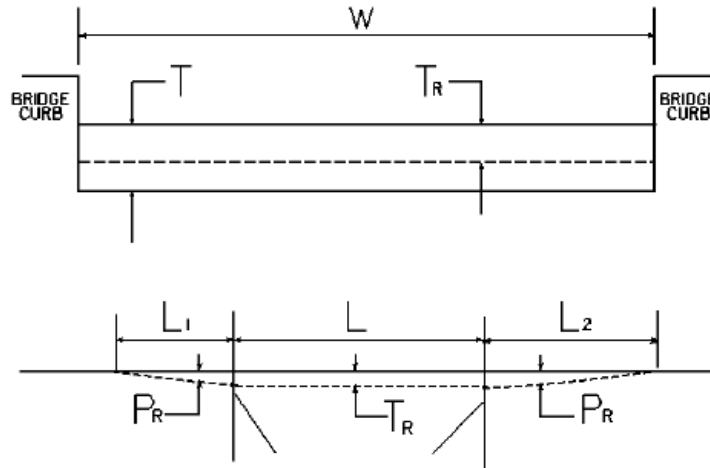

**W** = bridge width curb to curb                      **T** = thickness of existing bituminous overlay                      **L** = length of bridge  
**L<sub>1</sub> & L<sub>2</sub>** = length of approach pavement to be removed  
**T<sub>R</sub>** = thickness to be removed and replaced on bridge                      **P<sub>R</sub>** = thickness to be removed and replaced on pavement  
**Note:** **L<sub>1</sub> & L<sub>2</sub>** lengths shall be determined by using a transition rate of 100 ft / inch of thickness

BRIDGE NO	MP	W (ft)	T (in)	L <sub>1</sub> (ft)	L <sub>2</sub> (ft)	T <sub>R</sub> (in)	L (ft)	P <sub>R</sub> (in)
B00027N	0.390	13.50	0.00	100.00	100.00	0.00	166.00	1.00
B00035N	4.620	27.00	0.00	100.00	100.00	0.00	259.00	1.00
B00019N	5.410	22.00	0.00	100.00	100.00	0.00	165.00	1.00

**PART II**  
**SPECIFICATIONS AND STANDARD DRAWINGS**

### **STANDARD SPECIFICATIONS**

Any reference in the plans or proposal to previous editions of the *Standard Specifications for Road and Bridge Construction* and *Standard Drawings* are superseded by *Standard Specifications for Road and Bridge Construction, Edition of 2019* and *Standard Drawings, Edition of 2020*.

### **SUPPLEMENTAL SPECIFICATIONS**

The contractor shall use the Supplemental Specifications that are effective at the time of letting. The Supplemental Specifications can be found at the following link:  
<http://transportation.ky.gov/Construction/Pages/Kentucky-Standard-Specifications.aspx>

### **SPECIAL NOTE FOR PORTABLE CHANGEABLE MESSAGE SIGNS**

This Special Note will apply when indicated on the plans or in the proposal.

**1.0 DESCRIPTION.** Furnish, install, operate, and maintain variable message signs at the locations shown on the plans or designated by the Engineer. Remove and retain possession of variable message signs when they are no longer needed on the project.

#### **2.0 MATERIALS.**

**2.1 General.** Use LED Variable Message Signs Class I, II, or III, as appropriate, from the Department's List of Approved Materials.

Unclassified signs may be submitted for approval by the Engineer. The Engineer may require a daytime and nighttime demonstration. The Engineer will make a final decision within 30 days after all required information is received.

**2.2 Sign and Controls.** All signs must:

- 1) Provide 3-line messages with each line being 8 characters long and at least 18 inches tall. Each character comprises 35 pixels.
- 2) Provide at least 40 preprogrammed messages available for use at any time. Provide for quick and easy change of the displayed message; editing of the message; and additions of new messages.
- 3) Provide a controller consisting of:
  - a) Keyboard or keypad.
  - b) Readout that mimics the actual sign display. (When LCD or LCD type readout is used, include backlighting and heating or otherwise arrange for viewing in cold temperatures.)
  - c) Non-volatile memory or suitable memory with battery backup for storing pre-programmed messages.
  - d) Logic circuitry to control the sequence of messages and flash rate.
- 4) Provide a serial interface that is capable of supporting complete remote control ability through land line and cellular telephone operation. Include communication software capable of immediately updating the message, providing complete sign status, and allowing message library queries and updates.
- 5) Allow a single person easily to raise the sign to a satisfactory height above the pavement during use, and lower the sign during travel.
- 6) Be Highway Orange on all exterior surfaces of the trailer, supports, and controller cabinet.
- 7) Provide operation in ambient temperatures from -30 to + 120 degrees Fahrenheit during snow, rain and other inclement weather.
- 8) Provide the driver board as part of a module. All modules are interchangeable, and have plug and socket arrangements for disconnection and reconnection. Printed circuit boards associated with driver boards have a conformable coating to protect against moisture.
- 9) Provide a sign case sealed against rain, snow, dust, insects, etc. The lens is UV stabilized clear plastic (polycarbonate, acrylic, or other approved material) angled to prevent glare.
- 10) Provide a flat black UV protected coating on the sign hardware, character PCB, and appropriate lens areas.
- 11) Provide a photocell control to provide automatic dimming.

- 12) Allow an on-off flashing sequence at an adjustable rate.
- 13) Provide a sight to aim the message.
- 14) Provide a LED display color of approximately 590 nm amber.
- 15) Provide a controller that is password protected.
- 16) Provide a security device that prevents unauthorized individuals from accessing the controller.
- 17) Provide the following 3-line messages preprogrammed and available for use when the sign unit begins operation:

/KEEP/RIGHT/=>=>=>/	/MIN/SPEED/**MPH/
/KEEP/LEFT/<=<=</	/ICY/BRIDGE/AHEAD/ /ONE
/LOOSE/GRAVEL/AHEAD/	LANE/BRIDGE/AHEAD/
/RD WORK/NEXT/**MILES/	/ROUGH/ROAD/AHEAD/
/TWO WAY/TRAFFIC/AHEAD/	/MERGING/TRAFFIC/AHEAD/
/PAINT/CREW/AHEAD/	/NEXT/***/MILES/
/REDUCE/SPEED/**MPH/	/HEAVY/TRAFFIC/AHEAD/
/BRIDGE/WORK/***0 FT/	/SPEED/LIMIT/**MPH/
/MAX/SPEED/**MPH/	/BUMP/AHEAD/
/SURVEY/PARTY/AHEAD/	/TWO/WAY/TRAFFIC/

\*Insert numerals as directed by the Engineer.  
Add other messages during the project when required by the Engineer.

**2.3 Power.**

- 1) Design solar panels to yield 10 percent or greater additional charge than sign consumption. Provide direct wiring for operation of the sign or arrow board from an external power source to provide energy backup for 21 days without sunlight and an on-board system charger with the ability to recharge completely discharged batteries in 24 hours.

**3.0 CONSTRUCTION.** Furnish and operate the variable message signs as designated on the plans or by the Engineer. Ensure the bottom of the message panel is a minimum of 7 feet above the roadway in urban areas and 5 feet above in rural areas when operating. Use Class I, II, or III signs on roads with a speed limit less than 55 mph. Use Class I or II signs on roads with speed limits 55 mph or greater.

Maintain the sign in proper working order, including repair of any damage done by others, until completion of the project. When the sign becomes inoperative, immediately repair or replace the sign. Repetitive problems with the same unit will be cause for rejection and replacement.

Use only project related messages and messages directed by the Engineer, unnecessary messages lessen the impact of the sign. Ensure the message is displayed in either one or 2 phases with each phase having no more than 3 lines of text. When no message is needed, but it is necessary to know if the sign is operable, flash only a pixel.

When the sign is not needed, move it outside the clear zone or where the Engineer directs. Variable Message Signs are the property of the Contractor and shall be removed from the project when no longer needed. The Department will not assume ownership of these signs.

**4.0 MEASUREMENT.** The final quantity of Variable Message Sign will be



11

the actual number of individual signs acceptably furnished and operated during the project. The Department will not measure signs replaced due to damage or rejection.

**5.0 PAYMENT.** The Department will pay for the Variable Message Signs at the unit price each. The Department will not pay for signs replaced due to damage or rejection. Payment is full compensation for furnishing all materials, labor, equipment, and service necessary to, operate, move, repair, and maintain or replace the variable message signs. The Department will make payment for the completed and accepted quantities under the following:

<u>Code</u>	<u>Pay Item</u>	<u>Pay Unit</u>
02671	Portable Changeable Message Sign	Each

Effective June 15, 2012

## 2020 KENTUCKY STANDARD DRAWINGS

---

MISCELLANEOUS STANDARDS.....	RGX-001-06
DETECTABLE WARNINGS .....	RGX-040-03
APPROACHES, ENTRANCES, AND MAIL BOX TURNOUT .....	RPM-110-07
PAVEMENT STRIPING DETAILS FOR TWO LANE TWO WAY ROADWAYS .....	TPM-175
EDGELINE RUMBLE STRIP DETAILS TWO LANE ROADWAYS .....	TPR-120
LANE CLOSURE TWO-LANE HIGHWAY .....	TTC-100-05
LANE CLOSURE MULTI-LANE HIGHWAY CASE I.....	TTC-115-04
LANE CLOSURE MULTI-LANE HIGHWAY CASE II .....	TTC-120-04
SHOULDER CLOSURE .....	TTC-135-03
PAVEMENT CONDITION WARNING SIGNS.....	TTD-125-06
MOBILE OPERATION FOR PAINT STRIPING CASE I .....	TTS-100-02
MOBILE OPERATION FOR PAINT STRIPING CASE II.....	TTS-105-02
MOBILE OPERATION FOR DURABLE STRIPING CASE III.....	TTS-130-02
MOBILE OPERATION FOR DURABLE STRIPING CASE IV .....	TTS-135-02

## **PART III**

### **EMPLOYMENT, WAGE AND RECORD REQUIREMENTS**

**TRANSPORTATION CABINET  
DEPARTMENT OF HIGHWAYS**

**LABOR AND WAGE REQUIREMENTS  
APPLICABLE TO OTHER THAN FEDERAL-AID SYSTEM PROJECTS**

- I. Application
- II. Nondiscrimination of Employees (KRS 344)

**I. APPLICATION**

1. These contract provisions shall apply to all work performed on the contract by the contractor with his own organization and with the assistance of workmen under his immediate superintendence and to all work performed on the contract by piecework, station work or by subcontract. The contractor's organization shall be construed to include only workmen employed and paid directly by the contractor and equipment owned or rented by him, with or without operators.

2. The contractor shall insert in each of his subcontracts all of the stipulations contained in these Required Provisions and such other stipulations as may be required.

3. A breach of any of the stipulations contained in these Required Provisions may be grounds for termination of the contract.

3. If the contractor is in control of apprenticeship or other training or retraining, including on-the-job training programs, he shall not discriminate against an individual because of his race, color, religion, national origin, sex, disability or age forty (40) and over, in admission to, or employment in any program established to provide apprenticeship or other training.

4. The contractor will send to each labor union or representative of workers with which he has a collective bargaining agreement or other contract or understanding, a notice to be provided advising the said labor union or workers' representative of the contractor's commitments under this section, and shall post copies of the notice in conspicuous places available to employees and applicants for employment. The contractor will take such action with respect to any subcontract or purchase order as the administrating agency may direct as a means of enforcing such provisions, including sanctions for non-compliance.

Revised: January 25, 2017

**II. NONDISCRIMINATION OF EMPLOYEES**

**AN ACT OF THE KENTUCKY  
GENERAL ASSEMBLY TO PREVENT  
DISCRIMINATION IN EMPLOYMENT  
KRS CHAPTER 344  
EFFECTIVE JUNE 16, 1972**

The contract on this project, in accordance with KRS Chapter 344, provides that during the performance of this contract, the contractor agrees as follows:

1. The contractor shall not fail or refuse to hire, or shall not discharge any individual, or otherwise discriminate against an individual with respect to his compensation, terms, conditions, or privileges of employment, because of such individual's race, color, religion, national origin, sex, disability or age (forty and above); or limit, segregate, or classify his employees in any way which would deprive or tend to deprive an individual of employment opportunities or otherwise adversely affect his status as an employee, because of such individual's race, color, religion, national origin, sex, disability or age forty (40) and over. The contractor agrees to post in conspicuous places, available to employees and applicants for employment, notices to be provided setting forth the provisions of this nondiscrimination clause.

2. The contractor shall not print or publish or cause to be printed or published a notice or advertisement relating to employment by such an employer or membership in or any classification or referral for employment by the employment agency, indicating any preference, limitation, specification, or discrimination, based on race, color, religion, national origin, sex, or age forty (40) and over, or because the person is a qualified individual with a disability, except that such a notice or advertisement may indicate a preference, limitation, or specification based on religion, national origin, sex, or age forty (40) and over, or because the person is a qualified individual with a disability, when religion, national origin, sex, or age forty (40) and over, or because the person is a qualified individual with a disability, is a bona fide occupational qualification for employment.

## EXECUTIVE BRANCH CODE OF ETHICS

In the 1992 regular legislative session, the General Assembly passed and Governor Brereton Jones signed Senate Bill 63 (codified as KRS 11A), the Executive Branch Code of Ethics, which states, in part:

KRS 11A.040 (7) provides:

No present or former public servant shall, within six (6) months following termination of his office or employment, accept employment, compensation, or other economic benefit from any person or business that contracts or does business with, or is regulated by, the state in matters in which he was directly involved during the last thirty-six (36) months of his tenure. This provision shall not prohibit an individual from returning to the same business, firm, occupation, or profession in which he was involved prior to taking office or beginning his term of employment, or for which he received, prior to his state employment, a professional degree or license, provided that, for a period of six (6) months, he personally refrains from working on any matter in which he was directly involved during the last thirty-six (36) months of his tenure in state government. This subsection shall not prohibit the performance of ministerial functions, including but not limited to filing tax returns, filing applications for permits or licenses, or filing incorporation papers, nor shall it prohibit the former officer or public servant from receiving public funds disbursed through entitlement programs.

KRS 11A.040 (9) states:

A former public servant shall not represent a person or business before a state agency in a matter in which the former public servant was directly involved during the last thirty-six (36) months of his tenure, for a period of one (1) year after the latter of:

- a) The date of leaving office or termination of employment; or
- b) The date the term of office expires to which the public servant was elected.

This law is intended to promote public confidence in the integrity of state government and to declare as public policy the idea that state employees should view their work as a public trust and not as a way to obtain private benefits.

If you have worked for the executive branch of state government within the past six months, you may be subject to the law's prohibitions. The law's applicability may be different if you hold elected office or are contemplating representation of another before a state agency.

Also, if you are affiliated with a firm which does business with the state and which employs former state executive-branch employees, you should be aware that the law may apply to them.

In case of doubt, the law permits you to request an advisory opinion from the Executive Branch Ethics Commission, 1025 Capital Center Drive, Suite 104, Frankfort, Kentucky 40601; telephone (502) 564-7954.

Revised: May 23, 2022

### **Kentucky Equal Employment Opportunity Act of 1978**

The requirements of the Kentucky Equal Employment Opportunity Act of 1978 (KRS 45.560-45.640) shall apply to this Contract. The apparent low Bidder will be required to submit EEO forms to the Division of Construction Procurement, which will then forward to the Finance and Administration Cabinet for review and approval. No award will become effective until all forms are submitted and EEO/CC has certified compliance. The required EEO forms are as follows:

- EEO-1: Employer Information Report
- Affidavit of Intent to Comply
- Employee Data Sheet
- Subcontractor Report

These forms are available on the Finance and Administration's web page under ***Vendor Information, Standard Attachments and General Terms*** at the following address:  
**<https://www.eProcurement.ky.gov>**.

Bidders currently certified as being in compliance by the Finance and Administration Cabinet may submit a copy of their approval letter in lieu of the referenced EEO forms.

For questions or assistance please contact the Finance and Administration Cabinet by email at **[finance.contractcompliance@ky.gov](mailto:finance.contractcompliance@ky.gov)** or by phone at 502-564-2874.

# EMPLOYEE RIGHTS UNDER THE FAIR LABOR STANDARDS ACT

THE UNITED STATES DEPARTMENT OF LABOR WAGE AND HOUR DIVISION

## FEDERAL MINIMUM WAGE

# \$7.25 PER HOUR

BEGINNING JULY 24, 2009

**OVERTIME PAY** At least 1½ times your regular rate of pay for all hours worked over 40 in a workweek.

**CHILD LABOR** An employee must be at least **16** years old to work in most non-farm jobs and at least **18** to work in non-farm jobs declared hazardous by the Secretary of Labor.

Youths **14** and **15** years old may work outside school hours in various non-manufacturing, non-mining, non-hazardous jobs under the following conditions:

**No more than**

- **3** hours on a school day or **18** hours in a school week;
- **8** hours on a non-school day or **40** hours in a non-school week.

Also, work may not begin before **7 a.m.** or end after **7 p.m.**, except from June 1 through Labor Day, when evening hours are extended to **9 p.m.** Different rules apply in agricultural employment.

**TIP CREDIT** Employers of “tipped employees” must pay a cash wage of at least \$2.13 per hour if they claim a tip credit against their minimum wage obligation. If an employee’s tips combined with the employer’s cash wage of at least \$2.13 per hour do not equal the minimum hourly wage, the employer must make up the difference. Certain other conditions must also be met.

**ENFORCEMENT** The Department of Labor may recover back wages either administratively or through court action, for the employees that have been underpaid in violation of the law. Violations may result in civil or criminal action.

Employers may be assessed civil money penalties of up to \$1,100 for each willful or repeated violation of the minimum wage or overtime pay provisions of the law and up to \$11,000 for each employee who is the subject of a violation of the Act’s child labor provisions. In addition, a civil money penalty of up to \$50,000 may be assessed for each child labor violation that causes the death or serious injury of any minor employee, and such assessments may be doubled, up to \$100,000, when the violations are determined to be willful or repeated. The law also prohibits discriminating against or discharging workers who file a complaint or participate in any proceeding under the Act.

### ADDITIONAL INFORMATION

- Certain occupations and establishments are exempt from the minimum wage and/or overtime pay provisions.
- Special provisions apply to workers in American Samoa and the Commonwealth of the Northern Mariana Islands.
- Some state laws provide greater employee protections; employers must comply with both.
- The law requires employers to display this poster where employees can readily see it.
- Employees under 20 years of age may be paid \$4.25 per hour during their first 90 consecutive calendar days of employment with an employer.
- Certain full-time students, student learners, apprentices, and workers with disabilities may be paid less than the minimum wage under special certificates issued by the Department of Labor.

For additional information:



# 1-866-4-USWAGE

(1-866-487-9243) TTY: 1-877-889-5627



# WWW.WAGEHOUR.DOL.GOV

**PART IV**  
**INSURANCE**

Refer to  
*Kentucky Standard Specifications for Road and Bridge Construction,*  
current edition



**PART V**  
**BID ITEMS**

**PROPOSAL BID ITEMS**

242155

Page 1 of 1

Report Date 3/21/24

**Section: 0001 - ROADWAY**

LINE	BID CODE	ALT	DESCRIPTION	QUANTITY	UNIT	UNIT PRIC	FP	AMOUNT
0010	00190		LEVELING & WEDGING PG64-22	1,068.00	TON		\$	
0020	00212		CL2 ASPH BASE 1.00D PG64-22	140.00	TON		\$	
0030	00301		CL2 ASPH SURF 0.38D PG64-22	4,680.00	TON		\$	
0040	00388		CL3 ASPH SURF 0.38B PG64-22	2,900.00	TON		\$	
0050	02562		TEMPORARY SIGNS	1,600.00	SQFT		\$	
0060	02650		MAINTAIN & CONTROL TRAFFIC (KY 1571)	1.00	LS		\$	
0070	02650		MAINTAIN & CONTROL TRAFFIC (KY 52)	1.00	LS		\$	
0080	02671		PORTABLE CHANGEABLE MESSAGE SIGN	4.00	EACH		\$	
0090	02676		MOBILIZATION FOR MILL & TEXT (KY 1571)	1.00	LS		\$	
0100	02676		MOBILIZATION FOR MILL & TEXT (KY 52)	1.00	LS		\$	
0110	02677		ASPHALT PAVE MILLING & TEXTURING	3,520.00	TON		\$	
0120	02697		EDGE LINE RUMBLE STRIPS	58,300.00	LF		\$	
0130	06510		PAVE STRIPING-TEMP PAINT-4 IN	107,400.00	LF		\$	
0140	06515		PAVE STRIPING-PERM PAINT-6 IN	117,850.00	LF		\$	
0150	06542		PAVE STRIPING-THERMO-6 IN W	22,039.00	LF		\$	
0160	06543		PAVE STRIPING-THERMO-6 IN Y	35,360.00	LF		\$	
0170	06562		PAVE MARKING-THERMO R 6 FT	4.00	EACH		\$	
0180	06563		PAVE MARKING-R/R XBUCKS 16 IN	144.00	LF		\$	
0190	06565		PAVE MARKING-THERMO X-WALK-6 IN	520.00	LF		\$	
0200	06568		PAVE MARKING-THERMO STOP BAR-24IN	248.00	LF		\$	
0210	06569		PAVE MARKING-THERMO CROSS-HATCH	283.00	SQFT		\$	
0220	06573		PAVE MARKING-THERMO STR ARROW	2.00	EACH		\$	
0230	06574		PAVE MARKING-THERMO CURV ARROW	16.00	EACH		\$	
0240	10020NS		FUEL ADJUSTMENT	13,640.00	DOLL	\$1.00	\$	\$13,640.00
0250	10030NS		ASPHALT ADJUSTMENT	34,710.00	DOLL	\$1.00	\$	\$34,710.00
0260	24880EC		REMOVE PAVEMENT MARKER	450.00	EACH		\$	
0270	24970EC		ASPHALT MATERIAL FOR TACK NON- TRACKING	52.00	TON		\$	
0280	26119EC		INSTALL RADAR PRESENCE DETECTOR TYPE A	6.00	EACH		\$	
0290	26228EC		ELECTRONIC DELIVERY MGMT SYSTEM (KY 1571)	1.00	LS		\$	
0300	26228EC		ELECTRONIC DELIVERY MGMT SYSTEM (KY 52)	1.00	LS		\$	

**Section: 0002 - DEMOBILIZATION**

LINE	BID CODE	ALT	DESCRIPTION	QUANTITY	UNIT	UNIT PRIC	FP	AMOUNT
0310	02569		DEMOBILIZATION	1.00	LS		\$	