



CALL NO. 333

CONTRACT ID. 192045

HARLAN COUNTY

FED/STATE PROJECT NUMBER FD05 048 0421 007-015

DESCRIPTION HARLAN - VIRGINIA ROAD (US 421)

WORK TYPE ASPHALT RESURFACING

PRIMARY COMPLETION DATE 11/15/2019

LETTING DATE: January 25,2019

Sealed Bids will be received electronically through the Bid Express bidding service until 10:00 AM EASTERN STANDARD TIME January 25,2019. Bids will be publicly announced at 10:00 AM EASTERN STANDARD TIME.

NO PLANS ASSOCIATED WITH THIS PROJECT.

REQUIRED BID PROPOSAL GUARANTY: Not less than 5% of the total bid.

TABLE OF CONTENTS

PART I	SCOPE OF WORK
	<ul style="list-style-type: none">• PROJECT(S), COMPLETION DATE(S), & LIQUIDATED DAMAGES• CONTRACT NOTES• STATE CONTRACT NOTES• SURFACING AREAS• ASPHALT MIXTURE• INCIDENTAL SURFACING• FUEL AND ASPHALT PAY ADJUSTMENT• COMPACTION OPTION A• MATERIAL TRANSFER VEHICLE (MTV)• SPECIAL NOTE(S) APPLICABLE TO PROJECT• WASTE AND BORROW SITES• ASPHALT MIXTURE FOR PAVEMENT WEDGE• EDGE KEY (BY TON)• ASPHALT MILLING AND TEXTURING• BASE FAILURE REPAIR• TRAFFIC ISLAND REMOVAL• TYPICAL SECTION DIMENSIONS• TRAFFIC CONTROL PLAN 2 LANE• DURABLE PAVEMENT EDGE DETAILS• TRAFFIC SIGNAL LOOP DETECTORS• SKETCH MAP(S)• SUMMARY SHEET(S)• TYPICAL SECTION(S)• BRIDGE DETAIL FOR PAVING PROJECT
PART II	SPECIFICATIONS AND STANDARD DRAWINGS
	<ul style="list-style-type: none">• SPECIFICATIONS REFERENCE• SUPPLEMENTAL SPECIFICATION• [SN-11] PORTABLE CHANGEABLE SIGNS• 2016 STANDARD DRAWINGS THAT APPLY• CENTERLINE RUMBLE STRIPS• CENTERLINE RUMBLE STRIP 4 INCH STRIPING• SHOULDER AND EDGE LINE RUMBLE STRIP DETAILS• SHOULDER RUMBLE STRIP DETAILS TWO LANE ROADWAYS
PART III	EMPLOYMENT, WAGE AND RECORD REQUIREMENTS
	<ul style="list-style-type: none">• LABOR AND WAGE REQUIREMENTS• EXECUTIVE BRANCH CODE OF ETHICS• KENTUCKY EQUAL EMPLOYMENT OPPORTUNITY ACT OF 1978 LOCALITY / STATE• PROJECT WAGE RATES / STATE
PART IV	INSURANCE
PART V	BID ITEMS

PART I
SCOPE OF WORK

ADMINISTRATIVE DISTRICT - 11

CONTRACT ID - 192045

FD05 048 0421 007-015

COUNTY - HARLAN

PCN - MP04804211801

FD05 048 0421 007-015

HARLAN - VIRGINIA ROAD (US 421) (MP 7.278) BEGINNING AT MARTINS FORK BRIDGE EXTENDING
NORTHERLY TO WALDON DRIVE (MP 14.103), A DISTANCE OF 06.83 MILES.ASPHALT RESURFACING
GEOGRAPHIC COORDINATES LATITUDE 36:48:16.00 LONGITUDE 83:16:15.00

COMPLETION DATE(S):

COMPLETED BY 11/15/2019

APPLIES TO ENTIRE CONTRACT

CONTRACT NOTES

PROPOSAL ADDENDA

All addenda to this proposal must be applied when calculating bid and certified in the bid packet submitted to the Kentucky Department of Highways. Failure to use the correct and most recent addenda may result in the bid being rejected.

BID SUBMITTAL

Bidder must use the Department's electronic bidding software. The Bidder must download the bid file located on the Bid Express website (www.bidx.com) to prepare a bid packet for submission to the Department. The bidder must submit electronically using Bid Express.

JOINT VENTURE BIDDING

Joint venture bidding is permissible. All companies in the joint venture must be prequalified in one of the work types in the Qualifications for Bidders for the project. The bidders must get a vendor ID for the joint venture from the Division of Construction Procurement and register the joint venture as a bidder on the project. Also, the joint venture must obtain a digital ID from Bid Express to submit a bid. A joint bid bond of 5% may be submitted for both companies or each company may submit a separate bond of 5%.

UNDERGROUND FACILITY DAMAGE PROTECTION

The contractor shall make every effort to protect underground facilities from damage as prescribed in the Underground Facility Damage Protection Act of 1994, Kentucky Revised Statute KRS 367.4901 to 367.4917. It is the contractor's responsibility to determine and take steps necessary to be in compliance with federal and state damage prevention directives. When prescribed in said directives, the contractor shall submit Excavation Locate Requests to the Kentucky Contact Center (KY811) via web ticket entry. The submission of this request does not relieve the contractor from the responsibility of contacting non-member facility owners, whom shall be contacted through their individual Protection Notification Center. Non-compliance with these directives can result in the enforcement of penalties.

REGISTRATION WITH THE SECRETARY OF STATE BY A FOREIGN ENTITY

Pursuant to KRS 176.085(1)(b), an agency, department, office, or political subdivision of the Commonwealth of Kentucky shall not award a state contract to a person that is a foreign entity required by [KRS 14A.9-010](#) to obtain a certificate of authority to transact business in the Commonwealth ("certificate") from the Secretary of State under [KRS 14A.9-030](#) unless the person produces the certificate within fourteen (14) days of the bid or proposal opening. If the foreign entity is not required to obtain a certificate as provided in [KRS 14A.9-010](#), the foreign entity should identify the applicable exception. Foreign entity is defined within [KRS 14A.1-070](#).

For all foreign entities required to obtain a certificate of authority to transact business in the Commonwealth, if a copy of the certificate is not received by the contracting agency within the time frame identified above, the foreign entity's solicitation response shall be deemed non-responsive or the awarded contract shall be cancelled.

Businesses can register with the Secretary of State at <https://secure.kentucky.gov/sos/ftbr/welcome.aspx>.

SPECIAL NOTE FOR PROJECT QUESTIONS DURING ADVERTISEMENT

Questions about projects during the advertisement should be submitted in writing to the Division of Construction Procurement. This may be done by fax (502) 564-7299 or email to kytc.projectquestions@ky.gov. The Department will attempt to answer all submitted questions. The Department reserves the right not to answer if the question is not pertinent or does not aid in clarifying the project intent.

The deadline for posting answers will be 3:00 pm Eastern Daylight Time, the day preceding the Letting. Questions may be submitted until this deadline with the understanding that the later a question is submitted, the less likely an answer will be able to be provided.

The questions and answers will be posted for each Letting under the heading "Questions & Answers" on the Construction Procurement website (www.transportation.ky.gov/contract). The answers provided shall be considered part of this Special Note and, in case of a discrepancy, will govern over all other bidding documents.

HARDWOOD REMOVAL RESTRICTIONS

The US Department of Agriculture has imposed a quarantine in Kentucky and several surrounding states, to prevent the spread of an invasive insect, the emerald ash borer. Hardwood cut in conjunction with the project may not be removed from the state. Chipping or burning on site is the preferred method of disposal.

INSTRUCTIONS FOR EXCESS MATERIAL SITES AND BORROW SITES

Identification of excess material sites and borrow sites shall be the responsibility of the Contractor. The Contractor shall be responsible for compliance with all applicable state and federal laws and may wish to consult with the US Fish and Wildlife Service to seek protection under Section 10 of the Endangered Species Act for these activities.

ACCESS TO RECORDS

The contractor, as defined in KRS 45A.030 (9) agrees that the contracting agency, the Finance and Administration Cabinet, the Auditor of Public Accounts, and the Legislative Research Commission, or their duly authorized representatives, shall have access to any books, documents, papers, records, or other evidence, which are directly pertinent to this contract for the purpose of financial audit or program review. Records and other prequalification information confidentially

disclosed as part of the bid process shall not be deemed as directly pertinent to the contract and shall be exempt from disclosure as provided in KRS 61.878(1)(c). The contractor also recognizes that any books, documents, papers, records, or other evidence, received during a financial audit or program review shall be subject to the Kentucky Open Records Act, KRS 61.870 to 61.884.

In the event of a dispute between the contractor and the contracting agency, Attorney General, or the Auditor of Public Accounts over documents that are eligible for production and review, the Finance and Administration Cabinet shall review the dispute and issue a determination, in accordance with Secretary's Order 11-004.

April 30, 2018

SPECIAL NOTE FOR RECIPROCAL PREFERENCE

RECIPROCAL PREFERENCE TO BE GIVEN BY PUBLIC AGENCIES TO RESIDENT BIDDERS

By reference, KRS 45A.490 to 45A.494 are incorporated herein and in compliance regarding the bidders residency. Bidders who want to claim resident bidder status should complete the Affidavit for Claiming Resident Bidder Status along with their bid in the electronic bidding software. Submittal of the Affidavit should be done along the bid in Bid Express.

April 30, 2018

SURFACING AREAS

The Department estimates the mainline surfacing width to be 24-68 feet.

The Department estimates the total mainline area to be surfaced to be 138,819 square yards.

The Department estimates the shoulder width to be 10 feet on each side.

The Department estimates the total shoulder area to be surfaced to be 74,870 square yards.

ASPHALT MIXTURE

Unless otherwise noted, the Department estimates the rate of application for all asphalt mixtures to be 110 lbs/sy per inch of depth.

INCIDENTAL SURFACING

The Department has included in the quantities of asphalt mixtures established in the proposal estimated quantities required for resurfacing or surfacing mailbox turnouts, farm field entrances, residential and commercial entrances, curve widening, ramp gores and tapers, and road and street approaches, as applicable. Pave these areas to the limits as shown on Standard Drawing RPM-110-06 or as directed by the Engineer. In the event signal detectors are present in the intersecting streets or roads, pave the crossroads to the right of way limit or back of the signal detector, whichever is the farthest back of the mainline. Surface or resurface these areas as directed by the Engineer. The Department will not measure placing and compacting for separate payment but shall be incidental to the Contract unit price for the asphalt mixtures.

FUEL AND ASPHALT PAY ADJUSTMENT

The Department has included the Contract items Asphalt Adjustment and Fuel Adjustment for possible future payments at an established Contract unit price of \$1.00. The Department will calculate actual adjustment quantities after work is completed. If existing Contract amount is insufficient to pay all items on the contract with the adjustments, the Department will establish additional monies with a change order.

OPTION A

Be advised that the Department will accept compaction of asphalt mixtures furnished for driving lanes and ramps, at 1 inch (25mm) or greater, on this project according to OPTION A in accordance with Section 402 and Section 403 of the current Standard Specifications. The Department will require joint cores as described in Section 402.03.02 for surface mixtures only. The Department will accept compaction of all other asphalt mixtures according to OPTION B.

MATERIAL TRANSFER VEHICLE (MTV)

Provide and use a MTV in accordance with Sections 403.02.10 and 403.03.05.

Special Note for Pavement Cross Slope in Island Removal Area

Median Area to be Paved in a manner to ensure proper drainage of roadway and prevent any water ponding from occurring.

SPECIAL NOTE FOR ACCEPTANCE OF STRIPING ON RESURFACING CONTRACTS

RETROREFLECTIVITY REQUIREMENTS

The minimum retroreflectivity requirements shall be in accordance with **Section 713.03.05A of the Standard Specifications**.

In addition to **Section 713.03.05C of the Standard Specifications**, re-stripe all markings failing to meet the minimum retroreflectivity requirements within 15 calendar days after notification by the Engineer except that no striping will be performed after **November 15, 2019**. All aspects of this specification shall apply to lines that are repainted due to failure to meet the minimum retroreflectivity requirements. Liquidated damages, as outlined in **Section 108.09 of the Standard Specifications**, shall be assessed for each day beyond the 15 calendar days that repainting is not completed and shall accrue until the **November 15, 2019** deadline. At that point, no additional striping will be performed and payment will be based upon the Payment Schedule.

MEASUREMENT AND PAYMENT

The Department will measure the quantity in linear feet.

The **ACCEPTANCE PAY SCHEDULE FOR PERMANENT STRIPING** listed in **Section 713.03.06 of the Specifications** will not apply. The Contractor will receive an initial payment of 70% of the bid item after initial application of striping to the section of roadway. No additional payment will be made for re-striping sections failing to meet the minimum retroreflectivity requirements. Payment of the remaining 30% will be based on the Payment Schedule in this Special Note.

Payment Schedule

	Initial Payment	Final Payment	Total Payment
Section is Accepted	70%	30%	100%
Section is Not Accepted	70%	0%	70%

SPECIAL NOTE FOR CRACK SEALING

The crack sealant shall be Crafcro Polyfiber Type III or approved equivalent. Crack sealing must be completed a minimum of 30 days prior to the overlay treatment. No sealant material shall be placed until the joints and cracks have been cleaned of all loose dirt and material using a minimum of 125 psi/ 100 cfm air compressor. After routing and cleaning, all joints and cracks shall be heat lanced to clean and remove moisture. The heat lance shall be a LAB Model B or approved equal capable of producing air temperatures up to 2500 F. Joints and cracks shall be inspected and approved by the Department prior to placing the sealant material. Final joint and crack cleaning and heat lancing shall not proceed in advance of sealing by more than 1/8 mile. The sealant container shall be a thermostatically controlled heated oil jacketed tank with the ability to agitate the sealant. Sealant shall be leveled or struck down with the use of a 3 inch disk attachment at the end of the wand applicator. The overband width of the hot applied modified crack sealant shall not exceed 3 inches in width or 1/8 inch in height above the surrounding pavement unless directed by the engineer. Glenzoil 20 Plus, Crafcro Detack or approved equal shall be sprayed on the placed sealant prior to opening to traffic at an application rate of approximately 1 gallon of Glenzoil 20 Plus/Crafcro Detack per 50 gallons of sealant. All debris from the work must be removed prior to opening to traffic.

SPECIAL PROVISION FOR WASTE AND BORROW SITES

Obtain U.S. Army Corps of Engineer's approval before utilizing a waste or borrow site that involves "Waters of the United States". The Corps of Engineers defines "Waters of the United States" as perennial or intermittent streams, ponds or wetlands. The Corps of Engineers also considers ephemeral streams, typically dry except during rainfall but having a defined drainage channel, to be jurisdictional waters. Direct questions concerning any potential impacts to "Waters of the United States" to the attention of the appropriate District Office for the Corps of Engineers for a determination prior to disturbance. Be responsible for any fees associated with obtaining approval for waste and borrow sites from the U.S. Army Corps of Engineer or other appropriate regulatory agencies.

1-296 Waste & Borrow Sites
01/02/2012

SPECIAL NOTE FOR PAVEMENT WEDGE AND SHOULDER SEPARATE OPERATION

1.0 MATERIALS. Provide an Asphalt Mixture for Pavement Wedge conforming to Section 407 of the Standard Specifications or an Asphalt Surface Mixture conforming to Section 403 of the Standard Specifications, as applicable to the project, for the pavement wedge.

2.0 CONSTRUCTION. Place the Asphalt Mixture for Pavement Wedge or Asphalt Surface Mixture as a separate operation from the driving lane. Prime the existing shoulder with tack material as the Engineer directs before placing the wedge. Construct according to Sections 407.03 and 403.03 as applicable.

When the Engineer deems it appropriate to pave both the driving lane and the adjoining wedge monolithically, equip the paver with a modified screed that extends the full width of the wedge being placed and is tapered to produce a wedge. Obtain the Engineer's approval of the modified screed before placing shoulder wedge monolithically with the driving lane.

The wedge may vary in thickness at the edge of the driving lanes. Where existing site conditions permit, limit the outside edge thickness of the new paving limits to one inch above the existing shoulder wedge elevation. If an Asphalt Surface Mixture is furnished for the pavement wedge, texture according to Section 403.03.08.

The following sketch is primarily for the computation of quantities; however, the wedge will result in a similar cross-section where sufficient width exists. Do not construct a shoulder for placing the wedge unless specified elsewhere in the Contract.

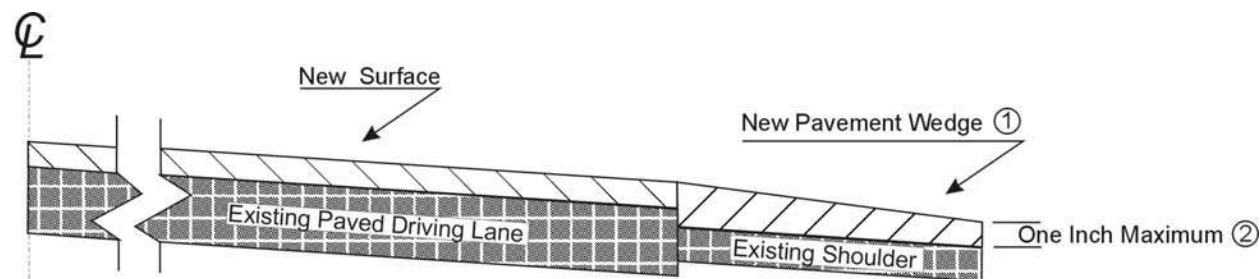

- ① Slope varies, but is down from the driving lanes except on outside of some curves where superelevation controls.
- ② Where existing site conditions permit.

3.0 MEASUREMENT. The Department will measure Asphalt Mixture for Pavement Wedge or Asphalt Surface Mixture placed as the pavement wedge according to Sections 403 and 407 as applicable.

4.0 PAYMENT. The Department will make payment for the completed and accepted quantities of Asphalt Surface Mixtures placed as pavement wedge according to Section 403. The Department will make payment for the completed and accepted quantities of Asphalt Mixture for Pavement Wedge according to Section 407.

SPECIAL NOTE FOR EDGE KEY

Construct Edge Keys at the beginning of project, end of project, at railroad crossings, and at ramps, as applicable. Unless specified in the Contract or directed by the Engineer, do not construct edge keys at intersecting streets, roads, alleys, or entrances. Cut out the existing asphalt surface to the required depth and width shown on the drawing and heel the new surface into the existing surface. The Department will make payment for this work at the Contract unit price per ton for Asphalt Pavement Milling and Texturing, which shall be full compensation for all labor, materials, equipment, and incidentals for removal and disposal of the existing asphalt surface required to construct the edge key.

EDGE KEY

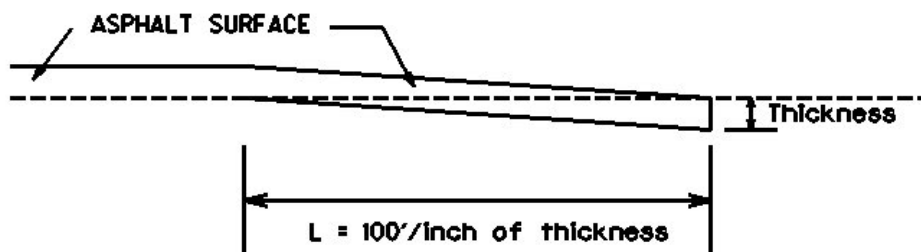

Thickness = **1.25** Inches

L = **125** LF

L= Length of Edge Key

1-3309 Edge key by Ton
01/02//2012

**SPECIAL NOTE FOR
ASPHALT MILLING AND TEXTURING**

Begin paving operations within **48 hours** of commencement of the milling operation. Continue paving operations continuously until completed. If paving operations are not begun within this time period, the Department will assess liquidated damages at the rate prescribed by Section 108.09 until such time as paving operations are begun.

Take possession of the millings and recycle the millings or dispose of the millings off the Right-of-Way at sites obtained by the Contractor at no additional cost to the Department.

1-3520 48 hours Contractor keeps millings
01/2/2012

SPECIAL NOTE FOR BASE FAILURE REPAIR

Repair locations listed on the summary are approximate only. The Engineer will determine actual repair locations and dimensions at the time of construction. Prior to overall milling and/or leveling and wedging, excavate the designated base failure areas by milling to a depth 4 inches below the existing asphalt pavement surface level. Dispose of the excavated materials at waste sites off the Right-of-Way obtained by the Contractor at no additional cost to the Department. See Special Note for Waste and Borrow.

Backfill the excavated areas with Class 2 Asphalt Base 1.00D PG 64-22. Compact the asphalt base to the compaction required in Section 403.03.10. Seal the asphalt base with leveling and wedging. Perform all base failure repairs in such a manner that removal and replacement are completed on the same day. Do this work as one of the Contractor's first operations in order to allow further compaction by traffic. Do not mill or place new asphalt surface over repaired base failure areas until a minimum of 7 calendar days have elapsed after placement of the asphalt base. After a minimum of 7 calendar days and when the Engineer determines the base failure repair areas have sufficiently stabilized, begin milling and/or resurfacing operations. Prior to milling and/or constructing the new asphalt surface, level and wedge any settlement of the repair areas.

The bidder must draw conclusions as to the conditions encountered. The Department does not give any guarantee as to the accuracy of the data and will not consider any claim for additional compensation if the materials encountered that are not in accord with the classification shown.

Accept payment at the Contract unit prices per ton for Asphalt Milling and Texturing, Asphalt Base, and Leveling and Wedging as full compensation for all labor, materials, equipment, and incidentals for removing pavement and disposing of the materials, furnishing and placing asphalt base, leveling and wedging, and all other items necessary to complete the work according to these notes to the satisfaction of the Engineer.

1-3605 basefailurerepairmillinlaypayton
01/02/2012

SPECIAL NOTES FOR TRAFFIC ISLAND REMOVAL

Remove existing traffic islands as shown on the drawings, listed in the summary, or as directed by the Engineer. Saw cut the existing pavement, asphalt surface, base, DGA and PCC pavement (if present). Excavate to an approximate depth of 6 inches below the bottom of the existing adjacent pavement level. Remove and dispose of all materials off the Right-of Way at sites obtained by the Contractor at no additional cost to the Department (see Special Note for Waste and Borrow). Do not damage existing culvert pipes and any existing underground utilities. Repair or restore any damaged items at no additional cost to the Department.

Backfill the excavated area with Class 2 Asphalt Base 1.00D PG64-22 in 3 inch maximum courses up to the existing pavement surface. Compact the asphalt base to the compaction required in Section 403.03.10. Seal the asphalt base with leveling and wedging. Perform all traffic island removal operations in such a manner that removal and replacement are completed on the same day. Do this work as one of the Contractor's first operations in order to allow further compaction by traffic. Do not mill or place new asphalt surface over repaired base failure areas until a minimum of 7 calendar days have elapsed after placement of the asphalt base. After a minimum of 7 calendar days and when the Engineer determines the base failure repair areas have sufficiently stabilized, begin milling and/or resurfacing operations. Prior to milling and/or constructing the new asphalt surface, level and wedge any settlement of the repair areas.

The bidder must draw conclusions as to the conditions encountered. The Department does not give any guarantee as to the accuracy of the data and will not consider any claim for additional compensation if the materials encountered that are not in accord with the classification shown.

Accept payment at the Contract unit prices per square yard for Remove Traffic Island and per ton for Asphalt Base as full compensation for all labor, materials, equipment, and incidentals for removing traffic island and disposing of the materials, furnishing and placing asphalt base, leveling and wedging, and all other items necessary to complete the work according to these notes to the satisfaction of the Engineer.

1-3640 removetrafficisland
01/02/2012

SPECIAL NOTE FOR TYPICAL SECTION DIMENSIONS

Consider the dimensions shown on the typical sections for pavement and shoulder widths and thickness' to be nominal or typical dimensions. The Engineer may direct or approve varying the actual dimensions to be constructed to fit existing conditions. Do not widen existing pavement or shoulders unless specified elsewhere in this proposal or directed by the engineer.

1-3725 Typical Section Dimensions
01/02/2012

TRAFFIC CONTROL PLAN

TRAFFIC CONTROL GENERAL

Except as provided herein, maintain and control traffic in accordance with the Standard and Supplemental Specifications and the Standard and Sepia Drawings, current editions. Except for the roadway and traffic control bid items listed, all items of work necessary to maintain and control traffic will be paid at the lump sum bid price to "Maintain and Control Traffic".

Contrary to Section 106.01, furnish new, or used in like new condition, traffic control devices at the beginning of the work and maintain in like new condition until completion of the work.

PROJECT PHASING & CONSTRUCTION PROCEDURES

The Engineer may specify days and hours when lane closures will not be allowed.

Maintain alternating one way traffic during construction. Provide a minimum clear lane width of 11 feet; however, provide for passage of vehicles of up to 16 feet in width. If traffic should be stopped due to construction operations, and a school bus on an official run arrives on the scene, make provisions for the passage of the bus as quickly as possible.

LANE CLOSURES

Do not leave lane closures in place during non-working hours.

SIGNS

Sign posts and splices shall be compliant with NCHRP 350 or MASH. Manufacturer's documentation validating this compliance shall be provided to the Engineer prior to installation. Signs, including any splices, shall be installed according to manufacturer's specifications and installation recommendations. Contrary to section 112.04.02, only long-term signs (signs intended to be continuously in place for more than 3 days) will be measured for payment. Short-term signs (signs intended to be left in place for 3 days or less) will not be measured for payment but will be incidental to Maintain and Control Traffic.

CHANGEABLE MESSAGE SIGNS

Provide changeable message signs in advance of and within the project at locations determined by the Engineer. If work is in progress concurrently in both directions or if more than one lane closure is in place in the same direction of travel, provide additional changeable message signs as directed

Traffic Control Plan Page 2 of 4

by the Engineer. Place changeable message signs one mile in advance of the anticipated queue at each lane closure. As the actual queue lengthens and/or shortens, relocate or provide additional changeable message signs so that traffic has warning of slowed or stopped traffic at least one mile but not more than two miles before reaching the end of the actual queue. The Engineer may vary the designated locations as the work progresses. The Engineer will determine the messages to be displayed. In the event of damage or mechanical/electrical failure, repair or replace the Changeable Message Sign within 24 hours. The Department will measure for payment the maximum number of Changeable Message Signs in concurrent use at the same time on a single day on all sections of the contract. The Department will measure individual Changeable Message Signs only once for payment, regardless of how many times they are set, reset, removed, and relocated during the duration of the project. The Department will not measure replacements for damaged Changeable Message Signs or for signs the Engineer directs be replaced due to poor condition or readability. Retain possession of the Changeable Message Signs upon completion of the work.

ARROW PANELS

Use arrow panels as shown on the Standard Drawings or as directed by the Engineer. The Department will measure for payment the maximum number of arrow panels in concurrent use at the same time on a single day on all sections of the contract. The Department will measure for payment the maximum number of Arrow Panels in concurrent use at the same time on a single day on all sections of the contract. The Department will measure individual Arrow Panels only once for payment, regardless of how many times they are set, reset, removed, and relocated during the duration of the project. The Department will not measure replacements for damaged Arrow Panels or for panels signs the Engineer directs be replaced due to poor condition or readability for payment. Retain possession of the Arrow Panels upon completion of the work.

TEMPORARY ENTRANCES

The Engineer will not require the Contractor to provide continuous access to farms, single family, duplex, or triplex residential properties during working hours; however, provide reasonable egress and ingress to each such property when actual operations are not in progress at that location. Limit the time during which a farm or residential entrance is blocked to the minimum length of time required for actual operations, not extended for the Contractor's convenience, and in no case exceeding six (6) hours. Notify all residents twenty-four hours in advance of any driveway or entrance closings and make any accommodations necessary to meet the access needs of disabled residents.

Except as allowed by the Phasing as specified above, maintain direct access to all side streets and roads, schools, churches, commercial properties and apartments or apartment complexes of four or more units at all times.

The Department will measure asphalt materials required to construct and maintain any temporary entrances which may be necessary to provide temporary access; however, the Department will not measure aggregates, excavation, and/or embankment, but shall be incidental to Maintain and

Traffic Control Plan
Page 3 of 4

Control Traffic. The Engineer will determine the type of surfacing material, asphalt or aggregate, to be used at each entrance.

THERMOPLASTIC INTERSECTION MARKINGS

Consider the locations listed on the summary as approximate only. Prior to milling and/or resurfacing, locate and document the locations of the existing markings. After resurfacing, replace the markings at their approximate existing locations or as directed by Engineer. Place markings not existing prior to resurfacing as directed by the Engineer.

BARRICADES

The Department will not measure barricades used in lieu of barrels and cones for channelization or delineation, but shall be incidental to Maintain and Control Traffic according to Section 112.04.01.

The Department will measure barricades used to protect pavement removal areas in individual units Each. The Department will measure for payment the maximum number of barricades in concurrent use at the same time on a single day on all sections of the contract. The Department will measure individual barricades only once for payment, regardless of how many times they are set, reset, removed, and relocated during the duration of the project. The Department will not measure replacements for damaged barricades the Engineer directs to be replaced due to poor condition or reflectivity. Retain possession of the Barricades upon completion of construction.

PAVEMENT MARKINGS

If there is to be a deviation from the existing striping plan, the Engineer will furnish the Contractor a striping plan prior to placement of the final surface course.

Install Temporary Striping according to Section 112 with the following exception:

If the Contractor's operations or phasing requires temporary markings that must subsequently be removed from the final surface course, use an approved removable lane tape; however, the Department will not measure removable lane tape for separate payment, but will measure and pay for removable lane tape as temporary striping.

PAVEMENT EDGE DROP-OFFS

Do not allow a pavement edge between opposing directions of traffic or lanes that traffic is expected to cross in a lane change situation with an elevation difference greater than 1½". Place Warning signs (MUTCD W8-11 or W8-9A) in advance of and at 1500' intervals throughout the drop-off area. Dual post the signs on both sides of the traveled way. Wedge all transverse transitions between resurfaced and unresurfaced areas which traffic may cross with asphalt mixture

Traffic Control Plan
Page 4 of 4

for leveling and wedging. Remove the wedges prior to placement of the final surface course.

Protect pavement edges that traffic is not expected to cross, except accidentally, as follows:

Less than 2" - No protection required.

2" to 4" - Place plastic drums, vertical panels, or barricades every 50 feet. During daylight working hours only, the Engineer will allow the Contractor to use cones in lieu of plastic drums, panels, and barricades. Wedge the drop-off with DGA or asphalt mixture for leveling and wedging with a 1:1 or flatter slope in daylight hours, or 3:1 or flatter slope during nighttime hours, when work is not active in the drop-off area.

Greater than 4" - Protect drop-offs greater than 4 inches within 10 feet of traffic by placing drums, vertical panels, or barricades every 25 feet. The Engineer will not allow the use of cones in lieu of drums, vertical panels, or barricades for drop-offs greater than 4". Place Type III Barricades directly in front of the drop-off facing on coming traffic in both directions of travel. Provide warning signs as shown on the Standard Drawings or as directed by the Engineer

Pedestrians & Bicycles - Protect pedestrian and bicycle traffic as directed by the engineer.

DURABLE PAVEMENT EDGE DETAIL

(Resurfacing adjacent to fill slope or ditch foreslope that is 3:1 or less)

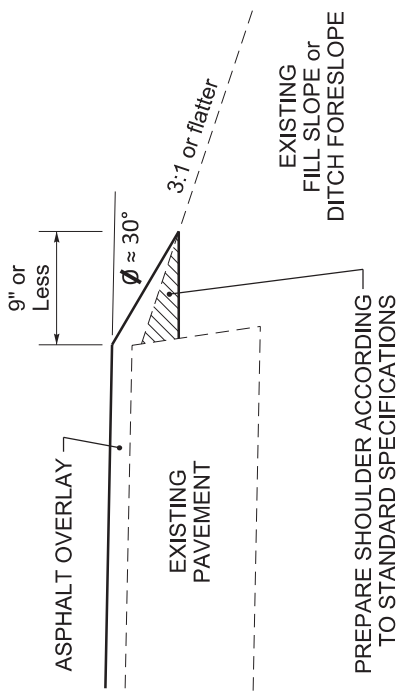

DURABLE PAVEMENT EDGE DETAIL

(Resurfacing adjacent to fill slope or ditch foreslope that is steeper than 3:1)

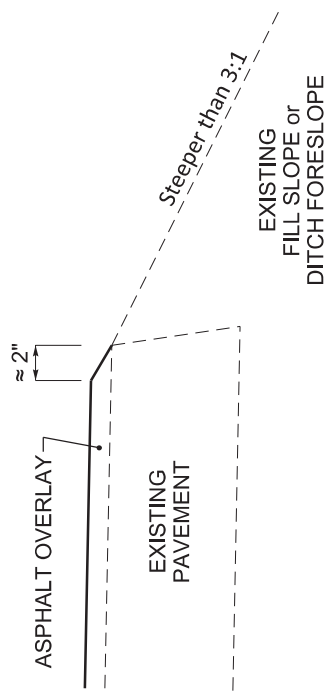

NOTES

1. DETAILS DO NOT APPLY TO OVERLAYS LESS THAN 1 INCH THICK.
2. THE DURABLE PAVEMENT EDGE DEVICE MAY BE DISENGAGED AT DRIVEWAYS, SIDE STREETS, HIGH SHOULDERS, AND OTHER LOCATIONS NOT FEASIBLE TO CONSTRUCT, AS APPROVED BY THE ENGINEER.

DURABLE PAVEMENT EDGE DETAILS

DRAWING NOT TO SCALE

DURABLE PAVEMENT EDGE DETAIL

(Resurfacing adjacent to low shoulder with dropoff of 5 inches or less)

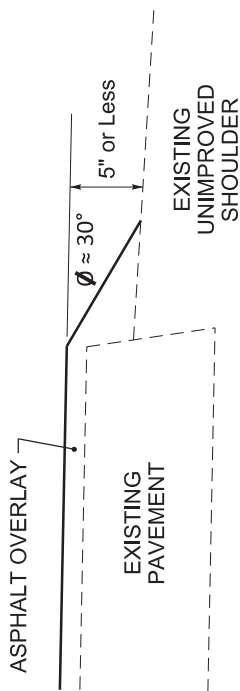

DURABLE PAVEMENT EDGE DETAIL

(Resurfacing adjacent to low shoulder with dropoff of more than 5 inches)

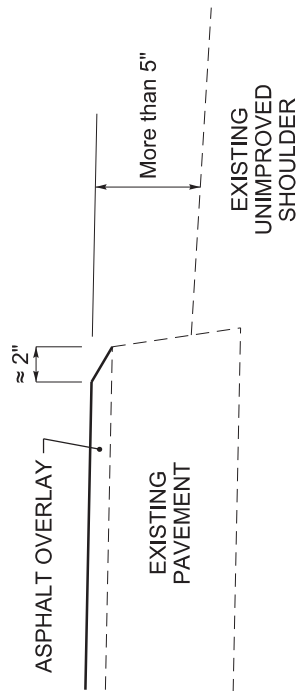

DURABLE PAVEMENT EDGE DETAIL

(Resurfacing adjacent to an obstruction, such as an existing headwall)

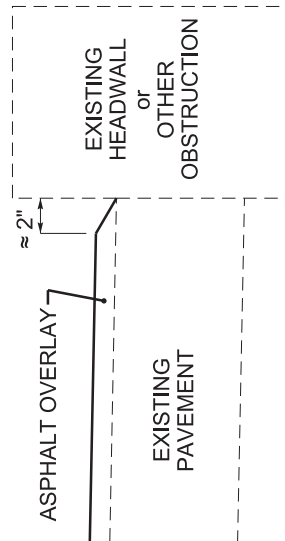

SPECIAL NOTE FOR TRAFFIC SIGNAL LOOP DETECTORS

1.0 DESCRIPTION. Be advised that there are existing traffic signal loop detectors within the construction limits of this project. Except as specified herein, perform traffic signal loop replacement in accordance with the Department's Standard/Supplemental Specifications, Special Provisions, Special Notes, and Standard/Sepia Drawings, current editions and as directed by the Engineer. Article references are to the Standard Specifications. Furnish all materials, labor, equipment, and incidentals for replacement of traffic signal loop installation(s) and all other work specified as part of this contract.

1.1 Pre-bid Requirements. Each Contractor submitting a bid for this work shall make a thorough inspection of the site prior to submitting his bid and shall thoroughly familiarize himself with existing conditions so that the work can be expeditiously performed after a Contract is awarded. Information provided in the Plans regarding types and quantities of work is not to be taken as an accurate or complete evaluation of the materials and conditions to be encountered during construction. The bidder must make his own determinations as to the conditions encountered.

2.0 MATERIALS. Except as specified herein, furnish materials in accordance with Subsection 732.02 and Section 835. Provide for materials to be sampled and tested in accordance with the Department's Sampling Manual. Make materials available for sampling a sufficient time in advance of the use of the materials to allow for the necessary time for testing, unless otherwise specified in this Special Note.

2.1 Maintain and Control Traffic. See Traffic Control Plan.

2.2 Sand. Furnish natural sand meeting the requirements of Subsection 804.04.01.

2.3 Seeding. Furnish Seed Mix Type I.

2.4 Loop Saw Slot and Fill. Furnish loop sealant, backer rod, and non-shrink grout according to the Saw Slot Detail.

2.5 Junction Boxes. Furnish junction box type B, #57 aggregate, and geotextile filter type IV according to junction box detail.

2.6 Cable No. 14/1 Pair (Lead-in). Furnish cable that is specified in Section 835. Cable shall be ran splice free. This shall include splice kits to connect to the loop wire.

2.7 Conduit. Furnish and install appropriate conduit from transitions to the roadway, junction boxes and poles. See details below.

3.0 CONSTRUCTION. Except as specified herein, install and test Traffic Signal Loop Detectors in accordance with Section 723 and the drawings.

3.1 Testing. The Contractor shall test all loops and cable no. 14/1 pair (lead-in) according to Subsection 723.03.17 before and after milling the roadway. The Contractor may have to separate the loop from the lead-in to perform this test. If the loop/lead-in meets the requirement in Section 723 at the controller cabinet, the loop/lead-in shall not be replaced. If existing loops do not meet the requirements in Subsection 723.03.17, the loops shall be replaced. Replacement loops may be installed either before or after the milling process.

Traffic Signal Loop Detectors Page 2 of 8

The Contractor shall verify that loops (both existing and replacement loops) meet the requirements per Subsection 723.03.17 before the final surface is laid. If loops do not meet conditions of Subsection 723.03.17, the Contractor shall replace them before the resurfacing activities begin. If replacement loops have to be reinstalled, the costs of reinstallation shall be incidental to the milling bid item. The Contractor shall re-splice loops to the lead-in with the proper splice as noted in the spec book.

3.2 Coordination. Notify the Engineer in writing, two (2) weeks prior to beginning any work. The Engineer will contact the District Traffic Engineer to coordinate the Department's operations with the Contractor's work.

3.3 Connection. The Contractor shall schedule all signal loop installation to ensure the new loops are connected to the lead-in and operational within 5 calendar days of the old loops being damaged and/or disconnected. This requirement includes damage caused by any work activity associated with the project. If the new signal loops are not functioning as intended following 5 calendar days, the Department may assess Liquidated Damages at a rate of \$500 per calendar day per signal location until the loops are operating at pre-construction conditions. All liquidated damages will be applied cumulatively.

3.4 Maintain and Control Traffic. See Traffic Control Plan.

3.5 Milling. On projects involving milling and texturing of the existing pavement, install loops in the existing pavement before or after performing the milling and texturing. After milling, the remnant contents of the existing saw slot (grout, loop wires, backer rod, and/or loop sealant) may not be flush with the top of the milled portion of the surface. In such cases, clear the saw slot of loose remnant contents and refill the saw slot with natural sand. Obtain the Engineer's approval of the stabilized saw slot prior to resurfacing. The Department will not measure for separate payment clearing and stabilizing the saw slot and shall consider this work incidental to milling.

3.6 Loop Saw Slot and Fill. The following is a typical step by step procedure for the installation of a loop.

- 1) Carefully mark the slot to be cut, perpendicular to the flow of traffic and centered in the lane.
- 2) Make each saw-cut 3/8-inch wide and at a depth such that the top of the backer rod is a minimum of 4 inches below the surface of asphalt pavement.
- 3) Drill a 1½ inch core hole at each corner and use a chisel to smooth corners to prevent sharp bends in the wire.
- 4) Clean all foreign and loose matter out of the slots and drilled cores and within 1 foot on all sides of the slots using a high pressure washer.
- 5) Completely dry the slots and drilled cores and within 1 foot on all sides of the slots.
- 6) Measure 9-12 inches from the edge of the paved surface (shoulder break or face of curb) and drill a 1½ inch hole on a 45° angle to the conduit adjacent to the roadway.
- 7) Closely inspect all cuts, cores, and slots for jagged edges or protrusions prior to the placement of the wire. All jagged edges and protrusions shall be ground or re-cut and cleaned again.

Traffic Signal Loop Detectors

Page 3 of 8

- 8) Place the loop wire splice-free from the termination point (cabinet or junction box) to the loop, continue around the loop for two turns (6'x30' loop) or three turns (6'x6' loop), and return to the termination point.
- 9) Push the wire into the saw slot with a blunt object such as a wooden stick. Make sure that the loop wire is pushed fully to the bottom of the saw slot. Screwdrivers shall not be used.
- 10) Install duct sealant to a minimum of 1 inch deep into the cored 1½ inch hole.
- 11) Apply loop sealant from the bottom up and fully encapsulate the loop wires in the saw slot. The wire should not be able to move when the sealant has set.
- 12) Cover the encapsulated loop wire with a continuous layer of backer rod along the entire loop and home run saw slots such that no voids are present between the loop sealant and backer rod.
- 13) Finish filling the saw cut with non-shrinkable grout per manufacturer's instructions. Alleviate all air pockets and refill low spaces. There shall be no concave portion to the grout in the saw slot. Any excess grout shall be cleaned from the roadway to alleviate tracking.
- 14) Clean up the site and dispose of all waste off the project.
- 15) Ensure that the grout has completely cured prior to subjecting the loop to traffic. Curing time varies with temperature and humidity.

3.7 Final Dressing, Clean Up, and Seeding. After all work is completed, clean work sites and all disturbed areas. Dispose of all waste and debris off the right of way at sites obtained by the Contractor at no additional cost to the Department. Sow all disturbed earthen areas with Seed Mix Type I.

3.8 Removal. The Contractor shall remove all existing junction boxes, wire from spans/poles/junction boxes/conduits, and conduits. The removal will be incidental to the project.

3.9 Property/Roadway Damage. The Contractor shall be responsible for all damage to public and/or private property resulting from the work. Upon completion of the work, restore all disturbed highway features and private property in like kind design and materials at no additional cost to the Department.

3.10 Right-of-Way Limits. The Department has not established exact limits of Right-of-Way. Limit work activities to obvious Right-of-Way and work areas secured by the Department through Consent and Release of the adjacent property owners. Contractor is responsible for all encroachments onto private lands.

3.11 Utility Clearance. Work around and do not disturb existing utilities. The Department does not anticipate any utility impacts for loop installation. If utilities are impacted, work with associated utility companies to resolve issues.

3.12 Control. Obtain the Engineer's approval of all designs required to be furnished by the Contractor prior to incorporation into the work. The Department reserves the right to permit other contractors, state forces, public utility companies, and others to do work during the construction within the limits of, or adjacent to, the project. Conduct operations and cooperate with such other parties so that interference with each other's work will be reduced to a minimum. The Contractor agrees to make no claims against the Department for additional compensation due to delays or other conditions created by

Traffic Signal Loop Detectors
Page 4 of 8

the operations of such other parties. Should a difference of opinion arise as to the rights of the Contractor and others working within the limits of, or adjacent to, the project, the Engineer will decide as to the respective rights of the various parties involved in order to ensure the completion of the work in general harmony and in a satisfactory manner, and the Engineer's decision shall be final and binding upon the Contractor.

3.13 Bore and Jack. Except for situations outlined in 3.15, bore and jack will be used if conduit is under pavement of any kind. The conduit shall be 2" rigid steel conduit under all pavement areas except for the area where the loop transitions from the saw slot. The installation of conduit should follow the below detail.

3.14 Open Cut Roadway. With permission of the Engineer, roadway may be open cut if the conduit is under pavement. The conduit shall be 2" rigid steel conduit under all pavement areas except for the area that the loop transition from the saw slot. The installation of conduit should follow requirements per Section 723.

4.0 MEASUREMENT. See Subsection 723.04 for bid item notes. Additional bid items include the following:

4.1 Loop Test. The Department will measure the quantity as each individual unit loop tested. The Department will not measure disconnection, reconnection, traffic control, re-splicing per specifications, before and after testing per note above, and any associated hardware for payment and will consider them incidental to this item of work.

5.0 PAYMENT. The Department will make payment for the completed and accepted quantities of listed items according to Subsection 723.05 in addition to the following:

<u>Code</u>	<u>Pay Item</u>	<u>Pay Unit</u>
Conduit 1"	4792	Linear Foot
PVC Conduit – 1 ¼ inch – sch 80	24900EC	Linear Foot
PVC Conduit – 2 inch – sch 80	24901EC	Linear Foot
Conduit 2"	4795	Linear Foot
Electrical Junction Box type B	4811	Each
Loop Test	24963ED	Each
Trenching and Backfilling	4820	Linear Foot
Loop Wire	4830	Linear Foot
Cable-No. 14/1 Pair	4850	Linear Foot ¹
Loop Saw Slot and Fill	4895	Linear Foot ¹
Bore and Jack Conduit	21543EN	Linear Foot ³
Open Cut Roadway	4821	Linear Foot ³

The Department will consider payment as full compensation for all work required under these notes and the Standard Specifications.

Traffic Signal Loop Detectors

Page 5 of 8

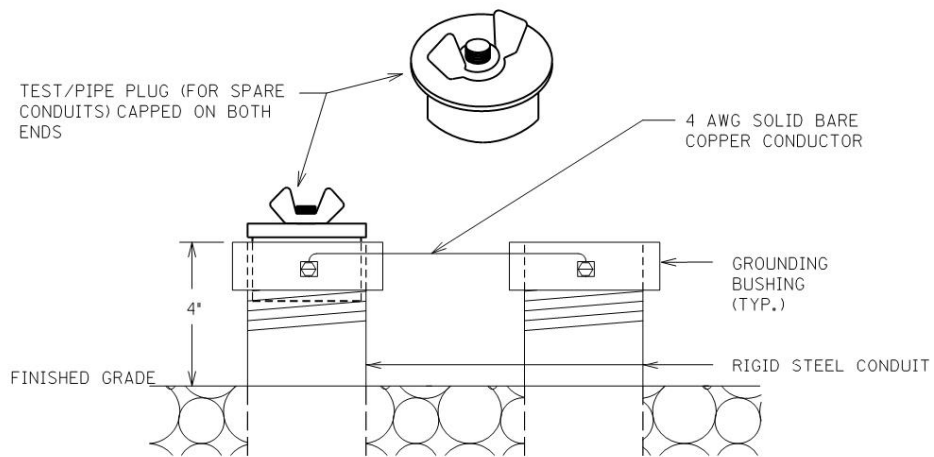

TEST/PIPE PLUG(FOR SPARE CONDUITS) AND GROUNDING DETAIL

Traffic Signal Loop Detectors
Page 6 of 8

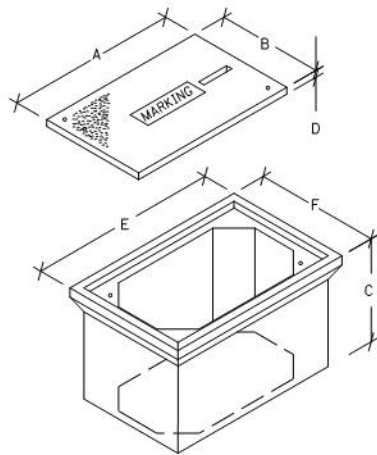

JUNCTION BOX DIMENSIONS (NOMINAL)						
	A	B	C	D	E	F
TYPE A	23"	14"	27"	2"	25"	15"
TYPE B	18"	11"	12"	1 3/4"	20"	13"
TYPE C	36"	24"	30"	3"	38"	26"

• MINIMUM
NOTE: STACKABLE BOXES ARE PERMITTED

BEFORE THE INSTALLATION OF THE #57 AGGREGATE AND JUNCTION BOX, THE CONTRACTOR SHALL INSTALL GEOTEXTILE FILTER FABRIC TYPE IV IN THE HOLE. THE FABRIC SHALL EXTEND TO JUST BELOW THE LIP OF THE JUNCTION BOX AND SHALL BE CONTINUOUSLY ADHERED TO THE EXTERIOR OF THE BOX WITH ADHESIVE. ANY LOCATIONS WHERE CONDUITS ENTER THE BOX, THE FABRIC SHALL BE 'X CUT' ONLY AS MUCH AS NECESSARY TO ALLOW PASSAGE OF EACH INDIVIDUAL CONDUIT THROUGH THE FABRIC. THE FABRIC SHALL BE INCIDENTAL TO BID ITEMS 481I, 2039INS835, OR 20392NS835.

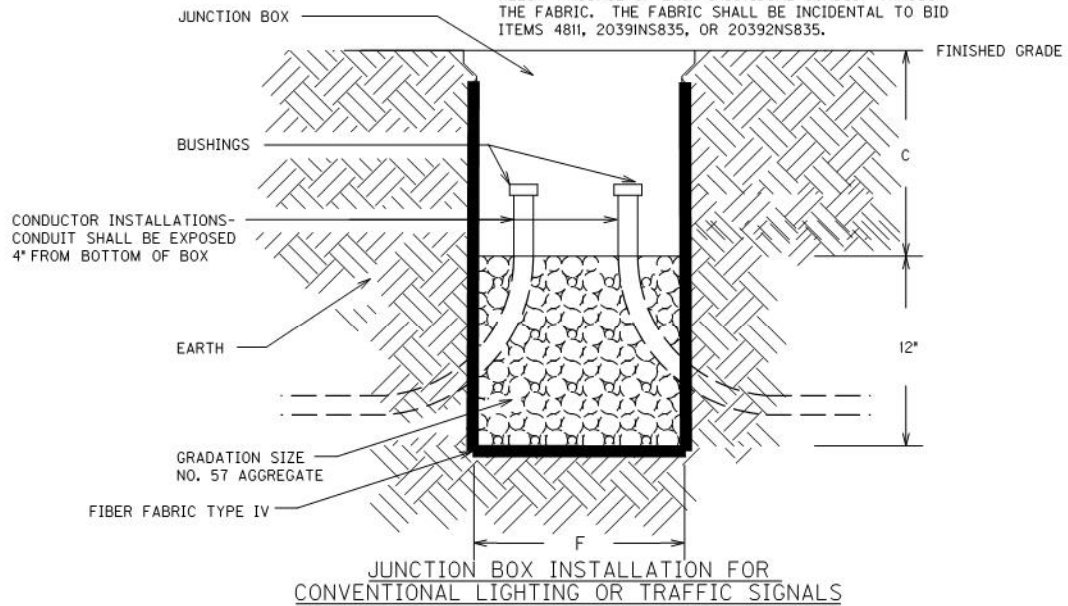

JUNCTION BOX INSTALLATION FOR CONVENTIONAL LIGHTING OR TRAFFIC SIGNALS

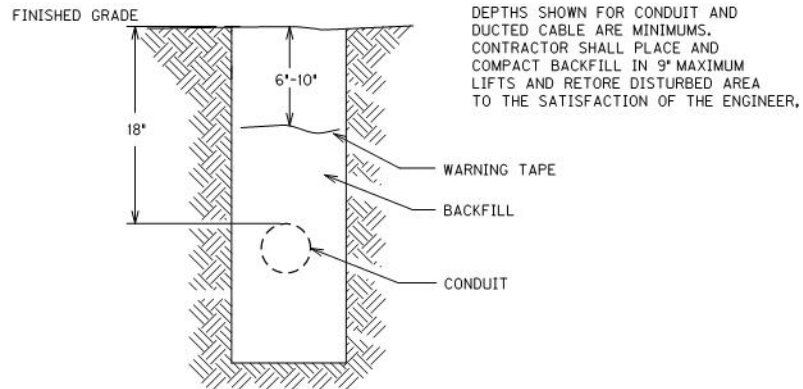

CONDUIT AND WARNING TAPE TRENCH

Traffic Signal Loop Detectors

Page 7 of 8

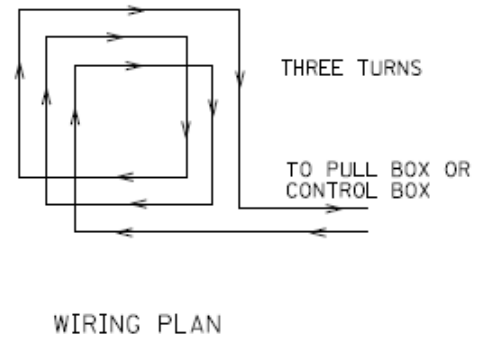
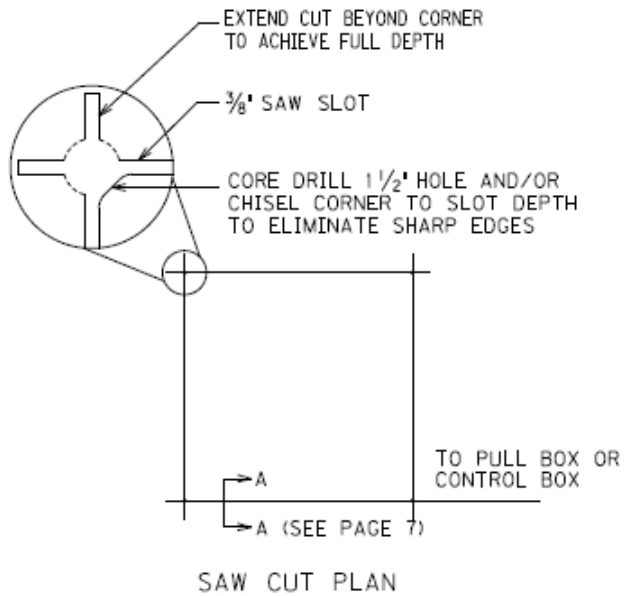

6'X6' LOOP

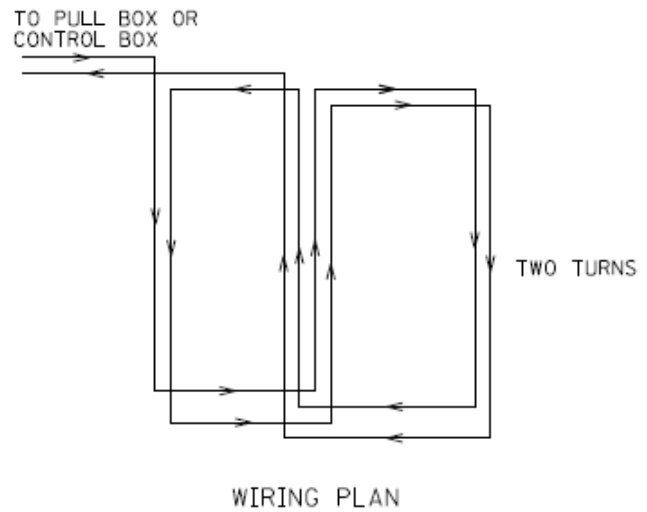
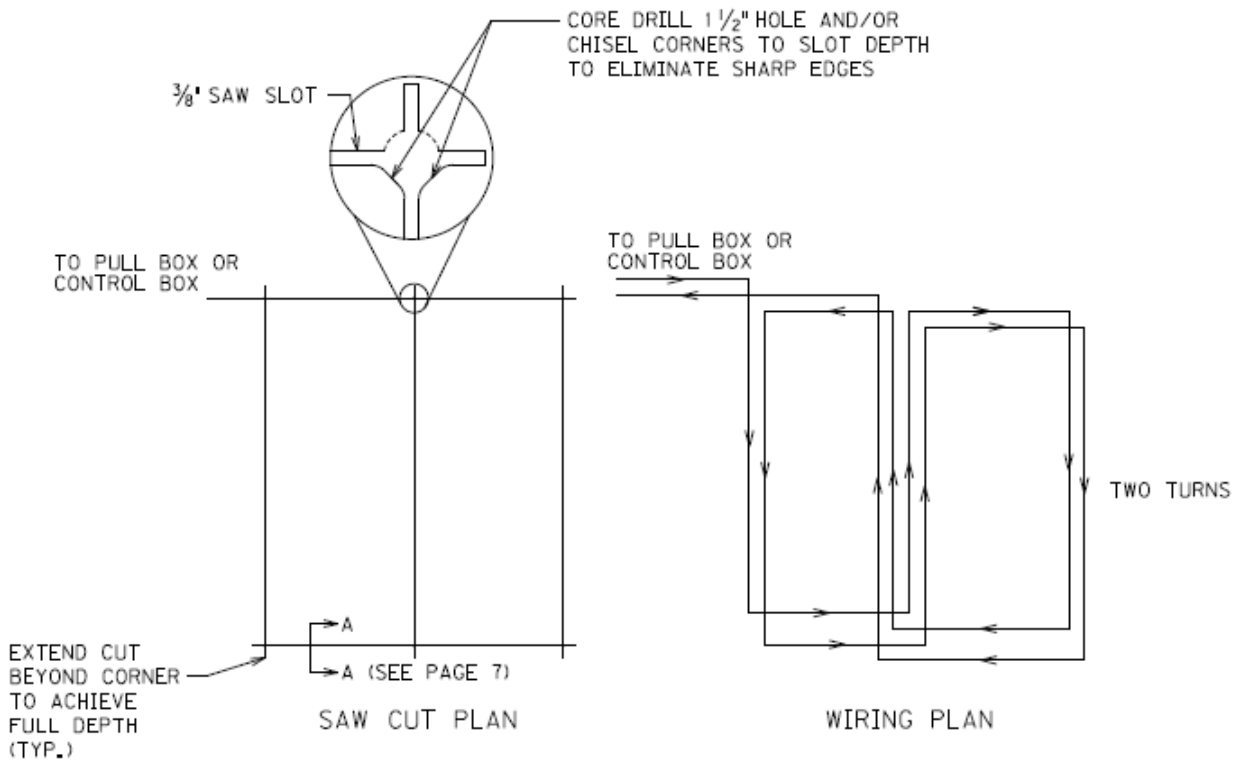

6'X30' QUADRAPOLE LOOP

Traffic Signal Loop Detectors

Page 8 of 8

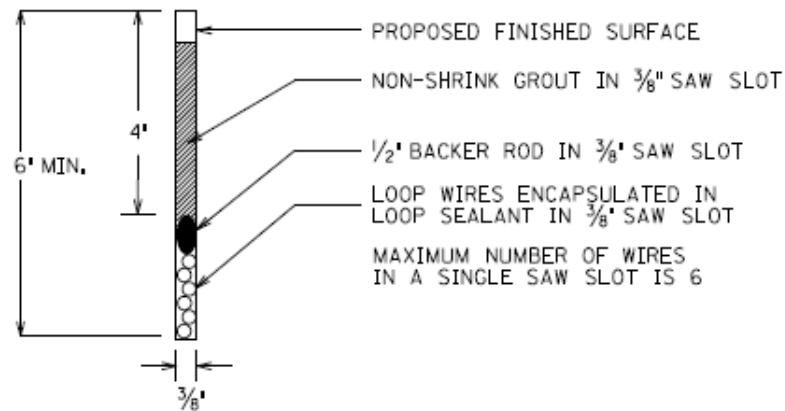

SECTION A-A (SAW SLOT DETAIL)

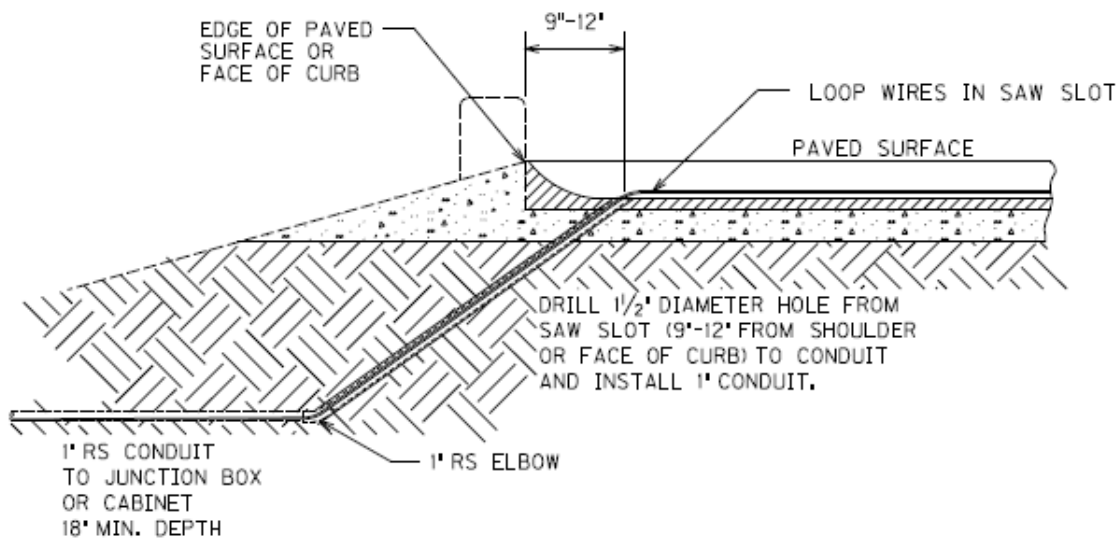

SAW SLOT EDGE OF PAVEMENT TRANSITION

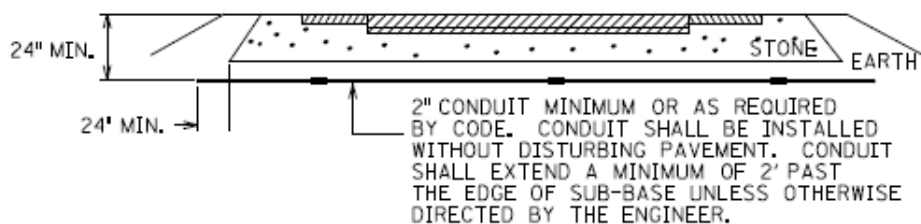

CONDUIT UNDER EXISTING PAVEMENT DETAIL

HARLAN

FD05 048 0421 007-015

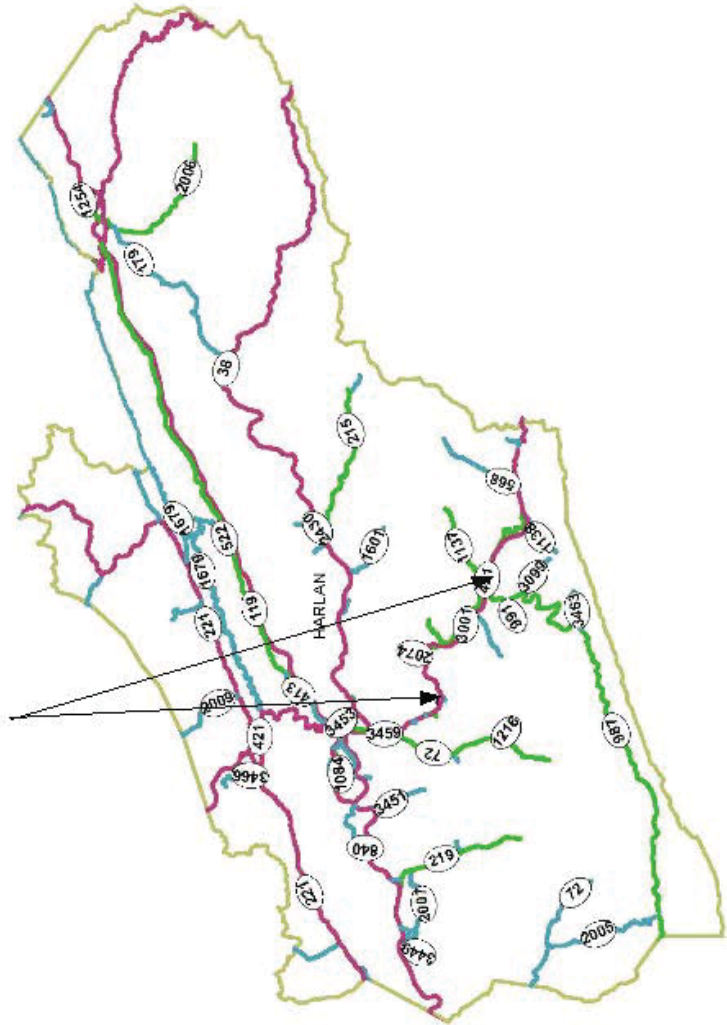

Legend

Priority

- A (pink line)
- B (green line)
- C (blue line)

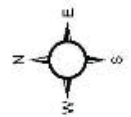

Harlan County
THERMOPLASTIC INTERSECTION PAVEMENT MARKINGS SUMMARY
FD05 048 0421 007-015

MPT.	INTERSECTION	X-WALKS		STP BARS		CURVE		ARROWS		COMB		CROSS		CATRAXX		RAILROAD		NOTES
		12 INCH	LF	24 INCH	LF	EA	EA	STR	EA	EA	EA	EA	EA	EA	EA	EA	EA	
8	KY 1556			10														
10.784	KY 3001			12		4												
10.974	KY2074			10														
12.624	Old US421/MT. Const			60														
13.32	Comprehensive Dr.			40		4												
13.453	KY115/Skidmore Dr.			193		6		4										
13.544	Holiday Dr.			40		4												
13.67	Armory St.			50		4												
13.791	KY6256/Mall RD	550		158		4												
13.878	Village Center RD			45		4												
14.12	Waldon RD			36		2												
13.349-13.423	Island Removal Area												4707					
13.445-13.518	Island Removal Area												3555					
13.537-13.648	Island Removal Area												5382					
13.79-13.864	Island Removal Area												3690					
13.887-13.982	Island Removal Area												5625					
13.994-14.103	Island Removal Area												9162					
13.31-13.2	Existing Median Cross Hatch												5280					
10.775-10.852	Existing Median Cross Hatch												5291					
10.626-10.553	Existing Median Cross Hatch												3100					
13.453	KY 1115 Island Removal					4							432					
13.791	Mall RD Island Removal												200					
TOTAL		550		654		36		4		0		0	46424					0

FD05 048 0421 007-015
Traffic Island Removal Summary

Begin MP	End MP	Area (SY)		CL2 Asph Base 1.0D PG 64-22	L/W PG 64-22	CL3 Asph Surf 0.38B PG 64-22	Comments
13.349	13.423	523		172.59	14.3825	35.95625	
13.445	13.518	395		130.35	10.8625	27.15625	
13.537	13.648	598		197.34	16.445	41.1125	
13.79	13.864	410		135.3	11.275	28.1875	
13.887	13.982	625		206.25	17.1875	42.96875	
13.994	14.103	1018		335.94	27.995	69.9875	
13.453		48		15.84	1.32	3.3	KY 1115, CL2 Asp Surf 0.38D PG 64-22
13.791		22.2		7.326	0.6105	1.52625	Mall RD, CL2 Asp Surf 0.38D PG 64-22
Totals		3639.2		1200	100.078	250.195	

Harlan County
TRAFFIC LOOP SUMMARY
FD05 048 0421 007-015
LOOP SUMMARY FOR ASPHALT PAVEMENT BID ALTERNATE

INTERSECTION	SAW, SLOT AND FILL LF	LOOP WIRE LF	CONDUIT 1 INCH		CONDUIT 1 1/4 INCH		CABLE NO. 14 LF	JUNCTION TYPE B		Trenching and Backfilling LF	Loop Test EA	NOTES
			LF	EA	LF	EA		LF	EA			
US 421 / Waldon												
North Leg	285	1,050	30		435	2,750	3		435		5	4 - 6x6 (2@228', 2@406') 1 - 6x30 left turn
South Leg	165	685	20		435	2,265	2		435		4	4 - 6x6 (2@228', 2@406')
Waldon												
	275	700	10		20	75	1		20		2	2 6x30 stop bar
US 421 / Qualls												
North Leg	225	400	10		30	750	1		30		3	2 6x6 50' setback mainline, 1 left turn 6x30
South Leg	225	400	10		30	875	1		30		3	2 6x6 50' setback mainline, 1 left turn 6x30
Qualls												
East (Village)	120	315	15		35	0	1		35		1	1 6x30 stopbar
West (Wendys)	230	600	15		20	775	1		20		2	2 6x30 stop bar
Total	1,525	4,150	110		1,005	7,490	10		1,005		20	

NOTES: 1. Quantities are for estimating purposes only. The Contractor shall field measure and inspect items to verify quantities.
 2. 2 - 1 1/4 inch conduits may be used in place of 2" conduit. Field verify conduit to match existing facilities/tie-in to poles/cabinets.
 Only replace existing conduit if damaged.

HARLAN COUNTY
FD05 048 0421 007-015
TYPICAL SECTION
MP 7.278-8.220, 8.800-9.110, 9.850-10.300,
10.890-13.170

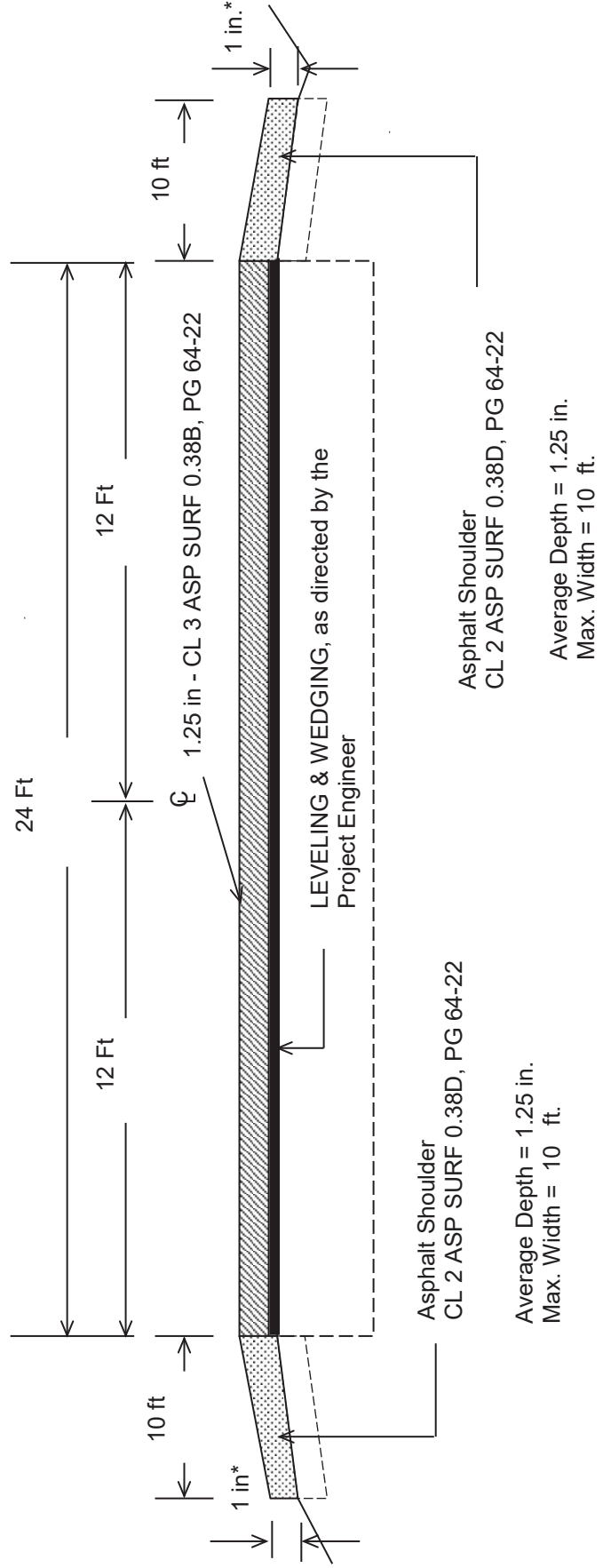

***Where Existing Site Conditions Permit**

HARLAN COUNTY
FD05 048 0421 007-015
MP 8.220-8.800, 9.110-9.850,
10.300-10.890

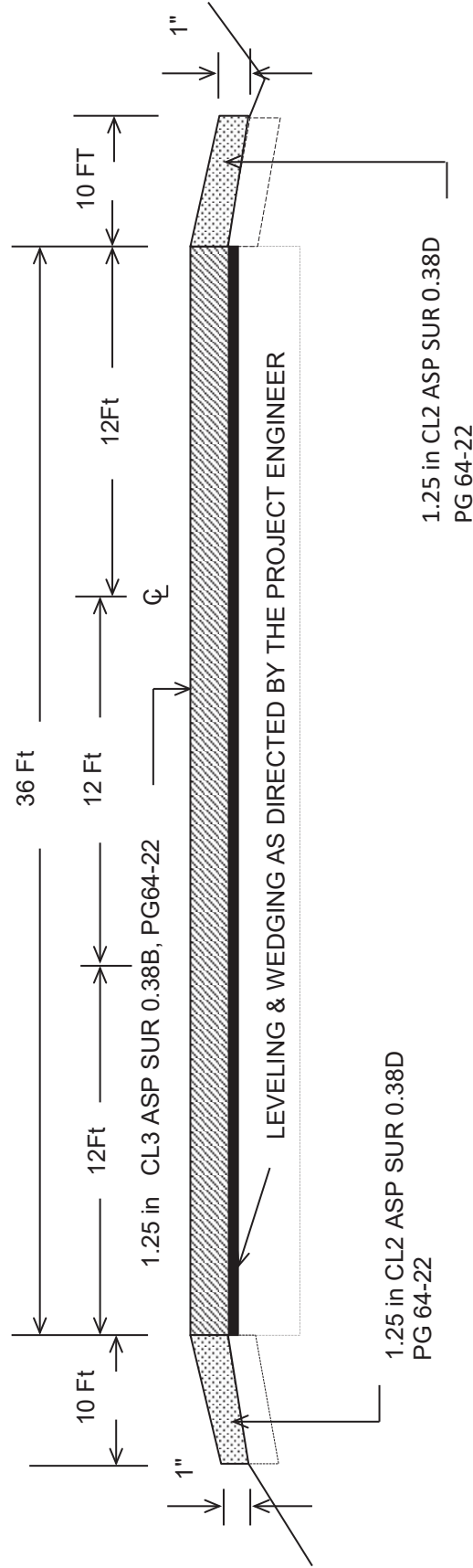

AVERAGE DEPTH = 1.25 inch
MAXIMUM WIDTH = 10 Ft.

AVERAGE DEPTH = 1.25 Inches
MAXIMUM WIDTH = 10 Ft.

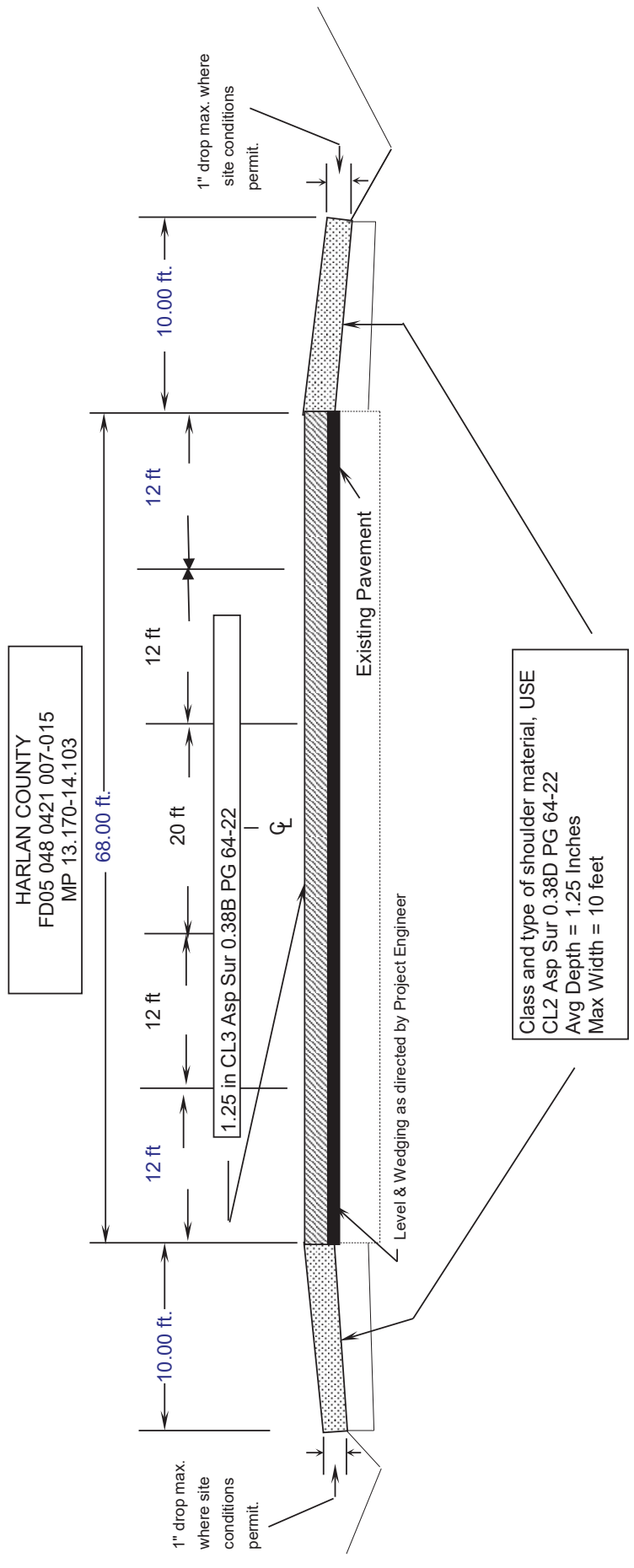

**BRIDGE DETAIL FOR PAVING PROJECT
 FD05 048 0421 007-015**

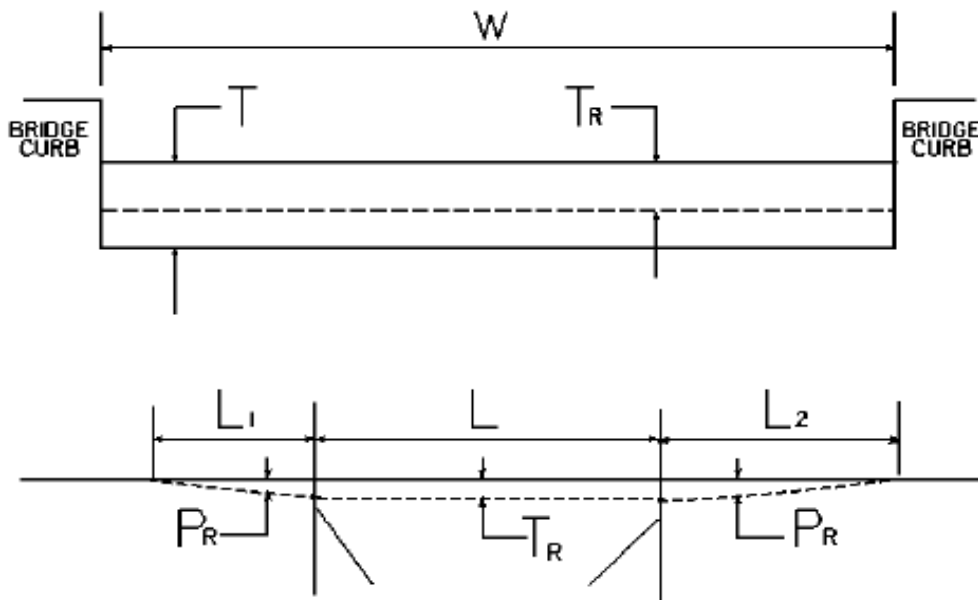

W = bridge width curb to curb
 T = thickness of existing asphalt overlay
 L = length of bridge
 L₁ & L₂ = length of approach pavement to be removed
 T_R = thickness to be removed and replaced on bridge
 P_R = thickness to be removed and replaced on pavement
 Note: L₁ & L₂ lengths shall be determined by using a transition rate of 100 ft/in of thickness

Route	Bridge No.	MP	W (ft)	T (in)	L ₁ (ft)	L ₂ (ft)	T _R (in)	L (ft)	P _R (in)
US 421	048B00186N	7.241	44.00	0.00	125.00	125.00	0.00	560.00	1.25
US 421	048B00187N	7.651	44.00	0.00	125.00	125.00	0.00	264.00	1.25
US 421	048B00188N	8.148	44.00	0.00	125.00	125.00	0.00	951.00	1.25
US 421	048B00189N	10.144	44.00	0.00	125.00	125.00	0.00	1,162.00	1.25
US 421	048B00180N	12.836	44.00	0.00	125.00	125.00	0.00	201.00	1.25
US 421	048B00167N	13.118	44.00	0.00	125.00	125.00	0.00	275.00	1.25

01/01/2009

PART II
SPECIFICATIONS AND STANDARD DRAWINGS

SPECIFICATIONS REFERENCE

Any reference in the plans or proposal to previous editions of the *Standard Specifications for Road and Bridge Construction* and *Standard Drawings* are superseded by *Standard Specifications for Road and Bridge Construction, Edition of 2012* and *Standard Drawings, Edition of 2016*.

SUPPLEMENTAL SPECIFICATIONS

The contractor shall use the Supplemental Specifications that are effective at the time of letting.
The Supplemental Specifications can be found at the following link:

<http://transportation.ky.gov/Construction/Pages/Kentucky-Standard-Specifications.aspx>

SPECIAL NOTE FOR PORTABLE CHANGEABLE MESSAGE SIGNS

This Special Note will apply when indicated on the plans or in the proposal.

1.0 DESCRIPTION. Furnish, install, operate, and maintain variable message signs at the locations shown on the plans or designated by the Engineer. Remove and retain possession of variable message signs when they are no longer needed on the project.

2.0 MATERIALS.

2.1 General. Use LED Variable Message Signs Class I, II, or III, as appropriate, from the Department's List of Approved Materials.

Unclassified signs may be submitted for approval by the Engineer. The Engineer may require a daytime and nighttime demonstration. The Engineer will make a final decision within 30 days after all required information is received.

2.2 Sign and Controls. All signs must:

- 1) Provide 3-line messages with each line being 8 characters long and at least 18 inches tall. Each character comprises 35 pixels.
- 2) Provide at least 40 preprogrammed messages available for use at any time. Provide for quick and easy change of the displayed message; editing of the message; and additions of new messages.
- 3) Provide a controller consisting of:
 - a) Keyboard or keypad.
 - b) Readout that mimics the actual sign display. (When LCD or LCD type readout is used, include backlighting and heating or otherwise arrange for viewing in cold temperatures.)
 - c) Non-volatile memory or suitable memory with battery backup for storing pre-programmed messages.
 - d) Logic circuitry to control the sequence of messages and flash rate.
- 4) Provide a serial interface that is capable of supporting complete remote control ability through land line and cellular telephone operation. Include communication software capable of immediately updating the message, providing complete sign status, and allowing message library queries and updates.
- 5) Allow a single person easily to raise the sign to a satisfactory height above the pavement during use, and lower the sign during travel.
- 6) Be Highway Orange on all exterior surfaces of the trailer, supports, and controller cabinet.
- 7) Provide operation in ambient temperatures from -30 to + 120 degrees Fahrenheit during snow, rain and other inclement weather.
- 8) Provide the driver board as part of a module. All modules are interchangeable, and have plug and socket arrangements for disconnection and reconnection. Printed circuit boards associated with driver boards have a conformable coating to protect against moisture.
- 9) Provide a sign case sealed against rain, snow, dust, insects, etc. The lens is UV stabilized clear plastic (polycarbonate, acrylic, or other approved material) angled to prevent glare.
- 10) Provide a flat black UV protected coating on the sign hardware, character PCB, and appropriate lens areas.
- 11) Provide a photocell control to provide automatic dimming.

- 12) Allow an on-off flashing sequence at an adjustable rate.
- 13) Provide a sight to aim the message.
- 14) Provide a LED display color of approximately 590 nm amber.
- 15) Provide a controller that is password protected.
- 16) Provide a security device that prevents unauthorized individuals from accessing the controller.
- 17) Provide the following 3-line messages preprogrammed and available for use when the sign unit begins operation:

/KEEP/RIGHT/=>=>=>/	/MIN/SPEED/**MPH/
/KEEP/LEFT/<<<</	/ICY/BRIDGE/AHEAD/ /ONE
/LOOSE/GRAVEL/AHEAD/	LANE/BRIDGE/AHEAD/
/RD WORK/NEXT/**MILES/	/ROUGH/ROAD/AHEAD/
/TWO WAY/TRAFFIC/AHEAD/	/MERGING/TRAFFIC/AHEAD/
/PAINT/CREW/AHEAD/	/NEXT/***/MILES/
/REDUCE/SPEED/**MPH/	/HEAVY/TRAFFIC/AHEAD/
/BRIDGE/WORK/***0 FT/	/SPEED/LIMIT/**MPH/
/MAX/SPEED/**MPH/	/BUMP/AHEAD/
/SURVEY/PARTY/AHEAD/	/TWO/WAY/TRAFFIC/

*Insert numerals as directed by the Engineer.
Add other messages during the project when required by the Engineer.

2.3 Power.

- 1) Design solar panels to yield 10 percent or greater additional charge than sign consumption. Provide direct wiring for operation of the sign or arrow board from an external power source to provide energy backup for 21 days without sunlight and an on-board system charger with the ability to recharge completely discharged batteries in 24 hours.

3.0 CONSTRUCTION. Furnish and operate the variable message signs as designated on the plans or by the Engineer. Ensure the bottom of the message panel is a minimum of 7 feet above the roadway in urban areas and 5 feet above in rural areas when operating. Use Class I, II, or III signs on roads with a speed limit less than 55 mph. Use Class I or II signs on roads with speed limits 55 mph or greater.

Maintain the sign in proper working order, including repair of any damage done by others, until completion of the project. When the sign becomes inoperative, immediately repair or replace the sign. Repetitive problems with the same unit will be cause for rejection and replacement.

Use only project related messages and messages directed by the Engineer, unnecessary messages lessen the impact of the sign. Ensure the message is displayed in either one or 2 phases with each phase having no more than 3 lines of text. When no message is needed, but it is necessary to know if the sign is operable, flash only a pixel.

When the sign is not needed, move it outside the clear zone or where the Engineer directs. Variable Message Signs are the property of the Contractor and shall be removed from the project when no longer needed. The Department will not assume ownership of these signs.

4.0 MEASUREMENT. The final quantity of Variable Message Sign will be

11

the actual number of individual signs acceptably furnished and operated during the project. The Department will not measure signs replaced due to damage or rejection.

5.0 PAYMENT. The Department will pay for the Variable Message Signs at the unit price each. The Department will not pay for signs replaced due to damage or rejection. Payment is full compensation for furnishing all materials, labor, equipment, and service necessary to, operate, move, repair, and maintain or replace the variable message signs. The Department will make payment for the completed and accepted quantities under the following:

<u>Code</u>	<u>Pay Item</u>	<u>Pay Unit</u>
02671	Portable Changeable Message Sign	Each

Effective June 15, 2012

2016 KENTUCKY STANDARD DRAWINGS

CURVE WIDENING AND SUPERELEVATION TRANSITIONS	RGS-001-07
SUPERELEVATION FOR MULTILANE PAVEMENT	RGS-002-06
MISCELLANEOUS STANDARDS	RGX-001-06
APPROACHES, ENTRANCES, AND MAIL BOX TURNOUT	RPM-110-07
CENTERLINE RUMBLE STRIPS	TPM-150-02
CENTERLINE RUMBLE STRIP 4 INCH STRIPING	TPM-155-02
SHOULDER AND EDGE LINE RUMBLE STRIP DETAILS	TPM-165
LANE CLOSURE TWO-LANE HIGHWAY	TTC-100-04
SHOULDER CLOSURE	TTC-135-02
PAVEMENT CONDITION WARNING SIGNS	TTD-125-02
MOBILE OPERATION FOR PAINT STRIPING CASE I	TTS-100-02
MOBILE OPERATION FOR PAINT STRIPING CASE II	TTS-105-02

COUNTY OF	SHEET NO.
TERMIN.	

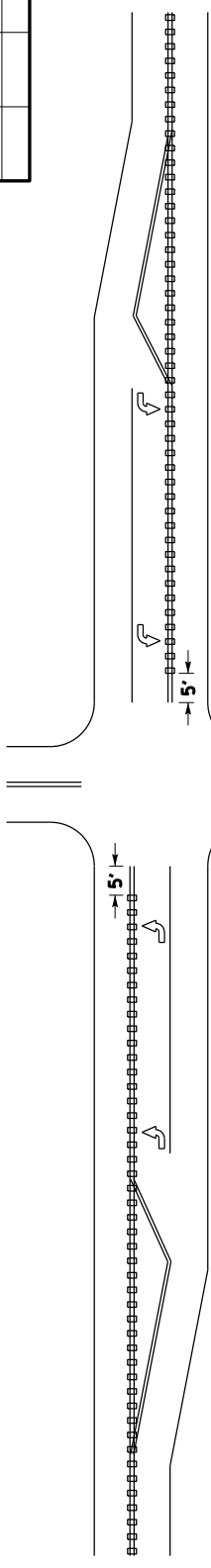

INTERSECTIONS WITH LEFT-TURN LANES ①

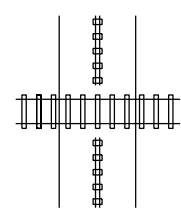

HIGHWAY-RAIL GRADE CROSSINGS ③

INTERSECTIONS WITHOUT LEFT-TURN LANES ①

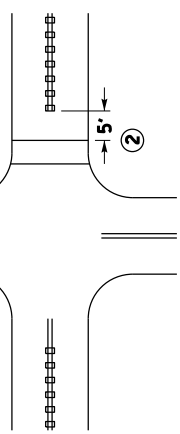

APPROACH SLAB

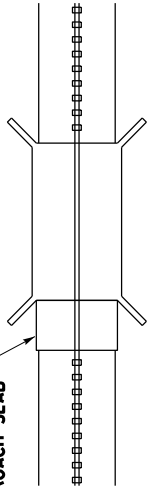

BRIDGE DECK/APPROACH SLAB ④

DRIVEWAYS/MINOR COMMERCIAL ENTRANCES ⑤

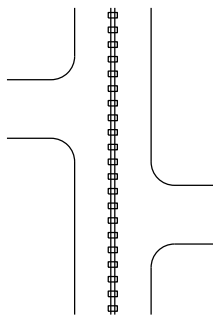

NOTES ~

- ① CENTERLINE RUMBLE STRIPS SHALL BE OMITTED THROUGH MAJOR INTERSECTIONS WITH, OR WITHOUT, LEFT-TURN LANES. OMIT THE CENTERLINE RUMBLE STRIPS APPROXIMATELY 5' IN ADVANCE OF THE AREA WHERE THE CENTERLINE PAVEMENT MARKINGS HAVE BEEN OMITTED (NORMALLY WHERE SIDE STREET RADIUS INTERSECTS MAINLINE).
- ② CENTERLINE RUMBLE STRIPS SHALL NOT BE INSTALLED THROUGH MARKED CROSSWALKS. OMIT THE CENTERLINE RUMBLE STRIPS APPROXIMATELY 5' IN ADVANCE OF MARKED CROSSWALKS.
- ③ CENTERLINE RUMBLE STRIPS SHALL NOT BE INSTALLED ACROSS HIGHWAY-RAIL GRADE CROSSINGS.
- ④ CENTERLINE RUMBLE STRIPS SHALL NOT BE INSTALLED ON BRIDGE DECKS OR APPROACH SLABS.
- ⑤ CENTERLINE RUMBLE STRIPS SHALL BE INSTALLED THROUGH DRIVEWAYS & MINOR COMMERCIAL ENTRANCES.
- 6. CENTERLINE RUMBLE STRIPS SHOULD BE OMITTED WHERE THE POSTED SPEED LIMIT IS 45 MPH OR LESS, OR WHERE LANE WIDTHS ARE LESS THAN 11 FT.

BID ITEM AND UNIT TO BID
CENTERLINE RUMBLE STRIPS

LF

DRAWING NOT TO SCALE
USE WITH CUR. STD. DWGS. TPM-155 AND TPM-160

KENTUCKY
DEPARTMENT OF HIGHWAYS
CENTERLINE RUMBLE STRIPS

SUBMITTED: *B. [Signature]*
II-23-16
DATE
002

COUNTY OF	SHEET NO.
TERMIN.	007-015

PLAN VIEW

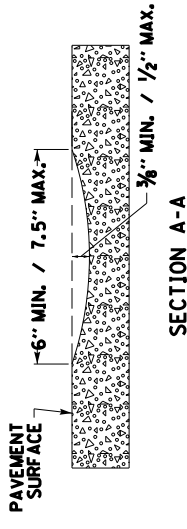
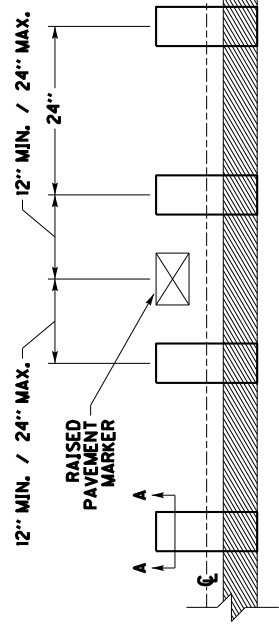
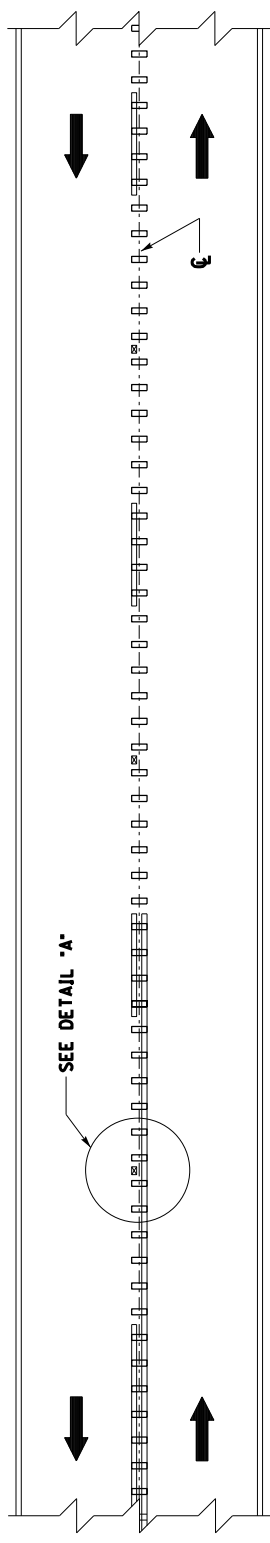

RUMBLE STRIP DETAIL

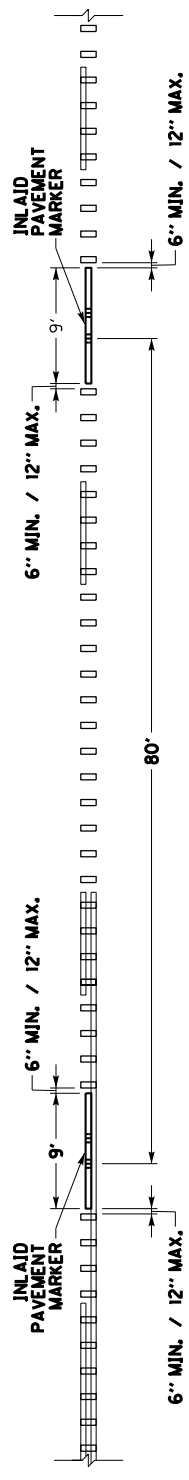
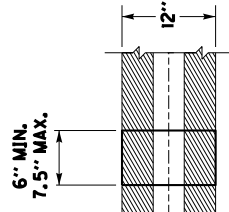

DETAIL FOR CENTERLINE RUMBLE STRIPS WITH INLAID PAVEMENT MARKERS

NOTES

1. DISTANCES SHOWN ARE APPROXIMATE. MAINTAIN RUMBLE STRIP DIMENSIONS AND SPACING AS MUCH AS POSSIBLE.
2. CENTERLINE RUMBLE STRIPS SHALL BE INSTALLED IN LINE WITH THE CENTER OF THE ROADWAY AS MUCH AS POSSIBLE.
3. DISCONTINUE CENTERLINE RUMBLE STRIPS AT LEAST 12" BEFORE AND AFTER THE CENTER OF EACH RAISED PAVEMENT MARKER, AND AT LEAST 6" BEFORE AND AFTER THE GROOVE FOR EACH INLAID PAVEMENT MARKER, INSTALL AS MANY RUMBLE STRIPS AS POSSIBLE BETWEEN ADJACENT PAVEMENT MARKERS WHILE MAINTAINING THE 24" CYCLE.
4. DO NOT INSTALL CENTERLINE RUMBLE STRIPS IN AREAS INDICATED ON TPM-150.
5. CENTERLINE RUMBLE STRIPS SHOULD BE OMITTED WHERE THE POSTED SPEED LIMIT IS 45 MPH OR LESS, OR WHERE LANE WIDTHS ARE LESS THAN 11 FT.

BID ITEM AND UNIT TO BID
CENTERLINE RUMBLE STRIPS

LF

DRAWING NOT TO SCALE
USE WITH CUR. STD. DWG.
TPM-150

KENTUCKY DEPARTMENT OF HIGHWAYS
CENTERLINE RUMBLE STRIPS 4 INCH STRIPING

SUBMITTED BY: <i>B. [Signature]</i>	DATE: 11-23-16
	003

COUNTY OF	SHEET NO.
TERMIN.	

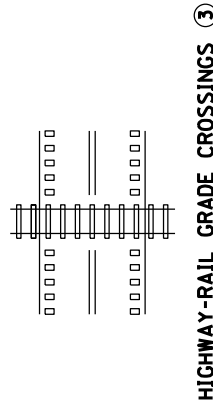
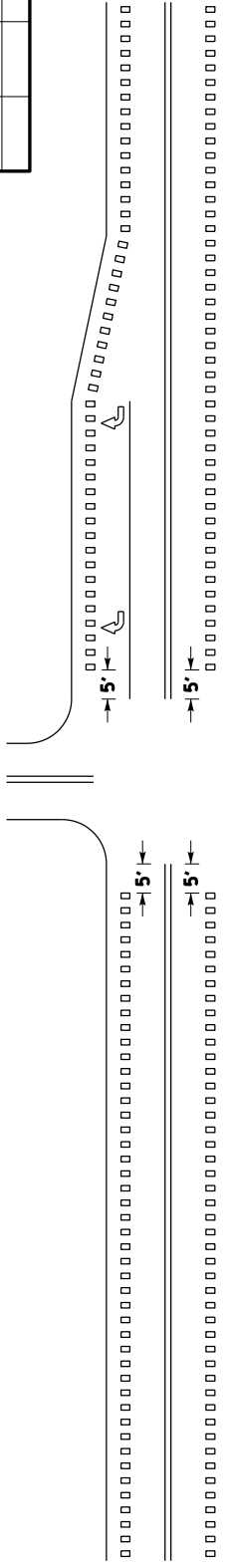

**INTERSECTIONS WITH OR WITHOUT
 RIGHT TURN LANES ①**

HIGHWAY-RAIL GRADE CROSSINGS ③

MARKED CROSSWALK ②

APPROACH SLAB

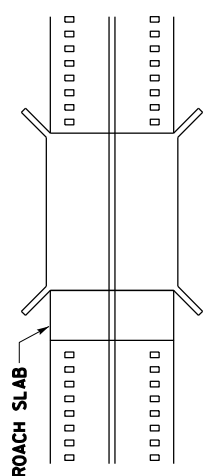

BRIDGE DECK/APPROACH SLAB ④

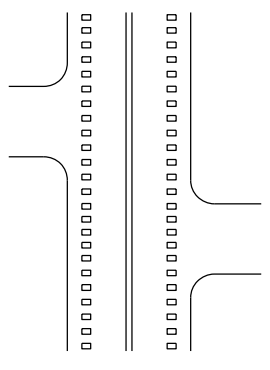

**DRIVEWAYS/MINOR
 COMMERCIAL ENTRANCES ⑤**

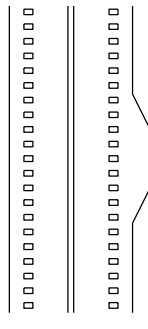

MAILBOX TURNOUTS ⑥

NOTES

- ① RUMBLE STRIPS SHALL BE OMITTED THROUGH MAJOR INTERSECTIONS WITH, OR WITHOUT, RIGHT-TURN LANES. OMIT RUMBLE STRIPS APPROXIMATELY 5' IN ADVANCE OF THE AREA WHERE EDGELINE PAVEMENT MARKINGS HAVE BEEN OMITTED (NORMALLY WHERE SIDE STREET RADIUS INTERSECTS MAINLINE).
- ② RUMBLE STRIPS SHALL NOT BE INSTALLED THROUGH MARKED CROSSWALKS. OMIT RUMBLE STRIPS APPROXIMATELY 5' IN ADVANCE OF MARKED CROSSWALKS.
- ③ RUMBLE STRIPS SHALL NOT BE INSTALLED ACROSS HIGHWAY-RAIL GRADE CROSSINGS.
- ④ RUMBLE STRIPS SHALL NOT BE INSTALLED ON BRIDGE DECKS OR APPROACH SLABS.
- ⑤ RUMBLE STRIPS SHALL BE INSTALLED THROUGH DRIVEWAYS & MINOR COMMERCIAL ENTRANCES.
- ⑥ RUMBLE STRIPS SHALL BE INSTALLED THROUGH MAILBOX TURNOUTS.
7. RUMBLE STRIPS SHOULD BE OMITTED WHERE THE POSTED SPEED LIMIT IS 45 MPH OR LESS.

DRAWING NOT TO SCALE

**USE WITH SEP1A 006, 007,
 AND 008**

KENTUCKY
 DEPARTMENT OF HIGHWAYS
**SHOULDER & EDGELINE
 RUMBLE STRIP DETAILS**

BID ITEMS AND UNIT TO BID
 EDGELINE RUMBLE STRIPS
 SHOULDER RUMBLE STRIPS

LF
 LF

SUBMITTED: *B. [Signature]*
 DATE: 11-23-16
 005

COUNTY OF	TERRING	SHEET	007-015
-----------	---------	-------	---------

PAVEMENT WIDTH (W) ②	RUMBLE LENGTH (X) ⑤	OFFSET ⑥	CLRS & SRS	
			LANE WIDTH (Y) ③	SHOULDER WIDTH (Z) ④
34'	8"	6"	12'	5'
35'	8"	6"	12'	5.5'
36'	8"	6"	12'	6'
37'	12"	12"	12'	6.5'
38'	12"	12"	12'	7'
39'	12"	12"	12'	7.5'
>=40'	16"	12"	12'	>=8'

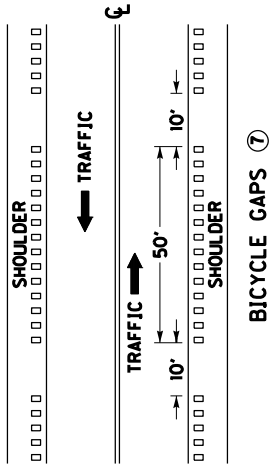
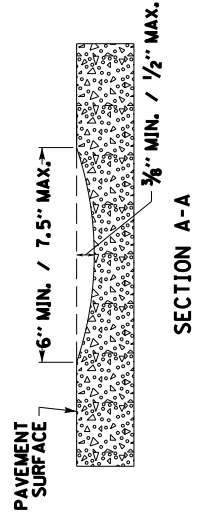
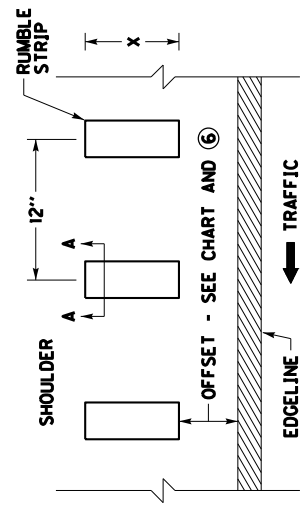
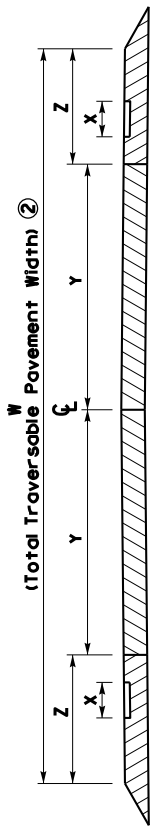

~ NOTES ~

- SHOULDER RUMBLE STRIPS SHOULD BE INSTALLED ACCORDING TO THE DIMENSIONS PROPOSED ABOVE UNLESS THERE IS AN ENGINEERING BASIS THAT SUPPORTS A CHANGE IN DIMENSION. FOR EXAMPLE, IF THE EXISTING LANE WIDTH IS NARROWER THAN THE LANE WIDTH PROPOSED IN THIS DRAWING AND THE EXISTING SHOULDER PAVEMENT DEPTH IS NOT SUITABLE TO BE CONVERTED INTO A PORTION OF THE PROPOSED LANE WIDTH, THEN THE EXISTING LANE WIDTH SHOULD BE USED INSTEAD OF THE WIDTH PROPOSED IN THIS DRAWING.
- PAVEMENT WIDTH (W) IS THE TOTAL WIDTH OF TRAVERSABLE PAVEMENT. DO NOT INCLUDE THE WIDTH OF ANY NON-TRAVERSABLE PAVEMENT, SUCH AS PAVEMENT WEDGES, WHEN MEASURING THE PAVEMENT WIDTH (W).
- LANE WIDTH (Y) TO BE MEASURED FROM CENTER OF ROAD TO CENTER OF EDGELINE STRIPE.
- PAVED SHOULDER WIDTH (Z) TO BE MEASURED FROM CENTER OF EDGELINE STRIPE TO OUTSIDE EDGE OF TRAVERSABLE PAVEMENT. DISTANCES SHOWN ARE APPROXIMATE. MAINTAIN RUMBLE STRIP DIMENSIONS AND SPACING AS MUCH AS POSSIBLE. IF THE TYPICAL SECTION SHOWS A LANE WIDTH (Y) AND/OR SHOULDER WIDTH (Z) THAT DIFFERS FROM THE WIDTHS LISTED IN THIS DRAWING, THE ENGINEER SHALL DETERMINE THE LANE WIDTH (Y) AND/OR SHOULDER WIDTH (Z) AT THE TIME OF CONSTRUCTION. NOTE: CENTERLINE RUMBLE STRIPS SHOULD BE OMITTED WHEN THE LANE WIDTH (Y) IS LESS THAN 11 FT.
- RUMBLE LENGTH (X) AND/OR OFFSET DISTANCE MAY BE MODIFIED AS THE ENGINEER DIRECTS, IF THE SHOULDER WIDTH (Z) IS EQUAL TO OR LESS THAN THE COMBINED WIDTH OF THE PROPOSED RUMBLE LENGTH (X) AND OFFSET DISTANCE.
- ALL SHOULDER RUMBLE STRIPS ALONG SHOULDERS THAT ARE 5' OR WIDER SHOULD INCLUDE BICYCLE GAPS AS DETAILED.
- SHOULDER RUMBLE STRIPS SHOULD BE OMITTED WHERE THE POSTED SPEED LIMIT IS 45 MPH OR LESS.

BID ITEM AND UNIT TO BID
SHOULDER RUMBLE STRIPS

LF

USE WITH SEP1A 005
KENTUCKY
DEPARTMENT OF HIGHWAYS
SHOULDER RUMBLE STRIP
DETAILS
TWO LANE ROADWAYS
SUBMITTED: *B. [Signature]* DATE: 11-23-16
007

DRAWING NOT TO SCALE

PART III

EMPLOYMENT, WAGE AND RECORD REQUIREMENTS

**TRANSPORTATION CABINET
DEPARTMENT OF HIGHWAYS**

**LABOR AND WAGE REQUIREMENTS
APPLICABLE TO OTHER THAN FEDERAL-AID SYSTEM PROJECTS**

- I. Application
- II. Nondiscrimination of Employees (KRS 344)

I. APPLICATION

1. These contract provisions shall apply to all work performed on the contract by the contractor with his own organization and with the assistance of workmen under his immediate superintendence and to all work performed on the contract by piecework, station work or by subcontract. The contractor's organization shall be construed to include only workmen employed and paid directly by the contractor and equipment owned or rented by him, with or without operators.

2. The contractor shall insert in each of his subcontracts all of the stipulations contained in these Required Provisions and such other stipulations as may be required.

3. A breach of any of the stipulations contained in these Required Provisions may be grounds for termination of the contract.

3. If the contractor is in control of apprenticeship or other training or retraining, including on-the-job training programs, he shall not discriminate against an individual because of his race, color, religion, national origin, sex, disability or age forty (40) and over, in admission to, or employment in any program established to provide apprenticeship or other training.

4. The contractor will send to each labor union or representative of workers with which he has a collective bargaining agreement or other contract or understanding, a notice to be provided advising the said labor union or workers' representative of the contractor's commitments under this section, and shall post copies of the notice in conspicuous places available to employees and applicants for employment. The contractor will take such action with respect to any subcontract or purchase order as the administrating agency may direct as a means of enforcing such provisions, including sanctions for non-compliance.

Revised: January 25, 2017

II. NONDISCRIMINATION OF EMPLOYEES

**AN ACT OF THE KENTUCKY
GENERAL ASSEMBLY TO PREVENT
DISCRIMINATION IN EMPLOYMENT
KRS CHAPTER 344
EFFECTIVE JUNE 16, 1972**

The contract on this project, in accordance with KRS Chapter 344, provides that during the performance of this contract, the contractor agrees as follows:

1. The contractor shall not fail or refuse to hire, or shall not discharge any individual, or otherwise discriminate against an individual with respect to his compensation, terms, conditions, or privileges of employment, because of such individual's race, color, religion, national origin, sex, disability or age (forty and above); or limit, segregate, or classify his employees in any way which would deprive or tend to deprive an individual of employment opportunities or otherwise adversely affect his status as an employee, because of such individual's race, color, religion, national origin, sex, disability or age forty (40) and over. The contractor agrees to post in conspicuous places, available to employees and applicants for employment, notices to be provided setting forth the provisions of this nondiscrimination clause.

2. The contractor shall not print or publish or cause to be printed or published a notice or advertisement relating to employment by such an employer or membership in or any classification or referral for employment by the employment agency, indicating any preference, limitation, specification, or discrimination, based on race, color, religion, national origin, sex, or age forty (40) and over, or because the person is a qualified individual with a disability, except that such a notice or advertisement may indicate a preference, limitation, or specification based on religion, national origin, sex, or age forty (40) and over, or because the person is a qualified individual with a disability, when religion, national origin, sex, or age forty (40) and over, or because the person is a qualified individual with a disability, is a bona fide occupational qualification for employment.

EXECUTIVE BRANCH CODE OF ETHICS

In the 1992 regular legislative session, the General Assembly passed and Governor Brereton Jones signed Senate Bill 63 (codified as KRS 11A), the Executive Branch Code of Ethics, which states, in part:

KRS 11A.040 (7) provides:

No present or former public servant shall, within six (6) months following termination of his office or employment, accept employment, compensation, or other economic benefit from any person or business that contracts or does business with, or is regulated by, the state in matters in which he was directly involved during the last thirty-six (36) months of his tenure. This provision shall not prohibit an individual from returning to the same business, firm, occupation, or profession in which he was involved prior to taking office or beginning his term of employment, or for which he received, prior to his state employment, a professional degree or license, provided that, for a period of six (6) months, he personally refrains from working on any matter in which he was directly involved during the last thirty-six (36) months of his tenure in state government. This subsection shall not prohibit the performance of ministerial functions, including but not limited to filing tax returns, filing applications for permits or licenses, or filing incorporation papers, nor shall it prohibit the former officer or public servant from receiving public funds disbursed through entitlement programs.

KRS 11A.040 (9) states:

A former public servant shall not represent a person or business before a state agency in a matter in which the former public servant was directly involved during the last thirty-six (36) months of his tenure, for a period of one (1) year after the latter of:

- a) The date of leaving office or termination of employment; or
- b) The date the term of office expires to which the public servant was elected.

This law is intended to promote public confidence in the integrity of state government and to declare as public policy the idea that state employees should view their work as a public trust and not as a way to obtain private benefits.

If you have worked for the executive branch of state government within the past six months, you may be subject to the law's prohibitions. The law's applicability may be different if you hold elected office or are contemplating representation of another before a state agency.

Also, if you are affiliated with a firm which does business with the state and which employs former state executive-branch employees, you should be aware that the law may apply to them.

In case of doubt, the law permits you to request an advisory opinion from the Executive Branch Ethics Commission, 3 Fountain Place, Frankfort, Kentucky 40601; telephone (502) 564-7954.

Revised: January 27, 2017

Kentucky Equal Employment Opportunity Act of 1978

The requirements of the Kentucky Equal Employment Opportunity Act of 1978 (KRS 45.560-45.640) shall apply to this Contract. The apparent low Bidder will be required to submit EEO forms to the Division of Construction Procurement, which will then forward to the Finance and Administration Cabinet for review and approval. No award will become effective until all forms are submitted and EEO/CC has certified compliance. The required EEO forms are as follows:

- EEO-1: Employer Information Report
- Affidavit of Intent to Comply
- Employee Data Sheet
- Subcontractor Report

These forms are available on the Finance and Administration's web page under ***Vendor Information, Standard Attachments and General Terms*** at the following address:
<https://www.eProcurement.ky.gov>.

Bidders currently certified as being in compliance by the Finance and Administration Cabinet may submit a copy of their approval letter in lieu of the referenced EEO forms.

For questions or assistance please contact the Finance and Administration Cabinet by email at **finance.contractcompliance@ky.gov** or by phone at 502-564-2874.

EMPLOYEE RIGHTS UNDER THE FAIR LABOR STANDARDS ACT

THE UNITED STATES DEPARTMENT OF LABOR WAGE AND HOUR DIVISION

FEDERAL MINIMUM WAGE

\$7.25

 PER HOUR

BEGINNING JULY 24, 2009

OVERTIME PAY At least 1½ times your regular rate of pay for all hours worked over 40 in a workweek.

CHILD LABOR An employee must be at least **16** years old to work in most non-farm jobs and at least **18** to work in non-farm jobs declared hazardous by the Secretary of Labor.

Youths **14** and **15** years old may work outside school hours in various non-manufacturing, non-mining, non-hazardous jobs under the following conditions:

No more than

- **3** hours on a school day or **18** hours in a school week;
- **8** hours on a non-school day or **40** hours in a non-school week.

Also, work may not begin before **7 a.m.** or end after **7 p.m.**, except from June 1 through Labor Day, when evening hours are extended to **9 p.m.** Different rules apply in agricultural employment.

TIP CREDIT Employers of “tipped employees” must pay a cash wage of at least \$2.13 per hour if they claim a tip credit against their minimum wage obligation. If an employee’s tips combined with the employer’s cash wage of at least \$2.13 per hour do not equal the minimum hourly wage, the employer must make up the difference. Certain other conditions must also be met.

ENFORCEMENT The Department of Labor may recover back wages either administratively or through court action, for the employees that have been underpaid in violation of the law. Violations may result in civil or criminal action.

Employers may be assessed civil money penalties of up to \$1,100 for each willful or repeated violation of the minimum wage or overtime pay provisions of the law and up to \$11,000 for each employee who is the subject of a violation of the Act’s child labor provisions. In addition, a civil money penalty of up to \$50,000 may be assessed for each child labor violation that causes the death or serious injury of any minor employee, and such assessments may be doubled, up to \$100,000, when the violations are determined to be willful or repeated. The law also prohibits discriminating against or discharging workers who file a complaint or participate in any proceeding under the Act.

ADDITIONAL INFORMATION

- Certain occupations and establishments are exempt from the minimum wage and/or overtime pay provisions.
- Special provisions apply to workers in American Samoa and the Commonwealth of the Northern Mariana Islands.
- Some state laws provide greater employee protections; employers must comply with both.
- The law requires employers to display this poster where employees can readily see it.
- Employees under 20 years of age may be paid \$4.25 per hour during their first 90 consecutive calendar days of employment with an employer.
- Certain full-time students, student learners, apprentices, and workers with disabilities may be paid less than the minimum wage under special certificates issued by the Department of Labor.

For additional information:



1-866-4-USWAGE

(1-866-487-9243)

TTY: 1-877-889-5627



WWW.WAGEHOUR.DOL.GOV

PART IV
INSURANCE

INSURANCE

The Contractor shall procure and maintain the following insurance in addition to the insurance required by law:

- 1) Commercial General Liability-Occurrence form – not less than \$2,000,000 General aggregate, \$2,000,000 Products & Completed Aggregate, \$1,000,000 Personal & Advertising, \$1,000,000 each occurrence.
- 2) Automobile Liability- \$1,000,000 per accident
- 3) Employers Liability:
 - a) \$100,000 Each Accident Bodily Injury
 - b) \$500,000 Policy limit Bodily Injury by Disease
 - c) \$100,000 Each Employee Bodily Injury by Disease
- 4) The insurance required above must be evidenced by a Certificate of Insurance and this Certificate of Insurance must contain one of the following statements:
 - a) "policy contains no deductible clauses."
 - b) "policy contains _____ (amount) deductible property damage clause but company will pay claim and collect the deductible from the insured."
- 5) **KENTUCKY WORKMEN'S COMPENSATION INSURANCE.** The contractor shall furnish evidence of coverage of all his employees or give evidence of self-insurance by submitting a copy of a certificate issued by the Workmen's Compensation Board.

The cost of insurance is incidental to all contract items. All subcontractors must meet the same minimum insurance requirements.

PART V
BID ITEMS

PROPOSAL BID ITEMS

192045

Page 1 of 1

Report Date 1/3/19

Section: 0001 - PAVING

LINE	BID CODE	ALT	DESCRIPTION	QUANTITY	UNIT	UNIT PRIC	FP	AMOUNT
0010	00190		LEVELING & WEDGING PG64-22	1,600.00	TON		\$	
0020	00212		CL2 ASPH BASE 1.00D PG64-22	2,500.00	TON		\$	
0030	00301		CL2 ASPH SURF 0.38D PG64-22	5,200.00	TON		\$	
0040	00356		ASPHALT MATERIAL FOR TACK	106.00	TON		\$	
0050	00388		CL3 ASPH SURF 0.38B PG64-22	10,225.00	TON		\$	
0060	02562		TEMPORARY SIGNS	450.00	SQFT		\$	
0070	02650		MAINTAIN & CONTROL TRAFFIC	1.00	LS		\$	
0080	02671		PORTABLE CHANGEABLE MESSAGE SIGN	2.00	EACH		\$	
0090	02676		MOBILIZATION FOR MILL & TEXT	1.00	LS		\$	
0100	02677		ASPHALT PAVE MILLING & TEXTURING	1,570.00	TON		\$	
0110	02696		SHOULDER RUMBLE STRIPS	72,072.00	LF		\$	
0120	02775		ARROW PANEL	2.00	EACH		\$	
0130	04792		CONDUIT-1 IN	110.00	LF		\$	
0140	04811		ELECTRICAL JUNCTION BOX TYPE B	10.00	EACH		\$	
0150	04820		TRENCHING AND BACKFILLING	1,005.00	LF		\$	
0160	04830		LOOP WIRE	4,150.00	LF		\$	
0170	04850		CABLE-NO. 14/1 PAIR	7,490.00	LF		\$	
0180	04895		LOOP SAW SLOT AND FILL	1,525.00	LF		\$	
0190	06510		PAVE STRIPING-TEMP PAINT-4 IN	75,000.00	LF		\$	
0200	06514		PAVE STRIPING-PERM PAINT-4 IN	162,075.00	LF		\$	
0210	06566		PAVE MARKING-THERMO X-WALK-12 IN	550.00	LF		\$	
0220	06568		PAVE MARKING-THERMO STOP BAR-24IN	654.00	LF		\$	
0230	06569		PAVE MARKING-THERMO CROSS-HATCH	46,424.00	SQFT		\$	
0240	06573		PAVE MARKING-THERMO STR ARROW	4.00	EACH		\$	
0250	06574		PAVE MARKING-THERMO CURV ARROW	36.00	EACH		\$	
0260	06600		REMOVE PAVEMENT MARKER TYPE V	1,500.00	EACH		\$	
0270	10020NS		FUEL ADJUSTMENT	27,763.00	DOLL	\$1.00	\$	\$27,763.00
0280	10030NS		ASPHALT ADJUSTMENT	69,732.00	DOLL	\$1.00	\$	\$69,732.00
0290	20997ED		REMOVE TRAFFIC ISLAND	3,640.00	SQYD		\$	
0300	23821EC		CENTERLINE RUMBLE STRIPS-12 IN	21,025.00	LF		\$	
0310	24900EC		PVC CONDUIT-1 1/4 IN-SCHEDULE 80	1,005.00	LF		\$	
0320	24963ED		LOOP TEST	20.00	EACH		\$	

Section: 0002 - DEMOBILIZATION

LINE	BID CODE	ALT	DESCRIPTION	QUANTITY	UNIT	UNIT PRIC	FP	AMOUNT
0330	02569		DEMOBILIZATION	1.00	LS		\$	