



CALL NO. 330

CONTRACT ID. 191077

POWELL COUNTY

FED/STATE PROJECT NUMBER FD39 099 2026 002-004

DESCRIPTION MAPLE STREET(KY-2026)

WORK TYPE ASPHALT PAVEMENT & ROADWAY REHAB

PRIMARY COMPLETION DATE 7/1/2020

LETTING DATE: November 22,2019

Sealed Bids will be received electronically through the Bid Express bidding service until 10:00 AM EASTERN STANDARD TIME November 22,2019. Bids will be publicly announced at 10:00 AM EASTERN STANDARD TIME.

NO PLANS ASSOCIATED WITH THIS PROJECT.

REQUIRED BID PROPOSAL GUARANTY: Not less than 5% of the total bid.

TABLE OF CONTENTS

PART I	SCOPE OF WORK
	<ul style="list-style-type: none">• PROJECT(S), COMPLETION DATE(S), & LIQUIDATED DAMAGES• CONTRACT NOTES• STATE CONTRACT NOTES• ASPHALT MIXTURE• DGA BASE• DGA BASE FOR SHOULDERS• INCIDENTAL SURFACING• COMPACTION OPTION B• SPECIAL NOTE(S) APPLICABLE TO PROJECT
PART II	SPECIFICATIONS AND STANDARD DRAWINGS
	<ul style="list-style-type: none">• SPECIFICATIONS REFERENCE• SUPPLEMENTAL SPECIFICATION• [SN-1I] PORTABLE CHANGEABLE SIGNS
PART III	EMPLOYMENT, WAGE AND RECORD REQUIREMENTS
	<ul style="list-style-type: none">• LABOR AND WAGE REQUIREMENTS• EXECUTIVE BRANCH CODE OF ETHICS• KENTUCKY EQUAL EMPLOYMENT OPPORTUNITY ACT OF 1978 LOCALITY / STATE• PROJECT WAGE RATES / STATE FUNDED
PART IV	INSURANCE
PART V	BID ITEMS

PART I
SCOPE OF WORK

ADMINISTRATIVE DISTRICT - 10

CONTRACT ID - 191077

FD39 099 2026 002-004

COUNTY - POWELL

PCN - DE09920261949

FD39 099 2026 002-004

MAPLE STREET(KY-2026) (MP 2.0) ASPHALT PAVEMENT REHABILITATION AND CULVERT REPLACEMENT ON
KY-2026 FROM MP 2.0 TO MP 4.2 (MP 4.2), A DISTANCE OF 02.20 MILES.ASPHALT PAVEMENT & ROADWAY
REHAB

GEOGRAPHIC COORDINATES LATITUDE 83:51:43.00 LONGITUDE 37:51:14.00

COMPLETION DATE(S):

COMPLETED BY 07/01/2020

APPLIES TO ENTIRE CONTRACT

CONTRACT NOTES

PROPOSAL ADDENDA

All addenda to this proposal must be applied when calculating bid and certified in the bid packet submitted to the Kentucky Department of Highways. Failure to use the correct and most recent addenda may result in the bid being rejected.

BID SUBMITTAL

Bidder must use the Department's electronic bidding software. The Bidder must download the bid file located on the Bid Express website (www.bidx.com) to prepare a bid packet for submission to the Department. The bidder must submit electronically using Bid Express.

JOINT VENTURE BIDDING

Joint venture bidding is permissible. All companies in the joint venture must be prequalified in one of the work types in the Qualifications for Bidders for the project. The bidders must get a vendor ID for the joint venture from the Division of Construction Procurement and register the joint venture as a bidder on the project. Also, the joint venture must obtain a digital ID from Bid Express to submit a bid. A joint bid bond of 5% may be submitted for both companies or each company may submit a separate bond of 5%.

UNDERGROUND FACILITY DAMAGE PROTECTION

The contractor shall make every effort to protect underground facilities from damage as prescribed in the Underground Facility Damage Protection Act of 1994, Kentucky Revised Statute KRS 367.4901 to 367.4917. It is the contractor's responsibility to determine and take steps necessary to be in compliance with federal and state damage prevention directives. When prescribed in said directives, the contractor shall submit Excavation Locate Requests to the Kentucky Contact Center (KY811) via web ticket entry. The submission of this request does not relieve the contractor from the responsibility of contacting non-member facility owners, whom shall be contacted through their individual Protection Notification Center. Non-compliance with these directives can result in the enforcement of penalties.

REGISTRATION WITH THE SECRETARY OF STATE BY A FOREIGN ENTITY

Pursuant to KRS 176.085(1)(b), an agency, department, office, or political subdivision of the Commonwealth of Kentucky shall not award a state contract to a person that is a foreign entity required by [KRS 14A.9-010](#) to obtain a certificate of authority to transact business in the Commonwealth ("certificate") from the Secretary of State under [KRS 14A.9-030](#) unless the person produces the certificate within fourteen (14) days of the bid or proposal opening. If the foreign entity is not required to obtain a certificate as provided in [KRS 14A.9-010](#), the foreign entity should identify the applicable exception. Foreign entity is defined within [KRS 14A.1-070](#).

For all foreign entities required to obtain a certificate of authority to transact business in the Commonwealth, if a copy of the certificate is not received by the contracting agency within the time frame identified above, the foreign entity's solicitation response shall be deemed non-responsive or the awarded contract shall be cancelled.

Businesses can register with the Secretary of State at <https://secure.kentucky.gov/sos/ftbr/welcome.aspx>.

SPECIAL NOTE FOR PROJECT QUESTIONS DURING ADVERTISEMENT

Questions about projects during the advertisement should be submitted in writing to the Division of Construction Procurement. This may be done by fax (502) 564-7299 or email to kytc.projectquestions@ky.gov. The Department will attempt to answer all submitted questions. The Department reserves the right not to answer if the question is not pertinent or does not aid in clarifying the project intent.

The deadline for posting answers will be 3:00 pm Eastern Daylight Time, the day preceding the Letting. Questions may be submitted until this deadline with the understanding that the later a question is submitted, the less likely an answer will be able to be provided.

The questions and answers will be posted for each Letting under the heading "Questions & Answers" on the Construction Procurement website (www.transportation.ky.gov/contract). The answers provided shall be considered part of this Special Note and, in case of a discrepancy, will govern over all other bidding documents.

HARDWOOD REMOVAL RESTRICTIONS

The US Department of Agriculture has imposed a quarantine in Kentucky and several surrounding states, to prevent the spread of an invasive insect, the emerald ash borer. Hardwood cut in conjunction with the project may not be removed from the state. Chipping or burning on site is the preferred method of disposal.

INSTRUCTIONS FOR EXCESS MATERIAL SITES AND BORROW SITES

Identification of excess material sites and borrow sites shall be the responsibility of the Contractor. The Contractor shall be responsible for compliance with all applicable state and federal laws and may wish to consult with the US Fish and Wildlife Service to seek protection under Section 10 of the Endangered Species Act for these activities.

ACCESS TO RECORDS

The contractor, as defined in KRS 45A.030 (9) agrees that the contracting agency, the Finance and Administration Cabinet, the Auditor of Public Accounts, and the Legislative Research Commission, or their duly authorized representatives, shall have access to any books, documents, papers, records, or other evidence, which are directly pertinent to this contract for the purpose of financial audit or program review. Records and other prequalification information confidentially

disclosed as part of the bid process shall not be deemed as directly pertinent to the contract and shall be exempt from disclosure as provided in KRS 61.878(1)(c). The contractor also recognizes that any books, documents, papers, records, or other evidence, received during a financial audit or program review shall be subject to the Kentucky Open Records Act, KRS 61.870 to 61.884.

In the event of a dispute between the contractor and the contracting agency, Attorney General, or the Auditor of Public Accounts over documents that are eligible for production and review, the Finance and Administration Cabinet shall review the dispute and issue a determination, in accordance with Secretary's Order 11-004.

April 30, 2018

SPECIAL NOTE FOR RECIPROCAL PREFERENCE

RECIPROCAL PREFERENCE TO BE GIVEN BY PUBLIC AGENCIES TO RESIDENT BIDDERS

By reference, KRS 45A.490 to 45A.494 are incorporated herein and in compliance regarding the bidders residency. Bidders who want to claim resident bidder status should complete the Affidavit for Claiming Resident Bidder Status along with their bid in the electronic bidding software. Submittal of the Affidavit should be done along the bid in Bid Express.

April 30, 2018

ASPHALT MIXTURE

Unless otherwise noted, the Department estimates the rate of application for all asphalt mixtures to be 110 lbs/sy per inch of depth.

DGA BASE

Unless otherwise noted, the Department estimates the rate of application for DGA Base to be 115 lbs/sy per inch of depth.

DGA BASE FOR SHOULDERS

Unless otherwise noted, the Department estimates the rate of application for DGA Base for Shoulders to be 115 lbs/sy per inch of depth. The Department will not measure necessary grading and/or shaping of existing shoulders prior to placing of DGA Base, but shall be incidental to the Contract unit price per ton for DGA Base.

Accept payment at the Contract unit price per ton as full compensation for all labor, materials, equipment, and incidentals for grading and/or shaping of existing shoulders and furnishing, placing, and compacting the DGA Base.

INCIDENTAL SURFACING

The Department has included in the quantities of asphalt mixtures established in the proposal estimated quantities required for resurfacing or surfacing mailbox turnouts, farm field entrances, residential and commercial entrances, curve widening, ramp gores and tapers, and road and street approaches, as applicable. Pave these areas to the limits as shown on Standard Drawing RPM-110-06 or as directed by the Engineer. In the event signal detectors are present in the intersecting streets or roads, pave the crossroads to the right of way limit or back of the signal detector, whichever is the farthest back of the mainline. Surface or resurface these areas as directed by the Engineer. The Department will not measure placing and compacting for separate payment but shall be incidental to the Contract unit price for the asphalt mixtures.

OPTION B

Be advised that the Department will control and accept compaction of asphalt mixtures furnished on this project under OPTION B in accordance with Sections 402 and 403.

POWELL COUNTY
KY 2026
MAPLE STREET
(M.P. 2.0 – M.P. 4.2)
CULVERT REPLACEMENT
& ROADWAY REHABILITATION
PROJECT #: CB01 099 2026 003-004
PROGRAM CODE #: 95055
PROJECT #: FD39 099 2026 002-004
PROGRAM CODE #: 10349

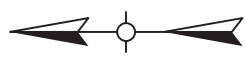
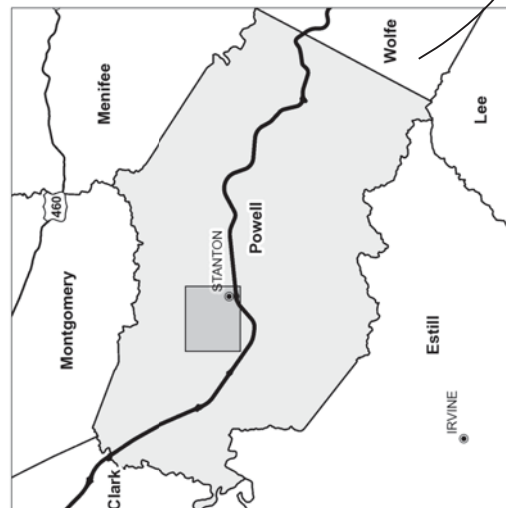
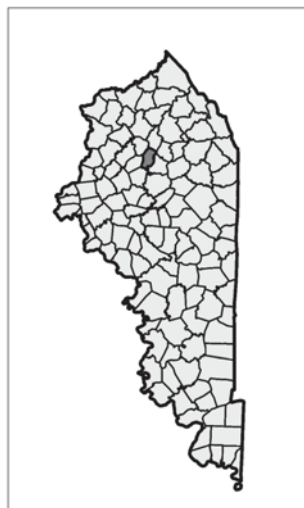
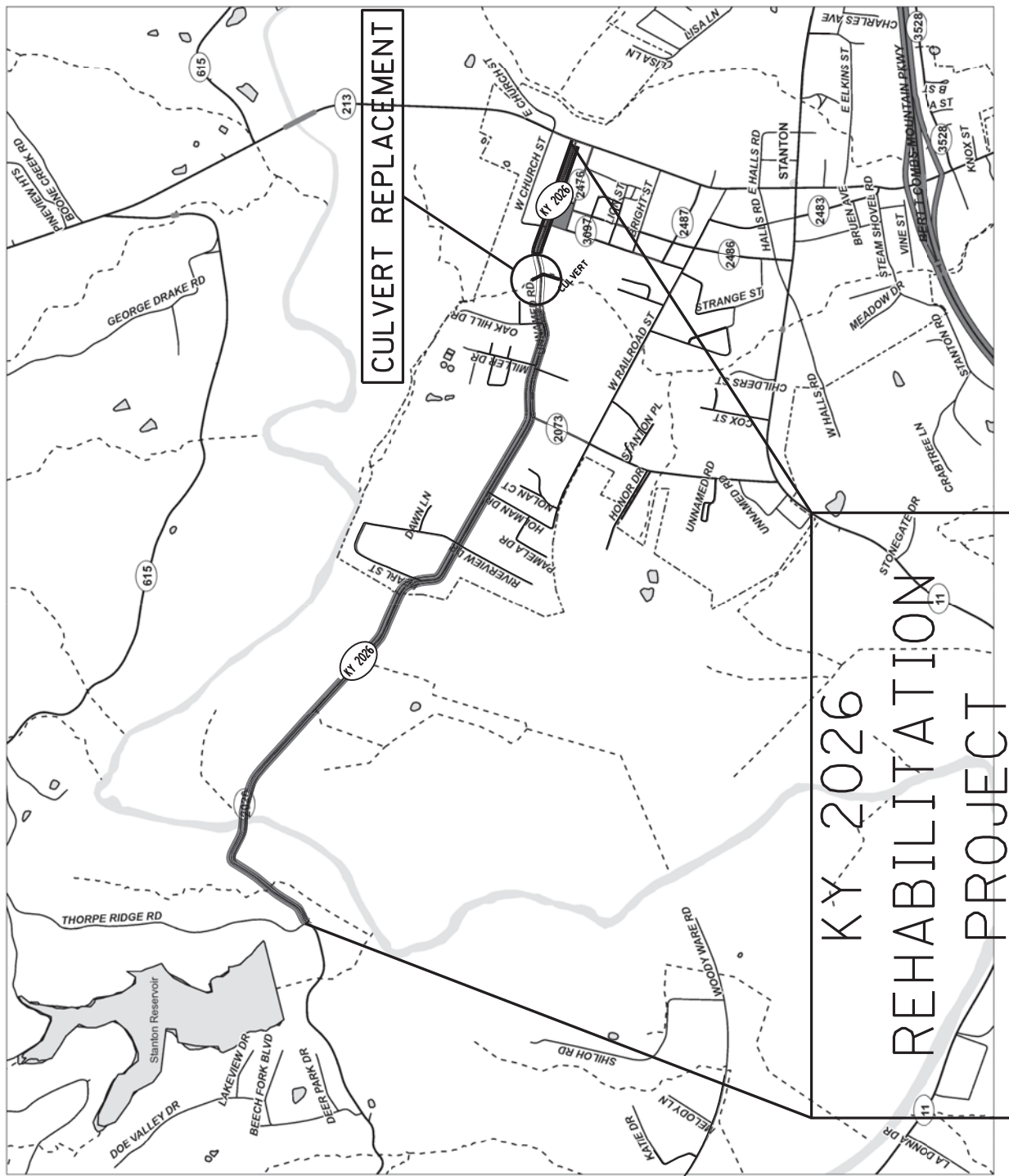

POWELL COUNTY
 KY 2026 (MAPLE STREET)
 CULVERT REPLACEMENT
 & ROADWAY REHABILITATION

BASE FAILURE

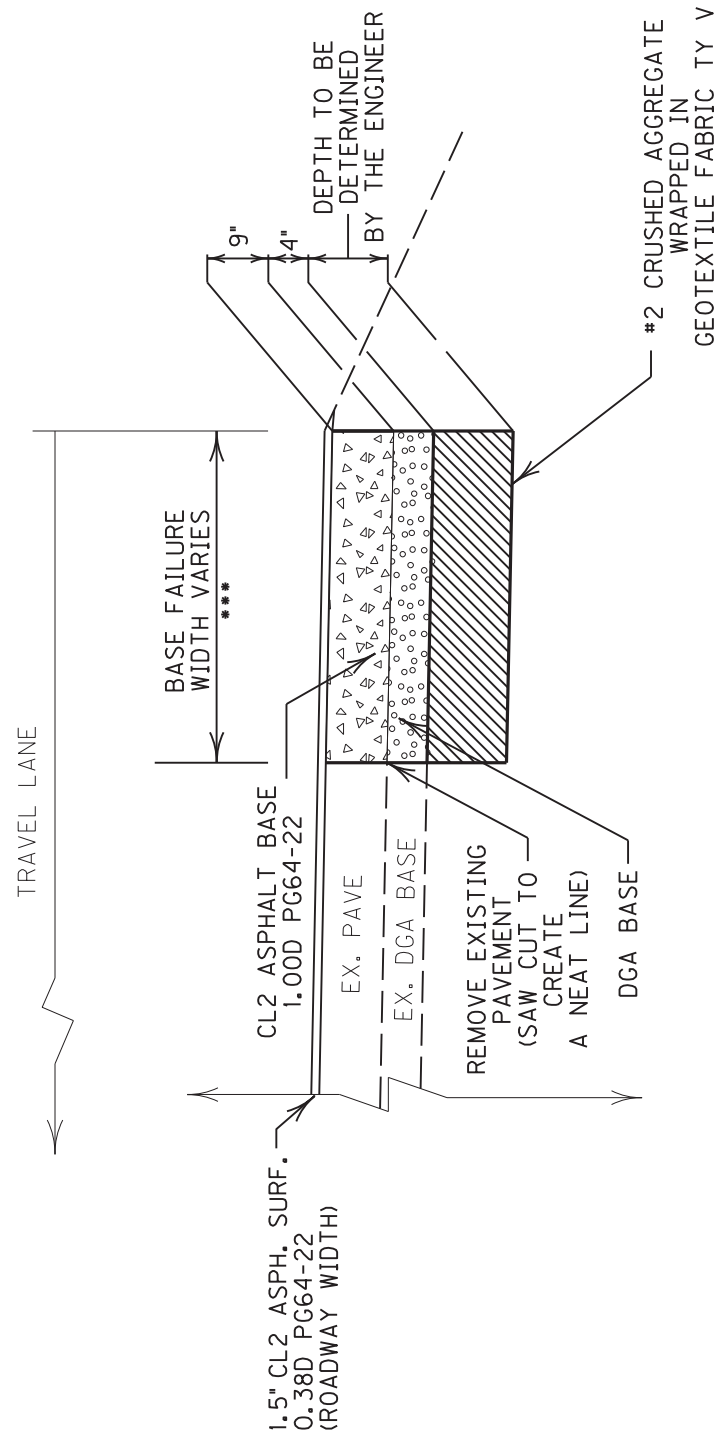

*** SEE BASE FAILURES SPREADSHEET FOR LOCATIONS AND DIMENSIONS.

REFER TO THE "BASE FAILURES" SPECIAL NOTE FOR MORE INFORMATION.

THE ENGINEER WILL MAKE THE FINAL DETERMINATION AS TO CONDITIONS THAT ARE APPROPRIATE FOR THIS TYPICAL SECTION

TYPICAL SECTIONS

DETAIL SHEET
 1 OF 3

POWELL COUNTY
KY 2026 (MAPLE STREET)
CULVERT REPLACEMENT
& ROADWAY REHABILITATION

DITCH ROCK LINING

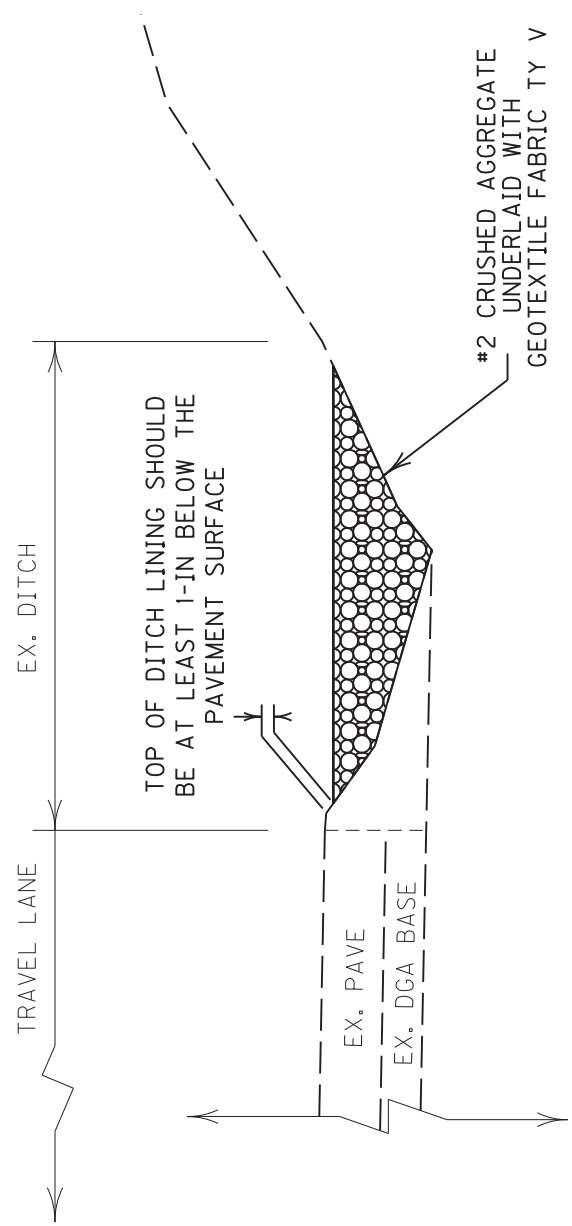

SECTION 1 - WB FROM MP 2.965 TO MP 3.125 (845 FT)
 SECTION 2 - WB FROM MP 3.720 TO MP 3.755 (185 FT)

THE ENGINEER WILL MAKE THE FINAL DETERMINATION AS TO CONDITIONS THAT ARE APPROPRIATE FOR THIS TYPICAL SECTION

TYPICAL SECTIONS

DETAIL SHEET
2 OF 3

POWELL COUNTY
KY 2026 (MAPLE STREET)
CULVERT REPLACEMENT
& ROADWAY REHABILITATION

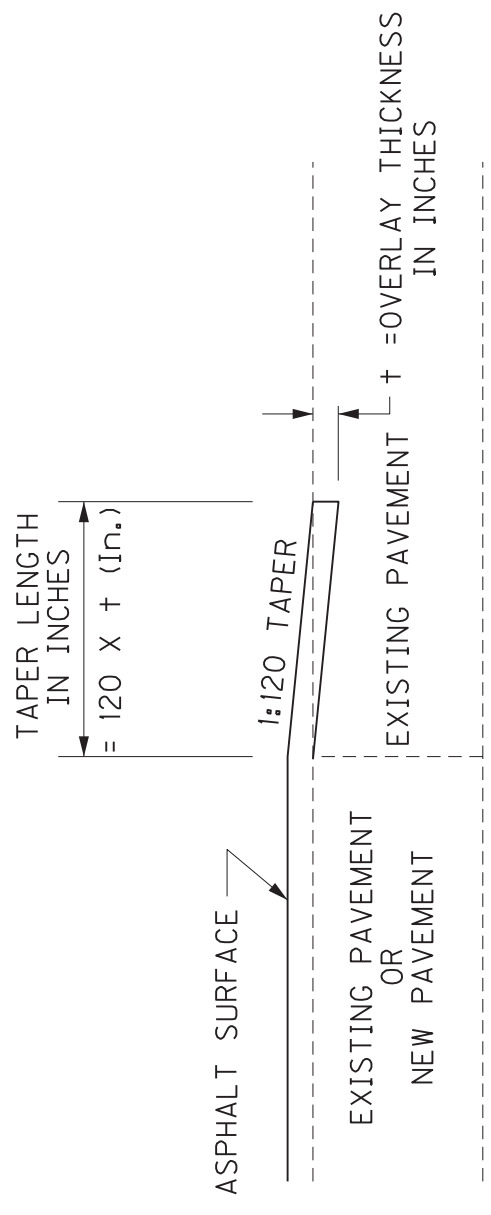

TAPERING OF OVERLAYS ON LOW SPEED FACILITIES (< 45 MPH)

OVERLAY THICKNESS = 1.5 IN
TAPER LENGTH = 120 X 1.5 IN = 180 IN/12 = 15 FEET
SEE RESURFACING SPREADSHEET FOR LOCATIONS

TYPICAL SECTIONS

DETAIL SHEET
3 OF 3

BASE FAILURE REPAIR

Beginning Mile Point	Ending Mile Point	DIRECTION	Length (Feet)	Width (Feet)	4" DGA BASE (Ton)	9" CL 2 Asph Base 0.75D PG 64-22 (Ton)	0.5" Level & Wedge (Ton)
3.998	3.935	WB	333	6.5	55	119	6.6
3.764	3.760	WB	21	6.5	4	8	0.4
3.711	3.706	EB	26	6.5	4	9	0.5
3.640	3.632	EB	42	6.5	7	15	0.8
3.608	3.591	WB	90	6.5	15	32	1.8
3.455	3.452	EB	16	6.5	3	6	0.3
3.321	3.303	WB	95	6.5	16	34	1.9
3.297	3.288	WB	48	6.5	8	17	0.9
3.165	3.127	WB	201	6.5	33	72	4.0
3.103	3.094	WB	48	6.5	8	17	0.9
3.044	3.021	WB	121	6.5	20	43	2.4
3.032	2.995	EB	195	6.5	32	70	3.9
3.011	2.972	WB	206	6.5	34	74	4.1
2.950	2.929	WB	111	6.5	18	40	2.2
2.921	2.893	WB	148	6.5	25	53	2.9
2.831	2.816	WB	79	6.5	13	28	1.6
2.782	2.749	WB	174	10	45	96	5.3
2.719	2.698	EB	111	10	28	61	3.4
2.683	2.676	WB	37	6.5	6	13	0.7
2.672	2.663	CL	48	10	12	26	1.5
2.636	2.621	CL	79	10	20	44	2.4
2.538	2.523	WB	79	6.5	13	28	1.6
2.533	2.523	EB	53	6.5	9	19	1.0
2.514	2.510	EB	21	6.5	4	8	0.4
2.440	2.436	EB	21	6.5	4	8	0.4
2.440	2.413	WB	143	6.5	24	51	2.8
2.406	2.403	CL	16	10	4	9	0.5
2.283	2.267	WB	84	6.5	14	30	1.7

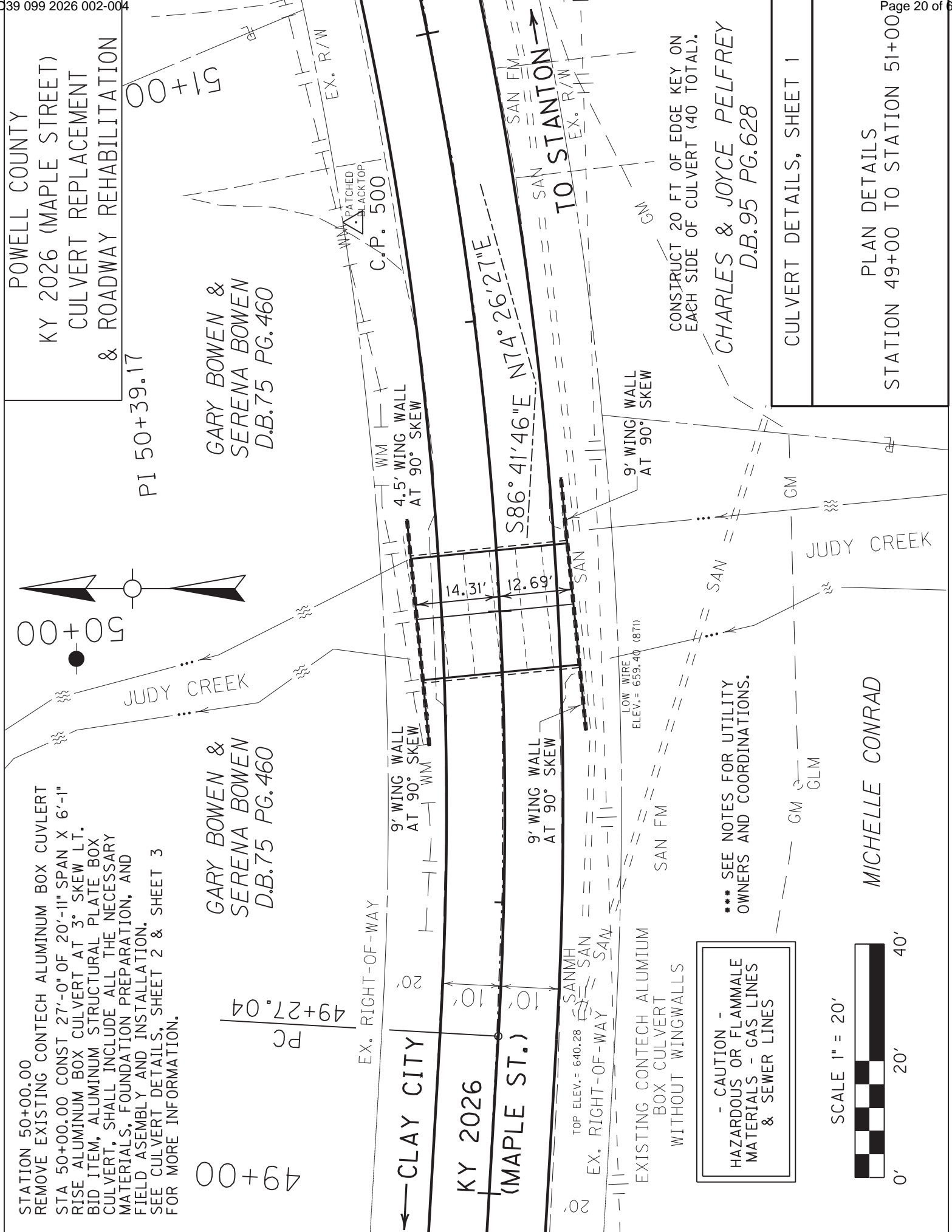

POWELL COUNTY
KY 206 (MAPLE STREET)
CULVERT REPLACEMENT
& ROADWAY REHABILITATION

PI 50+39.17

GARY BOWEN &
SERENA BOWEN
D.B.75 PG.460

GARY BOWEN &
SERENA BOWEN
D.B.75 PG.460

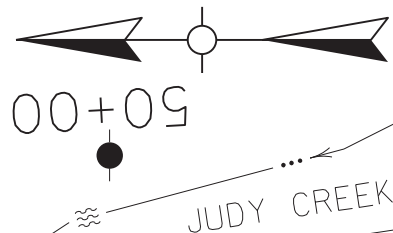

STATION 50+00.00
REMOVE EXISTING CONTECH ALUMINUM BOX CULVERT
STA 50+00.00 CONST 27'-0" OF 20'-11" SPAN X 6'-1"
RISE ALUMINUM BOX CULVERT AT 3° SKEW LT.
BID ITEM, ALUMINUM STRUCTURAL PLATE BOX
CULVERT, SHALL INCLUDE ALL THE NECESSARY
MATERIALS, FOUNDATION PREPARATION, AND
FIELD ASSEMBLY AND INSTALLATION.
SEE CULVERT DETAILS, SHEET 2 & SHEET 3
FOR MORE INFORMATION.

49+00

49+27.04
PC

EX. RIGHT-OF-WAY

CLAY CITY
KY 206
(MAPLE ST.)

TOP ELEV. = 640.28
EX. RIGHT-OF-WAY

EXISTING CONTECH ALUMINUM
BOX CULVERT
WITHOUT WINGWALLS

- CAUTION -
HAZARDOUS OR FLAMMABLE
MATERIALS - GAS LINES
& SEWER LINES

SCALE 1" = 20'

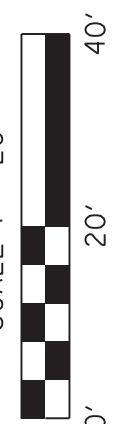

MICHELLE CONRAD

*** SEE NOTES FOR UTILITY
OWNERS AND COORDINATIONS.

LOW WIRE
ELEV. = 659.40 (871)

JUDY CREEK

9' WING WALL
AT 90° SKEW

4.5' WING WALL
AT 90° SKEW

S86° 41' 46" E N74° 26' 27" E

TO STANTON

CONSTRUCT 20 FT OF EDGE KEY ON
EACH SIDE OF CULVERT (40 TOTAL).

CHARLES & JOYCE PELFREY
D.B.95 PG.628

CULVERT DETAILS, SHEET 1

PLAN DETAILS
STATION 49+00 TO STATION 51+00

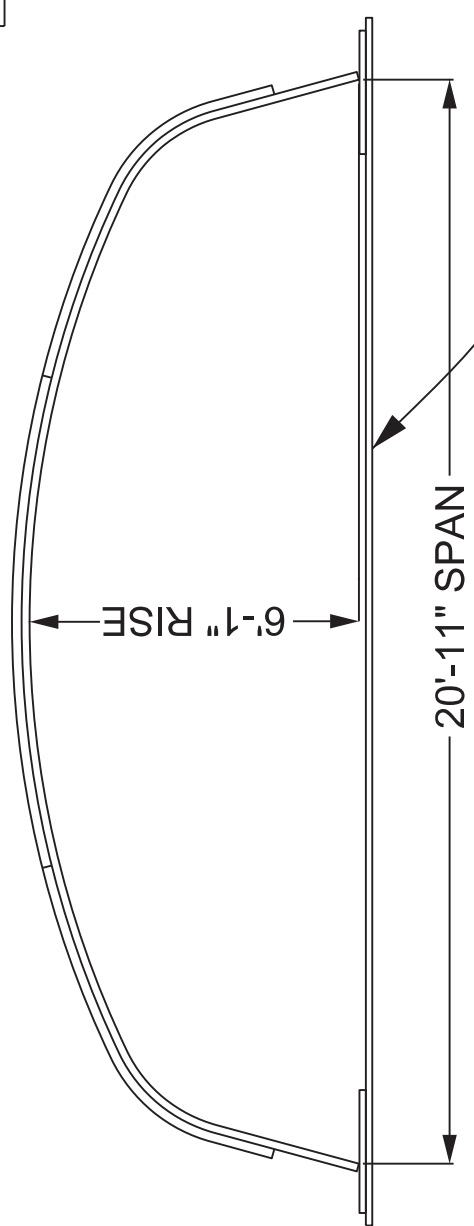

ALUMINUM BOX CULVERT SHALL HAVE A FULL INVERT.

SHOWN IN THIS DRAWING IS:
 ALUMINUM BOX CULVERT 20'-11" SPAN X 6'-1" RISE (1.4' MIN. COVER HEIGHT, 4' MAX. COVER HEIGHT) WITH FULL INVERT, LISTED OPEN AREA OF 54.4 SQ. FT.

***THE DIMENSIONS OF THE CULVERT SHOWN ON THE PLAN ARE FOR AN ALUMINUM BOX CULVERT WITH 6 PANELS (4.5 FT PER PANEL, 27 FT TOTAL). HOWEVER, THE CONTRACTOR SHALL ORDER THE SAME STRUCTURE WITH AN EXTRA PANEL (31.5 FT TOTAL). AFTER DETERMINED THE EXACT LOCATION AND ELEVATION OF THE UTILITIES, THE CONTRACTOR SHALL DISCUSS WITH THE ENGINEER ABOUT THE POSSIBILITY OF INSTALLING THE 7-PANEL STRUCTURE AT THIS LOCATION. THE ENGINEER WILL MAKE THE FINAL DECISION ON WHETHER A 6-PANEL STRUCTURE OR A 7-PANEL STRUCTURE SHOULD BE USED.

DUE TO COVER HEIGHT LIMITATION, 10" CONCRETE PAVEMENT ONTOP OF DGA BASE IS RECOMMENDED FOR THIS AREA. DEVIATION TO THE PAVEMENT DESIGN SHALL BE APPROVED BY THE ENGINEER. (10" JPC PAVEMENT + 6.8" DGA BASE)

OTHER ALTERNATES THAT MEET THE FOLLOWING REQUIREMENTS WILL ALSO BE ACCEPTABLE IF:

- 1) APPROVED BY THE RESIDENT ENGINEER.
- 2) OPEN AREA EQUAL TO OR GREATER THAN 105.5 SQ. FT.
- 3) STRUCTURE MUST BE OF A SINGLE SPAN DESIGN.
- 4) COMPLY WITH THE PROJECT MOT NOTES.
- 5) MEET MINIMUM COVER HEIGHT REQUIREMENT.

CULVERT DETAILS, SHEET 2
CULVERT SPECIFICATIONS

POWELL COUNTY
KY 2026 (MAPLE STREET)
CULVERT REPLACEMENT
& ROADWAY REHABILITATION

GENERAL NOTES

1. DIMENSIONS SHOWN ARE APPROXIMATE AND INTENDED TO CONVEY ENOUGH INFORMATION TO DEVELOP DETAIL STRUCTURAL DRAWINGS AND BIDDING DOCUMENTS. IF THE CONTRACTOR DESIRES TO MODIFY THIS LAYOUT, NO PAYMENT ADJUSTMENTS WILL BE ALLOWED.
2. IF AN ALTERNATE IS USED THAT REQUIRES MODIFICATIONS TO LAYOUT OR ROADWAY PROFILE, NO PAYMENT ADJUSTMENTS WILL BE ALLOWED.
3. ALL WORK TO CONSTRUCT THE BOX CULVERT IS PAID FOR UNDER THE BID ITEM "ALUMINUM STRUCTURAL PLATE BOX CULVERT." THIS BID ITEM IS A LUMP SUM BID ITEM THAT COVERS ALL WORK TO CONSTRUCT AND INSTALL THE CULVERT AND ALL THE REQUIRED EROSION CONTROL DEVICES AT THE CULVERT LOCATION. THE FOLLOWING ITEMS SHALL BE CONSIDERED INCIDENTAL TO THE STRUCTURE: STRUCTURE EXCAVATION, BACKFILLS AND ALL ITEMS NECESSARY TO CONSTRUCT HEADWALLS AND WINGWALLS. ALSO INCLUDED IN THIS BID ITEM ARE ALL WORK AND MATERIALS REQUIRED TO OBTAIN A MINIMUM BEARING CAPACITY OF 4,000 PSF.
- THE CONTRACTOR IS RESPONSIBLE FOR LOCATING A SUITABLE AREA FOR ASSEMBLY OF THE ALUMINUM BOX CULVERT.
4. ALL COMPONENTS MUST BE DESIGNED TO MEET STRUCTURAL REQUIREMENTS AS SET FORTH FOR EARTH, DEAD, AND HL-93 LIVE LOAD IN AASHTO LRFD BRIDGE DESIGN SPECIFICATIONS, WITH INTERIMS. ALL DESIGNS SUBMITTED FOR CONSIDERATION MUST BE PERFORMED AND STAMPED BY A QUALIFIED PROFESSIONAL ENGINEER LICENSED TO PRACTICE IN THE STATE OF KENTUCKY.
5. NO GEOTECHNICAL INVESTIGATION HAS BEEN PERFORMED FOR THIS PROJECT. A VISUAL INSPECTION IN THE FIELD SHOWS THE STREAM TO BE FLOWING ON A SOLID ROCK STREAMBED. IF AN ALTERNATE STRUCTURE IS USED IT IS THE RESPONSIBILITY OF THE CONTRACTOR TO ENSURE FOUNDATION MEETS THE MANUFACTURES STRUCTURAL REQUIREMENTS. ANY EXTRA WORK THAT MAY BE REQUIRED FOR THIS WILL BE CONSIDERED INCIDENTAL TO THE BID AND NO PAYMENT ADJUSTMENTS WILL BE ALLOWED.
6. ALL MATERIALS USED MUST BE IN CONFORMANCE WITH KYTC STANDARD SPECIFICATIONS FOR ROAD AND BRIDGE CONSTRUCTION, THE KYTC LIST OF APPROVED MATERIALS, AND ALL APPLICABLE ASTM AND AASHTO STANDARDS.
7. COMPLY WITH SECTION 106.04 OF THE STANDARD SPECIFICATIONS FOR ROAD AND BRIDGE CONSTRUCTION BUY AMERICAN REQUIREMENT.
8. BOX CULVERT STRUCTURES THAT REQUIRE SPECIAL BACKFILL CONTRARY TO KYTC STANDARD SPECIFICATIONS FOR ROAD AND BRIDGE CONSTRUCTION WILL REQUIRE A CERTIFICATION LETTER STATING THAT THE BACKFILL WAS CONSTRUCTED PROPERLY. THE LETTER WILL BE SIGNED BY THE CONTRACTOR AND THE MANUFACTURER OF THE BOX CULVERT STRUCTURE AND WILL BE SUBMITTED TO THE RESIDENT ENGINEER.
9. THE MANUFACTURER OR SUPPLIER MUST PROVIDE 6 COPIES OF DETAILED SHOP DRAWINGS FOR FINAL APPROVAL FOR USE ON THIS PROJECT. BACKFILL REQUIREMENTS AND ANY SPECIFICATIONS THAT ARE CONTRARY TO THE KYTC STANDARD SPECIFICATIONS FOR ROAD AND BRIDGE CONSTRUCTION SHOULD BE SUPPLIED AS WELL. INCLUDE ONE SET OF STRUCTURAL DESIGN CALCULATIONS FOR REVIEW AND ARCHIVAL PURPOSES. THIS INFORMATION WILL BE SUBMITTED TO THE DIVISION OF CONSTRUCTION. ALLOW 4 WEEKS TIME FOR REVIEW OF THIS MATERIAL.
10. SKEW OF THE ALUMINUM BOX CULVERT & WINGWALL ANGLES MAY BE REVISED AT THE DISCRETION OF THE PROJECT ENGINEER.

CULVERT DETAILS, SHEET 3

GENERAL NOTES

KY 2026 COORDINATE CONTROL
 KENTUCKY SINGLE ZONE

CONTROL POINT 501 (OUTSIDE PLAN SHEET)
 X = 5466051.1051
 Y = 3840216.6179
 ELEV = 641.3979'

CONTROL POINT 500
 X = 5466340.2378
 Y = 3840243.8118
 ELEV = 640.1927'

CENTERLINE

Project Name: KY 2026

	STATION	NORTHING	EASTING
Element: Linear			
POB ()	47+79.99	3840227.87	5466053.76
PC ()	49+27.04	3840219.40	5466200.56
Tangent Direction:	S 86°41'46" E		
Tangent Length:	147.05		
Element: Circular			
PC ()	49+27.04	3840219.40	5466200.56
PI ()	50+39.17	3840212.94	5466312.50
CC ()		3840893.28	5466239.46
PT ()	51+49.27	3840243.01	5466420.52
Radius:	675.00		
Delta:	18°51'47" Left		
Degree of Curvature(Arc):	8°29'18"		
Length:	222.22		
Tangent:	112.13		
Chord:	221.22		
Middle Ordinate:	9.12		
External:	9.25		
Tangent Direction:	S 86°41'46" E		
Radial Direction:	S 3°18'14" W		
Chord Direction:	N 83°52'20" E		
Radial Direction:	S 15°33'33" E		
Tangent Direction:	N 74°26'27" E		
Element: Linear			
PT ()	51+49.27	3840243.01	5466420.52
PC ()	52+02.68	3840257.34	5466471.98
Tangent Direction:	N 74°26'27" E		
Tangent Length:	53.41		
Element: Circular			
PC ()	52+02.68	3840257.34	5466471.98
PI ()	52+93.04	3840281.58	5466559.03
CC ()		3839987.60	5466547.08
PT ()	53+77.50	3840250.36	5466643.83
Radius:	280.00		
Delta:	35°46'20" Right		
Degree of Curvature(Arc):	20°27'46"		
Length:	174.82		
Tangent:	90.36		

tes
Chord: 171.99
Middle Ordinate: 13.53
External: 14.22
Tangent Direction: N 74^26' 27" E
Radial Direction: S 15^33' 33" E
Chord Direction: S 87^40' 23" E
Radial Direction: S 20^12' 47" W
Tangent Direction: S 69^47' 13" E

Element: Linear
PT () 53+77.50 3840250.36 5466643.83
POE () 54+64.09 3840220.44 5466725.09
Tangent Direction: S 69^47' 13" E
Tangent Length: 86.60

GENERAL NOTES

165. BEFORE YOU DIG

THE CONTRACTOR IS INSTRUCTED TO CALL 1-800-752-6007 TO REACH KY 811, THE ONE-CALL SYSTEM FOR INFORMATION ON THE LOCATION OF EXISTING UNDERGROUND UTILITIES. THE CALL IS TO BE PLACED A MINIMUM OF TWO (2) AND NO MORE THAN TEN (10) DAYS PRIOR TO EXCAVATION. THE CONTRACTOR SHOULD BE AWARE THAT OWNERS OF UNDERGROUND FACILITIES ARE NOT REQUIRED TO BE MEMBERS OF THE KY 811 ONE-CALL BEFORE-U-DIG(BUD) SERVICE. THE CONTRACTOR MUST COORDINATE EXCAVATION WITH THE UTILITY OWNERS, INCLUDING THOSE WHOM DO NOT SUBSCRIBE KY 811. IT MAY BE NECESSARY FOR THE CONTRACTOR TO CONTACT THE COUNTY COURT CLERK TO DETERMINE WHAT UTILITY COMPANIES HAVE FACILITIES IN THE AREA.

448. COMPACTION OF ASPHALT MIXTURES

THE DEPARTMENT WILL ACCEPT THE COMPACTION OF ASPHALT MIXTURES FURNISHED ON THIS PROJECT BY OPTION B ACCORDING TO SUBSECTIONS 402.03.02 AND 402.03.10 OF THE STANDARD SPECIFICATIONS.

650. STANDARD DRAWINGS

STANDARD DRAWINGS ARE NOT ATTACHED TO THESE PLANS. A STANDARD DRAWING BOOK AND THE HEADWALL SUPPLEMENTAL BOOK MAY BE OBTAINED FROM THE POLICY SUPPORT BRANCH OF THE DEPARTMENT OF ADMINISTRATIVE SERVICES IN FRANKFORT, KY, AT (502)564-3670.

ASPHALT MILLING

ALL THE ASPHALT MILLING SHALL BECOME THE PROPERTY OF THE CONTRACTOR.

EDGE KEY

THIS WORK INCLUDES CUTTING OUT THE EXISTING ASPHALT SURFACE TO A MINIMUM DEPTH AND WIDTH AS DETAILED ELSEWHERE IN THE PLANS, OR AS DIRECTED BY THE PROJECT ENGINEER, SO THAT THE NEW SURFACE MAY HEEL INTO THE EXISTING SURFACE. THE CONTRACT PRICE PER LINEAR FOOT FOR "EDGE KEY" INCLUDES ALL NECESSARY MATERIALS, LABOR, AND EQUIPMENT NECESSARY TO PERFORM THE WORK AND DISPOSE OF THE REMOVED ASPHALT MATERIAL.

REMOVE STRUCTURE

THE EXISTING STRUCTURE SHALL BE REMOVED IN ACCORDANCE WITH THE STANDARD SPECIFICATIONS. ALL MATERIAL SHALL BECOME THE PROPERTY OF THE CONTRACTOR AND SHALL BE DISPOSED OF IN ACCORDANCE WITH THE STANDARD SPECIFICATIONS. ALL ITEMS AND WORK NECESSARY TO REMOVE THE EXISTING STRUCTURES SHALL BE PAID UNDER THE LUMP SUM ITEM "REMOVE STRUCTURE." THIS INCLUDES BUT NOT LIMITED TO SAW CUTTING EXISTING ASPHALT PAVEMENT.

PROPERTY DAMAGE

THE CONTRACTOR SHALL BE RESPONSIBLE FOR ALL DAMAGE TO PUBLIC AND/OR PRIVATE PROPERTY RESULTING FROM THE WORK. RESTORE ALL DISTURBED FEATURES/AREAS IN LIKE KIND MATERIALS AND DESIGN TO THE EXISTING OR PROPOSED GRADES, AS APPLICABLE, AT NO ADDITIONAL COST TO THE DEPARTMENT OR OWNER.

SEWER MANHOLES

THE CONTRACTOR SHALL EXERCISE CAUTION WHEN WORKING AROUND EXISTING MANHOLES. AS DIRECTED BY THE ENGINEER, ADJUST MILLING AND PAVING AROUND THE MANHOLES TO MINIMIZE ELEVATION DIFFERENCE BETWEEN FINAL PAVEMENT SURFACE AND TOP OF MANHOLES.

TEMPORARY EROSION CONTROL

SEE SPECIAL NOTES FOR EROSION CONTROL.

GENERAL NOTES

POWELL COUNTY
KY 2026 (MAPLE STREET)
CULVERT REPLACEMENT
& ROADWAY REHABILITATION

BEFORE YOU DIG



The contractor is instructed to call 1-800-752-6007 to reach KY 811, the one-call system for information on the location of existing underground utilities. The call is to be placed a minimum of two (2) and no more than ten (10) business days prior to excavation. The contractor should be aware that owners of underground facilities are not required to be members of the KY 811 one-call Before-U-Dig (BUD) service. The contractor must coordinate excavation with the utility owners, including those whom do not subscribe to KY 811. It may be necessary for the contractor to contact the County Court Clerk to determine what utility companies have facilities in the area.

LOCATE EXISTING UTILITIES

UTILITY LOCATIONS SHOWN ON THE PLAN SHEET ARE APPROXIMATE. IT WILL BE THE ROAD CONTRACTOR'S RESPONSIBILITY TO LOCATE UTILITIES BEFORE EXCAVATING BY CALLING THE VARIOUS UTILITY OWNERS AND BY EXAMINING ANY SUPPLEMENTAL INFORMATION PROVIDED BY THE CABINET AND/OR UTILITY OWNER. THE ROAD CONTRACTOR SHALL DETERMINE THE EXACT LOCATION AND ELEVATION OF UTILITIES BY HAND DIGGING OR OTHER METHODS AS APPROVED BY THE ENGINEER TO EXPOSE UTILITIES BEFORE HE EXCAVATES IN THE AREA OF A UTILITY. REPRESENTATIVES FROM UTILITY COMPANIES SHALL BE ON-SITE DURING EXCAVATION. THE COST FOR REPAIR AND ANY OTHER ASSOCIATED COSTS FOR ANY DAMAGE TO UTILITIES CAUSED BY THE ROAD CONTRACTORS OPERATIONS SHALL BE BORNE BY THE ROAD CONTRACTOR.

Electric
170 Halls Lane
Stanton, KY 40380
Todd Peyton
(859)744-4251

Water & Sewer Company
Stanton Water District
525 Washington St.
#107
Stanton, KY 40380
(606)663-6474

Telephone/Telecommunications
AT&T - KY
29 Wills Branch
Prestonsburg, KY 41653
Jack Salyer
(606)424-9328

Red River Waste
321 E College Ave
Stanton, KY 40380
(606)663-9797

Crystal Broadband
P.O. Box 180336
4141 North Kedzie Rd.
Chicago, IL 60618
Janathan Kurien
Operation Manager
(606)663-9328

Detal Nautral Gas
3617 Lexington Road
Winchester, KY 40391
(859)744-6171
Thomas Conlee

UTILITY NOTES / OWNERS

POWELL COUNTY
KY 2026 (MAPLE STREET)
CULVERT REPLACEMENT
& ROADWAY REHABILITATION

GENERAL NOTES

1. THE CONTRACTOR IS RESPONSIBLE FOR DEVELOPING A TRAFFIC CONTROL PLAN. THE TRAFFIC CONTROL PLAN SHALL BE SUBMITTED TO STANTON SECTION SUPERVISOR AND DISTRICT TRAFFIC ENGINEER AT LEAST TWO WEEKS PRIOR TO THE PRE-CONSTRUCTION MEETING. TRAFFIC CONTROL PLAN SHALL BE IN ACCORDANCE WITH THE MANUAL ON UNIFORM TRAFFIC CONTROL DEVICES, THE STANDARD SPECIFICATIONS FOR ROAD AND BRIDGE CONSTRUCTION AND THE STANDARD DRAWINGS, CURRENT EDITIONS. THE TRAFFIC CONTROL PLAN SHALL BE REVIEWED AND APPROVED BY STANTON SECTION SUPERVISOR AND DISTRICT TRAFFIC ENGINEER PRIOR TO ANY CONSTRUCTION.
2. ALL ITEMS OF WORK NECESSARY TO MAINTAIN AND CONTROL TRAFFIC WILL BE PAID AT THE LUMP SUM BID PRICE TO "MAINTAIN AND CONTROL TRAFFIC" AS SET FORTH IN THE CURRENT STANDARD SPECIFICATIONS FOR ROAD AND BRIDGE CONSTRUCTION UNLESS OTHERWISE PROVIDED FOR IN THESE NOTES. THE LUMP SUM BID TO "MAINTAIN AND CONTROL TRAFFIC" SHALL ALSO INCLUDE, BUT IS NOT LIMITED TO, THE FOLLOWING ITEMS AND OPERATIONS:
 - A. ALL LABOR AND MATERIALS NECESSARY FOR CONSTRUCTION AND MAINTENANCE OF TRAFFIC CONTROL DEVICES AND MARKINGS.
 - B. ALL FLAGPERSONS AND TRAFFIC CONTROL DEVICES SUCH AS, BUT NOT LIMITED TO, FLASHERS, SIGNS BARRICADES AND VERTICAL PANELS, PLASTIC DRUMS (STEEL DRUMS WILL NOT BE PERMITTED) AND CONES NECESSARY FOR THE CONTROL AND PROTECTION OF VEHICULAR AND PEDESTRIAN TRAFFIC AS SPECIFIED IN THESE NOTES, THE PLANS, THE MUTCD OR THE ENGINEER.
3. THE ENGINEER AND THE CONTRACTOR, OR THEIR AUTHORIZED REPRESENTATIVES, SHALL REVIEW THE SIGNING BEFORE TRAFFIC IS ALLOWED TO USE ANY LANE CLOSURES, CROSSOVERS OR DETOURS. ALL SIGNING SHALL BE APPROVED BY THE ENGINEER BEFORE WORK CAN BE STARTED BY THE CONTRACTOR.
4. THE CONTRACTOR SHALL SCHEDULE A REVIEW OF FINAL STRIPING PLANS PRIOR TO PLACEMENT WITH PROJECT ENGINEER.
5. ANY TEMPORARY TRAFFIC CONTROL ITEMS, DEVICES, MATERIALS AND INCIDENTALS SHALL REMAIN THE PROPERTY OF THE CONTRACTOR WHEN NO LONGER NEEDED.
6. DURING WORKING HOURS, ONE-WAY TRAFFIC MAY BE ALLOWED AT THE DISCRETION OF THE ENGINEER, PROVIDED ADEQUATE SIGNING AND FLAGPERSONS ARE AT THE LOCATION.
7. THE CONTRACTOR SHALL COMPLETELY COVER ANY SIGNS, EITHER EXISTING, PERMANENT OR TEMPORARY, WHICH DO NOT PROPERLY APPLY TO THE CURRENT TRAFFIC PHASING, AND SHALL MAINTAIN THE COVERING UNTIL THE SIGNS ARE APPLICABLE OR ARE REMOVED.
8. IN GENERAL, ALL TRAFFIC CONTROL DEVICES SHALL BE PLACED STARTING AND PROCEEDING IN THE DIRECTION OF THE FLOW OF TRAFFIC AND REMOVED STARTING AND PROCEEDING IN THE DIRECTION OPPOSITE THE FLOW OF TRAFFIC.
9. ALL KENTUCKY DEPARTMENT OF HIGHWAYS SIGNS (NON-ESSENTIAL AND NON-DIRECTIONAL) SHALL BE REMOVED BY THE CONTRACTOR AT THE DIRECTION OF THE ENGINEER. THE CONTRACTOR IS ADVISED TO SCHEDULE SIGN REMOVAL WITH THE ENGINEER. SIGNS AND POSTS SHALL BE SEPARATED, BONDED ON PALLETS AND DELIVERED TO THE BREATHITT TRAFFIC BARN.
10. IF TRAFFIC SHOULD BE STOPPED DUE TO CONSTRUCTION OPERATIONS AND AN EMERGENCY VEHICLE ON AN OFFICIAL EMERGENCY RUN ARRIVES AT THE SCENE, THE CONTRACTOR SHALL MAKE THE PROVISIONS FOR THE PASSAGE OF THAT VEHICLE AS QUICKLY AS POSSIBLE.
11. THE CONTRACTOR'S VEHICLES SHALL ALWAYS MOVE WITH AND NOT AGAINST THE FLOW OF TRAFFIC. VEHICLES SHALL ENTER AND LEAVE WORK AREAS IN A MANNER WHICH NOT BE HAZARDOUS TO OR INTERFERE WITH NORMAL TRAFFIC. VEHICLES SHALL NOT PARK OR STOP EXCEPT WITHIN WORK AREAS DESIGNATED BY THE ENGINEER.
12. REMOVE ALL PAVEMENT MARKING BY WATER BLASTING PROCESS TO THE SATISFACTION OF THE ENGINEER.
13. PAYMENT FOR SPEED LIMIT SIGNS (INCLUDING MOUNTING HARDWARE AND POSTS) FOR ADVISEMENT OF REDUCED SPEEDS THROUGH THE WORK ZONE SHALL BE ERECTED WHILE THE CONTRACTOR IS WORKING AND BE INCLUDED IN THE LUMP SUM BID TO "MAINTAIN AND CONTROL TRAFFIC."

MAINTENANCE OF TRAFFIC NOTES

POWELL COUNTY
KY 2026 (MAPLE STREET)
CULVERT REPLACEMENT
& ROADWAY REHABILITATION

PAVEMENT DROP-OFF

A PAVEMENT EDGE THAT TRAFFIC IS NOT EXPECTED TO CROSS, EXCEPT ACCIDENTALLY, SHOULD BE TREATED AS FOLLOWS:

- LESS THAN TWO INCHES - NO PROTECTION REQUIRED. WARNING SIGNS SHOULD BE PLACED IN ADVANCE AND THROUGHOUT THE DROP-OFF AREA.
- TWO TO FOUR INCHES - PLASTIC DRUMS, VERTICAL PANELS OR BARRICADES EVERY 100 FEET ON TANGENT SECTIONS FOR SPEEDS OF 50 MPH OR GREATER. CONES MAY BE USED IN PLACE OF PLASTIC DRUMS, PANELS AND BARRICADES DURING DAYLIGHT HOURS. FOR TANGENT SECTIONS WITH SPEEDS LESS THAN 50 MPH AND FOR CURVES, DEVICES SHOULD BE PLACED EVERY 50 FEET. SPACING OF DEVICES ON TAPERED SECTIONS SHOULD BE IN ACCORDANCE WITH THE MANUAL ON UNIFORM TRAFFIC CONTROL DEVICES, CURRENT EDITION.
- GREATER THAN FOUR INCHES - POSITIVE SEPARATION OR WEDGE WITH 3:1 OR FLATTER SLOPE NEEDED. IF THERE IS FIVE FEET OR MORE DISTANCE BETWEEN THE EDGE OF THE PAVEMENT AND THE DROP-OFF, THEN DRUMS, PANEL, OR BARRICADES MAY BE USED. IF THE DROP-OFF IS GREATER THAN 12 INCHES, POSITIVE SEPARATION IS STRONGLY ENCOURAGED. IF CONCRETE BARRIERS ARE USED, SPECIAL REFLECTIVE DEVICES OR STEADY BURN LIGHTS SHOULD BE USED FOR OVERNIGHT INSTALLATIONS. BARRICADES MAY BE USED IF THE DROP-OFF IS GREATER THAN 12 INCHES.

FOR TEMPORARY CONDITIONS, DROP-OFFS GREATER THAN FOUR INCHES MAY BE PROTECTED WITH PLASTIC DRUMS, VERTICAL PANELS OR BARRICADES FOR SHORT DISTANCES DURING DAYLIGHT HOURS WHILE WORK IS BEING DONE IN THE DROP-OFF AREA.

LESSER TREATMENTS THAN THOSE DESCRIBED ABOVE MAY BE CONSIDERED FOR LOW-VOLUME LOCAL STREETS.

PAYMENT WILL BE ALLOWED FOR DGA, CSB AND OTHER SUITABLE MATERIALS USED FOR WEDGING.

PROJECT SPECIFIC TRAFFIC CONTROL NOTES

1. THE CONTRACTOR SHALL REMOVE THE EXISTING STRUCTURES AND INSTALL NEW CULVERT IN A SINGLE 72 HOUR PERIOD. THE CONTRACTOR WILL BE ALLOWED TO CLOSE THE ROADWAY DURING THIS 72 HOUR PERIOD. IF THE ROADWAY IS NOT REOPENED FOR TRAFFIC USAGE AT OR BEFORE THIS TIMEFRAME, A DISINCENTIVE FEE OF \$500 PER HOUR WILL BE CHARGED FOR EACH OF THE FIRST FOUR (4) HOURS OR FRACTION THEREOF PAST THE 72 HOURS ALLOWED. IF THE ROADWAY IS CLOSED FOR MORE THAN FOUR (4) HOURS BEYOND THE ORIGINAL 72 HOURS ALLOWED, THE CONTRACTOR WILL BE CHARGED DISINCENTIVE FEES AT A HIGHER RATE. THIS DISINCENTIVE FEE FOR ANY SUCCESSIVE HOUR BEYOND THE 72 HOUR AND 4 HOUR PERIOD WILL BE \$1000 PER HOUR OR FRACTION OF AN HOUR.
2. EXISTING PAVEMENT MAY BE SAW CUT PRIOR TO 72 HOUR ROADWAY CLOSURE. IF THIS IS DONE, CONTRACTOR SHALL FOLLOW GENERAL TRAFFIC CONTROL REQUIREMENTS FOR ONE LANE CONTROL. TRAFFIC CONTROL FOR THE DURATION OF THE SAW CUT OPERATION IS INCIDENTAL TO THE BID ITEM "MAINTAIN AND CONTROL TRAFFIC."
3. CONTRACTOR SHALL NOTIFY THE PROJECT ENGINEER AT LEAST THREE WEEKS PRIOR TO THE DATE THEY PLAN ON PERFORMING ROAD CLOSURE AND CULVERT INSTALLATION. WITH THIS NOTIFICATION, CONTRACTOR SHALL GIVE THE DATE THEY PLAN TO PERFORM THE WORK AS WELL AS A SECONDARY DATE THAT WILL BE USED IN CASE WORK CANNOT BE PERFORMED ON THE SELECTED DATE.
4. IF CONTRACTOR SELECTS TO PERFORM ROAD CLOSURE OVERNIGHT OR ON A WEEKEND, ANY EXTRA ITEMS THAT MAY BE USED ARE CONSIDERED TO BE INCIDENTAL TO THE BID ITEM "MAINTAIN AND CONTROL TRAFFIC."
5. AT LEAST TWO WEEKS PRIOR TO THE ROAD CLOSURE, CONTRACTOR SHALL INSTALL TWO VARIABLE MESSAGE BOARDS INDICATING THE DATE AND TIMES ROAD SHALL BE CLOSED AT LOCATIONS APPROVED BY THE PROJECT ENGINEER.
6. THE ENGINEER AND THE CONTRACTOR, OR THEIR AUTHORIZED REPRESENTATIVES, SHALL REVIEW THE DETOUR SIGNING PLAN BEFORE THE ROAD CLOSURE. ALL SIGNING SHALL BE APPROVED BY THE ENGINEER BEFORE WORK CAN BE STARTED BY THE CONTRACTOR.
7. THE CONTRACTOR SHALL NOTIFY THE RED RIVER RANCH TRUCKING COMPANY A WEEK PRIOR TO PRIOR TO ANY THE ROAD CLOSURE OR ANY CONSTRUCTION ACTIVITIES THAT MAY LIMIT THE TRUCKS OR OTHER HEAVY VEHICLES FROM ACCESSING THIS SECTION OF KY 2026

MAINTENANCE OF TRAFFIC NOTES

POWELL COUNTY
KY 2026 (MAPLE STREET)
CULVERT REPLACEMENT
& ROADWAY REHABILITATION

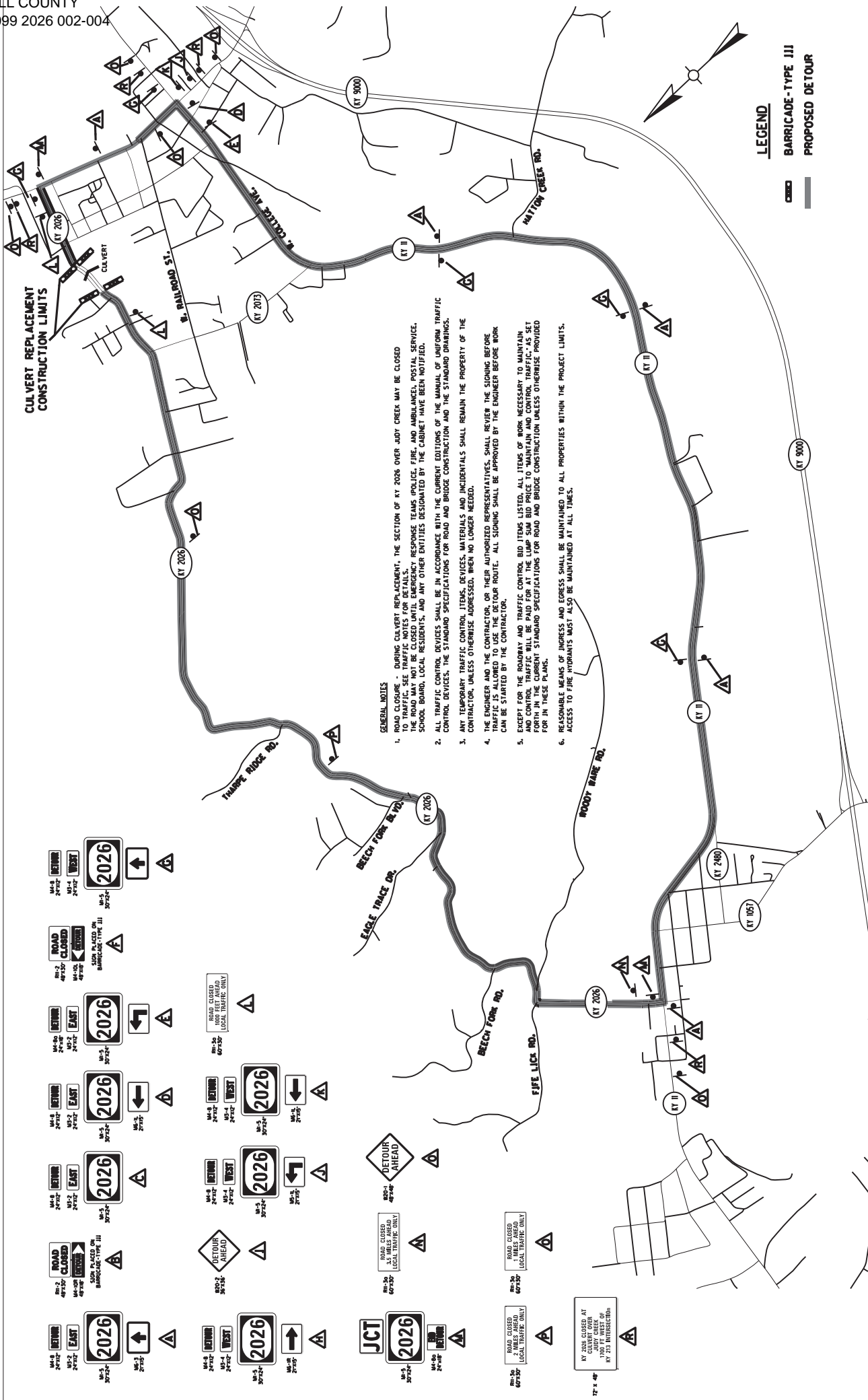

GENERAL NOTES

1. ROAD CLOSURE - DURING CULVERT REPLACEMENT, THE SECTION OF KY 2026 OVER JUDY CREEK MAY BE CLOSED TO TRAFFIC. SEE TRAFFIC NOTES FOR DETAILS. POLICE, FIRE, AND AMBULANCE, POSTAL SERVICE, SCHOOL BOARD, LOCAL RESIDENTS, AND ANY OTHER ENTITIES DESIGNATED BY THE CABINET HAVE BEEN NOTIFIED.
2. ALL TRAFFIC CONTROL DEVICES SHALL BE IN ACCORDANCE WITH THE CURRENT EDITIONS OF THE MANUAL OF UNIFORM TRAFFIC CONTROL DEVICES, THE STANDARD SPECIFICATIONS FOR ROAD AND BRIDGE CONSTRUCTION AND THE STANDARD DRAWINGS.
3. ANY TEMPORARY TRAFFIC CONTROL ITEMS, DEVICES, MATERIALS AND INCIDENTALS SHALL REMAIN THE PROPERTY OF THE CONTRACTOR, UNLESS OTHERWISE ADDRESSED, WHEN NO LONGER NEEDED.
4. THE ENGINEER AND THE CONTRACTOR, OR THEIR AUTHORIZED REPRESENTATIVES, SHALL REVIEW THE SIGNING BEFORE WORK CAN BE STARTED BY THE CONTRACTOR.
5. EXCEPT FOR THE ROADWAY AND TRAFFIC CONTROL BID ITEMS LISTED, ALL ITEMS OF WORK NECESSARY TO MAINTAIN ACCESS TO THE ROADWAY SHALL BE PAID FOR BY THE SHOP BID PRICE TO MAINTAIN AND CORRECT EXISTING CONDITIONS FOR IN THE CURRENT STANDING SPECIFICATIONS FOR ROAD AND BRIDGE CONSTRUCTION UNLESS OTHERWISE PROVIDED FOR IN THESE PLANS.
6. REASONABLE MEANS OF ACCESS AND EGRESS SHALL BE MAINTAINED TO ALL PROPERTIES WITHIN THE PROJECT LIMITS. ACCESS TO FIRE HYDRANTS MUST ALSO BE MAINTAINED AT ALL TIMES.

LEGEND

- BARRICADE-TYPE III
- PROPOSED DETOUR

Special Note for Completion Date, and Liquidated Damages
POWELL COUNTY
KY 2026 (STANTON)

Contrary to Section 108.09, Liquidated Damages of \$5,000 per calendar day will be assessed for each day or fraction thereof work remains uncompleted beyond the Specified Project Completion Date. This project has a Fixed Project Completion Date of July 1, 2020.

Contrary to Section 108.09 of the Standard Specifications, the disincentive fee will be charged during those periods when seasonal limitations of the Contract prohibit the Contractor from working on a controlling item or operation. This includes the months from December through March.

All liquidated damages will be applied cumulatively.

All other applicable portions of Section 108 apply.

SPECIAL NOTES FOR BASE FAILURE REPAIR

Repair locations listed on the summary are approximate only. The Engineer will determine actual repair locations and dimensions at the time of construction. Prior to milling and/or resurfacing, saw cut the existing pavement, asphalt surface, base, DGA, and PCC pavement (if present). Excavate to an approximate depth of 13 inches below the existing pavement surface level. Use all possible care to avoid damaging existing culvert pipes and any existing underground utilities. Repair or restore any damaged items at no additional cost to the Department. Remove and dispose of all materials off the Right-of-way at sites obtained by the Contractor at no additional cost to the Department. When directed by the Engineer, excavate and dispose of unsuitable material below the depth listed above and refill with Crushed Aggregate #2 wrapped in Geotextile Fabric Type V. Quantities for aggregate and geotextile fabric are included in the proposal. Equipment and labor for excavation and disposal of unsuitable material are considered incidental to the bid item Crushed Aggregate #2.

On the same day trench is excavated, backfill the excavated area with 4 inches of DGA base on the bottom and sides. Backfill the remaining area with Class 2 Asphalt Base 1.00D PG64-22 in 3.0inch maximum courses up to the existing pavement surface. Compact the asphalt base to the compaction required in Section 403.03.10. Perform all base failure repairs in such a manner that removal and replacement are completed on the same day. Do this work as one of the Contractor's first operations in order to allow further compaction by traffic. Do not place new asphalt surface over repaired base failure areas until a minimum of 7 calendar days have elapsed after placement of the final course of asphalt base. After a minimum of 7 calendar days and when the Engineer determines the base failure repair areas have sufficiently stabilized, begin milling and/or resurfacing operations. Prior to milling and/or constructing the new asphalt surface, level and wedge any settlement of the repair areas.

The bidder must draw conclusions as to the conditions encountered. The Department does not give any guarantee as to the accuracy of the data and will not consider any claim for additional compensation if the materials encountered that are not in accord with the classification shown.

Accept payment at the Contract unit prices per ton for DGA base, Asphalt Base, and Leveling and Wedging as full compensation for all labor, materials, equipment, and incidentals for saw cutting pavement and excavating and disposing of all materials; furnishing and placing DGA base; furnishing and placing asphalt base up to the pavement boundary; leveling and wedging until the repair areas stabilize; and all other items necessary to complete the work according to these notes to the satisfaction of the Engineer. The Department will not measure pavement removal, excavation, and geotextile fabric but shall be incidental to Crushed Limestone and Asphalt Base as applicable.

SPECIAL NOTE FOR EXCESS MATERIAL SITES

POWELL COUNTY - KY 2026 (STANTON)

IDENTIFICATION OF EXCESS MATERIAL SITE(S) AND BORROW SITE(S) SHALL BE THE RESPONSIBILITY OF THE CONTRACTOR. THE CONTRACTOR SHALL BE RESPONSIBLE FOR COMPLIANCE WITH ALL APPLICABLE STATE AND FEDERAL LAWS AND MAY WISH TO CONSULT WITH THE US FISH AND WILDLIFE SERVICE TO SEEK PROTECTION UNDER SECTION 10 OF THE ENDANGERED SPECIES ACT FOR THESE ACTIVITIES. MITIGATION REQUIREMENT RESULTING FROM THE USE OF EXCESS MATERIAL SITE(S) AND BORROW SITE(S) SHALL BE PAID BY THE CONTRACTOR PRIOR TO THE STREAM IMPACTS OCCURING AT THESE SITES.

EROSION CONTROL NOTES

ALL SILT CONTROL DEVICES SHALL BE SIZED TO RETAIN A VOLUME OF 3,600 CUBIC FEET PER DISTURBED CONTRIBUTING ACRE.

THE CONTRACTOR SHALL CONDUCT HIS OPERATION TO MINIMIZE THE AMOUNT OF DISTURBED GROUND DURING EACH PHASE OF CONSTRUCTION. THE CONTRACTOR SHALL COMPUTE THE VOLUME NECESSARY TO CONTROL SEDIMENT DURING EACH PHASE OF CONSTRUCTION. AS WORK PROCEEDS, SILT TRAPS/FENCES MAY BE ADDED OR REMOVED IN ORDER TO ACHIEVE THE BEST MANAGEMENT PLAN.

THE REQUIRED VOLUME AT EACH SILT TRAP SHALL BE COMPUTED AS UP GRADIENT CONTRIBUTING AREAS ARE DISTURBED OR ARE STABILIZED TO THE SATISFACTION OF THE ENGINEER. THE REQUIRED VOLUME CALCULATION FOR EACH SILT TRAP SHALL BE DETERMINED BY THE CONTRACTOR AND VERIFIED BY THE ENGINEER. THE REQUIRED VOLUME AT EACH SILT TRAP MAY BE REDUCED BY THE FOLLOWING AMOUNTS:

- UP GRADIENT AREAS NOT DISTURBED (ACRES).
- UP GRADIENT AREAS THAT HAVE BEEN RECLAIMED AND PROTECTED BY EROSION CONTROL BLANKET OR OTHER GROUND PROTECTION MATERIAL SUCH AS TEMP. MULCH (ACRES).
- UP GRADIENT AREAS THAT HAVE BEEN PROTECTED BY SILT FENCE (ACRES). AREAS PROTECTED BY SILT FENCE SHALL BE COMPUTED AT A MAXIMUM RATE OF 100 SQUARE FOOT PER LINEAR FOOT OF SILT FENCE.
- UP GRADIENT AREAS THAT HAVE BEEN PROTECTED BY SILT TRAPS (ACRES).

THE USE OF TEMPORARY MULCH IS ENCOURAGED.

SILT TRAP TYPE B SHALL ALWAYS BE PLACED AT THE COLLECTION POINT PRIOR TO DISCHARGING INTO A BLUE LINE STREAM OR ONTO AN ADJACENT PROPERTY OWNER. WHERE OVERLAND FLOW EXIST, A SILT FENCE OR OTHER FILTER DEVICES MAY BE USED. EROSION CONTROL MEASURES SHALL BE IN PLACE AND FUNCTIONING PRIOR TO ANY EXCAVATION OR DISTURBANCE WITHIN A DRAINAGE AREA.

THE CONTRACTOR SHALL BE REQUIRED TO CLEAN OUT (REMOVE SEDIMENT FROM) SILT TRAPS AND SILT FENCES WHENEVER THEY BECOME ONE - HALF FULL AND PROPERLY DISPOSE OF MATERIAL AT SITES APPROVED BY THE RESIDENT ENGINEER.

EROSION CONTROL NOTES
POWELL COUNTY KY 2026 (MAPLE STREET) CULVERT REPLACEMENT & ROADWAY REHABILITATION

SPECIAL NOTE FOR EROSION CONTROL

I. DESCRIPTION

Perform all erosion and water pollution control work in accordance with the Department's Standard and Interim Supplemental Specifications, Special Provisions and Special Notes, and Standard and Sepia Drawings, current editions, and as directed by the Engineer. Section references are to the Standard Specifications. This work shall consist of:

(1) Developing and preparing a Best Management Practices Plan (BMP) tailored to suit the specific construction phasing for each site within the project; (2) Preparing the project site for construction, including locating, furnishing, installing, and maintaining temporary and/or permanent erosion and water pollution control measures as required by the BMP prior to beginning any earth disturbing activity on the project site; (3) Clearing and grubbing and removal of all obstructions as required for construction; (4) Removing all erosion control devices when no longer needed; (5) Restoring all disturbed areas as nearly as possible to their original condition; (6) Preparing seedbeds and permanently seeding all disturbed areas; (7) Providing a Kentucky Erosion Prevention and Sediment Control Program (KEPSC) qualified inspector; and (8) Performing any other work to prevent erosion and/or water pollution as specified by this contract, required by the BMP, or as directed by the Engineer.

II. MATERIALS

Furnish materials in accordance with these notes, the Standard Specifications and Interim Supplemental Specifications, and applicable Special Provisions and Special Notes, and Standard and Sepia Drawings, current editions. Provide for all materials to be sampled and tested in accordance with the Department's Sampling Manual. Unless directed otherwise by the Engineer, make the materials available for sampling a sufficient time in advance of the use of the materials to allow for the necessary time for testing.

III. CONSTRUCTION

Be advised, these Erosion Control Plan Notes do not constitute a BMP plan for the project. Jointly with the Engineer, prepare a site specific BMP plan for each drainage area within the project in accordance with Section 213. Provide a unique BMP at each project site using good engineering practices taking into account existing site conditions, the type of work to be performed, and the construction phasing, methods and techniques to be utilized to complete the work. Be responsible for all erosion prevention, sediment control, and water pollution prevention measures required by the BMP for each site. Represent and warrant compliance with the Clean Water Act (33 USC Section 1251 et seq.), the 404 Permit, the 401 Water Quality Certification, and applicable state and

Erosion Control
Page 2 of 4

local government agency laws, regulations, rules, specifications, and permits. Contrary to Section 105.05, in case of discrepancy between these notes, the Standard Specifications, Interim Supplemental Specifications, Special and Special Notes, Standard and Sepia Drawings, and such state and local government agency requirements, adhere to the most restrictive requirement.

Conduct operations in such a manner as to minimize the amount of disturbed ground during each phase of the construction and limit the haul roads to the minimum required to perform the work. Preserve existing vegetation not required to be removed by the work or the contract. Seed and/or mulch disturbed areas at the earliest opportunity. Use silt fence, silt traps, temporary ditches, brush barriers, erosion control blankets, sodding, channel lining, and other erosion control measures in a timely manner as required by the BMP and as directed or approved by the Engineer. Prevent sediment laden water from leaving the project, entering an existing drainage structure, or entering a stream.

Provide for erosion control measures to be in place and functioning prior to any earth disturbance within a drainage area. Compute the volume and size of silt control devices necessary to control sediment during each phase of construction. Remove sediment from silt traps before they become a maximum of ½ full. Maintain silt fence by removing accumulated trappings and/or replacing the geotextile fabric when it becomes clogged, damaged, or deteriorated, or when directed by the Engineer. Properly dispose of all materials trapped by erosion control devices at approved sites off the right of way obtained by the Contractor at no additional cost to the Department (See Special Note for Waste and Borrow).

As work progresses, add or remove erosion control measures as required by the BMP applicable to the Contractor's project phasing and construction methods and techniques. Update the volume calculations and modify the BMP as necessary throughout the duration of the project. Ensure that an updated BMP is kept on site and available for public inspection throughout the life of the project.

After all construction is complete, restore all disturbed areas in accordance with Section 212. Completely remove all temporary erosion control devices not required as part of the permanent erosion control from the construction site. Prior to removal, obtain the Engineer's concurrence of items to be removed. Grade the remaining exposed earth (both on and off the Right of-Way) as nearly as possible to its original condition, or as directed by the Engineer. Prepare the seed bed areas and sow all exposed earthen areas with the applicable seed mixture(s) according to Section 212.03.03.

Erosion Control
Page 3 of 4

IV. MEASUREMENT

Erosion Control Blanket. If required by the BMP, the Department will measure Erosion Control Blanket according to Section 212.04.07.

Sodding. If required by the BMP, the Department will measure Sodding according to Section 212.04.08.

Channel Lining. If required by the BMP, the Department will measure Channel Lining according to Sections 703.04.04-703.04.07.

Erosion Control. Contrary to Sections 212.04, 213.04, and 703.04 other than Erosion Control Blankets, Sodding, and Channel Lining, the Department will measure Erosion Control as one lump sum. The Department will not measure developing, updating, and maintaining a BMP plan for each site; providing a KEPSC qualified inspector; locating, furnishing, installing, inspecting, maintaining, and removing erosion and water pollution control items; Roadway Excavation, Borrow Excavation, Embankment In Place, Topsoil Furnished and Placed, and Spreading Stockpiled Topsoil; Topdressing Fertilizer, Temporary and Permanent Seeding and Protection, Special Seeding Crown Vetch, and Temporary Mulch; Sedimentation Basin and Clean Sedimentation Basin, Silt Trap Type "A" and Clean Silt Trap Type "A"; Silt Trap Type "B" and Clean Silt Trap Type "B"; Silt Trap Type "C" and Clean Silt Trap Type "C"; Temporary Silt Fence and Clean Temporary Silt Fence; Plants, Vines, Shrubs, and Trees; Gabion and Dumped Stone Deflectors and Riffle Structures; Boulders; Temporary Ditches and clean Temporary Ditches; Geotextile Fabric, and all other erosion and water pollution control items required by the BMP or the Engineer, but shall be incidental to Erosion Control.

V. Basis of Payment

Erosion Control Blanket. If not listed as a bid item, but required by the BMP, the Department will pay for Erosion Control Blankets as Extra Work according to Sections 104.03 and 109.04.

Sodding. If not listed as a bid item, but required by the BMP, the Department will pay for Sodding as Extra Work according to Sections 104.03 and 109.04.

Channel Lining. If not listed as a bid item, but required by the BMP, the Department will pay for Channel Lining as Extra Work according to Sections 104.03 and 109.04.

Erosion Control
Page 4 of 4

Erosion Control. Contrary to Sections 212.05 and 213.05, other than Erosion Control Blanket, Sodding, and Channel Lining, payment at the Contract lump sum price for Erosion Control, shall be full compensation for all materials, equipment, labor and incidentals necessary to complete the erosion and water pollution control work as specified in these notes, Sections 212 and 213, the Supplemental Specifications, applicable Special Provisions and Special Notes, and Standard and Sepia Drawings, including but not limited to developing, updating, and maintaining a BMP plan for each site; providing a KEPSC qualified inspector; locating, furnishing, installing, inspecting, maintaining, and removing erosion and water pollution control items; Roadway Excavation, Borrow Excavation, Embankment In Place, Topsoil Furnished and Placed, and Spreading Stockpiled Topsoil; Topdressing Fertilizer, Temporary and Permanent Seeding and Protection, Special Seeding Crown Vetch, and Temporary Mulch; Sedimentation Basin and Clean Sedimentation Basin, Silt Trap Type "A" and Clean Silt Trap Type "A"; Silt Trap Type "B" and Clean Silt Trap Type "B"; Silt Trap Type "C" and Clean Silt Trap Type "C"; Temporary Silt Fence and Clean Temporary Silt Fence; Plants, Vines, Shrubs, and Trees; Gabion and Dumped Stone Deflectors and Riffle Structures; Boulders; Temporary Ditches and clean Temporary Ditches; Geotextile Fabric and all other erosion and water pollution control items required by the BMP or the Engineer.

06/08/2012

Special Note Concerning Environmental Training Specified by Permit:

Training is required as a part of the ground water protection plan. All employees of the contractor and all sub-contractor personnel will be trained to understand the nature and requirements of this plan as they pertain to their job function(s). Training will be accomplished within one week of employment and annually thereafter. A record of training will be maintained by the contractor with a copy provided to the resident engineer within 10 days of employment and annually thereafter for as long as the contractor is under contract.

KyTC BMP Plan for Project PCN ## - #####



Kentucky Transportation Cabinet

Highway District 10

And

_____ **(2), Construction**

**Kentucky Pollutant Discharge Elimination System
Permit KYR10
Best Management Practices (BMP) plan**

Groundwater protection plan

For Highway Construction Activities

For

**[Roadway Rehabilitation and Culvert Replacement
on KY 2026, Powell County]**

Project: PCN ## - #####

KyTC BMP Plan for Project PCN ## -

Project information

Note – (1) = Design (2) = Construction (3) = Contractor

1. Owner – Kentucky Transportation Cabinet, District _10_
2. Resident Engineer: (2)
3. Contractor name: (2)
Address: (2)

Phone number: (2)
Contact: (2)
Contractors agent responsible for compliance with the KPDES permit requirements (3):
4. Project Control Number (2)
5. Route (Address) KY 2026, MP 2 to MP 4.2
6. Latitude/Longitude (project mid-point) (1) -83.862°, 37.854°
7. County (project mid-point) Powell
8. Project start date (date work will begin): (2)
9. Projected completion date: (2)

A. Site description:

1. Nature of Construction Activity (from letting project description)
Base failure repair and culvert replacement
2. Order of major soil disturbing activities (2) and (3)
3. Projected volume of material to be moved
Approximately 1600 Tons of existing pavement to be removed for base failure repair.

KyTC BMP Plan for Project PCN ## -

4. Estimate of total project area (acres) 0.2 acre at culvert replacement
5. Estimate of area to be disturbed (acres) 0.2 acre at culvert replacement
6. Post construction runoff coefficient will be included in the project drainage folder. Persons needing information pertaining to the runoff coefficient will contact the resident engineer to request this information.
7. Data describing existing soil condition (2)
8. Data describing existing discharge water quality (if any) (1) & (2)
Muddy due to failing roadway embankment slope.
9. Receiving water name **Judy Creek**
10. TMDLs and Pollutants of Concern in Receiving Waters: (1 DEA)
11. Site map – Project layout sheet plus the erosion control sheets in the project plans that depict Disturbed Drainage Areas (DDAs) and related information. These sheets depict the existing project conditions with areas delineated by DDA (drainage area bounded by watershed breaks and right of way limits), the storm water discharge locations (either as a point discharge or as overland flow) and the areas that drain to each discharge point. These plans define the limits of areas to be disturbed and the location of control measures. Controls will be either site specific as designated by the designer or will be annotated by the contractor and resident engineer before disturbance commences. The project layout sheet shows the surface waters and wetlands.
12. Potential sources of pollutants:

The primary source of pollutants is solids that are mobilized during storm events. Other sources of pollutants include oil/fuel/grease from servicing and operating construction equipment, concrete washout water, sanitary wastes and trash/debris. (3)

B. Sediment and Erosion Control Measures:

1. Plans for highway construction projects will include erosion control sheets that depict Disturbed Drainage Areas (DDAs) and related information. These plan sheets will show the existing project conditions with areas delineated by DDA within the right of way limits, the discharge points and the areas that drain to each discharge point. Project managers and

KyTC BMP Plan for Project PCN ## -

designers will analyze the DDAs and identify Best Management Practices (BMPs) that are site specific. The balance of the BMPs for the project will be listed in the bid documents for selection and use by the contractor on the project with approval by the resident engineer.

Projects that do not have DDAs annotated on the erosion control sheets will employ the same concepts for development and managing BMP plans.

2. Following award of the contract, the contractor and resident engineer will annotate the erosion control sheets showing location and type of BMPs for each of the DDAs that will be disturbed at the outset of the project. This annotation will be accompanied by an order of work that reflects the order or sequence of major soil moving activities. The remaining DDAs are to be designated as "Do Not Disturb" until the contractor and resident engineer prepare the plan for BMPs to be employed. The initial BMP's shall be for the first phase (generally Clearing and Grubbing) and shall be modified as needed as the project changes phases. The BMP Plan will be modified to reflect disturbance in additional DDA's as the work progresses. All DDA's will have adequate BMP's in place before being disturbed.

3. As DDAs are prepared for construction, the following will be addressed for the project as a whole or for each DDA as appropriate:
 - Construction Access – This is the first land-disturbing activity. As soon as construction begins, bare areas will be stabilized with gravel and temporary mulch and/or vegetation.
 - At the beginning of the project, all DDAs for the project will be inspected for areas that are a source of storm water pollutants. Areas that are a source of pollutants will receive appropriate cover or BMPs to arrest the introduction of pollutants into storm water. Areas that have not been opened by the contractor will be inspected periodically (once per month) to determine if there is a need to employ BMPs to keep pollutants from entering storm water.
 - Clearing and Grubbing – The following BMP's will be considered and used where appropriate.
 - Leaving areas undisturbed when possible.
 - Silt basins to provide silt volume for large areas.
 - Silt Traps Type A for small areas.
 - Silt Traps Type C in front of existing and drop inlets which are to be saved

KyTC BMP Plan for Project PCN ## -

- Diversion ditches to catch sheet runoff and carry it to basins or traps or to divert it around areas to be disturbed.
- Brush and/or other barriers to slow and/or divert runoff.
- Silt fences to catch sheet runoff on short slopes. For longer slopes, multiple rows of silt fence may be considered.
- Temporary Mulch for areas which are not feasible for the fore mentioned types of protections.
- Non-standard or innovative methods.
- Cut & Fill and placement of drainage structures - The BMP Plan will be modified to show additional BMP's such as:
 - Silt Traps Type B in ditches and/or drainways as they are completed
 - Silt Traps Type C in front of pipes after they are placed
 - Channel Lining
 - Erosion Control Blanket
 - Temporary mulch and/or seeding for areas where construction activities will be ceased for 21 days or more.
 - Non-standard or innovative methods
- Profile and X-Section in place – The BMP Plan will be modified to show elimination of BMP's which had to be removed and the addition of new BMP's as the roadway was shaped. Probably changes include:
 - Silt Trap Type A, Brush and/or other barriers, Temporary Mulch, and any other BMP which had to be removed for final grading to take place.
 - Additional Silt Traps Type B and Type C to be placed as final drainage patterns are put in place.
 - Additional Channel Lining and/or Erosion Control Blanket.
 - Temporary Mulch for areas where Permanent Seeding and Protection cannot be done within 21 days.
 - Special BMP's such as Karst Policy
- Finish Work (Paving, Seeding, Protect, etc.) – A final BMP Plan will result from modifications during this phase of construction. Probably changes include:
 - Removal of Silt Traps Type B from ditches and drainways if they are protected with other BMP's which are sufficient to control erosion, i.e. Erosion Control Blanket or Permanent Seeding and Protection on moderate grades.
 - Permanent Seeding and Protection
 - Placing Sod
 - Planting trees and/or shrubs where they are included in the project
- BMP's including Storm Water Management Devices such as velocity dissipation devices and Karst policy BMP's to be installed during construction to control the pollutants in storm water

KyTC BMP Plan for Project PCN ## -

discharges that will occur after construction has been completed are : (1)

C. Other Control Measures

1. No solid materials, including building materials, shall be discharged to waters of the commonwealth, except as authorized by a Section 404 permit.

All waste materials that may leach pollutants (paint and paint containers, caulk tubes, oil/grease containers, liquids of any kind, soluble materials, etc.) will be collected and stored in appropriate covered waste containers. Waste containers shall be removed from the project site on a sufficiently frequent basis as to not allow wastes to become a source of pollution. All personnel will be instructed regarding the correct procedure for waste disposal. Wastes will be disposed in accordance with appropriate regulations. Notices stating these practices will be posted in the office.

2. Hazardous Waste

All hazardous waste materials will be managed and disposed of in the manner specified by local or state regulation. The contractor shall notify the Resident Engineer if there any hazardous wastes being generated at the project site and how these wastes are being managed. Site personnel will be instructed with regard to proper storage and handling of hazardous wastes when required. The Transportation Cabinet will file for generator, registration when appropriate, with the Division of Waste Management and advise the contractor regarding waste management requirements.

3. Spill Prevention

The following material management practices will be used to reduce the risk of spills or other exposure of materials and substances to the weather and/or runoff.

➤ **Good Housekeeping:**

The following good housekeeping practices will be followed onsite during the construction project.

- An effort will be made to store only enough product required to do the job
- All materials stored onsite will be stored in a neat, orderly manner in their appropriate containers and, if possible, under a roof or other enclosure

KyTC BMP Plan for Project PCN ## -

- Products will be kept in their original containers with the original manufacturer's label
- Substances will not be mixed with one another unless recommended by the manufacturer
- Whenever possible, all of the product will be used up before disposing of the container
- Manufacturers' recommendations for proper use and disposal will be followed
- The site contractor will inspect daily to ensure proper use and disposal of materials onsite

➤ **Hazardous Products:**

These practices will be used to reduce the risks associated with any and all hazardous materials.

- Products will be kept in original containers unless they are not resealable
- Original labels and material safety data sheets (MSDS) will be reviewed and retained
- Contractor will follow procedures recommended by the manufacturer when handling hazardous materials
- If surplus product must be disposed of, manufacturers' or state/local recommended methods for proper disposal will be followed

The following product-specific practices will be followed onsite:

➤ **Petroleum Products:**

Vehicles and equipment that are fueled and maintained on site will be monitored for leaks, and receive regular preventative maintenance to reduce the chance of leakage. Petroleum products onsite will be stored in tightly sealed containers, which are clearly labeled and will be protected from exposure to weather.

The contractor shall prepare an Oil Pollution Spill Prevention Control and Countermeasure plan when the project that involves the storage of petroleum products in 55 gallon or larger containers with a total combined storage capacity of 1,320 gallons. This is a requirement of 40 CFR 112.

This project (will / will not) (3) have over 1,320 gallons of petroleum products with a total capacity, sum of all containers 55 gallon capacity and larger.

➤ **Fertilizers:**

Fertilizers will be applied at rates prescribed by the contract, standard specifications or as directed by the resident engineer. Once applied, fertilizer will

KyTC BMP Plan for Project PCN ## -

be covered with mulch or blankets or worked into the soil to limit exposure to storm water. Storage will be in a covered shed. The contents of any partially used bags of fertilizer will be transferred to a sealable plastic bin to avoid spills.

➤ **Paints:**

All containers will be tightly sealed and stored indoors or under roof when not being used. Excess paint or paint wash water will not be discharged to the drainage or storm sewer system but will be properly disposed of according to manufacturers' instructions or state and local regulations.

➤ **Concrete Truck Washout:**

Concrete truck mixers and chutes will not be washed on pavement, near storm drain inlets, or within 75 feet of any ditch, stream, wetland, lake, or sinkhole. Where possible, excess concrete and wash water will be discharged to areas prepared for pouring new concrete, flat areas to be paved that are away from ditches or drainage system features, or other locations that will not drain off site. Where this approach is not possible, a shallow earthen wash basin will be excavated away from ditches to receive the wash water

➤ **Spill Control Practices**

In addition to the good housekeeping and material management practices discussed in the previous sections of this plan, the following practices will be followed for spill prevention and cleanup:

- Manufacturers' recommended methods for spill cleanup will be clearly posted. All personnel will be made aware of procedures and the location of the information and cleanup supplies.
- Materials and equipment necessary for spill cleanup will be kept in the material storage area. Equipment and materials will include as appropriate, brooms, dust pans, mops, rags, gloves, oil absorbents, sand, sawdust, and plastic and metal trash containers.
- All spills will be cleaned up immediately after discovery.
- The spill area will be kept well ventilated and personnel will wear appropriate protective clothing to prevent injury from contact with a hazardous substance.
- Spills of toxic or hazardous material will be reported to the appropriate state/local agency as required by KRS 224 and applicable federal law.
- The spill prevention plan will be adjusted as needed to prevent spills from reoccurring and improve spill response and cleanup.
- Spills of products will be cleaned up promptly. Wastes from spill clean up will be disposed in accordance with appropriate regulations.

KyTC BMP Plan for Project PCN ## -

D. Other State and Local Plans

This BMP plan shall include any requirements specified in sediment and erosion control plans, storm water management plans or permits that have been approved by other state or local officials. Upon submittal of the NOI, other requirements for surface water protection are incorporated by reference into and are enforceable under this permit (even if they are not specifically included in this BMP plan). This provision does not apply to master or comprehensive plans, non-enforceable guidelines or technical guidance documents that are not identified in a specific plan or permit issued for the construction site by state or local officials. (1)

E. Maintenance

1. The BMP plan shall include a clear description of the maintenance procedures necessary to keep the control measures in good and effective operating condition.
- Maintenance of BMPs during construction shall be a result of weekly and post rain event inspections with action being taken by the contractor to correct deficiencies.
 - Post Construction maintenance will be a function of normal highway maintenance operations. Following final project acceptance by the cabinet, district highway crews will be responsible for identification and correction of deficiencies regarding ground cover and cleaning of storm water BMPs. The project manager shall identify any BMPs that will be for the purpose of post construction storm water management with specific guidance for any non-routine maintenance. (1)

F. Inspections

Inspection and maintenance practices that will be used to maintain erosion and sediment controls:

- All erosion prevention and sediment control measures will be inspected at least once each week and following any rain of one-half inch or more.
- Inspections will be conducted by individuals that have successfully completed the KEPSC-RI course as required by Section 213.02.02 of the Standard Specifications for Road and Bridge Construction, current edition.

KyTC BMP Plan for Project PCN ## -

- Inspection reports will be written, signed, dated, and kept on file.
- Areas at final grade will be seeded and mulched within 14 days.
- Areas that are not at final grade where construction has ceased for a period of 21 days or longer and soil stock piles shall receive temporary mulch no later than 14 days from the last construction activity in that area.
- All measures will be maintained in good working order; if a repair is necessary, it will be initiated within 24 hours of being reported.
- Built-up sediment will be removed from behind the silt fence before it has reached halfway up the height of the fence.
- Silt fences will be inspected for bypassing, overtopping, undercutting, depth of sediment, tears, and to ensure attachment to secure posts.
- Sediment basins will be inspected for depth of sediment, and built-up sediment will be removed when it reaches 70 percent of the design capacity and at the end of the job.
- Diversion dikes and berms will be inspected and any breaches promptly repaired. Areas that are eroding or scouring will be repaired and re-seeded / mulched as needed.
- Temporary and permanent seeding and mulching will be inspected for bare spots, washouts, and healthy growth. Bare or eroded areas will be repaired as needed.
- All material storage and equipment servicing areas that involve the management of bulk liquids, fuels, and bulk solids will be inspected weekly for conditions that represent a release or possible release of pollutants to the environment.

G. Non – Storm Water discharges

It is expected that non-storm water discharges may occur from the site during the construction period. Examples of non-storm water discharges include:

- Water from water line flushings.
- Water from cleaning concrete trucks and equipment.
- Pavement wash waters (where no spills or leaks of toxic or hazardous materials have occurred).
- Uncontaminated groundwater and rain water (from dewatering during excavation).

All non-storm water discharges will be directed to the sediment basin or to a filter fence enclosure in a flat vegetated infiltration area or be filtered via another approved commercial product.

KyTC BMP Plan for Project PCN ## - #####

H. Groundwater Protection Plan (3)

This plan serves as the groundwater protection plan as required by 401 KAR 5:037.

➤ Contractors statement: (3)

The following activities, as enumerated by 401 KAR 5:037 Section 2 that require the preparation and implementation of a groundwater protection plan, will or may be may be conducted as part of this construction project:

_____ 2. (e) land treatment or land disposal of a pollutant;

_____ 2. (f) Storing, ..., or related handling of hazardous waste, solid waste or special waste, ..., in tanks, drums, or other containers, or in piles, (This does not include wastes managed in a container placed for collection and removal of municipal solid waste for disposal off site);

_____ 2. (g) Handling of materials in bulk quantities (equal or greater than 55 gallons or 100 pounds net dry weight transported held in an individual container) that, if released to the environment, would be a pollutant;

_____ 2. (j) Storing or related handling of road oils, dust suppressants,, at a central location;

_____ 2. (k) Application or related handling of road oils, dust suppressants or deicing materials, (does not include use of chloride-based deicing materials applied to roads or parking lots);

_____ 2. (m) Installation, construction, operation, or abandonment of wells, bore holes, or core holes, (this does not include bore holes for the purpose of explosive demolition);

Or, check the following only if there are no qualifying activities

_____ There are no activities for this project as listed in 401 KAR 5:037 Section 2 that require the preparation and implementation of a groundwater protection plan.

The contractor is responsible for the preparation of a plan that addresses the

401 KAR 5:037 Section 3. (3) Elements of site specific groundwater protection plan:

(a) General information about this project is covered in the Project information;

KyTC BMP Plan for Project PCN ## - #####

- (b) Activities that require a groundwater protection plan have been identified above;
- (c) Practices that will protect groundwater from pollution are addressed in section C. Other control measures.
- (d) Implementation schedule – all practices required to prevent pollution of groundwater are to be in place prior to conducting the activity;
- (e) Training is required as a part of the ground water protection plan. All employees of the contractor, sub-contractor and resident engineer personnel will be trained to understand the nature and requirements of this plan as they pertain to their job function(s). Training will be accomplished within one week of employment and annually thereafter. A record of training will be maintained by the contractor with a copy provide to the resident engineer.
- (f) Areas of the project and groundwater plan activities will be inspected as part of the weekly sediment and erosion control inspections
- (g) Certification (see signature page.)

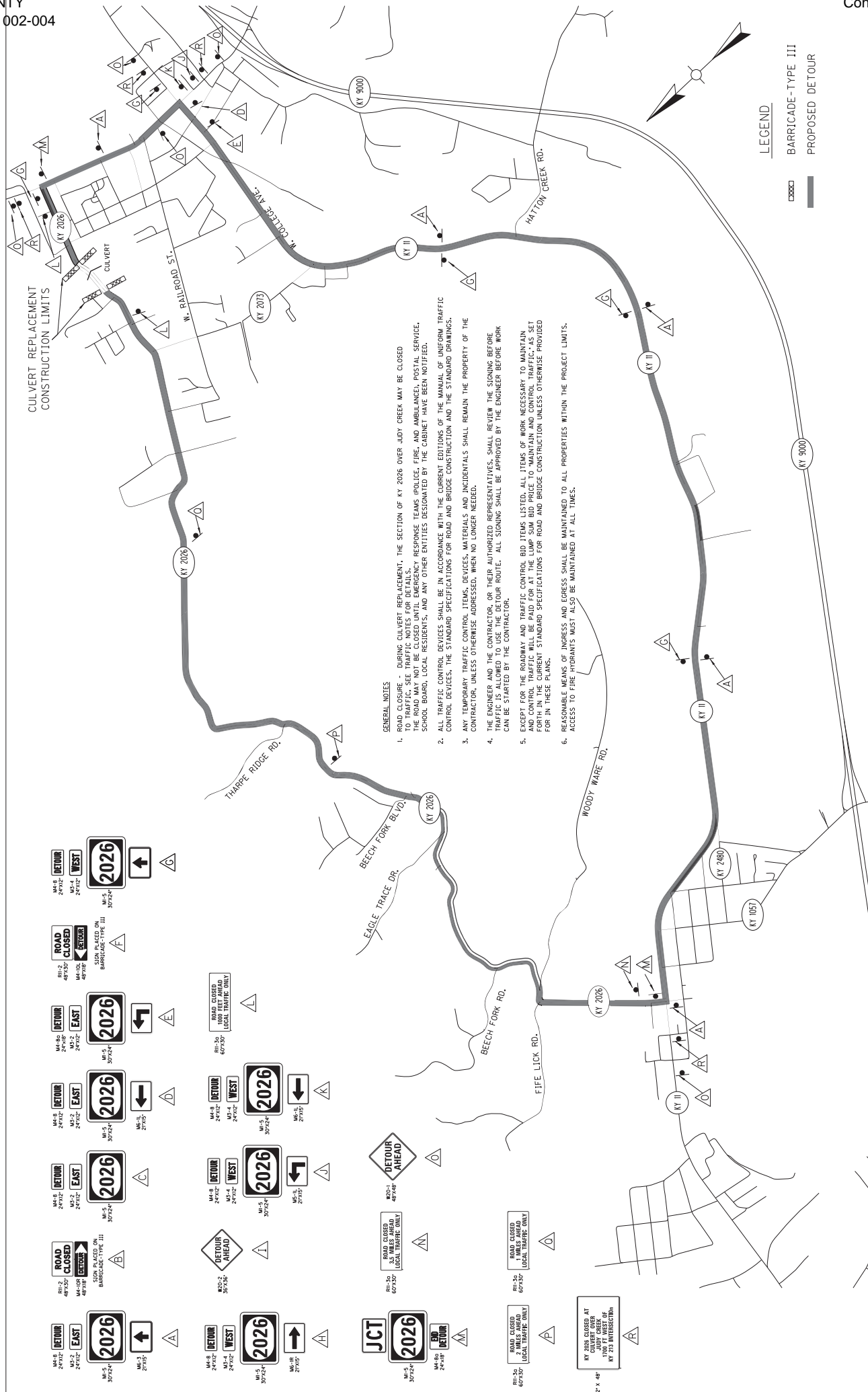

GENERAL NOTES

1. ROAD CLOSURE - DURING CULVERT REPLACEMENT, THE SECTION OF KY 2026 OVER JUDY CREEK MAY BE CLOSED FOR A PERIOD OF TIME. THE ROAD WILL BE CLOSED UNTIL EMERGENCY RESPONSE TEAMS (POLICE, FIRE, AND AMBULANCE), POSTAL SERVICE, SCHOOL BOARD, LOCAL RESIDENTS, AND ANY OTHER ENTITIES DESIGNATED BY THE CABINET HAVE BEEN NOTIFIED.
2. ALL TRAFFIC CONTROL DEVICES SHALL BE IN ACCORDANCE WITH THE CURRENT EDITIONS OF THE MANUAL OF UNIFORM TRAFFIC CONTROL DEVICES, THE STANDARD SPECIFICATIONS FOR ROAD AND BRIDGE CONSTRUCTION AND THE STANDARD DRAWINGS.
3. ANY TEMPORARY TRAFFIC CONTROL ITEMS, DEVICES, MATERIALS AND INCIDENTALS SHALL REMAIN THE PROPERTY OF THE CONTRACTOR, UNLESS OTHERWISE ADDRESSED, WHEN NO LONGER NEEDED.
4. THE ENGINEER AND THE CONTRACTOR, OR THEIR AUTHORIZED REPRESENTATIVES, SHALL REVIEW THE SIGNING BEFORE TRAFFIC IS ALLOWED TO USE THE DETOUR ROUTE. ALL SIGNING SHALL BE APPROVED BY THE ENGINEER BEFORE WORK CAN BE STARTED BY THE CONTRACTOR.
5. EXCEPT FOR THE ROADWAY AND TRAFFIC CONTROL BID ITEMS LISTED, ALL ITEMS OF WORK NECESSARY TO MAINTAIN AND CONTROL TRAFFIC WILL BE PAID FOR AT THE LUMP SUM BID PRICE TO MAINTAIN AND CONTROL TRAFFIC, AS SET FORTH IN THE CURRENT STANDARD SPECIFICATIONS FOR ROAD AND BRIDGE CONSTRUCTION UNLESS OTHERWISE PROVIDED FOR IN THESE PLANS.
6. REASONABLE MEANS OF INGRESS AND EGRESS SHALL BE MAINTAINED TO ALL PROPERTIES WITHIN THE PROJECT LIMITS. ACCESS TO FIRE HYDRANTS MUST ALSO BE MAINTAINED AT ALL TIMES.

DETOUR WEST
 M-5 28'x32'
 M-4 24'x32'
 M-5 30'x24'
2026
 ↑

ROAD CLOSED
 RII-2 48'x30'
 MA-10R 48'x30'
 MA-10S 48'x30'
DETOUR
 BARRICADE-TYPE III
2026
 ↓

DETOUR EAST
 M-5B 28'x32'
 M-5 24'x32'
 M-5 30'x24'
2026
 ←

DETOUR WEST
 M-5B 28'x32'
 M-5 24'x32'
 M-5 30'x24'
2026
 →

DETOUR EAST
 M-5 28'x32'
 M-5 24'x32'
 M-5 30'x24'
2026
 ←

DETOUR WEST
 M-5B 28'x32'
 M-5 24'x32'
 M-5 30'x24'
2026
 →

ROAD CLOSED
 RII-2 48'x30'
 MA-10R 48'x30'
 MA-10S 48'x30'
DETOUR
 BARRICADE-TYPE III
2026
 ↓

DETOUR WEST
 M-5B 28'x32'
 M-5 24'x32'
 M-5 30'x24'
2026
 →

DETOUR EAST
 M-5 28'x32'
 M-5 24'x32'
 M-5 30'x24'
2026
 ←

ROAD CLOSED
 RII-2 48'x30'
 MA-10R 48'x30'
 MA-10S 48'x30'
DETOUR
 BARRICADE-TYPE III
2026
 ↓

DETOUR WEST
 M-5B 28'x32'
 M-5 24'x32'
 M-5 30'x24'
2026
 →

DETOUR EAST
 M-5 28'x32'
 M-5 24'x32'
 M-5 30'x24'
2026
 ←

ROAD CLOSED
 RII-2 48'x30'
 MA-10R 48'x30'
 MA-10S 48'x30'
DETOUR
 BARRICADE-TYPE III
2026
 ↓

ROAD CLOSED
 RII-2 48'x30'
 MA-10R 48'x30'
 MA-10S 48'x30'
DETOUR
 BARRICADE-TYPE III
2026
 ↓

ROAD CLOSED
 RII-2 48'x30'
 MA-10R 48'x30'
 MA-10S 48'x30'
DETOUR
 BARRICADE-TYPE III
2026
 ↓

JCT
2026
 ↓

DETOUR AHEAD
 M-5B 28'x32'
 M-5 24'x32'
 M-5 30'x24'
2026
 ↓

ROAD CLOSED
 RII-2 48'x30'
 MA-10R 48'x30'
 MA-10S 48'x30'
DETOUR
 BARRICADE-TYPE III
2026
 ↓

ROAD CLOSED
 RII-2 48'x30'
 MA-10R 48'x30'
 MA-10S 48'x30'
DETOUR
 BARRICADE-TYPE III
2026
 ↓

ROAD CLOSED
 RII-2 48'x30'
 MA-10R 48'x30'
 MA-10S 48'x30'
DETOUR
 BARRICADE-TYPE III
2026
 ↓

ROAD CLOSED
 RII-2 48'x30'
 MA-10R 48'x30'
 MA-10S 48'x30'
DETOUR
 BARRICADE-TYPE III
2026
 ↓

ROAD CLOSED
 RII-2 48'x30'
 MA-10R 48'x30'
 MA-10S 48'x30'
DETOUR
 BARRICADE-TYPE III
2026
 ↓

KY 2026 CLOSED AT
 CULVERT OVER
 JUDY CREEK
 1700 FT. WEST OF
 KY 2026+69.50
 IN ECH BYPASS/DRUM

LEGEND
 BARRICADE-TYPE III
 PROPOSED DETOUR

PART II
SPECIFICATIONS AND STANDARD DRAWINGS

SPECIFICATIONS REFERENCE

Any reference in the plans or proposal to previous editions of the *Standard Specifications for Road and Bridge Construction* and *Standard Drawings* are superseded by *Standard Specifications for Road and Bridge Construction, Edition of 2019* and *Standard Drawings, Edition of 2016*.

SUPPLEMENTAL SPECIFICATIONS

The contractor shall use the Supplemental Specifications that are effective at the time of letting.
The Supplemental Specifications can be found at the following link:

<http://transportation.ky.gov/Construction/Pages/Kentucky-Standard-Specifications.aspx>

SPECIAL NOTE FOR PORTABLE CHANGEABLE MESSAGE SIGNS

This Special Note will apply when indicated on the plans or in the proposal.

1.0 DESCRIPTION. Furnish, install, operate, and maintain variable message signs at the locations shown on the plans or designated by the Engineer. Remove and retain possession of variable message signs when they are no longer needed on the project.

2.0 MATERIALS.

2.1 General. Use LED Variable Message Signs Class I, II, or III, as appropriate, from the Department's List of Approved Materials.

Unclassified signs may be submitted for approval by the Engineer. The Engineer may require a daytime and nighttime demonstration. The Engineer will make a final decision within 30 days after all required information is received.

2.2 Sign and Controls. All signs must:

- 1) Provide 3-line messages with each line being 8 characters long and at least 18 inches tall. Each character comprises 35 pixels.
- 2) Provide at least 40 preprogrammed messages available for use at any time. Provide for quick and easy change of the displayed message; editing of the message; and additions of new messages.
- 3) Provide a controller consisting of:
 - a) Keyboard or keypad.
 - b) Readout that mimics the actual sign display. (When LCD or LCD type readout is used, include backlighting and heating or otherwise arrange for viewing in cold temperatures.)
 - c) Non-volatile memory or suitable memory with battery backup for storing pre-programmed messages.
 - d) Logic circuitry to control the sequence of messages and flash rate.
- 4) Provide a serial interface that is capable of supporting complete remote control ability through land line and cellular telephone operation. Include communication software capable of immediately updating the message, providing complete sign status, and allowing message library queries and updates.
- 5) Allow a single person easily to raise the sign to a satisfactory height above the pavement during use, and lower the sign during travel.
- 6) Be Highway Orange on all exterior surfaces of the trailer, supports, and controller cabinet.
- 7) Provide operation in ambient temperatures from -30 to + 120 degrees Fahrenheit during snow, rain and other inclement weather.
- 8) Provide the driver board as part of a module. All modules are interchangeable, and have plug and socket arrangements for disconnection and reconnection. Printed circuit boards associated with driver boards have a conformable coating to protect against moisture.
- 9) Provide a sign case sealed against rain, snow, dust, insects, etc. The lens is UV stabilized clear plastic (polycarbonate, acrylic, or other approved material) angled to prevent glare.
- 10) Provide a flat black UV protected coating on the sign hardware, character PCB, and appropriate lens areas.
- 11) Provide a photocell control to provide automatic dimming.

- 12) Allow an on-off flashing sequence at an adjustable rate.
- 13) Provide a sight to aim the message.
- 14) Provide a LED display color of approximately 590 nm amber.
- 15) Provide a controller that is password protected.
- 16) Provide a security device that prevents unauthorized individuals from accessing the controller.
- 17) Provide the following 3-line messages preprogrammed and available for use when the sign unit begins operation:

/KEEP/RIGHT/=>=>=>/	/MIN/SPEED/**MPH/
/KEEP/LEFT/<=<=</	/ICY/BRIDGE/AHEAD/ /ONE
/LOOSE/GRAVEL/AHEAD/	LANE/BRIDGE/AHEAD/
/RD WORK/NEXT/**MILES/	/ROUGH/ROAD/AHEAD/
/TWO WAY/TRAFFIC/AHEAD/	/MERGING/TRAFFIC/AHEAD/
/PAINT/CREW/AHEAD/	/NEXT/***/MILES/
/REDUCE/SPEED/**MPH/	/HEAVY/TRAFFIC/AHEAD/
/BRIDGE/WORK/***0 FT/	/SPEED/LIMIT/**MPH/
/MAX/SPEED/**MPH/	/BUMP/AHEAD/
/SURVEY/PARTY/AHEAD/	/TWO/WAY/TRAFFIC/

*Insert numerals as directed by the Engineer.
Add other messages during the project when required by the Engineer.

2.3 Power.

- 1) Design solar panels to yield 10 percent or greater additional charge than sign consumption. Provide direct wiring for operation of the sign or arrow board from an external power source to provide energy backup for 21 days without sunlight and an on-board system charger with the ability to recharge completely discharged batteries in 24 hours.

3.0 CONSTRUCTION. Furnish and operate the variable message signs as designated on the plans or by the Engineer. Ensure the bottom of the message panel is a minimum of 7 feet above the roadway in urban areas and 5 feet above in rural areas when operating. Use Class I, II, or III signs on roads with a speed limit less than 55 mph. Use Class I or II signs on roads with speed limits 55 mph or greater.

Maintain the sign in proper working order, including repair of any damage done by others, until completion of the project. When the sign becomes inoperative, immediately repair or replace the sign. Repetitive problems with the same unit will be cause for rejection and replacement.

Use only project related messages and messages directed by the Engineer, unnecessary messages lessen the impact of the sign. Ensure the message is displayed in either one or 2 phases with each phase having no more than 3 lines of text. When no message is needed, but it is necessary to know if the sign is operable, flash only a pixel.

When the sign is not needed, move it outside the clear zone or where the Engineer directs. Variable Message Signs are the property of the Contractor and shall be removed from the project when no longer needed. The Department will not assume ownership of these signs.

4.0 MEASUREMENT. The final quantity of Variable Message Sign will be

11

the actual number of individual signs acceptably furnished and operated during the project. The Department will not measure signs replaced due to damage or rejection.

5.0 PAYMENT. The Department will pay for the Variable Message Signs at the unit price each. The Department will not pay for signs replaced due to damage or rejection. Payment is full compensation for furnishing all materials, labor, equipment, and service necessary to, operate, move, repair, and maintain or replace the variable message signs. The Department will make payment for the completed and accepted quantities under the following:

<u>Code</u>	<u>Pay Item</u>	<u>Pay Unit</u>
02671	Portable Changeable Message Sign	Each

Effective June 15, 2012

PART III

EMPLOYMENT, WAGE AND RECORD REQUIREMENTS

**TRANSPORTATION CABINET
DEPARTMENT OF HIGHWAYS**

**LABOR AND WAGE REQUIREMENTS
APPLICABLE TO OTHER THAN FEDERAL-AID SYSTEM PROJECTS**

- I. Application
- II. Nondiscrimination of Employees (KRS 344)

I. APPLICATION

1. These contract provisions shall apply to all work performed on the contract by the contractor with his own organization and with the assistance of workmen under his immediate superintendence and to all work performed on the contract by piecework, station work or by subcontract. The contractor's organization shall be construed to include only workmen employed and paid directly by the contractor and equipment owned or rented by him, with or without operators.

2. The contractor shall insert in each of his subcontracts all of the stipulations contained in these Required Provisions and such other stipulations as may be required.

3. A breach of any of the stipulations contained in these Required Provisions may be grounds for termination of the contract.

3. If the contractor is in control of apprenticeship or other training or retraining, including on-the-job training programs, he shall not discriminate against an individual because of his race, color, religion, national origin, sex, disability or age forty (40) and over, in admission to, or employment in any program established to provide apprenticeship or other training.

4. The contractor will send to each labor union or representative of workers with which he has a collective bargaining agreement or other contract or understanding, a notice to be provided advising the said labor union or workers' representative of the contractor's commitments under this section, and shall post copies of the notice in conspicuous places available to employees and applicants for employment. The contractor will take such action with respect to any subcontract or purchase order as the administrating agency may direct as a means of enforcing such provisions, including sanctions for non-compliance.

Revised: January 25, 2017

II. NONDISCRIMINATION OF EMPLOYEES

**AN ACT OF THE KENTUCKY
GENERAL ASSEMBLY TO PREVENT
DISCRIMINATION IN EMPLOYMENT
KRS CHAPTER 344
EFFECTIVE JUNE 16, 1972**

The contract on this project, in accordance with KRS Chapter 344, provides that during the performance of this contract, the contractor agrees as follows:

1. The contractor shall not fail or refuse to hire, or shall not discharge any individual, or otherwise discriminate against an individual with respect to his compensation, terms, conditions, or privileges of employment, because of such individual's race, color, religion, national origin, sex, disability or age (forty and above); or limit, segregate, or classify his employees in any way which would deprive or tend to deprive an individual of employment opportunities or otherwise adversely affect his status as an employee, because of such individual's race, color, religion, national origin, sex, disability or age forty (40) and over. The contractor agrees to post in conspicuous places, available to employees and applicants for employment, notices to be provided setting forth the provisions of this nondiscrimination clause.

2. The contractor shall not print or publish or cause to be printed or published a notice or advertisement relating to employment by such an employer or membership in or any classification or referral for employment by the employment agency, indicating any preference, limitation, specification, or discrimination, based on race, color, religion, national origin, sex, or age forty (40) and over, or because the person is a qualified individual with a disability, except that such a notice or advertisement may indicate a preference, limitation, or specification based on religion, national origin, sex, or age forty (40) and over, or because the person is a qualified individual with a disability, when religion, national origin, sex, or age forty (40) and over, or because the person is a qualified individual with a disability, is a bona fide occupational qualification for employment.

EXECUTIVE BRANCH CODE OF ETHICS

In the 1992 regular legislative session, the General Assembly passed and Governor Brereton Jones signed Senate Bill 63 (codified as KRS 11A), the Executive Branch Code of Ethics, which states, in part:

KRS 11A.040 (7) provides:

No present or former public servant shall, within six (6) months following termination of his office or employment, accept employment, compensation, or other economic benefit from any person or business that contracts or does business with, or is regulated by, the state in matters in which he was directly involved during the last thirty-six (36) months of his tenure. This provision shall not prohibit an individual from returning to the same business, firm, occupation, or profession in which he was involved prior to taking office or beginning his term of employment, or for which he received, prior to his state employment, a professional degree or license, provided that, for a period of six (6) months, he personally refrains from working on any matter in which he was directly involved during the last thirty-six (36) months of his tenure in state government. This subsection shall not prohibit the performance of ministerial functions, including but not limited to filing tax returns, filing applications for permits or licenses, or filing incorporation papers, nor shall it prohibit the former officer or public servant from receiving public funds disbursed through entitlement programs.

KRS 11A.040 (9) states:

A former public servant shall not represent a person or business before a state agency in a matter in which the former public servant was directly involved during the last thirty-six (36) months of his tenure, for a period of one (1) year after the latter of:

- a) The date of leaving office or termination of employment; or
- b) The date the term of office expires to which the public servant was elected.

This law is intended to promote public confidence in the integrity of state government and to declare as public policy the idea that state employees should view their work as a public trust and not as a way to obtain private benefits.

If you have worked for the executive branch of state government within the past six months, you may be subject to the law's prohibitions. The law's applicability may be different if you hold elected office or are contemplating representation of another before a state agency.

Also, if you are affiliated with a firm which does business with the state and which employs former state executive-branch employees, you should be aware that the law may apply to them.

In case of doubt, the law permits you to request an advisory opinion from the Executive Branch Ethics Commission, 3 Fountain Place, Frankfort, Kentucky 40601; telephone (502) 564-7954.

Revised: January 27, 2017

Kentucky Equal Employment Opportunity Act of 1978

The requirements of the Kentucky Equal Employment Opportunity Act of 1978 (KRS 45.560-45.640) shall apply to this Contract. The apparent low Bidder will be required to submit EEO forms to the Division of Construction Procurement, which will then forward to the Finance and Administration Cabinet for review and approval. No award will become effective until all forms are submitted and EEO/CC has certified compliance. The required EEO forms are as follows:

- EEO-1: Employer Information Report
- Affidavit of Intent to Comply
- Employee Data Sheet
- Subcontractor Report

These forms are available on the Finance and Administration's web page under ***Vendor Information, Standard Attachments and General Terms*** at the following address:
<https://www.eProcurement.ky.gov>.

Bidders currently certified as being in compliance by the Finance and Administration Cabinet may submit a copy of their approval letter in lieu of the referenced EEO forms.

For questions or assistance please contact the Finance and Administration Cabinet by email at **finance.contractcompliance@ky.gov** or by phone at 502-564-2874.

EMPLOYEE RIGHTS UNDER THE FAIR LABOR STANDARDS ACT

THE UNITED STATES DEPARTMENT OF LABOR WAGE AND HOUR DIVISION

FEDERAL MINIMUM WAGE

\$7.25 PER HOUR

BEGINNING JULY 24, 2009

OVERTIME PAY At least 1½ times your regular rate of pay for all hours worked over 40 in a workweek.

CHILD LABOR An employee must be at least **16** years old to work in most non-farm jobs and at least **18** to work in non-farm jobs declared hazardous by the Secretary of Labor.

Youths **14** and **15** years old may work outside school hours in various non-manufacturing, non-mining, non-hazardous jobs under the following conditions:

No more than

- **3** hours on a school day or **18** hours in a school week;
- **8** hours on a non-school day or **40** hours in a non-school week.

Also, work may not begin before **7 a.m.** or end after **7 p.m.**, except from June 1 through Labor Day, when evening hours are extended to **9 p.m.** Different rules apply in agricultural employment.

TIP CREDIT Employers of “tipped employees” must pay a cash wage of at least \$2.13 per hour if they claim a tip credit against their minimum wage obligation. If an employee’s tips combined with the employer’s cash wage of at least \$2.13 per hour do not equal the minimum hourly wage, the employer must make up the difference. Certain other conditions must also be met.

ENFORCEMENT The Department of Labor may recover back wages either administratively or through court action, for the employees that have been underpaid in violation of the law. Violations may result in civil or criminal action.

Employers may be assessed civil money penalties of up to \$1,100 for each willful or repeated violation of the minimum wage or overtime pay provisions of the law and up to \$11,000 for each employee who is the subject of a violation of the Act’s child labor provisions. In addition, a civil money penalty of up to \$50,000 may be assessed for each child labor violation that causes the death or serious injury of any minor employee, and such assessments may be doubled, up to \$100,000, when the violations are determined to be willful or repeated. The law also prohibits discriminating against or discharging workers who file a complaint or participate in any proceeding under the Act.

ADDITIONAL INFORMATION

- Certain occupations and establishments are exempt from the minimum wage and/or overtime pay provisions.
- Special provisions apply to workers in American Samoa and the Commonwealth of the Northern Mariana Islands.
- Some state laws provide greater employee protections; employers must comply with both.
- The law requires employers to display this poster where employees can readily see it.
- Employees under 20 years of age may be paid \$4.25 per hour during their first 90 consecutive calendar days of employment with an employer.
- Certain full-time students, student learners, apprentices, and workers with disabilities may be paid less than the minimum wage under special certificates issued by the Department of Labor.

For additional information:



1-866-4-USWAGE

(1-866-487-9243) TTY: 1-877-889-5627



WWW.WAGEHOUR.DOL.GOV

PART IV
INSURANCE

Refer to
Kentucky Standard Specifications for Road and Bridge Construction,
current edition

PART V
BID ITEMS

PROPOSAL BID ITEMS

191077

Page 1 of 1

Report Date 11/7/19

Section: 0001 - PAVING

LINE	BID CODE	ALT	DESCRIPTION	QUANTITY	UNIT	UNIT PRIC	FP	AMOUNT
0010	00001		DGA BASE	556.00	TON		\$	
0020	00078		CRUSHED AGGREGATE SIZE NO 2	800.00	TON		\$	
0030	00190		LEVELING & WEDGING PG64-22	61.00	TON		\$	
0040	00221		CL2 ASPH BASE 0.75D PG64-22	1,123.00	TON		\$	
0050	00307		CL2 ASPH SURF 0.38B PG64-22	899.00	TON		\$	
0060	00356		ASPHALT MATERIAL FOR TACK	4.20	TON		\$	
0070	02024		JPC PAVEMENT-10 IN/24	67.00	SQYD		\$	
0080	02677		ASPHALT PAVE MILLING & TEXTURING	36.00	TON		\$	

Section: 0002 - ROADWAY

LINE	BID CODE	ALT	DESCRIPTION	QUANTITY	UNIT	UNIT PRIC	FP	AMOUNT
0090	02014		BARRICADE-TYPE III	4.00	EACH		\$	
0100	02231		STRUCTURE GRANULAR BACKFILL	156.00	CUYD		\$	
0110	02562		TEMPORARY SIGNS	350.00	SQFT		\$	
0120	02650		MAINTAIN & CONTROL TRAFFIC	1.00	LS		\$	
0130	02671		PORTABLE CHANGEABLE MESSAGE SIGN	2.00	EACH		\$	
0140	02676		MOBILIZATION FOR MILL & TEXT	1.00	LS		\$	
0150	02726		STAKING	1.00	LS		\$	
0160	02731		REMOVE STRUCTURE	1.00	LS		\$	
0170	06510		PAVE STRIPING-TEMP PAINT-4 IN	18,000.00	LF		\$	
0180	06514		PAVE STRIPING-PERM PAINT-4 IN	40,128.00	LF		\$	
0190	20071EC		JOINT ADHESIVE	4,429.00	LF		\$	
0200	21415ND		EROSION CONTROL	1.00	LS		\$	
0210	22861EN		HIGH STRENGTH GEOTEXTILE FABRIC TY V	1,690.00	SQYD		\$	
0220	23911EC		GROUT	10.00	CUYD		\$	
0230	24649EN		ALUMINUM STRUCTURAL PLATE BOX CULVERT 20'-11" X 6'-1"	1.00	LS		\$	

Section: 0003 - DEMOBILIZATION &/OR MOBILIZATION

LINE	BID CODE	ALT	DESCRIPTION	QUANTITY	UNIT	UNIT PRIC	FP	AMOUNT
0240	02569		DEMOBILIZATION	1.00	LS		\$	