



CALL NO. 319

CONTRACT ID. 172615

KNOTT COUNTY

FED/STATE PROJECT NUMBER FE02 060 0015 B00056N

DESCRIPTION BEAM REPAIR & DRAIN PIPE REPLACEMENT ON KY 15 (MP 5.686).

WORK TYPE BRIDGE REPAIRS

PRIMARY COMPLETION DATE 7/31/2018

LETTING DATE: December 08,2017

Sealed Bids will be received electronically through the Bid Express bidding service until 10:00 AM EASTERN STANDARD TIME December 08,2017. Bids will be publicly announced at 10:00 AM EASTERN STANDARD TIME.

NO PLANS ASSOCIATED WITH THIS PROJECT.

REQUIRED BID PROPOSAL GUARANTY: Not less than 5% of the total bid.

TABLE OF CONTENTS

| | |
|----------|--|
| PART I | SCOPE OF WORK |
| | <ul style="list-style-type: none">• PROJECT(S), COMPLETION DATE(S), & LIQUIDATED DAMAGES• CONTRACT NOTES• STATE CONTRACT NOTES• SPECIAL NOTE(S) APPLICABLE TO PROJECT• LIQUIDATED DAMAGES• TRAFFIC CONTROL PLAN• SKETCH MAP(S)• BRIDGE DRAWINGS |
| PART II | SPECIFICATIONS AND STANDARD DRAWINGS |
| | <ul style="list-style-type: none">• SPECIFICATIONS REFERENCE• SUPPLEMENTAL SPECIFICATION• STANDARD DRAWINGS THAT APPLY |
| PART III | EMPLOYMENT, WAGE AND RECORD REQUIREMENTS |
| | <ul style="list-style-type: none">• LABOR AND WAGE REQUIREMENTS• EXECUTIVE BRANCH CODE OF ETHICS• KENTUCKY EQUAL EMPLOYMENT OPPORTUNITY ACT OF 1978 LOCALITY / STATE• PROJECT WAGE RATES / STATE |
| PART IV | INSURANCE |
| PART V | BID ITEMS |

PART I
SCOPE OF WORK

ADMINISTRATIVE DISTRICT - 12

CONTRACT ID - 172615

FE02 060 0015 B00056N

COUNTY - KNOTT

PCN - MB06000151701

FE02 060 0015 B00056N

BEAM REPAIR & DRAIN PIPE REPLACEMENT ON KY 15 (MP 5.686). BRIDGE OVER CARR FORK LAKEBRIDGE
REPAIRS

GEOGRAPHIC COORDINATES LATITUDE 37:13:48.00 LONGITUDE 82:59:52.00

COMPLETION DATE(S):

COMPLETED BY 07/31/2018

APPLIES TO ENTIRE CONTRACT

30 CALENDAR Days

APPLIES TO 060B00056N

CONTRACT NOTES

PROPOSAL ADDENDA

All addenda to this proposal must be applied when calculating bid and certified in the bid packet submitted to the Kentucky Department of Highways. Failure to use the correct and most recent addenda may result in the bid being rejected.

BID SUBMITTAL

Bidder must use the Department's Expedite Bidding Program available on the Internet web site of the Department of Highways, Division of Construction Procurement. (www.transportation.ky.gov/construction-procurement)

The Bidder must download the bid file located on the Bid Express website (www.bidx.com) to prepare a bid packet for submission to the Department. The bidder must submit electronically using Bid Express.

JOINT VENTURE BIDDING

Joint venture bidding is permissible. All companies in the joint venture must be prequalified in one of the work types in the Qualifications for Bidders for the project. The bidders must get a vendor ID for the joint venture from the Division of Construction Procurement and register the joint venture as a bidder on the project. Also, the joint venture must obtain a digital ID from Bid Express to submit a bid. A joint bid bond of 5% may be submitted for both companies or each company may submit a separate bond of 5%.

UNDERGROUND FACILITY DAMAGE PROTECTION

The contractor shall make every effort to protect underground facilities from damage as prescribed in the Underground Facility Damage Protection Act of 1994, Kentucky Revised Statute KRS 367.4901 to 367.4917. It is the contractor's responsibility to determine and take steps necessary to be in compliance with federal and state damage prevention directives. When prescribed in said directives, the contractor shall submit Excavation Locate Requests to the Kentucky Contact Center (KY811) via web ticket entry. The submission of this request does not relieve the contractor from the responsibility of contacting non-member facility owners, whom shall be contacted through their individual Protection Notification Center. Non-compliance with these directives can result in the enforcement of penalties.

SPECIAL NOTE FOR COMPOSITE OFFSET BLOCKS

Contrary to the Standard Drawings (2016 edition) the Cabinet will allow 6" composite offset blocks in lieu of wooden offset blocks, except as specified on proprietary end treatments and crash cushions. The composite blocks shall be selected from the Cabinet's List of Approved Materials.

REGISTRATION WITH THE SECRETARY OF STATE BY A FOREIGN ENTITY

Pursuant to KRS 176.085(1)(b), an agency, department, office, or political subdivision of the Commonwealth of Kentucky shall not award a state contract to a person that is a foreign entity required by [KRS 14A.9-010](#) to obtain a certificate of authority to transact business in the Commonwealth (“certificate”) from the Secretary of State under [KRS 14A.9-030](#) unless the person produces the certificate within fourteen (14) days of the bid or proposal opening. If the foreign entity is not required to obtain a certificate as provided in [KRS 14A.9-010](#), the foreign entity should identify the applicable exception. Foreign entity is defined within [KRS 14A.1-070](#).

For all foreign entities required to obtain a certificate of authority to transact business in the Commonwealth, if a copy of the certificate is not received by the contracting agency within the time frame identified above, the foreign entity’s solicitation response shall be deemed non-responsive or the awarded contract shall be cancelled.

Businesses can register with the Secretary of State at <https://secure.kentucky.gov/sos/ftbr/welcome.aspx>.

SPECIAL NOTE FOR PROJECT QUESTIONS DURING ADVERTISEMENT

Questions about projects during the advertisement should be submitted in writing to the Division of Construction Procurement. This may be done by fax (502) 564-7299 or email to kytc.projectquestions@ky.gov. The Department will attempt to answer all submitted questions. The Department reserves the right not to answer if the question is not pertinent or does not aid in clarifying the project intent.

The deadline for posting answers will be 3:00 pm Eastern Daylight Time, the day preceding the Letting. Questions may be submitted until this deadline with the understanding that the later a question is submitted, the less likely an answer will be able to be provided.

The questions and answers will be posted for each Letting under the heading “Questions & Answers” on the Construction Procurement website (www.transportation.ky.gov/contract). The answers provided shall be considered part of this Special Note and, in case of a discrepancy, will govern over all other bidding documents.

HARDWOOD REMOVAL RESTRICTIONS

The US Department of Agriculture has imposed a quarantine in Kentucky and several surrounding states, to prevent the spread of an invasive insect, the emerald ash borer. Hardwood cut in conjunction with the project may not be removed from the state. Chipping or burning on site is the preferred method of disposal.

INSTRUCTIONS FOR EXCESS MATERIAL SITES AND BORROW SITES

Identification of excess material sites and borrow sites shall be the responsibility of the Contractor. The Contractor shall be responsible for compliance with all applicable state and federal laws and may wish to consult with the US Fish and Wildlife Service to seek protection under Section 10 of the Endangered Species Act for these activities.

ACCESS TO RECORDS

The contractor, as defined in KRS 45A.030 (9) agrees that the contracting agency, the Finance and Administration Cabinet, the Auditor of Public Accounts, and the Legislative Research Commission, or their duly authorized representatives, shall have access to any books, documents, papers, records, or other evidence, which are directly pertinent to this contract for the purpose of financial audit or program review. Records and other prequalification information confidentially disclosed as part of the bid process shall not be deemed as directly pertinent to the contract and shall be exempt from disclosure as provided in KRS 61.878(1)(c). The contractor also recognizes that any books, documents, papers, records, or other evidence, received during a financial audit or program review shall be subject to the Kentucky Open Records Act, KRS 61.870 to 61.884.

In the event of a dispute between the contractor and the contracting agency, Attorney General, or the Auditor of Public Accounts over documents that are eligible for production and review, the Finance and Administration Cabinet shall review the dispute and issue a determination, in accordance with Secretary's Order 11-004.

06/01/16

SPECIAL NOTE FOR RECIPROCAL PREFERENCE

Reciprocal preference to be given by public agencies to resident bidders

By reference, KRS 45A.490 to 45A.494 are incorporated herein and in compliance regarding the bidders residency. Bidders who want to claim resident bidder status should complete the Affidavit for Claiming Resident Bidder Status along with their bid in the Expedite Bidding Program. Submittal of the Affidavit should be done along with the bid in Bid Express.

03/01/2011

SPECIAL NOTE FOR FIBERGLASS DRAIN PIPE

1. DESCRIPTION. Perform all work in accordance with the Kentucky Transportation Cabinet, Department of Highway's Standard Specifications for Road and Bridge Construction and applicable Supplemental Specifications, the Standard Drawings (Current Editions), this Note, and the attached detail drawings. Section references are to the Standard Specifications. This work consists of the following: (1) Furnish all labor, materials, tools, and equipment; (2) Install Fiberglass Drain Pipe, Fittings, Attachment Hardware, etc.; (3) Maintain and control traffic; and (5) Any other work specified as part of this contract.

II. MATERIALS.

A. Fiberglass Drain Pipe and Fittings

Use 6 inch inside diameter fiberglass drain pipe and fittings with 0.25" minimum wall thickness, filament wound with fiberglass epoxy resin formulation with ultraviolet inhibitors. Supply pipe and fittings pigmented to match standard concrete coloring. See the attached "ORIGINAL DESIGN DRAWING 19541 – SHEET 259" for reference.

B. Attachment Hardware

Use galvanized attachment hardware as specified by the manufacturer.

III. CONSTRUCTION.

A. Fiberglass Drain Pipe – 6 Inch. Complete installation of Fiberglass Drain Pipe as specified in this special note and per manufacturer's specifications. All pipe connections shall be leak proof. Pipe shall be cut and connected to field dimensions.

B. Remove Existing Drain Pipe. Remove existing drain pipe and all attachment hardware. Dispose of all removed material entirely away from the job site. All existing bridge deck drains shall remain and be cleaned of all debris before any new fiberglass drain pipe is installed. This work is incidental to the contract unit price for "Fiberglass Drain Pipe - 6 inch."

C. Verifying Field Conditions. The Contractor shall field verify all plate and shape dimensions, bolt patterns and locations before ordering any material. New material that is unsuitable due to variation in existing structure shall be replaced at the Contractors expense.

D. Damage to the structure. The Contractor shall bear all responsibility and expense for any and all damage to the structure during the repair work, even to the removal and replacement of a fallen span, should the fallen span result from the Contractors actions.

IV MEASUREMENT.

Fiberglass Drain Pipe – 6 Inch. The Department will measure the quantity in Linear Feet.

V. PAYMENT.

Fiberglass Drain Pipe – 6 Inch (21679EN). Payment at the contract unit price in Linear Feet is full compensation for removing and disposing of all existing drain pipe, furnishing and installing all new fiberglass drain pipe, fittings, attachment hardware, etc. as specified by the manufacturer.

Residual lead paint may still be on bridge. The Contractor is advised to take all necessary protective measures including worker safety and environmental regulations when performing surface preparation and other work. The Department will not consider any claims based on residual lead paint.

**SPECIAL NOTE FOR CONTRACT COMPLETION DATE AND
LIQUIDATED DAMAGES ON BRIDGE REPAIR CONTRACTS**

- I. COMPLETION DATE.** The Contractor has the option of selecting the starting date for this Contract. Once selected, notify the Department in writing of the date selected at least two weeks prior to beginning work. All work is to be started no earlier than June 1, 2018 and completed no later than July 31, 2018. An allotted number of Calendar days are assigned to each structure in this contract as shown below.

| <u>STRUCTURE</u> | <u>NO. OF CALENDAR DAYS</u> | <u>COMPLETION DATE</u> |
|------------------|-----------------------------|------------------------|
| 060B00056N | 30 | July 31, 2018 |

Contrary to Section 108.07.02, the Engineer will begin charging calendar days for a structure on the day the Contractor starts work or sets up traffic control on that particular structure.

- II. LIQUIDATED DAMAGES.** Liquidated damages will be assessed the Contractor in accordance with the Transportation Cabinet, Department of Highway's 2012 Standard Specifications for Road and Bridge Construction, Section 108.09, when either the allotted number of calendar days or the July 31, 2018 date is exceeded.

Contrary to the Standard Specifications, liquidated damages will be assessed the Contractor during the months of December, January, February and March when the contract time has expired on any individual bridge or bridges. Contract time will be charged during these months.

All construction must be completed in accordance with the weather limitations specified in Section 606 and/or Section 601 as applicable. No extension of Contract time will be granted due to inclement weather or temperature limitations that occur due to starting work on the Contract or a structure late in the construction season.

SPECIAL NOTE FOR TRAFFIC CONTROL ON BRIDGE REPAIR CONTRACTS

I. TRAFFIC CONTROL GENERAL

Except as provided herein, traffic shall be maintained in accordance with the 2012 Standard Specifications, Section 112. Except for the roadway and traffic control bid items listed, all items of work necessary to maintain and control traffic will be paid at the lump sum bid price to "Maintain and Control Traffic".

Contrary to Section 106.01, traffic control devices used on this project may be new or used in new condition, at the beginning of the work and maintained in like new condition until completion of the work.

II. TRAFFIC COORDINATOR

Furnish a Traffic Coordinator as per Section 112. The Traffic Coordinator shall inspect the project maintenance of traffic, at least three times daily, or as directed by the Engineer, during the Contractor's operations and at any time a lane closure is in place. The personnel shall have access on the project to a radio or telephone to be used in case of emergencies or accidents.

The Traffic Coordinator shall report all incidents throughout the work zone to the Engineer on the project. The Contractor shall furnish the name and telephone number where the Traffic Coordinator can be contacted at all times.

III. SIGNS

Contrary to Section 112.04.02, only long term signs (sign intended to be continuously in place for more than 3 days) will be measured for payment; short term signs (signs intended to be left in place for 3 days or less) will not be measured for payment but will be incidental to Maintain and Control Traffic.

The contractor is to install warning signs for wide loads in advance of the bridge under the direction of the Engineer. The Department will not measure installation, maintenance, or removal for payment, and will consider these incidentals to Maintain and Control Traffic.

IV. TEMPORARY PAVEMENT STRIPING

Skip lines and/or solid lines through the length of the tapers for lane closures and other striping as directed by the Engineer shall be temporarily covered with 6" black removable tape. Permanent removal of all other pavement striping for traffic control shall be considered incidental to Maintain and Control Traffic. Temporary pavement striping shall be paid only once per course in accordance with Section 112.04.07. The Contractor shall replace any temporary striping that becomes damaged or fails to adhere to the pavement before dark on the day of the notification. Liquidated damages shall be assessed to the Contractor at a rate of \$500 per day for failing to replace temporary striping within this time limit.

V. PROJECT PHASING & CONSTRUCTION PROCEDURES

Maintain one lane of traffic during construction in accordance with Standard Drawing No. TTC-110 for lane closures, and the attached detail drawing. The minimum clear lane width required is 13'-3".

VI. TEMPORARY SIGNAL

Provide, install, and maintain a temporary multi-phase traffic signal. The Contractor must provide a 24-hour contact person and number available to maintain the temporary signals as needed.

KNOTT COUNTY

BRIDGE 060B000056N
KY 15 (MP 5.686)
OVER CARR FORK LAKE
LatDD= 37.230, LonDD= -82.998

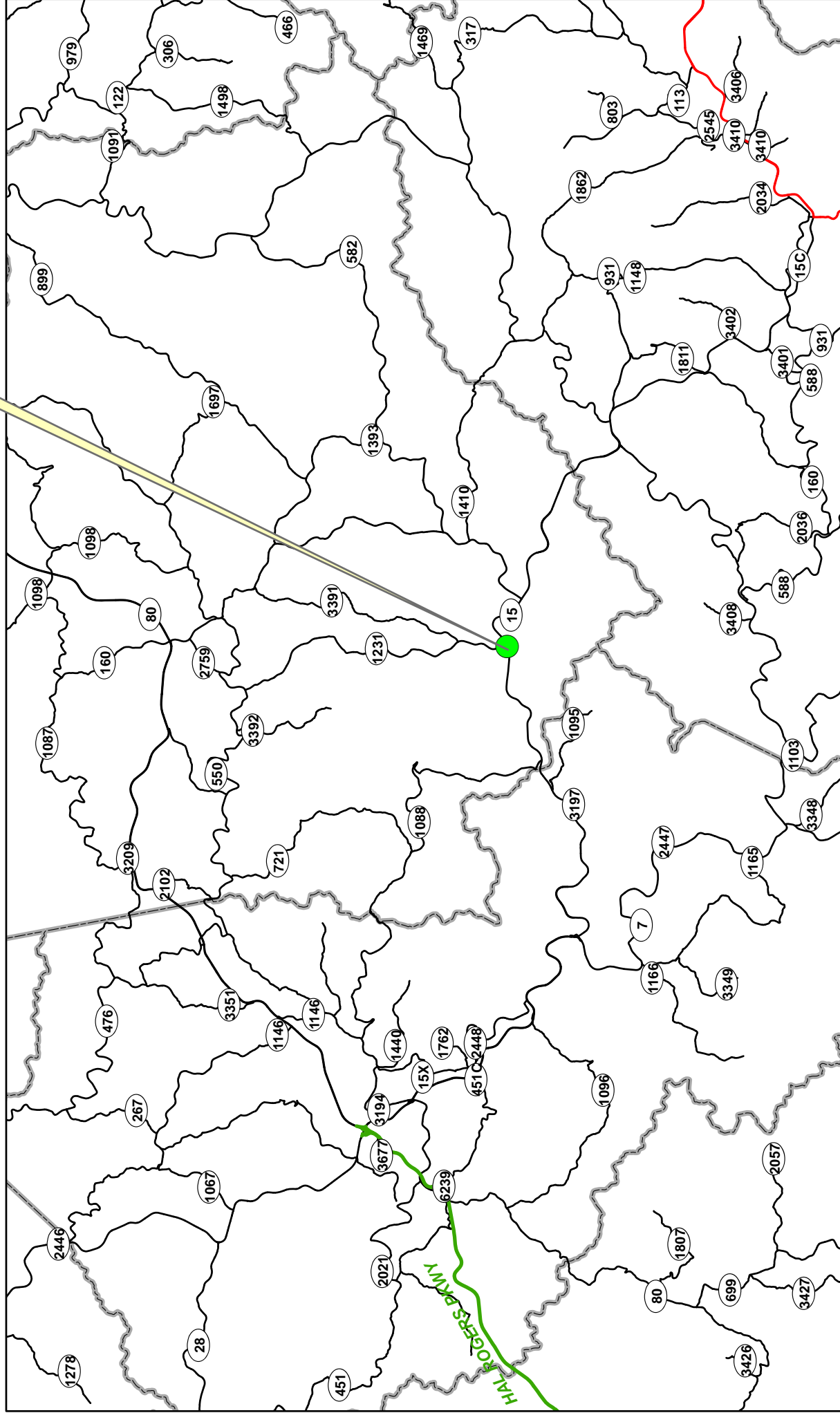
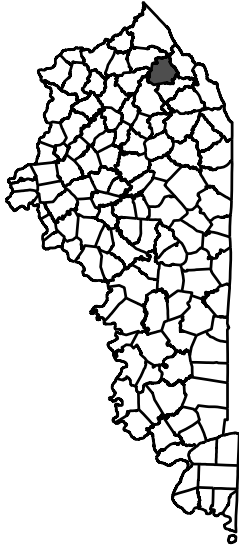

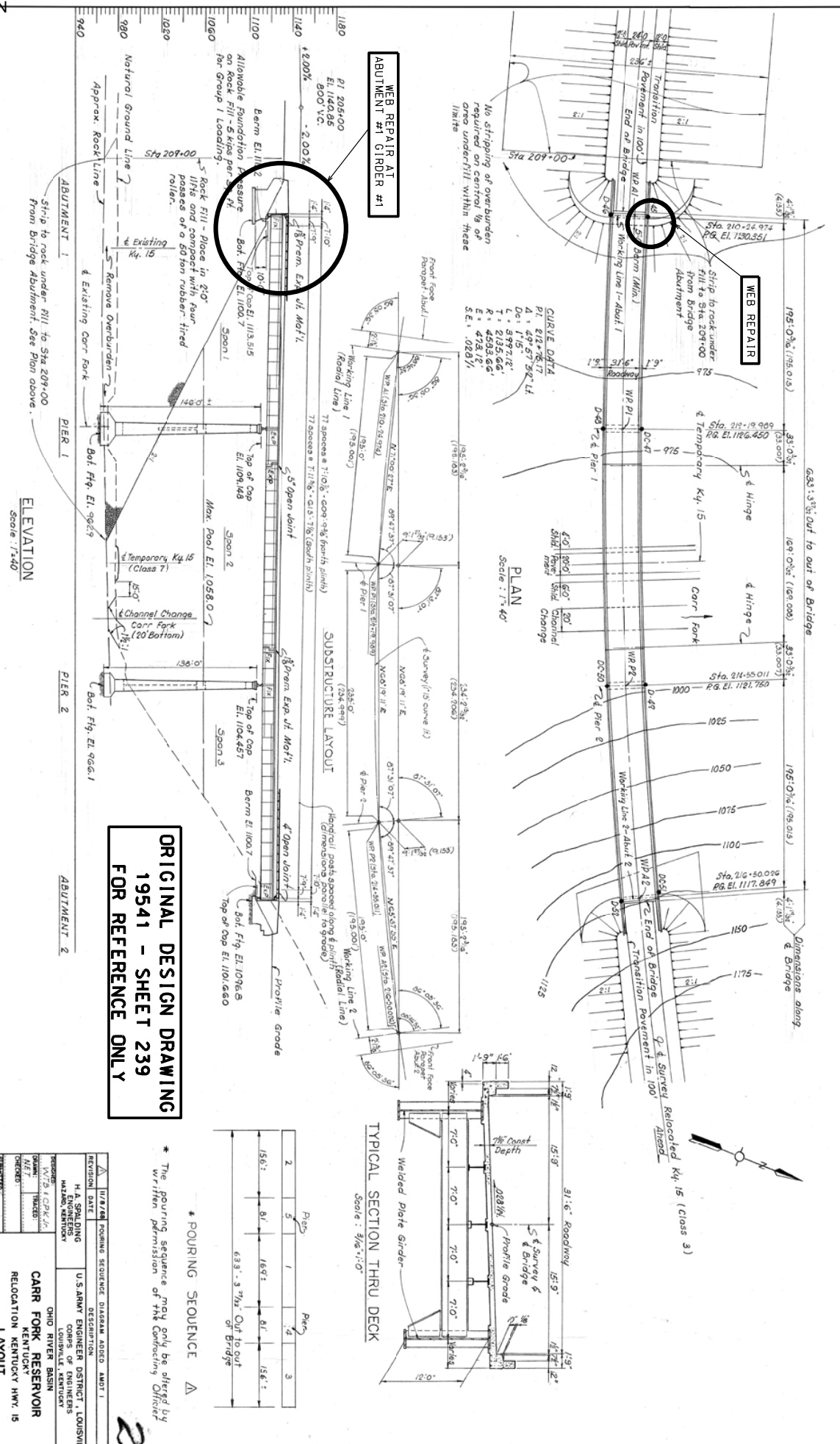

**ORIGINAL DESIGN DRAWING
19541 - SHEET 239
FOR REFERENCE ONLY**

* POURING SEQUENCE
The pouring sequence may only be offered by written permission of the Contracting Officer

| Span | 1 | 2 | 3 |
|-------------------------------------|-----|------|--------|
| 156.1' | 81' | 167' | 156.1' |
| 63.9' - 3 7/8" Out to Out of Bridge | | | |

| | |
|--|---|
| DATE: 11/27/24 | PROJECT: CARR FORK RESERVOIR RELOCATION KENTUCKY HWY. 15 LAYOUT |
| DESIGNER: H.A. SHANNON | CHECKED: M. J. COOPER |
| ENGINEER: HAZARD KENTON | APPROVED: [Signature] |
| U.S. ARMY ENGINEER DISTRICT LOUISVILLE, KENTUCKY | OHIO RIVER BASIN KENTUCKY |
| | RELOCATION KENTUCKY HWY. 15 LAYOUT |
| DATE: 11/27/24 | PROJECT: CARR FORK RESERVOIR RELOCATION KENTUCKY HWY. 15 LAYOUT |
| DESIGNER: H.A. SHANNON | CHECKED: M. J. COOPER |
| ENGINEER: HAZARD KENTON | APPROVED: [Signature] |
| U.S. ARMY ENGINEER DISTRICT LOUISVILLE, KENTUCKY | OHIO RIVER BASIN KENTUCKY |
| | RELOCATION KENTUCKY HWY. 15 LAYOUT |

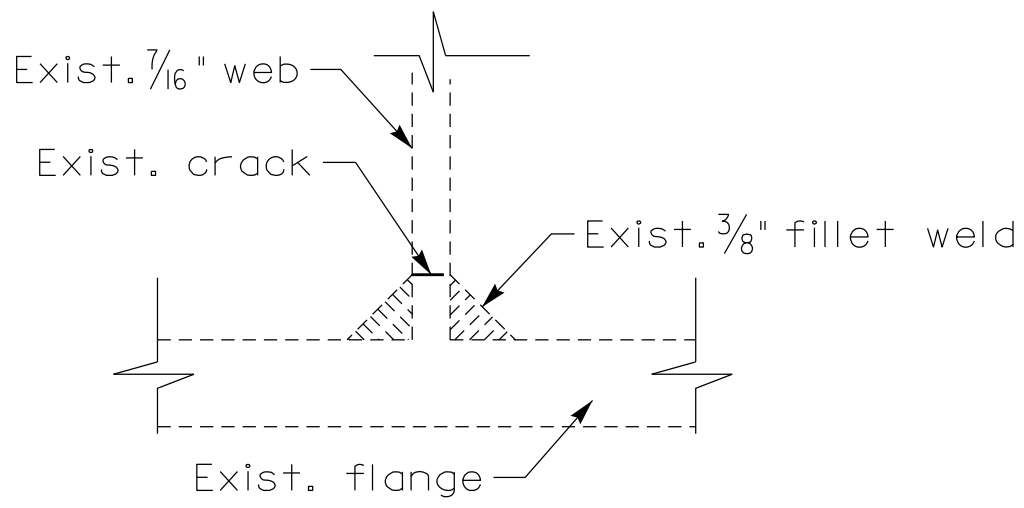

Existing Section @ Crack

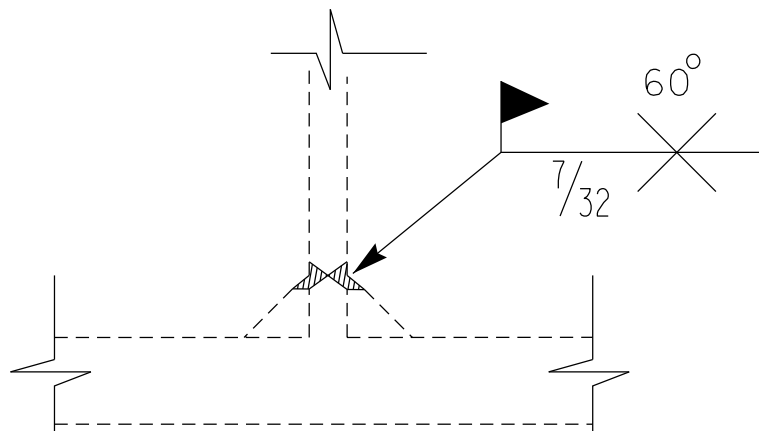

Proposed Section

Contractor to grind and weld existing crack on both sides of web.
Plate to be Grade 50 A709.

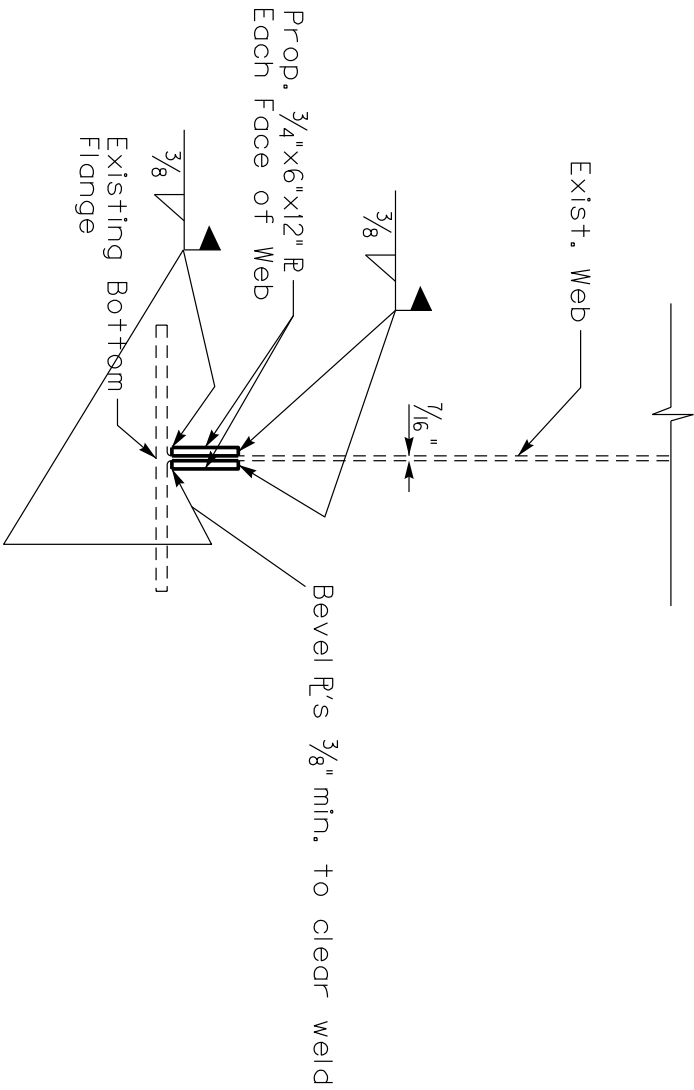
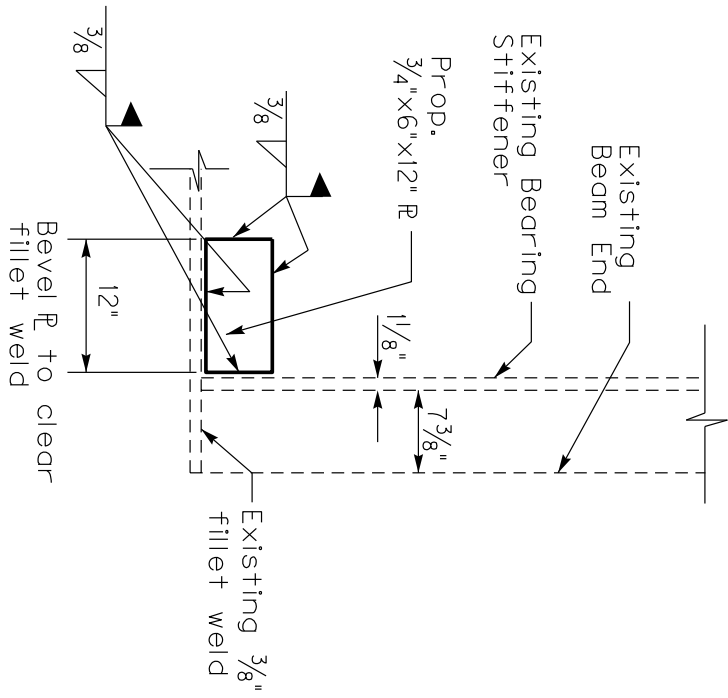

Proposed Web Plate Retrofit

ORIGINAL DESIGN DRAWING
19541 - SHEET 251
FOR REFERENCE ONLY

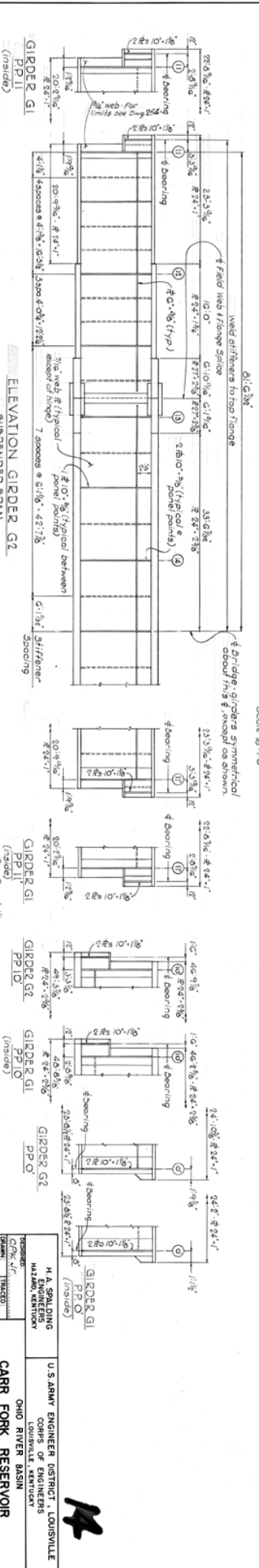
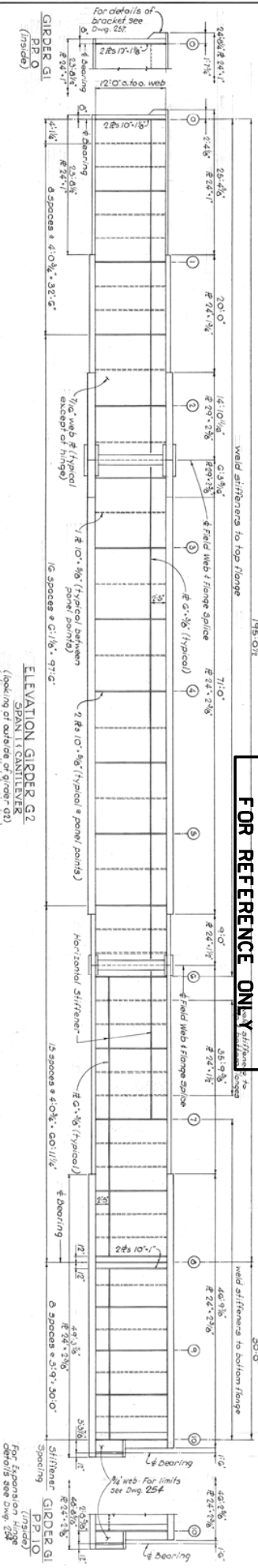
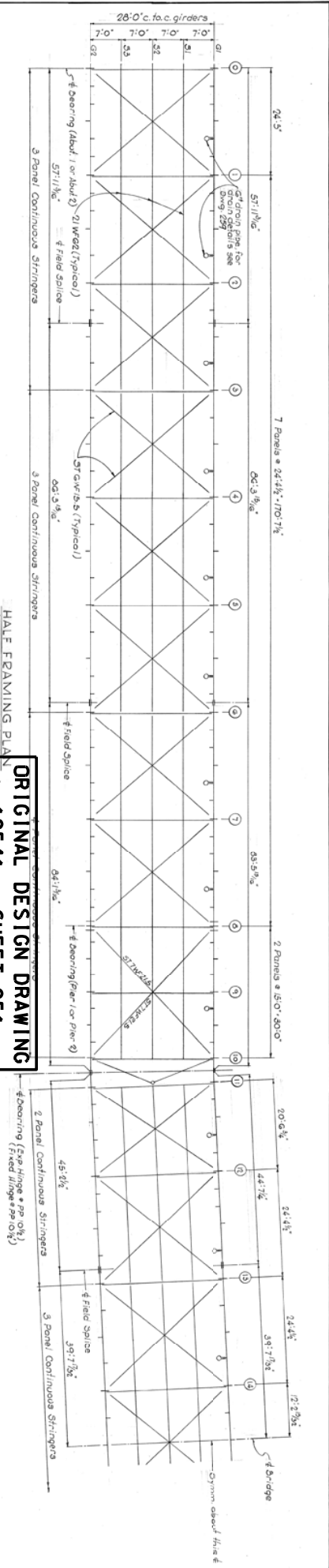

H. A. SPALDING
HARRIS, KENTUCKY
U.S. ARMY ENGINEER DISTRICT, LOUISVILLE
OHIO RIVER BASIN

CARR FORK RESERVOIR
RELOCATION KENTUCKY HWY. 15
FRAMING PLAN & GIRDER DETAILS

DATE: _____

APPROVED: _____

DESIGNED BY: _____

CHECKED BY: _____

SCALE: AS NOTED

PROJECT: NFK-13-12.3/251

AK

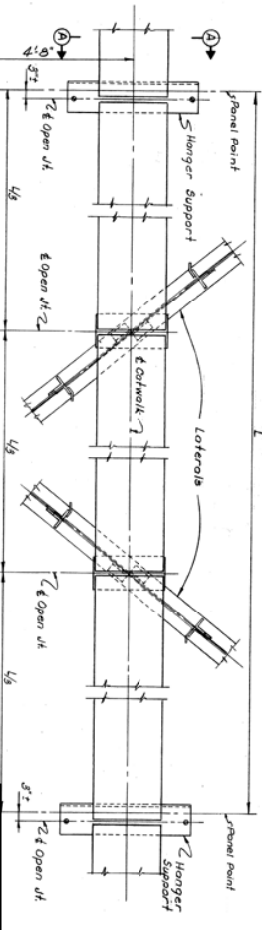

**ORIGINAL DESIGN DRAWING
 19541 - SHEET 259
 FOR REFERENCE ONLY**

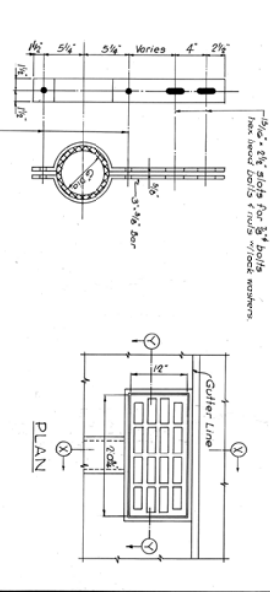
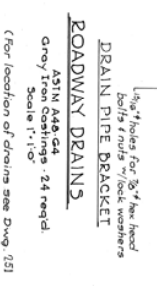
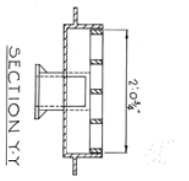
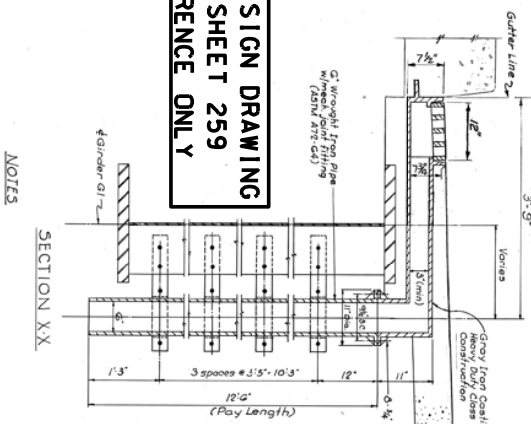
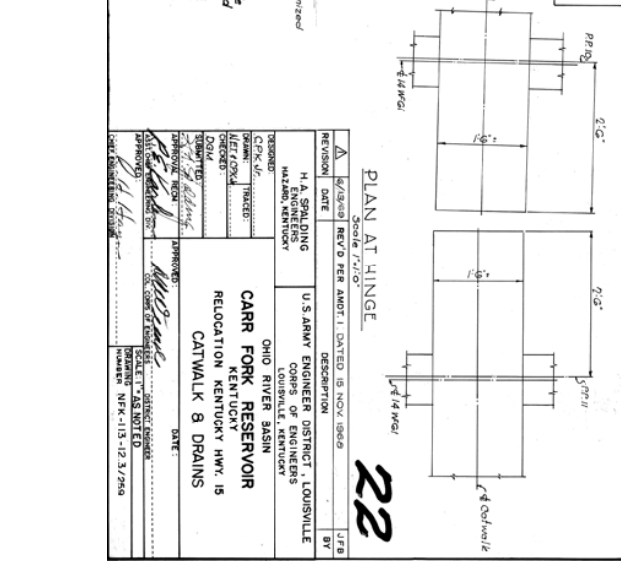
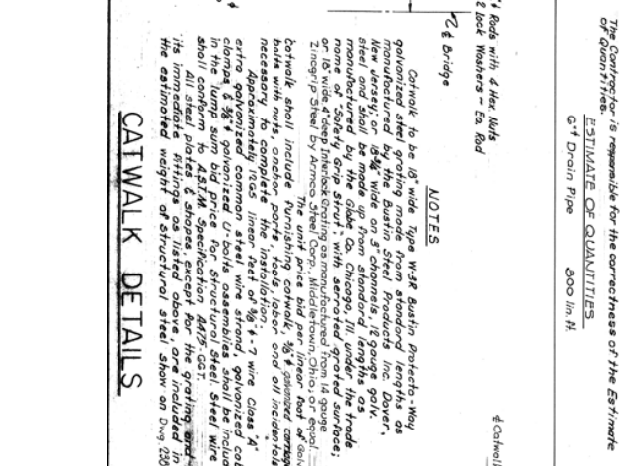
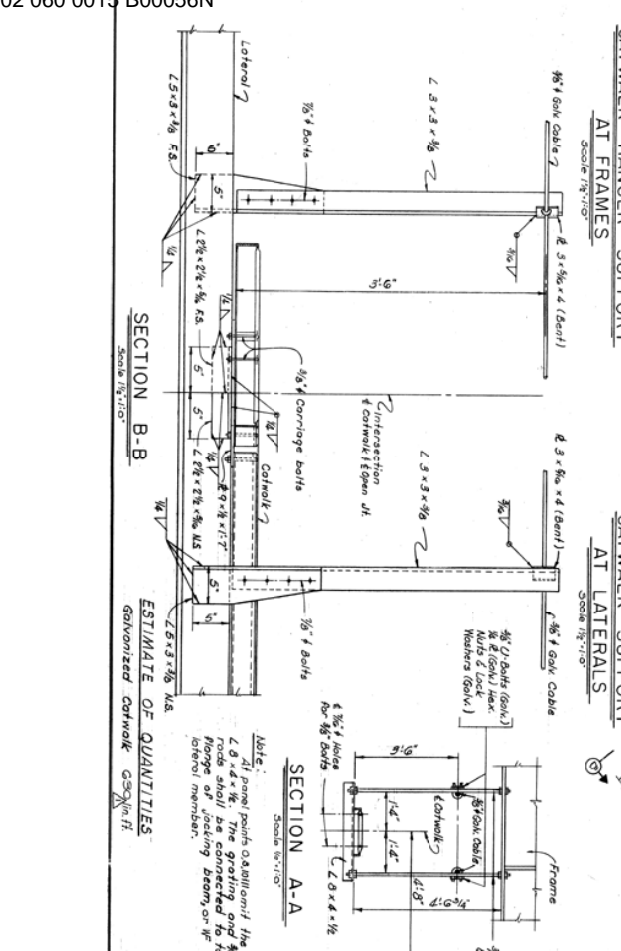
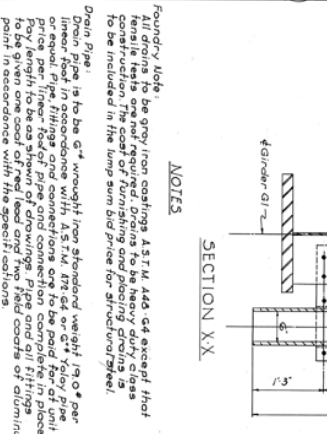
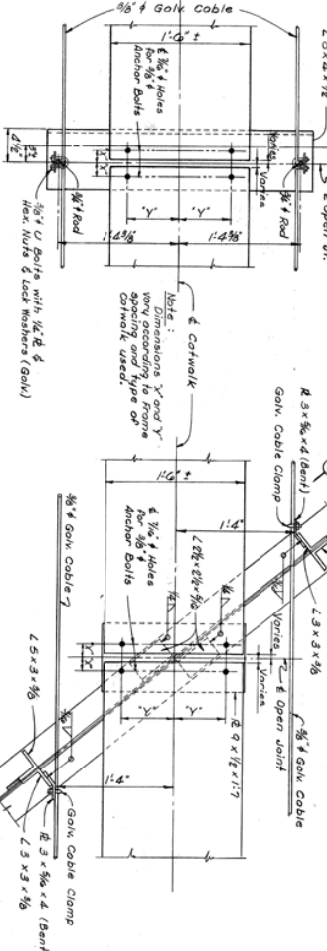

NOTES

Foundry Note: All drains to be gray iron coatings ASTM A48 except that ferrule ferris are not required. Drains to be heavy duty class 30. The cast of draining one packing gasket is to be included in the bid price for structural steel.

Drain Pipe to be 6" diameter, 14 lb weight 12' or less in length in accordance with ASTM A153, 12' or 6' long pipe or equal. Pipe fittings and connections are to be paid for at unit price per fitting, rod or pipe and connection complete in place to be given one coat of red lead and two field coats of aluminum paint in accordance with the specifications.

The Contractor is responsible for the correctness of the Estimate of Quantities.

ESTIMATE OF QUANTITIES
 300 in. H

NOTES

Cotwalk to be 18" wide Type W-8 Galvan Products - May galvanize steel grating made from standard lengths as manufactured by the Bunting Steel Products Inc. Dover, New Jersey, or 24" wide on 3" centers. 12 gauge galv. steel manufactured by the Galv. Co. Chicago, Ill. under the name of "Staley Grip-Strut" with serrated grooved surfaces; or 18" wide 4 deep interlocking galvanized steel grating from 12 gauge galvanized steel by Phoenix. The unit price bid per linear foot of galvanized cotwalk shall include furnishing cotwalk, 3/8" galvanized cotwalk with nuts, washers, rods, spacers and oil-included bolts approximately 1000 linear feet of 3/8" x 7" wire Class A cotwalk, 3/8" x 3/8" galvanized U-bolts, structural steel, galvanized cable in the lump sum bid price for structural steel shall include all steel plates & shapes, except for the grating and its immediate fittings as listed above, are included in the estimated weight of structural steel show on Dwg 250

PLAN AT HINGE
 Scale 1/16"=1'-0"

| REVISION | DATE | REV'D PER | AU'T'D | DATE | DESCRIPTION |
|----------|----------|----------------|----------------|-------------|--|
| 1 | 10/19/69 | H. A. SPALDING | H. A. SPALDING | 18 NOV 1969 | U. S. ARMY ENGINEER DISTRICT, LOUISVILLE |
| 2 | 11/20/69 | M. W. JONES | M. W. JONES | | CARR FORK RESERVOIR |
| 3 | 11/20/69 | M. W. JONES | M. W. JONES | | RELOCATION KENTUCKY HWY. 15 |
| 4 | 11/20/69 | M. W. JONES | M. W. JONES | | CATAWK 8 DRAINS |

DATE: 11/20/69

22

PART II
SPECIFICATIONS AND STANDARD DRAWINGS

SPECIFICATIONS REFERENCE

Any reference in the plans or proposal to previous editions of the *Standard Specifications for Road and Bridge Construction* and *Standard Drawings* are superseded by *Standard Specifications for Road and Bridge Construction, Edition of 2012* and *Standard Drawings, Edition of 2016*.

SUPPLEMENTAL SPECIFICATIONS

The contractor shall use the Supplemental Specifications that are effective at the time of letting.
The Supplemental Specifications can be found at the following link:

<http://transportation.ky.gov/Construction/Pages/Kentucky-Standard-Specifications.aspx>

STANDARD DRAWINGS THAT APPLY

**TRAFFIC
~ *TEMPORARY* ~
TRAFFIC CONTROL**

LANE CLOSURE USING TRAFFIC SIGNALS

TTC-110

DEVICES

POST SPLICING DETAIL

TTD-110

PART III

EMPLOYMENT, WAGE AND RECORD REQUIREMENTS

**TRANSPORTATION CABINET
DEPARTMENT OF HIGHWAYS**

**LABOR AND WAGE REQUIREMENTS
APPLICABLE TO OTHER THAN FEDERAL-AID SYSTEM PROJECTS**

- I. Application
- II. Nondiscrimination of Employees (KRS 344)

I. APPLICATION

1. These contract provisions shall apply to all work performed on the contract by the contractor with his own organization and with the assistance of workmen under his immediate superintendence and to all work performed on the contract by piecework, station work or by subcontract. The contractor's organization shall be construed to include only workmen employed and paid directly by the contractor and equipment owned or rented by him, with or without operators.

2. The contractor shall insert in each of his subcontracts all of the stipulations contained in these Required Provisions and such other stipulations as may be required.

3. A breach of any of the stipulations contained in these Required Provisions may be grounds for termination of the contract.

3. If the contractor is in control of apprenticeship or other training or retraining, including on-the-job training programs, he shall not discriminate against an individual because of his race, color, religion, national origin, sex, disability or age forty (40) and over, in admission to, or employment in any program established to provide apprenticeship or other training.

4. The contractor will send to each labor union or representative of workers with which he has a collective bargaining agreement or other contract or understanding, a notice to be provided advising the said labor union or workers' representative of the contractor's commitments under this section, and shall post copies of the notice in conspicuous places available to employees and applicants for employment. The contractor will take such action with respect to any subcontract or purchase order as the administrating agency may direct as a means of enforcing such provisions, including sanctions for non-compliance.

Revised: January 25, 2017

II. NONDISCRIMINATION OF EMPLOYEES

**AN ACT OF THE KENTUCKY
GENERAL ASSEMBLY TO PREVENT
DISCRIMINATION IN EMPLOYMENT
KRS CHAPTER 344
EFFECTIVE JUNE 16, 1972**

The contract on this project, in accordance with KRS Chapter 344, provides that during the performance of this contract, the contractor agrees as follows:

1. The contractor shall not fail or refuse to hire, or shall not discharge any individual, or otherwise discriminate against an individual with respect to his compensation, terms, conditions, or privileges of employment, because of such individual's race, color, religion, national origin, sex, disability or age (forty and above); or limit, segregate, or classify his employees in any way which would deprive or tend to deprive an individual of employment opportunities or otherwise adversely affect his status as an employee, because of such individual's race, color, religion, national origin, sex, disability or age forty (40) and over. The contractor agrees to post in conspicuous places, available to employees and applicants for employment, notices to be provided setting forth the provisions of this nondiscrimination clause.

2. The contractor shall not print or publish or cause to be printed or published a notice or advertisement relating to employment by such an employer or membership in or any classification or referral for employment by the employment agency, indicating any preference, limitation, specification, or discrimination, based on race, color, religion, national origin, sex, or age forty (40) and over, or because the person is a qualified individual with a disability, except that such a notice or advertisement may indicate a preference, limitation, or specification based on religion, national origin, sex, or age forty (40) and over, or because the person is a qualified individual with a disability, when religion, national origin, sex, or age forty (40) and over, or because the person is a qualified individual with a disability, is a bona fide occupational qualification for employment.

EXECUTIVE BRANCH CODE OF ETHICS

In the 1992 regular legislative session, the General Assembly passed and Governor Brereton Jones signed Senate Bill 63 (codified as KRS 11A), the Executive Branch Code of Ethics, which states, in part:

KRS 11A.040 (7) provides:

No present or former public servant shall, within six (6) months following termination of his office or employment, accept employment, compensation, or other economic benefit from any person or business that contracts or does business with, or is regulated by, the state in matters in which he was directly involved during the last thirty-six (36) months of his tenure. This provision shall not prohibit an individual from returning to the same business, firm, occupation, or profession in which he was involved prior to taking office or beginning his term of employment, or for which he received, prior to his state employment, a professional degree or license, provided that, for a period of six (6) months, he personally refrains from working on any matter in which he was directly involved during the last thirty-six (36) months of his tenure in state government. This subsection shall not prohibit the performance of ministerial functions, including but not limited to filing tax returns, filing applications for permits or licenses, or filing incorporation papers, nor shall it prohibit the former officer or public servant from receiving public funds disbursed through entitlement programs.

KRS 11A.040 (9) states:

A former public servant shall not represent a person or business before a state agency in a matter in which the former public servant was directly involved during the last thirty-six (36) months of his tenure, for a period of one (1) year after the latter of:

- a) The date of leaving office or termination of employment; or
- b) The date the term of office expires to which the public servant was elected.

This law is intended to promote public confidence in the integrity of state government and to declare as public policy the idea that state employees should view their work as a public trust and not as a way to obtain private benefits.

If you have worked for the executive branch of state government within the past six months, you may be subject to the law's prohibitions. The law's applicability may be different if you hold elected office or are contemplating representation of another before a state agency.

Also, if you are affiliated with a firm which does business with the state and which employs former state executive-branch employees, you should be aware that the law may apply to them.

In case of doubt, the law permits you to request an advisory opinion from the Executive Branch Ethics Commission, 3 Fountain Place, Frankfort, Kentucky 40601; telephone (502) 564-7954.

Kentucky Equal Employment Opportunity Act of 1978

The requirements of the Kentucky Equal Employment Opportunity Act of 1978 (KRS 45.560-45.640) shall apply to this Contract. The apparent low Bidder will be required to submit EEO forms to the Division of Construction Procurement, which will then forward to the Finance and Administration Cabinet for review and approval. No award will become effective until all forms are submitted and EEO/CC has certified compliance. The required EEO forms are as follows:

- EEO-1: Employer Information Report
- Affidavit of Intent to Comply
- Employee Data Sheet
- Subcontractor Report

These forms are available on the Finance and Administration's web page under ***Vendor Information, Standard Attachments and General Terms*** at the following address:
<https://www.eProcurement.ky.gov>.

Bidders currently certified as being in compliance by the Finance and Administration Cabinet may submit a copy of their approval letter in lieu of the referenced EEO forms.

For questions or assistance please contact the Finance and Administration Cabinet by email at **finance.contractcompliance@ky.gov** or by phone at 502-564-2874.

EMPLOYEE RIGHTS UNDER THE FAIR LABOR STANDARDS ACT

THE UNITED STATES DEPARTMENT OF LABOR WAGE AND HOUR DIVISION

FEDERAL MINIMUM WAGE

\$7.25

 PER HOUR

BEGINNING JULY 24, 2009

OVERTIME PAY

At least 1½ times your regular rate of pay for all hours worked over 40 in a workweek.

CHILD LABOR

An employee must be at least **16** years old to work in most non-farm jobs and at least **18** to work in non-farm jobs declared hazardous by the Secretary of Labor.

Youths **14** and **15** years old may work outside school hours in various non-manufacturing, non-mining, non-hazardous jobs under the following conditions:

No more than

- **3** hours on a school day or **18** hours in a school week;
- **8** hours on a non-school day or **40** hours in a non-school week.

Also, work may not begin before **7 a.m.** or end after **7 p.m.**, except from June 1 through Labor Day, when evening hours are extended to **9 p.m.** Different rules apply in agricultural employment.

Contract ID: 172615
Page 28 of 32

TIP CREDIT

Employers of “tipped employees” must pay a cash wage of at least \$2.13 per hour if they claim a tip credit against their minimum wage obligation. If an employee's tips combined with the employer's cash wage of at least \$2.13 per hour do not equal the minimum hourly wage, the employer must make up the difference. Certain other conditions must also be met.

ENFORCEMENT

The Department of Labor may recover back wages either administratively or through court action, for the employees that have been underpaid in violation of the law. Violations may result in civil or criminal action.

Employers may be assessed civil money penalties of up to \$1,100 for each willful or repeated violation of the minimum wage or overtime pay provisions of the law and up to \$11,000 for each employee who is the subject of a violation of the Act's child labor provisions. In addition, a civil money penalty of up to \$50,000 may be assessed for each child labor violation that causes the death or serious injury of any minor employee, and such assessments may be doubled, up to \$100,000, when the violations are determined to be willful or repeated. The law also prohibits discriminating against or discharging workers who file a complaint or participate in any proceeding under the Act.

ADDITIONAL INFORMATION

- Certain occupations and establishments are exempt from the minimum wage and/or overtime pay provisions.
- Special provisions apply to workers in American Samoa and the Commonwealth of the Northern Mariana Islands.
- Some state laws provide greater employee protections; employers must comply with both.
- The law requires employers to display this poster where employees can readily see it.
- Employees under 20 years of age may be paid \$4.25 per hour during their first 90 consecutive calendar days of employment with an employer.
- Certain full-time students, student learners, apprentices, and workers with disabilities may be paid less than the minimum wage under special certificates issued by the Department of Labor.

For additional information:



1-866-4-USWAGE

(1-866-487-9243)

TTY: 1-877-889-5627



WWW.WAGEHOUR.DOL.GOV

U.S. Department of Labor | Wage and Hour Division

PART IV
INSURANCE

INSURANCE

The Contractor shall procure and maintain the following insurance in addition to the insurance required by law:

- 1) Commercial General Liability-Occurrence form – not less than \$2,000,000 General aggregate, \$2,000,000 Products & Completed Aggregate, \$1,000,000 Personal & Advertising, \$1,000,000 each occurrence.
- 2) Automobile Liability- \$1,000,000 per accident
- 3) Employers Liability:
 - a) \$100,000 Each Accident Bodily Injury
 - b) \$500,000 Policy limit Bodily Injury by Disease
 - c) \$100,000 Each Employee Bodily Injury by Disease
- 4) The insurance required above must be evidenced by a Certificate of Insurance and this Certificate of Insurance must contain one of the following statements:
 - a) "policy contains no deductible clauses."
 - b) "policy contains _____ (amount) deductible property damage clause but company will pay claim and collect the deductible from the insured."
- 5) **KENTUCKY WORKMEN'S COMPENSATION INSURANCE.** The contractor shall furnish evidence of coverage of all his employees or give evidence of self-insurance by submitting a copy of a certificate issued by the Workmen's Compensation Board.

The cost of insurance is incidental to all contract items. All subcontractors must meet the same minimum insurance requirements.

PART V
BID ITEMS

PROPOSAL BID ITEMS

172615

Page 1 of 1

Report Date 11/13/17

Section: 0001 - BRIDGE

| LINE | BID CODE | ALT | DESCRIPTION | QUANTITY | UNIT | UNIT PRIC | FP | AMOUNT |
|------|----------|-----|---|----------|------|-----------|----|--------|
| 0010 | 02562 | | TEMPORARY SIGNS | 149.00 | SQFT | | \$ | |
| 0020 | 02650 | | MAINTAIN & CONTROL TRAFFIC APPLIES TO 060B00056N | 1.00 | LS | | \$ | |
| 0030 | 02653 | | LANE CLOSURE | 1.00 | EACH | | \$ | |
| 0040 | 02654 | | TRUCK MOUNTED ATTENUATOR | 1.00 | EACH | | \$ | |
| 0050 | 04934 | | TEMP SIGNAL MULTI PHASE | 1.00 | EACH | | \$ | |
| 0060 | 06549 | | PAVE STRIPING-TEMP REM TAPE-B | 500.00 | LF | | \$ | |
| 0070 | 06550 | | PAVE STRIPING-TEMP REM TAPE-W | 1,000.00 | LF | | \$ | |
| 0080 | 06551 | | PAVE STRIPING-TEMP REM TAPE-Y | 2,000.00 | LF | | \$ | |
| 0090 | 21679EN | | FIBERGLASS DRAIN PIPE 6 INCH | 300.00 | LF | | \$ | |
| 0100 | 24093EC | | BEAM REPAIR | 1.00 | EACH | | \$ | |

Section: 0002 - DEMOBILIZATION

| LINE | BID CODE | ALT | DESCRIPTION | QUANTITY | UNIT | UNIT PRIC | FP | AMOUNT |
|------|----------|-----|----------------|----------|------|-----------|----|--------|
| 0110 | 02569 | | DEMOBILIZATION | 1.00 | LS | | \$ | |