



CALL NO. 315

CONTRACT ID. 202004

VARIOUS COUNTIES

FED/STATE PROJECT NUMBER FE01 121 DW20 0040000

DESCRIPTION VARIOUS ROUTES IN DISTRICT 4

WORK TYPE WATERBOURNE PAINT STRIPING

PRIMARY COMPLETION DATE 8/15/2020

LETTING DATE: February 21,2020

Sealed Bids will be received electronically through the Bid Express bidding service until 10:00 am EASTERN STANDARD TIME February 21,2020. Bids will be publicly announced at 10:00 am EASTERN STANDARD TIME.

NO PLANS ASSOCIATED WITH THIS PROJECT.

REQUIRED BID PROPOSAL GUARANTY: Not less than 5% of the total bid.

TABLE OF CONTENTS

PART I	SCOPE OF WORK
	<ul style="list-style-type: none">• PROJECT(S), COMPLETION DATE(S), & LIQUIDATED DAMAGES• CONTRACT NOTES• STATE CONTRACT NOTES• NATIONAL HIGHWAY• SPECIAL NOTE(S) APPLICABLE TO PROJECT• COORDINATION OF WORK WITH OTHER CONTRACTS• TRAFFIC CONTROL PLAN• CONTRACT COMPLETION DATE AND LIQUIDATED DAMAGES• SKETCH MAP(S)• SUMMARY SHEET(S)• DETAIL SHEET(S)
PART II	SPECIFICATIONS AND STANDARD DRAWINGS
	<ul style="list-style-type: none">• SPECIFICATIONS REFERENCE• SUPPLEMENTAL SPECIFICATION• 2016 STANDARD DRAWINGS THAT APPLY• CENTERLINE RUMBLE STRIPS• CENTERLINE RUMBLE STRIP 4 INCH STRIPING• CENTERLINE RUMBLE STRIP 6 INCH STRIPING• SHOULDER AND EDGE LINE RUMBLE STRIP DETAILS• EDGE LINE RUMBLE STRIP DETAILS TWO LANE ROADWAYS• SHOULDER RUMBLE STRIP DETAILS TWO LANE ROADWAYS• RUMBLE STRIP DETAILS MULTI-LANE ROADWAYS AND RAMPS
PART III	EMPLOYMENT, WAGE AND RECORD REQUIREMENTS
	<ul style="list-style-type: none">• LABOR AND WAGE REQUIREMENTS• EXECUTIVE BRANCH CODE OF ETHICS• KENTUCKY EQUAL EMPLOYMENT OPPORTUNITY ACT OF 1978 LOCALITY / STATE• PROJECT WAGE RATES / STATE FUNDED
PART IV	INSURANCE
PART V	BID ITEMS

PART I
SCOPE OF WORK

ADMINISTRATIVE DISTRICT - 04

CONTRACT ID - 202004

FE01 121 DW20 0040000

COUNTY - VARIOUS

PCN - MP12100002004

FE01 121 DW20 0040000

VARIOUS ROUTES IN DISTRICT 4 -WATERBOURNE PAINT STRIPING
GEOGRAPHIC COORDINATES LATITUDE 37:36:50.00 LONGITUDE 85:47:52.00

COMPLETION DATE(S):

COMPLETED BY 08/15/2020	SPECIFIED COMPLETION DATE - ALL ITEMS IN CONTRACT
COMPLETED BY 06/01/2020	SPECIFIED COMPLETION DATE - PRIORITY ROUTES
5 WORKING Days	REMOVE STRIPING ERRORS AND SPILLS
15 CALENDAR Hours	RESTRIPE SECTIONS WITH FAILED RETROREFLECTIVITY

CONTRACT NOTES

PROPOSAL ADDENDA

All addenda to this proposal must be applied when calculating bid and certified in the bid packet submitted to the Kentucky Department of Highways. Failure to use the correct and most recent addenda may result in the bid being rejected.

BID SUBMITTAL

Bidder must use the Department's electronic bidding software. The Bidder must download the bid file located on the Bid Express website (www.bidx.com) to prepare a bid packet for submission to the Department. The bidder must submit electronically using Bid Express.

JOINT VENTURE BIDDING

Joint venture bidding is permissible. All companies in the joint venture must be prequalified in one of the work types in the Qualifications for Bidders for the project. The bidders must get a vendor ID for the joint venture from the Division of Construction Procurement and register the joint venture as a bidder on the project. Also, the joint venture must obtain a digital ID from Bid Express to submit a bid. A joint bid bond of 5% may be submitted for both companies or each company may submit a separate bond of 5%.

UNDERGROUND FACILITY DAMAGE PROTECTION

The contractor shall make every effort to protect underground facilities from damage as prescribed in the Underground Facility Damage Protection Act of 1994, Kentucky Revised Statute KRS 367.4901 to 367.4917. It is the contractor's responsibility to determine and take steps necessary to be in compliance with federal and state damage prevention directives. When prescribed in said directives, the contractor shall submit Excavation Locate Requests to the Kentucky Contact Center (KY811) via web ticket entry. The submission of this request does not relieve the contractor from the responsibility of contacting non-member facility owners, whom shall be contacted through their individual Protection Notification Center. Non-compliance with these directives can result in the enforcement of penalties.

REGISTRATION WITH THE SECRETARY OF STATE BY A FOREIGN ENTITY

Pursuant to KRS 176.085(1)(b), an agency, department, office, or political subdivision of the Commonwealth of Kentucky shall not award a state contract to a person that is a foreign entity required by [KRS 14A.9-010](#) to obtain a certificate of authority to transact business in the Commonwealth ("certificate") from the Secretary of State under [KRS 14A.9-030](#) unless the person produces the certificate within fourteen (14) days of the bid or proposal opening. If the foreign entity is not required to obtain a certificate as provided in [KRS 14A.9-010](#), the foreign entity should identify the applicable exception. Foreign entity is defined within [KRS 14A.1-070](#).

For all foreign entities required to obtain a certificate of authority to transact business in the Commonwealth, if a copy of the certificate is not received by the contracting agency within the time frame identified above, the foreign entity's solicitation response shall be deemed non-responsive or the awarded contract shall be cancelled.

Businesses can register with the Secretary of State at <https://secure.kentucky.gov/sos/ftbr/welcome.aspx>.

SPECIAL NOTE FOR PROJECT QUESTIONS DURING ADVERTISEMENT

Questions about projects during the advertisement should be submitted in writing to the Division of Construction Procurement. This may be done by fax (502) 564-7299 or email to kytc.projectquestions@ky.gov. The Department will attempt to answer all submitted questions. The Department reserves the right not to answer if the question is not pertinent or does not aid in clarifying the project intent.

The deadline for posting answers will be 3:00 pm Eastern Daylight Time, the day preceding the Letting. Questions may be submitted until this deadline with the understanding that the later a question is submitted, the less likely an answer will be able to be provided.

The questions and answers will be posted for each Letting under the heading "Questions & Answers" on the Construction Procurement website (www.transportation.ky.gov/contract). The answers provided shall be considered part of this Special Note and, in case of a discrepancy, will govern over all other bidding documents.

HARDWOOD REMOVAL RESTRICTIONS

The US Department of Agriculture has imposed a quarantine in Kentucky and several surrounding states, to prevent the spread of an invasive insect, the emerald ash borer. Hardwood cut in conjunction with the project may not be removed from the state. Chipping or burning on site is the preferred method of disposal.

INSTRUCTIONS FOR EXCESS MATERIAL SITES AND BORROW SITES

Identification of excess material sites and borrow sites shall be the responsibility of the Contractor. The Contractor shall be responsible for compliance with all applicable state and federal laws and may wish to consult with the US Fish and Wildlife Service to seek protection under Section 10 of the Endangered Species Act for these activities.

ACCESS TO RECORDS

The contractor, as defined in KRS 45A.030 (9) agrees that the contracting agency, the Finance and Administration Cabinet, the Auditor of Public Accounts, and the Legislative Research Commission, or their duly authorized representatives, shall have access to any books, documents, papers, records, or other evidence, which are directly pertinent to this contract for the purpose of financial audit or program review. Records and other prequalification information confidentially

disclosed as part of the bid process shall not be deemed as directly pertinent to the contract and shall be exempt from disclosure as provided in KRS 61.878(1)(c). The contractor also recognizes that any books, documents, papers, records, or other evidence, received during a financial audit or program review shall be subject to the Kentucky Open Records Act, KRS 61.870 to 61.884.

In the event of a dispute between the contractor and the contracting agency, Attorney General, or the Auditor of Public Accounts over documents that are eligible for production and review, the Finance and Administration Cabinet shall review the dispute and issue a determination, in accordance with Secretary's Order 11-004.

April 30, 2018

SPECIAL NOTE FOR RECIPROCAL PREFERENCE

RECIPROCAL PREFERENCE TO BE GIVEN BY PUBLIC AGENCIES TO RESIDENT BIDDERS

By reference, KRS 45A.490 to 45A.494 are incorporated herein and in compliance regarding the bidders residency. Bidders who want to claim resident bidder status should complete the Affidavit for Claiming Resident Bidder Status along with their bid in the electronic bidding software. Submittal of the Affidavit should be done along the bid in Bid Express.

April 30, 2018

NATIONAL HIGHWAY

Be advised that some routes in this project are on the NATIONAL HIGHWAY SYSTEM.

**SPECIAL NOTES FOR WATERBORNE PAINT STRIPING
AND DURABLE WATERBORNE PAINT STRIPING
2020 DISTRICT WIDE CONTRACTS**

DESCRIPTION

Except as specified herein, perform all work according to the Commonwealth of Kentucky, Transportation Cabinet, Department of Highways' 2019 Standard Specifications for Road and Bridge Construction; Supplemental Specifications; applicable Standard and Sepia Drawings; applicable Special Notes and Special Provisions; and Kentucky Methods; current editions. Section references are to the Standard Specifications.

SCOPE OF WORK

Furnish and apply waterborne striping paint for 4 inch lines and durable waterborne striping paint for 6 inch lines, reflectorized with glass beads, to the sections of roadway provided in this Contract with an updated listing provided at the pre-construction meeting. This Contract is for the installation of centerlines, lane lines, edgelines, ramp lines, dotted lines and gore **lines** only. Gore **line** materials shall be the same as the mainline of the roadway. Special markings such as stop bars, crosswalks, cross-hatching, **chevrons**, railroad markings, etc. are not to be installed under this Contract.

Intersection approach markings such as the edgelines of large painted islands or edgelines on mountable medians may be included at the discretion of the Engineer provided they can be painted by the striping truck. Markings that would require application by equipment other than the striping truck are not to be installed under this Contract.

Retrace existing lines on the listed routes. The Department will pre-mark any section of roadway where there are no existing markings, old markings are no longer visible, or where the existing markings are to be changed. Do not place edge lines on any section of roadway where edgelines do not currently exist without written authorization from the Chief District Engineer. **Use only one paint crew per route per county.**

MATERIALS FOR WATERBORNE AND DURABLE WATERBORNE PAINT STRIPING

PAINT: Furnish paint materials for this project to meet the performance requirements detailed in Sections 842 and 846 of the Standard Specifications.

Submit initial samples for each paint formulation for approval prior to initiation of the striping operations. The Contractor's paint manufacturer may submit the initial sample directly to the Department. The Department will obtain subsequent samples of paint in accordance with the

Materials Field Sampling Manual when striping operations are in progress. A minimum of one sample will be obtained per color, per truck, per week and shall represent the quantity of striping applied per week. Deductions for application of non-specification paint shall be assessed to the quantity of striping represented by the sample.

BEADS: Use sufficient beads to ensure the pavement marking material meets retroreflectivity requirements. The Department will evaluate beads as part of the installed pavement marking in accordance with Kentucky Method 202 or 203 as applicable. Testing of the coatings, gradation and quality of the product applied shall be the responsibility of the Contractor.

MATERIALS SAMPLING AND ACCEPTANCE

If two or more random samples obtained during striping operations fail to meet minimum compositional requirements, striping operations shall be discontinued at the discretion of the Engineer. In the event striping operations are discontinued, the Department will randomly sample and test each batch of paint the Contractor has in stock at the storage location.

For batches of paint that fail to meet the minimum compositional criteria, the stock material will be rejected. The Contractor will be required to remove all failing paint from his central storage location. Batches that are tested and found to be in compliance with the compositional requirements may be used. After the Department has sampled all of the material at the central storage area, sampling and testing will resume according to the Materials Field Sampling Manual as soon as striping operations resume.

A deduction in payment will be made for any paint used that fails to meet material requirements according to Sections 842 and 846 as applicable.

EQUIPMENT

Each striper shall be equipped with electrical foot counters. The counters shall individually tabulate the amount of footage applied by each striping gun on the carriage, whether solid or dashed. The counters shall be capable of measuring up to six digits and shall have a reset feature. The counters shall be calibrated in the presence of a Department representative to insure an accurate measurement of the paint applied. Perform the calibration prior to starting striping operations and as necessary thereafter. When done, the Department's representative will record the calibrations on the Engineer's Daily Work Report (DWR).

Each striper shall be equipped with an accurate dashing mechanism, capable of being adjusted to retrace existing lane line, dotted lines, or centerline markings as directed by the Engineer. The striper shall also be equipped with a detection device that will automatically cutoff the paint guns when a raised or recessed pavement marker is detected in the pavement. The Contractor, at his own expense, shall replace or adequately clean any pavement marker lens that is painted.

Equip each striper with a Data Logging System (DLS) that will record operational details during striping operations, store data, and generate and export reports on a daily basis to the manufacturer's secure server. Provide only DLS equipment certified by the manufacturer. Ensure the data is in Microsoft Excel format, or a comma or spaces delimited text file adequate for insertion into a computerized spreadsheet. The DLS shall monitor and report the quantities of paint and beads consumed in line and calculate, in real time, the gallons of paint per mile, average wet film thickness, and pounds of beads per gallon of paint for each line application. The DLS shall monitor and report the ambient temperature, pavement temperature, and paint temperature, and record the data at the beginning of each line application and at a minimum of 1 mile increments during application. The DLS shall be capable of storing and supplying the necessary scaling and calibration parameters to the flow meters, and shall provide a means of adjusting the scaling factor as necessary. The DLS shall include a remote cab mounted display, which shall indicate in real time, pavement temperature, application rate of paint in gallons per mile, paint film thickness in mils, and application rate of beads in pounds per gallon. In addition the Contractor's striper shall also be equipped with a calibrated measuring device for monitoring quantities of paint and beads consumed in line.

Export to the secure server a DLS report as raw data, and as an Excel spreadsheet containing the following information: route; the beginning and ending mile points; the beginning and ending coordinates determined by a Global Positioning System receiver with a 16 foot accuracy, and the direction of travel; line type, indicated as CL (Yellow Center Line Double-Solid, Mono-directional passing, or Bi-directional passing); EL (White Edge Line on all roads or Yellow Edge Line on Solid Median Multi-Lane Highways and Interstates); LL (Solid Yellow or White Lane Line to define turn or merge lanes); SK (Dashed Yellow or White Line 10'stripe/30'gap); GM (Gore Marking installed at 2x the Edge Line Width); DTLE (Dashed Yellow or White Line Extension 3'stripe/9'gap); line width; line color; direction of application (this must be indicated for each direction travelled i.e. must include a separate entry for both the North and South directions, cannot be one entry that says direction was North/South); weight of paint applied in pounds or number of strokes counted, appropriate scaling factors; paint film thickness in mils; paint application rate in gallons per mile; bead application rate in pounds per gallon; paint temperature obtained immediately after the heat exchanger; ambient temperature; pavement temperature; and vehicle speed in miles per hour. Report application and temperature data in one-mile increments for each line applied. Provide GPS mapping system that is capable of real time (within 20 minutes) tracking of material application rates, film thickness, beads pounds per gallon, vehicle speed, time, date, project numbers, operator manual data, and color coded alarms for film thickness. Film thickness alarms must have a tolerance of ± 0.5 mils.

Provide access to stored data on a secure password protected website. The Department reserves the right to obtain any and all raw data recorded by the DLS at any time during this Contract. The Engineer may require field verification of the DLS operation and calibration at any time to ensure the accuracy of the DLS data and output. If field personnel suspect that the DLS data and/or output are not accurate, the Engineer may direct additional checks be performed. The secure server shall allow the Department to be able to create a Daily Striping Report which automatically fills from the DLS's data. It shall auto-populate all fields shown on the attached DSR except for Route Type, Mobile, and Corrective Re-stripe. These fields will be drop downs to be chosen by the user. The route length shall be calculated from the GPS data and not the manually entered milepoints. The DSR shall compute the total striped line length in "Totals

Summary” once the user picks the “Route Type.”

Prior to starting striping operations, make all strippers available at a central location within Kentucky designated by the Department for inspection by the Department for compliance to Kentucky Method 64-267 and DLS requirements. Striping trucks that can fulfill the requirements of this method and these notes will be approved for use on this Contract. Striping trucks that have not been approved for use by Department personnel will not be allowed to stripe as part of this Contract. The Department reserves the right to perform random field verifications of striping equipment during this Contract.

The Engineer may require the Contractor to provide detailed operating instructions from the manufacturer of the striping equipment and/or the DLS if quality or reporting issues arise at any time during the Contract. The Contractor shall then be required to operate the striping equipment within the suggested operating guidelines of the manufacturer, with particular emphasis on the speed of the striping operation, or make other adjustments until the quality of the striping is satisfactory to the Engineer.

The Contractor shall provide a separate sweeping unit powerful enough to remove normal highway dirt and debris. This unit shall not be a part of the striper.

Provide the KYTC inspector the same form of direct communication with the paint striping crew as that used by the paint striping crew (CB Radio, 2-Way Radio, etc.). The Department will return the item to the Contractor upon completion of the Contract.

SURFACE PREPARATION

Prepare the pavement surface for the striping operation in accordance with Section 713.03.02. Sweep all pavement surfaces prior to striping and maintain the cleaning operation far enough in advance of the striping operation to prevent any dust from the cleaning operation from mixing with the paint. The sweeper must maintain contact with the roadway. When the Engineer determines abnormal amounts of debris or other material have accumulated beyond the capability of the required sweeping unit which will require shoveling or other means to remove, the Engineer will make arrangements, prior to painting, to have the material removed by the Department or that section of roadway will be deleted from the Contract.

CONSTRUCTION

Except as specified herein, apply all striping according to Section 713.

QUALITY CONTROL (QC) and QUALITY ASSURANCE (QA)

The Contractor shall designate a Quality Control Coordinator (QCC) for the project who will be the contact person for any questions or concerns regarding the quality of the work performed

under this Contract. The QCC shall:

- Hold current qualification from the Department as a Pavement Marking Inspection Technician;
- Plan and oversee the Contractor's evaluation of the lines applied on the project;
- Complete and submit Daily Striping Reports to the Engineer within 24 hours of completion of that days striping;
- Ensure that the DLS manufacturer submits electronic DLS raw data and Excel spreadsheets from the secure server by e-mail, at the e-mail addresses provided at the preconstruction meeting, to designated field personnel no later than the first working day following application of the pavement markings.
- Verify the electronic records are completed and received by the Engineer prior to the records being removed from the pavement marking equipment.
- Coordinate and review or Perform KM-202, for each section of striping and provide completed test reports (electronic copy) along with printouts from the handheld retroreflectometer to the Engineer within one (1) working day of completion (failure to provide the printouts will cause the Department to not accept that section and require corrective work in order to be eligible for the final 50% payment).
- Document all adjustments made to the application process to consistently produce the quality of line desired;
- Notify the Engineer of any changes in the striping work plan that are determined necessary
- Inform and mobilize crews to complete restriping or corrective work (after notification by the Department);
- Supply the appropriate certifications for paint and the DLS to the Engineer assigned to the particular project at the time of sampling;
- Track the quantities of materials supplied by the Contractor's vendors and applied by the painting crew;
- Meet with the Engineer to discuss and/or conduct field reviews on the project throughout the execution of the Contract;
- Perform QC testing in accordance with KM-202 for each section of striping on zones selected by the Department based on KM-64-113 The Department will **NOT** provide advanced notice of the randomly selected zones to the Contractor prior to the striping being placed, but will only provide the locations for each randomly selected zone on the day of the test. The Department's QA inspector will coordinate the date of the test with the Contractor's QCC.

At the Pre-construction Conference, the Contractor shall furnish the Department for approval a Quality Control Plan (QCP) that covers in detail the following items:

- The name, address, phone and fax numbers for the QCC;
- The names of individuals other than the QCC taking readings in accordance with KM-202 (these people shall hold qualification from the Department as Pavement Marking Inspection Technicians);

- An overall work plan which states the estimated starting and completion dates for the entire project, the number of crews to be used on the project and a general description of how the project will be completed;
- A description of the striping equipment to be used on the project, including make and model of each striper, minimum and maximum operating speeds, and type of instruments to be used to calibrate the flow of paint and beads;
- The frequency and method to be used to monitor application rates and quality of the line (specifically with regard to retroreflectivity, width, thickness, bead distribution, tracing accuracy, etc.);
- A list of paint(s) and bead(s) to be used in this Contract along with a statement from the paint manufacturer that indicates the recommended minimum and maximum application temperatures for ambient temperature, pavement temperature, paint temperature, and guidelines for any other environmental factors that would adversely affect the successful performance of the paint;
- The contact person, phone, e-mail and fax numbers for reporting claims for paint on vehicles
- A description and product literature of the reflectometer to be used by the Contractor;
- A description, product literature, and manufacturer's certification of the DLS to be used by the Contractor;
- The manufacturer's sampling procedure for sampling paint from the tote.

Obtain the Engineer's acceptance of the Contractor's QCP prior to the start of work. The Department reserves the right to require the Contractor to make changes in the QCP to obtain the quality specified in the Contract.

After acceptance by the Department, the Contractor shall notify the Engineer in writing of any proposed change(s) to the QCP. Proposed changes are subject to acceptance by the Department.

The Department will perform Quality Assurance (QA) testing on (at least) one segment of each section of striping completed by the Contractor. QA testing is intended to verify the Contractor's QC test data. Upon receipt of the Contractor's QC test reports for each section, the QA Inspector will randomly select (at least) one segment for QA evaluation. The Department will **NOT** provide advance notice to the Contractor of the selected segment. The Department will perform the test in accordance with KM-202 with the exception that QA testing will be conducted within the later of 30-60 calendar days after the striping application or 2 weeks of receipt of the Contractor's QC report.

The Department will base payment for each section evaluated in accordance with KM-202 on the Contractor's QC test results if the QC and QA mean values for each segment selected for QA testing differ by less than 10% of the QA mean value.

If a dispute should arise regarding the acceptability of the Contractor's QC test results the dispute resolution shall be conducted as follows:

1. If the retroreflectivity values obtained during the QA testing within a segment indicate a change in pay quantities (i.e. QC readings are passing and QA readings are failing) and

the mean values differ by more than 10% of the QA mean value; additional testing will be required. Discard the original QC and QA test results for the section in question. The QA will randomly establish three new zones, in accordance with KM-113, in each segment within the section in question. The QC and QA will jointly evaluate each new zone within the section in accordance with KM-202 (with the exception of the evaluation period if greater than 60 days). The QC test results for each segment will be used for evaluation of the section if the QC and QA mean values for each segment differ by less than 10% of the QA mean value.

2. If the variance between QC and QA testing does not indicate a change in the pay quantities for the section (i.e. QC and QA readings are both passing) however, the QC mean values differ by more than 10% of the QA mean value, additional readings will not be required. Accept the QC test results for evaluation of the section. However, additional testing within the section in question should be conducted as soon as possible to determine the cause of the discrepancy. The Contractor and the Engineer shall document the resolution to the discrepancy.
3. If resolution to a dispute or variance of QC and QA test results cannot be achieved by the QC and QA, additional testing will be required. Discard the QC and QA test results for the section in question. Additional testing will be conducted by the QC, QA, and representatives of Central Office Division of Materials. Additional testing will be conducted within two weeks of receipt of a written request from the Engineer to the Division of Materials for each section in question. Three new zones, randomly selected in accordance with KM-113, will be established by the QA for each segment of the section in question. Each instrument to be used for testing will be calibrated in the presence of Central Office representatives prior to initiation of testing. The QC, QA and Central Office representatives will obtain readings for each new zone in accordance with KM-202 (with the exception of the evaluation period if greater than 60 days). The QC test results for each segment will be used for evaluation of the section if the QC mean values for each segment differ by less than 10% to the mean value obtained by Central Office. The QA test results for each segment will be used for evaluation of the section if the QC mean values differ by more than 10% to the mean value obtained by Central Office and the QA mean value differs by less than 10% to the Central Office mean value. If neither the QC nor QA mean values meet these requirements, the Central Office mean value for each segment will be used to evaluate the section in question. These results will be final and the basis of payment for the section in question.

The Contractor shall incur all costs associated with additional testing performed by Department personnel for dispute resolution that does not result in the use of QC test data as the basis of payment. These costs will include the cost to maintain and control traffic.

The Department reserves the right to take over the QC portion of testing. In the event that the Department exercises this option, the Contractor will incur the cost of testing performed by the Department.

The Department reserves the right to evaluate retroreflectivity on designated routes, in whole or in part, in accordance with KM-203. The Department will identify routes or portions of routes to be evaluated in accordance with KM-203. The evaluation of a section in accordance with KM-203 will be conducted at the Departments expense.

The Department will require the Department's approved vendor performing retroreflectivity evaluation in accordance with KM-203 to successfully demonstrate compliance to his/her quality control procedures prior to collection of data for this Contract. The Department will select an appropriate test site for demonstration purposes and conduct joint evaluations of both yellow and white longitudinal markings within the test site using approved 30M geometry handheld instruments. The demonstration will be deemed successful if the mean average obtained by the approved vendor differs by less than 10% to the mean average obtained by the Department for each marking evaluated within the test site.

The Department will base payment for each section evaluated in accordance with KM-203 solely on the test results obtained by the Department's approved vendor. Completed test results submitted by the Department's approved vendor will be considered final and are not subject to dispute.

The Department will furnish the Contractor with a blank electronic copy of the Contractors Daily Striping Report (DSR). The Contractor shall complete and furnish this standard DSR to the Engineer's office the next calendar day for each crew for each color and width of line applied. The information on the DSR shall reflect the milepoints and quantities for striping completed for that day and for that crew. The Contractor shall also include with the DSR the certification for the paint used on that day's striping according to Section 842.05 and 846.05, as applicable.

Export DLS reports each calendar day to the manufacturer's secure server. Ensure that the DLS manufacturer submits electronic DLS raw data and Excel spreadsheets from the secure server by e-mail, at the e-mail addresses provided at the preconstruction meeting, to the designated field personnel no later than the first working day following application of the pavement markings. Verify the electronic records are completed and received by the Engineer prior to the records being removed from the pavement marking equipment.

APPLICATION OF STRIPING

Roadways shall be marked with 4", 6", 8" and 12" lines as indicated in the summaries and/or as directed by the Engineer. The four-inch line shall be not less than four inches nor more than five inches in width. The six-inch line shall be not less than six inches nor more than seven inches in width. The centerline of all newly applied lines shall be within one inch of the centerline of the existing stripe. Mark all State Primary System Routes and other routes listed on the summaries for 6 inch striping using Durable Waterborne Paint meeting the requirements of Section 846, except as specified herein. Mark all other routes with four-inch lines using Waterborne Paint meeting the requirements of Section 842, except as specified herein. Apply gore **lines** at twice the width of the normal line width on that portion of roadway. All lines shall have distinct, clean edges with proper bead distribution across the entire width and length of the line.

Passing zones and lane lines shall be installed as a 10' segment of paint with a 30' gap. The length of the 10' segment shall not be less than 10' nor longer than 10 feet 6 inches. The stripe-gap cycle shall be not less than 39 feet 6 inches and no longer than 40 feet 6 inches.

Apply paint, in a single pass, in accordance with the application rates in Section 713.03.03. Contrary to Section 713.03.03, the Contractor may apply beads at any application rate that meets the retroreflectivity requirements of Section 713.03.05.

The Contractor shall be responsible for protecting the painted line from traffic until dry in order to eliminate tracking. Retroreflectivity readings will be taken on zones with substantial amounts of tracking and the readings will be used in the calculation of payment. **If the Engineer Directs or the Contractor elects to use additional traffic control devices beyond what is specified in the TRAFFIC CONTROL PLAN, or other methods to control tracking,** the additional cost shall be incidental to the bid item "Maintain and Control Traffic".

If the Engineer determines that the quality of the striping applied by the Contractor is unsatisfactory with regard to retroreflectivity, bead distribution, paint thickness, overspray, accuracy of retracing, line width, consistency, tracking, etc., the Engineer may stop the striping operation immediately until the Contractor can demonstrate that the problem has been corrected. If it is determined by the Engineer that the striping is not applied at the specified application rate, restriping will be required.

CLEANING OF APPLIED STRIPING

The Contractor has the option to clean accumulated debris from affected route prior to performing QC testing. Cleaning is defined as a single pass using the broom truck to remove accumulated debris from the affected striping. Notify the Engineer 48 hours prior to performing the cleaning operations.

MARKING REMOVAL

The Contractor shall be responsible for all necessary cleanup of any paint or other material that is spilled onto the pavement or elsewhere as a result of his operations and for correcting any striping error (including tracking and rain damage) that the Engineer determines removal to be required. Contrary to Section 713.03.04, remove all striping errors or paint spills by water blasting only (see attached note) at no additional cost to the Department. This removal process shall be performed in a manner that shall not be detrimental to the pavement. Upon notification of a striping error or paint spill by the Engineer, the Contractor shall be required to begin the process of correcting the striping error or paint spill within five (5) working days and shall work continuously to complete the corrective work prior to striping any other section of roadway included in this Contract.

Prior to retracing, the Engineer will notify the Contractor if existing striping errors need to be removed. Contrary to Section 713.03.04, remove all existing striping errors by water blasting only (see attached note). The Department will measure and pay for water blasting removal of existing stripes directed by the Engineer in linear feet.

PAINT ON VEHICLES

The Contractor shall be responsible for addressing disputes with the public regarding paint on vehicles that occur as a result of his operations. All complaints from the public shall be addressed in a timely manner and the Contractor must demonstrate a “good faith” attempt to resolve disputes to the satisfaction of the citizen. However, the Contractor shall have the right to dispute fault and refuse settlement in cases where the Contractor feels that paint on the vehicle was a result of negligence on the part of the citizen. Unresolved disputes involving paint on vehicles shall be handled through the legal system. The Department shall not be held responsible for paint on vehicles under any circumstances.

RETROREFLECTIVITY REOUIREMENTS

The minimum retroreflectivity requirements shall be in accordance with Section 713.03.05A of the Standard Specifications.

Restriping will be required for striping that fails to meet to meet the minimum retroreflectivity requirements. The provisions for restriping are described in the section of the Contract entitled MEASUREMENT AND PAYMENT. Complete the restriping within 15 calendar days after notification by the Engineer except that restriping will be suspended after **October 15, 2020** until the following spring at the discretion of the Engineer. All restriping not completed by **October 15, 2020** will be restriped at the Engineer’s discretion as a priority route in the spring of 2021 and completed by **June 1, 2021**. All aspects of this specification shall apply to lines that are repainted due to failure to meet the requirements of this specifications including the retroreflectivity requirements.

SCHEDULING

At the Pre-construction conference, the Engineer may provide the Contractor with a list of Priority Routes (not to exceed 10 percent of the total project estimate) which are to be striped prior to **June 1, 2020**. The painting of all scheduled routes shall be completed by **August 15, 2020**.

The Contractor shall coordinate the daily striping schedule, one week in advance, with the Engineer. Unless approved by the Engineer, complete all striping in a county, for that type of paint, before starting striping for that type of paint in another county (for this Contract there are 4 types of paint striping: 4” yellow, 4” white” 6” yellow, and 6” white). The Contractor shall ensure that once striping begins on a section that ALL striping on that section must be completed

within one week. Failure to comply with this requirement will result in withholding of pay estimates.

The Engineer may eliminate any route from the schedule at any time prior to striping if it is determined that the route does not require retracing. Also, the Engineer may add additional routes to be striped. The Contractor shall be notified of added routes prior to July 1, 2020.

CONTRACT COMPLETION AND LIQUIDATED DAMAGES

All priority routes shall be striped by **June 1, 2020**. Contrary to the Standard Specifications, no time extension will be granted for failure to complete striping of these priority routes by the **June 1, 2020** milestone completion date. Liquidated damages in the amount specified in Section 108.09 of the Standard Specifications will be assessed for each day that any priority route remains unstriped after **June 1, 2020**.

Sections that are required to be re-striped due to failure to meet retroreflectivity requirements must be completed within 15 calendar days after notification by the Engineer. The Department will assess Liquidated Damages in the amount specified in Section 108.09 of the Standard Specifications for each day beyond the 15 calendar days that the restriping is not completed and shall accrue until **October 15, 2020**. Failure to complete all necessary corrective work by the **October 15, 2020** deadline will result in no additional payment for the stripe beyond the 50% that was initially paid for the installation of the stripe and payment will be based upon the Payment Schedule. At the Engineer's discretion, necessary corrective work not completed by the **October 15, 2020** deadline may be required to be restriped in the spring of 2021 as a priority route with a completion date of **June 1, 2021**. Any re-stripe required by the Engineer that is not completed by **June 1, 2021** shall accrue liquidated damages until **October 15, 2021**.

All routes that are required to be striped under this Contract shall be completed by **August 15, 2020**. Contrary to the Standard Specifications, no time extension will be granted. Liquidated damages will apply in accordance with Section 108.09 of the Standard Specifications for failure to complete the striping by August 15, 2020. Liquidated damages will accrue until October 15, 2020; no striping shall be performed after this date.

Remove all striping errors and spills within five (5) working days after notification by the Engineer. Liquidated damages, in the amount specified in Section 108.09 of the Standard Specifications, shall apply for each day beyond the five (5) working days that the Contractor has not begun to correct the striping error/spill or continuously work to complete the corrective work.

The Department will apply all Liquidated Damages accumulatively.

RE-TESTING OF FAILURES

The Department’s costs associated with re-testing of striping failures for Kentucky Method 203 shall be reimbursed to the Department by the Contractor. The reimbursement shall include mobilization of the Department’s mobile striping vendor’s mobile testing machine as well as the current per mile rate for the mobile striping according to the Cabinet’s Master Agreement.

MEASUREMENT AND PAYMENT

STRIPING: The Department will measure the paint striping of each type in linear miles of paint stripe. The Department will measure the quantity at twice the rate for a 4-inch line when an 8-inch line is applied or twice the rate for a 6-inch line when a 12-inch line is applied.

The Department will pay 50% of the Contract Unit Bid price for the applicable bid items after application of all striping to a particular section of roadway. Contrary to Section 104.02.02, the overrun and underrun formula shall not apply to this Contract. The remaining payment will be made based upon the following procedure and the Payment Schedule:

1. Each section of striping will be evaluated in accordance with KM-202 or KM-203, as applicable, and the QC/QA testing specified herein, for the purpose of evaluating retroreflectivity.
2. If a Section is accepted in accordance with the appropriate Kentucky Methods, the Department will make final payment according to the Payment Schedule listed below.
3. If a section is not accepted in accordance with the appropriate Kentucky Methods, restripe the entire section within fifteen (15) calendar days after notification by the Engineer subject to the same requirements as the original striping at no additional cost to the Department. If the restriped Section is accepted in accordance with the appropriate Kentucky Methods, the Department will make final payment according to the following Payment Schedule. If the section is not restriped by October 15, 2020, the Department will not make final payment and restriping may be required in the spring of 2021 where the corrective will become a priority route and re-striping must be completed by June 1, 2021. If the Engineer does not require re-striping to be completed in the spring of 2021, the Contractor shall accept the deduction in payment for the section that has been determined to be unacceptable.

Payment Schedule

	Initial Payment	Final Payment	Total Payment
Section is Accepted	50%	50%	100%
Section is Not Accepted	50%	0%	50%

QUALITY CONTROL: The Department will measure and pay the quantity as one lump sum. The Department will not measure the QCP, the DLS, any actions and personnel required to carry out the QCP, any testing, any testing equipment, or any other work necessary to perform the specified QC/QA procedures for payment, but will consider them incidental to this item of work.

MAINTAIN AND CONTROL TRAFFIC: See Traffic Control Plan.

LAW ENFORCEMENT OFFICER: See Traffic Control Plan.

WATER BLASTING EXISTING STRIPE: See Special Note for Water Blasting Existing Stripe.

SPECIAL NOTE FOR CENTERLINE & EDGELINE RUMBLE STRIPES

Be advised there may be some centerline and edgeline rumble stripes to be retraced. Place centerline rumble stripes according to Standard Drawings TPM-155-02 and TPM-160-02. Place edgeline rumble stripes according to the detail drawings for centerline and edgeline rumble strips. Notify the Engineer if questions arise regarding the striping patterns. If necessary, the Engineer will obtain guidance from the District Traffic Engineer and/or the Division of Traffic.

SPECIAL NOTE FOR WATER BLASTING EXISTING STRIPE

This Special Note will apply where indicated on the plans or in the proposal. Section references herein are to the Department's 2019 Standard Specifications for Road and Bridge Construction.

1.0 DESCRIPTION. Remove pavement striping, temporary or permanent, from asphalt or concrete pavement using ultra-high pressure water.

2.0 MATERIALS AND EQUIPMENT.

2.1 Truck Mounted Ultra-high Pressure Pump and Water Tank. Use a truck having a separate hydrostatic transmission capable of speed increments of ± 1 foot per minute at operator's discretion. Use a pump capable of delivering a minimum of 30,000 psi to a bumper mounted deck containing an operator controlled rotating manifold that is speed variable up to at least 3,000 rpm and accepts interchangeable waterjet nozzles. Provide all necessary waterjet nozzle setups and patterns to ensure clean sufficient removal. Ensure the deck's discharge directs the water and removal material in a manner that is not hazardous to vehicles or pedestrians.

2.2 Water. Conform to Section 803.

3.0 CONSTRUCTION. Before starting work, provide the Engineer with a contractor work history of 2 projects where striping removal was completed acceptably for a similar type of pavement. If no history is available, complete 1,000 linear feet of striping removal and obtain the Engineer's approval before continuing.

Conduct striping removal under lane closures meeting the conditions of the MUTCD and Kentucky Standard Drawings and Specifications. Waterblast to remove temporary or permanent striping completely as the Engineer directs. Do not damage the pavement in any way and protect all joint seals. If damage is observed, stop the removal process until the operator can make changes and demonstrate acceptable striping removal. Repair any damage to the pavement. Vacuum all marking material and removal debris concurrently with the blasting operation.

4.0 MEASUREMENT. The Department will measure the quantity in linear feet. When the removal area's width exceeds 8 inches and a second pass is required, the Department will measure the length of the additional pass for Payment. The Department will not measure for payment additional passes for widths of 8 inches or less or passes to further eradicate markings. The Department will not measure repair of damaged pavement for payment and will consider it incidental to this item of work.

5.0 PAYMENT. The Department will make payment for the completed and accepted quantities under the following:

<u>Code</u>	<u>Pay Item</u>	<u>Pay Unit</u>
22664EN	Water Blasting Existing Stripe	Linear Foot

The Department will consider payment as full compensation for all work required under this note.

October 30, 2012

SPECIAL NOTE FOR PROJECTS TO BE RESURFACED IN 2020

Be advised that some projects listed herein may be scheduled for resurfacing in 2020. The Engineer may delete the striping on these routes from this Contract.

EXPERIMENTAL STRIPING LOCATIONS

Be advised that experimental striping materials may be in place at the following locations. Verify with the Engineer if experiment has been concluded and obtain the Engineer's approval before retracing these route segments. Be responsible to replace the markings in like kind material and design at no additional cost to the Department if the lines are restriped without the Engineer's prior approval.

DISTRICT	COUNTY	ROUTE	BMP	EMP	NOTES
3	Warren	KY 234	12.000	13.500	
4	Nelson	US 31E	25.800	27.100	
5	Franklin	KY 420	0.000	2.150	
6	Kenton	KY 1501	0.000	2.519	
6	Grant	I 75	162.600	164.400	EDGE LINES ONLY

COORDINATION OF WORK WITH OTHERS

Be advised, the Department may issue permits for work on the Department's right of way adjacent to or within the limits of this project. See Sections 107.06 and 107.14. The Engineer will coordinate the work of the Contractor and the permit holders.

Be advised, there may be an active project(s) adjacent to or within this project. The Engineer will coordinate the work of the Contractors. See Section 105.06.

Be advised the Department may be performing work adjacent to or within this project. The Engineer will coordinate the Department's operations with the Contractor's work. See Section 105.11.

The Department will not grant any time extension or monetary consideration, and will not consider any claims if the Contractor's forces are delayed in their operations.

TRAFFIC CONTROL PLAN DURABLE WATERBORNE AND WATERBORNE PAINT STRIPING

1. Maintain and Control Traffic in accordance with the Standard Specifications for Road and Bridge Construction, Supplemental Specification, Standard and Sepia Drawings, and the MUTCD, current editions.
2. Contrary to Section 112, include all items necessary to maintain and control traffic in the lump sum bid item “Maintain and Control Traffic”. The Department will measure and pay only the bid items listed; consider all other work and necessary items to be incidental to the listed bid items. The Department will measure and pay “Maintain and Control Traffic” as one lump sum.
3. Maintain possession of all temporary traffic control items, devices, materials, and incidentals, unless otherwise specified in the proposal, when no longer needed.
4. If the Contractor desires to deviate from the traffic control scheme outlined in the Standard Drawings, prepare an alternate plan and present it in writing to the Engineer. Do not use the alternate plan until reviewed and approved by the District Engineer and the Divisions of Construction, Maintenance, and Traffic Operations.
5. Provide for the Contractor’s vehicles to always move with and not across or against the flow of traffic. Do not allow vehicles to make U-turns at any location. Do not allow the striper to stop and back down the road or ramps to stripe gore lines and turn lanes. Require vehicles to enter or leave work areas in a manner that will not be hazardous to, or interfere with, normal traffic flow. **If approved in advance by the Engineer, the contractor may use rolling road blocks to stripe intersections, not to exceed five (5) minutes duration, allowing the paint truck and broom to back up and paint the entire intersection.** Do not allow vehicles to park or stop within the right-of-way except within work areas designated by the Engineer. Do not allow personal vehicles to park within the right-of-way except in specific areas designated by the Engineer.
6. Do not allow the paint supply truck to operate as one of the traffic control vehicles shown on the Standard Drawings. If one of the required traffic control vehicles experiences mechanical problems or for some other reason is not available to remain in position as shown in the traffic control scheme, cease the striping operation until all required vehicles are in place.
7. Do not perform striping operations on any roadway during the peak times of the day, holiday periods, or special events as determined by the Engineer.
8. On two-lane, two-way highways, make provisions to the satisfaction of the Engineer to periodically allow traffic to safely pass the train of vehicles in the striping operation. **When painting center lines release traffic at least every two (2) miles.**

Traffic Control Plan
Durable Waterborne & Waterborne Paint Striping
Page 2 of 2

9. In low speed, urban situations, the Engineer may permit the Contractor to delete the intermediate trail vehicle between the striper and the final trail vehicle shown on the Standard Drawings.

10. If requested by the Contractor, the Engineer may approve Law Enforcement Officer Police Support on Interstate highways when striping operations are taking place. If the Contractor requests Law Enforcement Officer Police Support on other than Interstate Highways, provide written justification for the Engineer's approval. If approved, provide two (2) police support units for each lane closure, each unit consisting of an off-duty law enforcement officer from any police agency having lawful jurisdiction and a police car equipped with externally mounted flashing blue lights. Place the police support unit at locations determined by the Engineer. The Department will measure and pay for each approved individual police support unit on a per hour basis for the officer with the police vehicle.

CONTRACT COMPLETION DATE AND LIQUIDATED DAMAGES

All Priority Routes shall be striped by June 1, 2020. Contrary to the Standard Specifications, no time extension will be granted for failure to complete striping of these priority routes by the June 1, 2020 milestone completion date. Liquidated damages in the amount specified in **Section 108.09 of the Standard Specifications** will be assessed for each day that any Priority Route remains unstriped after June 1, 2020.

Sections that are required to be re-striped due to failure to meet retroreflectivity requirements must be completed within 15 calendar days after notification by the Engineer. The Department will assess Liquidated Damages in the amount specified in Section 108.09 of the Standard Specifications for each day beyond the 15 calendar days that the restriping is not completed and shall accrue until October 15, 2020. All re-striping must be complete by October 15, 2020. Failure to complete all necessary corrective work by the October 15, 2020 deadline will result in no additional payment for the stripe beyond the 50% that was initially paid for the installation of the stripe and payment will be based upon the Payment Schedule.

All routes that are required to be striped under this contract shall be completed by August 15, 2020. Contrary to the Standard Specifications, no time extension will be granted. Liquidated damages will apply in accordance with **Section 108.09 of the Standard Specifications** for failure to complete the striping by August 15, 2020. Liquidated damages will accrue until October 15, 2020; no striping shall be performed after this date.

Remove all striping errors and spills within five (5) working days after notification by the Engineer. Liquidated damages, in the amount specified in **Section 108.09 of the Standard Specifications**, shall apply for each day beyond the five (5) working days that the Contractor has not begun to correct the striping error/spill or continuously work to complete the corrective work.

The Department will apply all Liquidated Damages accumulatively.

DISTRICT 4

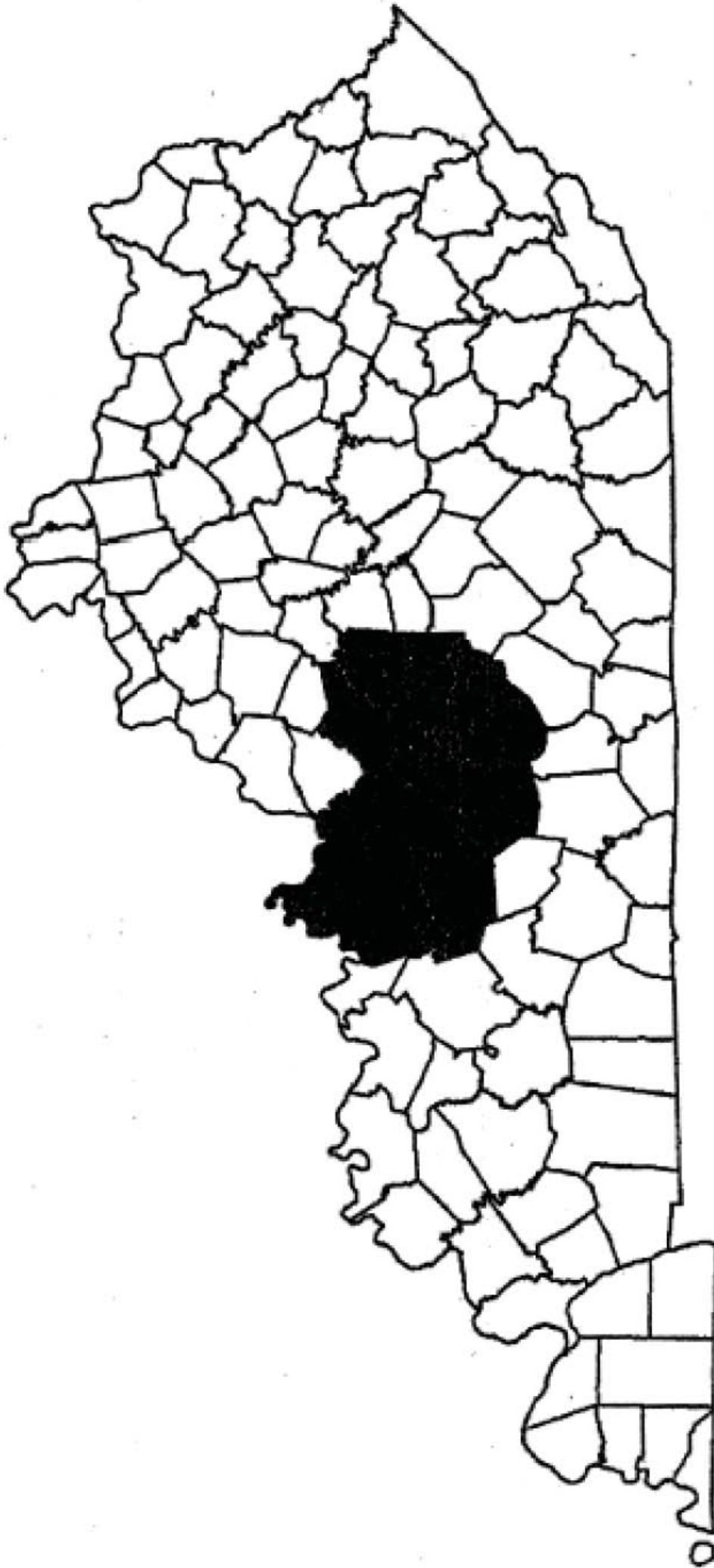

**2020 DURABLE WATERBORNE PAINT STRIPING - DISTRICT 4
STATE PRIMARY SYSTEM - 6 INCH LINES**

COUNTY	ROUTE	MILEPOINTS		ROADWAY MILES	6" LINE		EDGE LINES	COMMENTS
		BEGIN	END		YELLOW	WHITE		
Breckinridge Co.	KY 79	5.294	14.990	9.696	15.029	19.198	Yes	
Grayson Co.	US 62	20.787	21.296	0.509	0.920	0.814	Yes	Omit Thermo in Courthouse Square
Grayson Co.	KY 259	0.000	12.954	12.954	25.299	25.908	Yes	
Grayson Co.	KY 259	12.954	21.459	8.505	16.610	17.010	Yes	
Grayson Co.	KY 3155	0.000	4.697	4.697	10.000	11.902	Yes	
Green Co.	US 68	11.968	14.301	2.333	4.444	4.981	Yes	
Hardin Co.	US 31 W	18.818	20.440	1.622	2.949	3.244	Yes	
Hardin Co.	US 62	14.580	17.429	2.849	6.268	5.698	Yes	
Hardin Co.	US 62	19.551	20.115	0.564	1.241	1.128	Yes	
Hardin Co.	KY 220	12.307	13.337	1.030	1.753	2.140	Yes	
Hardin Co.	KY 3005	8.818	10.582	1.764	4.234	2.431	Yes	
Larue Co.	US 31 E	6.926	10.140	3.214	6.431	5.470	Yes	
Larue Co.	KY 61	0.000	8.031	8.031	13.700	20.134	No	
Marion Co.	US 68	0.000	9.364	9.364	16.387	19.646	Yes	
Marion Co.	US 68	12.322	13.159	0.837	1.791	1.129	Yes	
Marion Co.	US 68	13.159	23.803	10.644	15.221	22.342	Yes	
Marion Co.	KY 2154	0.000	1.351	1.351	2.000	0.000	No	
Meade Co.	KY 313	0.000	18.607	18.607	26.050	39.075	yes	
Nelson Co.	US 31 E	0.000	27.167	27.167	40.098	51.807	Yes	
Nelson Co.	US 62	12.274	14.633	2.359	3.774	4.744	Yes	
Nelson Co.	KY 245	0.000	5.150	5.150	12.499	11.799	Yes	
Taylor Co.	US 68	4.870	7.404	2.534	6.370	1.700	Yes	
Taylor Co.	KY 210	15.363	16.626	1.263	2.500	1.642	Yes	
Washington Co.	US 150	6.250	9.299	3.049	5.442	6.180	Yes	

SP GRAND TOTAL 6" LINES 140.093 241.011 280.122

- NOTES: 1. 6 INCH LINES - SECTION 846**
2. ESTIMATED QUANTITIES ONLY. RE-TRACE AS DIRECTED BY THE ENGINEER.
THE DEPARTMENT WILL MEASURE AND PAY ONLY ACTUAL
QUANTITIES RE-TRACED.

**2020 WATERBORNE PAINT STRIPING - DISTRICT 4
STATE SECONDARY & SUPPLEMENTAL SYSTEMS - 4 INCH LINES**

COUNTY	ROUTE	MILEPOINTS		ROADWAY MILES	4" LINES		EDGE LINES	COMMENTS
		BEGIN	END		YELLOW	WHITE		
Breckinridge	KY 79	0.000	5.294	5.294	7.406		No	
Breckinridge	KY 79	14.990	16.920	1.930	2.992	3.821	Yes	
Breckinridge	KY 105	0.000	5.606	5.606	7.288		No	
Breckinridge	KY 105	17.458	18.345	0.887	1.725		No	
Breckinridge	KY 823	0.000	0.837	0.837		1.674	yes	
Breckinridge	KY 886	0.000	0.528	0.528		1.056	yes	
Breckinridge	KY 992	13.822	14.851	1.029	1.544	0.050	No	
Breckinridge	KY 2201	0.000	1.893	1.893		3.786	yes	
Grayson	US 62	18.950	20.787	1.837	3.319	2.939	Yes	
Grayson	US 62	21.296	25.463	4.167	7.530	6.667	Yes	
Grayson	KY 79	0.000	19.885	19.885	30.802	0.400	19.686 - 19.885	
Grayson	KY 920	0.000	1.397	1.397	2.900	0.500	No	
Grayson	KY 1655	0.000	2.312	2.312		4.530	yes	
Green	US 68	0.000	11.968	11.968	22.799	25.552	Yes	
Green	KY 3535	0.000	0.770	0.770	1.320	1.600	Yes	
Hardin	US 31 W	3.517	18.818	15.301	27.817	30.602	Yes	
Hardin	US 62	12.480	14.580	2.100	4.620	4.200	Yes	
Hardin	US 62	17.429	19.551	2.122	4.668	4.244	yes	
Hardin	KY 220	13.377	17.191	3.814	6.491	6.212	15.322-15.744 16.884-17.191	
Hardin	KY 251	0.000	2.720	2.720	6.251	2.059	Skip & Turn Lanes	
Hardin	KY 251	2.722	7.981	5.259	7.889	7.096	2.772-6.32	
Hardin	KY 434	0.000	11.300	11.300	17.515	22.600	Yes	
Hardin	KY 1357	14.614	16.981	2.367	4.045	4.512	yes	
Hardin	KY 1407	0.000	2.047	2.047		4.094	Yes	
Hardin	KY 1815	0.000	2.439	2.439	8.000	7.000	Yes	
Hardin	KY 1823	0.000	2.621	2.621		5.242	Yes	
Hardin	KY 1921	0.000	4.150	4.150		8.300	Yes	
Hart	US 31 E	0.000	20.651	20.651	27.363	41.157	Yes	
Hart	KY 88	17.820	30.472	12.652	23.280		No	
Hart	KY 728	0.000	3.470	3.470		6.940	Yes	
Hart	KY 728	3.470	4.044	0.574	1.030		No	
Hart	KY 1656	0.000	4.167	4.167		8.334	Yes	
Hart	KY 2754	0.000	1.715	1.715		3.430	Yes	
Hart	KY 2756	0.000	1.567	1.567		3.134	Yes	
Larue	KY 224	0.000	0.692	0.692	1.183	1.384		
Larue	KY 357	0.000	7.720	7.720	11.302			
Larue	KY 2216	0.000	0.727	0.727		1.454	Yes	
Larue	KY 2767	0.000	1.613	1.613		3.226	Yes	

**2020 WATERBORNE PAINT STRIPING - DISTRICT 4
STATE SECONDARY & SUPPLEMENTAL SYSTEMS - 4 INCH LINES**

COUNTY	ROUTE	MILEPOINTS		ROADWAY MILES	4" LINES		EDGE LINES	COMMENTS
		BEGIN	END		YELLOW	WHITE		
Marion	US 68	9.364	12.322	2.958	6.330	3.990	9.364-9.858 11.882-12.322	
Marion	KY 49	0.000	27.442	27.442	50.384	54.884	Yes	
Marion	KY 49	33.688	34.292	0.604	1.109		No	
Marion	KY 289	0.000	5.617	5.617	10.410	11.400	Yes	
Marion	KY 2154	4.601	6.576	1.975	3.358	4.108	Yes	
Meade	KY 656	0.000	1.463	1.463		2.926	Yes	
Meade	KY 823	0.000	3.783	3.783		7.566	Yes	
Meade	KY 886	0.000	2.189	2.189		4.737	Yes	
Meade	KY 1726	0.000	1.670	1.670		3.328	Yes	
Meade	KY 1736	0.000	2.061	2.061		4.095	Yes	
Meade	KY 1919	0.000	4.091	4.091		8.182	Yes	
Meade	KY 2204	0.000	0.285	0.285	0.600		No	
Meade	KY 3139	0.000	0.202	0.202		0.404	Yes	
Meade	KY 3886	0.000	0.148	0.148		0.296	Yes	
Nelson	US 62	12.133	12.274	0.141	0.226	0.284	Yes	
Nelson	US 62	14.633	17.410	2.777	4.443	5.585	Yes	
Nelson	KY 49	0.000	9.442	9.442	17.940		No	
Nelson	KY 52	0.000	16.236	16.236	25.978		No	
Nelson	KY 2230	0.000	0.436	0.436		0.872	Yes	
Nelson	KY 2775	0.000	0.269	0.269		0.538	Yes	
Taylor	KY 70	0.000	13.963	13.963	22.341	27.926	Yes	
Taylor	KY 658	0.000	0.665	0.665	1.330	0.832	yes	
Taylor	KY 1252	0.000	2.447	2.447		4.894	Yes	
Taylor	KY 1511	0.000	3.060	3.060		6.120	Yes	
Taylor	KY 1834	0.000	1.860	1.860		3.720	Yes	
Washington	US 150 X	0.000	4.545	4.545	7.727	8.181	Yes	
Washington	KY 1584	0.000	1.298	1.298	2.500	0.015	No	Turn Lane
MP GRAND TOTAL				283.755	395.752	392.678		

- NOTES: 1. 4 INCH LINES - SECTION 842**
2. ESTIMATED QUANTITIES ONLY. RE-TRACE AS DIRECTED BY THE ENGINEER. THE DEPARTMENT WILL MEASURE AND PAY ONLY ACTUAL QUANTITIES RE-TRACED.

**2020 WATERBORNE PAINT STRIPING - DISTRICT 4
RURAL SECONDARY SYSTEM - 4 INCH LINES**

COUNTY	ROUTE	MILEPOINTS		ROADWAY MILES	4" LINES		EDGE LINES	COMMENTS
		BEGIN	END		YELLOW	WHITE		
Breckinridge	KY 105	5.606	17.458	11.852	23.052		no	
Breckinridge	KY 261	14.579	16.921	2.342		4.684	Yes	Add Edge Lines
Breckinridge	KY 629	0.000	15.972	15.972		31.944	yes	
Breckinridge	KY 690	0.000	18.941	18.941	35.098		no	
Breckinridge	KY 992	0.000	9.890	9.890		19.780	yes	
Breckinridge	KY 992	9.890	13.822	3.932	5.898		no	
Breckinridge	KY 1401	0.000	3.269	3.269	5.400		no	
Breckinridge	KY 1401	3.269	10.055	6.786		13.572	yes	
Breckinridge	KY 1740	0.000	5.000	5.000		10.000	yes	
Breckinridge	KY 1740	5.000	7.189	2.189	4.816	4.378	yes	
Breckinridge	KY 2779	0.000	2.259	2.259	3.700		no	
Breckinridge	KY 2779	2.259	6.460	4.201		8.402	yes	
Breckinridge	KY 2780	0.000	3.157	3.157		6.314	yes	
TOTAL				89.790	77.964	99.074		

Grayson	KY 736	0.000	19.713	19.713		39.603	yes	
Grayson	KY 878	0.000	4.624	4.624		9.280	yes	
Grayson	KY 920	1.400	7.866	6.466	11.600			
Grayson	KY 1133	0.000	2.517	2.517		5.034	yes	
Grayson	KY 1133	2.517	9.077	6.560	11.998		yes	
Grayson	KY 1214	0.000	14.860	14.860	26.897			
Grayson	KY 1356	0.000	2.880	2.880		5.760	yes	
Grayson	KY 2766	0.000	6.323	6.323	12.001			
Grayson	KY 2777	0.000	1.100	1.100	2.200			
Grayson	KY 2778	0.000	4.134	4.134		8.268	yes	
TOTAL				69.177	64.696	67.946		

Green	KY 424	0.000	4.214	4.214		8.281	yes	
Green	KY 487	0.000	9.995	9.995		19.600	yes	
Green	KY 569	0.000	0.540	0.540		1.080	yes	
Green	KY 729	0.000	5.245	5.245		10.301	yes	
Green	KY 767	0.000	1.421	1.421		2.760	yes	
Green	KY 793	4.585	9.136	4.551		9.102	yes	
Green	KY 1048	0.000	3.248	3.248		6.301	yes	
Green	KY 1079	0.000	0.919	0.919		1.838	yes	
Green	KY 2762	0.000	3.847	3.847		7.694	yes	
Green	KY 2763	0.000	2.766	2.766	4.990			
Green	KY 2764	0.000	1.775	1.775		3.550	yes	
Green	KY 2765	0.000	4.527	4.527		9.054	yes	
Green	KY 3098	0.000	2.560	2.560	4.101			
TOTAL				45.608	9.091	79.561		

Hardin	KY 210	0.000	4.256	4.256	5.899	8.512	yes	
Hardin	KY 222	6.930	9.956	3.026		6.052	yes	
Hardin	KY 920	0.000	20.469	20.469	37.356			
Hardin	KY 1357	0.000	3.375	3.375		6.750	yes	
Hardin	KY 1357	3.375	14.614	11.239	14.611			
Hardin	KY 1391	0.000	0.778	0.778		1.556		
Hardin	KY 1882	0.000	1.678	1.678	3.104			
Hardin	KY 1904	0.000	4.702	4.702	7.001	1.000	yes	
Hardin	KY 2212	0.000	3.888	3.888	8.165			
Hardin	KY 2213	0.000	4.932	4.932		9.864	yes	
Hardin	KY 2802	0.000	2.148	2.148	3.952			
Hardin	KY 2802	2.148	2.670	0.522	1.236	1.044	yes	
TOTAL				61.013	81.324	34.778		

**2020 WATERBORNE PAINT STRIPING - DISTRICT 4
RURAL SECONDARY SYSTEM - 4 INCH LINES**

COUNTY	ROUTE	MILEPOINTS		ROADWAY MILES	4" LINES		EDGE LINES	COMMENTS
		BEGIN	END		YELLOW	WHITE		
Hart	KY 218	0.000	5.239	5.239	9.430			
Hart	KY 570	0.000	5.485	5.485		10.784	yes	
Hart	KY 571	0.000	8.099	8.099	14.700			
Hart	KY 1079	0.000	5.380	5.380	10.760			
Hart	KY 1140	0.000	13.760	13.760	26.997			
Hart	KY 1214	0.000	2.606	2.606		5.212	yes	
Hart	KY 1827	0.000	3.639	3.639	7.096			
Hart	KY 1846	0.000	3.802	3.802	6.463			
Hart	KY 2185	0.000	5.016	5.016		10.032	yes	
Hart	KY 2195	0.000	0.520	0.520	1.300			
TOTAL				53.546	76.746	26.028		

Larue	KY 84	9.033	12.689	3.656	5.681			
Larue	KY 210	0.000	6.994	6.994	10.071	14.401		
Larue	KY 224	0.690	5.864	5.174	9.831			
Larue	KY 1079	0.000	4.156	4.156	7.581			
Larue	KY 1192	0.000	8.004	8.004		15.984	yes	
Larue	KY 1517	5.040	8.216	3.176		6.352	yes	
Larue	KY 1549	0.000	0.217	0.217	0.440			
Larue	KY 1607	4.190	4.836	0.646	1.292			
Larue	KY 1832	0.000	2.650	2.650	4.733		yes	
Larue	KY 1832	2.650	7.110	4.460		8.878	yes	
Larue	KY 2216	0.000	0.727	0.727		1.454	yes	
Larue	KY 2426	0.000	0.296	0.296	0.592	0.592	yes	
Larue	KY 2760	0.000	0.743	0.743		1.486	yes	
Larue	KY 2761	0.000	3.922	3.922		7.844	yes	
Larue	KY 2762	0.000	3.425	3.425		6.834	yes	
TOTAL				48.246	40.221	63.825		

Marion	KY 49	27.442	33.688	6.246	11.468	12.492	Yes	
Marion	KY 243	0.000	2.558	2.558	4.929			
Marion	KY 429	0.000	5.368	5.368	10.709			
Marion	KY 457	0.000	0.871	0.871	1.742			
Marion	KY 634	0.000	1.122	1.122		2.244	yes	
Marion	KY 1157	0.000	5.931	5.931	11.862			
Marion	KY 1183	0.000	2.774	2.774	5.825			
Marion	KY 1195	0.000	6.082	6.082	12.164			
TOTAL				30.952	58.699	14.736		

Meade	KY 230	0.000	4.747	4.747		9.494	Yes	
Meade	KY 259	0.000	1.026	1.026		2.052	Yes	
Meade	KY 428	0.000	3.248	3.248	4.498		no	
Meade	KY 428	3.248	5.402	2.154		4.308	Yes	
Meade	KY 1047	0.000	4.195	4.195		8.390	Yes	
Meade	KY 1239	0.000	4.768	4.768	7.629			
Meade	KY 1735	0.000	1.495	1.495		2.990	Yes	
Meade	KY 1844	0.000	4.083	4.083	7.578			
Meade	KY 1882	0.000	5.329	5.329	8.526			
Meade	KY 2726	0.000	3.055	3.055		5.982	Yes	
Meade	KY 2727	0.000	2.322	2.322		4.621	Yes	
Meade	KY 2731	0.000	3.114	3.114		6.228	Yes	
Meade	KY 2734	0.000	2.373	2.373		4.746	Yes	
TOTAL				41.909	28.232	48.810		

**2020 WATERBORNE PAINT STRIPING - DISTRICT 4
RURAL SECONDARY SYSTEM - 4 INCH LINES**

COUNTY	ROUTE	MILEPOINTS		ROADWAY MILES	4" LINES		EDGE LINES	COMMENTS
		BEGIN	END		YELLOW	WHITE		
Nelson	KY 332	0.000	3.115	3.115	6.180			Not striped since 2015
Nelson	KY 509	0.000	9.782	9.782	17.793			
Nelson	KY 523	0.000	7.844	7.844	14.394			
Nelson	KY 605	0.000	10.575	10.575	17.449	21.362	Yes	
Nelson	KY 1066	0.000	1.678	1.678	3.500		NO	
Nelson	KY 1066	1.678	6.001	4.323		8.600	Yes	
Nelson	KY 1754	0.000	1.433	1.433	3.380			
Nelson	KY 1873	0.000	3.074	3.074		6.148	Yes	
Nelson	KY 2735	0.000	8.080	8.080		16.160	Yes	
Nelson	KY 2739	0.000	5.376	5.376		10.752	Yes	
Nelson	KY 3358	0.000	0.165	0.165		0.350	Yes	
TOTAL				55.445	62.697	63.372		
Taylor	KY 372	0.000	3.508	3.508	6.841			
Taylor	KY 424	0.000	1.949	1.949	4.093			
Taylor	KY 527	0.000	5.694	5.694	9.965	11.388	yes	
Taylor	KY 527	5.694	11.377	5.683	9.945			
Taylor	KY 565	0.000	1.325	1.325	2.650			
Taylor	KY 569	0.000	2.182	2.182	4.582			
Taylor	KY 634	0.000	1.686	1.686		3.372	yes	
Taylor	KY 658	0.665	2.890	2.225		4.450	yes	
Taylor	KY 659	0.000	7.968	7.968		15.936	yes	
Taylor	KY 1061	0.000	3.052	3.052	5.640			
Taylor	KY 2784	0.000	5.688	5.688		11.376	yes	
Taylor	KY 3098	0.000	3.080	3.080	5.680			
Taylor	KY 3571	0.000	0.959	0.959	2.000	0.100	no	Turn Lane @ 0.959
TOTAL				44.999	51.395	46.622		
Washington Co.	KY 152	0.000	6.217	6.217	10.569			
Washington Co.	US 390	0.000	1.586	1.586	3.172			
Washington Co.	KY 442	0.000	0.151	0.151	0.302			
Washington Co.	KY 442	0.151	6.661	6.510		13.020	yes	
Washington Co.	KY 458	0.000	6.139	6.139	11.971			
Washington Co.	KY 529	0.000	1.809	1.809		3.618	yes	
Washington Co.	KY 605	0.000	1.332	1.332	2.930			
Washington Co.	KY 1030	0.000	2.725	2.725		5.450	yes	
Washington Co.	KY 1586	0.000	9.957	9.957		19.914	yes	
Washington Co.	KY 1724	0.000	1.830	1.830		3.660	yes	
Washington Co.	KY 1796	0.000	7.853	7.853		15.706	yes	
Washington Co.	KY 2234	0.000	2.285	2.285		4.570	yes	
TOTAL				48.394	28.944	65.938		

**NOTES: 1. 4 INCH LINES - SECTION 842
2. ESTIMATED QUANTITIES ONLY. RE-TRACE AS DIRECTED BY THE ENGINEER.
THE DEPARTMENT WILL MEASURE AND PAY ONLY ACTUAL
QUANTITIES RE-TRACED.**

DETAIL 6 INCH TO 4 INCH TRANSITION

PREFERRED METHOD TO OBTAIN 6" WIDTH FOR VARIOUS STRIPING SCENARIOS

EDGE LINE RUMBLE STRIPS

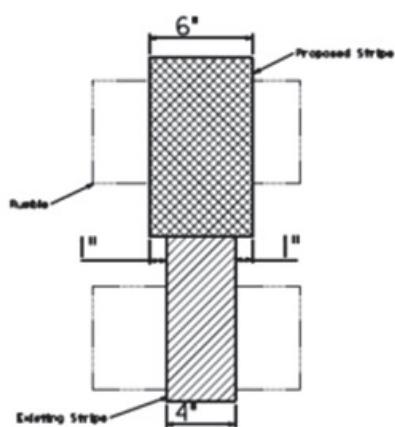

DOUBLE TELLOW CENTERLINE STRIPING

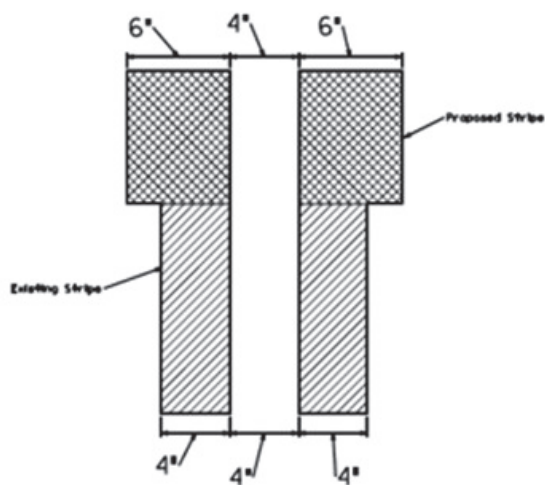

EDGELINES

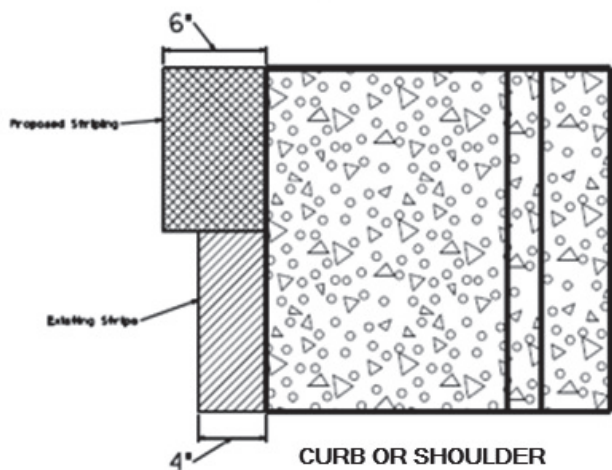

SINGLE SKIP CENTERLINE STRIPING

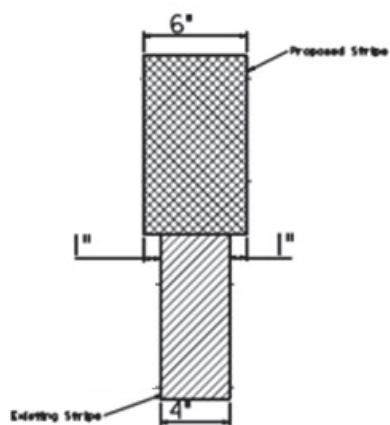

Daily Striping Report

User Instructions Clear Route Information Add More Rows to Route Information

Contractor & District Information

DISTRICT	2
CONTACT	
PROJECT TYPE:	District Wide Striping
FUNDING STRIP:	
CONTRACT ID:	
APPLICATION DATE:	
APPLICATION TYPE:	Permanent
FIRST DAY TO TEST:	
LAST DAY TO TEST:	
SECTION STATUS:	ACCEPT AT 50% PAY

CONTRACTOR	
------------	--

Route Information

County	Route	Direction	Color	Width	Line Type	Starting Milepoint	Ending Milepoint	Striped Line Length (Miles)	Route Length (Miles)	Gal/Mile Avg.	Route Type	Mobile 203)?	(KM Corrective Re-stripe)?
									0.000				
									0.000				
									0.000				
									0.000				
									0.000				
									0.000				
									0.000				
									0.000				
									0.000				
									0.000				
									0.000				
									0.000				
									0.000				
									0.000				
									0.000				
									0.000				
									0.000				
									0.000				
									0.000				
									0.000				
									0.000				
									0.000				
									0.000				
									0.000				
									0.000				
									0.000				

Totals Summary

Materials	Comments	Striped Line Length (Miles)	MP 4" W	MP 4" Y	MP 6" W	MP 6" Y	RS 4" W	RS 4" Y
Yellow WB Traffic Paint								
White WB Traffic Paint								
Beads								

To request measurement of retroreflectivity in accordance with KM203, please email all correspondence to brandi.mitchell@ky.gov. Please notify Central Office at least two (2) weeks in advance of when mobile testing is needed.

PART II
SPECIFICATIONS AND STANDARD DRAWINGS

SPECIFICATIONS REFERENCE

Any reference in the plans or proposal to previous editions of the *Standard Specifications for Road and Bridge Construction* and *Standard Drawings* are superseded by *Standard Specifications for Road and Bridge Construction, Edition of 2019* and *Standard Drawings, Edition of 2016*.

SUPPLEMENTAL SPECIFICATIONS

The contractor shall use the Supplemental Specifications that are effective at the time of letting.
The Supplemental Specifications can be found at the following link:

<http://transportation.ky.gov/Construction/Pages/Kentucky-Standard-Specifications.aspx>

2016 STANDARD DRAWINGS THAT APPLY

APPROACHES, ENTRANCES, AND MAIL BOX TURNOUT	RPM-110-07
PAVEMENT MARKER ARRANGEMENTS MULTI-LANE ROADWAYS	TPM-100-03
PAVEMENT MARKER ARRANGEMENTS MULTI-LANE ROADWAYS	TPM-105-03
PAVEMENT MARKER ARRANGEMENTS MULTI-LANE ROADWAYS	TPM-110-03
PAVEMENT MARKER ARRANGEMENTS TWO-LANE TWO-WAY ROADWAYS	TPM-115-03
PAVEMENT MARKER ARRANGEMENT TWO-LANE TO FOUR-LANE TRANSITIONS.....	TPM-120-03
PAVEMENT MARKER ARRANGEMENT FOR PARALLEL DECELERATION LANE.....	TPM-126
PAVEMENT MARKER ARRANGEMENT CHANNELIZED INTERSECTION	TPM-145-03
MOBILE OPERATION FOR PAINT STRIPING CASE I	TTS-100-02
MOBILE OPERATION FOR PAINT STRIPING CASE II	TTS-105-02
MOBILE OPERATION FOR PAINT STRIPING CASE III.....	TTS-110-02
MOBILE OPERATION FOR PAINT STRIPING CASE IV	TTS-115-02

COUNTY OF	SHEET NO.
TERRING	

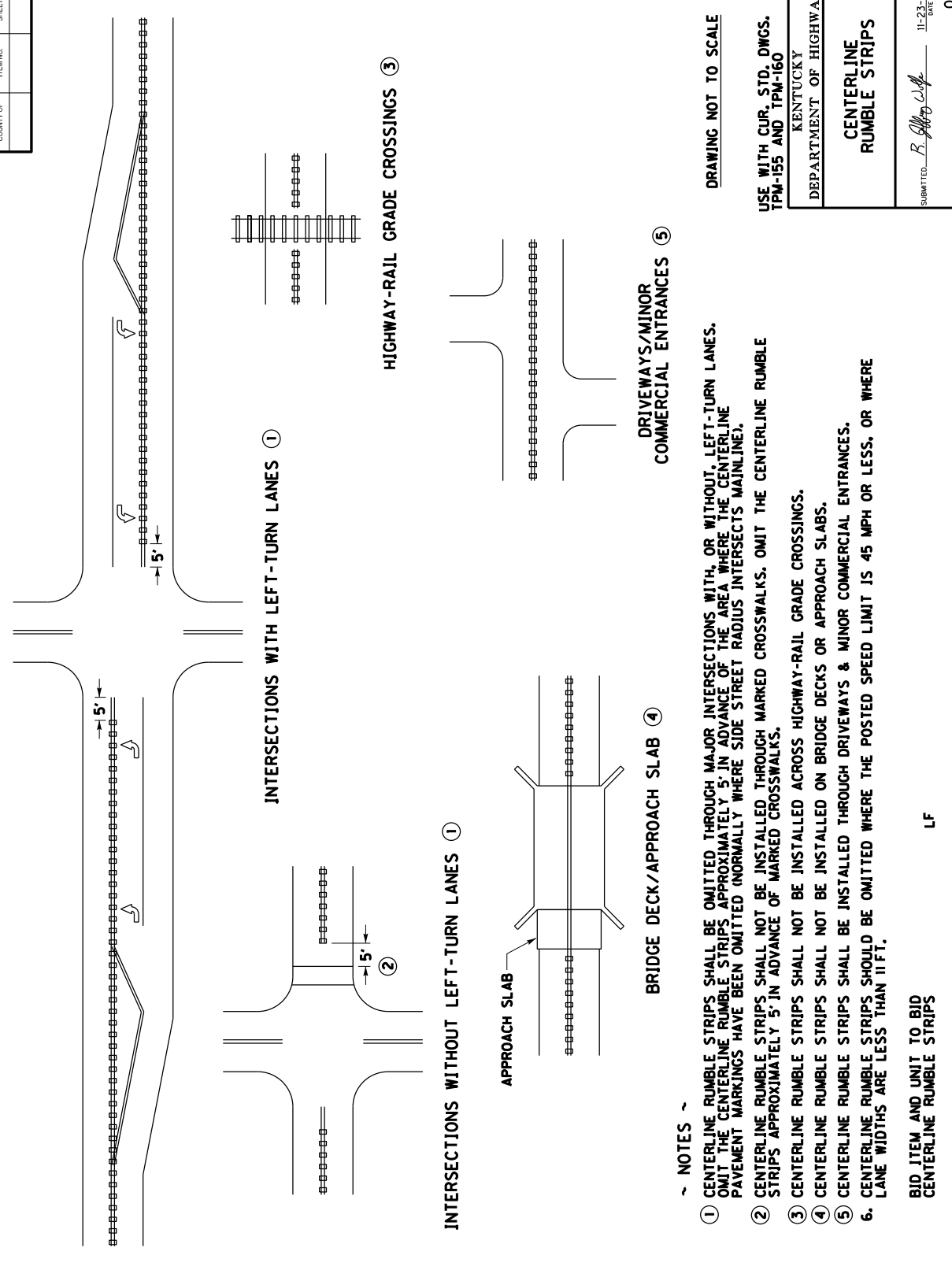

~ NOTES ~

- ① CENTERLINE RUMBLE STRIPS SHALL BE OMITTED THROUGH MAJOR INTERSECTIONS WITH, OR WITHOUT, LEFT-TURN LANES. OMIT THE CENTERLINE RUMBLE STRIPS APPROXIMATELY 5' IN ADVANCE OF THE AREA WHERE THE CENTERLINE PAVEMENT MARKINGS HAVE BEEN OMITTED (NORMALLY WHERE SIDE STREET RADIUS INTERSECTS MAINLINE).
- ② CENTERLINE RUMBLE STRIPS SHALL NOT BE INSTALLED THROUGH MARKED CROSSWALKS. OMIT THE CENTERLINE RUMBLE STRIPS APPROXIMATELY 5' IN ADVANCE OF MARKED CROSSWALKS.
- ③ CENTERLINE RUMBLE STRIPS SHALL NOT BE INSTALLED ACROSS HIGHWAY-RAIL GRADE CROSSINGS.
- ④ CENTERLINE RUMBLE STRIPS SHALL NOT BE INSTALLED ON BRIDGE DECKS OR APPROACH SLABS.
- ⑤ CENTERLINE RUMBLE STRIPS SHALL BE INSTALLED THROUGH DRIVEWAYS & MINOR COMMERCIAL ENTRANCES.
6. CENTERLINE RUMBLE STRIPS SHOULD BE OMITTED WHERE THE POSTED SPEED LIMIT IS 45 MPH OR LESS, OR WHERE LANE WIDTHS ARE LESS THAN 11 FT.

BID ITEM AND UNIT TO BID
CENTERLINE RUMBLE STRIPS

LF

DRAWING NOT TO SCALE
USE WITH CUR. STD. DWGS.
TPM-155 AND TPM-160

KENTUCKY DEPARTMENT OF HIGHWAYS
CENTERLINE RUMBLE STRIPS
SUBMITTED: <i>B. [Signature]</i> JL-23-16 DATE
002

COUNTY OF	TITLING	SHEET NO.

PLAN VIEW

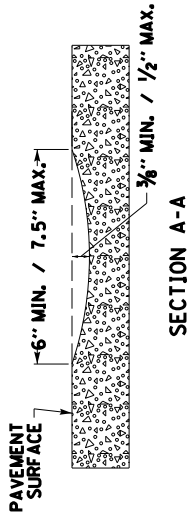
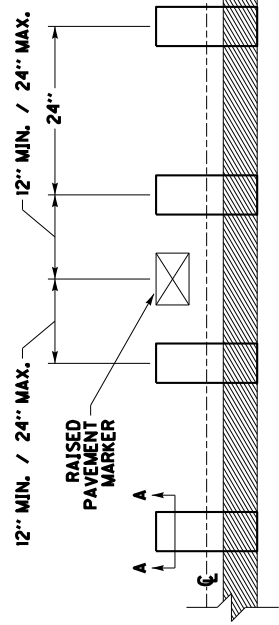
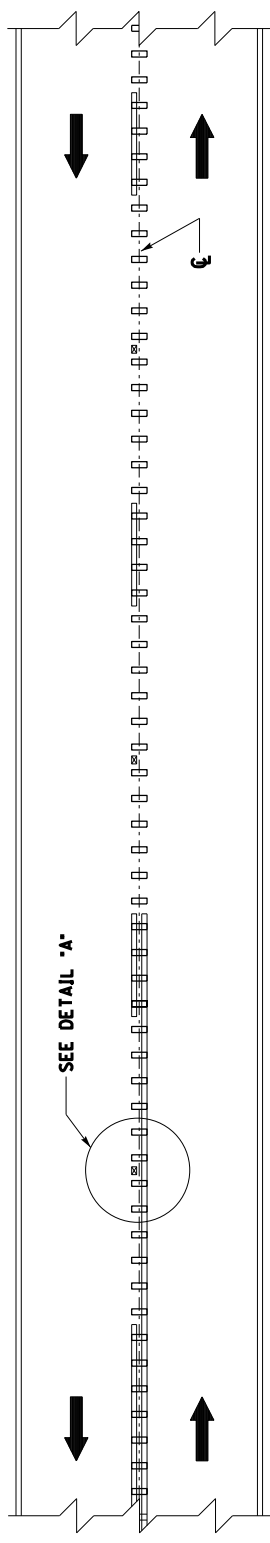

DETAIL 'A'

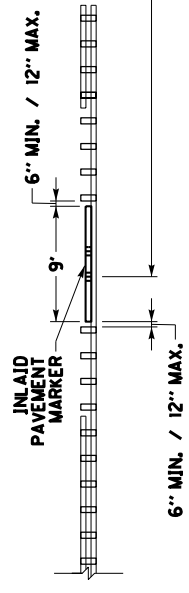

DETAIL FOR CENTERLINE RUMBLE STRIPS WITH INLAID PAVEMENT MARKERS

NOTES

1. DISTANCES SHOWN ARE APPROXIMATE. MAINTAIN RUMBLE STRIP DIMENSIONS AND SPACING AS MUCH AS POSSIBLE.
2. CENTERLINE RUMBLE STRIPS SHALL BE INSTALLED IN LINE WITH THE CENTER OF THE ROADWAY AS MUCH AS POSSIBLE.
3. DISCONTINUE CENTERLINE RUMBLE STRIPS AT LEAST 12'' BEFORE AND AFTER THE CENTER OF EACH RAISED PAVEMENT MARKER, AND AT LEAST 6'' BEFORE AND AFTER THE GROOVE FOR EACH INLAID PAVEMENT MARKER, INSTALL AS MANY RUMBLE STRIPS AS POSSIBLE BETWEEN ADJACENT PAVEMENT MARKERS WHILE MAINTAINING THE 24'' CYCLE.
4. DO NOT INSTALL CENTERLINE RUMBLE STRIPS IN AREAS INDICATED ON TPM-150.
5. CENTERLINE RUMBLE STRIPS SHOULD BE OMITTED WHERE THE POSTED SPEED LIMIT IS 45 MPH OR LESS, OR WHERE LANE WIDTHS ARE LESS THAN 11 FT.

BID ITEM AND UNIT TO BID
CENTERLINE RUMBLE STRIPS

LF

DRAWING NOT TO SCALE
USE WITH CUR. STD. DWG.
TPM-150

KENTUCKY
DEPARTMENT OF HIGHWAYS
CENTERLINE
RUMBLE STRIPS
4 INCH STRIPING

SUBMITTED: *B. [Signature]*
11-23-16
DATE
003

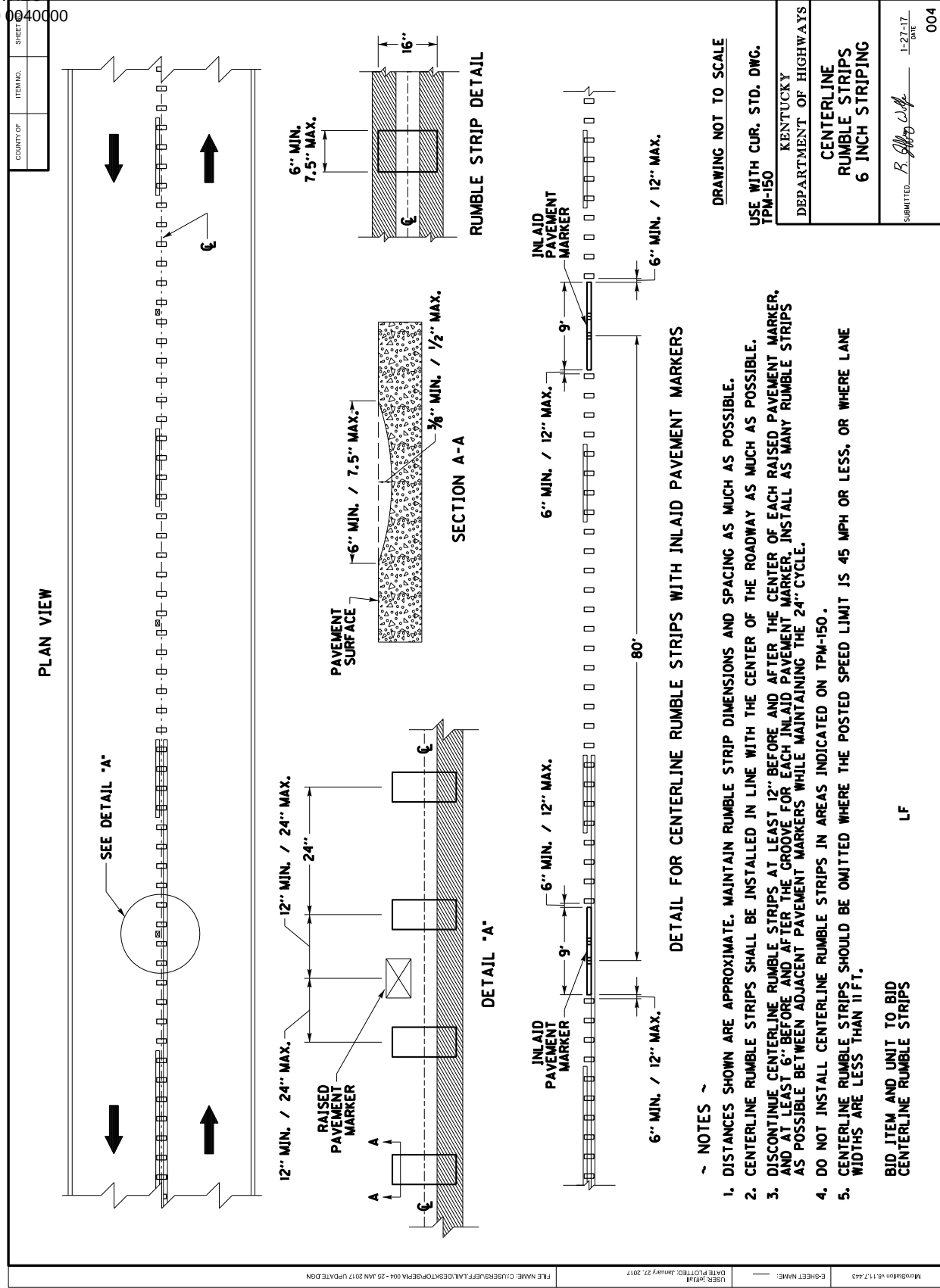

FILE NAME: C:\USERS\JEFF.LAL\DESKTOP\PA 004 - 25 JAN 2017 UPD\A.DGN
 USER: jellm
 DATE PLOTTED: January 27, 2017
 MicroStation v8.11.7.443
 E-SHEET NAME:

LF
BID ITEM AND UNIT TO BID
CENTERLINE RUMBLE STRIPS

COUNTY OF	SHEET NO.
TOWNSHIP	

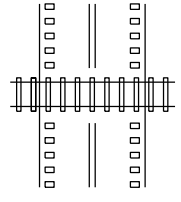
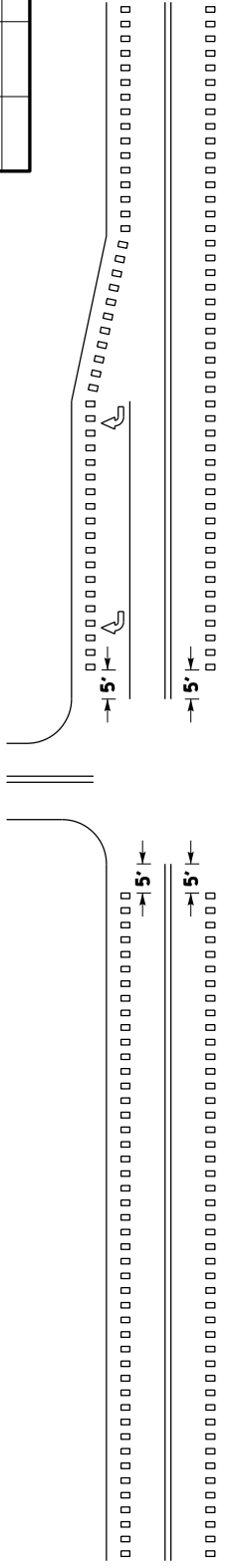

HIGHWAY-RAIL GRADE CROSSINGS ③

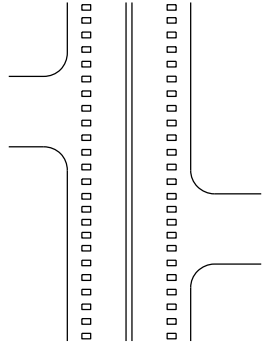

DRIVEWAYS/MINOR COMMERCIAL ENTRANCES ⑤

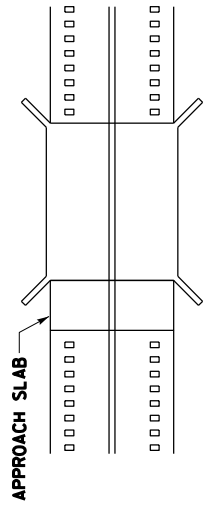

BRIDGE DECK/APPROACH SLAB ④

MAILBOX TURNOUTS ⑥

~ NOTES ~

- ① RUMBLE STRIPS SHALL BE OMITTED THROUGH MAJOR INTERSECTIONS WITH, OR WITHOUT, RIGHT-TURN LANES. OMIT RUMBLE STRIPS APPROXIMATELY 5' IN ADVANCE OF THE AREA WHERE EDGELINE PAVEMENT MARKINGS HAVE BEEN OMITTED (NORMALLY WHERE SIDE STREET RADIUS INTERSECTS MAINLINE).
- ② RUMBLE STRIPS SHALL NOT BE INSTALLED THROUGH MARKED CROSSWALKS. OMIT RUMBLE STRIPS APPROXIMATELY 5' IN ADVANCE OF MARKED CROSSWALKS.
- ③ RUMBLE STRIPS SHALL NOT BE INSTALLED ACROSS HIGHWAY-RAIL GRADE CROSSINGS.
- ④ RUMBLE STRIPS SHALL NOT BE INSTALLED ON BRIDGE DECKS OR APPROACH SLABS.
- ⑤ RUMBLE STRIPS SHALL BE INSTALLED THROUGH DRIVEWAYS & MINOR COMMERCIAL ENTRANCES.
- ⑥ RUMBLE STRIPS SHALL BE INSTALLED THROUGH MAILBOX TURNOUTS.
7. RUMBLE STRIPS SHOULD BE OMITTED WHERE THE POSTED SPEED LIMIT IS 45 MPH OR LESS.

DRAWING NOT TO SCALE

USE WITH SEPIA 006, 007, AND 008

KENTUCKY
DEPARTMENT OF HIGHWAYS
SHOULDER & EDGELINE
RUMBLE STRIP DETAILS

SUBMITTED: *B. [Signature]* JI-23-16 DATE
005

BID ITEMS AND UNIT TO BID
EDGELINE RUMBLE STRIPS
SHOULDER RUMBLE STRIPS

LF
LF

COUNTY OF	TIERING	SHEET NO.

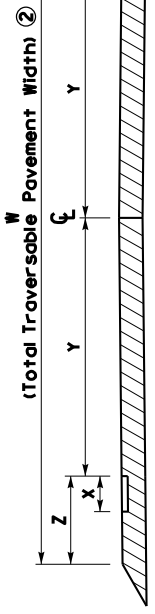

PAVEMENT CROSS-SECTION

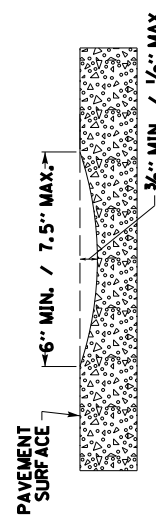
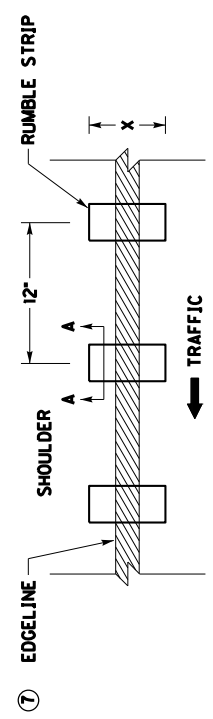

PAVEMENT WIDTH (W) ②	RUMBLE LENGTH (X) ⑥	ELRS ONLY		CLRS & ELRS	
		LANE WIDTH (Y) ③	SHOULDER WIDTH (Z) ④	LANE WIDTH (Y) ③	SHOULDER WIDTH (Z) ④
20'	8"	9'	1'	N/A	N/A
21'	8"	9.5'	1'	N/A	N/A
22'	8"	10'	1'	N/A	N/A
23'	8"	10'	1.5'	N/A	N/A
24'	8"	10.5'	1.5'	N/A	N/A
25'	8"	N/A	N/A	11'	1.5'
26'	8"	N/A	N/A	11'	2'
27'	8"	N/A	N/A	11.5'	2'
28'	8"	N/A	N/A	12'	2'
29'	8"	N/A	N/A	12'	2.5'
30'	8"	N/A	N/A	12'	3'
31'	8"	N/A	N/A	12'	3.5'
32'	8"	N/A	N/A	12'	4'
33'	8"	N/A	N/A	12'	4.5'

NOTES

1. EDGELINE RUMBLE STRIPS SHOULD BE INSTALLED ACCORDING TO THE DIMENSIONS PROPOSED ABOVE UNLESS THERE IS AN ENGINEERING BASIS THAT SUPPORTS A CHANGE IN DIMENSION. FOR EXAMPLE, IF THE EXISTING LANE WIDTH IS NARROWER THAN THE LANE WIDTH PROPOSED IN THIS DRAWING AND THE EXISTING SHOULDER PAVEMENT DEPTH IS NOT SUITABLE TO BE CONVERTED INTO A PORTION OF THE PROPOSED LANE WIDTH, THEN THE EXISTING LANE WIDTH SHOULD BE USED INSTEAD OF THE WIDTH PROPOSED IN THIS DRAWING.
2. PAVEMENT WIDTH (W) IS THE TOTAL WIDTH OF TRAVERSABLE PAVEMENT. DO NOT INCLUDE THE WIDTH OF ANY NON-TRAVERSABLE PAVEMENT, SUCH AS PAVEMENT WEDGES, WHEN MEASURING THE PAVEMENT WIDTH (W).
3. LANE WIDTH (Y) TO BE MEASURED FROM CENTER OF ROAD TO LANE SIDE EDGE OF RUMBLE STRIP.
4. PAVED SHOULDER WIDTH (Z) TO BE MEASURED FROM LANE SIDE EDGE OF RUMBLE STRIP TO OUTSIDE EDGE OF TRAVERSABLE PAVEMENT.
5. DISTANCES SHOWN ARE APPROXIMATE. MAINTAIN RUMBLE STRIP DIMENSIONS AND SPACING AS MUCH AS POSSIBLE. IF THE TYPICAL SECTION SHOWS A LANE WIDTH (Y) AND/OR SHOULDER WIDTH (Z) THAT DIFFERS FROM THE WIDTHS LISTED IN THIS DRAWING, THE ENGINEER SHALL DETERMINE THE LANE WIDTH (Y) AND/OR SHOULDER WIDTH (Z) AT THE TIME OF CONSTRUCTION.
NOTE: CENTERLINE RUMBLE STRIPS SHOULD BE OMITTED WHEN THE LANE WIDTH (Y) IS LESS THAN 11 FT.
6. RUMBLE LENGTH (X) MAY BE MODIFIED AS THE ENGINEER DIRECTS. IF THE SHOULDER WIDTH (Z) IS EQUAL TO OR LESS THAN THE PROPOSED RUMBLE LENGTH (X).
7. PLACE THE EDGELINE MARKING IN THE CENTER OF THE RUMBLE STRIP.
8. EDGELINE RUMBLE STRIPS SHOULD BE OMITTED WHERE THE POSTED SPEED LIMIT IS 45 MPH OR LESS.

BID ITEM AND UNIT TO BID
EDGELINE RUMBLE STRIPS

LF

DRAWING NOT TO SCALE

USE WITH SEPIA 005

KENTUCKY
DEPARTMENT OF HIGHWAYS
EDGELINE RUMBLE STRIP
DETAILS
TWO LANE ROADWAYS

SUBMITTED: *B. [Signature]*
DATE: 11-23-16
006

COUNTY OF	TITLING	SHEET NO.

PAVEMENT WIDTH (W) ②	RUMBLE LENGTH (X) ⑤	OFFSET ⑥	CLRS & SRS	
			LANE WIDTH (Y) ③	SHOULDER WIDTH (Z) ④
34'	8"	6"	12'	5'
35'	8"	6"	12'	5.5'
36'	8"	6"	12'	6'
37'	12"	12"	12'	6.5'
38'	12"	12"	12'	7'
39'	12"	12"	12'	7.5'
>=40'	16"	12"	12'	>=8'

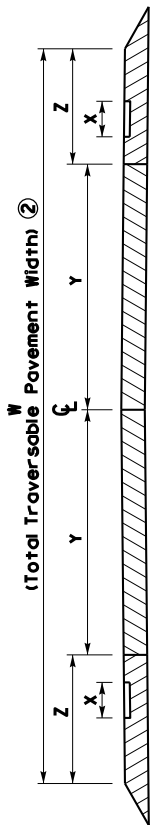

PAVEMENT CROSS-SECTION

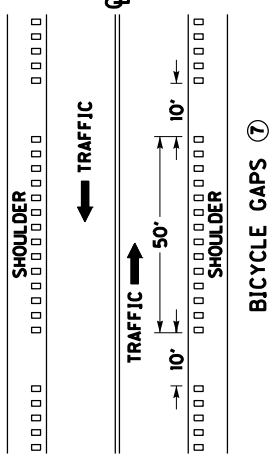
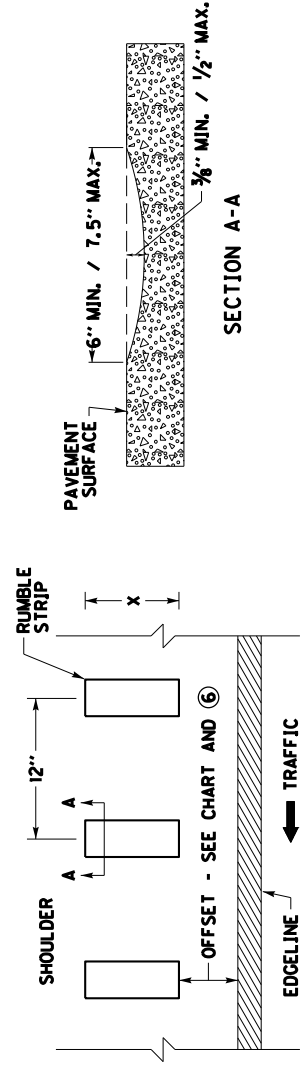

~ NOTES ~

- SHOULDER RUMBLE STRIPS SHOULD BE INSTALLED ACCORDING TO THE DIMENSIONS PROPOSED ABOVE UNLESS THERE IS AN ENGINEERING BASIS THAT SUPPORTS A CHANGE IN DIMENSION. FOR EXAMPLE, IF THE EXISTING LANE WIDTH IS NARROWER THAN THE LANE WIDTH PROPOSED IN THIS DRAWING AND THE EXISTING SHOULDER PAVEMENT DEPTH IS NOT SUITABLE TO BE CONVERTED INTO A PORTION OF THE PROPOSED LANE WIDTH, THEN THE EXISTING LANE WIDTH SHOULD BE USED INSTEAD OF THE WIDTH PROPOSED IN THIS DRAWING.
- PAVEMENT WIDTH (W) IS THE TOTAL WIDTH OF TRAVERSABLE PAVEMENT. DO NOT INCLUDE THE WIDTH OF ANY NON-TRAVERSABLE PAVEMENT, SUCH AS PAVEMENT WEDGES, WHEN MEASURING THE PAVEMENT WIDTH (W).
- LANE WIDTH (Y) TO BE MEASURED FROM CENTER OF ROAD TO CENTER OF EDGELINE STRIPE.
- PAVED SHOULDER WIDTH (Z) TO BE MEASURED FROM CENTER OF EDGELINE STRIPE TO OUTSIDE EDGE OF TRAVERSABLE PAVEMENT. DISTANCES SHOWN ARE APPROXIMATE. MAINTAIN RUMBLE STRIP DIMENSIONS AND SPACING AS MUCH AS POSSIBLE. IF THE TYPICAL SECTION SHOWS A LANE WIDTH (Y) AND/OR SHOULDER WIDTH (Z) THAT DIFFERS FROM THE WIDTHS LISTED IN THIS DRAWING, THE ENGINEER SHALL DETERMINE THE LANE WIDTH (Y) AND/OR SHOULDER WIDTH (Z) AT THE TIME OF CONSTRUCTION.
- NOTE: CENTERLINE RUMBLE STRIPS SHOULD BE OMITTED WHEN THE LANE WIDTH (Y) IS LESS THAN 11 FT.
- RUMBLE LENGTH (X) AND/OR OFFSET DISTANCE MAY BE MODIFIED AS THE ENGINEER DIRECTS, IF THE SHOULDER WIDTH (Z) IS EQUAL TO OR LESS THAN THE COMBINED WIDTH OF THE PROPOSED RUMBLE LENGTH (X) AND OFFSET DISTANCE.
- ALL SHOULDER RUMBLE STRIPS ALONG SHOULDERS THAT ARE 5' OR WIDER SHOULD INCLUDE BICYCLE GAPS AS DETAILED.
- SHOULDER RUMBLE STRIPS SHOULD BE OMITTED WHERE THE POSTED SPEED LIMIT IS 45 MPH OR LESS.

DRAWING NOT TO SCALE

USE WITH SEP1A 005
KENTUCKY
DEPARTMENT OF HIGHWAYS
SHOULDER RUMBLE STRIP
DETAILS
TWO LANE ROADWAYS
SUBMITTED: *B. [Signature]* JL-23-16 DATE
007

BID ITEM AND UNIT TO BID
SHOULDER RUMBLE STRIPS

LF

COUNTY OF	TITLING	SHEET NO.
-----------	---------	-----------

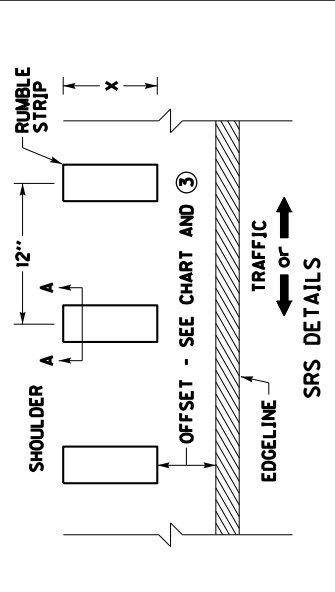
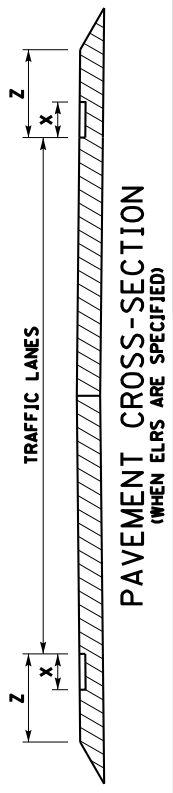
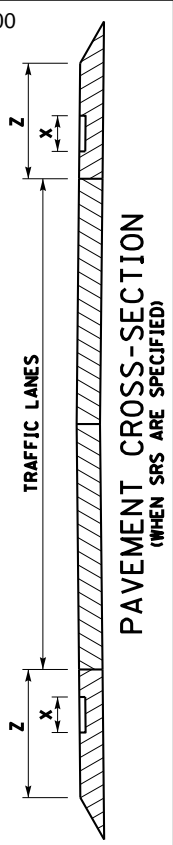

SHOULDER WIDTH (Z) ②	RUMBLE TYPE ①	RUMBLE LENGTH (X) ③	OFFSET ④
>1'	ELRS	8"	N/A
2'	ELRS-N/A SRS-6"	8"	ELRS-N/A SRS-6"
3'	ELRS or SRS	8"	ELRS-N/A SRS-6"
4'	ELRS or SRS	8"	ELRS-N/A SRS-6"
5'	SRS ⑥	8"	6"
6'	SRS ⑥	8"	6"
7'	SRS ⑥	12"	12"
>8'	SRS ⑥	16"	12"

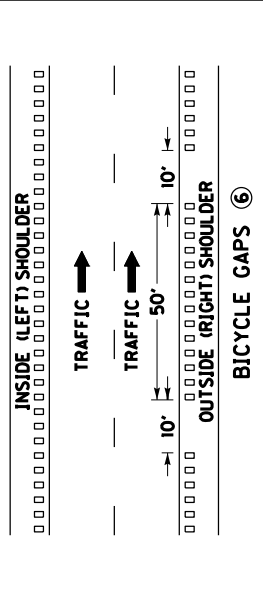
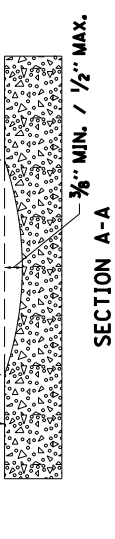
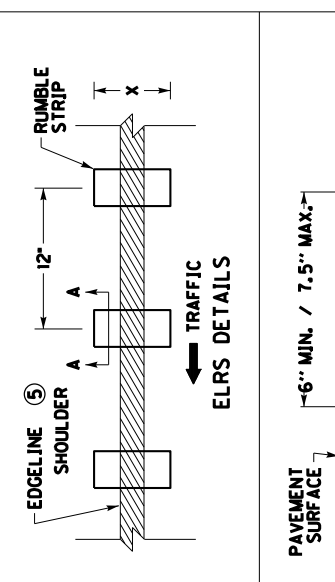

- NOTES ~
- FOR MULTI-LANE ROADWAYS, THE RUMBLE TYPE TO BE INSTALLED IS BASED ON SHOULDER WIDTH (Z), FOR SHOULDER WIDTHS OF 2', 3', AND 4' THE RUMBLE TYPE MAY BE SPECIFIED AS EITHER EDGE LINE RUMBLE STRIPS (ELRS) OR SHOULDER RUMBLE STRIPS (SRS). IN THESE SITUATIONS, THE RUMBLE TYPE TO BE INSTALLED WILL BE SPECIFIED IN THE PLANS, PROPOSAL, AND/OR BID ITEMS, OR AS DIRECTED BY THE ENGINEER.
 - WHEN ELRS ARE SPECIFIED, SHOULDER WIDTH (Z) IS FROM LANE SIDE EDGE OF RUMBLE STRIP TO OUTSIDE EDGE OF TRAVERSABLE PAVEMENT. WHEN SRS ARE SPECIFIED, SHOULDER WIDTH (Z) IS FROM CENTER OF EDGE LINE STRIPE TO OUTSIDE EDGE OF TRAVERSABLE PAVEMENT.
 - RUMBLE LENGTH (X) AND/OR OFFSET DISTANCE MAY BE MODIFIED AS THE ENGINEER DIRECTS. IF THE SHOULDER WIDTH (Z) IS EQUAL TO OR LESS THAN THE COMBINED WIDTH OF THE PROPOSED RUMBLE LENGTH (X) AND OFFSET DISTANCE.
 - DISTANCES SHOWN ARE APPROXIMATE. MAINTAIN RUMBLE STRIP DIMENSIONS AND SPACING AS MUCH AS POSSIBLE.
 - WHEN ELRS ARE SPECIFIED, THE EDGE LINE MARKING SHALL BE PLACED IN THE CENTER OF THE RUMBLE STRIP.
 - SHOULDER RUMBLE STRIPS (SRS) ALONG OUTSIDE (RIGHT) SHOULDERS THAT ARE 5' OR WIDER SHOULD INCLUDE BICYCLE GAPS AS DETAILED. BICYCLE GAPS ARE NOT REQUIRED ON INSIDE (LEFT) SHOULDERS. BICYCLE GAPS SHALL NOT BE USED ON INTERSTATES AND PARKWAYS.
 - RUMBLE STRIPS SHOULD BE OMITTED WHERE THE POSTED SPEED LIMIT IS 45 MPH OR LESS, OR WHEN THE SHOULDER WIDTH IS LESS THAN 1 FT.

BID ITEMS AND UNIT TO BID
SHOULDER RUMBLE STRIPS
EDGE LINE RUMBLE STRIPS

LF
LF

USE WITH SEP1A 005

KENTUCKY
DEPARTMENT OF HIGHWAYS

RUMBLE STRIP DETAILS
MULTI-LANE ROADWAYS
AND RAMP

SUBMITTED: *B. [Signature]* JL-23-16 DATE

008

PART III

EMPLOYMENT, WAGE AND RECORD REQUIREMENTS

**TRANSPORTATION CABINET
DEPARTMENT OF HIGHWAYS**

**LABOR AND WAGE REQUIREMENTS
APPLICABLE TO OTHER THAN FEDERAL-AID SYSTEM PROJECTS**

- I. Application
- II. Nondiscrimination of Employees (KRS 344)

I. APPLICATION

1. These contract provisions shall apply to all work performed on the contract by the contractor with his own organization and with the assistance of workmen under his immediate superintendence and to all work performed on the contract by piecework, station work or by subcontract. The contractor's organization shall be construed to include only workmen employed and paid directly by the contractor and equipment owned or rented by him, with or without operators.

2. The contractor shall insert in each of his subcontracts all of the stipulations contained in these Required Provisions and such other stipulations as may be required.

3. A breach of any of the stipulations contained in these Required Provisions may be grounds for termination of the contract.

3. If the contractor is in control of apprenticeship or other training or retraining, including on-the-job training programs, he shall not discriminate against an individual because of his race, color, religion, national origin, sex, disability or age forty (40) and over, in admission to, or employment in any program established to provide apprenticeship or other training.

4. The contractor will send to each labor union or representative of workers with which he has a collective bargaining agreement or other contract or understanding, a notice to be provided advising the said labor union or workers' representative of the contractor's commitments under this section, and shall post copies of the notice in conspicuous places available to employees and applicants for employment. The contractor will take such action with respect to any subcontract or purchase order as the administrating agency may direct as a means of enforcing such provisions, including sanctions for non-compliance.

Revised: January 25, 2017

II. NONDISCRIMINATION OF EMPLOYEES

**AN ACT OF THE KENTUCKY
GENERAL ASSEMBLY TO PREVENT
DISCRIMINATION IN EMPLOYMENT
KRS CHAPTER 344
EFFECTIVE JUNE 16, 1972**

The contract on this project, in accordance with KRS Chapter 344, provides that during the performance of this contract, the contractor agrees as follows:

1. The contractor shall not fail or refuse to hire, or shall not discharge any individual, or otherwise discriminate against an individual with respect to his compensation, terms, conditions, or privileges of employment, because of such individual's race, color, religion, national origin, sex, disability or age (forty and above); or limit, segregate, or classify his employees in any way which would deprive or tend to deprive an individual of employment opportunities or otherwise adversely affect his status as an employee, because of such individual's race, color, religion, national origin, sex, disability or age forty (40) and over. The contractor agrees to post in conspicuous places, available to employees and applicants for employment, notices to be provided setting forth the provisions of this nondiscrimination clause.

2. The contractor shall not print or publish or cause to be printed or published a notice or advertisement relating to employment by such an employer or membership in or any classification or referral for employment by the employment agency, indicating any preference, limitation, specification, or discrimination, based on race, color, religion, national origin, sex, or age forty (40) and over, or because the person is a qualified individual with a disability, except that such a notice or advertisement may indicate a preference, limitation, or specification based on religion, national origin, sex, or age forty (40) and over, or because the person is a qualified individual with a disability, when religion, national origin, sex, or age forty (40) and over, or because the person is a qualified individual with a disability, is a bona fide occupational qualification for employment.

EXECUTIVE BRANCH CODE OF ETHICS

In the 1992 regular legislative session, the General Assembly passed and Governor Brereton Jones signed Senate Bill 63 (codified as KRS 11A), the Executive Branch Code of Ethics, which states, in part:

KRS 11A.040 (7) provides:

No present or former public servant shall, within six (6) months following termination of his office or employment, accept employment, compensation, or other economic benefit from any person or business that contracts or does business with, or is regulated by, the state in matters in which he was directly involved during the last thirty-six (36) months of his tenure. This provision shall not prohibit an individual from returning to the same business, firm, occupation, or profession in which he was involved prior to taking office or beginning his term of employment, or for which he received, prior to his state employment, a professional degree or license, provided that, for a period of six (6) months, he personally refrains from working on any matter in which he was directly involved during the last thirty-six (36) months of his tenure in state government. This subsection shall not prohibit the performance of ministerial functions, including but not limited to filing tax returns, filing applications for permits or licenses, or filing incorporation papers, nor shall it prohibit the former officer or public servant from receiving public funds disbursed through entitlement programs.

KRS 11A.040 (9) states:

A former public servant shall not represent a person or business before a state agency in a matter in which the former public servant was directly involved during the last thirty-six (36) months of his tenure, for a period of one (1) year after the latter of:

- a) The date of leaving office or termination of employment; or
- b) The date the term of office expires to which the public servant was elected.

This law is intended to promote public confidence in the integrity of state government and to declare as public policy the idea that state employees should view their work as a public trust and not as a way to obtain private benefits.

If you have worked for the executive branch of state government within the past six months, you may be subject to the law's prohibitions. The law's applicability may be different if you hold elected office or are contemplating representation of another before a state agency.

Also, if you are affiliated with a firm which does business with the state and which employs former state executive-branch employees, you should be aware that the law may apply to them.

In case of doubt, the law permits you to request an advisory opinion from the Executive Branch Ethics Commission, 3 Fountain Place, Frankfort, Kentucky 40601; telephone (502) 564-7954.

Revised: January 27, 2017

Kentucky Equal Employment Opportunity Act of 1978

The requirements of the Kentucky Equal Employment Opportunity Act of 1978 (KRS 45.560-45.640) shall apply to this Contract. The apparent low Bidder will be required to submit EEO forms to the Division of Construction Procurement, which will then forward to the Finance and Administration Cabinet for review and approval. No award will become effective until all forms are submitted and EEO/CC has certified compliance. The required EEO forms are as follows:

- EEO-1: Employer Information Report
- Affidavit of Intent to Comply
- Employee Data Sheet
- Subcontractor Report

These forms are available on the Finance and Administration's web page under ***Vendor Information, Standard Attachments and General Terms*** at the following address:
<https://www.eProcurement.ky.gov>.

Bidders currently certified as being in compliance by the Finance and Administration Cabinet may submit a copy of their approval letter in lieu of the referenced EEO forms.

For questions or assistance please contact the Finance and Administration Cabinet by email at **finance.contractcompliance@ky.gov** or by phone at 502-564-2874.

EMPLOYEE RIGHTS UNDER THE FAIR LABOR STANDARDS ACT

THE UNITED STATES DEPARTMENT OF LABOR WAGE AND HOUR DIVISION

FEDERAL MINIMUM WAGE

\$7.25

 PER HOUR

BEGINNING JULY 24, 2009

OVERTIME PAY At least 1½ times your regular rate of pay for all hours worked over 40 in a workweek.

CHILD LABOR An employee must be at least **16** years old to work in most non-farm jobs and at least **18** to work in non-farm jobs declared hazardous by the Secretary of Labor.

Youths **14** and **15** years old may work outside school hours in various non-manufacturing, non-mining, non-hazardous jobs under the following conditions:

No more than

- **3** hours on a school day or **18** hours in a school week;
- **8** hours on a non-school day or **40** hours in a non-school week.

Also, work may not begin before **7 a.m.** or end after **7 p.m.**, except from June 1 through Labor Day, when evening hours are extended to **9 p.m.** Different rules apply in agricultural employment.

TIP CREDIT Employers of “tipped employees” must pay a cash wage of at least \$2.13 per hour if they claim a tip credit against their minimum wage obligation. If an employee’s tips combined with the employer’s cash wage of at least \$2.13 per hour do not equal the minimum hourly wage, the employer must make up the difference. Certain other conditions must also be met.

ENFORCEMENT The Department of Labor may recover back wages either administratively or through court action, for the employees that have been underpaid in violation of the law. Violations may result in civil or criminal action.

Employers may be assessed civil money penalties of up to \$1,100 for each willful or repeated violation of the minimum wage or overtime pay provisions of the law and up to \$11,000 for each employee who is the subject of a violation of the Act’s child labor provisions. In addition, a civil money penalty of up to \$50,000 may be assessed for each child labor violation that causes the death or serious injury of any minor employee, and such assessments may be doubled, up to \$100,000, when the violations are determined to be willful or repeated. The law also prohibits discriminating against or discharging workers who file a complaint or participate in any proceeding under the Act.

ADDITIONAL INFORMATION

- Certain occupations and establishments are exempt from the minimum wage and/or overtime pay provisions.
- Special provisions apply to workers in American Samoa and the Commonwealth of the Northern Mariana Islands.
- Some state laws provide greater employee protections; employers must comply with both.
- The law requires employers to display this poster where employees can readily see it.
- Employees under 20 years of age may be paid \$4.25 per hour during their first 90 consecutive calendar days of employment with an employer.
- Certain full-time students, student learners, apprentices, and workers with disabilities may be paid less than the minimum wage under special certificates issued by the Department of Labor.

For additional information:



1-866-4-USWAGE

(1-866-487-9243) TTY: 1-877-889-5627



WWW.WAGEHOUR.DOL.GOV

PART IV
INSURANCE

Refer to
Kentucky Standard Specifications for Road and Bridge Construction,
current edition

PART V
BID ITEMS

PROPOSAL BID ITEMS

202004

Page 1 of 1

Report Date 1/24/20

Section: 0001 - RS ROUTES BRECKINRIDGE COUNTY

LINE	BID CODE	ALT	DESCRIPTION	QUANTITY	UNIT	UNIT PRIC	FP	AMOUNT
0010	06520		PAVE STRIPING-WB PAINT-4 IN W	79.50	MILE		\$	
0020	06520		PAVE STRIPING-WB PAINT-4 IN W RS ROUTES	46.62	MILE		\$	
0030	06520		PAVE STRIPING-WB PAINT-4 IN W RS ROUTES	484.51	MILE		\$	
0040	06521		PAVE STRIPING-WB PAINT-4 IN Y MP ROUTES	788.43	MILE		\$	
0050	06521		PAVE STRIPING-WB PAINT-4 IN Y RS ROUTES	579.94	MILE		\$	
0060	23140EN		DURABLE WATERBORNE MARKING-6 IN W	280.12	MILE		\$	
0070	23141EN		DURABLE WATERBORNE MARKING-6 IN Y	241.01	MILE		\$	

Section: 0002 - OVERALL ITEMS ALL ROUTES DISTRICT 4

LINE	BID CODE	ALT	DESCRIPTION	QUANTITY	UNIT	UNIT PRIC	FP	AMOUNT
0080	02572		QUALITY CONTROL	1.00	LS		\$	
0090	20411ED		LAW ENFORCEMENT OFFICER	10.00	HOUR		\$	
0100	21741NC		MAINTAIN & CONTROL TRAFFIC	1.00	EACH		\$	
0110	22664EN		WATER BLASTING EXISTING STRIPE	1,000.00	LF		\$	

Section: 0003 - DEMOBILIZATION

LINE	BID CODE	ALT	DESCRIPTION	QUANTITY	UNIT	UNIT PRIC	FP	AMOUNT
0120	02569		DEMOBILIZATION	1.00	LS		\$	