



**CALL NO. 314**

**CONTRACT ID. 242173**

**LIVINGSTON COUNTY**

**FED/STATE PROJECT NUMBER FD05 070 0453 013-016**

**DESCRIPTION COURT STREET (KY 453)**

**WORK TYPE ASPHALT RESURFACING**

**PRIMARY COMPLETION DATE 6/30/2025**

**LETTING DATE: July 18,2024**

Sealed Bids will be received electronically through the Bid Express bidding service until 10:00 AM EASTERN DAYLIGHT TIME July 18,2024. Bids will be publicly announced at 10:00 AM EASTERN DAYLIGHT TIME.

**NO PLANS ASSOCIATED WITH THIS PROJECT.**

**REQUIRED BID PROPOSAL GUARANTY:** Not less than 5% of the total bid.

## TABLE OF CONTENTS

PART I	SCOPE OF WORK
	<ul style="list-style-type: none"><li>• PROJECT(S), COMPLETION DATE(S), &amp; LIQUIDATED DAMAGES</li><li>• CONTRACT NOTES</li><li>• STATE CONTRACT NOTES</li><li>• SURFACING AREAS</li><li>• ASPHALT MIXTURE</li><li>• INCIDENTAL SURFACING</li><li>• COMPACTION OPTION B</li><li>• ELECTRONIC DELIVERY MANAGEMENT SYSTEM (E-TICKETING)</li><li>• ASPHALT MIX PAVEMENT WEDGE MONOLITHIC OPERATION</li><li>• EDGE KEY (BY TON)</li><li>• ASPHALT MILLING AND TEXTURING</li><li>• TYPICAL SECTION DIMENSIONS</li><li>• TRAFFIC CONTROL PLAN 2 LANE</li><li>• DURABLE PAVEMENT EDGE DETAILS</li><li>• SKETCH MAP(S)</li><li>• SUMMARY SHEET(S)</li><li>• TYPICAL SECTION(S)</li><li>• BRIDGE DETAIL FOR PAVING PROJECT</li></ul>
PART II	SPECIFICATIONS AND STANDARD DRAWINGS
	<ul style="list-style-type: none"><li>• STANDARD AND SUPPLEMENTAL SPECIFICATIONS</li><li>• 2020 STANDARD DRAWINGS THAT APPLY</li></ul>
PART III	EMPLOYMENT, WAGE AND RECORD REQUIREMENTS
	<ul style="list-style-type: none"><li>• LABOR AND WAGE REQUIREMENTS</li><li>• EXECUTIVE BRANCH CODE OF ETHICS</li><li>• KENTUCKY EQUAL EMPLOYMENT OPPORTUNITY ACT OF 1978 LOCALITY / STATE</li><li>• PROJECT WAGE RATES / STATE FUNDED</li></ul>
PART IV	INSURANCE
PART V	BID ITEMS

**PART I**  
**SCOPE OF WORK**

## ADMINISTRATIVE DISTRICT - 01

**CONTRACT ID - 242173**

**FD05 070 0453 013-016**

**COUNTY - LIVINGSTON**

**PCN - MP07004532401**

**FD05 070 0453 013-016**

COURT STREET (KY 453) (MP 13.854) BEGIN 0.046 MILES NORTH OF ROCK SPRING BRANCH CULVERT  
EXTENDING NORTH TO RIVERFRONT DRIVE (MP 15.819), A DISTANCE OF 01.96 MILES.ASPHALT  
RESURFACING

GEOGRAPHIC COORDINATES LATITUDE 37:07:53.92 LONGITUDE 88:23:42.25

ADT 1,600

**COMPLETION DATE(S):**

COMPLETED BY 06/30/2025

APPLIES TO ENTIRE CONTRACT

## **CONTRACT NOTES**

### **PROPOSAL ADDENDA**

All addenda to this proposal must be applied when calculating bid and certified in the bid packet submitted to the Kentucky Department of Highways. Failure to use the correct and most recent addenda may result in the bid being rejected.

### **BID SUBMITTAL**

Bidder must use the Department's electronic bidding software. The Bidder must download the bid file located on the Bid Express website ([www.bidx.com](http://www.bidx.com)) to prepare a bid packet for submission to the Department. The bidder must submit electronically using Bid Express.

### **JOINT VENTURE BIDDING**

Joint venture bidding is permissible. All companies in the joint venture must be prequalified in one of the work types in the Qualifications for Bidders for the project. The bidders must get a vendor ID for the joint venture from the Division of Construction Procurement and register the joint venture as a bidder on the project. Also, the joint venture must obtain a digital ID from Bid Express to submit a bid. A joint bid bond of 5% may be submitted for both companies or each company may submit a separate bond of 5%.

### **UNDERGROUND FACILITY DAMAGE PROTECTION**

The contractor shall make every effort to protect underground facilities from damage as prescribed in the Underground Facility Damage Protection Act of 1994, Kentucky Revised Statute KRS 367.4901 to 367.4917. It is the contractor's responsibility to determine and take steps necessary to be in compliance with federal and state damage prevention directives. When prescribed in said directives, the contractor shall submit Excavation Locate Requests to the Kentucky Contact Center (KY811) via web ticket entry. The submission of this request does not relieve the contractor from the responsibility of contacting non-member facility owners, whom shall be contacted through their individual Protection Notification Center. Non-compliance with these directives can result in the enforcement of penalties.

### **REGISTRATION WITH THE SECRETARY OF STATE BY A FOREIGN ENTITY**

Pursuant to KRS 176.085(1)(b), an agency, department, office, or political subdivision of the Commonwealth of Kentucky shall not award a state contract to a person that is a foreign entity required by [KRS 14A.9-010](#) to obtain a certificate of authority to transact business in the Commonwealth ("certificate") from the Secretary of State under [KRS 14A.9-030](#) unless the person produces the certificate within fourteen (14) days of the bid or proposal opening. If the foreign entity is not required to obtain a certificate as provided in [KRS 14A.9-010](#), the foreign entity should identify the applicable exception. Foreign entity is defined within [KRS 14A.1-070](#).

**For all foreign entities required to obtain a certificate of authority to transact business in the Commonwealth, if a copy of the certificate is not received by the contracting agency within the time frame identified above, the foreign entity's solicitation response shall be deemed non-responsive or the awarded contract shall be cancelled.**

Businesses can register with the Secretary of State at <https://secure.kentucky.gov/sos/ftbr/welcome.aspx>.

### **SPECIAL NOTE FOR PROJECT QUESTIONS DURING ADVERTISEMENT**

Questions about projects during the advertisement should be submitted in writing to the Division of Construction Procurement. This may be done by email to [kytc.projectquestions@ky.gov](mailto:kytc.projectquestions@ky.gov). The Department will attempt to answer all submitted questions. The Department reserves the right not to answer if the question is not pertinent or does not aid in clarifying the project intent.

The deadline for posting answers will be 3:00 pm Eastern Daylight Time, the day preceding the Letting. Questions may be submitted until this deadline with the understanding that the later a question is submitted, the less likely an answer will be able to be provided.

The questions and answers will be posted for each Letting under the heading "Questions & Answers" on the Construction Procurement website ([www.transportation.ky.gov/construction-procurement](http://www.transportation.ky.gov/construction-procurement)). The answers provided shall be considered part of this Special Note and, in case of a discrepancy, will govern over all other bidding documents.

### **HARDWOOD REMOVAL RESTRICTIONS**

The US Department of Agriculture has imposed a quarantine in Kentucky and several surrounding states, to prevent the spread of an invasive insect, the emerald ash borer. Hardwood cut in conjunction with the project may not be removed from the state. Chipping or burning on site is the preferred method of disposal.

### **INSTRUCTIONS FOR EXCESS MATERIAL SITES AND BORROW SITES**

Identification of excess material sites and borrow sites shall be the responsibility of the Contractor. The Contractor shall be responsible for compliance with all applicable state and federal laws and may wish to consult with the US Fish and Wildlife Service to seek protection under Section 10 of the Endangered Species Act for these activities.

### **ACCESS TO RECORDS**

The contractor, as defined in KRS 45A.030 (9) agrees that the contracting agency, the Finance and Administration Cabinet, the Auditor of Public Accounts, and the Legislative Research Commission, or their duly authorized representatives, shall have access to any books, documents, papers, records, or other evidence, which are directly pertinent to this contract for the purpose of financial audit or program review. Records and other prequalification information confidentially disclosed as part of the bid process shall not be deemed as directly pertinent to the contract and

shall be exempt from disclosure as provided in KRS 61.878(1)(c). The contractor also recognizes that any books, documents, papers, records, or other evidence, received during a financial audit or program review shall be subject to the Kentucky Open Records Act, KRS 61.870 to 61.884.

In the event of a dispute between the contractor and the contracting agency, Attorney General, or the Auditor of Public Accounts over documents that are eligible for production and review, the Finance and Administration Cabinet shall review the dispute and issue a determination, in accordance with Secretary's Order 11-004.

### **BOYCOTT PROVISIONS**

If applicable, the contractor represents that, pursuant to [KRS 45A.607](#), they are not currently engaged in, and will not for the duration of the contract engage in, the boycott of a person or an entity based in or doing business with a jurisdiction with which Kentucky can enjoy open trade. **Note:** The term Boycott does not include actions taken for bona fide business or economic reasons, or actions specifically required by federal or state law.

If applicable, the contractor verifies that, pursuant to KRS 41.480, they do not engage in, and will not for the duration of the contract engage in, in energy company boycotts as defined by KRS 41.472.

### **LOBBYING PROHIBITIONS**

The contractor represents that they, and any subcontractor performing work under the contract, have not violated the agency restrictions contained in [KRS 11A.236](#) during the previous ten (10) years, and pledges to abide by the restrictions set forth in such statute for the duration of the contract awarded.

The contractor further represents that, pursuant to [KRS 45A.328](#), they have not procured an original, subsequent, or similar contract while employing an executive agency lobbyist who was convicted of a crime related to the original, subsequent, or similar contract within five (5) years of the conviction of the lobbyist.

Revised: 2/29/2024

## **1.0 BUY AMERICA REQUIREMENT.**

Follow the “Buy America” provisions as required by 23 U.S.C. § 313 and 23 C.F.R. § 635.410. Except as expressly provided herein all manufacturing processes of steel or iron materials including but not limited to structural steel, guardrail materials, corrugated steel, culvert pipe, structural plate, prestressing strands, and steel reinforcing bars shall occur in the United States of America, including the application of:

- Coating,
- Galvanizing,
- Painting, and
- Other coating that protects or enhances the value of steel or iron products.

The following are exempt, unless processed or refined to include substantial amounts of steel or iron material, and may be used regardless of source in the domestic manufacturing process for steel or iron material:

- Pig iron,
- Processed, pelletized, and reduced iron ore material, or
- Processed alloys.

The Contractor shall submit a certification stating that all manufacturing processes involved with the production of steel or iron materials occurred in the United States.

Produce, mill, fabricate, and manufacture in the United States of America all aluminum components of bridges, tunnels, and large sign support systems, for which either shop fabrication, shop inspection, or certified mill test reports are required as the basis of acceptance by the Department.

Use foreign materials only under the following conditions:

- 1) When the materials are not permanently incorporated into the project; or
- 2) When the delivered cost of such materials used does not exceed 0.1 percent of the total Contract amount or \$2,500.00, whichever is greater.

The Contractor shall submit to the Engineer the origin and value of any foreign material used.

## **2.0 – BUILD AMERICA, BUY AMERICA (BABA)**

Contractor shall comply with the Federal Highway Administration (FHWA) Buy America Requirement in 23 C.F.R. § 635.410 and all relevant provisions of the Build America, Buy America Act (BABA), contained within the Infrastructure Investment and Jobs Act, Pub. L. No. 117-58, §§ 70901-52 enacted November 15, 2021. The BABA requires iron, steel, manufactured products, and construction materials used in infrastructure projects funded by federal financial assistance to be produced in the United States. Comply with 2 C.F.R § 184.

BABA permits FHWA participation in the Contract only if domestic steel and iron will be used on the Project. To be considered domestic, all steel and iron used, and all products manufactured from steel and iron must be produced in the United States and all manufacturing processes, including application of a coating, for these materials must occur in the United States. Coating includes all processes that protect or enhance the value of the material to which the coating is applied. This requirement does not preclude a minimal use of foreign steel and iron materials, provided the cost of such materials does not exceed 0.1% of the total contract amount under the Contract or \$2,500.00 whichever is greater.

BABA permits FHWA participation in the Contract only if all “construction materials” as defined in the Act are made in the United States. The Buy America preference applies to the following construction materials



SPECIAL NOTE – BUY AMERICA REQUIREMENTS AND BUILD  
AMERICA, BUY AMERICA (BABA) ACT

10/26/2023

incorporated into infrastructure projects: non-ferrous metals; plastic and polymer-based products (including polyvinylchloride, composite building materials, and polymers used in fiber optic cables); glass (including optic glass); Fiber optic cable; optical fiber; lumber; engineered wood; and drywall. Contractor will be required to use construction materials produced in the United States on this Project. The Contractor shall submit a certification stating that all construction materials are certified to be BABA compliant.

Finally, BABA permits the continuation of FHWA's current general applicability waivers for manufactured products, raw materials, and ferryboat parts, but these waivers are subject to reevaluation, specifically the general applicability waiver for manufactured products.

The Contractor has completed and submitted, or shall complete and submit, to the Cabinet a Buy America/Build America, Buy America Certificate prior to the Cabinet issuing the notice to proceed, in the format below. After submittal, the Contractor is bound by its original certification.

A false certification is a criminal act in violation of 18 U.S.C. § 1001. The Contractor has the burden of proof to establish that it is in compliance.

At the Contractor's request, the Cabinet may, but is not obligated to, seek a waiver of Buy America requirements if grounds for the waiver exist under 23 C.F.R. § 635.410(c) or will comply with the applicable Buy America requirements if a waiver of those requirements is not available or not pursued by the Cabinet.

Please refer to the Federal Highway Administration's Buy America webpage for more information.

[Buy America - Construction Program Guide - Contract Administration - Construction - Federal Highway Administration \(dot.gov\)](#)

October 26, 2023 Letting

SPECIAL NOTE – BUY AMERICA REQUIREMENTS AND BUILD AMERICA, BUY AMERICA (BABA) ACT

10/26/2023

**BUY AMERICA / BUILD AMERICA, BUY AMERICA (ACT) MATERIALS CERTIFICATE OF COMPLIANCE**

The Contractor hereby certifies that it will comply with all relevant provisions of the Build America, Buy America Act, contained within the Infrastructure Investment and Jobs Act, Pub. L. NO. 117-58, §§ 70901-52, the requirements of 23 U.S.C. § 313, 23 C.F.R. § 635.410 and 2 C.F.R § 184.

Date Submitted: \_\_\_\_\_

Contractor: \_\_\_\_\_

Signature: \_\_\_\_\_

Printed Name: \_\_\_\_\_

Title: \_\_\_\_\_

**NOTE: THIS CERTIFICATION IS IN ADDITION TO ANY AND ALL REQUIREMENTS OUTLINED IN THE CURRENT EDITION OF THE STANDARD SPECIFICATIONS FOR ROAD AND BRIDGE CONSTRUCTION AND/OR SPECIAL NOTES CONTAINED IN THE PROJECT PROPOSAL.**

## **SPECIAL NOTE FOR RECIPROCAL PREFERENCE**

### **RECIPROCAL PREFERENCE TO BE GIVEN BY PUBLIC AGENCIES TO RESIDENT BIDDERS**

By reference, KRS 45A.490 to 45A.494 are incorporated herein and in compliance regarding the bidders residency. Bidders who want to claim resident bidder status should complete the Affidavit for Claiming Resident Bidder Status along with their bid in the electronic bidding software. Submittal of the Affidavit should be done along the bid in Bid Express.

April 30, 2018

### **SURFACING AREAS**

The Department estimates the mainline surfacing width to be 22 feet.

The Department estimates the total mainline area to be surfaced to be 27,898 square yards.

The Department estimates the shoulder width to be varied 1 to 6 feet on each side.

The Department estimates the total shoulder area to be surfaced to be 3,720 square yards.

### **ASPHALT MIXTURE**

Unless otherwise noted, the Department estimates the rate of application for all asphalt mixtures to be 110 lbs/sy per inch of depth.

### **INCIDENTAL SURFACING**

The Department has included in the quantities of asphalt mixtures established in the proposal estimated quantities required for resurfacing or surfacing mailbox turnouts, farm field entrances, residential and commercial entrances, curve widening, ramp gores and tapers, and road and street approaches, as applicable. Pave these areas to the limits as shown on Standard Drawing RPM-110-06 or as directed by the Engineer. In the event signal detectors are present in the intersecting streets or roads, pave the crossroads to the right of way limit or back of the signal detector, whichever is the farthest back of the mainline. Surface or resurface these areas as directed by the Engineer. The Department will not measure placing and compacting for separate payment but shall be incidental to the Contract unit price for the asphalt mixtures.

### **OPTION B**

Be advised that the Department will control and accept compaction of asphalt mixtures furnished on this project under OPTION B in accordance with Sections 402 and 403.

## **SPECIAL NOTE FOR ELECTRONIC DELIVERY MANAGEMENT SYSTEM (e-Ticketing)**

This Special Note will apply when indicated on the plans or in the proposal. Section references herein are to the Department's Standard Specifications for Road and Bridge Construction current edition.

**1.0 DESCRIPTION.** Incorporate an e-Ticketing Delivery Software for weighed asphalt material delivered to the project to report loads and provide daily running totals of weighed asphalt material for pay items and incidental work during the construction processes from the point of measurement and loading to the point of incorporation to the project.

**2.0 MATERIALS AND EQUIPMENT.** Contractor shall supply material data in JavaScript Object Notation (JSON) documents to the KYTC e-Ticketing Delivery Software (KYTC e-Ticketing Portal) via Application Programming Interface (API) or direct connection. Test and verify that ticket data can be shared from the original source no fewer than 30 days prior to material placement activities. An e-Ticketing Delivery Software supplier can provide a qualified representative for on-site technical assistance during the initial setup, pre-construction verifications, and data management and processing as needed during the Project to maintain material data delivery capabilities. Virtual meetings may be hosted in lieu of on-site meetings when deemed appropriate by the Engineer.

Provide e-Ticketing Delivery Software that will meet the following:

1. The e-Ticketing Delivery Software shall be fully integrated with the Contractor's Load Read-Out scale system at the material source location.
2. The e-Ticketing Delivery Software shall provide real-time delivery to KYTC e-Ticketing Portal.
3. Transmit any updates to the ticket data within 5 minutes of a change.

**3.0 CONSTRUCTION.** Provide the Engineer with the manufacturer's specifications and all required documentation for data access at the pre-construction conference.

### **A. Construction Requirements**

1. Install and operate software in accordance with the manufacturer's specifications.
2. Verify that all pertinent information is provided by the software within the requirements of this Special Note.

### **B. Data Deliverables**

Provide to the Engineer a means in which to gather report summaries by way of iOS apps, web pages, or any other method at the disposal of the Engineer. The Engineer may request data at any time during the project.

#### **1. Asphalt Material**

##### **a. Real-time Continuous Data Items**

Provide the Engineer access to JSON documents capable of being transmitted through the KYTC's e-Ticketing Portal that displays the following information in real-time with a web-based system compatible with iOS and Windows environments.

- Each Truck
  - Supplier Name
  - Supplier Address
  - Supplier Phone
  - Plant location
  - Date
  - Time at source
  - Project Location

- Contract ID#
- Carrier Name
- Unique Truck ID
- Description of Material
- Mix Design Number
- Gross, Tare and Net Weight
- Weighmaster

**4.0 MEASUREMENT.** The Department will measure the electronic delivery management system as a lump sum item.

**5.0 PAYMENT.** The Department will make payment for the completed and accepted quantities under the following:

1. Payment is full compensation for all work associated with providing all required equipment, training, and documentation.
2. Payment will be full compensation for costs related to providing the e-Ticketing Delivery Software, including integration with plant load-out systems, and report viewing/exporting process. All quality control procedures including the software representative's technical support and on-site training shall be included in the Contract lump sum price.

<u>Code</u>	<u>Pay Item</u>	<u>Pay Unit</u>
26228EC	ELECTRONIC DELIVERY MGMT SYSTEM	LS

January 2024

## SPECIAL NOTE FOR PAVEMENT WEDGE AND SHOULDER MONOLITHIC OPERATION

**1.0 MATERIALS.** Provide an Asphalt Surface Mixture conforming to Section 403 of the Standard Specifications, as applicable to the project, for the pavement wedge.

**2.0 CONSTRUCTION.** Place the specified Asphalt Surface Mixture on shoulders monolithically with the driving lane. Prime the existing shoulder with tack material as the Engineer directs before placing the wedge. Construct according to Section 403.03 of the Standard Specifications.

Equip the paver with a modified screed that extends the full width of the wedge being placed and is tapered to produce a wedge. Obtain the Engineer's approval of the modified screed before placing shoulder wedge monolithically with the driving lane.

The wedge may vary in thickness at the edge of the milled area in the shoulder. If the area to receive the shoulder wedge is milled prior to placement, during rolling operations pinch the outside edge of the new inlay wedge to match the existing shoulder elevation not being resurfaced. Unless required otherwise by the Contract, construct rolled or sawed rumble strips according to Section 403.03.08, as applicable.

The following sketch is primarily for the computation of quantities; however, the wedge will result in a similar cross-section where sufficient width exists. Do not construct a shoulder for placing the wedge unless specified elsewhere in the Contract.

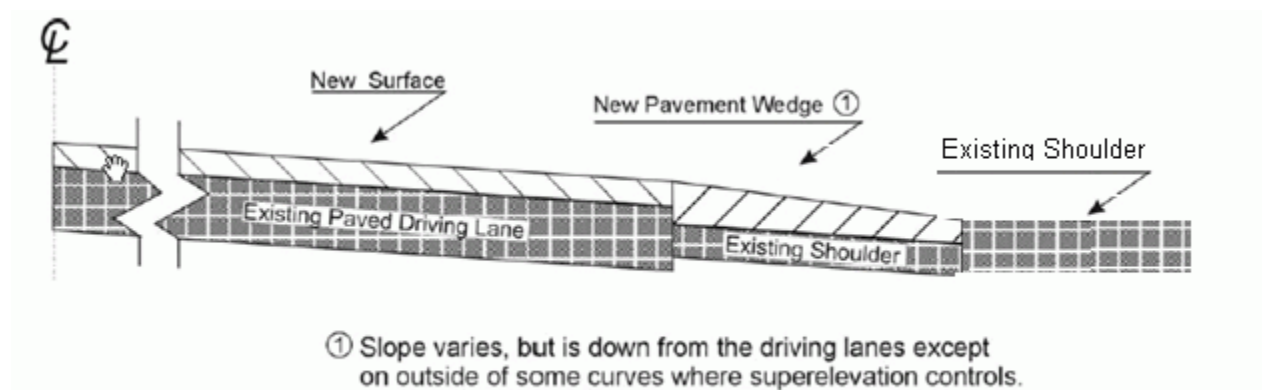

**3.0 MEASUREMENT.** The Department will measure Asphalt Surface Mixture placed as the pavement wedge according to Section 403.

**4.0 PAYMENT.** The Department will make payment for the completed and accepted quantities of Asphalt Surface Mixtures on pavement wedges according to Section 403.

### SPECIAL NOTE FOR EDGE KEY

Construct Edge Keys at the beginning of project, end of project, at railroad crossings, and at ramps, as applicable. Unless specified in the Contract or directed by the Engineer, do not construct edge keys at intersecting streets, roads, alleys, or entrances. Cut out the existing asphalt surface to the required depth and width shown on the drawing and heel the new surface into the existing surface. The Department will make payment for this work at the Contract unit price per ton for Asphalt Pavement Milling and Texturing, which shall be full compensation for all labor, materials, equipment, and incidentals for removal and disposal of the existing asphalt surface required to construct the edge key.

### EDGE KEY

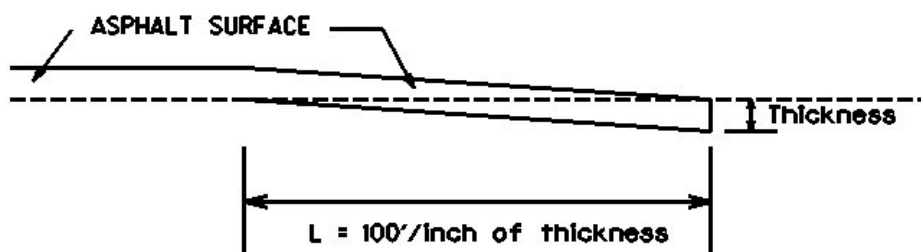

**Thickness = 1.0 Inches**

**L = 100 LF**

**L = Length of Edge Key**

1-3309 Edge key by Ton  
01/02//2012



**SPECIAL NOTE FOR  
ASPHALT MILLING AND TEXTURING**

Begin paving operations within **48 hours** of commencement of the milling operation. Continue paving operations continuously until completed. If paving operations are not begun within this time period, the Department will assess liquidated damages at the rate prescribed by Section 108.09 until such time as paving operations are begun.

Take possession of the millings and recycle the millings or dispose of the millings off the Right-of-Way at sites obtained by the Contractor at no additional cost to the Department.

1-3520 48 hours Contractor keeps millings  
01/2/2012

### **SPECIAL NOTE FOR TYPICAL SECTION DIMENSIONS**

Consider the dimensions shown on the typical sections for pavement and shoulder widths and thickness' to be nominal or typical dimensions. The Engineer may direct or approve varying the actual dimensions to be constructed to fit existing conditions. Do not widen existing pavement or shoulders unless specified elsewhere in this proposal or directed by the engineer.

1-3725 Typical Section Dimensions  
01/02/2012

## **TRAFFIC CONTROL PLAN**

---

### **TRAFFIC CONTROL GENERAL**

Except as provided herein, maintain and control traffic in accordance with the Standard and Supplemental Specifications and the Standard and Sepia Drawings, current editions. Except for the roadway and traffic control bid items listed, all items of work necessary to maintain and control traffic will be paid at the lump sum bid price to "Maintain and Control Traffic".

Contrary to Section 106.01, furnish new, or used in like new condition, traffic control devices at the beginning of the work and maintain in like new condition until completion of the work.

### **PROJECT PHASING & CONSTRUCTION PROCEDURES**

The Engineer may specify days and hours when lane closures will not be allowed.

Maintain alternating one way traffic during construction. Provide a minimum clear lane width of 10 feet; however, provide for passage of vehicles of up to 16 feet in width. If traffic should be stopped due to construction operations, and a school bus on an official run arrives on the scene, make provisions for the passage of the bus as quickly as possible.

### **LANE CLOSURES**

Do not leave lane closures in place during non-working hours.

### **SIGNS**

Sign posts and splices shall be compliant with NCHRP 350 or MASH. Manufacturer's documentation validating this compliance shall be provided to the Engineer prior to installation. Signs, including any splices, shall be installed according to manufacturer's specifications and installation recommendations. Contrary to section 112.04.02, only long-term signs (signs intended to be continuously in place for more than 3 days) will be measured for payment. Short-term signs (signs intended to be left in place for 3 days or less) will not be measured for payment but will be incidental to Maintain and Control Traffic.

### **CHANGEABLE MESSAGE SIGNS**

If deemed necessary by the Engineer, the Department will furnish, operate, and maintain Changeable Message Signs.

Traffic Control Plan  
Page 2 of 4

### **TEMPORARY ENTRANCES**

The Engineer will not require the Contractor to provide continuous access to farms, single family, duplex, or triplex residential properties during working hours; however, provide reasonable egress and ingress to each such property when actual operations are not in progress at that location. Limit the time during which a farm or residential entrance is blocked to the minimum length of time required for actual operations, not extended for the Contractor's convenience, and in no case exceeding six (6) hours. Notify all residents twenty-four hours in advance of any driveway or entrance closings and make any accommodations necessary to meet the access needs of disabled residents.

Except as allowed by the Phasing as specified above, maintain direct access to all side streets and roads, schools, churches, commercial properties and apartments or apartment complexes of four or more units at all times.

The Department will measure asphalt materials required to construct and maintain any temporary entrances which may be necessary to provide temporary access; however, the Department will not measure aggregates, excavation, and/or embankment, but shall be incidental to Maintain and Control Traffic. The Engineer will determine the type of surfacing material, asphalt or aggregate, to be used at each entrance.

### **THERMOPLASTIC INTERSECTION MARKINGS**

Consider the locations listed on the summary as approximate only. Prior to milling and/or resurfacing, locate and document the locations of the existing markings. After resurfacing, replace the markings at their approximate existing locations or as directed by Engineer. Place markings not existing prior to resurfacing as directed by the Engineer.

### **BARRICADES**

The Department will not measure barricades used in lieu of barrels and cones for channelization or delineation, but shall be incidental to Maintain and Control Traffic according to Section 112.04.01.

The Department will measure barricades used to protect pavement removal areas in individual units Each. The Department will measure for payment the maximum number of barricades in concurrent use at the same time on a single day on all sections of the contract. The Department will measure individual barricades only once for payment, regardless of how many times they are set, reset, removed, and relocated during the duration of the project. The Department will not measure replacements for damaged barricades the Engineer directs to be replaced due to poor condition or reflectivity. Retain possession of the Barricades upon completion of construction.

Traffic Control Plan  
Page 3 of 4

## **PAVEMENT MARKINGS**

If there is to be a deviation from the existing striping plan, the Engineer will furnish the Contractor a striping plan prior to placement of the final surface course.

Install Temporary Striping according to Section 112 with the following exception:

If the Contractor's operations or phasing requires temporary markings that must subsequently be removed from the final surface course, use an approved removable lane tape; however, the Department will not measure removable lane tape for separate payment, but will measure and pay for removable lane tape as temporary striping.

## **PAVEMENT EDGE DROP-OFFS**

Do not allow a pavement edge between opposing directions of traffic or lanes that traffic is expected to cross in a lane change situation with an elevation difference greater than 1½". Place Warning signs (MUTCD W8-11 or W8-9A) in advance of and at 1500' intervals throughout the drop-off area. Dual post the signs on both sides of the traveled way. Wedge all transverse transitions between resurfaced and unresurfaced areas which traffic may cross with asphalt mixture for leveling and wedging. Remove the wedges prior to placement of the final surface course.

Protect pavement edges that traffic is not expected to cross, except accidentally, as follows:

Less than 2" - No protection required.

2" to 4" - Place plastic drums, vertical panels, or barricades every 50 feet. During daylight working hours only, the Engineer will allow the Contractor to use cones in lieu of plastic drums, panels, and barricades. Wedge the drop-off with DGA or asphalt mixture for leveling and wedging with a 1:1 or flatter slope in daylight hours, or 3:1 or flatter slope during nighttime hours, when work is not active in the drop-off area.

Greater than 4" - Protect drop-offs greater than 4 inches within 10 feet of traffic by placing drums, vertical panels, or barricades every 25 feet. The Engineer will not allow the use of cones in lieu of drums, vertical panels, or barricades for drop-offs greater than 4". Place Type III Barricades directly in front of the drop-off facing on coming traffic in both directions of travel. Provide warning signs as shown on the Standard Drawings or as directed by the Engineer

Pedestrians & Bicycles - Protect pedestrian and bicycle traffic as directed by the

Traffic Control Plan  
Page 4 of 4

engineer.

**DURABLE PAVEMENT EDGE DETAIL**

(Resurfacing adjacent to fill slope or ditch foreslope that is 3:1 or less)

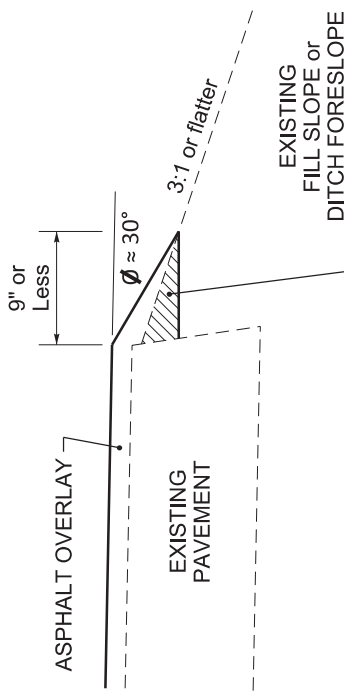

PREPARE SHOULDER ACCORDING TO STANDARD SPECIFICATIONS

**DURABLE PAVEMENT EDGE DETAIL**

(Resurfacing adjacent to low shoulder with dropoff of 5 inches or less)

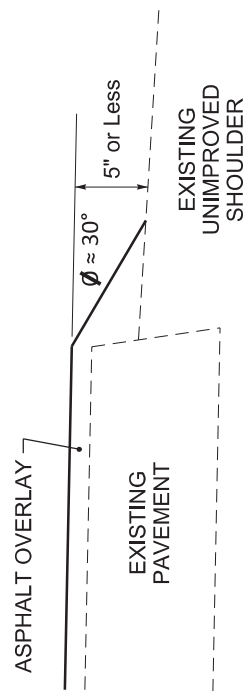

**DURABLE PAVEMENT EDGE DETAIL**

(Resurfacing adjacent to low shoulder with dropoff of more than 5 inches)

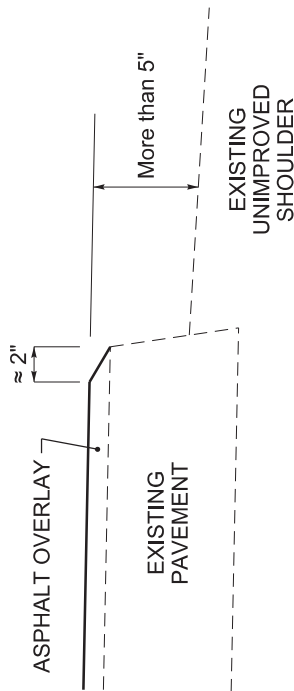

**DURABLE PAVEMENT EDGE DETAIL**

(Resurfacing adjacent to an obstruction, such as an existing headwall)

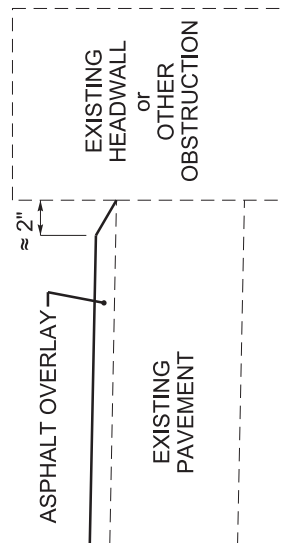

**DURABLE PAVEMENT EDGE DETAIL**

(Resurfacing adjacent to fill slope or ditch foreslope that is steeper than 3:1)

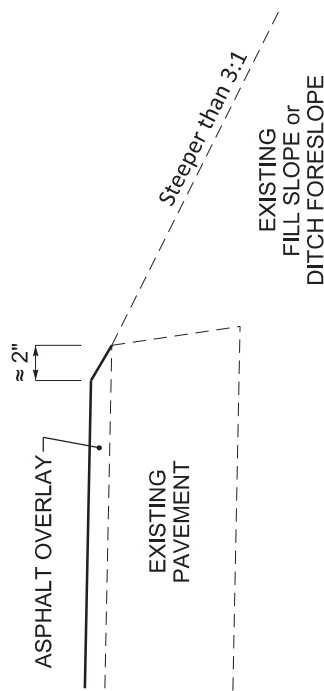

**NOTES**

1. DETAILS DO NOT APPLY TO OVERLAYS LESS THAN 1 INCH THICK.
2. THE DURABLE PAVEMENT EDGE DEVICE MAY BE DISENGAGED AT DRIVEWAYS, SIDE STREETS, HIGH SHOULDERS, AND OTHER LOCATIONS NOT FEASIBLE TO CONSTRUCT, AS APPROVED BY THE ENGINEER.

DRAWING NOT TO SCALE

DURABLE PAVEMENT EDGE DETAILS

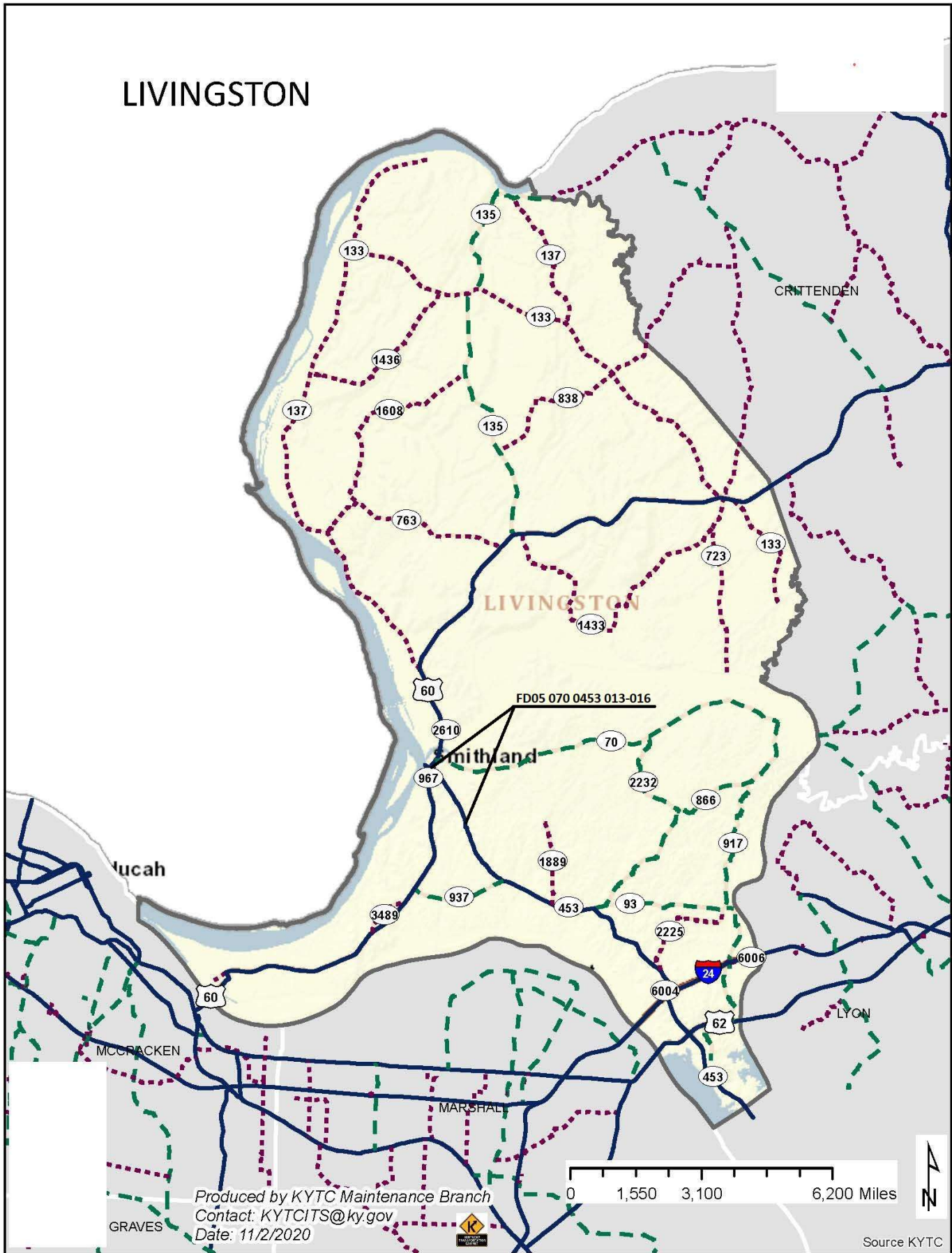







**Crittenden County  
TYPICAL SECTION  
FD05 070 0453 013-016  
MP's 13.854 to 15.819**

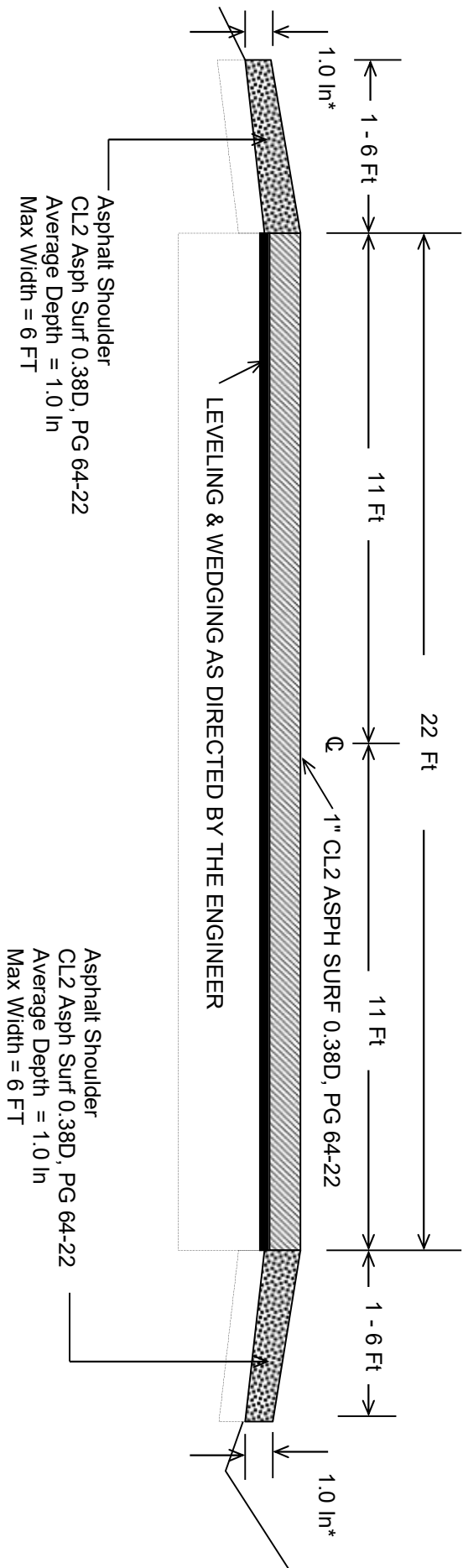

**\* Where Existing Site Conditions Permit**

### BRIDGE DETAIL FOR PAVING PROJECT

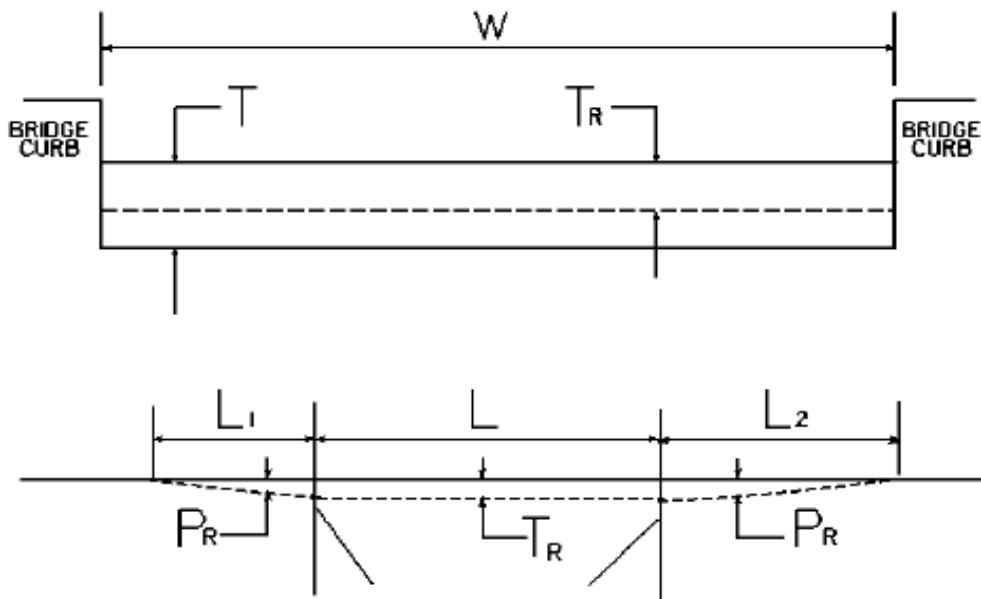

$W$  = bridge width curb to curb  
 $T$  = thickness of existing asphalt overlay  
 $L$  = length of bridge  
 $L_1$  &  $L_2$  = length of approach pavement to be removed  
 $T_R$  = thickness to be removed and replaced on bridge  
 $P_R$  = thickness to be removed and replaced on pavement  
 Note:  $L_1$  &  $L_2$  lengths shall be determined by using a transition rate of 100 ft/in of thickness

Route	Bridge No.	MP	W (ft)	T (in)	L <sub>1</sub> (ft)	L <sub>2</sub> (ft)	T <sub>R</sub> (in)	L (ft)	P <sub>R</sub> (in)
KY 453	B00083N	14.170	34.000		000.00	000.00	0.00	40.00	1.00

01/01/2009

**PART II**  
**SPECIFICATIONS AND STANDARD DRAWINGS**

### **STANDARD SPECIFICATIONS**

Any reference in the plans or proposal to previous editions of the *Standard Specifications for Road and Bridge Construction* and *Standard Drawings* are superseded by *Standard Specifications for Road and Bridge Construction, Edition of 2019* and *Standard Drawings, Edition of 2020*.

### **SUPPLEMENTAL SPECIFICATIONS**

The contractor shall use the Supplemental Specifications that are effective at the time of letting. The Supplemental Specifications can be found at the following link:  
<http://transportation.ky.gov/Construction/Pages/Kentucky-Standard-Specifications.aspx>

## 2020 KENTUCKY STANDARD DRAWINGS

---

CURVE WIDENING AND SUPERELEVATION TRANSITIONS .....	RGS-001-07
SUPERELEVATION FOR MULTILANE PAVEMENT .....	RGS-002-06
MISCELLANEOUS STANDARDS .....	RGX-001-06
APPROACHES, ENTRANCES, AND MAIL BOX TURNOUT .....	RPM-110-07
LANE CLOSURE TWO-LANE HIGHWAY .....	TTC-100-05
SHOULDER CLOSURE .....	TTC-135-03
PAVEMENT CONDITION WARNING SIGNS.....	TTD-125-02
MOBILE OPERATION FOR PAINT STRIPING CASE I.....	TTS-100-02
MOBILE OPERATION FOR PAINT STRIPING CASE II.....	TTS-105-02
SHOULDER & EDGELINE RUMBLE STRIPS PLACEMENT DETAILS .....	TPR-115
EDGELINE RUMBLE STRIP DETAILS TWO LANE ROADWAYS .....	TPR-120

## **PART III**

### **EMPLOYMENT, WAGE AND RECORD REQUIREMENTS**



**TRANSPORTATION CABINET  
DEPARTMENT OF HIGHWAYS**

**LABOR AND WAGE REQUIREMENTS  
APPLICABLE TO OTHER THAN FEDERAL-AID SYSTEM PROJECTS**

- I. Application
- II. Nondiscrimination of Employees (KRS 344)

**I. APPLICATION**

1. These contract provisions shall apply to all work performed on the contract by the contractor with his own organization and with the assistance of workmen under his immediate superintendence and to all work performed on the contract by piecework, station work or by subcontract. The contractor's organization shall be construed to include only workmen employed and paid directly by the contractor and equipment owned or rented by him, with or without operators.

2. The contractor shall insert in each of his subcontracts all of the stipulations contained in these Required Provisions and such other stipulations as may be required.

3. A breach of any of the stipulations contained in these Required Provisions may be grounds for termination of the contract.

3. If the contractor is in control of apprenticeship or other training or retraining, including on-the-job training programs, he shall not discriminate against an individual because of his race, color, religion, national origin, sex, disability or age forty (40) and over, in admission to, or employment in any program established to provide apprenticeship or other training.

4. The contractor will send to each labor union or representative of workers with which he has a collective bargaining agreement or other contract or understanding, a notice to be provided advising the said labor union or workers' representative of the contractor's commitments under this section, and shall post copies of the notice in conspicuous places available to employees and applicants for employment. The contractor will take such action with respect to any subcontract or purchase order as the administrating agency may direct as a means of enforcing such provisions, including sanctions for non-compliance.

Revised: January 25, 2017

**II. NONDISCRIMINATION OF EMPLOYEES**

**AN ACT OF THE KENTUCKY  
GENERAL ASSEMBLY TO PREVENT  
DISCRIMINATION IN EMPLOYMENT  
KRS CHAPTER 344  
EFFECTIVE JUNE 16, 1972**

The contract on this project, in accordance with KRS Chapter 344, provides that during the performance of this contract, the contractor agrees as follows:

1. The contractor shall not fail or refuse to hire, or shall not discharge any individual, or otherwise discriminate against an individual with respect to his compensation, terms, conditions, or privileges of employment, because of such individual's race, color, religion, national origin, sex, disability or age (forty and above); or limit, segregate, or classify his employees in any way which would deprive or tend to deprive an individual of employment opportunities or otherwise adversely affect his status as an employee, because of such individual's race, color, religion, national origin, sex, disability or age forty (40) and over. The contractor agrees to post in conspicuous places, available to employees and applicants for employment, notices to be provided setting forth the provisions of this nondiscrimination clause.

2. The contractor shall not print or publish or cause to be printed or published a notice or advertisement relating to employment by such an employer or membership in or any classification or referral for employment by the employment agency, indicating any preference, limitation, specification, or discrimination, based on race, color, religion, national origin, sex, or age forty (40) and over, or because the person is a qualified individual with a disability, except that such a notice or advertisement may indicate a preference, limitation, or specification based on religion, national origin, sex, or age forty (40) and over, or because the person is a qualified individual with a disability, when religion, national origin, sex, or age forty (40) and over, or because the person is a qualified individual with a disability, is a bona fide occupational qualification for employment.

## EXECUTIVE BRANCH CODE OF ETHICS

In the 1992 regular legislative session, the General Assembly passed and Governor Brereton Jones signed Senate Bill 63 (codified as KRS 11A), the Executive Branch Code of Ethics, which states, in part:

KRS 11A.040 (7) provides:

No present or former public servant shall, within six (6) months following termination of his office or employment, accept employment, compensation, or other economic benefit from any person or business that contracts or does business with, or is regulated by, the state in matters in which he was directly involved during the last thirty-six (36) months of his tenure. This provision shall not prohibit an individual from returning to the same business, firm, occupation, or profession in which he was involved prior to taking office or beginning his term of employment, or for which he received, prior to his state employment, a professional degree or license, provided that, for a period of six (6) months, he personally refrains from working on any matter in which he was directly involved during the last thirty-six (36) months of his tenure in state government. This subsection shall not prohibit the performance of ministerial functions, including but not limited to filing tax returns, filing applications for permits or licenses, or filing incorporation papers, nor shall it prohibit the former officer or public servant from receiving public funds disbursed through entitlement programs.

KRS 11A.040 (9) states:

A former public servant shall not represent a person or business before a state agency in a matter in which the former public servant was directly involved during the last thirty-six (36) months of his tenure, for a period of one (1) year after the latter of:

- a) The date of leaving office or termination of employment; or
- b) The date the term of office expires to which the public servant was elected.

This law is intended to promote public confidence in the integrity of state government and to declare as public policy the idea that state employees should view their work as a public trust and not as a way to obtain private benefits.

If you have worked for the executive branch of state government within the past six months, you may be subject to the law's prohibitions. The law's applicability may be different if you hold elected office or are contemplating representation of another before a state agency.

Also, if you are affiliated with a firm which does business with the state and which employs former state executive-branch employees, you should be aware that the law may apply to them.

In case of doubt, the law permits you to request an advisory opinion from the Executive Branch Ethics Commission, 1025 Capital Center Drive, Suite 104, Frankfort, Kentucky 40601; telephone (502) 564-7954.

Revised: May 23, 2022

### **Kentucky Equal Employment Opportunity Act of 1978**

The requirements of the Kentucky Equal Employment Opportunity Act of 1978 (KRS 45.560-45.640) shall apply to this Contract. The apparent low Bidder will be required to submit EEO forms to the Division of Construction Procurement, which will then forward to the Finance and Administration Cabinet for review and approval. No award will become effective until all forms are submitted and EEO/CC has certified compliance. The required EEO forms are as follows:

- EEO-1: Employer Information Report
- Affidavit of Intent to Comply
- Employee Data Sheet
- Subcontractor Report

These forms are available on the Finance and Administration's web page under ***Vendor Information, Standard Attachments and General Terms*** at the following address:  
**<https://www.eProcurement.ky.gov>**.

Bidders currently certified as being in compliance by the Finance and Administration Cabinet may submit a copy of their approval letter in lieu of the referenced EEO forms.

For questions or assistance please contact the Finance and Administration Cabinet by email at **[finance.contractcompliance@ky.gov](mailto:finance.contractcompliance@ky.gov)** or by phone at 502-564-2874.

# EMPLOYEE RIGHTS UNDER THE FAIR LABOR STANDARDS ACT

THE UNITED STATES DEPARTMENT OF LABOR WAGE AND HOUR DIVISION

## FEDERAL MINIMUM WAGE

# \$7.25 PER HOUR

BEGINNING JULY 24, 2009

**OVERTIME PAY** At least 1½ times your regular rate of pay for all hours worked over 40 in a workweek.

**CHILD LABOR** An employee must be at least **16** years old to work in most non-farm jobs and at least **18** to work in non-farm jobs declared hazardous by the Secretary of Labor.

Youths **14** and **15** years old may work outside school hours in various non-manufacturing, non-mining, non-hazardous jobs under the following conditions:

**No more than**

- **3** hours on a school day or **18** hours in a school week;
- **8** hours on a non-school day or **40** hours in a non-school week.

Also, work may not begin before **7 a.m.** or end after **7 p.m.**, except from June 1 through Labor Day, when evening hours are extended to **9 p.m.** Different rules apply in agricultural employment.

**TIP CREDIT** Employers of “tipped employees” must pay a cash wage of at least \$2.13 per hour if they claim a tip credit against their minimum wage obligation. If an employee’s tips combined with the employer’s cash wage of at least \$2.13 per hour do not equal the minimum hourly wage, the employer must make up the difference. Certain other conditions must also be met.

**ENFORCEMENT** The Department of Labor may recover back wages either administratively or through court action, for the employees that have been underpaid in violation of the law. Violations may result in civil or criminal action.

Employers may be assessed civil money penalties of up to \$1,100 for each willful or repeated violation of the minimum wage or overtime pay provisions of the law and up to \$11,000 for each employee who is the subject of a violation of the Act’s child labor provisions. In addition, a civil money penalty of up to \$50,000 may be assessed for each child labor violation that causes the death or serious injury of any minor employee, and such assessments may be doubled, up to \$100,000, when the violations are determined to be willful or repeated. The law also prohibits discriminating against or discharging workers who file a complaint or participate in any proceeding under the Act.

### ADDITIONAL INFORMATION

- Certain occupations and establishments are exempt from the minimum wage and/or overtime pay provisions.
- Special provisions apply to workers in American Samoa and the Commonwealth of the Northern Mariana Islands.
- Some state laws provide greater employee protections; employers must comply with both.
- The law requires employers to display this poster where employees can readily see it.
- Employees under 20 years of age may be paid \$4.25 per hour during their first 90 consecutive calendar days of employment with an employer.
- Certain full-time students, student learners, apprentices, and workers with disabilities may be paid less than the minimum wage under special certificates issued by the Department of Labor.

For additional information:



# 1-866-4-USWAGE

(1-866-487-9243)

TTY: 1-877-889-5627



# WWW.WAGEHOUR.DOL.GOV

**PART IV**  
**INSURANCE**

Refer to  
*Kentucky Standard Specifications for Road and Bridge Construction,*  
current edition

**PART V**  
**BID ITEMS**

## PROPOSAL BID ITEMS

242173

Page 1 of 1

Report Date 6/13/24

### Section: 0001 - PAVING

LINE	BID CODE	ALT	DESCRIPTION	QUANTITY	UNIT	UNIT PRIC	FP	AMOUNT
0010	00190		LEVELING & WEDGING PG64-22	420.00	TON		\$	
0020	00301		CL2 ASPH SURF 0.38D PG64-22	1,750.00	TON		\$	
0030	00356		ASPHALT MATERIAL FOR TACK	19.00	TON		\$	
0040	02562		TEMPORARY SIGNS	300.00	SQFT		\$	
0050	02650		MAINTAIN & CONTROL TRAFFIC	1.00	LS		\$	
0060	02676		MOBILIZATION FOR MILL & TEXT	1.00	LS		\$	
0070	02677		ASPHALT PAVE MILLING & TEXTURING	15.00	TON		\$	
0080	02697		EDGE LINE RUMBLE STRIPS	12,007.00	LF		\$	
0090	06510		PAVE STRIPING-TEMP PAINT-4 IN	21,000.00	LF		\$	
0100	06515		PAVE STRIPING-PERM PAINT-6 IN	42,000.00	LF		\$	
0110	06568		PAVE MARKING-THERMO STOP BAR-24IN	44.00	LF		\$	
0120	26228EC		ELECTRONIC DELIVERY MGMT SYSTEM	1.00	LS		\$	

### Section: 0002 - DEMOBILIZATION

LINE	BID CODE	ALT	DESCRIPTION	QUANTITY	UNIT	UNIT PRIC	FP	AMOUNT
0130	02569		DEMOBILIZATION	1.00	LS		\$	