



CALL NO. 308

CONTRACT ID. 202302

MCCREARY COUNTY

FED/STATE PROJECT NUMBER FD05 074 0090 007-012

DESCRIPTION CUMBERLAND FALLS ROAD (KY 90)

WORK TYPE ASPHALT RESURFACING

PRIMARY COMPLETION DATE 6/30/2021

LETTING DATE: November 20,2020

Sealed Bids will be received electronically through the Bid Express bidding service until 10:00 am EASTERN STANDARD TIME November 20,2020. Bids will be publicly announced at 10:00 am EASTERN STANDARD TIME.

NO PLANS ASSOCIATED WITH THIS PROJECT.

DEFERRED PAYMENT

REQUIRED BID PROPOSAL GUARANTY: Not less than 5% of the total bid.

TABLE OF CONTENTS

PART I	SCOPE OF WORK
	<ul style="list-style-type: none">• PROJECT(S), COMPLETION DATE(S), & LIQUIDATED DAMAGES• CONTRACT NOTES• STATE CONTRACT NOTES• DEFERRED PAYMENT• SURFACING AREAS• ASPHALT MIXTURE• INCIDENTAL SURFACING• FUEL AND ASPHALT PAY ADJUSTMENT• COMPACTION OPTION B• SPECIAL NOTE(S) APPLICABLE TO PROJECT• WASTE AND BORROW SITES• ASPHALT MIX PAVEMENT WEDGE MONOLITHIC OPERATION• EDGE KEY (BY TON)• ASPHALT MILLING AND TEXTURING• BASE FAILURE REPAIR• TYPICAL SECTION DIMENSIONS• TRAFFIC CONTROL PLAN 2 LANE• DURABLE PAVEMENT EDGE DETAILS• SKETCH MAP(S)• SUMMARY SHEET(S)• TYPICAL SECTION(S)• BRIDGE DETAIL FOR PAVING PROJECT
PART II	SPECIFICATIONS AND STANDARD DRAWINGS
	<ul style="list-style-type: none">• SPECIFICATIONS REFERENCE• SUPPLEMENTAL SPECIFICATION• 2020 STANDARD DRAWINGS THAT APPLY
PART III	EMPLOYMENT, WAGE AND RECORD REQUIREMENTS
	<ul style="list-style-type: none">• LABOR AND WAGE REQUIREMENTS• EXECUTIVE BRANCH CODE OF ETHICS• KENTUCKY EQUAL EMPLOYMENT OPPORTUNITY ACT OF 1978 LOCALITY / STATE• PROJECT WAGE RATES / STATE FUNDED
PART IV	INSURANCE
PART V	BID ITEMS

PART I
SCOPE OF WORK

ADMINISTRATIVE DISTRICT - 08

CONTRACT ID - 202302

FD05 074 0090 007-012

COUNTY - MCCREARY

PCN - MP07400902002

FD05 074 0090 007-012

CUMBERLAND FALLS ROAD (KY 90) (MP 7.002) BEGINNING AT KY 896 EXTENDING EAST TO THE MCCREARY - WHITLEY COUNTY LINE. (MP 11.920), A DISTANCE OF 04.91 MILES.ASPHALT RESURFACING
GEOGRAPHIC COORDINATES LATITUDE 36:50:09.50 LONGITUDE 84:20:26.00

COMPLETION DATE(S):

COMPLETED BY 06/30/2021

APPLIES TO ENTIRE CONTRACT

CONTRACT NOTES

PROPOSAL ADDENDA

All addenda to this proposal must be applied when calculating bid and certified in the bid packet submitted to the Kentucky Department of Highways. Failure to use the correct and most recent addenda may result in the bid being rejected.

BID SUBMITTAL

Bidder must use the Department's electronic bidding software. The Bidder must download the bid file located on the Bid Express website (www.bidx.com) to prepare a bid packet for submission to the Department. The bidder must submit electronically using Bid Express.

JOINT VENTURE BIDDING

Joint venture bidding is permissible. All companies in the joint venture must be prequalified in one of the work types in the Qualifications for Bidders for the project. The bidders must get a vendor ID for the joint venture from the Division of Construction Procurement and register the joint venture as a bidder on the project. Also, the joint venture must obtain a digital ID from Bid Express to submit a bid. A joint bid bond of 5% may be submitted for both companies or each company may submit a separate bond of 5%.

UNDERGROUND FACILITY DAMAGE PROTECTION

The contractor shall make every effort to protect underground facilities from damage as prescribed in the Underground Facility Damage Protection Act of 1994, Kentucky Revised Statute KRS 367.4901 to 367.4917. It is the contractor's responsibility to determine and take steps necessary to be in compliance with federal and state damage prevention directives. When prescribed in said directives, the contractor shall submit Excavation Locate Requests to the Kentucky Contact Center (KY811) via web ticket entry. The submission of this request does not relieve the contractor from the responsibility of contacting non-member facility owners, whom shall be contacted through their individual Protection Notification Center. Non-compliance with these directives can result in the enforcement of penalties.

REGISTRATION WITH THE SECRETARY OF STATE BY A FOREIGN ENTITY

Pursuant to KRS 176.085(1)(b), an agency, department, office, or political subdivision of the Commonwealth of Kentucky shall not award a state contract to a person that is a foreign entity required by [KRS 14A.9-010](#) to obtain a certificate of authority to transact business in the Commonwealth ("certificate") from the Secretary of State under [KRS 14A.9-030](#) unless the person produces the certificate within fourteen (14) days of the bid or proposal opening. If the foreign entity is not required to obtain a certificate as provided in [KRS 14A.9-010](#), the foreign entity should identify the applicable exception. Foreign entity is defined within [KRS 14A.1-070](#).

For all foreign entities required to obtain a certificate of authority to transact business in the Commonwealth, if a copy of the certificate is not received by the contracting agency within the time frame identified above, the foreign entity's solicitation response shall be deemed non-responsive or the awarded contract shall be cancelled.

Businesses can register with the Secretary of State at <https://secure.kentucky.gov/sos/ftbr/welcome.aspx>.

SPECIAL NOTE FOR PROJECT QUESTIONS DURING ADVERTISEMENT

Questions about projects during the advertisement should be submitted in writing to the Division of Construction Procurement. This may be done by fax (502) 564-7299 or email to kytc.projectquestions@ky.gov. The Department will attempt to answer all submitted questions. The Department reserves the right not to answer if the question is not pertinent or does not aid in clarifying the project intent.

The deadline for posting answers will be 3:00 pm Eastern Daylight Time, the day preceding the Letting. Questions may be submitted until this deadline with the understanding that the later a question is submitted, the less likely an answer will be able to be provided.

The questions and answers will be posted for each Letting under the heading "Questions & Answers" on the Construction Procurement website (www.transportation.ky.gov/contract). The answers provided shall be considered part of this Special Note and, in case of a discrepancy, will govern over all other bidding documents.

HARDWOOD REMOVAL RESTRICTIONS

The US Department of Agriculture has imposed a quarantine in Kentucky and several surrounding states, to prevent the spread of an invasive insect, the emerald ash borer. Hardwood cut in conjunction with the project may not be removed from the state. Chipping or burning on site is the preferred method of disposal.

INSTRUCTIONS FOR EXCESS MATERIAL SITES AND BORROW SITES

Identification of excess material sites and borrow sites shall be the responsibility of the Contractor. The Contractor shall be responsible for compliance with all applicable state and federal laws and may wish to consult with the US Fish and Wildlife Service to seek protection under Section 10 of the Endangered Species Act for these activities.

ACCESS TO RECORDS

The contractor, as defined in KRS 45A.030 (9) agrees that the contracting agency, the Finance and Administration Cabinet, the Auditor of Public Accounts, and the Legislative Research Commission, or their duly authorized representatives, shall have access to any books, documents, papers, records, or other evidence, which are directly pertinent to this contract for the purpose of financial audit or program review. Records and other prequalification information confidentially

disclosed as part of the bid process shall not be deemed as directly pertinent to the contract and shall be exempt from disclosure as provided in KRS 61.878(1)(c). The contractor also recognizes that any books, documents, papers, records, or other evidence, received during a financial audit or program review shall be subject to the Kentucky Open Records Act, KRS 61.870 to 61.884.

In the event of a dispute between the contractor and the contracting agency, Attorney General, or the Auditor of Public Accounts over documents that are eligible for production and review, the Finance and Administration Cabinet shall review the dispute and issue a determination, in accordance with Secretary's Order 11-004.

April 30, 2018

SPECIAL NOTE FOR RECIPROCAL PREFERENCE

RECIPROCAL PREFERENCE TO BE GIVEN BY PUBLIC AGENCIES TO RESIDENT BIDDERS

By reference, KRS 45A.490 to 45A.494 are incorporated herein and in compliance regarding the bidders residency. Bidders who want to claim resident bidder status should complete the Affidavit for Claiming Resident Bidder Status along with their bid in the electronic bidding software. Submittal of the Affidavit should be done along the bid in Bid Express.

April 30, 2018

DEFERRED PAYMENT

The Department will issue a work order with the distinct understanding that payment for any Pay Estimates may be delayed until January 31, 2021.

SURFACING AREAS

The Department estimates the mainline surfacing width to be 22 feet.

The Department estimates the total mainline area to be surfaced to be 66,649 square yards.

The Department estimates the shoulder width to be 1 foot on each side.

The Department estimates the total shoulder area to be surfaced to be 5,770 square yards.

ASPHALT MIXTURE

Unless otherwise noted, the Department estimates the rate of application for all asphalt mixtures to be 110 lbs/sy per inch of depth.

INCIDENTAL SURFACING

The Department has included in the quantities of asphalt mixtures established in the proposal estimated quantities required for resurfacing or surfacing mailbox turnouts, farm field entrances, residential and commercial entrances, curve widening, ramp gores and tapers, and road and street approaches, as applicable. Pave these areas to the limits as shown on Standard Drawing RPM-110-06 or as directed by the Engineer. In the event signal detectors are present in the intersecting streets or roads, pave the crossroads to the right of way limit or back of the signal detector, whichever is the farthest back of the mainline. Surface or resurface these areas as directed by the Engineer. The Department will not measure placing and compacting for separate payment but shall be incidental to the Contract unit price for the asphalt mixtures.

FUEL AND ASPHALT PAY ADJUSTMENT

The Department has included the Contract items Asphalt Adjustment and Fuel Adjustment for possible future payments at an established Contract unit price of \$1.00. The Department will calculate actual adjustment quantities after work is completed. If existing Contract amount is insufficient to pay all items on the contract with the adjustments, the Department will establish additional monies with a change order.

OPTION B

Be advised that the Department will control and accept compaction of asphalt mixtures furnished on this project under OPTION B in accordance with Sections 402 and 403.

SPECIAL NOTE FOR EXPERIMENTAL KYCT AND HAMBURG TESTING

1.0 General

1.1 Description. The KYCT (Kentucky Method for Cracking Test) and the Hamburg test results will help determine if the mixture is susceptible to cracking and rutting. During the experimental phase, data will be gathered and analyzed by the Department to determine the durability of the bituminous mixes. Additionally, the data will help the Department to create future performance based specifications which will include the KYCT and Hamburg test methods.

2.0 Equipment

2.1 KYCT Testing Equipment. The Department will require a Marshall Test Press with digital recordation capabilities. Other CT testing equipment may be used for testing with prior approval by the Department.

2.2 Water Baths. One or more water baths will be required that can maintain a temperature of 77• +/- 1.8° F with a digital thermometer showing the water bath temperature. Also, one water bath shall have the ability to suspend gyratory specimen fully submerged in water in accordance with AASHTO T-166, current edition.

2.3 Hamburg Wheel Track Testing. The department encourages the use of the PTI APA/Hamburg Jr. test equipment to perform the loaded wheel testing. The Department will allow different equipment for the Hamburg testing, but the testing device must be approved by the Department prior to testing.

2.4 Gyratory Molds. Gyratory molds will be required to assist in the production of gyratory specimens in accordance with AASHTO T-312, current edition.

2.5 Ovens. Adequate (minimum of two ovens) will be required to accommodate the additional molds and asphalt mixture necessary to perform the acceptance testing as outlined in Section 402 of the Kentucky Standard Specifications for Road and Bridge Construction, current edition.

2.6 Department Equipment. The Department will provide gyratory molds, PINE 850 Test Press with digital recordation, and CT testing equipment to assist during this experimental phase so data can be gathered. Hamburg test specimens will be submitted to the Division of Materials for testing on the PTI APA/Hamburg Jr if the asphalt contractor or district materials office does not have an approved Hamburg testing device.

3.0 Testing Requirements

3.1 Acceptance Testing. Perform all acceptance testing and aggregate gradation as according with Section 402 and Section 403 of the Kentucky Standard Specifications for Road and Bridge Construction, current edition.

3.2 KYCT Testing. Perform crack resistance analysis (KYCT) in accordance with the current Kentucky Method for KYCT Index Testing during the mix design phase and during the plant production of all surface mixtures. For mix design approvals, submit KYCT results on the Department MixPack. For Class 4 mixtures, submit ingredient materials to the Division of Materials for informational verification.

3.2.1 KYCT Frequency. Obtain an adequate sample of hot mix asphalt to insure the acceptance testing, gradation, and KYCT gyratory samples can be fabricated and is representative of the bituminous

mixture. Acceptance specimens shall be fabricated first, then immediately after, fabricate the KYCT samples with the gyratory compactor in accordance with Section 2.4 of this Special Note. Analysis of the KYCT specimens and gradation will be required one per subplot produced from the same asphalt material and at the same time as the acceptance specimen is sampled and tested.

3.2.2 Number of Specimens and Conditioning. Fabricate specimens in accordance with the Kentucky Method for KYCT Index Testing. Contrary to the method, fabricate a minimum of 3 and up to 6 test specimens. The specimens shall be compacted at the temperature in accordance to KM 64-411. KYCT mix design specimens shall be short-term conditioned for four hours at compaction temperature in accordance to KM 64-411. Contrary to the Kentucky Method, plant produced bituminous material shall be short-term conditioned immediately after sampling for two hours at compaction temperature in accordance to KM 64-411. Additionally, fabricated specimens shall be allowed to cool in air (fan is permissible) for 30 minutes +/- 5 minutes and conditioned in a 77 °F water bath for 30 minutes +/- 5 minutes. To insure confidence and reliability of the test results provided by KYCT testing and Hamburg testing, reheating of the asphalt mixture is prohibited.

3.2.3 Record Times. For each subplot, record the time required between drying aggregates in the plant to KYCT specimen fabrication. The production time may vary due to the time that the bituminous material is held in the silo. Record the preconditioning time when the time exceeds the one hour specimen cool down time as required in accordance to The Kentucky Method for KYCT Index Testing. The preconditioning time may exceed an hour if the technician is unable to complete the test on the same day or within the specified times as outlined in The Kentucky Method for KYCT Index Testing. The production time and the preconditioning time shall be recorded on the AMAW.

3.2.4 File Name. As according to section 7.12 of The Kentucky Method for KYCT Index Testing, save the filename with the following format; "CID_Approved Mix Number_Lot Number_Sublot Number_Date"

3.3 Hamburg Testing. Perform the rut resistance analysis (Hamburg) in accordance to AASTHO T-324, not to exceed 20,000 passes for all bituminous mixtures during the mix design phase and production. For mix design approvals, submit Hamburg results on the Department MixPack. For Class 4 mixtures, submit ingredient materials to the Division of Materials for informational verification.

3.3.1 Hamburg Testing Frequency. Perform testing and analysis per lot of material. The plant produced bituminous material sampled for the Hamburg test does not have to be obtained at the same time as the acceptance and KYCT sample. If the Hamburg test sample is not obtained at the same time as the KYCT sample, determine the Maximum Specific Gravity of the KYCT sample in accordance with AASTHO T-209 coinciding with the Hamburg specimens.

3.3.2 Record Times. Record the production time as according to section 3.2.3 in this special note. Also record the time that the specimens were fabricated and the time the Hamburg testing was started. All times shall be recorded on the AMAW.

3.3.3 File Name. Save the Excel spreadsheet with the following file name; "Hamburg_CID_Approved Mix Number_Lot Number_Sublot Number_Date" and upload the file into the AMAW.

4.0 Data

Submit the AMAW and all test data that was obtained for acceptance, gradation, KYCT, and Hamburg testing within five working days once all testing has been completed for a lot to Central Materials Lab and the District Materials Engineer. Also, any data and or comments that the asphalt contractor or district personnel deem informational during this experimental phase, shall also be submitted to the Central Materials Lab and the District Materials Engineer. Any questions or comments regarding any item in this Special Note can be directed to the Central Office, Division of Materials, Asphalt Branch.

5.0 KYCT Video Demonstration

<https://www.youtube.com/watch?v=84j0bM45-hg&feature=youtu.be>

6.0 Payment

Any additional labor and testing equipment that is required to fabricate and test the KYCT and Hamburg specimens shall be considered to be incidental to the asphalt surface line item. The Department will perform the testing for the KYCT and Hamburg specimens if a producer does not possess the proper equipment.

June 3, 2019

SPECIAL NOTE FOR NON-TRACKING TACK COAT

1. DESCRIPTION AND USEAGE. This specification covers the requirements and practices for applying a non-tracking tack asphalt coating. Place this material on the existing pavement course, prior to placement of a new asphalt pavement layer. Use when expedited paving is necessary or when asphalt tracking would negatively impact the surrounding area. This material is not suitable for other uses. Ensure material can "break" within 15 minutes under conditions listed in 3.2.

2. MATERIALS, EQUIPMENT, AND PERSONNEL.

2.1 Non-Tracking Tack. Provide material conforming to Subsection 2.1.1.

2.1.1 Provide a tack conforming to the following material requirements:

Property	Specification	Test Procedure
Viscosity, SFS, 77 • F	20 – 100	AASHTO T 72
Sieve, %	0.3 max.	AASHTO T 59
Asphalt Residue ¹ , %	50 min.	AASHTO T 59
Oil Distillate, %	1.0 max.	AASHTO T 59
Residue Penetration, 77 • F	20 max.	AASHTO T 49
Original Dynamic Shear (G*/sin δ), 82 • C	1.0 min.	AASHTO T 315
Softening Point, • F	149 min.	AASHTO T 53
Solubility, %	97.5 min.	AASHTO T 44

¹ Bring sample to 212 •F over a 10-15 minute period. Maintain 212 •F for 15-20 minutes or until 30-40 mL of water has distilled. Continue distillation as specified in T59.

2.2. Equipment. Provide a distributor truck capable of heating, circulating, and spraying the tack between 170 •F and 180 •F. Do not exceed 180 •F. Circulate the material while heating. Provide the correct nozzles that is recommend by the producer to ensure proper coverage of tack is obtained. Ensure the bar can be raised to between 14” and 18” from the roadway.

2.3. Personnel. Ensure the tack supplier has provided training to the contractor on the installation procedures for this product. Make a technical representative from the supplier available at the request of the Engineer.

3. CONSTRUCTION.

3.1 Surface Preparation. Prior to the application of the non-tracking tack, ensure the pavement surface is thoroughly dry and free from dust or any other debris that would inhibit adhesion. Clean the surface by scraping, sweeping, and the use of compressed air. Ensure this preparation process occurs shortly before application to prevent the return of debris pavement. If rain is expected within one hour after application, do not apply material. Apply material only when the surface is dry, and no precipitation is expected.

3.2 Non-tracking Tack Application. Ensure the roadway temperature is a minimum of 40 °F and rising during the application of the tack. This material is not suitable for use in colder temperatures. Prior to applying the tack, demonstrate competence in applying the tack according to this note to the satisfaction of the Engineer. Heat the tack in the distributor to between 170 – 180 °F. After initial heating to between 170 – 180 °F, the material may be sprayed between 165 °F and 180 °F. Do not apply outside this temperature range. Apply material at a minimum rate of 0.70 pounds (0.08 gallons) per square yard. Ensure full coverage of the material on the pavement surface. Full coverage of this material is critical. If full coverage is not achieved, material application rate may be increased to ensure full coverage. Do not heat material more than twice in one day.

3.3 Non-tracking Tack Certification. Furnish the tacks certification to the Engineer stating the material conforms to all requirements herein prior to use.

3.4 Sampling and Testing. The Department will require a sample of non-tracking tack be taken from the distributor at a rate of one sample per 15,000 tons of mix. Take two 1 gallon samples of the heated material and forward the sample to the Division of Materials for testing within 7 days. Ensure the product temperature is between 170 and 180 °F at the time of sampling.

4. MEASUREMENT. The Department will measure the quantity of non-tracking tack in tons. The Department will not measure for payment any extra materials, labor, methods, equipment, or construction techniques used to satisfy the requirements of this note. The Department will not measure for payment any trial applications of non-tracking tack, the cleaning of the pavement surface, or furnishing and placing the adhesive. The Department will consider all such items incidental to the non-tracking tack.

5. PAYMENT. The Department will pay for the non-tracking tack at the Contract unit bid price and apply an adjustment for each manufacturer's lot of material based on the degree of compliance as defined in the following schedule. When a sample fails on two or more tests, the Department may add the deductions, but the total deduction will not exceed 100 percent.

Non-Tracking Tack Price Adjustment Schedule						
Test	Specification	100% Pay	90% Pay	80% Pay	50% Pay	0% Pay
Viscosity, SFS, 77 • F	20 – 100	19 - 102	17 - 18 103 - 105	15 - 16 106 - 107	14 108 - 109	≤13 ≥ 110
Sieve, %	0.30 max.	• 0.40	0.41 - 0.50	0.51 - 0.60	0.61 - 0.70	≥ 0.71
Asphalt Residue, %	50 min.	• 49.0	48.5 – 48.9	48.0 – 48.4	47.5-47.9	≤ 47.4
Oil Distillate, %	1.0 max.	• 1.0	1.1-1.5	1.6 - 1.7	1.8-1.9	>2.0
Residue Penetration, 77 ° F	20 max.	• 21	22 - 23	24 - 25	26 - 27	≥ 28
Original Dynamic Shear (G*/sin δ), 82 • C	1.0 min.	• 0.95	0.92 – 0.94	0.90 – 0.91	0.85 - 0.89	≤ 0.84
Softening Point, ° F	149 min.	• 145	142 - 144	140 - 141	138 - 139	≤ 137
Solubility, %	97.5 min.	≥ 97.0	96.8 – 96.9	96.6 – 96.7	96.4 – 96.5	≤ 96.3

<u>Code</u>	<u>Pay Item</u>	<u>Pay Unit</u>
24970EC	Asphalt Material for Tack Non-Tracking	Ton

January 28, 2020

SPECIAL PROVISION FOR WASTE AND BORROW SITES

Obtain U.S. Army Corps of Engineer's approval before utilizing a waste or borrow site that involves "Waters of the United States". The Corps of Engineers defines "Waters of the United States" as perennial or intermittent streams, ponds or wetlands. The Corps of Engineers also considers ephemeral streams, typically dry except during rainfall but having a defined drainage channel, to be jurisdictional waters. Direct questions concerning any potential impacts to "Waters of the United States" to the attention of the appropriate District Office for the Corps of Engineers for a determination prior to disturbance. Be responsible for any fees associated with obtaining approval for waste and borrow sites from the U.S. Army Corps of Engineer or other appropriate regulatory agencies.

1-296 Waste & Borrow Sites
01/02/2012

SPECIAL NOTE FOR PAVEMENT WEDGE AND SHOULDER MONOLITHIC OPERATION

1.0 MATERIALS. Provide an Asphalt Surface Mixture conforming to Section 403 of the Standard Specifications, as applicable to the project, for the pavement wedge.

2.0 CONSTRUCTION. Place the specified Asphalt Surface Mixture on shoulders monolithically with the driving lane. Prime the existing shoulder with tack material as the Engineer directs before placing the wedge. Construct according to Section 403.03 of the Standard Specifications.

Equip the paver with a modified screed that extends the full width of the wedge being placed and is tapered to produce a wedge. Obtain the Engineer's approval of the modified screed before placing shoulder wedge monolithically with the driving lane.

The wedge may vary in thickness at the edge of the milled area in the shoulder. If the area to receive the shoulder wedge is milled prior to placement, during rolling operations pinch the outside edge of the new inlay wedge to match the existing shoulder elevation not being resurfaced. Unless required otherwise by the Contract, construct rolled or sawed rumble strips according to Section 403.03.08, as applicable.

The following sketch is primarily for the computation of quantities; however, the wedge will result in a similar cross-section where sufficient width exists. Do not construct a shoulder for placing the wedge unless specified elsewhere in the Contract.

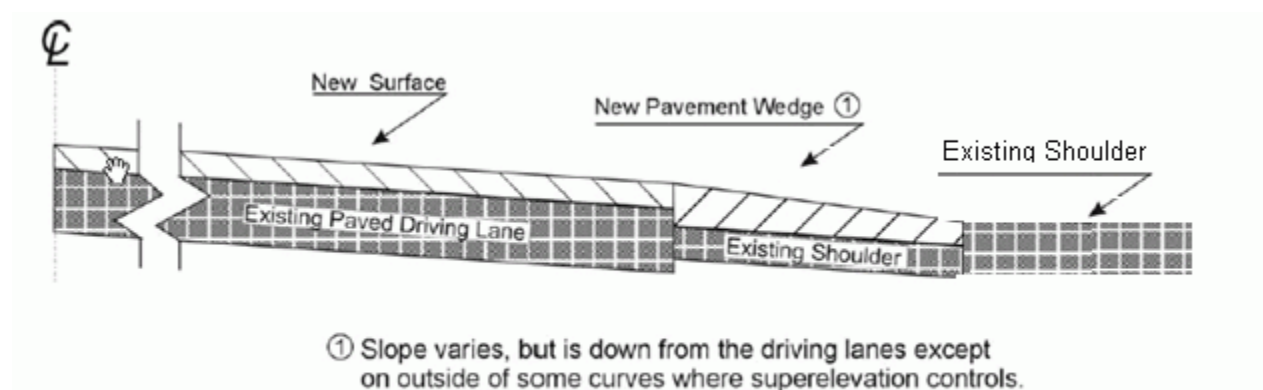

3.0 MEASUREMENT. The Department will measure Asphalt Surface Mixture placed as the pavement wedge according to Section 403.

4.0 PAYMENT. The Department will make payment for the completed and accepted quantities of Asphalt Surface Mixtures on pavement wedges according to Section 403.

SPECIAL NOTE FOR EDGE KEY

Construct Edge Keys at the beginning of project, end of project, at railroad crossings, and at ramps, as applicable. Unless specified in the Contract or directed by the Engineer, do not construct edge keys at intersecting streets, roads, alleys, or entrances. Cut out the existing asphalt surface to the required depth and width shown on the drawing and heel the new surface into the existing surface. The Department will make payment for this work at the Contract unit price per ton for Asphalt Pavement Milling and Texturing, which shall be full compensation for all labor, materials, equipment, and incidentals for removal and disposal of the existing asphalt surface required to construct the edge key.

EDGE KEY

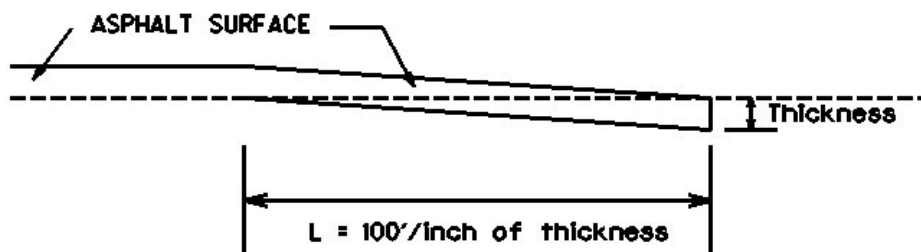

Thickness = 1 Inch

L = 100 LF

L= Length of Edge Key

1-3309 Edge key by Ton
01/02//2012

**SPECIAL NOTE FOR
ASPHALT MILLING AND TEXTURING**

Begin paving operations within **48 hours** of commencement of the milling operation. Continue paving operations continuously until completed. If paving operations are not begun within this time period, the Department will assess liquidated damages at the rate prescribed by Section 108.09 until such time as paving operations are begun.

Take possession of the millings and recycle the millings or dispose of the millings off the Right-of-Way at sites obtained by the Contractor at no additional cost to the Department.

1-3520 48 hours Contractor keeps millings
01/2/2012

SPECIAL NOTE FOR BASE FAILURE REPAIR

Repair locations listed on the summary are approximate only. The Engineer will determine actual repair locations and dimensions at the time of construction. Prior to overall milling and/or leveling and wedging, excavate the designated base failure areas to a depth 6 inches below the existing asphalt pavement surface level. Dispose of the excavated materials at waste sites off the Right-of-Way obtained by the Contractor at no additional cost to the Department. See Special Note for Waste and Borrow.

Backfill the excavated areas with Class 2 Asphalt Base 1.00D PG64-22. Compact the asphalt base to the compaction required in Section 403.03.10. Seal the asphalt base with leveling and wedging. Perform all base failure repairs in such a manner that removal and replacement are completed on the same day. Do this work as one of the Contractor's first operations in order to allow further compaction by traffic. Do not mill or place new asphalt surface over repaired base failure areas until a minimum of 7 calendar days have elapsed after placement of the asphalt base. After a minimum of 7 calendar days and when the Engineer determines the base failure repair areas have sufficiently stabilized, begin milling and/or resurfacing operations. Prior to milling and/or constructing the new asphalt surface, level and wedge any settlement of the repair areas.

The bidder must draw conclusions as to the conditions encountered. The Department does not give any guarantee as to the accuracy of the data and will not consider any claim for additional compensation if the materials encountered that are not in accord with the classification shown.

Accept payment at the Contract unit prices per square yard for Base Failure repair and per ton for Leveling and Wedging as full compensation for all labor, materials, equipment, and incidentals for removing pavement and disposing of the materials, furnishing and placing asphalt base, leveling and wedging, and all other items necessary to complete the work according to these notes to the satisfaction of the Engineer.

1-3606basefailurerepairmillinlaypaybysy
01/02/2012

SPECIAL NOTE FOR TYPICAL SECTION DIMENSIONS

Consider the dimensions shown on the typical sections for pavement and shoulder widths and thickness' to be nominal or typical dimensions. The Engineer may direct or approve varying the actual dimensions to be constructed to fit existing conditions. Do not widen existing pavement or shoulders unless specified elsewhere in this proposal or directed by the engineer.

1-3725 Typical Section Dimensions
01/02/2012

TRAFFIC CONTROL PLAN

TRAFFIC CONTROL GENERAL

Except as provided herein, maintain and control traffic in accordance with the Standard and Supplemental Specifications and the Standard and Sepia Drawings, current editions. Except for the roadway and traffic control bid items listed, all items of work necessary to maintain and control traffic will be paid at the lump sum bid price to "Maintain and Control Traffic".

Contrary to Section 106.01, furnish new, or used in like new condition, traffic control devices at the beginning of the work and maintain in like new condition until completion of the work.

PROJECT PHASING & CONSTRUCTION PROCEDURES

The Engineer may specify days and hours when lane closures will not be allowed.

Maintain alternating one way traffic during construction. Provide a minimum clear lane width of 10 feet; however, provide for passage of vehicles of up to 16 feet in width. If traffic should be stopped due to construction operations, and a school bus on an official run arrives on the scene, make provisions for the passage of the bus as quickly as possible.

LANE CLOSURES

Do not leave lane closures in place during non-working hours.

SIGNS

Sign posts and splices shall be compliant with NCHRP 350 or MASH. Manufacturer's documentation validating this compliance shall be provided to the Engineer prior to installation. Signs, including any splices, shall be installed according to manufacturer's specifications and installation recommendations. Contrary to section 112.04.02, only long-term signs (signs intended to be continuously in place for more than 3 days) will be measured for payment. Short-term signs (signs intended to be left in place for 3 days or less) will not be measured for payment but will be incidental to Maintain and Control Traffic.

CHANGEABLE MESSAGE SIGNS

If deemed necessary by the Engineer, the Department will furnish, operate, and maintain Changeable Message Signs.

Traffic Control Plan
Page 2 of 3

TEMPORARY ENTRANCES

The Engineer will not require the Contractor to provide continuous access to farms, single family, duplex, or triplex residential properties during working hours; however, provide reasonable egress and ingress to each such property when actual operations are not in progress at that location. Limit the time during which a farm or residential entrance is blocked to the minimum length of time required for actual operations, not extended for the Contractor's convenience, and in no case exceeding six (6) hours. Notify all residents twenty-four hours in advance of any driveway or entrance closings and make any accommodations necessary to meet the access needs of disabled residents.

Except as allowed by the Phasing as specified above, maintain direct access to all side streets and roads, schools, churches, commercial properties and apartments or apartment complexes of four or more units at all times.

The Department will measure asphalt materials required to construct and maintain any temporary entrances which may be necessary to provide temporary access; however, the Department will not measure aggregates, excavation, and/or embankment, but shall be incidental to Maintain and Control Traffic. The Engineer will determine the type of surfacing material, asphalt or aggregate, to be used at each entrance.

THERMOPLASTIC INTERSECTION MARKINGS

Consider the locations listed on the summary as approximate only. Prior to milling and/or resurfacing, locate and document the locations of the existing markings. After resurfacing, replace the markings at their approximate existing locations or as directed by Engineer. Place markings not existing prior to resurfacing as directed by the Engineer.

BARRICADES

The Department will not measure barricades used in lieu of barrels and cones for channelization or delineation, but shall be incidental to Maintain and Control Traffic according to Section 112.04.01.

The Department will measure barricades used to protect pavement removal areas in individual units Each. The Department will measure for payment the maximum number of barricades in concurrent use at the same time on a single day on all sections of the contract. The Department will measure individual barricades only once for payment, regardless of how many times they are set, reset, removed, and relocated during the duration of the project. The Department will not measure replacements for damaged barricades the Engineer directs to be replaced due to poor condition or reflectivity. Retain possession of the Barricades upon completion of construction.

PAVEMENT MARKINGS

Traffic Control Plan
Page 3 of 3

If there is to be a deviation from the existing striping plan, the Engineer will furnish the Contractor a striping plan prior to placement of the final surface course.

Install Temporary Striping according to Section 112 with the following exception:

If the Contractor's operations or phasing requires temporary markings that must subsequently be removed from the final surface course, use an approved removable lane tape; however, the Department will not measure removable lane tape for separate payment, but will measure and pay for removable lane tape as temporary striping.

PAVEMENT EDGE DROP-OFFS

Do not allow a pavement edge between opposing directions of traffic or lanes that traffic is expected to cross in a lane change situation with an elevation difference greater than 1½". Place Warning signs (MUTCD W8-11 or W8-9A) in advance of and at 1500' intervals throughout the drop-off area. Dual post the signs on both sides of the traveled way. Wedge all transverse transitions between resurfaced and unresurfaced areas which traffic may cross with asphalt mixture for leveling and wedging. Remove the wedges prior to placement of the final surface course.

Protect pavement edges that traffic is not expected to cross, except accidentally, as follows:

Less than 2" - No protection required.

2" to 4" - Place plastic drums, vertical panels, or barricades every 50 feet. During daylight working hours only, the Engineer will allow the Contractor to use cones in lieu of plastic drums, panels, and barricades. Wedge the drop-off with DGA or asphalt mixture for leveling and wedging with a 1:1 or flatter slope in daylight hours, or 3:1 or flatter slope during nighttime hours, when work is not active in the drop-off area.

Greater than 4" - Protect drop-offs greater than 4 inches within 10 feet of traffic by placing drums, vertical panels, or barricades every 25 feet. The Engineer will not allow the use of cones in lieu of drums, vertical panels, or barricades for drop-offs greater than 4". Place Type III Barricades directly in front of the drop-off facing on coming traffic in both directions of travel. Provide warning signs as shown on the Standard Drawings or as directed by the Engineer

Pedestrians & Bicycles - Protect pedestrian and bicycle traffic as directed by the engineer.

DURABLE PAVEMENT EDGE DETAIL

(Resurfacing adjacent to fill slope or ditch foreslope that is 3:1 or less)

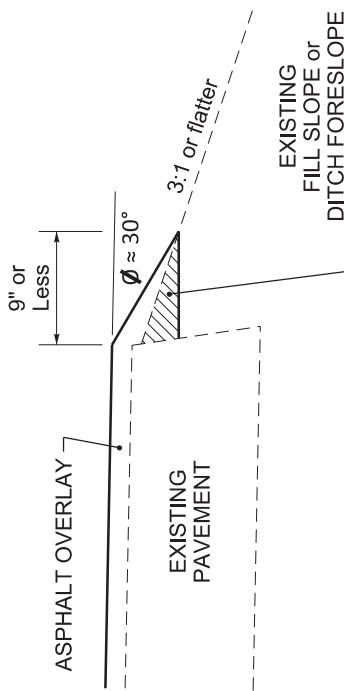

PREPARE SHOULDER ACCORDING TO STANDARD SPECIFICATIONS

DURABLE PAVEMENT EDGE DETAIL

(Resurfacing adjacent to fill slope or ditch foreslope that is steeper than 3:1)

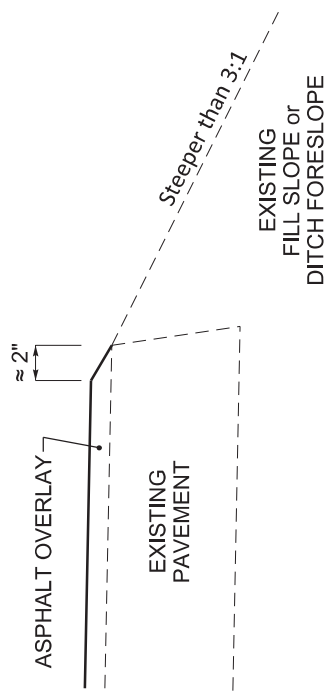

NOTES

1. DETAILS DO NOT APPLY TO OVERLAYS LESS THAN 1 INCH THICK.
2. THE DURABLE PAVEMENT EDGE DEVICE MAY BE DISENGAGED AT DRIVEWAYS, SIDE STREETS, HIGH SHOULDERS, AND OTHER LOCATIONS NOT FEASIBLE TO CONSTRUCT, AS APPROVED BY THE ENGINEER.

DURABLE PAVEMENT EDGE DETAILS

DRAWING NOT TO SCALE

DURABLE PAVEMENT EDGE DETAIL

(Resurfacing adjacent to low shoulder with dropoff of 5 inches or less)

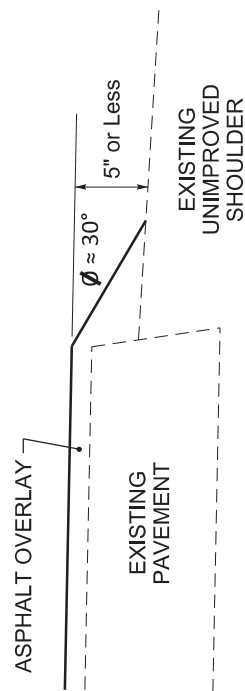

DURABLE PAVEMENT EDGE DETAIL

(Resurfacing adjacent to low shoulder with dropoff of more than 5 inches)

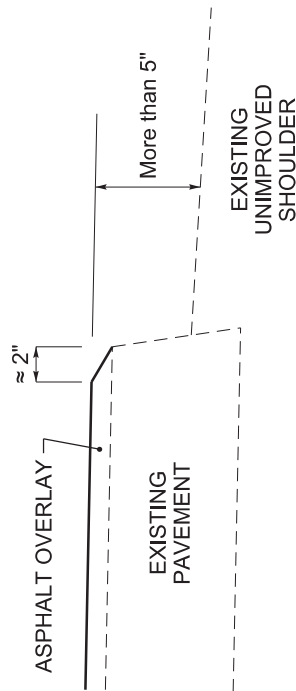

DURABLE PAVEMENT EDGE DETAIL

(Resurfacing adjacent to an obstruction, such as an existing headwall)

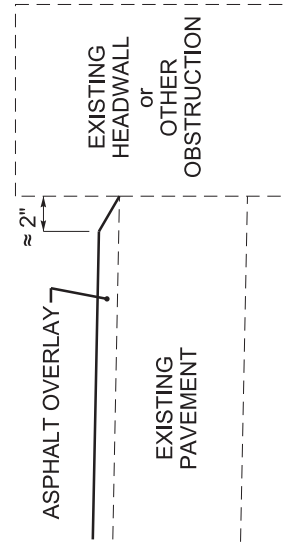

MCCREARY COUNTY

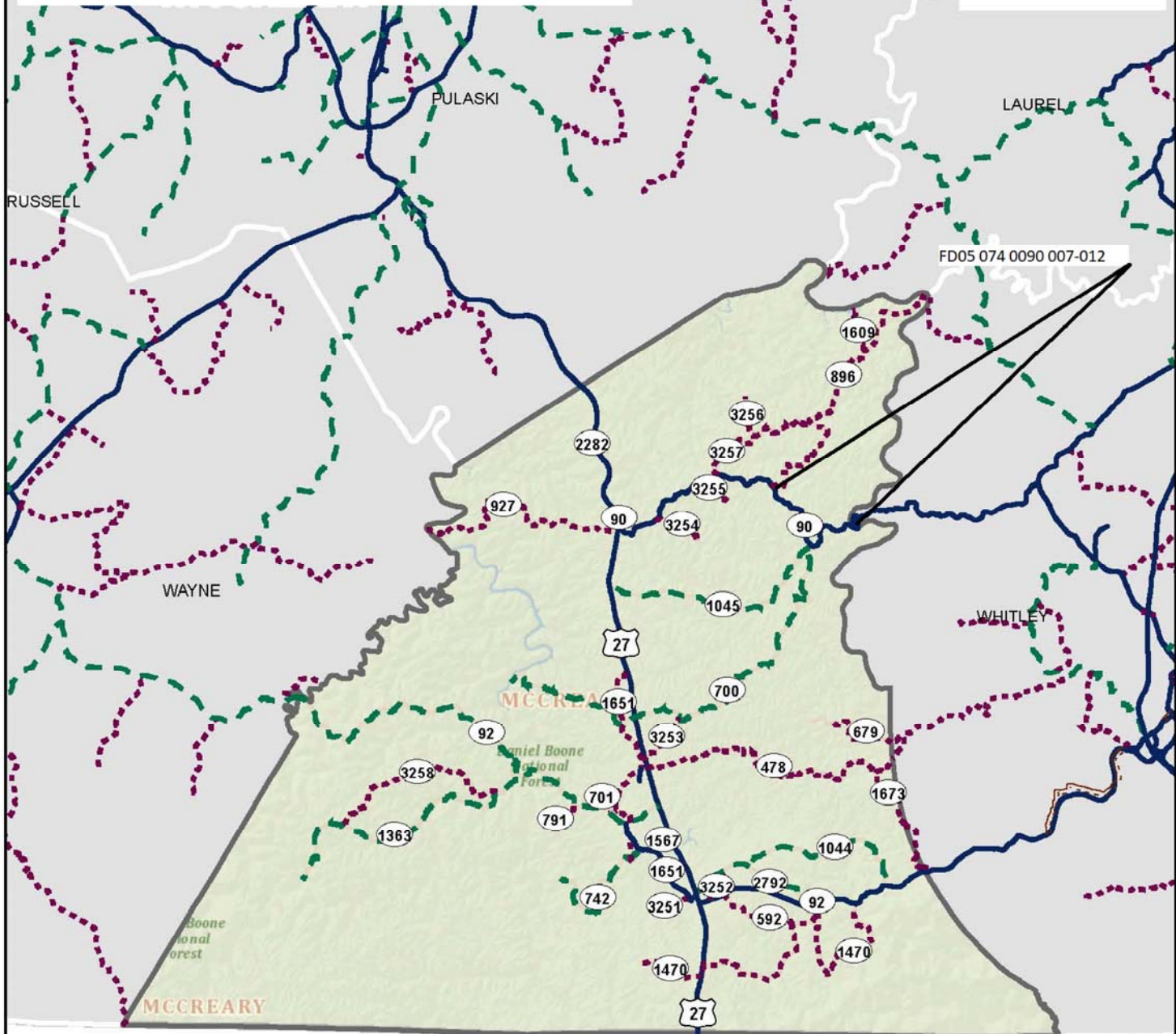

Produced by KYTC Maintenance Branch
Contact: KYTCITS@ky.gov
Date: 11/5/2019

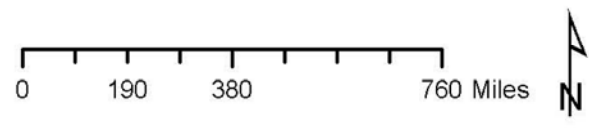

Source KYTC

**MCCREARY County
TYPICAL SECTION
FD05 074 0090 007-012
MP's 7.002 to 11.920**

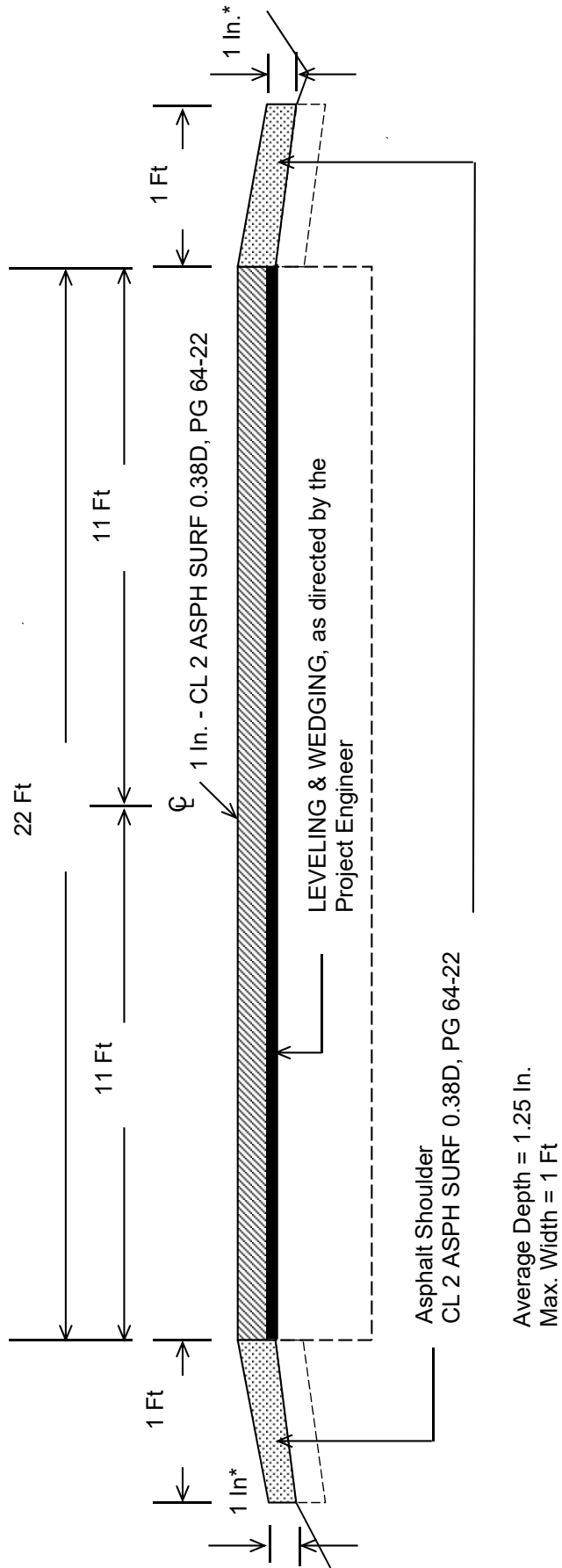

***Where Existing Site Conditions Permit**

PART II
SPECIFICATIONS AND STANDARD DRAWINGS

SPECIFICATIONS REFERENCE

Any reference in the plans or proposal to previous editions of the *Standard Specifications for Road and Bridge Construction* and *Standard Drawings* are superseded by *Standard Specifications for Road and Bridge Construction, Edition of 2019* and *Standard Drawings, Edition of 2020*.

SUPPLEMENTAL SPECIFICATIONS

The contractor shall use the Supplemental Specifications that are effective at the time of letting.
The Supplemental Specifications can be found at the following link:

<http://transportation.ky.gov/Construction/Pages/Kentucky-Standard-Specifications.aspx>

2020 KENTUCKY STANDARD DRAWINGS

CURVE WIDENING AND SUPERELEVATION TRANSITIONS	RGS-001-07
SUPERELEVATION FOR MULTILANE PAVEMENT.....	RGS-002-06
MISCELLANEOUS STANDARDS	RGX-001-06
APPROACHES, ENTRANCES, AND MAIL BOX TURNOUT.....	RPM-110-07
PAVEMENT STRIPING DETAILS FOR TWO LANE TWO WAY ROADWAYS	TPM-175
SHOULDER & EDGELINE RUMBLE STRIPS PLACEMENT DETAILS	TPR-115
EDGELINE RUMBLE STRIP DETAILS TWO LANE ROADWAYS	TPR-120
LANE CLOSURE TWO-LANE HIGHWAY	TTC-100-05
LANE CLOSURE MULTI-LANE HIGHWAY CASE I	TTC-115-04
LANE CLOSURE MULTI-LANE HIGHWAY CASE II.....	TTC-120-04
SHOULDER CLOSURE.....	TTC-135-03
PAVEMENT CONDITION WARNING SIGNS	TTD-125-06
MOBILE OPERATION FOR PAINT STRIPING CASE I	TTS-100-02
MOBILE OPERATION FOR PAINT STRIPING CASE II.....	TTS-105-02

PART III

EMPLOYMENT, WAGE AND RECORD REQUIREMENTS

**TRANSPORTATION CABINET
DEPARTMENT OF HIGHWAYS**

**LABOR AND WAGE REQUIREMENTS
APPLICABLE TO OTHER THAN FEDERAL-AID SYSTEM PROJECTS**

- I. Application
- II. Nondiscrimination of Employees (KRS 344)

I. APPLICATION

1. These contract provisions shall apply to all work performed on the contract by the contractor with his own organization and with the assistance of workmen under his immediate superintendence and to all work performed on the contract by piecework, station work or by subcontract. The contractor's organization shall be construed to include only workmen employed and paid directly by the contractor and equipment owned or rented by him, with or without operators.

2. The contractor shall insert in each of his subcontracts all of the stipulations contained in these Required Provisions and such other stipulations as may be required.

3. A breach of any of the stipulations contained in these Required Provisions may be grounds for termination of the contract.

3. If the contractor is in control of apprenticeship or other training or retraining, including on-the-job training programs, he shall not discriminate against an individual because of his race, color, religion, national origin, sex, disability or age forty (40) and over, in admission to, or employment in any program established to provide apprenticeship or other training.

4. The contractor will send to each labor union or representative of workers with which he has a collective bargaining agreement or other contract or understanding, a notice to be provided advising the said labor union or workers' representative of the contractor's commitments under this section, and shall post copies of the notice in conspicuous places available to employees and applicants for employment. The contractor will take such action with respect to any subcontract or purchase order as the administrating agency may direct as a means of enforcing such provisions, including sanctions for non-compliance.

Revised: January 25, 2017

II. NONDISCRIMINATION OF EMPLOYEES

**AN ACT OF THE KENTUCKY
GENERAL ASSEMBLY TO PREVENT
DISCRIMINATION IN EMPLOYMENT
KRS CHAPTER 344
EFFECTIVE JUNE 16, 1972**

The contract on this project, in accordance with KRS Chapter 344, provides that during the performance of this contract, the contractor agrees as follows:

1. The contractor shall not fail or refuse to hire, or shall not discharge any individual, or otherwise discriminate against an individual with respect to his compensation, terms, conditions, or privileges of employment, because of such individual's race, color, religion, national origin, sex, disability or age (forty and above); or limit, segregate, or classify his employees in any way which would deprive or tend to deprive an individual of employment opportunities or otherwise adversely affect his status as an employee, because of such individual's race, color, religion, national origin, sex, disability or age forty (40) and over. The contractor agrees to post in conspicuous places, available to employees and applicants for employment, notices to be provided setting forth the provisions of this nondiscrimination clause.

2. The contractor shall not print or publish or cause to be printed or published a notice or advertisement relating to employment by such an employer or membership in or any classification or referral for employment by the employment agency, indicating any preference, limitation, specification, or discrimination, based on race, color, religion, national origin, sex, or age forty (40) and over, or because the person is a qualified individual with a disability, except that such a notice or advertisement may indicate a preference, limitation, or specification based on religion, national origin, sex, or age forty (40) and over, or because the person is a qualified individual with a disability, when religion, national origin, sex, or age forty (40) and over, or because the person is a qualified individual with a disability, is a bona fide occupational qualification for employment.

EXECUTIVE BRANCH CODE OF ETHICS

In the 1992 regular legislative session, the General Assembly passed and Governor Brereton Jones signed Senate Bill 63 (codified as KRS 11A), the Executive Branch Code of Ethics, which states, in part:

KRS 11A.040 (7) provides:

No present or former public servant shall, within six (6) months following termination of his office or employment, accept employment, compensation, or other economic benefit from any person or business that contracts or does business with, or is regulated by, the state in matters in which he was directly involved during the last thirty-six (36) months of his tenure. This provision shall not prohibit an individual from returning to the same business, firm, occupation, or profession in which he was involved prior to taking office or beginning his term of employment, or for which he received, prior to his state employment, a professional degree or license, provided that, for a period of six (6) months, he personally refrains from working on any matter in which he was directly involved during the last thirty-six (36) months of his tenure in state government. This subsection shall not prohibit the performance of ministerial functions, including but not limited to filing tax returns, filing applications for permits or licenses, or filing incorporation papers, nor shall it prohibit the former officer or public servant from receiving public funds disbursed through entitlement programs.

KRS 11A.040 (9) states:

A former public servant shall not represent a person or business before a state agency in a matter in which the former public servant was directly involved during the last thirty-six (36) months of his tenure, for a period of one (1) year after the latter of:

- a) The date of leaving office or termination of employment; or
- b) The date the term of office expires to which the public servant was elected.

This law is intended to promote public confidence in the integrity of state government and to declare as public policy the idea that state employees should view their work as a public trust and not as a way to obtain private benefits.

If you have worked for the executive branch of state government within the past six months, you may be subject to the law's prohibitions. The law's applicability may be different if you hold elected office or are contemplating representation of another before a state agency.

Also, if you are affiliated with a firm which does business with the state and which employs former state executive-branch employees, you should be aware that the law may apply to them.

In case of doubt, the law permits you to request an advisory opinion from the Executive Branch Ethics Commission, 3 Fountain Place, Frankfort, Kentucky 40601; telephone (502) 564-7954.

Revised: January 27, 2017

Kentucky Equal Employment Opportunity Act of 1978

The requirements of the Kentucky Equal Employment Opportunity Act of 1978 (KRS 45.560-45.640) shall apply to this Contract. The apparent low Bidder will be required to submit EEO forms to the Division of Construction Procurement, which will then forward to the Finance and Administration Cabinet for review and approval. No award will become effective until all forms are submitted and EEO/CC has certified compliance. The required EEO forms are as follows:

- EEO-1: Employer Information Report
- Affidavit of Intent to Comply
- Employee Data Sheet
- Subcontractor Report

These forms are available on the Finance and Administration's web page under ***Vendor Information, Standard Attachments and General Terms*** at the following address:
<https://www.eProcurement.ky.gov>.

Bidders currently certified as being in compliance by the Finance and Administration Cabinet may submit a copy of their approval letter in lieu of the referenced EEO forms.

For questions or assistance please contact the Finance and Administration Cabinet by email at **finance.contractcompliance@ky.gov** or by phone at 502-564-2874.

EMPLOYEE RIGHTS UNDER THE FAIR LABOR STANDARDS ACT

THE UNITED STATES DEPARTMENT OF LABOR WAGE AND HOUR DIVISION

FEDERAL MINIMUM WAGE

\$7.25

 PER HOUR

BEGINNING JULY 24, 2009

OVERTIME PAY At least 1½ times your regular rate of pay for all hours worked over 40 in a workweek.

CHILD LABOR An employee must be at least **16** years old to work in most non-farm jobs and at least **18** to work in non-farm jobs declared hazardous by the Secretary of Labor.

Youths **14** and **15** years old may work outside school hours in various non-manufacturing, non-mining, non-hazardous jobs under the following conditions:

No more than

- **3** hours on a school day or **18** hours in a school week;
- **8** hours on a non-school day or **40** hours in a non-school week.

Also, work may not begin before **7 a.m.** or end after **7 p.m.**, except from June 1 through Labor Day, when evening hours are extended to **9 p.m.** Different rules apply in agricultural employment.

TIP CREDIT Employers of “tipped employees” must pay a cash wage of at least \$2.13 per hour if they claim a tip credit against their minimum wage obligation. If an employee’s tips combined with the employer’s cash wage of at least \$2.13 per hour do not equal the minimum hourly wage, the employer must make up the difference. Certain other conditions must also be met.

ENFORCEMENT The Department of Labor may recover back wages either administratively or through court action, for the employees that have been underpaid in violation of the law. Violations may result in civil or criminal action.

Employers may be assessed civil money penalties of up to \$1,100 for each willful or repeated violation of the minimum wage or overtime pay provisions of the law and up to \$11,000 for each employee who is the subject of a violation of the Act’s child labor provisions. In addition, a civil money penalty of up to \$50,000 may be assessed for each child labor violation that causes the death or serious injury of any minor employee, and such assessments may be doubled, up to \$100,000, when the violations are determined to be willful or repeated. The law also prohibits discriminating against or discharging workers who file a complaint or participate in any proceeding under the Act.

ADDITIONAL INFORMATION

- Certain occupations and establishments are exempt from the minimum wage and/or overtime pay provisions.
- Special provisions apply to workers in American Samoa and the Commonwealth of the Northern Mariana Islands.
- Some state laws provide greater employee protections; employers must comply with both.
- The law requires employers to display this poster where employees can readily see it.
- Employees under 20 years of age may be paid \$4.25 per hour during their first 90 consecutive calendar days of employment with an employer.
- Certain full-time students, student learners, apprentices, and workers with disabilities may be paid less than the minimum wage under special certificates issued by the Department of Labor.

For additional information:



1-866-4-USWAGE

(1-866-487-9243) TTY: 1-877-889-5627



WWW.WAGEHOUR.DOL.GOV

PART IV
INSURANCE

Refer to
Kentucky Standard Specifications for Road and Bridge Construction,
current edition

PART V
BID ITEMS

PROPOSAL BID ITEMS

202302

Page 1 of 1

Report Date 10/26/20

Section: 0001 - PAVING

LINE	BID CODE	ALT	DESCRIPTION	QUANTITY	UNIT	UNIT PRIC	FP	AMOUNT
0010	00190		LEVELING & WEDGING PG64-22	395.00	TON		\$	
0020	00301		CL2 ASPH SURF 0.38D PG64-22	4,065.00	TON		\$	
0030	02562		TEMPORARY SIGNS	470.00	SQFT		\$	
0040	02650		MAINTAIN & CONTROL TRAFFIC	1.00	LS		\$	
0050	02676		MOBILIZATION FOR MILL & TEXT	1.00	LS		\$	
0060	02677		ASPHALT PAVE MILLING & TEXTURING	100.00	TON		\$	
0070	02697		EDGELINE RUMBLE STRIPS	51,000.00	LF		\$	
0080	03240		BASE FAILURE REPAIR	295.00	SQYD		\$	
0090	06510		PAVE STRIPING-TEMP PAINT-4 IN	20,000.00	LF		\$	
0100	06514		PAVE STRIPING-PERM PAINT-4 IN	1,000.00	LF		\$	
0110	06542		PAVE STRIPING-THERMO-6 IN W	53,000.00	LF		\$	
0120	06543		PAVE STRIPING-THERMO-6 IN Y	53,000.00	LF		\$	
0130	06568		PAVE MARKING-THERMO STOP BAR-24IN	15.00	LF		\$	
0140	06600		REMOVE PAVEMENT MARKER TYPE V	675.00	EACH		\$	
0150	10020NS		FUEL ADJUSTMENT	6,888.00	DOLL	\$1.00	\$	\$6,888.00
0160	10030NS		ASPHALT ADJUSTMENT	17,300.00	DOLL	\$1.00	\$	\$17,300.00
0170	24970EC		ASPHALT MATERIAL FOR TACK NON-TRACKING	23.00	TON		\$	

Section: 0002 - DEMOBILIZATION

LINE	BID CODE	ALT	DESCRIPTION	QUANTITY	UNIT	UNIT PRIC	FP	AMOUNT
0180	02569		DEMOBILIZATION	1.00	LS		\$	