



**CALL NO. 303**

**CONTRACT ID. 152269**

**CAMPBELL COUNTY**

**FED/STATE PROJECT NUMBER FE01 019 0027 013-014**

**DESCRIPTION ALEXANDRIA PIKE (US 27)**

**WORK TYPE ASPHALT SURFACE WITH GRADE & DRAIN**

**PRIMARY COMPLETION DATE 11/15/2015**

**LETTING DATE: July 31,2015**

Sealed Bids will be received electronically through the Bid Express bidding service until 10:00 AM EASTERN DAYLIGHT TIME July 31,2015. Bids will be publicly announced at 10:00 AM EASTERN DAYLIGHT TIME.

**NO PLANS ASSOCIATED WITH THIS PROJECT.**

**REQUIRED BID PROPOSAL GUARANTY:** Not less than 5% of the total bid.

## TABLE OF CONTENTS

PART I	SCOPE OF WORK
	<ul style="list-style-type: none"><li>• PROJECT(S), COMPLETION DATE(S), &amp; LIQUIDATED DAMAGES</li><li>• CONTRACT NOTES</li><li>• STATE CONTRACT NOTES</li><li>• EXPEDITE WORK ORDER</li><li>• SURFACING AREAS</li><li>• ASPHALT MIXTURE</li><li>• DGA BASE</li><li>• INCIDENTAL SURFACING</li><li>• COMPACTION OPTION B</li><li>• SPECIAL NOTE(S) APPLICABLE TO PROJECT</li><li>• LIQUIDATED DAMAGES</li><li>• WASTE AND BORROW SITES</li><li>• ASPHALT MIXTURE FOR PAVEMENT WEDGE</li><li>• SHOULDER FAILURE REPAIR</li><li>• NEW GUARDRAIL INSTALLATION</li><li>• ASPHALT MILLING AND TEXTURING</li><li>• TYPICAL SECTION DIMENSIONS</li><li>• TRAFFIC CONTROL PLAN</li><li>• EROSION CONTROL PLAN FOR MAINTENANCE PROJECTS</li><li>• SKETCH MAP(S)</li><li>• SUMMARY SHEET(S)</li><li>• TYPICAL SECTION(S)</li><li>• DETAIL SHEET(S)</li><li>• GUARDRAIL DELIVERY VERIFICATION SHEET</li></ul>
PART II	SPECIFICATIONS AND STANDARD DRAWINGS
	<ul style="list-style-type: none"><li>• SPECIFICATIONS REFERENCE</li><li>• SUPPLEMENTAL SPECIFICATION</li><li>• PORTABLE CHANGEABLE SIGNS</li><li>• STANDARD DRAWINGS THAT APPLY ENTIRE LIST 2012</li><li>• DELINEATORS FOR GUARDRAIL</li><li>• GUARDRAIL COMPONENTS</li><li>• SHOULDER RUMBLE STRIPS</li><li>• STEEL BEAM GUARDRAIL ("W" BEAM)</li><li>• GUARDRAIL POSTS</li><li>• SILT TRAP TYPE B</li></ul>
PART III	EMPLOYMENT, WAGE AND RECORD REQUIREMENTS
	<ul style="list-style-type: none"><li>• LABOR AND WAGE REQUIREMENTS</li><li>• EXECUTIVE BRANCH CODE OF ETHICS</li><li>• KENTUCKY EQUAL EMPLOYMENT OPPORTUNITY ACT OF 1978 LOCALITY 1,2,3,4 / STATE (OVER 250,000)</li><li>• PROJECT WAGE RATES LOCALITY 4 / FEDERAL &amp; STATE</li></ul>
PART IV	INSURANCE
PART V	BID ITEMS

**PART I**  
**SCOPE OF WORK**

## ADMINISTRATIVE DISTRICT - 06

**CONTRACT ID - 152269**

**FE01 019 0027 013-014**

**COUNTY - CAMPBELL**

**PCN - MP01900271503**

**FE01 019 0027 013-014**

ALEXANDRIA PIKE (US 27) (MP 13.050) FROM 0.162 MILES SOUTH OF AUTUMN LANE EXTENDING NORTH TO 0.062 MILES SOUTH OF AUTUMN LANE (MP 13.150), A DISTANCE OF 0.10 MILES.GRADE & DRAIN WITH ASPHALT SURFACE

GEOGRAPHIC COORDINATES LATITUDE 38:59:41.00 LONGITUDE 84:24:53.00

**COMPLETION DATE(S):**

COMPLETED BY 11/15/2015

APPLIES TO ENTIRE CONTRACT

## **CONTRACT NOTES**

### **PROPOSAL ADDENDA**

All addenda to this proposal must be applied when calculating bid and certified in the bid packet submitted to the Kentucky Department of Highways. Failure to use the correct and most recent addenda may result in the bid being rejected.

### **BID SUBMITTAL**

Bidder must use the Department's Expedite Bidding Program available on the Internet web site of the Department of Highways, Division of Construction Procurement. ([www.transportation.ky.gov/construction-procurement](http://www.transportation.ky.gov/construction-procurement))

The Bidder must download the bid file located on the Bid Express website ([www.bidx.com](http://www.bidx.com)) to prepare a bid packet for submission to the Department. The bidder must submit electronically using Bid Express.

### **JOINT VENTURE BIDDING**

Joint venture bidding is permissible. All companies in the joint venture must be prequalified in one of the work types in the Qualifications for Bidders for the project. The bidders must get a vendor ID for the joint venture from the Division of Construction Procurement and register the joint venture as a bidder on the project. Also, the joint venture must obtain a digital ID from Bid Express to submit a bid. A joint bid bond of 5% may be submitted for both companies or each company may submit a separate bond of 5%.

### **UNDERGROUND FACILITY DAMAGE PROTECTION**

The contractor is advised that the Underground Facility Damage Protection Act of 1994, became law January 1, 1995. It is the contractor's responsibility to determine the impact of the act regarding this project, and take all steps necessary to be in compliance with the provision of the act.

### **SPECIAL NOTE FOR COMPOSITE OFFSET BLOCKS**

Contrary to the Standard Drawings (2012 edition) the Cabinet will allow 6" composite offset blocks in lieu of wooden offset blocks, except as specified on proprietary end treatments and crash cushions. The composite blocks shall be selected from the Cabinet's List of Approved Materials.

### **REGISTRATION WITH THE SECRETARY OF STATE BY A FOREIGN ENTITY**

Pursuant to KRS 176.085(1)(b), an agency, department, office, or political subdivision of the Commonwealth of Kentucky shall not award a state contract to a person that is a foreign entity required by [KRS 14A.9-010](#) to obtain a certificate of authority to transact business in the Commonwealth (“certificate”) from the Secretary of State under [KRS 14A.9-030](#) unless the person produces the certificate within fourteen (14) days of the bid or proposal opening. If the foreign entity is not required to obtain a certificate as provided in [KRS 14A.9-010](#), the foreign entity should identify the applicable exception. Foreign entity is defined within [KRS 14A.1-070](#).

**For all foreign entities required to obtain a certificate of authority to transact business in the Commonwealth, if a copy of the certificate is not received by the contracting agency within the time frame identified above, the foreign entity’s solicitation response shall be deemed non-responsive or the awarded contract shall be cancelled.**

Businesses can register with the Secretary of State at <https://secure.kentucky.gov/sos/ftbr/welcome.aspx>.

### **SPECIAL NOTE FOR PROJECT QUESTIONS DURING ADVERTISEMENT**

Questions about projects during the advertisement should be submitted in writing to the Division of Construction Procurement. This may be done by fax (502) 564-7299 or email to [kytc.projectquestions@ky.gov](mailto:kytc.projectquestions@ky.gov). The Department will attempt to answer all submitted questions. The Department reserves the right not to answer if the question is not pertinent or does not aid in clarifying the project intent.

The deadline for posting answers will be 3:00 pm Eastern Daylight Time, the day preceding the Letting. Questions may be submitted until this deadline with the understanding that the later a question is submitted, the less likely an answer will be able to be provided.

The questions and answers will be posted for each Letting under the heading “Questions & Answers” on the Construction Procurement website ([www.transportation.ky.gov/contract](http://www.transportation.ky.gov/contract)). The answers provided shall be considered part of this Special Note and, in case of a discrepancy, will govern over all other bidding documents.

### **HARDWOOD REMOVAL RESTRICTIONS**

The US Department of Agriculture has imposed a quarantine in Kentucky and several surrounding states, to prevent the spread of an invasive insect, the emerald ash borer.

Hardwood cut in conjunction with the project may not be removed from the state. Chipping or burning on site is the preferred method of disposal.

### **INSTRUCTIONS FOR EXCESS MATERIAL SITES AND BORROW SITES**

Identification of excess material sites and borrow sites shall be the responsibility of the Contractor. The Contractor shall be responsible for compliance with all applicable state and federal laws and may wish to consult with the US Fish and Wildlife Service to seek protection under Section 10 of the Endangered Species Act for these activities.

### **ACCESS TO RECORDS**

The contractor, as defined in KRS 45A.030 (9) agrees that the contracting agency, the Finance and Administration Cabinet, the Auditor of Public Accounts, and the Legislative Research Commission, or their duly authorized representatives, shall have access to any books, documents, papers, records, or other evidence, which are directly pertinent to this contract for the purpose of financial audit or program review. Records and other prequalification information confidentially disclosed as part of the bid process shall not be deemed as directly pertinent to the contract and shall be exempt from disclosure as provided in KRS 61.878(1)(c). The contractor also recognizes that any books, documents, papers, records, or other evidence, received during a financial audit or program review shall be subject to the Kentucky Open Records Act, KRS 61.870 to 61.884.

In the event of a dispute between the contractor and the contracting agency, Attorney General, or the Auditor of Public Accounts over documents that are eligible for production and review, the Finance and Administration Cabinet shall review the dispute and issue a determination, in accordance with Secretary's Order 11-004. (See attachment)

10/29/12



Steven L. Beshear  
Governor

Commonwealth of Kentucky  
Finance and Administration Cabinet  
**OFFICE OF THE SECRETARY**  
Room 383, Capitol Annex  
702 Capital Avenue  
Frankfort, KY 40601-3462  
(502) 564-4240  
Fax (502) 564-6785

Lori H. Flanery  
Secretary

## SECRETARY'S ORDER 11-004

### FINANCE AND ADMINISTRATION CABINET

#### Vendor Document Disclosure

**WHEREAS**, in order to promote accountability and transparency in governmental operations, the Finance and Administration Cabinet believes that a mechanism should be created which would provide for review and assistance to an Executive Branch agency if said agency cannot obtain access to documents that it deems necessary to conduct a review of the records of a private vendor that holds a contract to provide goods and/or services to the Commonwealth; and

**WHEREAS**, in order to promote accountability and transparency in governmental operations, the Finance and Administration Cabinet believes that a mechanism should be created which would provide for review and assistance to an Executive Branch agency if said agency cannot obtain access to documents that it deems necessary during the course of an audit, investigation or any other inquiry by an Executive Branch agency that involves the review of documents; and

**WHEREAS**, KRS 42.014 and KRS 12.270 authorizes the Secretary of the Finance and Administration Cabinet to establish the internal organization and assignment of functions which are not established by statute relating to the Finance and Administration Cabinet; further, KRS Chapter 45A.050 and 45A.230 authorizes the Secretary of the Finance and Administration Cabinet to procure, manage and control all supplies and services that are procured by the Commonwealth and to intervene in controversies among vendors and state agencies; and

**NOW, THEREFORE**, pursuant to the authority vested in me by KRS 42.014, KRS 12.270, KRS 45A.050, and 45A.230, I, Lori H. Flanery, Secretary of the Finance and Administration Cabinet, do hereby order and direct the following:

- I. Upon the request of an Executive Branch agency, the Finance and Administration Cabinet ("FAC") shall formally review any dispute arising where the agency has requested documents from a private vendor that holds a state contract and the vendor has refused access to said documents under a claim that said documents are not directly pertinent or relevant to the agency's inquiry upon which the document request was predicated.
- II. Upon the request of an Executive Branch agency, the FAC shall formally review any situation where the agency has requested documents that the agency deems necessary to

conduct audits, investigations or any other formal inquiry where a dispute has arisen as to what documents are necessary to conclude the inquiry.

- III. Upon receipt of a request by a state agency pursuant to Sections I & II, the FAC shall consider the request from the Executive Branch agency and the position of the vendor or party opposing the disclosure of the documents, applying any and all relevant law to the facts and circumstances of the matter in controversy. After FAC's review is complete, FAC shall issue a Determination which sets out FAC's position as to what documents and/or records, if any, should be disclosed to the requesting agency. The Determination shall be issued within 30 days of receipt of the request from the agency. This time period may be extended for good cause.
- IV. If the Determination concludes that documents are being wrongfully withheld by the private vendor or other party opposing the disclosure from the state agency, the private vendor shall immediately comply with the FAC's Determination. Should the private vendor or other party refuse to comply with FAC's Determination, then the FAC, in concert with the requesting agency, shall effectuate any and all options that it possesses to obtain the documents in question, including, but not limited to, jointly initiating an action in the appropriate court for relief.
- V. Any provisions of any prior Order that conflicts with the provisions of this Order shall be deemed null and void.

**SPECIAL NOTE FOR RECIPROCAL PREFERENCE**

**Reciprocal preference to be given by public agencies to resident bidders**

**By reference, KRS 45A.490 to 45A.494 are incorporated herein and in compliance regarding the bidders residency. Bidders who want to claim resident bidder status should complete the Affidavit for Claiming Resident Bidder Status along with their bid in the Expedite Bidding Program. Submittal of the Affidavit should be done along with the bid in Bid Express.**

03/01/2011

### **EXPEDITE PROJECT WORK ORDER**

The Contractor may request that the Department expedite the work order for this project to allow for maximization of time to complete the work. In order for the Department to accomplish this task, the Contractor may be required to “hand carry” all required project documentation to facilitate the process. Immediately UPON NOTIFICATION OF AWARD OF THE CONTRACT, deliver required project documentation to:

Division of Construction Procurement  
200 Mero St.  
Frankfort, KY 40602

### **SURFACING AREAS**

The Department estimates the mainline surfacing width to be 62 feet.

The Department estimates the total mainline area to be surfaced to be 3,637 square yards.

The Department estimates the shoulder width to be 10 feet on each side.

The Department estimates the total shoulder area to be surfaced to be 1,173 square yards.

### **ASPHALT MIXTURE**

Unless otherwise noted, the Department estimates the rate of application for all asphalt mixtures to be 110 lbs/sy per inch of depth.

### **DGA BASE**

Unless otherwise noted, the Department estimates the rate of application for DGA Base to be 115 lbs/sy per inch of depth.

### **INCIDENTAL SURFACING**

The Department has included in the quantities of asphalt mixtures established in the proposal estimated quantities required for resurfacing or surfacing mailbox turnouts, farm field entrances, residential and commercial entrances, curve widening, ramp gores and tapers, and road and street approaches, as applicable. Pave these areas to the limits as shown on Standard Drawing RPM-110-06 or as directed by the Engineer. In the event signal detectors are present in the intersecting streets or roads, pave the crossroads to the right of way limit or back of the signal detector, whichever is the farthest back of the mainline. Surface or resurface these areas as directed by the Engineer. The Department will not measure placing and compacting for separate payment but shall be incidental to the Contract unit price for the asphalt mixtures.

### **OPTION B**

Be advised that the Department will control and accept compaction of asphalt mixtures furnished on this project under OPTION B in accordance with Sections 402 and 403.

**SPECIAL NOTES FOR PIPE REPLACEMENT  
CAMPBELL COUNTY  
FE01 019 0027 013-014**

Except for the roadway and bid items listed the following shall be incidental to the bid item "24" Culvert Pipe".

- (1) Plugging of existing drainage structure (s) at proposed location.
- (2) Connecting new pipe into existing Drop Box Inlet
- (3) Installation of "Culvert Pipe" including bedding and fabric
- (4) Flowable fill
- (5) Furnish all materials, labor and equipment including water pumps.
- (6) Keeping the following people aware of the work schedule so they may adjust their routes if there are unexpected road closures or long delays:
  - (a) County Judge-Executive
  - (b) U.S. Postal Service
  - (c) Fire Department
  - (d) Ambulance Services
  - (e) Public Transportation (Bus)
  - (f) State Police
  - (g) Sheriff and /or County Police
  - (h) School Systems

The following paragraphs indicate the construction requirements pertaining to this project.

The Contractor shall coordinate the installation of the drainage structure with the Engineer.

All work shall be done in accordance with the current Standard Specifications for Road and Bridge Construction except as provided herein and elsewhere in the proposal, these "Special Notes" Pipe Log (if applicable) and applicable Standard Drawings.

The Department will sample and test all materials according to Department's Sampling Manual. The Contractor shall have the materials available for sampling a sufficient time in advance of the use of the materials to allow for the necessary time for testing, unless otherwise specified in these notes.

### **Location #1 – US 27 South Bound just south of Autumn Lane, MP 13.10**

A 68 foot long, 24 inch culvert pipe, shall be installed from the existing drop box inlet located in the center of US 27 to the beginning of the paved concrete gutter on the west side of the roadway (See Pipe Detail Sheet). The existing culvert pipe, which outlets under the tie-back wall, shall be properly safe-loaded in accordance with section 708 of the current Standard Specifications and plugged with concrete to create a water-tight seal.

Exact location will be marked by the project engineer prior to any work. The culvert is located beneath composite pavement. The contractor shall saw cut prior to culvert installation. Contractor shall be aware there may be utilities under the pavement and to take necessary precautions to avoid damage or disruption of service.

Culvert pipe shall be placed on No. 8 Aggregate bedding wrapped with geotextile fabric type IV. The trench below the roadbed shall be backfilled with flowable fill (pH range medium) to existing subgrade. Bring pavement up to the existing surface with CL 3 Asphalt Base. After the 7 day settlement period has passed, level and wedge the pavement as directed by the engineer. Concrete may be used in lieu of flowable fill and brought up to existing subgrade. The full width of the roadway (including shoulders) shall be milled 1.5” and replaced with 1.5” of CL3 ASPH SURF 0.38 A PG 64-22 at the end of the project. Locations will be marked in the field by the project engineer.

After all work is completed, debris from construction shall be completely removed from the job site. All disturbed areas shall be satisfactorily graded and then roughened with a bulldozer, disc, or other equipment to prepare the seed bed for the seeding and protection.

The maintaining and controlling of traffic shall be the responsibility of the Contractor (See Traffic Control Notes). The Contractor shall furnish, install and maintain advance construction signs in accordance with the Manual on Uniform Traffic Control Devices, the Department’s Standard Specifications for Road and Bridge Construction and applicable Standard Drawings.

Where it is necessary to maintain one lane of traffic or leave open trenches at night, the Contractor shall strictly adhere to all nighttime traffic control regulations. The project may **not** be closed to through traffic and one lane of traffic each in each direction shall be maintained at all times. Access to all local business shall be maintained at all times.

The installation of pipe shall be in conformance with the requirements of Section 701 of the current Standard Specifications for Road and Bridge Construction as applicable to this project, these “Special Notes”, and applicable Standard Drawings.

The Contractor shall remove and dispose of all debris and waste in a manner acceptable to the Engineer and in accordance with the disposal requirements of Section 202.03 of the current Standard Specifications.

The Contractor shall furnish all equipment, materials, labor, including the “Culvert Pipe”.

All applicable materials and construction requirements for pipe culverts shall be in conformance with Sections 701 and 612 of the current Standard Specifications, these “Special Notes”, and applicable Standard Drawings.

All pipe flow line grades will be established by the Engineer and shall meet existing ditch channel elevations. Positive drainage with watertight seals between pipes, DBIs and manholes openings are required upon completion of the project and shall be the responsibility of the Contractor.

Each Contractor submitting a bid for this work shall make a thorough inspection of the site prior to submitting his bid and shall thoroughly familiarize himself with existing conditions so that the work can be expeditiously performed after a contract is awarded. Submission of a bid will be considered evidence of this inspection having been made. Any claims resulting from site conditions will not be honored by the Department. All utilities shall be located and marked before construction begins.

Information shown on the drawings and in this proposal and the types and quantities of work listed are approximate only, and are not to be taken as an accurate or complete evaluation of the material and conditions to be encountered during construction. The bidder must draw his own conclusion as to the conditions encountered. The department does not give any guarantee as to the accuracy of the data and no claim will be considered for additional compensation if the conditions encountered are not in accordance with the information shown.

The exact limits of Right-of-Way have not been established by the Department. The Contractor shall have the ROW limits staked and limit his activities to ROW or work areas secured by the Department through Consent and Release of the adjacent property owners. The contractor shall be responsible for all encroachments onto private lands.

The Contractor will be responsible for all damage to public and/or private property resulting from his work.

## Geotech Recommended Procedure

The Geotechnical Branch recommends to excavate and replace below the wall. The embankment slope shall be excavated on a 1:1 slope with a minimum 15 foot shear key placed on unweathered bedrock. The refill shall be constructed with granular embankment, as shown on the attached plan sheets and shall cover the existing wall face. The brown shale encountered at the top of the bedrock formation is 4 to 5 feet thick and is considered weathered material.

The geotechnical recommendations are shown below.

- 1). Do not remove any of the existing wall or lagging.
- 2). Do not stockpile, even temporarily, any material above or below the wall.
- 3). Excavate on a 1H:1V slope to unweathered bedrock and construct a minimum 15 foot wide shear key. Positive drainage must be maintained from the base of the shear key. (see shear key typical)
- 4). Excavation will involve some risk. Perform excavation in short increments (50 feet length or less). Excavated areas must be refilled to grade within 48 hours.
- 5). The reconstructed embankment shall consist of granular embankment (Crushed Aggregate Size No. 2) meeting the material requirements of Section 805 of the current Standard Specifications for Road and Bridge Construction, non-erodible only.
- 6). Place a Geotextile Fabric Type IV between the soil and the granular embankment. The geotextile fabric shall also be placed on the wall face where the lagging is missing. The Geotextile Fabric shall meet the requirements of Section 843 of the Standard Specifications for Road and Bridge Construction, current edition. Install the Geotextile Fabric in accordance with Section 214 of the Standard Specifications for Road and Bridge Construction, current edition. Take special care not to rip or tear the fabric.
- 7). Remove guardrail as directed by the Engineer
- 8). Special care placing and compacting the granular embankment against the face of the wall shall be used as not to damage the existing lagging or walers.
- 9). Fill in existing voids between lagging and the asphalt curb with No. 8 stone.
- 10). Perform base failure repair on shoulders.
- 11). Replace guardrail.

### **SPECIAL NOTE FOR STAKING**

In addition to the requirements of Section 201, perform the following:

1. Contrary to Section 201.03.01, perform items 1-3 usually performed by the Engineer; and
2. Field survey the existing pavement in order to establish the existing cross slopes, transitions and profile. Irregularities in the existing pavement are to be eliminated with the construction of a smooth line and grade of the new asphalt pavement to ensure the best rideability possible.
3. Verify intersection and lane profile and alignment and prepare a Drainage Development Worksheet to provide for positive drainage upon completion of construction; and
4. Prior to incorporating into the work, obtain the Engineers approval of all designs and revisions to be provided by the Contractor; and
5. Produce and furnish to the Engineer "As Built" plans; and
6. Perform any and all other staking operations required to control and construct the work.

## **Special Note For Fixed Completion Date and Liquidated Damages**

Contrary to Section 108.09, Liquidated Damages of \$5,000 per calendar day will be assessed for each day work remains uncompleted beyond the Specified Completion Date. This project has a Fixed Completion Date of November 15, 2015.

In addition to the Liquidated Damages specified above, Liquidated Damages in the following amounts will be charged when a lane closure remains in place during a prohibited period outlined in the Traffic Control Plan, excluding delays caused by inclement weather and the US 27 North right lane which will remain closed throughout the duration of the project:

US 27 per lane	\$500 for the first hour
	\$750 for the second hour
	\$1,000 any additional hour

These hourly disincentives will still be in effect after the Fixed Completion Date of November 15, 2015 and will be charged in addition to the \$5,000 per calendar day if warranted. If work is delayed by inclement weather, the minimum work required to allow removal of the lane closure, as directed by the Engineer, shall be resumed immediately as soon as weather permits or the Department will begin to assess Liquidated Damages as specified herein.

Contrary to section 108.09, the Department will assess Liquidated Damages for the months of December through March.

Contrary to Section 108.09, the Department will assess Liquidated Damages regardless of whether seasonal limitations prohibit the Contractor from performing work on the controlling operation.

All liquidated damages will be applied cumulatively.

All other applicable portions of Section 108 apply.

## **SPECIAL PROVISION FOR WASTE AND BORROW SITES**

Obtain U.S. Army Corps of Engineer's approval before utilizing a waste or borrow site that involves "Waters of the United States". The Corps of Engineers defines "Waters of the United States" as perennial or intermittent streams, ponds or wetlands. The Corps of Engineers also considers ephemeral streams, typically dry except during rainfall but having a defined drainage channel, to be jurisdictional waters. Direct questions concerning any potential impacts to "Waters of the United States" to the attention of the appropriate District Office for the Corps of Engineers for a determination prior to disturbance. Be responsible for any fees associated with obtaining approval for waste and borrow sites from the U.S. Army Corps of Engineer or other appropriate regulatory agencies.

1-296 Waste & Borrow Sites  
01/02/2012

## SPECIAL NOTE FOR PAVEMENT WEDGE AND SHOULDER SEPARATE OPERATION

**1.0 MATERIALS.** Provide an Asphalt Mixture for Pavement Wedge conforming to Section 407 of the Standard Specifications or an Asphalt Surface Mixture conforming to Section 403 of the Standard Specifications, as applicable to the project, for the pavement wedge.

**2.0 CONSTRUCTION.** Place the Asphalt Mixture for Pavement Wedge or Asphalt Surface Mixture as a separate operation from the driving lane. Prime the existing shoulder with tack material as the Engineer directs before placing the wedge. Construct according to Sections 407.03 and 403.03 as applicable.

When the Engineer deems it appropriate to pave both the driving lane and the adjoining wedge monolithically, equip the paver with a modified screed that extends the full width of the wedge being placed and is tapered to produce a wedge. Obtain the Engineer's approval of the modified screed before placing shoulder wedge monolithically with the driving lane.

The wedge may vary in thickness at the edge of the driving lanes. Where existing site conditions permit, limit the outside edge thickness of the new paving limits to one inch above the existing shoulder wedge elevation. If an Asphalt Surface Mixture is furnished for the pavement wedge, texture according to Section 403.03.08.

The following sketch is primarily for the computation of quantities; however, the wedge will result in a similar cross-section where sufficient width exists. Do not construct a shoulder for placing the wedge unless specified elsewhere in the Contract.

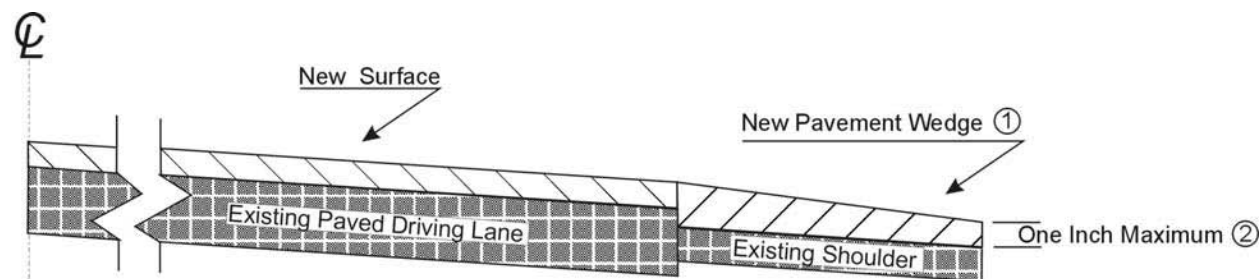

- ① Slope varies, but is down from the driving lanes except on outside of some curves where superelevation controls.
- ② Where existing site conditions permit.

**3.0 MEASUREMENT.** The Department will measure Asphalt Mixture for Pavement Wedge or Asphalt Surface Mixture placed as the pavement wedge according to Sections 403 and 407 as applicable.

**4.0 PAYMENT.** The Department will make payment for the completed and accepted quantities of Asphalt Surface Mixtures placed as pavement wedge according to Section 403. The Department will make payment for the completed and accepted quantities of Asphalt Mixture for Pavement Wedge according to Section 407.

## **SPECIAL NOTES FOR SHOULDER FAILURE REPAIR**

Repair locations listed in the summary are approximate only. The Engineer will determine actual shoulder failure repair locations at the time of construction. Excavate to an approximate depth of 14-18 inches below the top of the existing shoulder pavement level, as directed by the Engineer. Remove and dispose of all materials. Use all possible care to avoid damaging existing culvert pipes and any existing underground utilities. Repair or restore any damaged items at no additional cost to the Department. Waste all removed materials off the Right of Way at sites obtained by the Contractor at no additional cost to the Department (see Special Note for Waste and Borrow)

Backfill the excavated area with 6 inches of DGA and 8-12 inches of Class 3 Asphalt Base 0.75D PG64-22 up to the existing shoulder pavement surface. Compact the asphalt base to the proper compaction as required by the Section 403 and seal with Leveling and Wedging. Perform all shoulder failure repairs in such a manner that removal and replacement are completed on the same day. Do this work as one of the Contractor's first operations. Do not place new asphalt surface over repaired shoulder failures until a minimum of 7 days has elapsed after placement of the asphalt base. Prior to constructing new asphalt shoulder surfacing, level and wedge any settlement of the repair areas.

The bidder must draw his own conclusions as to the conditions encountered. The Department does not give any guarantee as to the accuracy of the data and no claim will be considered for additional compensation of the materials encountered that are not in accord with the classification shown.

Payment at the Contract unit prices per square yard for "Shoulder Failure Repair" and per ton for "Leveling and Wedging" shall be full compensation for all labor, materials, equipment, and incidentals for excavating and disposing of all materials, furnishing and placing DGA and asphalt base backfilling the trench up to the top pavement boundary, sealing the repaired area with Leveling and Wedging, and all other items necessary to complete the work to the satisfaction of the Engineer.

## SPECIAL NOTES FOR GUARDRAIL

---

### I. DESCRIPTION

Except as specified herein, perform all work in accordance with the Department's Standard and Supplemental Specifications and Standard and Sepia Drawings, current editions. Article references are to the Standard Specifications.

Furnish all equipment, labor, materials, and incidentals for the following work items:

(1) Site preparation; (2) Remove existing guardrail systems; (3) Install Guardrail furnished by the Department; (4) Extra Length Posts, End Treatments, Bridge End Connectors, and Terminal Sections, as applicable; (5) Delineators for guardrail; (6) Maintain and control traffic; and (7) all other work specified as part of this contract.

### II. MATERIALS

Except as specified herein, provide for all materials to be sampled and tested in accordance with the Department's Sampling Manual and make the materials available for sampling a sufficient time in advance of the use of the materials to allow for the necessary time for testing.

**A. Maintain and Control Traffic.** See Traffic Control Plan.

**B. Guardrail.** The Department will furnish guardrail elements and radius rail, steel posts, and timber off set blocks in general conformance to Section 814 and the Standard Drawings, but may vary in some respects, such as gage, pre-punched hole patterns, etc. The Contractor shall furnish guardrail hardware (nuts, bolts, and washers), extra length posts, end treatments, bridge end connectors, and terminal sections in accordance with Section 814 and the Standard Drawings. Furnish approximately 80 Extra Length Posts (9 foot length, steel-no alternates).

**C. Delineators for Guardrail.** Furnish bi-directional white and/or yellow Delineators for Guardrail according to the Delineators for Guardrail Sepia Drawing.

**D. Erosion Control.** See Special Note for Erosion Control.

### III. CONSTRUCTION METHODS

**A. Maintain and Control Traffic.** See Traffic Control Plan.

**B. Site Preparation.** Remove existing guardrail system including the guardrail end treatments, Bridge End connectors and all other elements of the existing guardrail system as per Section 719, except that the Contractor will take possession of all concrete posts

## Guardrail Page 2 of 4

and all concrete associated with existing bridge and/or guardrail end treatments. Locate all disposal areas off the Right of Way. Be responsible for all site preparation, including but not limited to, clearing and grubbing, excavation, embankment, and removal of all obstructions or any other items; regrading, reshaping, adding and compacting of suitable materials on the existing shoulders to provide proper template or foundation for the guardrail; filling voids left as the result of removing existing guardrail and guard posts with dry sand; temporary pollution and erosion control; disposal, of excess and waste materials and debris; and final dressing, cleanup, and seeding and protection. Perform all site preparation as approved or directed by the engineer.

**C. Install Guardrail.** Except as specified herein, install materials furnished by the Department and construct guardrail system according to Section 719 and the Standard Drawings. The Department will make the materials available to the Contractor at the Bailey Bridge Lot between the hours of 8:00 a.m. and 3:30 p.m. Monday through Friday. Determine curvature of radius rail for entrances and terminal sections and provide the Engineer a list of requirements fourteen (14) calendar days prior to beginning work.

Locations listed on the summary and/or shown on the drawings are approximate only. The Engineer will determine the exact termini for individual guardrail installations and locations for Extra Length Posts at the time of construction. Unless directed otherwise by the Engineer, provide a minimum two (2) foot shoulder width. Construct radii at entrances and road intersections as directed by the Engineer.

Erect guardrail to the lines and grades shown on current Standard Drawings or as directed by the Engineer by any method approved by the Engineer which allows construction of the guardrail to the true grade without apparent sags.

When installing guardrail, do not leave blunt ends exposed where they would be hazardous to the public. When it is not practical to complete the construction of the guardrail and the permanent end treatments and terminal sections first, provide a temporary end by connecting at least 25 feet of rail to the last post, and by slightly flaring, and burying the end of the rail completely into the existing shoulder. If left overnight, place a drum with bridge panel in advance of the guardrail end and maintain during use.

**D. Delineators for Guardrail.** Construct Delineators for Guardrail according to the delineators for Guardrail Sepia Drawing.

**E. Property Damage.** Be responsible for all damage to public and/or private property resulting from the work. Restore damaged roadway features and private property at no additional cost to the Department.

**F. Coordination with Utility Companies.** Locate all underground, above ground and overhead utilities prior to beginning construction. Be responsible for contacting and maintaining liaison with all utility companies that have utilities located within the project

Guardrail  
Page 3 of 4

limits. Do not disturb existing overhead or underground utilities. It is not anticipated that any utility facilities will need to be relocated and/or adjusted; however, in the event that it is discovered that the work does require that utilities be relocated and/or adjusted, the utility companies will work concurrently with the Contractor while relocating their facilities. Be responsible for repairing all utility damage that occurs as a result of guardrail operations at no additional cost to the Department.

**G. Right of Way Limits.** The Department has not established exact limits of the Right-of-Way. Limit work activities to obvious Right-of-Way, permanent or temporary easements, and work areas secured by the Department through consent and release of the adjacent property owners. Be responsible for all encroachments onto private lands.

**H. Disposal of Waste.** Dispose of all removed concrete, debris, and other waste and debris off the Right-of-Way at sites obtained by the Contractor at no additional cost to the Department. See Special Note for Waste and Borrow.

**I. Final Dressing, Clean Up, and Seeding and Protection.** Apply Class A Final Dressing to all disturbed areas, both on and off the Right-of-Way. Sow all disturbed earthen areas according to the Special Note for Erosion Control.

**J. Erosion Control.** See Special Note for Erosion Control.

#### IV. METHOD OF MEASUREMENT

**A. Maintain and Control Traffic.** See Traffic Control Plan.

**B. Site preparation.** Other than the bid items listed, the Department will not measure Site Preparation for separate payment but shall be incidental to Guardrail, Steel W Beam Single Face, Install; End Treatments; Bridge End Connectors; and Terminal Sections as applicable.

**C. Guardrail, Steel W Beam Single Face, Install.** The Department will measure the actual length of guardrail furnished by the Department and installed by the Contractor. Contrary to section 719.04.01, the Department will measure the actual length of shop curved guardrail in linear feet and will not multiply the actual length by a factor of 1.3 to determine the pay quantity.

Guardrail  
Page 4 of 4

**D. Guardrail Hardware.** The Department will not measure guardrail hardware for separate payment but shall be incidental to Guardrail, Steel W Beam Single Face, Install.

**E. Extra Length Posts, End Treatments, Bridge End Connectors, and Terminal Sections.** See Section 719.04

**F. Delineators for Guardrail.** See Delineators for Guardrail Sepia Drawing.

**G. Erosion Control.** See Special Note for Erosion Control.

**V. BASIS OF PAYMENT**

**A. Maintain and Control Traffic.** See Traffic Control Plan.

**B. Guardrail, Steel W Beam Single Face, Install.** See Section 719.05.

**C. Extra Length Posts, End Treatments, Bridge End Connectors, and Terminal Sections.** See Section 719.05.

**D. Delineators for Guardrail.** See Delineators for Guardrail Sepia Drawing.

**E. Erosion Control.** See Special Note for Erosion Control.

**SPECIAL NOTE FOR  
ASPHALT MILLING AND TEXTURING**

Begin paving operations within **48 hours** of commencement of the milling operation. Continue paving operations continuously until completed. If paving operations are not begun within this time period, the Department will assess liquidated damages at the rate prescribed by Section 108.09 until such time as paving operations are begun.

Take possession of the millings and recycle the millings or dispose of the millings off the Right-of-Way at sites obtained by the Contractor at no additional cost to the Department.

1-3520 48 hours Contractor keeps millings  
01/2/2012

### **SPECIAL NOTE FOR TYPICAL SECTION DIMENSIONS**

Consider the dimensions shown on the typical sections for pavement and shoulder widths and thickness' to be nominal or typical dimensions. The Engineer may direct or approve varying the actual dimensions to be constructed to fit existing conditions. Do not widen existing pavement or shoulders unless specified elsewhere in this proposal or directed by the engineer.

1-3725 Typical Section Dimensions  
01/02/2012

## **TRAFFIC CONTROL PLAN & CONSTRUCTION PROCEDURES CAMPBELL COUNTY FE01 019 0027 013-014**

---

### **TRAFFIC CONTROL GENERAL**

Except as provided herein, maintain and control traffic in accordance with the 2012 Standard Specifications and the Standard Drawings, current editions. Except for the roadway and traffic control bid items listed, all items of work necessary to maintain and control traffic will be paid at the lump sum bid price to "Maintain and Control Traffic".

Contrary to Section 106.01, traffic control devices used on this project may be new, or used in like new condition, at the beginning of the work and maintained in like new condition until completion of the work.

### **PROJECT PHASING & CONSTRUCTION PROCEDURES**

**PHASE I** – Install new cross culvert pipe and plug existing culvert. Roadway may be reduced to one lane of traffic in each direction from 8 PM Friday to 6 AM Monday. Ligated damages may be applied if all lanes are not reopened by 6 AM Monday (Excluding US 27 North right lane). Single lanes closures will be allowed except on weekdays between 6 AM – 9AM and 3 PM – 6 PM. The Engineer may specify additional days and hours when road work may be performed. Provide for approval by the Engineer a schedule of the proposed road work 14 calendar days prior to beginning work. Changeable Message Boards shall be placed one week in advance at each end of the project. Truck Mounted Attenuators conforming to Sections 725.02.05 and 725.03.03 shall be used in any immediately adjacent lane to open road cuts or work zones. Place the TMA within the lane closure at locations approved by the Engineer. Contrary to Section 725.03.03, retain possession of the TMA upon completion of the work.

**PHASE II** – Stabilize Tie-back Wall (See Geotech recommended procedure). The contractor shall remain on Right-of-Way unless given consent by the adjacent property owners. ROW has not been established, but control points are provided to stake the ROW lines. The entrance to Summit Church of Christ may be used at access to the site. The successful contractor shall keep the church apprised of all activities that affect their entrance and avoid conflicts when large gatherings are expected. The contractor shall be responsible to maintain the entrance at all times during construction and to replace in kind once all work is complete.

The right lane of US 27 North shall remain closed the duration of the project. KYTC currently has the right lane closed. The successful contractor shall coordinate with KYTC the removal or KYTC's traffic control devices with the installation of traffic control. Trucks entering and exiting roadway signs shall be used when necessary. Flaggers shall be

available if traffic must be stopped temporarily to unload equipment. Portable Changeable Message Signs shall be placed one week in advance at each end of the project. Truck Mounted Attenuators conforming to Sections 725.02.05 and 725.03.03 shall be used in any immediately adjacent lane to open road cuts or work zones. Place the TMA within the lane closure at locations approved by the Engineer. Contrary to Section 725.03.03, retain possession of the TMA upon completion of the work.

## **SIGNS**

Contrary to Section 112.04.02 and 112.04.03, Low Shoulder signs will not be measured for payment, but shall be incidental to Maintain and Control Traffic. Contrary to section 112.04.02, only long term signs (signs intended to be continuously in place for more than 3 days) will be measured for payment; short term signs (signs intended to be left in place for 3 days or less) will not be measured for payment but will be incidental to Maintain and Control Traffic.

## **CHANGEABLE MESSAGE SIGNS**

Provide changeable message signs in advance of and within the project at locations determined by the Engineer. If work is in progress concurrently in both directions or if more than one lane closure is in place in the same direction of travel, provide additional changeable message signs as directed by the Engineer. The Engineer may vary the designated locations as the work progresses. The Engineer will determine the messages to be displayed. In the event of damage or mechanical/electrical failure, repair or replace the Changeable Message Sign within 24 hours. The Department will measure for payment the maximum number of Changeable Message Signs in concurrent use at the same time on a single day on all sections of the contract. The Department will measure individual Changeable Message Signs only once for payment, regardless of how many times they are set, reset, removed, and relocated during the duration of the project. The Department will not measure replacements for damaged Changeable Message Signs or for signs the Engineer directs be replaced due to poor condition or readability. Retain possession of the Changeable Message Signs upon completion of the work.

## **ARROW PANELS**

Use arrow panels as shown on the Standard Drawings or as directed by the Engineer. The Department will measure for payment the maximum number of arrow panels in concurrent use at the same time on a single day on all sections of the contract. The Department will measure for payment the maximum number of Changeable Message Signs in concurrent use at the same time on a single day on all sections of the contract. The Department will measure individual Arrow Panels only once for payment, regardless of how many times they are set, reset, removed, and relocated during the duration of the project. The Department will not measure replacements for damaged Arrow Panels or for panels signs the Engineer directs be replaced due to poor condition or readability for payment. Retain possession of the Arrow Panels upon completion of the work.

## **BARRICADES**

Barricades used in lieu of barrels and cones for channelization or delineation will be incidental to Maintain and Control Traffic according to Section 112.04.01. Barricades used for road closures and to protect pavement removal areas will be bid as each according to Section 112.04.05.

## **TEMPORARY ENTRANCES**

Access to side streets and roads, schools, churches, commercial properties and apartments or apartment complexes of four or more units shall be maintained at all times. The Contractor will not be required to provide continuous access to farms, single family, duplex, or triplex residential properties during working hours; however, the Contractor shall provide reasonable egress and ingress to each such property when actual operations are not in progress at that location. The time during which a farm or residential entrance is blocked shall be the minimum length of time required for actual operations, shall not be extended for the Contractor's convenience, and in no case shall exceed six (6) hours. The Contractor shall notify all residents three days in advance of any driveway or entrance closings and shall make any accommodations necessary to meet the access needs of disabled residents.

No direct payment will be allowed for temporary entrance pipe, excavation and/or embankment, or any other incidentals needed to provide access.

## **PAVEMENT MARKINGS**

If there is to be a deviation from the existing striping plan, the Engineer will furnish the Contractor a striping plan prior to placement of the final surface course. Install Temporary Striping according to Section 112 with the following exceptions:

1. Place Temporary or Permanent Striping before opening a lane to traffic; and
2. If the Contractor's operations or phasing requires temporary markings that must subsequently be removed from the final surface course, use an approved removable lane tape; however, the Department will not measure removable lane tape for separate payment, but will measure and pay for removable lane tape as temporary striping.

## **PAVEMENT EDGE DROP-OFFS**

Less than 2" - No protection required.

2" to 4" - Place plastic drums, vertical panels, or barricades every 50 feet. Cones may be used in place of plastic drums, panels, and barricades during daylight working hours. Wedge with asphalt mixture for leveling and wedging with a 1:1 or flatter slope in daylight hours, or 3:1 or flatter slope during nighttime hours, when work is not active in the drop-off area.

Pedestrians & Bicycles - Protect pedestrian and bicycle traffic as directed by the engineer.

## **USE AND PLACEMENT OF CHANGEABLE MESSAGE SIGNS**

The following policy is based upon current Changeable Message Signs (CMS) standards and practice from many sources, including the Federal Highway Administration (FHWA), other State Departments of Transportation, and Traffic Safety Associations. It is understood that each CMS installation or use requires individual consideration due to the specific location or purpose. However, there will be elements that are constant in nearly all applications. Accordingly these recommended guidelines bring a level of uniformity, while still being open to regional experience and engineering judgment.

### **Application**

The primary purpose of CMS is to advise the driver of unexpected traffic and routing situations. Examples of applications where CMS can be effective include:

- Closures (road, lane, bridge, ramp, shoulder, interstate)
- Changes in alignment or surface conditions
- Significant delays, congestion
- Construction/maintenance activities (delays, future activities)
- Detours/alternative routes
- Special events with traffic and safety implications
- Crash/incidents
- Vehicle restrictions (width, height, weight, flammable)
- Advance notice of new traffic control devices
- Real-time traffic conditions (must be kept up to date)
- Weather /driving conditions, environmental conditions, Roadway Weather Information Systems
- Emergency Situations
- Referral to Highway Advisory Radio (if available)
- Messages as approved by the County Engineer's Office

### **CMS should not be used for:**

- Replacement of static signs (e.g. road work ahead), regulatory signage (e.g. speed limits), pavement markings, standard traffic control devices, conventional warning or guide signs.
- Replacement of lighted arrow board
- Advertising (Don't advertise the event unless clarifying "action" to be taken by driver – e.g. Speedway traffic next exit)
- Generic messages
- Test messages (portable signs only)
- Describe recurrent congestion (e.g. rush hour)
- Public service announcements (not traffic related)

## Messages

Basic principles that are important to providing proper messages and insuring the proper operation of a CMS are:

- Visible for at least ½ mile under ideal daytime and nighttime conditions
- Legible from all lanes a minimum of 650 feet
- Entire message readable twice while traveling at the posted speed
- Nor more than two message panels should be used (three panels may be used on roadways where vehicles are traveling less than 45 mph). A panel is the message that fits on the face of the sign without flipping or scrolling.
- Each panel should convey a single thought; short and concise
- Do not use two unrelated panels on a sign
- Do not use the sign for two unrelated messages
- Should not scroll text horizontally or vertically
- Should not contain both the words left and right
- Use standardized abbreviations and messages
- Should be accurate and timely
- Avoid filler/unnecessary words and periods (hazardous, a, an, the)
- Avoid use of speed limits
- Use words (not numbers) for dates

## Placement

Placement of the CMS is important to insure that the signs is visible to the driver and provides ample time to take any necessary action. Some of the following principles may only be applicable to controlled access roadways. The basic principles of placement for a CMS are:

- When 2 signs are needed, place on same side of roadway and at least 1,000 feet apart
- Place behind semi-rigid/rigid protection (guardrail, barrier) or outside of the clear zone
- Place 1,000 feet in advance of work zone; at least one mile ahead of decision point
- Normally place on right side of roadway; but should be placed closest to the affected lane so that either side is acceptable
- Signs should not be dual mounted (one on each side of roadway facing same direction)
- Point trailer hitch downstream
- Secure to immovable object to prevent thief (if necessary)
- Do not place in sags or just beyond crest
- Check for reflection of sun to prevent the blinding of motorist
- Should be turned ~3 degrees outward from perpendicular to the edge of pavement
- Bottom of sign should be 7 feet above the elevation of edge of roadway
- Should be removed when not in use
-

### Standard Abbreviations

The following is a list of standard abbreviations to be used on CMS.

<u>Word</u>	<u>Abbrev.</u>	<u>Example</u>
Access	ACCS	ACCIDENT AHEAD/USE ACCS RD NEXT RIGHT
Alternate	ALT	ACCIDENT AHEAD/USE ALT RTE NEXT RIGHT
Avenue	AVE	FIFTH AVE CLOSED/DETOUR NEXT LEFT
Blocked	BLKD	FIFTH AVE BLKD/MERGE LEFT
Boulevard	BLVD	MAIN BLVD CLOSED/USE ALT RTE
Bridge	BRDG	SMITH BRDG CLOSED/USE ALT RTE
Cardinal Directions	N, S, E, W	N I75 CLOSED/ DETOUR EXIT 30
Center	CNTR	CNTR LANE CLOSED/MERGE LEFT
Commercial	COMM	OVRSZ COMM VEH/USE I275
Condition	COND	ICY COND POSSIBLE
Congested	CONG	HVY CONG NEXT 3 MI
Construction	CONST	CONST WORK AHEAD/EXPECT DELAYS
Downtown	DWNTN	DWNTN TRAF USE EX 40
Eastbound	E-BND	E-BND I64 CLOSED/DETOUR EXIT 20
Emergency	EMER	EMER VEH AHEAD/PREPARE TO STOP
Entrance, Enter	EX, EXT	DWNTN TRAF USE EX 40
Expressway	EXPWY	WTRSN EXPWY CLOSED/DETOUR EXIT 10
Freeway	FRWY, FWY	GN SYNDR FWY CLOSED/DETOUR EXIT 15
Hazardous Materials	HAZMAT	HAZMAT IN ROADWAY/ALL TRAF EXIT 25
Highway	HWY	ACCIDENT ON AA HWY/EXPECT DELAYS
Hour	HR	ACCIDENT ON AA HWY/2 HR DELAY
Information	INFO	TRAF INFO TUNE TO 1240 AM
Interstate	I	E-BND I64 CLOSED/DETOUR EXIT 20
Lane	LN	LN CLOSED/MERGE LEFT
Left	LFT	LANE CLOSED/MERGE LFT
Local	LOC	LOC TRAF USE ALT RTE
Maintenance	MAINT	MAINT WRK ON BRDG/SLOW
Major	MAJ	MAJ DELWAYS I75/USE ALT RTE
Mile	MI	ACCIDENT 3 MI AHEAD/ USE ALT RTE
Minor	MNR	ACCIDENT 3 MI MNR DELAY

Minutes Northbound	MIN N-BND	ACCIDENT 3 MI/30 MIN DELAY N-BND I75 CLOSED/ DETOUR EXIT 50
Oversized	OVRSZ	OVRSZ COMM VEH/USE I275 NEXT RIGHT
Parking Parkway	PKING PKWY	EVENT PKING NEXT RGT CUM PKWAY TRAF/DETOUR EXIT 60
Prepare Right Road Roadwork	PREP RGT RD RDWK	ACCIDENT 3 MIL/PREP TO STOP EVENT PKING NEXT RGT HAZMAT IN RD/ALL TRAF EXIT 25 RDWK NEXT 4 MI/POSSIBLE DELAYS
Route Shoulder Slippery Southbound	RTE SHLDR SLIP S-BND	MAJ DELAYS I75/USE ALT RTE SHLDR CLOSED NEXT 5 MI SLIP COND POSSIBLE/ SLOW SPD S-BND I75 CLOSED/DETOUR EXIT 50
Speed Street Traffic	SPD ST TRAF	SLIP COND POSSIBLE/ SLOW SPD MAIN ST CLOSED/USE ALT RTE CUM PKWAY TRAF/DETOUR EXIT 60
Vehicle	VEH	OVRSZ COMM VEH/USE I275 NEXT RIGHT
Westbound	W-BND	W-BND I64 CLOSED/DETOUR EXIT 50
Work	WRK	CONST WRK 2MI/POSSIBLE DELAYS

Certain abbreviations are prone to inviting confusion because another word is abbreviated or could be abbreviated in the same way. DO NO USE THESE ABBREVIATIONS.

<u>Abbrev.</u>	<u>Intended Word</u>	<u>Word Erroneously Given</u>
ACC	Accident	Access (Road)
CLRS	Clears	Colors
DLY	Delay	Daily
FDR	Feeder	Federal
L	Left	Lane (merge)
LOC	Local	Location
LT	Light (traffic)	Left
PARK	Parking	Park
POLL	Pollution (index)	Poll
RED	Reduce	Red
STAD	Stadium	Standard
TEMP	Temporary	Temperature
WRNG	Warning	Wrong

### TYPICAL MESSAGES

The following is a list of typical messages used on CMS. The list consists of the reason or problem that you want the driver to be aware of and the action that you want the driver to take.

<u>Reason/Problem</u>	Action
ACCIDENT	ALL TRAFFIC EXIT RT
ACCIDENT/XX MILES	AVOID DELAY USE XX
XX ROAD CLOSED	CONSIDER ALT ROUTE
XX EXIT CLOSED	DETOUR
BRIDGE CLOSED	DETOUR XX MILES
BRIDGE/(SLIPPERY, ICE, ETC.)	DO NOT PASS
CENTER/LANE/CLOSED	EXPECT DELAYS
DELAY(S), MAJOR/DELAYS	FOLLOW ALT ROUTE
DEBRIS AHEAD	KEEP LEFT
DENSE FOG	KEEP RIGHT
DISABLED/VEHICLE	MERGE XX MILES
EMER/VEHICLES/ONLY	MERGE LEFT
EVENT PARKING	MERGE RIGHT
EXIT XX CLOSED	ONE-WAY TRAFFIC
FLAGGER XX MILES	PASS TO LEFT
FOG XX MILES	PASS TO RIGHT
FREEWAY CLOSED	PREPARE TO STOP
FRESH OIL	REDUCE SPEED
HAZMAT SPILL	SLOW
ICE	SLOW DOWN
INCIDENT AHEAD	STAY IN LANE
LANES (NARROW, SHIFT, MERGE, ETC.)	STOP AHEAD
LEFT LANE CLOSED	STOP XX MILES
LEFT LANE NARROWS	TUNE RADIO 1610 AM
LEFT 2 LANES CLOSED	USE NN ROAD
LEFT SHOULDER CLOSED	USE CENTER LANE
LOOSE GRAVEL	USE DETOUR ROUTE
MEDIAN WORK XX MILES	USE LEFT TURN LANE
MOVING WORK ZONE, WORKERS IN ROADWAY	USE NEXT EXIT
NEXT EXIT CLOSED	USE RIGHT LANE
NO OVERSIZED LOADS	WATCH FOR FLAGGER
NO PASSING	
NO SHOULDER	
ONE LANE BRIDGE	
PEOPLE CROSSING	
RAMP CLOSED	
RAMP (SLIPPERY, ICE, ETC.)	
RIGHT LANE CLOSED	
RIGHT LANE NARROWS	
RIGHT SHOULDER CLOSED	
ROAD CLOSED	
ROAD CLOSED XX MILES	
ROAD (SLIPPERY, ICE, ETC.)	
ROAD WORK	
ROAD WORK (OR CONSTRUCTION) (TONIGHT, TODAY, TOMORROW, DATE)	

ROAD WORK XX MILES  
SHOULDER (SLIPPERY, ICE, SOFT, BLOCKED, ETC.)  
NEW SIGNAL XX MILES  
SLOW 1 (OR 2) - WAY TRAFFIC  
SOFT SHOULDER  
STALLED VEHICLES AHEAD  
TRAFFIC BACKUP  
TRAFFIC SLOWS  
TRUCK CROSSING  
TRUCKS ENTERING  
TOW TRUCK AHEAD  
UNEVEN LANES  
WATER ON ROAD  
WET PAINT  
WORK ZONE XX MILES  
WORKERS AHEAD

## **SPECIAL NOTE FOR EROSION CONTROL**

---

### **I. DESCRIPTION**

Except as provided herein, perform all erosion and water pollution control work in accordance with the Department's Standard and Supplemental Specifications, and Standard and Sepia Drawings, current editions, and as directed by the Engineer. Section references are to the Standard Specifications. This work shall consist of:

(1) Developing and preparing a Best Management Practices Plan (BMP) tailored to suit the specific construction phasing for each site within the project; (2) Preparing the project site(s) for construction, including locating, furnishing, installing, and maintaining temporary and/or permanent erosion and water pollution control measures as required by the BMP prior to beginning any earth disturbing activity on the project site; (3) Clearing and grubbing and removal of all obstructions as required for construction; (4) Removing all erosion control devices when no longer needed; (5) Restoring all disturbed areas as nearly as possible to their original condition; (6) Preparing seedbeds and permanently seeding all disturbed areas; (7) Providing a Kentucky Erosion Prevention and Sediment Control Program (KEPSC) qualified inspector; and (8) Performing any other work to prevent erosion and/or water pollution as specified by this contract, required by the BMP, or as directed by the Engineer.

### **II. MATERIALS**

Except as provided herein, furnish all materials for erosion and water pollution control work in accordance with the Department's Standard and Supplemental Specifications, and Standard and Sepia Drawings, current editions, and as directed by the Engineer.

Provide for all materials to be sampled and tested in accordance with the Department's Sampling Manual. Unless directed otherwise by the Engineer, make the materials available for sampling a sufficient time in advance of the use of the materials to allow for the necessary time for testing.

### **III. CONSTRUCTION**

Except as provided herein, construct all erosion and water pollution control work in accordance with the Department's Standard and Supplemental Specifications, and Standard and Sepia Drawings, current editions, and as directed by the Engineer.

## Erosion Control Page 2 of 3

Be advised, these Erosion Control Plan Notes do not constitute a BMP plan for the project. Jointly with the Engineer, prepare a site specific BMP plan for each drainage area within the project in accordance with Section 213 and the supplemental specifications. Provide a unique BMP at each project site using good engineering practices taking into account existing site conditions, the type of work to be performed, and the construction phasing, methods and techniques to be utilized to complete the work. Be responsible for all erosion prevention, sediment control, and water pollution prevention measures required by the BMP for each site. Represent and warrant compliance with the Clean Water Act (33 USC Section 1251 et seq.), the 404 Permit, the 401 Water Quality Certification, and applicable state and local government agency laws, regulations, rules, specifications, and permits. Contrary to Section 105.05, in case of discrepancy between these notes, the Standard Specifications, interim Supplemental Specifications, Special and Special Notes, Standard and Sepia Drawings, and such state and local government agency requirements, adhere to the most restrictive requirement.

Conduct operations in such a manner as to minimize the amount of disturbed ground during each phase of the construction and limit the haul roads to the minimum required to perform the work. Preserve existing vegetation not required to be removed by the work or the contract. Seed and/or mulch disturbed areas at the earliest opportunity. Use silt fence, silt traps, temporary ditches, brush barriers, erosion control blankets, sodding, channel lining, and other erosion control measures in a timely manner as required by the BMP and as directed or approved by the Engineer. Prevent sediment laden water from leaving the project, entering an existing drainage structure, or entering a stream.

Provide for erosion control measures to be in place and functioning prior to any earth disturbance within a drainage area. Compute the volume and size of silt control devices necessary to control sediment during each phase of construction. Remove sediment from silt traps before they become a maximum of ½ full. Maintain silt fence by removing accumulated trappings and/or replacing the geotextile fabric when it becomes clogged, damaged, or deteriorated, or when directed by the Engineer. Properly dispose of all materials trapped by erosion control devices at approved sites off the right of way obtained by the Contractor at no additional cost to the Department (See Special Note for Waste and Borrow).

As work progresses, add or remove erosion control measures as required by the BMP applicable to the Contractor's project phasing and construction methods and techniques. Update the volume calculations and modify the BMP as necessary throughout the duration of the project. Ensure that an updated BMP is kept on site and available for public inspection throughout the life of the project.

After all construction is complete, restore all disturbed areas in accordance with Section 212. Completely remove all temporary erosion control devices not required as part of the permanent erosion control from the construction site. Prior to removal, obtain the Engineer's concurrence of items to be removed. Grade the remaining exposed earth (both on and off the Right of-Way) as nearly as possible to its original condition, or as directed by the Engineer. Prepare the seed bed areas and sow all exposed earthen areas with the applicable seed mixture(s) according to Section 212.03.03.

Erosion Control  
Page 3 of 3

#### **IV. MEASUREMENT**

Contrary to Section 212.04 and 213.04, the Department will not measure Erosion Control items for separate payment, but shall be incidental to Pavement Removal, DGA, Leveling and Wedging, and JPC Pavement as applicable



DEPARTMENT OF HIGHWAYS  
MAP OF  
CAMPBELL COUNTY

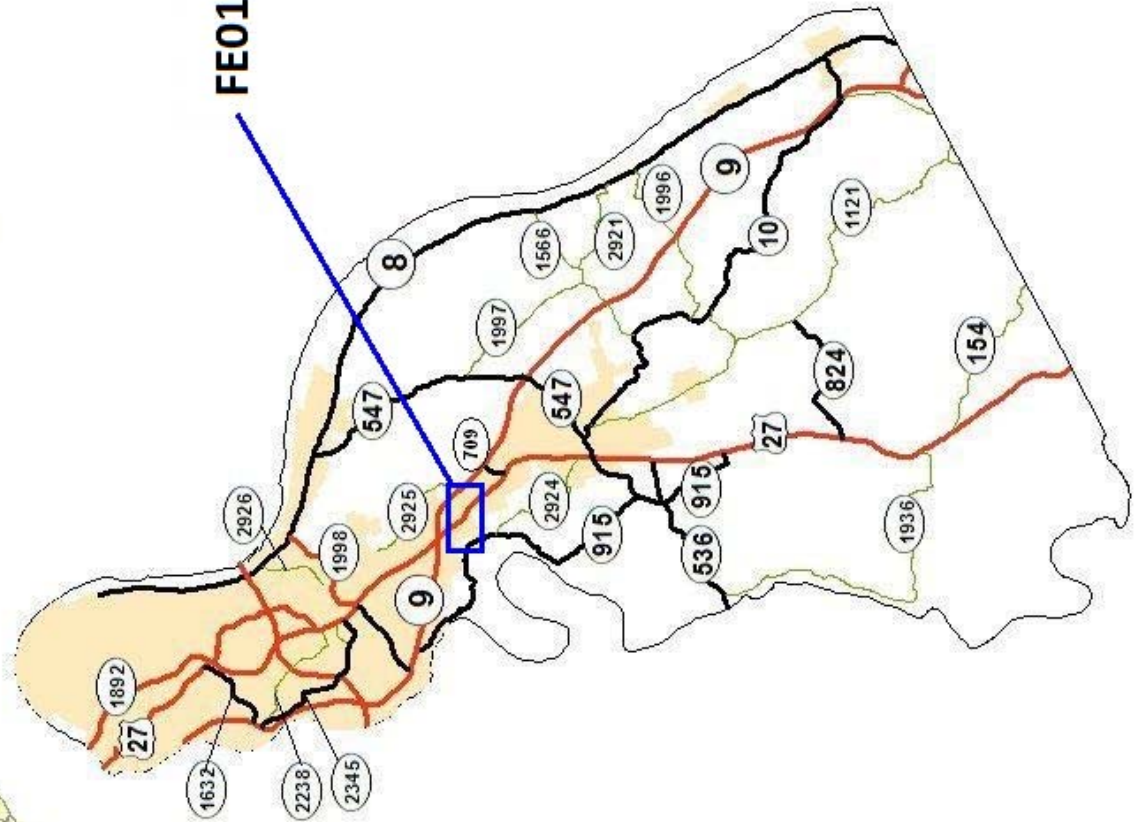

**FE01 019 0027 013-014**





### Typical Section

CAMPBELL COUNTY  
FE01 019 0027 013-014  
MP 13.050 - 13.150

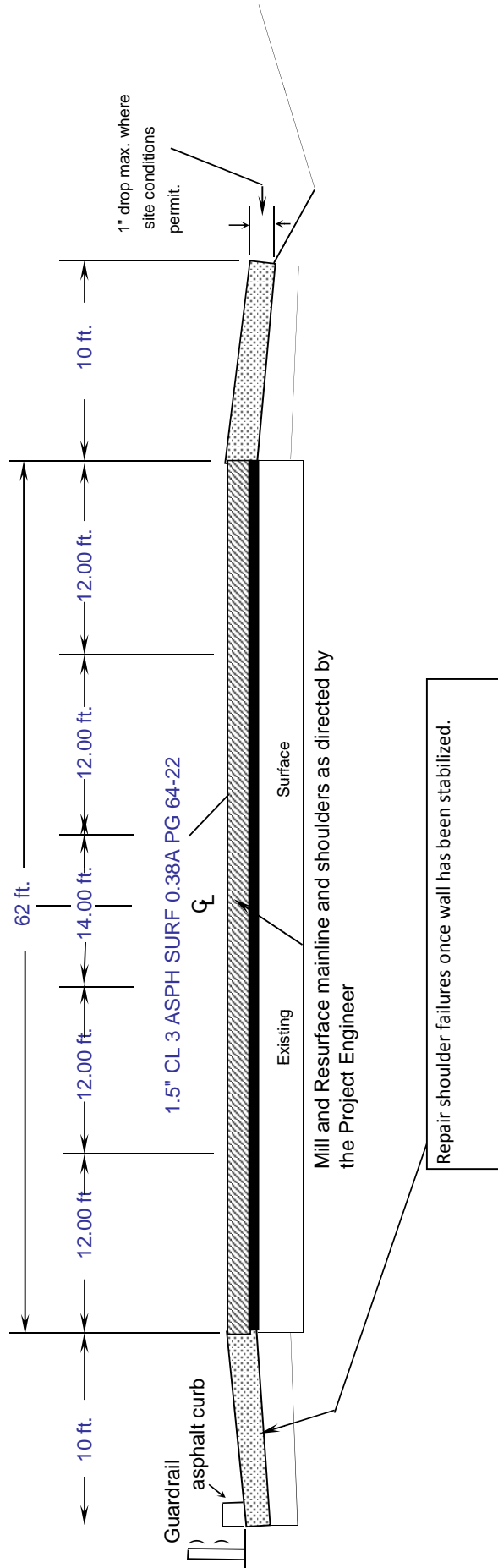

# PIPE REPLACEMENT AT RETAINING WALL ON US 27

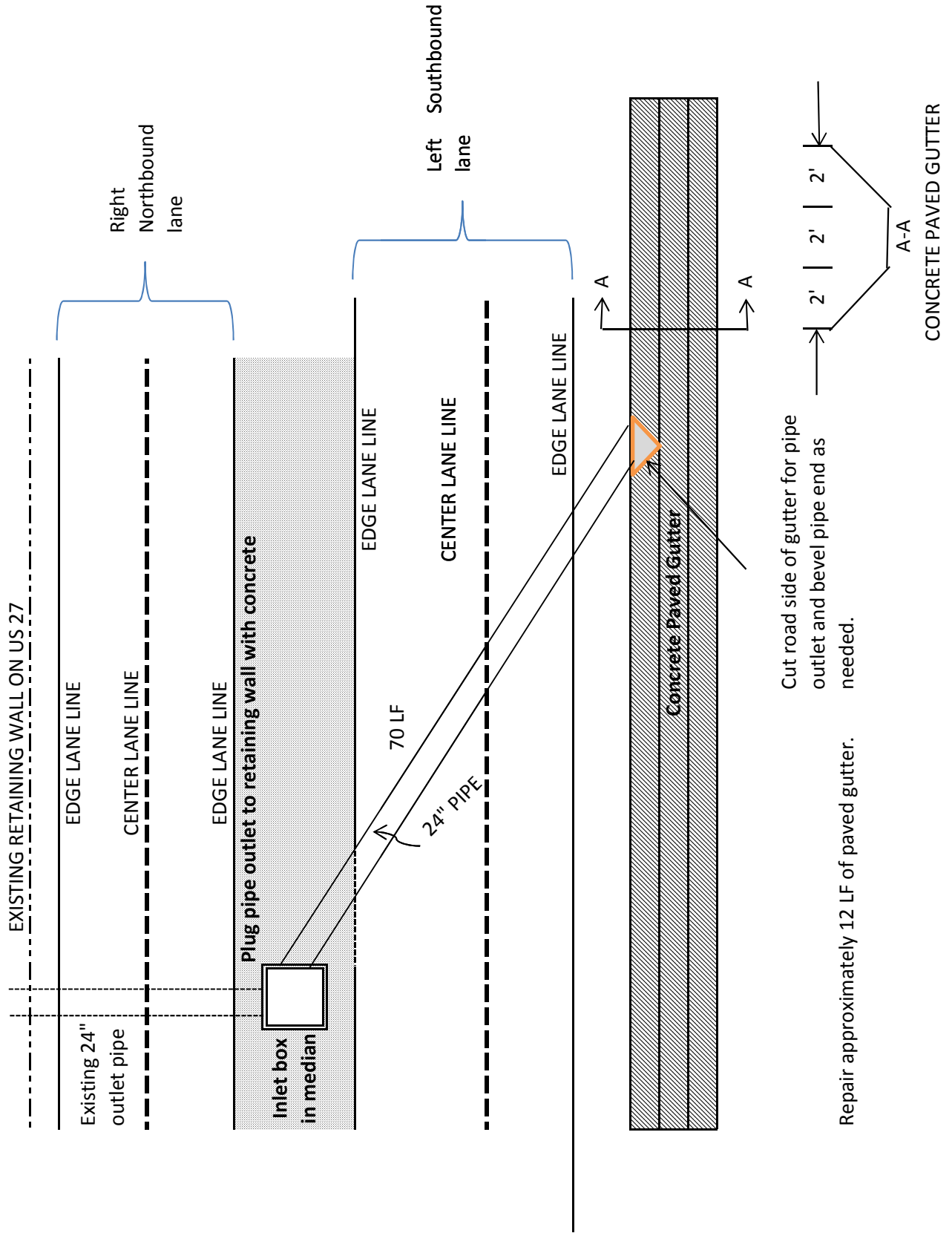



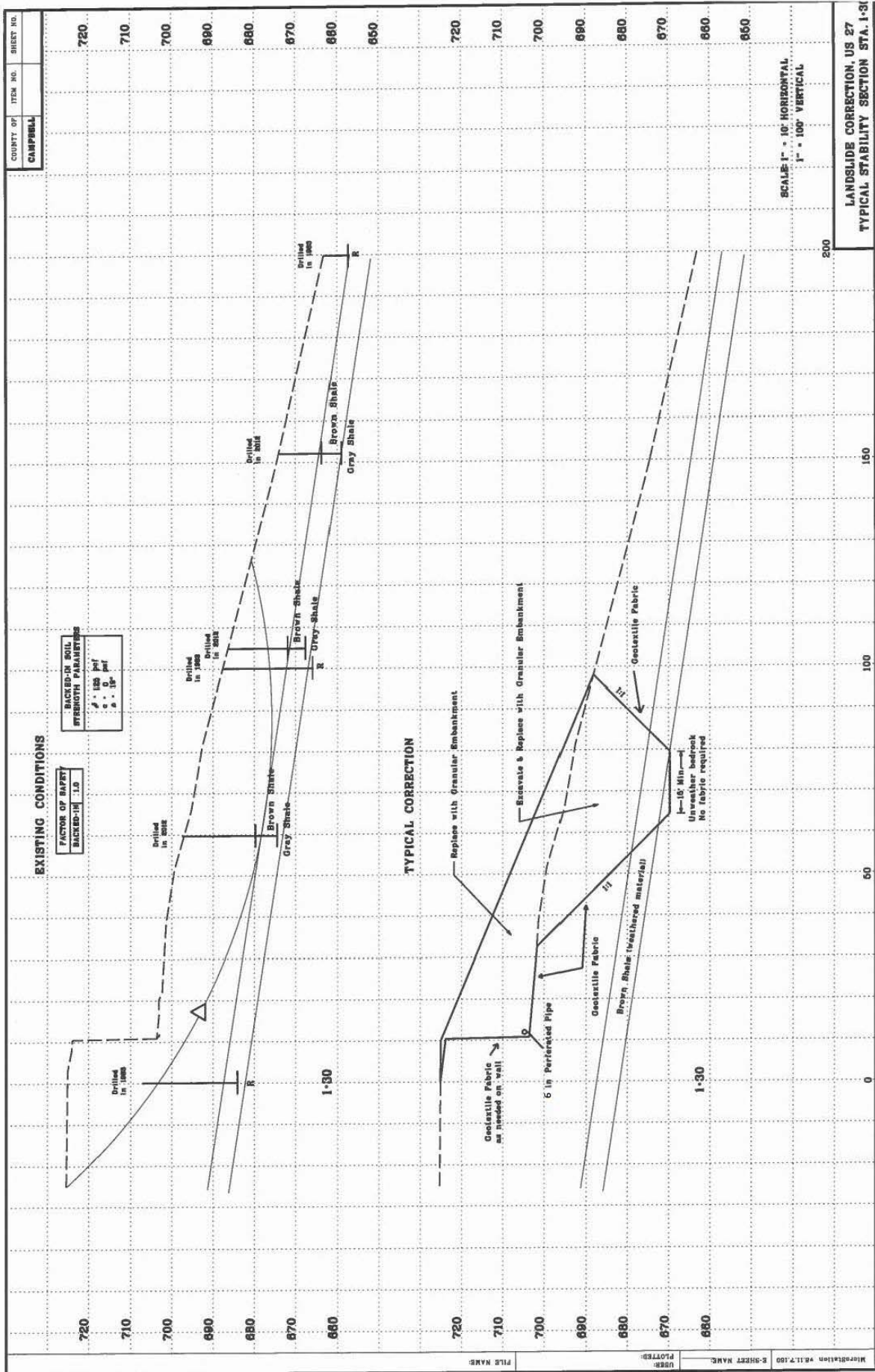

COUNTY DT	ITEM NO	SHEET NO

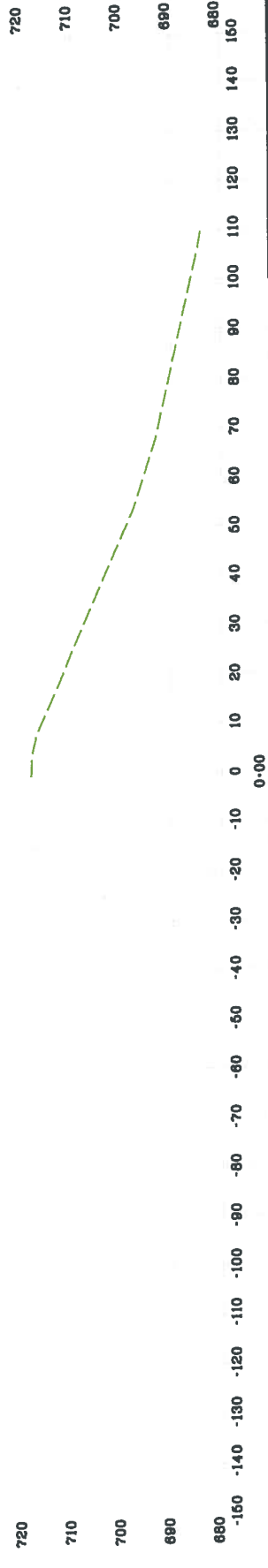
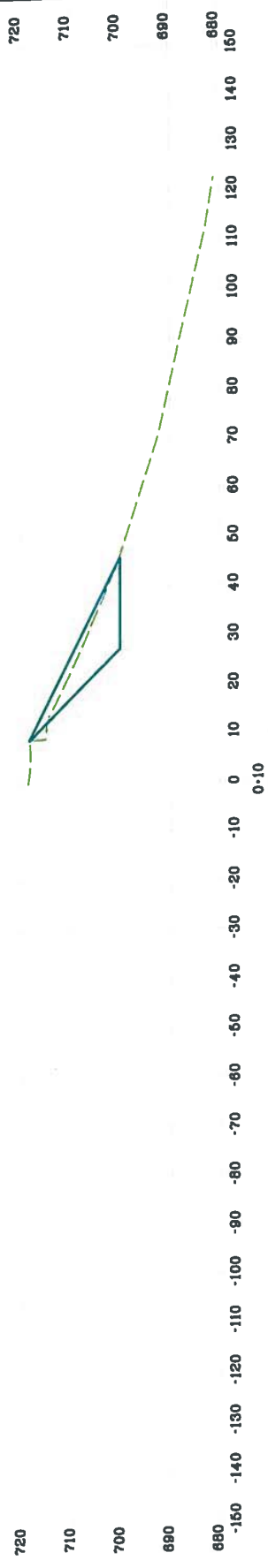
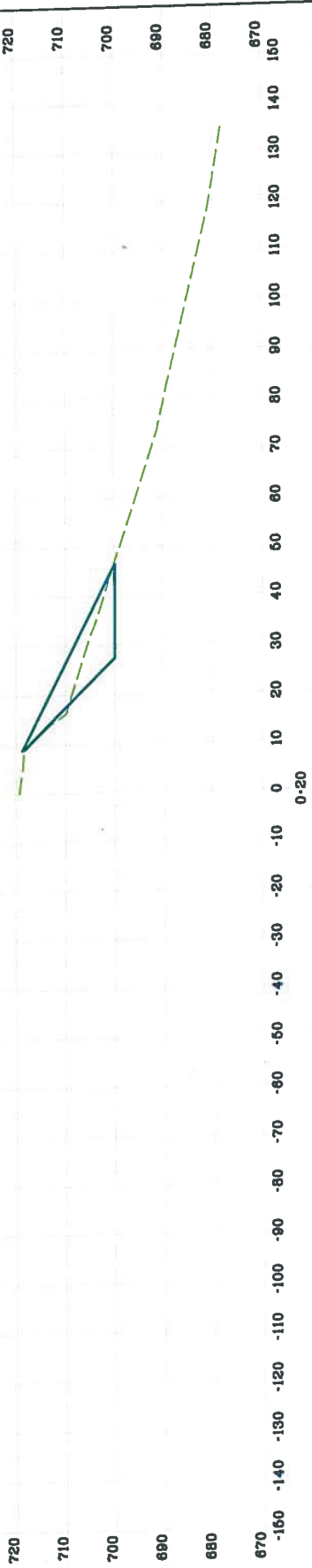

STA.0+00 TO STA.0+20

PREPARED BY: \_\_\_\_\_ DATE: \_\_\_\_\_  
 CHECKED BY: \_\_\_\_\_ DATE: \_\_\_\_\_  
 APPROVED BY: \_\_\_\_\_ DATE: \_\_\_\_\_

Cell Library: kyle cel  
 818 818  
 HH MM YYYY-MM-DD

COUNTY OF	ITEM NO	SHEET NO

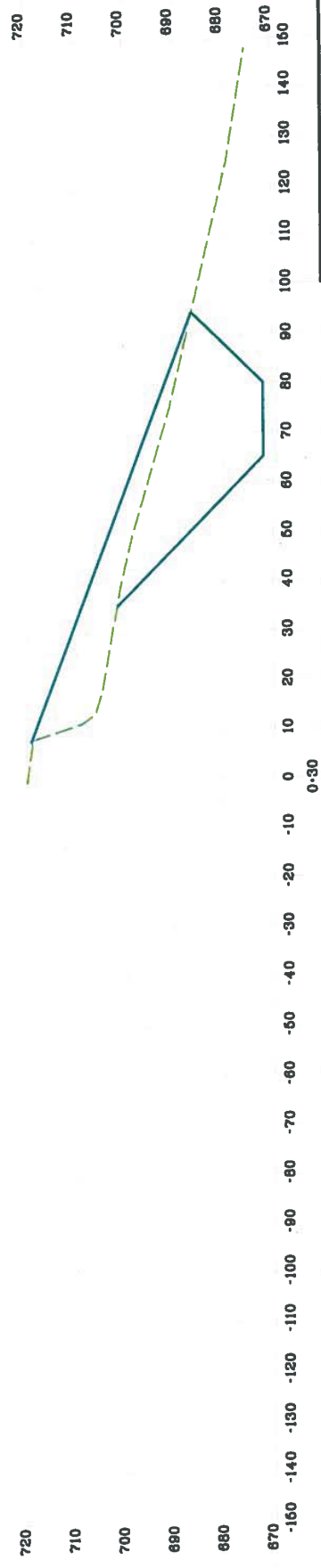
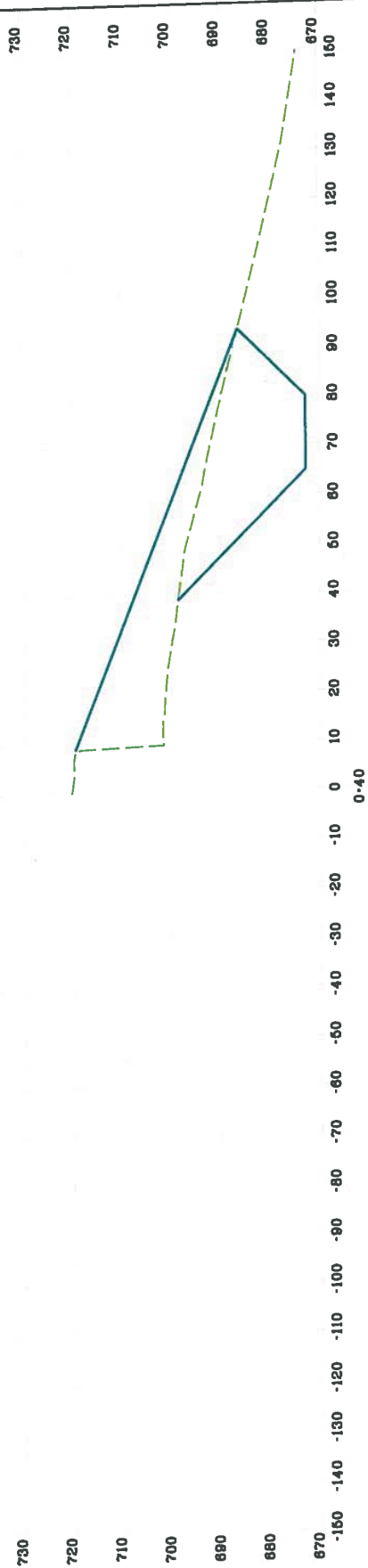

STA. 0-30 TO STA. 0-40

DATE	PREPARED BY
DATE	CHECKED BY
DATE	APPROVED BY

Call Library: bytel  
 Cell Name: 333  
 01-M-1111 H:MM

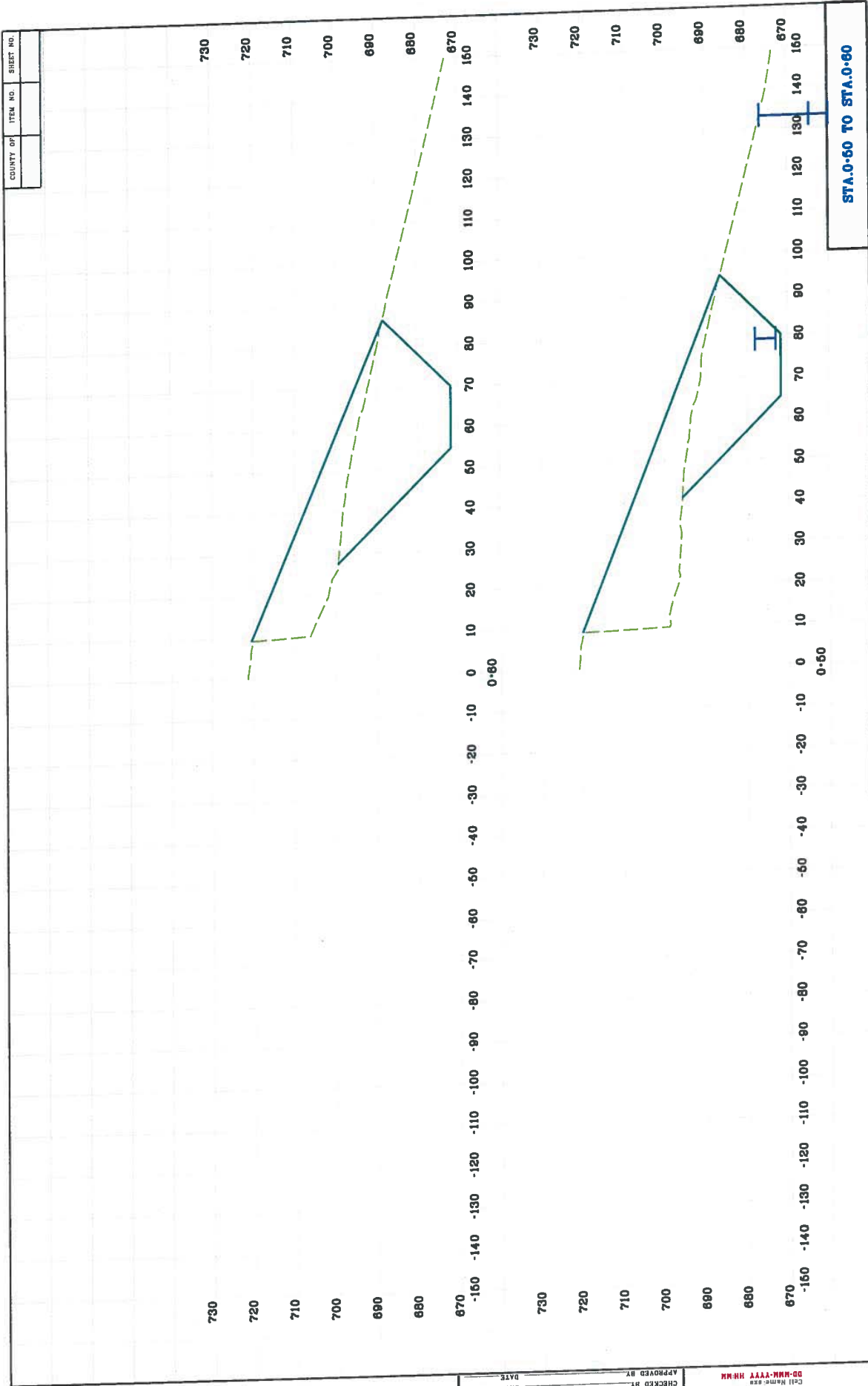

COUNTY OF	ITEM NO.	SUBSET NO.

730  
 720  
 710  
 700  
 690  
 680  
 670  
 -160 -140 -130 -120 -110 -100 -90 -80 -70 -60 -50 -40 -30 -20 -10 0 10 20 30 40 50 60 70 80 90 100 110 120 130 140 150 160  
 0-60

730  
 720  
 710  
 700  
 690  
 680  
 670  
 -160 -140 -130 -120 -110 -100 -90 -80 -70 -60 -50 -40 -30 -20 -10 0 10 20 30 40 50 60 70 80 90 100 110 120 130 140 150 160  
 0-50

STA.0-60 TO STA.0-60

PREPARED BY \_\_\_\_\_ DATE \_\_\_\_\_  
 CHECKED BY \_\_\_\_\_ DATE \_\_\_\_\_  
 APPROVED BY \_\_\_\_\_ DATE \_\_\_\_\_

Call Library Kylene  
 Cell Name: kxk  
 08-04-2011 11:11 AM

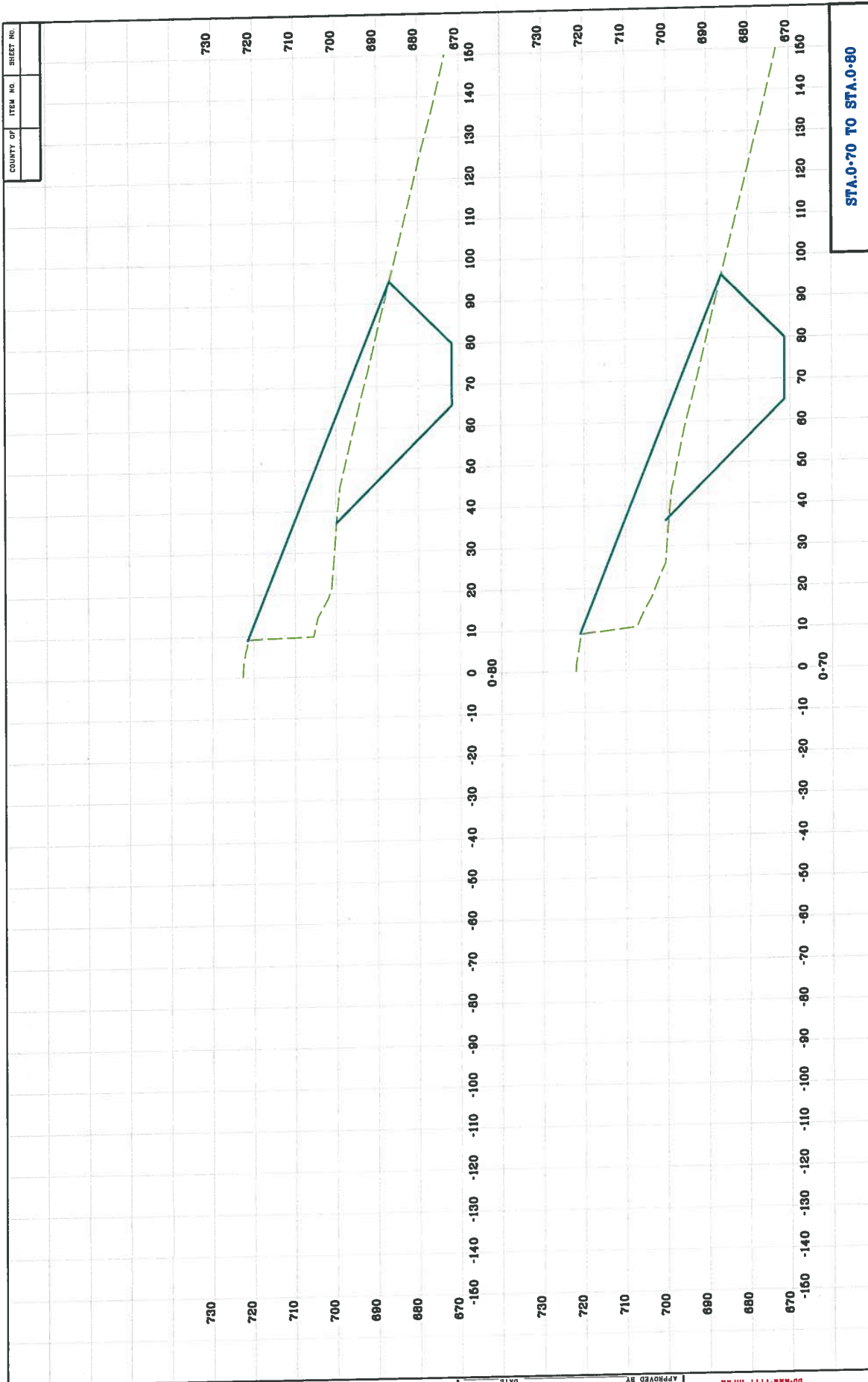

COUNTY OF	ITEM NO.	SHEET NO.

PREPARED BY	DATE
CHECKED BY	DATE
APPROVED BY	DATE

Call Library: kylec  
 Call Name: as  
 DD-MM-YYYY HR:MM

STA.0+70 TO STA.0+80

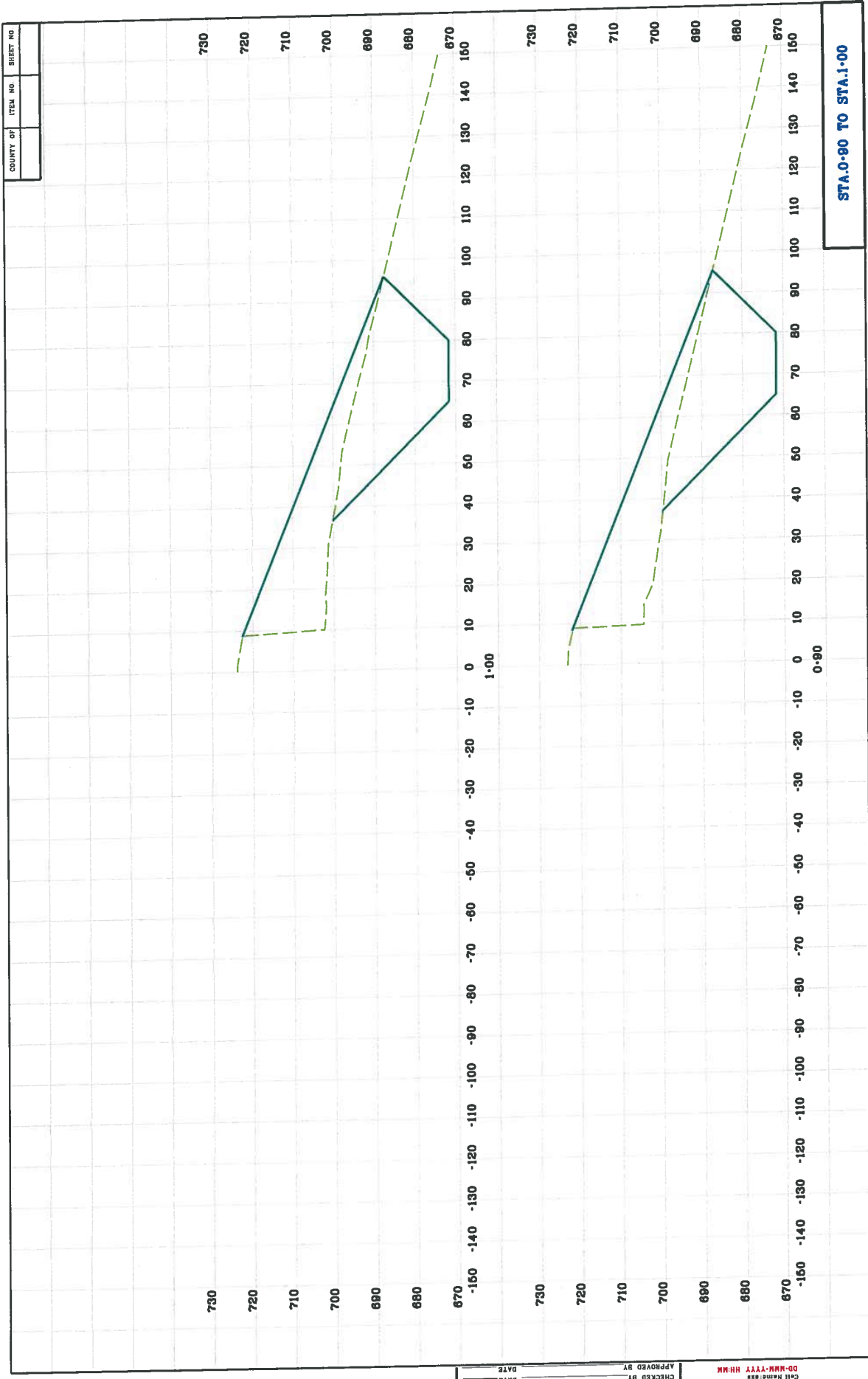

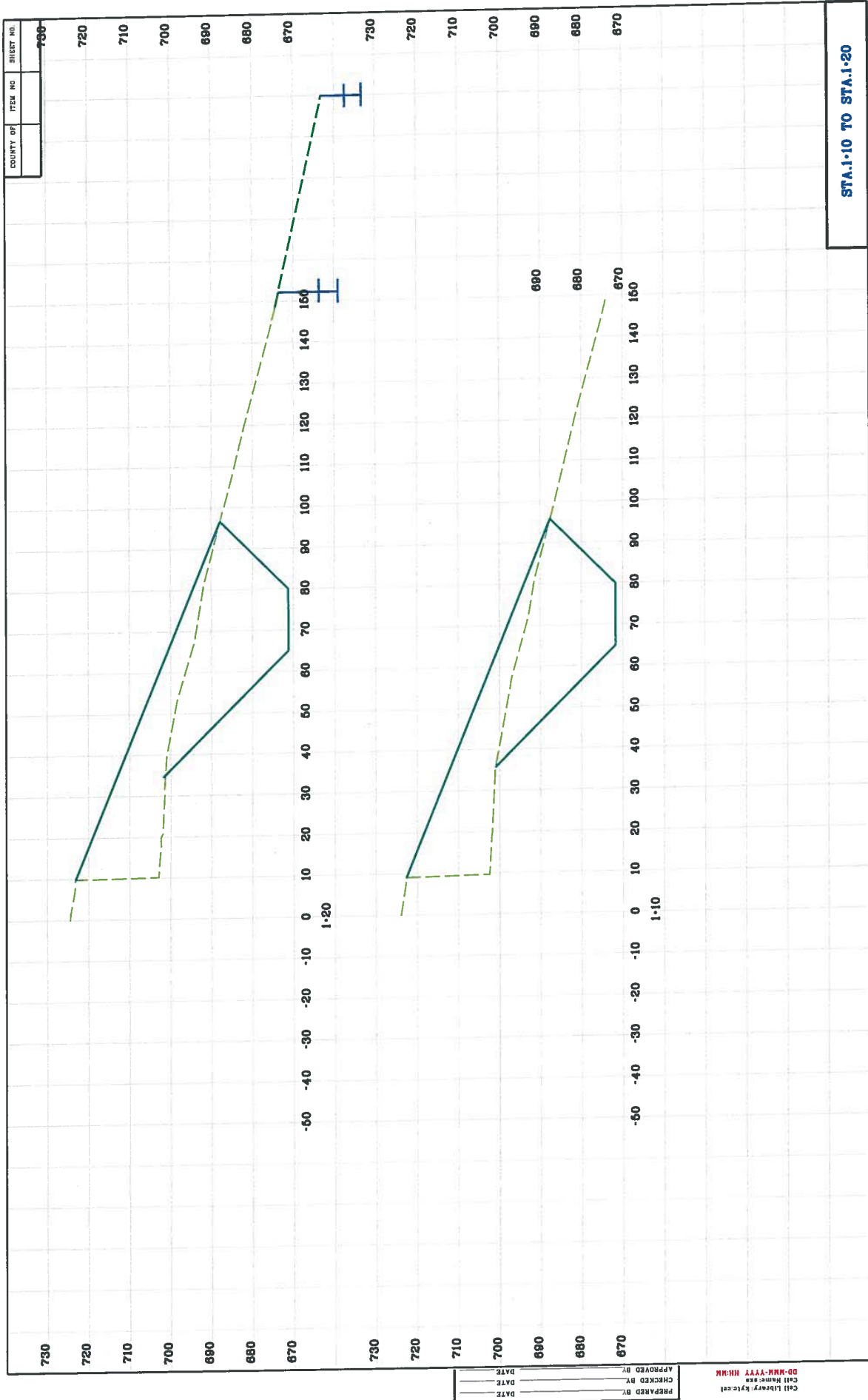

STA.1-10 TO STA.1-20

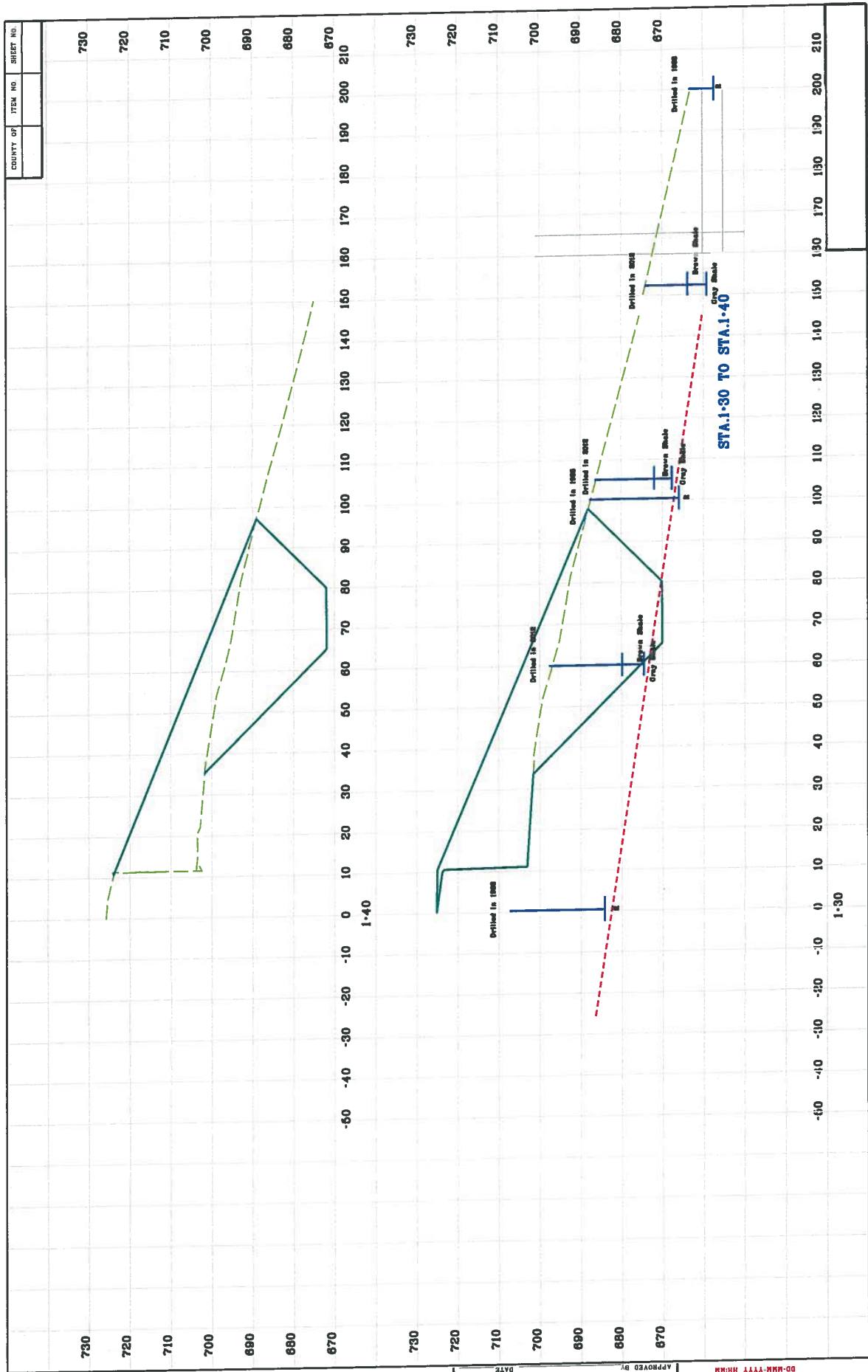

COUNTY OF	ITEM NO.	SHEET NO.
-----------	----------	-----------

730  
720  
710  
700  
690  
680  
670

730  
720  
710  
700  
690  
680  
670

-60 -40 -20 -10 0 10 20 30 40 50 60 70 80 90 100 110 120 130 140 150 160 170 180 190 200 210

DATE \_\_\_\_\_  
 CHECKED BY \_\_\_\_\_  
 DATE \_\_\_\_\_  
 PREPARED BY \_\_\_\_\_

Cell Library: kylec  
 DO-MNH-YTT-NH-M

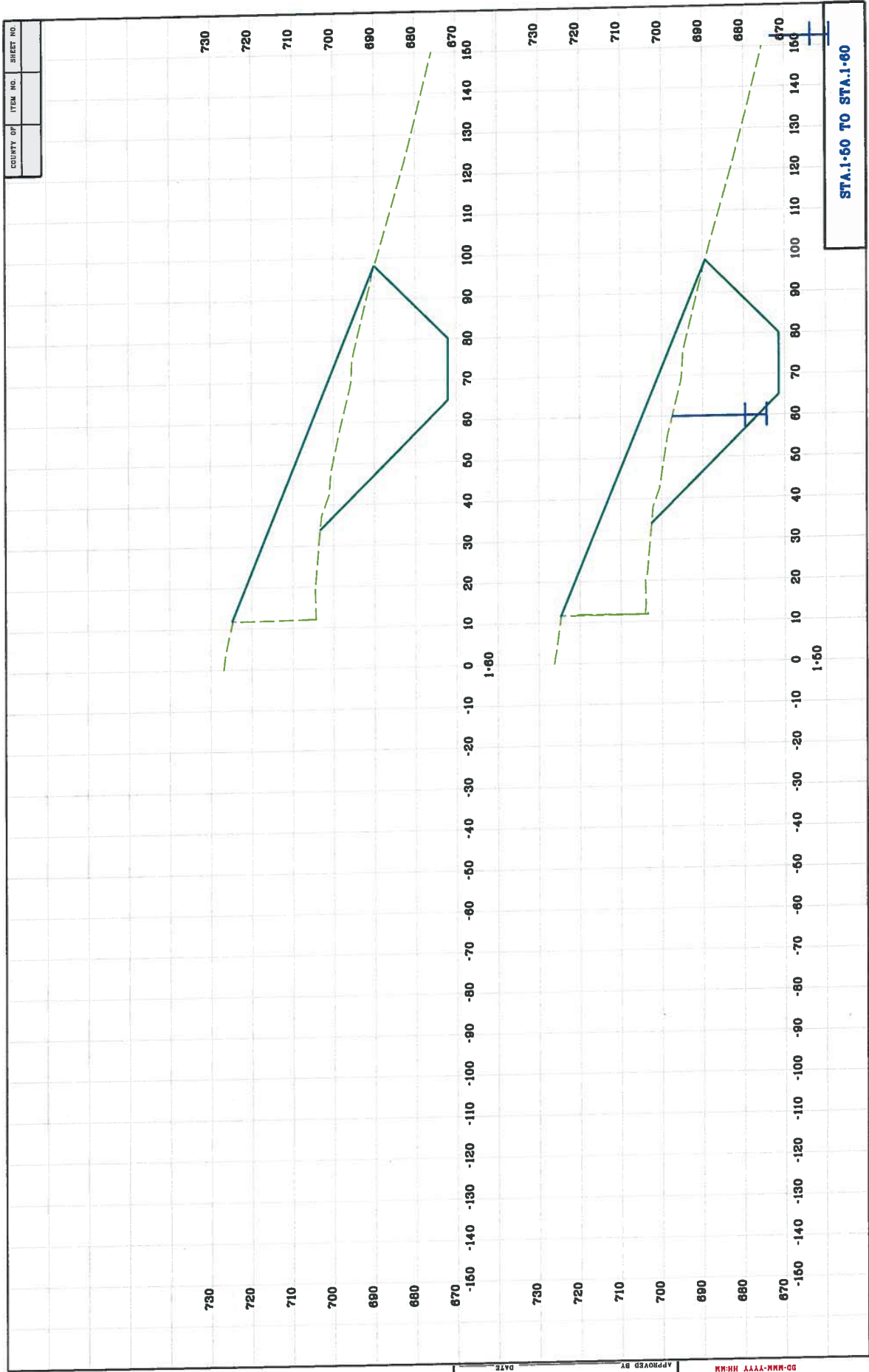

COUNTY OF	ITEM NO.	SHEET NO.

DATE	PREPARED BY
DATE	CHECKED BY
DATE	APPROVED BY

Cell Library: By:cel  
 00-MMM-YYYY HH:MM

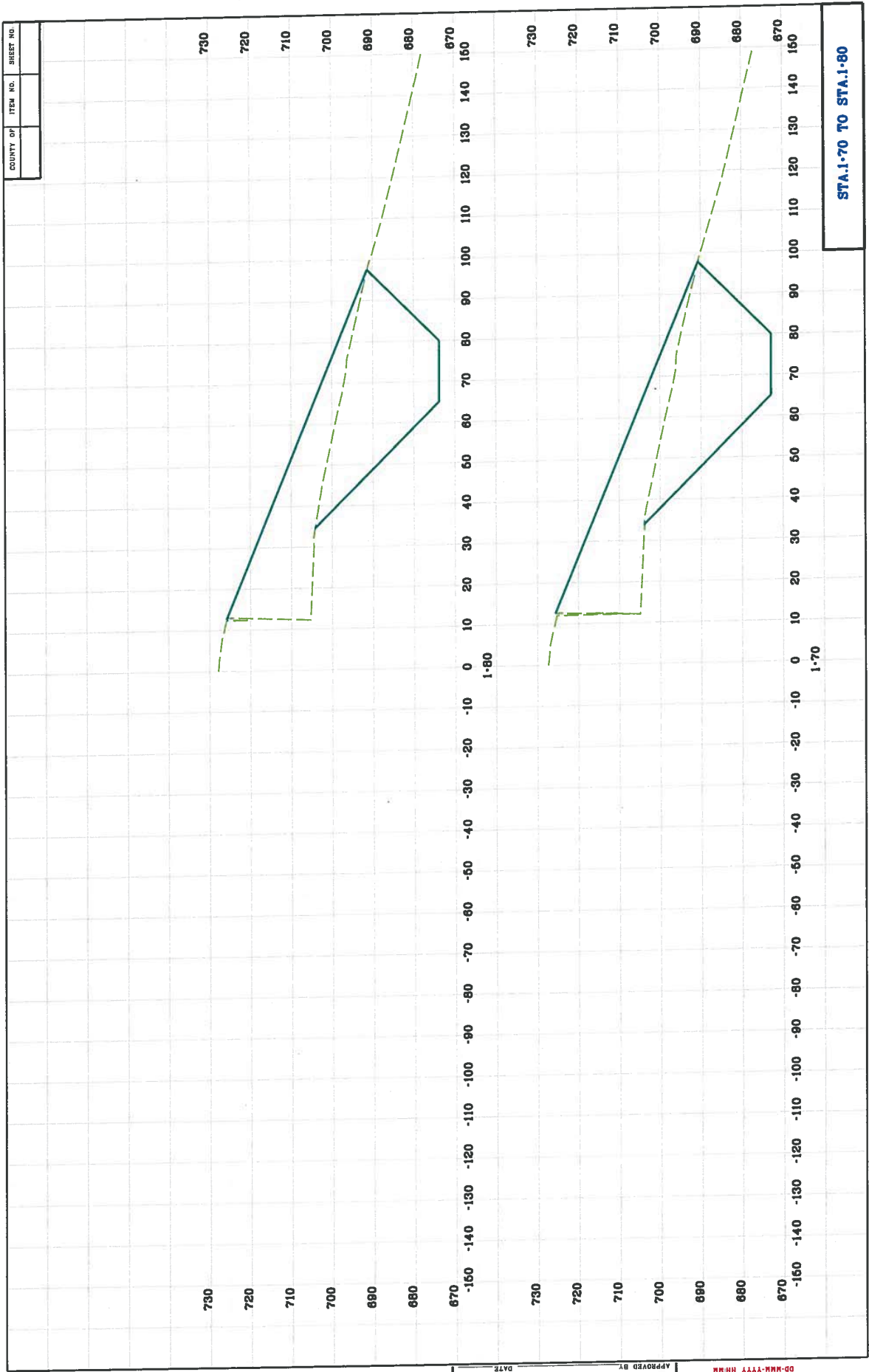

COUNTY OF	ITEM NO.	SHEET NO.

APPROVED BY	DATE
CHECKED BY	DATE
PREPARED BY	DATE

Cal Library kyle  
 Cal Home size  
 00-1111-1111 HMM

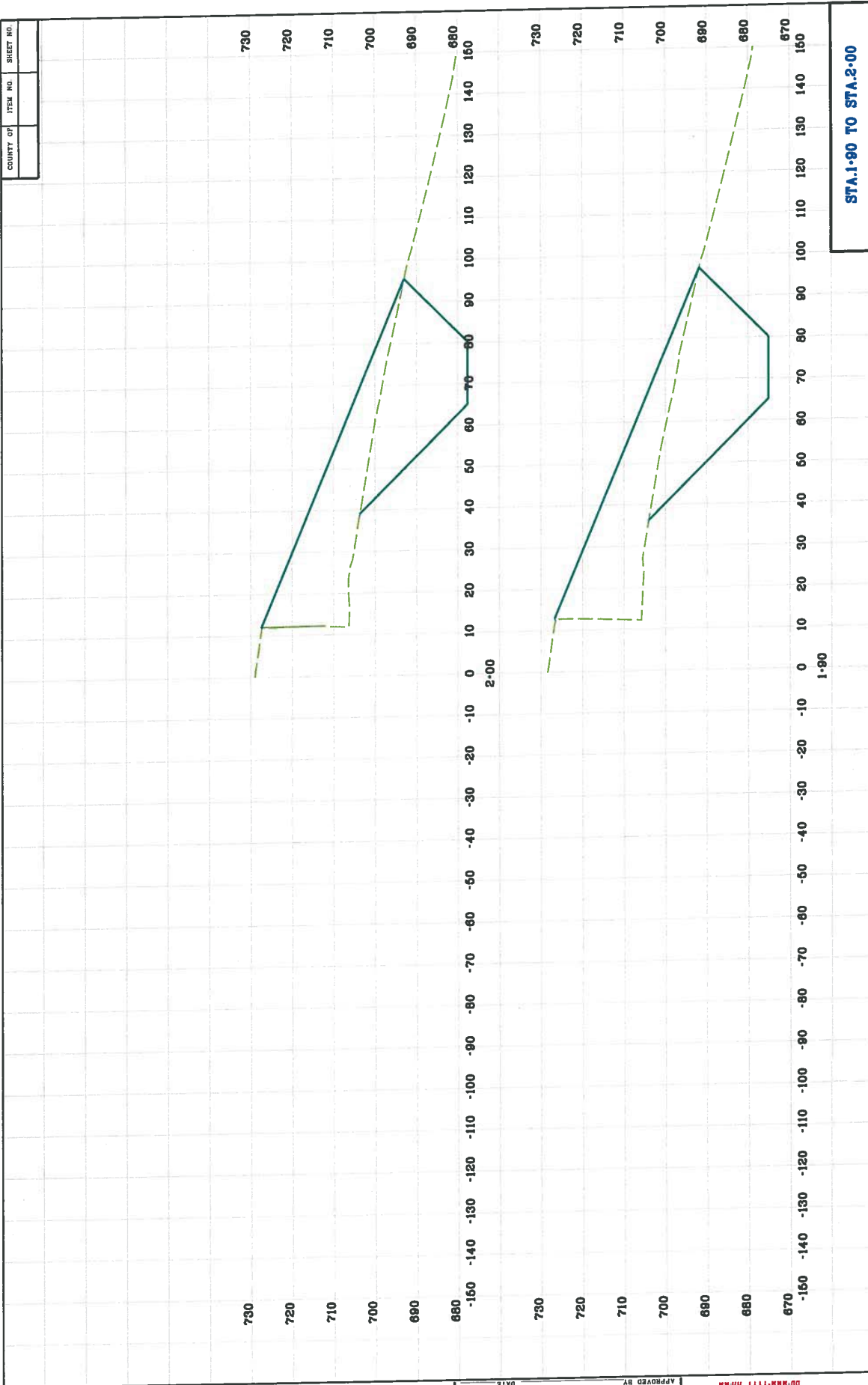



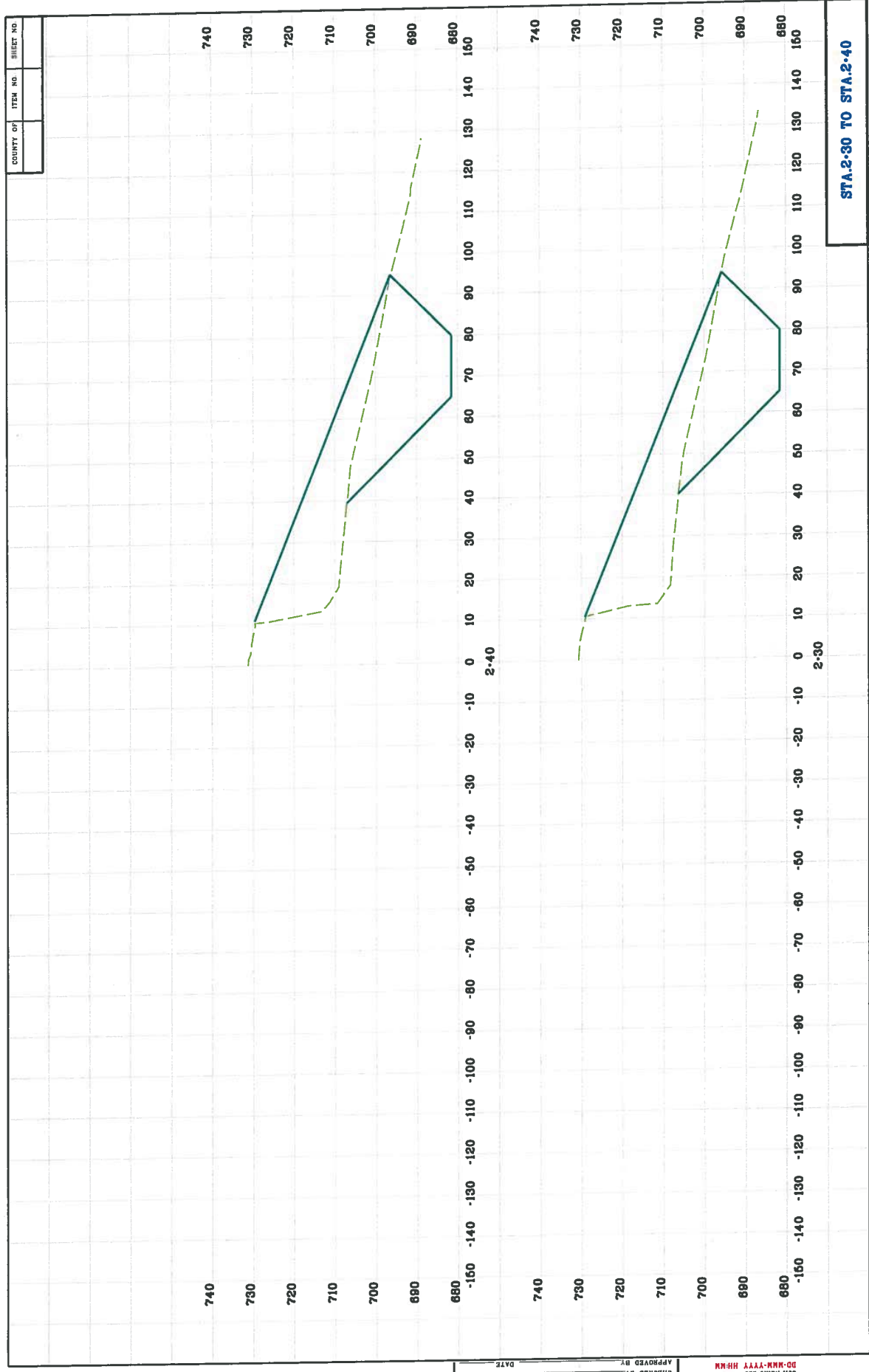

COUNTY OF	ITEM NO.	SHEET NO.
-----------	----------	-----------

STA. 2-30 TO STA. 2-40

PREPARED BY	DATE
CHECKED BY	DATE
APPROVED BY	DATE

Cell Library: hylc cel  
 00-MN-YYYY RHMN

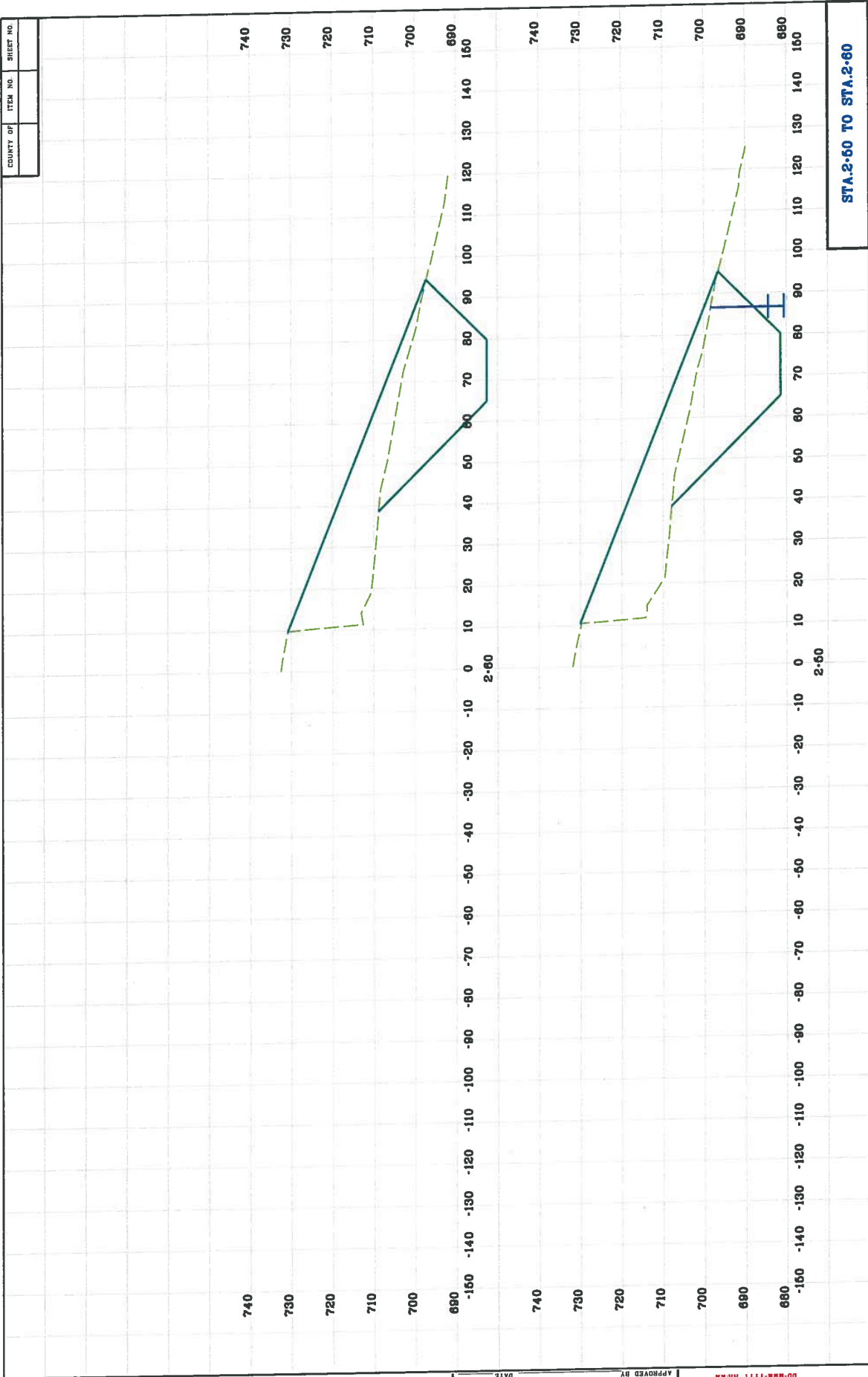

COUNTY OF	ITEM NO.	SHEET NO.

DATE	PREPARED BY
DATE	CHECKED BY
DATE	APPROVED BY

Call Library: Kylece  
DB: HMM\YYYY HMM

STA. 2-60 TO STA. 2-60

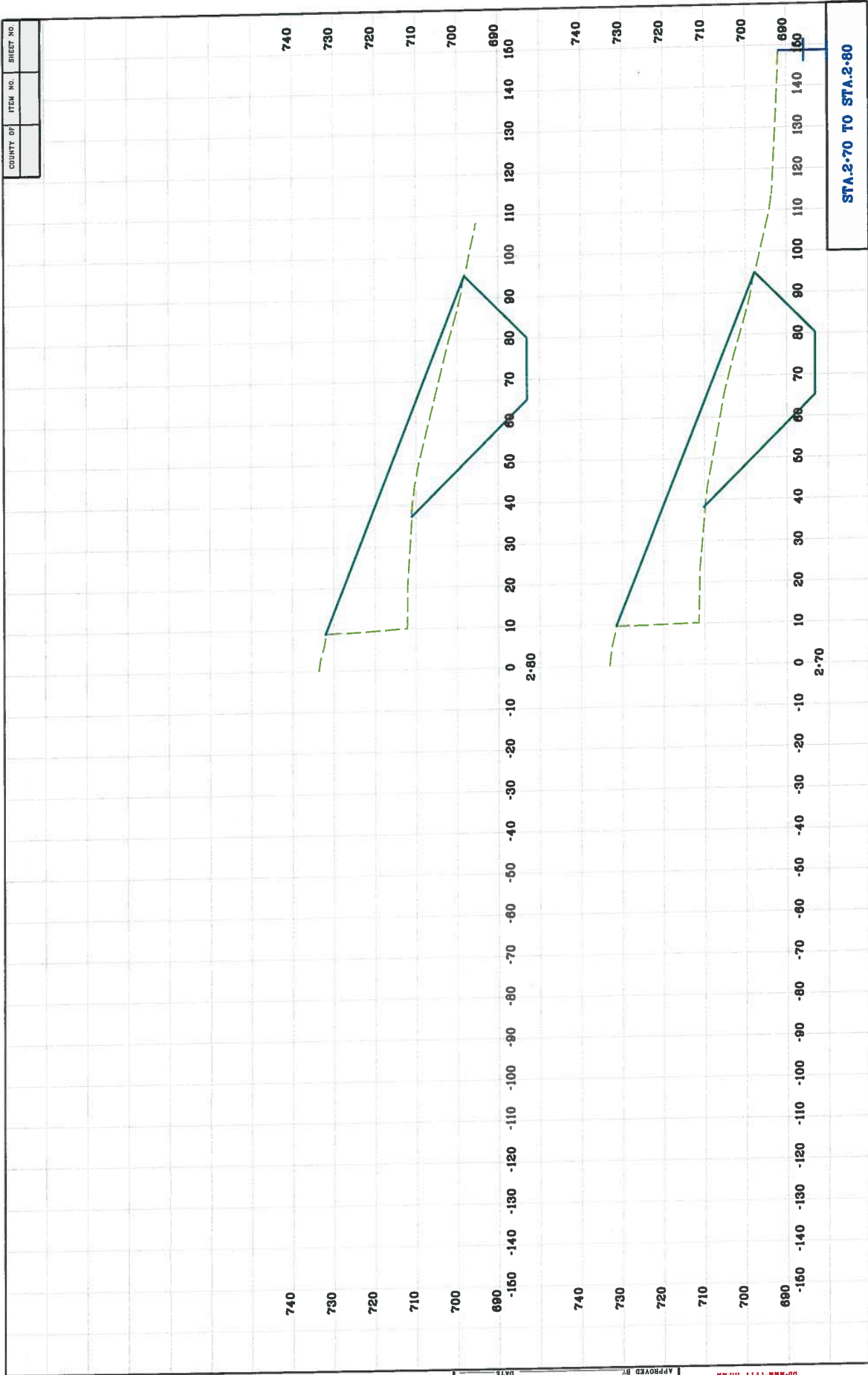

COUNTY OF	ITEM NO.	SHEET NO.

PREPARED BY	DATE
CHECKED BY	DATE
APPROVED BY	DATE

Cell Library: krcel  
 Cell Name: as  
 DD-MM-YYYY HH:MM

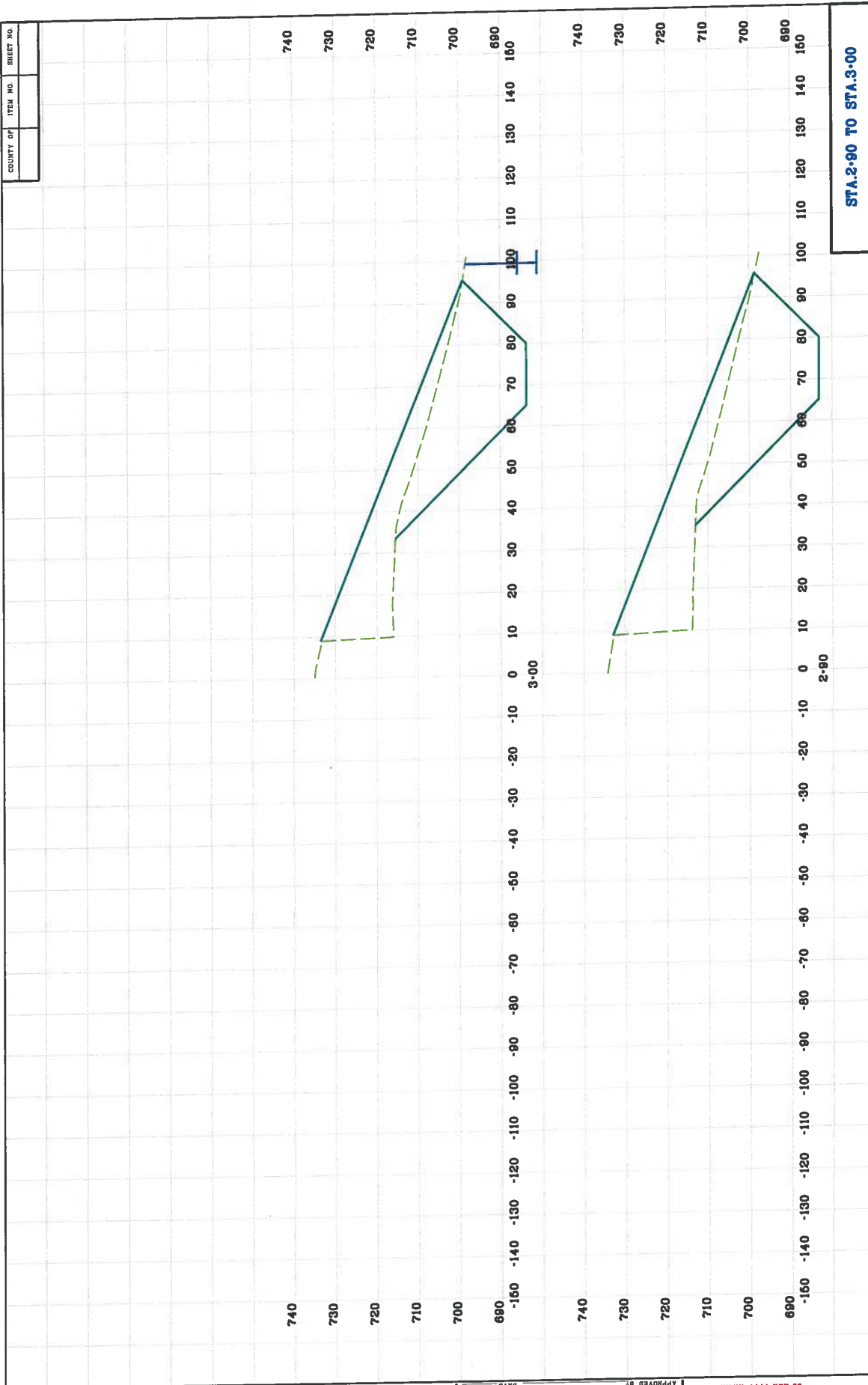

COUNTY OF	ITEM NO	SHEET NO

STA. 2+90 TO STA. 3+00

PREPARED BY	DATE
CHECKED BY	DATE
APPROVED BY	DATE

Cell Library: kycel  
DD-HMM-TTY HMM

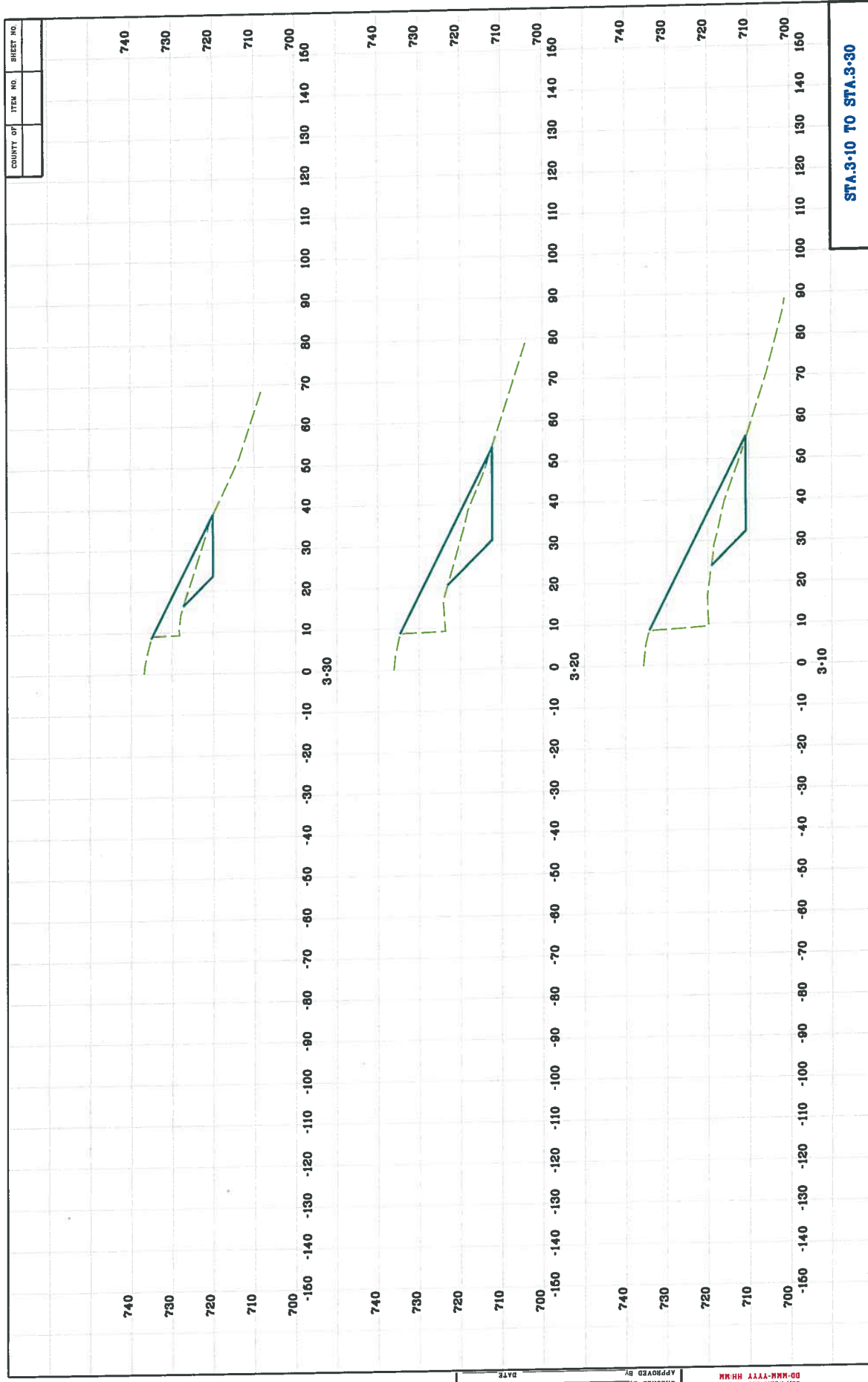

STA.3-10 TO STA.3-30

COUNTY OF	ITEM NO.	SHEET NO.

APPROVED BY	DATE
CHECKED BY	DATE
PREPARED BY	DATE

CALL LIBRARY KEYCOST  
 DP-HM-R-YYYY-HR-HM  
 REV. DATE

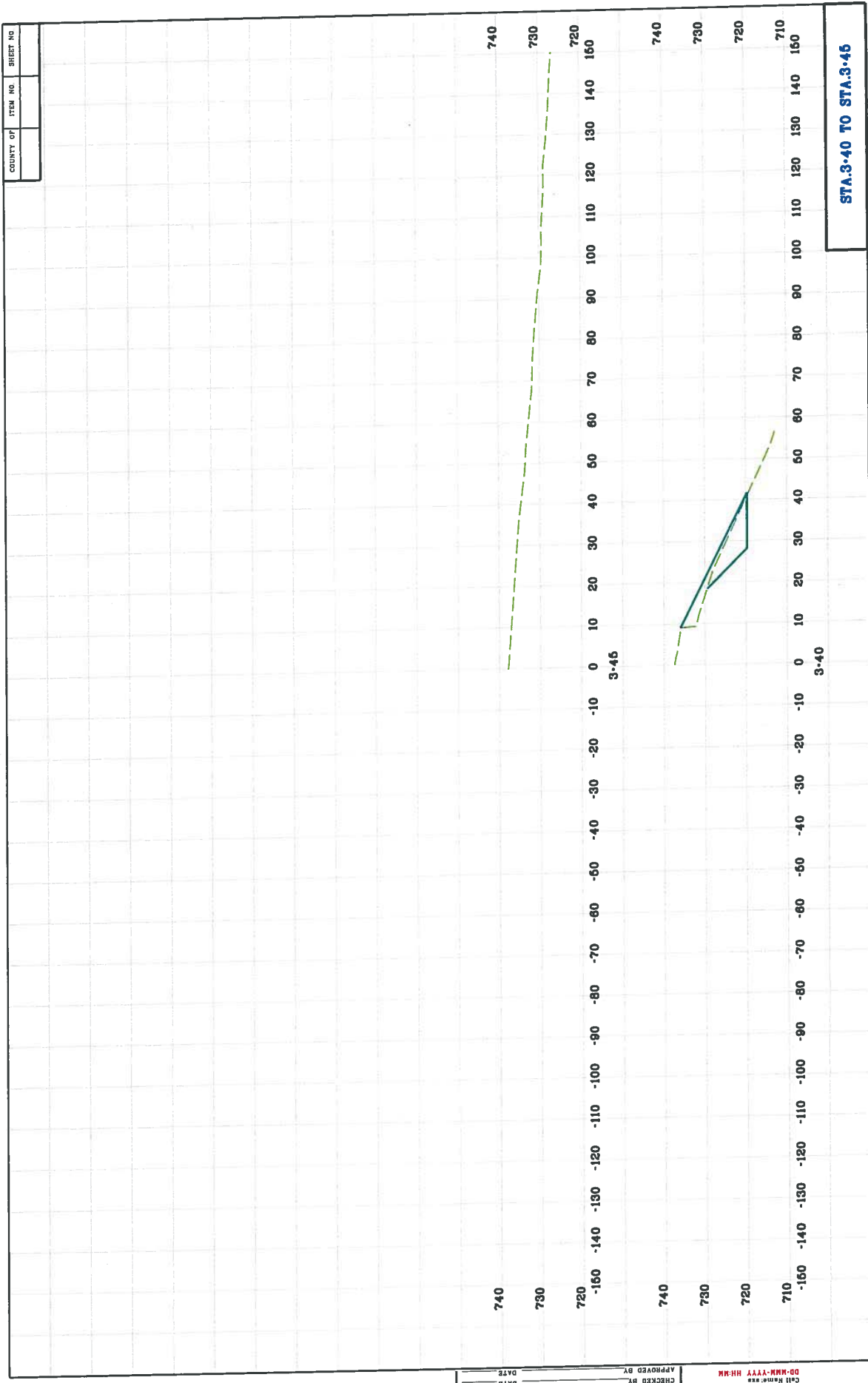

COUNTY OF	ITEM NO.	SHEET NO.

PREPARED BY \_\_\_\_\_ DATE \_\_\_\_\_  
 CHECKED BY \_\_\_\_\_ DATE \_\_\_\_\_  
 APPROVED BY \_\_\_\_\_ DATE \_\_\_\_\_

Call Liberty-Kyexcel  
 Cell Numbers  
 DD-MM-YYYY HH:MM

# GUARDRAIL DELIVERY VERIFICATION SHEET

**Contract Id:** \_\_\_\_\_

**Contractor:** \_\_\_\_\_

**Section Engineer:** \_\_\_\_\_

**District & County:** \_\_\_\_\_

<u>DESCRIPTION</u>	<u>UNIT</u>	<u>QTY LEAVING PROJECT</u>	<u>QTY RECEIVED@BB YARD</u>
GUARDRAIL (Includes End treatments & crash cushions)	LF	_____	_____
STEEL POSTS	EACH	_____	_____
STEEL BLOCKS	EACH	_____	_____
WOOD OFFSET BLOCKS	EACH	_____	_____
BACK UP PLATES	EACH	_____	_____
CRASH CUSHION	EACH	_____	_____
NUTS, BOLTS, WASHERS	BAG/BCKT	_____	_____
DAMAGED RAIL TO MAINT. FACILITY	LF	_____	_____
DAMAGED POSTS TO MAINT. FACILITY	EACH	_____	_____

**\*Required Signatures before Leaving Project Site**

Printed Section Engineer's Representative \_\_\_\_\_ & Date \_\_\_\_\_

Signature Section Engineer's Representative \_\_\_\_\_ & Date \_\_\_\_\_

Printed Contractor's Representative \_\_\_\_\_ & Date \_\_\_\_\_

Signature Contractor's Representative \_\_\_\_\_ & Date \_\_\_\_\_

**\*Required Signatures after Arrival at Bailey Bridge Yard (All material on truck must be counted & the quantity received column completed before signatures)**

Printed Bailey Bridge Yard Representative \_\_\_\_\_ & Date \_\_\_\_\_

Signature Bailey Bridge Yard Representative \_\_\_\_\_ & Date \_\_\_\_\_

Printed Contractor's Representative \_\_\_\_\_ & Date \_\_\_\_\_

Signature Contractor's Representative \_\_\_\_\_ & Date \_\_\_\_\_

\*\*Payment for the bid item remove guardrail will be based upon the quantities shown in the Bailey Bridge Yard received column. Payment will not be made for guardrail removal until the guardrail verification sheets are electronically submitted to the Section Engineer by the Bailey Bridge Yard Representative.

Completed Form Submitted to Section Engineer      Date: \_\_\_\_\_      By: \_\_\_\_\_

**PART II**  
**SPECIFICATIONS AND STANDARD DRAWINGS**

### **SPECIFICATIONS REFERENCE**

Any reference in the plans or proposal to previous editions of the *Standard Specifications for Road and Bridge Construction* and *Standard Drawings* are superseded by *Standard Specifications for Road and Bridge Construction, Edition of 2012* and *Standard Drawings, Edition of 2012 with the 2012 Revision*.

**Supplemental Specifications to the  
Standard Specifications for Road and Bridge Construction, 2012 Edition  
Effective with the July 31, 2015 Letting**

<b>Subsection:</b>	102.15 Process Agent.
<b>Revision:</b>	Replace the 1st paragraph with the following: Every corporation doing business with the Department shall submit evidence of compliance with KRS Sections 14A.4-010, 271B.11-010, 271B.11-070, 271B.11-080, 271B.5-010 and 271B.16-220, and file with the Department the name and address of the process agent upon whom process may be served.
<b>Subsection:</b>	105.13 Claims Resolution Process.
<b>Revision:</b>	Delete all references to TC 63-34 and TC 63-44 from the subsection as these forms are no longer available through the forms library and are forms generated within the AASHTO SiteManager software.
<b>Subsection:</b>	108.03 Preconstruction Conference.
<b>Revision:</b>	Replace 8) Staking with the following: 8) Staking (designated by a Professional Engineer or Land Surveyor licensed in the Commonwealth of Kentucky.
<b>Subsection:</b>	109.07.02 Fuel.
<b>Revision:</b>	Revise item Crushed Aggregate Used for Embankment Stabilization to the following: Crushed Aggregate Used for Stabilization of Unsuitable Materials Used for Embankment Stabilization
	Delete the following item from the table. <del>Crushed Sandstone Base (Cement Treated)</del>
<b>Subsection:</b>	110.02 Demobilization.
<b>Revision:</b>	Replace the first part of the first sentence of the second paragraph with the following: Perform all work and operations necessary to accomplish final clean-up as specified in the first paragraph of Subsection 105.12;
<b>Subsection:</b>	112.03.12 Project Traffic Coordinator (PTC).
<b>Revision:</b>	Replace the last paragraph of this subsection with the following: Ensure the designated PTC has sufficient skill and experience to properly perform the task assigned and has successfully completed the qualification courses.
<b>Subsection:</b>	112.04.18 Diversions (By-Pass Detours).
<b>Revision:</b>	Insert the following sentence after the 2nd sentence of this subsection. The Department will not measure temporary drainage structures for payment when the contract documents provide the required drainage opening that must be maintained with the diversion. The temporary drainage structures shall be incidental to the construction of the diversion. If the contract documents fail to provide the required drainage opening needed for the diversion, the cost of the temporary drainage structure will be handled as extra work in accordance with section 109.04.
<b>Subsection:</b>	201.03.01 Contractor Staking.
<b>Revision:</b>	Replace the first paragraph with the following: Perform all necessary surveying under the general supervision of a Professional Engineer or Land Surveyor licensed in the Commonwealth of Kentucky.

**Supplemental Specifications to the  
Standard Specifications for Road and Bridge Construction, 2012 Edition  
Effective with the July 31, 2015 Letting**

<b>Subsection:</b>	201.04.01 Contractor Staking.
<b>Revision:</b>	Replace the last sentence of the paragraph with the following: Complete the general layout of the project under the supervision of a Professional Engineer or Land Surveyor licensed in the Commonwealth of Kentucky.
<b>Subsection:</b>	206.04.01 Embankment-in-Place.
<b>Revision:</b>	Replace the fourth paragraph with the following: The Department will not measure <b>suitable</b> excavation included in the original plans that is disposed of for payment and will consider it incidental to Embankment-in-Place.
<b>Subsection:</b>	208.02.01 Cement.
<b>Revision:</b>	Replace paragraph with the following: Select Type I or Type II cement conforming to Section 801. Use the same type cement throughout the work.
<b>Subsection:</b>	208.03.06 Curing and Protection.
<b>Revision:</b>	Replace the fourth paragraph with the following: Do not allow traffic or equipment on the finished surface until the stabilized subgrade has cured for a total of 7-days with an ambient air temperature above 40 degrees Fahrenheit. A curing day consists of a continuous 24-hour period in which the ambient air temperature does not fall below 40 degrees Fahrenheit. Curing days will not be calculated consecutively, but must total seven (7) , 24-hour days with the ambient air temperature remaining at or above 40 degrees Fahrenheit before traffic or equipment will be allowed to traverse the stabilized subgrade. The Department may allow a shortened curing period when the Contractor requests. The Contractor shall give the Department at least 3 day notice of the request for a shortened curing period. The Department will require a minimum of 3 curing days after final compaction. The Contractor shall furnish cores to the treated depth of the roadbed at 500 feet intervals for each lane when a shortened curing time is requested. The Department will test cores using an unconfined compression test. Roadbed cores must achieve a minimum strength requirement of 80 psi.
<b>Subsection:</b>	208.03.06 Curing and Protection.
<b>Revision:</b>	Replace paragraph eight with the following: At no expense to the Department, repair any damage to the subgrade caused by freezing.
<b>Subsection:</b>	212.03.03 Permanent Seeding and Protection.
<b>Part:</b>	A) Seed Mixtures for Permanent Seeding.
<b>Revision:</b>	Revise <b>Seed Mix Type I</b> to the mixture shown below: 50% Kentucky 31 Tall Fescue (Festuca arundinacea) 35% Hard Fescue (Festuca (Festuca longifolia) 10% Ryegrass, Perennial (Lolium perenne) 5% White Dutch Clover (Trifolium repens)
<b>Subsection:</b>	212.03.03 Permanent Seeding and Protection.
<b>Part:</b>	A) Seed Mixtures for Permanent Seeding.
<b>Number:</b>	2)
<b>Revision:</b>	Replace the paragraph with the following: Permanent Seeding on Slopes Greater than 3:1 in Highway Districts 4, 5, 6, and 7. Apply seed mix Type II at a minimum application rate of 100 pounds per acre. If adjacent to a golf course replace the crown vetch with Kentucky 31 Tall Fescue.

**Supplemental Specifications to the  
 Standard Specifications for Road and Bridge Construction, 2012 Edition  
 Effective with the July 31, 2015 Letting**

<b>Subsection:</b>	212.03.03 Permanent Seeding and Protection.
<b>Part:</b>	A) Seed Mixtures for Permanent Seeding.
<b>Number:</b>	3)
<b>Revision:</b>	Replace the paragraph with the following: Permanent Seeding on Slopes Greater than 3:1 in Highway Districts 1, 2, 3, 8, 9, 10, 11, and 12. Apply seed mix Type III at a minimum application rate of 100 pounds per acre. If adjacent to crop land or golf course, replace the Sericea Lespedeza with Kentucky 31 Fescue.
<b>Subsection:</b>	212.03.03 Permanent Seeding and Protection.
<b>Part:</b>	B) Procedures for Permanent Seeding.
<b>Revision:</b>	Delete the first sentence of the section.
<b>Subsection:</b>	212.03.03 Permanent Seeding and Protection.
<b>Part:</b>	B) Procedures for Permanent Seeding.
<b>Revision:</b>	Replace the second and third sentence of the section with the following: Prepare a seedbed and apply an initial fertilizer that contains a minimum of 100 pounds of nitrogen, 100 pounds of phosphate, and 100 pounds of potash per acre. Apply agricultural limestone to the seedbed when the Engineer determines it is needed. When required, place agricultural limestone at a rate of 3 tons per acre.
<b>Subsection:</b>	212.03.03 Permanent Seeding and Protection.
<b>Part:</b>	D) Top Dressing.
<b>Revision:</b>	Change the title of part to D) Fertilizer.
<b>Subsection:</b>	212.03.03 Permanent Seeding and Protection.
<b>Part:</b>	D) Fertilizer.
<b>Revision:</b>	Replace the first paragraph with the following: Apply fertilizer at the beginning of the seeding operation and after vegetation is established. Use fertilizer delivered to the project in bags or bulk. Apply initial fertilizer to all areas prior to the seeding or sodding operation at the application rate specified in 212.03.03 B). Apply 20-10-10 fertilizer to the areas after vegetation has been established at a rate of 11.5 pounds per 1,000 square feet. Obtain approval from the Engineer prior to the 2nd fertilizer application. Reapply fertilizer to any area that has a streaked appearance. The reapplication shall be at no additional cost to the Department. Re-establish any vegetation severely damaged or destroyed because of an excessive application of fertilizer at no cost to the Department.
<b>Subsection:</b>	212.03.03 Permanent Seeding and Protection.
<b>Part:</b>	D) Fertilizer.
<b>Revision:</b>	Delete the second paragraph.
<b>Subsection:</b>	212.04.04 Agricultural Limestone.
<b>Revision:</b>	Replace the entire section with the following: The Department will measure the quantity of agricultural limestone in tons.
<b>Subsection:</b>	212.04.05 Fertilizer.
<b>Revision:</b>	Replace the entire section with the following: The Department will measure fertilizer used in the seeding or sodding operations for payment. The Department will measure the quantity by tons.

**Supplemental Specifications to the  
Standard Specifications for Road and Bridge Construction, 2012 Edition  
Effective with the July 31, 2015 Letting**

<b>Subsection:</b>	212.05 PAYMENT.												
<b>Revision:</b>	Delete the following item code:												
	<table border="1"> <thead> <tr> <th><u>Code</u></th> <th><u>Pay Item</u></th> <th><u>Pay Unit</u></th> </tr> </thead> <tbody> <tr> <td>05966</td> <td>Topdressing Fertilizer</td> <td>Ton</td> </tr> </tbody> </table>	<u>Code</u>	<u>Pay Item</u>	<u>Pay Unit</u>	05966	Topdressing Fertilizer	Ton						
<u>Code</u>	<u>Pay Item</u>	<u>Pay Unit</u>											
05966	Topdressing Fertilizer	Ton											
<b>Subsection:</b>	212.05 PAYMENT.												
<b>Revision:</b>	Add the following pay items:												
	<table border="1"> <thead> <tr> <th><u>Code</u></th> <th><u>Pay Item</u></th> <th><u>Pay Unit</u></th> </tr> </thead> <tbody> <tr> <td>05963</td> <td>Initial Fertilizer</td> <td>Ton</td> </tr> <tr> <td>05964</td> <td>20-10-10 Fertilizer</td> <td>Ton</td> </tr> <tr> <td>05992</td> <td>Agricultural Limestone</td> <td>Ton</td> </tr> </tbody> </table>	<u>Code</u>	<u>Pay Item</u>	<u>Pay Unit</u>	05963	Initial Fertilizer	Ton	05964	20-10-10 Fertilizer	Ton	05992	Agricultural Limestone	Ton
<u>Code</u>	<u>Pay Item</u>	<u>Pay Unit</u>											
05963	Initial Fertilizer	Ton											
05964	20-10-10 Fertilizer	Ton											
05992	Agricultural Limestone	Ton											
<b>Subsection:</b>	213.03.02 Progress Requirements.												
<b>Revision:</b>	Replace the last sentence of the third paragraph with the following: Additionally, the Department will apply a penalty equal to the liquidated damages when all aspects of work are not coordinated in an acceptable manner within 7 calendar days after written notification.												
<b>Subsection:</b>	213.03.05 Temporary Control Measures.												
<b>Part:</b>	E) Temporary Seeding and Protection.												
<b>Revision:</b>	Delete the second sentence of the first paragraph.												
<b>Subsection:</b>	304.02.01 Physical Properties.												
<b>Table:</b>	Required Geogrid Properties												
<b>Revision:</b>	Replace all references to Test Method "GRI-GG2-87" with ASTM D 7737.												
<b>Subsection:</b>	402.03.02 Contractor Quality Control and Department Acceptance.												
<b>Part:</b>	B) Sampling.												
<b>Revision:</b>	Replace the second sentence with the following: The Department will determine when to obtain the quality control samples using the random-number feature of the mix design submittal and approval spreadsheet. The Department will randomly determine when to obtain the verification samples required in Subsections 402.03.03 and 402.03.04 using the Asphalt Mixture Sample Random Tonnage Generator.												
<b>Subsection:</b>	402.03.02 Contractor Quality Control and Department Acceptance.												
<b>Part:</b>	D) Testing Responsibilities.												
<b>Number:</b>	3) VMA.												
<b>Revision:</b>	Add the following paragraph below Number 3) VMA: Retain the AV/VMA specimens and one additional corresponding G <sub>mm</sub> sample for 5 working days for mixture verification testing by the Department. For Specialty Mixtures, retain a mixture sample for 5 working days for mixture verification testing by the Department. When the Department's test results do not verify that the Contractor's quality control test results are within the acceptable tolerances according to Subsection 402.03.03, retain the samples and specimens from the affected subplot(s) for the duration of the project.												
<b>Subsection:</b>	402.03.02 Contractor Quality Control and Department Acceptance.												
<b>Part:</b>	D) Testing Responsibilities.												
<b>Number:</b>	4) Density.												
<b>Revision:</b>	Replace the second sentence of the Option A paragraph with the following: Perform coring by the end of the following work day.												

**Supplemental Specifications to the  
Standard Specifications for Road and Bridge Construction, 2012 Edition  
Effective with the July 31, 2015 Letting**

<b>Subsection:</b>	402.03.02 Contractor Quality Control and Department Acceptance.
<b>Part:</b>	D) Testing Responsibilities.
<b>Number:</b>	5) Gradation.
<b>Revision:</b>	Delete the second paragraph.
<b>Subsection:</b>	402.03.02 Contractor Quality Control and Department Acceptance.
<b>Part:</b>	H) Unsatisfactory Work.
<b>Number:</b>	1) Based on Lab Data.
<b>Revision:</b>	Replace the second paragraph with the following: When the Engineer determines that safety concerns or other considerations prohibit an immediate shutdown, continue work and the Department will make an evaluation of acceptability according to Subsection 402.03.05.
<b>Subsection:</b>	402.03.03 Verification.
<b>Revision:</b>	Replace the first paragraph with the following: <b>402.03.03 Mixture Verification.</b> For volumetric properties, the Department will perform a minimum of one verification test for AC, AV, and VMA according to the corresponding procedures as given in Subsection 402.03.02. The Department will randomly determine when to obtain the verification sample using the Asphalt Mixture Sample Random Tonnage Generator. For specialty mixtures, the Department will perform one AC and one gradation determination per lot according to the corresponding procedures as given in Subsection 402.03.02. However, Department personnel will not perform AC determinations according to KM 64-405. The Contractor will obtain a quality control sample at the same time the Department obtains the mixture verification sample and perform testing according to the procedures given in Subsection 402.03.02. If the Contractor's quality control sample is verified by the Department's test results within the tolerances provided below, the Contractor's sample will serve as the quality control sample for the affected subplot. The Department may perform the mixture verification test on the Contractor's equipment or on the Department's equipment.
<b>Subsection:</b>	402.03.03 Verification.
<b>Part:</b>	A) Evaluation of Subplot(s) Verified by Department.
<b>Revision:</b>	Replace the third sentence of the second paragraph with the following: When the paired <i>t</i> -test indicates that the Contractor's data and Department's data are possibly not from the same population, the Department will investigate the cause for the difference according to Subsection 402.03.05 and implement corrective measures as the Engineer deems appropriate.
<b>Subsection:</b>	402.03.03 Verification.
<b>Part:</b>	B) Evaluation of Subplots Not Verified by Department.
<b>Revision:</b>	Replace the third sentence of the first paragraph with the following: When differences between test results are not within the tolerances listed below, the Department will resolve the discrepancy according to Subsection 402.03.05.

**Supplemental Specifications to the  
Standard Specifications for Road and Bridge Construction, 2012 Edition  
Effective with the July 31, 2015 Letting**

<b>Subsection:</b>	402.03.03 Verification.
<b>Part:</b>	B) Evaluation of Sublots Not Verified by Department.
<b>Revision:</b>	Replace the third sentence of the second paragraph with the following: When the <i>F</i> -test or <i>t</i> -test indicates that the Contractor's data and Department's data are possibly not from the same population, the Department will investigate the cause for the difference according to Subsection 402.03.05 and implement corrective measures as the Engineer deems appropriate.
<b>Subsection:</b>	402.03.03 Verification.
<b>Part:</b>	C) Test Data Patterns.
<b>Revision:</b>	Replace the second sentence with the following: When patterns indicate substantial differences between the verified and non-verified sublots, the Department will perform further comparative testing according to subsection 402.03.05.
<b>Subsection:</b>	402.03 CONSTRUCTION.
<b>Revision:</b>	Add the following subsection: <b>402.03.04 Testing Equipment and Technician Verification.</b> For mixtures with a minimum quantity of 20,000 tons and for every 20,000 tons thereafter, the Department will obtain an additional verification sample at random using the Asphalt Mixture Sample Random Tonnage Generator in order to verify the integrity of the Contractor's and Department's laboratory testing equipment and technicians. The Department will obtain a mixture sample of at least 150 lb at the asphalt mixing plant according to KM 64-425 and split it according to AASHTO R 47. The Department will retain one split portion of the sample and provide the other portion to the Contractor. At a later time convenient to both parties, the Department and Contractor will simultaneously reheat the sample to the specified compaction temperature and test the mixture for AV and VMA using separate laboratory equipment according to the corresponding procedures given in Subsection 402.03.02. The Department will evaluate the differences in test results between the two laboratories. When the difference between the results for AV or VMA is not within $\pm 2.0$ percent, the Department will investigate and resolve the discrepancy according to Subsection 402.03.05.
<b>Subsection:</b>	402.03.04 Dispute Resolution.
<b>Revision:</b>	Change the subsection number to 402.03.05.
<b>Subsection:</b>	402.05 PAYMENT.
<b>Part:</b>	Lot Pay Adjustment Schedule Compaction Option A Base and Binder Mixtures
<b>Table:</b>	AC
<b>Revision:</b>	Replace the Deviation from JMF(%) that corresponds to a Pay Value of 0.95 to $\pm 0.6$ .
<b>Subsection:</b>	403.02.10 Material Transfer Vehicle (MTV).
<b>Revision:</b>	Replace the first sentence with the following: In addition to the equipment specified above, provide a MTV with the following minimum characteristics:
<b>Subsection:</b>	412.02.09 Material Transfer Vehicle (MTV).
<b>Revision:</b>	Replace the paragraph with the following: Provide and utilize a MTV with the minimum characteristics outlined in section 403.02.10.

**Supplemental Specifications to the  
Standard Specifications for Road and Bridge Construction, 2012 Edition  
Effective with the July 31, 2015 Letting**

<b>Subsection:</b>	412.03.07 Placement and Compaction.
<b>Revision:</b>	Replace the first paragraph with the following: Use a MTV when placing SMA mixture in the driving lanes. The MTV is not required on ramps and/or shoulders unless specified in the contract. When the Engineer determines the use of the MTV is not practical for a portion of the project, the Engineer may waive its requirement for that portion of pavement by a letter documenting the waiver.
<b>Subsection:</b>	412.04 MEASUREMENT.
<b>Revision:</b>	Add the following subsection: 412.04.03. Material Transfer Vehicle (MTV). The Department will not measure the MTV for payment and will consider its use incidental to the asphalt mixture.
<b>Subsection:</b>	501.03.05 Weather Limitations and Protection.
<b>Revision:</b>	Replace the reference to Subsection 501.03.19 in Paragraph 5, with Subsection 501.03.20.
<b>Subsection:</b>	501.03.19 Surface Tolerances and Testing Surface.
<b>Part:</b>	B) Ride Quality.
<b>Revision:</b>	Add the following to the end of the first paragraph: The Department will specify if the ride quality requirements are Category A or Category B when ride quality is specified in the Contract. Category B ride quality requirements shall apply when the Department fails to classify which ride quality requirement will apply to the Contract.
<b>Subsection:</b>	603.03.06 Cofferdams.
<b>Revision:</b>	Replace the seventh sentence of paragraph one with the following: Submit drawings that are stamped by a Professional Engineer licensed in the Commonwealth of Kentucky.
<b>Subsection:</b>	605.03.04 Tack Welding.
<b>Revision:</b>	Insert the subsection and the following: 605.03.04 Tack Welding. The Department does not allow tack welding.
<b>Subsection:</b>	606.03.17 Special Requirements for Latex Concrete Overlays.
<b>Part:</b>	A) Existing Bridges and New Structures.
<b>Number:</b>	1) Prewetting and Grout-Bond Coat.
<b>Revision:</b>	Add the following sentence to the last paragraph: Do not apply a grout-bond coat on bridge decks prepared by hydrodemolition.
<b>Subsection:</b>	609.03 Construction.
<b>Revision:</b>	Replace Subsection 609.03.01 with the following: 609.03.01 A) Swinging the Spans. Before placing concrete slabs on steel spans or precast concrete release the temporary erection supports under the bridge and swing the span free on its supports. 609.03.01 B) Lift Loops. Cut all lift loops flush with the top of the precast beam once the beam is placed in the final location and prior to placing steel reinforcement. At locations where lift loops are cut, paint the top of the beam with galvanized or epoxy paint.

**Supplemental Specifications to the  
 Standard Specifications for Road and Bridge Construction, 2012 Edition  
 Effective with the July 31, 2015 Letting**

<b>Subsection:</b>	611.03.02 Precast Unit Construction.
<b>Revision:</b>	Replace the first sentence of the subsection with the following: Construct units according to ASTM C1577, replacing <b>Table 1 (Design Requirements for Precast Concrete Box Sections Under Earth, Dead and HL-93 Live Load Conditions)</b> with <b>KY Table 1 (Precast Culvert KYHL-93 Design Table)</b> , and Section 605 with the following exceptions and additions:
<b>Subsection:</b>	613.03.01 Design.
<b>Number:</b>	2)
<b>Revision:</b>	Replace "AASHTO Standard Specifications for Highway Bridges" with "AASHTO LRFD Bridge Design Specifications"
<b>Subsection:</b>	615.06.02
<b>Revision:</b>	Add the following sentence to the end of the subsection. The ends of units shall be normal to walls and centerline except exposed edges shall be beveled $\frac{3}{4}$ inch.
<b>Subsection:</b>	615.06.03 Placement of Reinforcement in Precast 3-Sided Units.
<b>Revision:</b>	Replace the reference of 6.6 in the section to 615.06.06.
<b>Subsection:</b>	615.06.04 Placement of Reinforcement for Precast Endwalls.
<b>Revision:</b>	Replace the reference of 6.7 in the section to 615.06.07.
<b>Subsection:</b>	615.06.06 Laps, Welds, and Spacing for Precast 3-Sided Units.
<b>Revision:</b>	Replace the subsection with the following: Tension splices in the circumferential reinforcement shall be made by lapping. Laps may not be tack welded together for assembly purposes. For smooth welded wire fabric, the overlap shall meet the requirements of AASHTO 2012 Bridge Design Guide Section 5.11.2.5.2 and AASHTO 2012 Bridge Design Guide Section 5.11.6.3. For deformed welded wire fabric, the overlap shall meet the requirements of AASHTO 2012 Bridge Design Guide Section 5.11.2.5.1 and AASHTO 2012 Bridge Design Guide Section 5.11.6.2. The overlap of welded wire fabric shall be measured between the outer most longitudinal wires of each fabric sheet. For deformed billet-steel bars, the overlap shall meet the requirements of AASHTO 2012 Bridge Design Guide Section 5.11.2.1. For splices other than tension splices, the overlap shall be a minimum of 12" for welded wire fabric or deformed billet-steel bars. The spacing center to center of the circumferential wires in a wire fabric sheet shall be no less than 2 inches and no more than 4 inches. The spacing center to center of the longitudinal wires shall not be more than 8 inches. The spacing center to center of the longitudinal distribution steel for either line of reinforcing in the top slab shall be not more than 16 inches.
<b>Subsection:</b>	615.06.07 Laps, Welds, and Spacing for Precast Endwalls.
<b>Revision:</b>	Replace the subsection with the following: Splices in the reinforcement shall be made by lapping. Laps may not be tack welded together for assembly purposes. For smooth welded wire fabric, the overlap shall meet the requirements of AASHTO 2012 Bridge Design Guide Section 5.11.2.5.2 and AASHTO 2012 Bridge Design Guide Section 5.11.6.3. For deformed welded wire fabric, the overlap shall meet the requirements of AASHTO 2012 Bridge Design Guide Section 5.11.2.5.1 and AASHTO 2012 Bridge Design Guide Section 5.11.6.2. For deformed billet-steel bars, the overlap shall meet the requirements of AASHTO 2012 Bridge Design Guide Section 5.11.2.1. The spacing center-to-center of the wire fabric sheet shall not be less than 2 inches or more than 8 inches.

**Supplemental Specifications to the  
Standard Specifications for Road and Bridge Construction, 2012 Edition  
Effective with the July 31, 2015 Letting**

<b>Subsection:</b>	615.08.01 Type of Test Specimen.
<b>Revision:</b>	Replace the subsection with the following: Start-up slump, air content, unit weight, and temperature tests will be performed each day on the first batch of concrete. Acceptable start-up results are required for production of the first unit. After the first unit has been established, random acceptance testing is performed daily for each 50 yd <sup>3</sup> (or fraction thereof). In addition to the slump, air content, unit weight, and temperature tests, a minimum of one set of cylinders shall be required each time plastic property testing is performed.
<b>Subsection:</b>	615.08.02 Compression Testing.
<b>Revision:</b>	Delete the second sentence.
<b>Subsection:</b>	615.08.04 Acceptability of Core Tests.
<b>Revision:</b>	Delete the entire subsection.
<b>Subsection:</b>	615.12 Inspection.
<b>Revision:</b>	Add the following sentences to the end of the subsection: Units will arrive at jobsite with the "Kentucky Oval" stamped on the unit which is an indication of acceptable inspection at the production facility. Units shall be inspected upon arrival for any evidence of damage resulting from transport to the jobsite.
<b>Subsection:</b>	701.04.16 Deduction for Pipe Deflection.
<b>Revision:</b>	Insert the following at the end of the paragraph: The section length is determined by the length of the pipe between joints where the failure occurred.
<b>Subsection:</b>	716.02.02 Paint.
<b>Revision:</b>	Replace sentence with the following: Conform to Section 821.
<b>Subsection:</b>	716.03 CONSTRUCTION.
<b>Revision:</b>	Replace bullet 5) with the following: 5) AASHTO Standard Specifications for Structural Supports for Highway Signs, Luminaires, and Traffic Signals, 2013-6th Edition with current interims,
<b>Subsection:</b>	716.03.02 Lighting Standard Installation.
<b>Revision:</b>	Replace the second sentence with the following: Regardless of the station and offset noted, locate all poles/bases behind the guardrail a minimum of four feet from the front face of the guardrail to the front face of the pole base.
<b>Subsection:</b>	716.03.02 Lighting Standard Installation.
<b>Part:</b>	A) Conventional Installation.
<b>Revision:</b>	Replace the third sentence with the following: Orient the transformer base so the door is positioned on the side away from on-coming traffic.
<b>Subsection:</b>	716.03.02 Lighting Standard Installation.
<b>Part:</b>	A) Conventional Installation.
<b>Number:</b>	1) Breakaway Installation and Requirements.
<b>Revision:</b>	Replace the first sentence with the following: For breakaway supports, conform to Section 12 of the AASHTO Standard Specifications for Structural Supports for Highway Signs, Luminaires, and Traffic Signals, 2013-6th Edition with current interims.
<b>Subsection:</b>	716.03.02 Lighting Standard Installation.
<b>Part:</b>	B) High Mast Installation
<b>Revision:</b>	Replace the first sentence with the following: Install each high mast pole as noted on plans.

**Supplemental Specifications to the  
Standard Specifications for Road and Bridge Construction, 2012 Edition  
Effective with the July 31, 2015 Letting**

<b>Subsection:</b>	716.03.02 Lighting Standard Installation.																																																
<b>Part:</b>	B) High Mast Installation																																																
<b>Number:</b>	2) Concrete Base Installation																																																
<b>Revision:</b>	Modification of Chart and succeeding paragraphs within this section:																																																
	<table border="1" style="margin-left: auto; margin-right: auto;"> <thead> <tr> <th colspan="8">Drilled Shaft Depth Data</th> </tr> <tr> <th colspan="2">Level Ground</th> <th colspan="2">3:1 Ground Slope</th> <th colspan="2">2:1 Ground Slope</th> <th colspan="2">1.5:1 Ground Slope <sup>(2)</sup></th> </tr> <tr> <th>Soil</th> <th>Rock</th> <th>Soil</th> <th>Rock</th> <th>Soil</th> <th>Rock</th> <th>Soil</th> <th>Rock</th> </tr> </thead> <tbody> <tr> <td>17 ft</td> <td>7 ft</td> <td>19 ft</td> <td>7 ft</td> <td>20 ft</td> <td>7 ft</td> <td>(1)</td> <td>7 ft</td> </tr> </tbody> </table> <table border="1" style="margin-left: auto; margin-right: auto;"> <thead> <tr> <th colspan="4">Steel Requirements</th> </tr> <tr> <th colspan="2">Vertical Bars</th> <th colspan="2">Ties or Spiral</th> </tr> <tr> <th>Size</th> <th>Total</th> <th>Size</th> <th>Spacing or Pitch</th> </tr> </thead> <tbody> <tr> <td>#10</td> <td>16</td> <td>#4</td> <td>12 inch</td> </tr> </tbody> </table> <p>(1): Shaft length is 22' for cohesive soil only. For cohesionless soil, contact geotechnical branch for design.  (2): Do not construct high mast drilled shafts on ground slopes steeper than 1.5:1 without the approval of the Division of Traffic.</p> <p>If rock is encountered during drilling operations and confirmed by the engineer to be of sound quality, the shaft is only required to be further advanced into the rock by the length of rock socket shown in the table. The total length of the shaft need not be longer than that of soil alone. Both longitudinal rebar length and number of ties or spiral length shall be adjusted accordingly.</p> <p>If a shorter depth is desired for the drilled shaft, the contractor shall provide, for the state's review and approval, a detailed column design with individual site specific soil and rock analysis performed and approved by a Professional Engineer licensed in the Commonwealth of Kentucky.</p> <p>Spiral reinforcement may be substituted for ties. If spiral reinforcement is used, one and one-half closed coils shall be provided at the ends of each spiral unit. Subsurface conditions consisting of very soft clay or very loose saturated sand could result in soil parameters weaker than those assumed. Engineer shall consult with the geotechnical branch if such conditions are encountered.</p> <p>The bottom of the drilled hole shall be firm and thoroughly cleaned so no loose or compressible materials are present at the time of the concrete placement. If the drilled hole contains standing water, the concrete shall be placed using a tremie to displace water. Continuous concrete flow will be required to insure full displacement of any water.</p> <p>The reinforcement and anchor bolts shall be adequately supported in the proper positions so no movement occurs during concrete placement. Welding of anchor bolts to the reinforcing cage is unacceptable, templates shall be used. Exposed portions of the foundation shall be formed to create a smooth finished surface. All forming shall be removed upon completion of foundation construction.</p>	Drilled Shaft Depth Data								Level Ground		3:1 Ground Slope		2:1 Ground Slope		1.5:1 Ground Slope <sup>(2)</sup>		Soil	Rock	Soil	Rock	Soil	Rock	Soil	Rock	17 ft	7 ft	19 ft	7 ft	20 ft	7 ft	(1)	7 ft	Steel Requirements				Vertical Bars		Ties or Spiral		Size	Total	Size	Spacing or Pitch	#10	16	#4	12 inch
Drilled Shaft Depth Data																																																	
Level Ground		3:1 Ground Slope		2:1 Ground Slope		1.5:1 Ground Slope <sup>(2)</sup>																																											
Soil	Rock	Soil	Rock	Soil	Rock	Soil	Rock																																										
17 ft	7 ft	19 ft	7 ft	20 ft	7 ft	(1)	7 ft																																										
Steel Requirements																																																	
Vertical Bars		Ties or Spiral																																															
Size	Total	Size	Spacing or Pitch																																														
#10	16	#4	12 inch																																														
<b>Subsection:</b>	716.03.03 Trenching.																																																
<b>Part:</b>	A) Trenching of Conduit for Highmast Ducted Cables.																																																
<b>Revision:</b>	Add the following after the first sentence: If depths greater than 24 inches are necessary, obtain the Engineer's approval and maintain the required conduit depths coming into the junction boxes. No payment for additional junction boxes for greater depths will be allowed.																																																

**Supplemental Specifications to the  
Standard Specifications for Road and Bridge Construction, 2012 Edition  
Effective with the July 31, 2015 Letting**

<b>Subsection:</b>	716.03.03 Trenching.
<b>Part:</b>	B) Trenching of Conduit for Non-Highmast Cables.
<b>Revision:</b>	Add the following after the second sentence: If depths greater than 24 inches are necessary for either situation listed previously, obtain the Engineer's approval and maintain the required conduit depths coming into the junction boxes. No payment for additional junction boxes for greater depths will be allowed.
<b>Subsection:</b>	716.03.10 Junction Boxes.
<b>Revision:</b>	Replace subsection title with the following: Electrical Junction Box.
<b>Subsection:</b>	716.04.07 Pole with Secondary Control Equipment.
<b>Revision:</b>	Replace the paragraph with the following: The Department will measure the quantity as each individual unit furnished and installed. The Department will not measure mounting the cabinet to the pole, backfilling, restoration, any necessary hardware to anchor pole, or electrical inspection fees, and will consider them incidental to this item of work. The Department will also not measure furnishing and installing electrical service conductors, specified conduits, meter base, transformer, service panel, fused cutout, fuses, lighting arrestors, photoelectrical control, circuit breaker, contactor, manual switch, ground rods, and ground wires and will consider them incidental to this item of work.
<b>Subsection:</b>	716.04.08 Lighting Control Equipment.
<b>Revision:</b>	Replace the paragraph with the following: The Department will measure the quantity as each individual unit furnished and installed. The Department will not measure constructing the concrete base, excavation, backfilling, restoration, any necessary anchors, or electrical inspection fees, and will consider them incidental to this item of work. The Department will also not measure furnishing and installing electrical service conductors, specified conduits, meter base, transformer, service panel, fused cutout, fuses, lighting arrestors, photoelectrical control, circuit breakers, contactor, manual switch, ground rods, and ground wires and will consider them incidental to this item of work.
<b>Subsection:</b>	716.04.09 Luminaire.
<b>Revision:</b>	Replace the first sentence with the following: The Department will measure the quantity as each individual unit furnished and installed.
<b>Subsection:</b>	716.04.10 Fused Connector Kits.
<b>Revision:</b>	Replace the first sentence with the following: The Department will measure the quantity as each individual unit furnished and installed.
<b>Subsection:</b>	716.04.13 Junction Box.
<b>Revision:</b>	Replace the subsection title with the following: Electrical Junction Box Type Various.
<b>Subsection:</b>	716.04.13 Junction Box.
<b>Part:</b>	A) Junction Electrical.
<b>Revision:</b>	Rename A) Junction Electrical to the following: A) Electrical Junction Box.
<b>Subsection:</b>	716.04.14 Trenching and Backfilling.
<b>Revision:</b>	Replace the second sentence with the following: The Department will not measure excavation, backfilling, underground utility warning tape (if required), the restoration of disturbed areas to original condition, and will consider them incidental to this item of work.

**Supplemental Specifications to the  
 Standard Specifications for Road and Bridge Construction, 2012 Edition  
 Effective with the July 31, 2015 Letting**

<b>Subsection:</b>	716.04.18 Remove Lighting.															
<b>Revision:</b>	Replace the paragraph with the following: The Department will measure the quantity as a lump sum for the removal of lighting equipment. The Department will not measure the disposal of all equipment and materials off the project by the contractor. The Department also will not measure the transportation of the materials and will consider them incidental to this item of work.															
<b>Subsection:</b>	716.04.20 Bore and Jack Conduit.															
<b>Revision:</b>	Replace the paragraph with the following: The Department will measure the quantity in linear feet. This item shall include all work necessary for boring and installing conduit under an existing roadway. Construction methods shall be in accordance with Sections 706.03.02, paragraphs 1, 2, and 4.															
<b>Subsection:</b>	716.05 PAYMENT.															
<b>Revision:</b>	Replace items 04810-04811, 20391NS835 and, 20392NS835 under <u>Code</u> , <u>Pay Item</u> , and <u>Pay Unit</u> with the following:															
	<table border="0"> <thead> <tr> <th><u>Code</u></th> <th><u>Pay Item</u></th> <th><u>Pay Unit</u></th> </tr> </thead> <tbody> <tr> <td>04810</td> <td>Electrical Junction Box</td> <td>Each</td> </tr> <tr> <td>04811</td> <td>Electrical Junction Box Type B</td> <td>Each</td> </tr> <tr> <td>20391NS835</td> <td>Electrical Junction Box Type A</td> <td>Each</td> </tr> <tr> <td>20392NS835</td> <td>Electrical Junction Box Type C</td> <td>Each</td> </tr> </tbody> </table>	<u>Code</u>	<u>Pay Item</u>	<u>Pay Unit</u>	04810	Electrical Junction Box	Each	04811	Electrical Junction Box Type B	Each	20391NS835	Electrical Junction Box Type A	Each	20392NS835	Electrical Junction Box Type C	Each
<u>Code</u>	<u>Pay Item</u>	<u>Pay Unit</u>														
04810	Electrical Junction Box	Each														
04811	Electrical Junction Box Type B	Each														
20391NS835	Electrical Junction Box Type A	Each														
20392NS835	Electrical Junction Box Type C	Each														
<b>Subsection:</b>	723.02.02 Paint.															
<b>Revision:</b>	Replace sentence with the following: Conform to Section 821.															
<b>Subsection:</b>	723.03 CONSTRUCTION.															
<b>Revision:</b>	Replace bullet 5) with the following: 5) AASHTO Standard Specifications for Structural Supports for Highway Signs, Luminaires, and Traffic Signals, 2013-6th Edition with current interims,															
<b>Subsection:</b>	723.03.02 Poles and Bases Installation.															
<b>Revision:</b>	Replace the first sentence with the following: Regardless of the station and offset noted, locate all poles/bases behind the guardrail a minimum of four feet from the front face of the guardrail to the front face of the pole base.															
<b>Subsection:</b>	723.03.02 Poles and Bases Installation.															
<b>Part:</b>	A) Steel Strain and Mastarm Poles Installation															
<b>Revision:</b>	Replace the second paragraph with the following: For concrete base installation, see Section 716.03.02, B), 2), Paragraphs 2-7. Drilled shaft depth shall be based on the soil conditions encountered during drilling and slope condition at the site. Refer to the design chart below:															
<b>Subsection:</b>	723.03.02 Poles and Bases Installation.															
<b>Part:</b>	B) Pedestal or Pedestal Post Installation.															
<b>Revision:</b>	Replace the fourth sentence of the paragraph with the following: For breakaway supports, conform to Section 12 of the AASHTO Standard Specifications for Structural Supports for Highway Signs, Luminaires, and Traffic Signals, 2013-6th Edition with current interims.															

**Supplemental Specifications to the  
 Standard Specifications for Road and Bridge Construction, 2012 Edition  
 Effective with the July 31, 2015 Letting**

<b>Subsection:</b>	723.03.03 Trenching.
<b>Part:</b>	A) Under Roadway.
<b>Revision:</b>	Add the following after the second sentence: If depths greater than 24 inches are necessary, obtain the Engineer's approval and maintain ether required conduit depths coming into the junction boxes. No payment for additional junction boxes for greater depths will be allowed.
<b>Subsection:</b>	723.03.11 Wiring Installation.
<b>Revision:</b>	Add the following sentence between the fifth and sixth sentences: Provide an extra two feet of loop wire and lead-in past the installed conduit in poles, pedestals, and junction boxes.
<b>Subsection:</b>	723.03.12 Loop Installation.
<b>Revision:</b>	Replace the fourth sentence of the 2nd paragraph with the following: Provide an extra two feet of loop wire and lead-in past the installed conduit in poles, pedestals, and junction boxes.
<b>Subsection:</b>	723.04.02 Junction Box.
<b>Revision:</b>	Replace subsection title with the following: Electrical Junction Box Type Various.
<b>Subsection:</b>	723.04.03 Trenching and Backfilling.
<b>Revision:</b>	Replace the second sentence with the following: The Department will not measure excavation, backfilling, underground utility warning tape (if required), the restoration of disturbed areas to original condition, and will consider them incidental to this item of work.
<b>Subsection:</b>	723.04.10 Signal Pedestal.
<b>Revision:</b>	Replace the second sentence with the following: The Department will not measure excavation, concrete, reinforcing steel, specified conduits, fittings, ground rod, ground wire, backfilling, restoring disturbed areas, or other necessary hardware and will consider them incidental to this item of work.
<b>Subsection:</b>	723.04.15 Loop Saw Slot and Fill.
<b>Revision:</b>	Replace the second sentence with the following: The Department will not measure sawing, cleaning and filling induction loop saw slot, loop sealant, backer rod, and grout and will consider them incidental to this item of work.
<b>Subsection:</b>	723.04.16 Pedestrian Detector.
<b>Revision:</b>	Replace the paragraph with the following: The Department will measure the quantity as each individual unit furnished, installed and connected to pole/pedestal. The Department will not measure installing R10-3e (with arrow) sign, furnishing and installing mounting hardware for sign and will consider them incidental to this item of work.
<b>Subsection:</b>	723.04.18 Signal Controller- Type 170.
<b>Revision:</b>	Replace the second sentence with the following: The Department will not measure constructing the concrete base or mounting the cabinet to the pole, connecting the signal and detectors, excavation, backfilling, restoration, any necessary pole mounting hardware, electric service, or electrical inspection fees and will consider them incidental to this item of work. The Department will also not measure furnishing and connecting the induction of loop amplifiers, pedestrian isolators, load switches, model 400 modem card; furnishing and installing electrical service conductors, specified conduits, anchors, meter base, fused cutout, fuses, ground rods, ground wires and will consider them incidental to this item of work.

**Supplemental Specifications to the  
 Standard Specifications for Road and Bridge Construction, 2012 Edition  
 Effective with the July 31, 2015 Letting**

<b>Subsection:</b>	723.04.20 Install Signal Controller - Type 170.
<b>Revision:</b>	Replace the paragraph with the following: The Department will measure the quantity as each individual unit installed. The Department will not measure constructing the concrete base or mounting the cabinet to the pole, connecting the signal and detectors, and excavation, backfilling, restoration, any necessary pole mounting hardware, electric service, or electrical inspection fees and will consider them incidental to this item of work. The Department will also not measure connecting the induction loop amplifiers, pedestrian, isolators, load switches, model 400 modem card; furnishing and installing electrical service conductors, specified conduits, anchors, meter base, fused cutout, fuses, ground rods, ground wires and will consider them incidental to this item of work.
<b>Subsection:</b>	723.04.22 Remove Signal Equipment.
<b>Revision:</b>	Replace the paragraph with the following: The Department will measure the quantity as a lump sum removal of signal equipment. The Department will not measure the return of control equipment and signal heads to the Department of Highways as directed by the District Traffic Engineer. The Department also will not measure the transportation of materials of the disposal of all other equipment and materials off the project by the contractor and will consider them incidental to this item of work.
<b>Subsection:</b>	723.04.28 Install Pedestrian Detector Audible.
<b>Revision:</b>	Replace the second sentence with the following: The Department will not measure installing sign R10-3e (with arrow) and will consider it incidental to this item of work.
<b>Subsection:</b>	723.04.29 Audible Pedestrian Detector.
<b>Revision:</b>	Replace the second sentence with the following: The Department will not measure furnishing and installing the sign R10-3e (with arrow) and will consider it incidental to this item of work.
<b>Subsection:</b>	723.04.30 Bore and Jack Conduit.
<b>Revision:</b>	Replace the paragraph with the following: The Department will measure the quantity in linear feet. This item shall include all work necessary for boring and installing conduit under an existing roadway. Construction methods shall be in accordance with Sections 706.03.02, paragraphs 1, 2, and 4.
<b>Subsection:</b>	723.04.31 Install Pedestrian Detector.
<b>Revision:</b>	Replace the paragraph with the following: The Department will measure the quantity as each individual unit installed and connected to pole/pedestal. The Department will not measure installing sign R 10-3e (with arrow) and will consider it incidental to this item of work.
<b>Subsection:</b>	723.04.32 Install Mast Arm Pole.
<b>Revision:</b>	Replace the second sentence with the following: The Department will not measure arms, signal mounting brackets, anchor bolts, or any other necessary hardware and will consider them incidental to this item of work.
<b>Subsection:</b>	723.04.33 Pedestal Post.
<b>Revision:</b>	Replace the second sentence with the following: The Department will not measure excavation, concrete, reinforcing steel, anchor bolts, conduit, fittings, ground rod, ground wire, backfilling, restoration, or any other necessary hardware and will consider them incidental to this item of work.

**Supplemental Specifications to the  
Standard Specifications for Road and Bridge Construction, 2012 Edition  
Effective with the July 31, 2015 Letting**

<b>Subsection:</b>	723.04.36 Traffic Signal Pole Base.															
<b>Revision:</b>	Replace the second sentence with the following: The Department will not measure excavation, reinforcing steel, anchor bolts, specified conduits, ground rods, ground wires, backfilling, or restoration and will consider them incidental to this item of work.															
<b>Subsection:</b>	723.04.37 Install Signal Pedestal.															
<b>Revision:</b>	Replace the second sentence with the following: The Department will not measure excavation, concrete, reinforcing steel, anchor bolts, specified conduits, fittings, ground rod, ground wire, backfilling, restoration, or any other necessary hardware and will consider them incidental to this item of work.															
<b>Subsection:</b>	723.04.38 Install Pedestal Post.															
<b>Revision:</b>	Replace the second sentence with the following: The Department will not measure excavation, concrete, reinforcing steel, anchor bolts, specified conduits, fittings, ground rod, ground wire, backfilling, restoration, or any other necessary hardware and will consider them incidental to this item of work.															
<b>Subsection:</b>	723.05 PAYMENT.															
<b>Revision:</b>	Replace items 04810-04811, 20391NS835 and, 20392NS835 under <u>Code</u> , <u>Pay Item</u> , and <u>Pay Unit</u> with the following:															
	<table border="0"> <thead> <tr> <th><u>Code</u></th> <th><u>Pay Item</u></th> <th><u>Pay Unit</u></th> </tr> </thead> <tbody> <tr> <td>04810</td> <td>Electrical Junction Box</td> <td>Each</td> </tr> <tr> <td>04811</td> <td>Electrical Junction Box Type B</td> <td>Each</td> </tr> <tr> <td>20391NS835</td> <td>Electrical Junction Box Type A</td> <td>Each</td> </tr> <tr> <td>20392NS835</td> <td>Electrical Junction Box Type C</td> <td>Each</td> </tr> </tbody> </table>	<u>Code</u>	<u>Pay Item</u>	<u>Pay Unit</u>	04810	Electrical Junction Box	Each	04811	Electrical Junction Box Type B	Each	20391NS835	Electrical Junction Box Type A	Each	20392NS835	Electrical Junction Box Type C	Each
<u>Code</u>	<u>Pay Item</u>	<u>Pay Unit</u>														
04810	Electrical Junction Box	Each														
04811	Electrical Junction Box Type B	Each														
20391NS835	Electrical Junction Box Type A	Each														
20392NS835	Electrical Junction Box Type C	Each														
<b>Subsection:</b>	804.01.02 Crushed Sand.															
<b>Revision:</b>	Delete last sentence of the section.															
<b>Subsection:</b>	804.01.06 Slag.															
<b>Revision:</b>	Add subsection and following sentence. Provide blast furnace slag sand where permitted. The Department will allow steel slag sand only in asphalt surface applications.															
<b>Subsection:</b>	804.04 Asphalt Mixtures.															
<b>Revision:</b>	Replace the subsection with the following: Provide natural, crushed, conglomerate, or blast furnace slag sand, with the addition of filler as necessary, to meet gradation requirements. The Department will allow any combination of natural, crushed, conglomerate or blast furnace slag sand when the combination is achieved using cold feeds at the plant. The Engineer may allow other fine aggregates.															
<b>Subsection:</b>	806.03.01 General Requirements.															
<b>Revision:</b>	Replace the second sentence of the paragraph with the following: Additionally, the material must have a minimum solubility of 99.0 percent when tested according to AASHTO T 44 and PG 76-22 must exhibit a minimum recovery of 60 percent, with a J <sub>NR</sub> (nonrecoverable creep compliance) between 0.1 and 0.5, when tested according to AASHTO TP 70.															

**Supplemental Specifications to the  
Standard Specifications for Road and Bridge Construction, 2012 Edition  
Effective with the July 31, 2015 Letting**

<b>Subsection:</b>	806.03.01 General Requirements.														
<b>Table:</b>	PG Binder Requirements and Price Adjustment Schedule														
<b>Revision:</b>	Replace the Elastic Recovery, % <sup>(3)</sup> (AASHTO T301) and all corresponding values in the table with the following:														
	<table border="1"> <thead> <tr> <th><u>Test</u></th> <th><u>Specification</u></th> <th><u>100% Pay</u></th> <th><u>90% Pay</u></th> <th><u>80% Pay</u></th> <th><u>70% Pay</u></th> <th><u>50% Pay<sup>(1)</sup></u></th> </tr> </thead> <tbody> <tr> <td>MSCR recovery, % <sup>(3)</sup> (AASHTO TP 70)</td> <td>60 Min.</td> <td>≥58</td> <td>56</td> <td>55</td> <td>54</td> <td>&lt;53</td> </tr> </tbody> </table>	<u>Test</u>	<u>Specification</u>	<u>100% Pay</u>	<u>90% Pay</u>	<u>80% Pay</u>	<u>70% Pay</u>	<u>50% Pay<sup>(1)</sup></u>	MSCR recovery, % <sup>(3)</sup> (AASHTO TP 70)	60 Min.	≥58	56	55	54	<53
<u>Test</u>	<u>Specification</u>	<u>100% Pay</u>	<u>90% Pay</u>	<u>80% Pay</u>	<u>70% Pay</u>	<u>50% Pay<sup>(1)</sup></u>									
MSCR recovery, % <sup>(3)</sup> (AASHTO TP 70)	60 Min.	≥58	56	55	54	<53									
<b>Subsection:</b>	806.03.01 General Requirements.														
<b>Table:</b>	PG Binder Requirements and Price Adjustment Schedule														
<b>Superscript:</b>	(3)														
<b>Revision:</b>	Replace <sup>(3)</sup> with the following: Perform testing at 64°C.														
<b>Subsection:</b>	813.04 Gray Iron Castings.														
<b>Revision:</b>	Replace the reference to "AASHTO M105" with "ASTM A48".														
<b>Subsection:</b>	813.09.02 High Strength Steel Bolts, Nuts, and Washers.														
<b>Number:</b>	A) Bolts.														
<b>Revision:</b>	Delete first paragraph and "Hardness Number" Table. Replace with the following: A) Bolts. Conform to ASTM A325 (AASHTO M164) or ASTM A490 (AASHTO 253) as applicable.														
<b>Subsection:</b>	814.04.02 Timber Guardrail Posts.														
<b>Revision:</b>	Third paragraph, replace the reference to "AWPA C14" with "AWPA U1, Section B, Paragraph 4.1".														
<b>Subsection:</b>	814.04.02 Timber Guardrail Posts.														
<b>Revision:</b>	Replace the first sentence of the fourth paragraph with the following: Use any of the species of wood for round or square posts covered under AWPA U1.														
<b>Subsection:</b>	814.04.02 Timber Guardrail Posts.														
<b>Revision:</b>	Fourth paragraph, replace the reference to "AWPA C2" with "AWPA U1, Section B, Paragraph 4.1".														
<b>Subsection:</b>	814.04.02 Timber Guardrail Posts.														
<b>Revision:</b>	Delete the second sentence of the fourth paragraph.														
<b>Subsection:</b>	814.05.02 Composite Plastic.														
<b>Revision:</b>	1) Add the following to the beginning of the first paragraph: Select composite offset blocks conforming to this section and assure blocks are from a manufacturer included on the Department's List of Approved Materials. 2) Delete the last paragraph of the subsection.														
<b>Subsection:</b>	816.07.02 Wood Posts and Braces.														
<b>Revision:</b>	First paragraph, replace the reference to "AWPA C5" with "AWPA U1, Section B, Paragraph 4.1".														
<b>Subsection:</b>	816.07.02 Wood Posts and Braces.														
<b>Revision:</b>	Delete the second sentence of the first paragraph.														
<b>Subsection:</b>	818.07 Preservative Treatment.														
<b>Revision:</b>	First paragraph, replace all references to "AWPA C14" with "AWPA U1, Section A".														

**Supplemental Specifications to the  
 Standard Specifications for Road and Bridge Construction, 2012 Edition  
 Effective with the July 31, 2015 Letting**

<p><b>Subsection:</b> <b>Revision:</b></p>	<p>834.14 Lighting Poles.        Replace the first sentence with the following: Lighting pole design shall be in accordance with loading and allowable stress requirements of the AASHTO Standard Specifications for Structural Supports for Highway Signs, Luminaires, and Traffic Signals, 2013-6th Edition with current interims, with the exception of the following: The Cabinet will waive the requirement stated in the first sentence of Section 5.14.6.2 – Reinforced Holes and Cutouts for high mast poles (only). The minimum diameter at the base of the pole shall be 22 inches for high mast poles (only).</p>
<p><b>Subsection</b> <b>Revision:</b></p>	<p>834.14.03 High Mast Poles.        Remove the second and fourth sentence from the first paragraph.</p>
<p><b>Subsection</b> <b>Revision:</b></p>	<p>834.14.03 High Mast Poles.        Replace the third paragraph with the following: Provide calculations and drawings that are stamped by a Professional Engineer licensed in the Commonwealth of Kentucky.</p>
<p><b>Subsection:</b> <b>Revision:</b></p>	<p>834.14.03 High Mast Poles.        Replace paragraph six with the following: Provide a pole section that conforms to ASTM A 595 grade A with a minimum yield strength of 55 KSI or ASTM A 572 with a minimum yield strength of 55 KSI. Use tubes that are round or 16 sided with a four inch corner radius, have a constant linear taper of .144 in/ft and contain only one longitudinal seam weld. Circumferential welded tube butt splices and laminated tubes are not permitted. Provide pole sections that are telescopically slip fit assembled in the field to facilitate inspection of interior surface welds and the protective coating. The minimum length of the telescopic slip splices shall be 1.5 times the inside diameter of the exposed end of the female section. Use longitudinal seam welds as commended in Section 5.15 of the AASHTO 2013 Specifications. The thickness of the transverse base shall not be less than 2 inches. Plates shall be integrally welded to the tubes with a telescopic welded joint or a full penetration groove weld with backup bar. The handhole cover shall be removable from the handhole frame. One the frame side opposite the hinge, provide a mechanism on the handhole cover/frame to place the Department’s standard padlock as specified in Section 834.25. The handhole frame shall have two stainless studs installed opposite the hinge to secure the handhole cover to the frame which includes providing stainless steel wing nuts and washers. The handhole cover shall be manufactured from 0.25 inch thick galvanized steel (ASTM A 153) and have a neoprene rubber gasket that is permanently secured to the handhole frame to insure weather-tight protection. The hinge shall be manufactured from 7-gauge stainless steel to provide adjustability to insure weather-tight fit for the cover. The minimum clear distance between the transverse plate and the bottom opening of the handhole shall not be less than the diameter of the bottom tube of the pole but needs to be at least 15 inches. Provide products that are hot-dip galvanized to the requirements of either ASTM A123 (fabricated products) or ASTM A 153 (hardware items).</p>
<p><b>Subsection:</b> <b>Revision:</b></p>	<p>834.16 ANCHOR BOLTS.        Insert the following sentence at the beginning of the paragraph: The anchor bolt design shall follow the NCHRP Report 494 Section 2.4 and NCHRP 469 Appendix A Specifications.</p>

**Supplemental Specifications to the  
 Standard Specifications for Road and Bridge Construction, 2012 Edition  
 Effective with the July 31, 2015 Letting**

<b>Subsection:</b>	834.17.01 Conventional.
<b>Revision:</b>	Add the following sentence after the second sentence: Provide a waterproof sticker mounted on the bottom of the housing that is legible from the ground and indicates the wattage of the fixture by providing the first two numbers of the wattage.
<b>Subsection:</b>	834.21.01 Waterproof Enclosures.
<b>Revision:</b>	Replace the last five sentences in the second paragraph with the following sentences: Provide a cabinet door with a louvered air vent, filter-retaining brackets and an easy to clean metal filter. Provide a cabinet door that is keyed with a factory installed standard no. 2 corbin traffic control key. Provide a light fixture with switch and bulb. Use a 120-volt fixture and utilize a L.E.D. bulb (equivalent to 60 watts minimum). Fixture shall be situated at or near the top of the cabinet and illuminate the contents of the cabinet. Provide a 120 VAC GFI duplex receptacle in the enclosure with a separate 20 amp breaker.
<b>Subsection:</b>	835.07 Traffic Poles.
<b>Revision:</b>	Replace the first sentence of the first paragraph with the following: Pole diameter and wall thickness shall be calculated in accordance with the AASHTO Standard Specifications for Structural Supports for Highway Signs, Luminaires, and Traffic Signals, 2013-6th Edition with current interims.
<b>Subsection:</b>	835.07 Traffic Poles.
<b>Revision:</b>	*Replace the first sentence of the fourth paragraph with the following: Ensure transverse plates have a thickness $\geq 2$ inches. *Add the following sentence to the end of the fourth paragraph: The bottom pole diameter shall not be less than 16.25 inches.
<b>Subsection:</b>	835.07 Traffic Poles.
<b>Revision:</b>	Replace the third sentence of the fifth paragraph with the following: For anchor bolt design, pole forces shall be positioned in such a manner to maximize the force on any individual anchor bolt regardless of the actual anchor bolt orientation with the pole.
<b>Subsection:</b>	835.07 Traffic Poles.
<b>Revision:</b>	Replace the first and second sentence of the sixth paragraph with the following: The pole handhole shall be 25 inches by 6.5 inches. The handhole cover shall be removable from the handhole frame. On the frame side opposite the hinge, provide a mechanism on the handhole cover/frame to place the Department's standard padlock as specified in Section 834.25. The handhole frame shall have two stainless studs installed opposite the hinge to secure the handhole cover to the frame which includes providing stainless steel wing nuts and washers. The handhole cover shall be manufactured from 0.25 inch thick galvanized steel (ASTM 153) and have a neoprene rubber gasket that is permanently secured to the handhole frame to insure weather-tight protection. The hinge shall be manufactured from 7 gauge stainless steel to provide adjustability to insure a weather-tight fit for the cover. The minimum clear distance between the transverse plate and the bottom opening of the handhole shall not be less than the diameter of the bottom tube but needs to be at least 12 inches.

**Supplemental Specifications to the  
Standard Specifications for Road and Bridge Construction, 2012 Edition  
Effective with the July 31, 2015 Letting**

<b>Subsection:</b>	835.07 Traffic Poles.	
<b>Revision:</b>	<p>*Replace the first sentence of the last paragraph with the following: Provide calculations and drawings that are stamped by a Professional Engineer licensed in the Commonwealth of Kentucky.</p> <p>*Replace the third sentence of the last paragraph with the following: All tables referenced in 835.07 are found in the AASHTO Standard Specifications for Structural Supports for Highway Signs, Luminaires, and Traffic Signals, 2013-6th Edition with current interims.</p>	
<b>Subsection:</b>	835.07.01 Steel Strain Poles.	
<b>Revision:</b>	Replace the second sentence of the second paragraph with the following: The detailed analysis shall be certified by a Professional Engineer licensed in the Commonwealth of Kentucky.	
<b>Subsection:</b>	835.07.01 Steel Strain Poles.	
<b>Revision:</b>	Replace number 7. after the second paragraph with the following: 7. Fatigue calculations should be shown for all fatigue related connections. Provide the corresponding detail, stress category and example from table 11.9.3.1-1.	
<b>Subsection:</b>	835.07.02 Mast Arm Poles.	
<b>Revision:</b>	Replace the second sentence of the fourth paragraph with the following: The detailed analysis shall be certified by a Professional Engineer licensed in the Commonwealth of Kentucky.	
<b>Subsection:</b>	835.07.02 Mast Arm Poles.	
<b>Revision:</b>	Replace number 7) after the fourth paragraph with the following: 7) Fatigue calculations should be shown for all fatigue related connections. Provide the corresponding detail, stress category and example from table 11.9.3.1-1.	
<b>Subsection:</b>	835.07.03 Anchor Bolts.	
<b>Revision:</b>	Add the following to the end of the paragraph: There shall be two steel templates (one can be used for the headed part of the anchor bolt when designed in this manner) provided per pole. Templates shall be contained within a 26.5 inch diameter. All templates shall be fully galvanized (ASTM A 153).	
<b>Subsection:</b>	835.16.05 Optical Units.	
<b>Revision:</b>	Replace the 3rd paragraph with the following: The list of certified products can be found on the following website: <a href="http://www.intertek.com">http://www.intertek.com</a> .	
<b>Subsection:</b>	835.19.01 Pedestrian Detector Body.	
<b>Revision:</b>	Replace the first sentence with the following: Provide a four holed pole mounted aluminum rectangular housing that is compatible with the pedestrian detector.	
<b>Subsection:</b>	843.01.01 Geotextile Fabric.	
<b>Table:</b>	TYPE I FABRIC GEOTEXTILES FOR SLOPE PROTECTION AND CHANNEL LINING	
<b>Revision:</b>	Add the following to the chart:	
	<u>Property</u>	<u>Minimum Value<sup>(1)</sup></u>
	CBR Puncture (lbs)	494
	Permittivity (1/s)	0.7
		<u>Test Method</u>
		ASTM D6241
		ASTM D4491

**Supplemental Specifications to the  
 Standard Specifications for Road and Bridge Construction, 2012 Edition  
 Effective with the July 31, 2015 Letting**

<b>Subsection:</b>	843.01.01 Geotextile Fabric.		
<b>Table:</b>	TYPE II FABRIC GEOTEXTILES FOR UNDERDRAINS		
<b>Revision:</b>	Add the following to the chart:		
	<u>Property</u>	<u>Minimum Value<sup>(1)</sup></u>	<u>Test Method</u>
	CBR Puncture (lbs)	210	ASTM D6241
	Permittivity (1/s)	0.5	ASTM D4491
<b>Subsection:</b>	843.01.01 Geotextile Fabric.		
<b>Table:</b>	TYPE III FABRIC GEOTEXTILES FOR SUBGRADE OR EMBANKMENT STABILIZATION		
<b>Revision:</b>	Add the following to the chart:		
	<u>Property</u>	<u>Minimum Value<sup>(1)</sup></u>	<u>Test Method</u>
	CBR Puncture (lbs)	370	ASTM D6241
	Permittivity (1/s)	0.05	ASTM D4491
<b>Subsection:</b>	843.01.01 Geotextile Fabric.		
<b>Table:</b>	TYPE IV FABRIC GEOTEXTILES FOR EMBANKMENT DRAINAGE BLANKETS AND PAVEMENT EDGE DRAINS		
<b>Revision:</b>	Add the following to the chart:		
	<u>Property</u>	<u>Minimum Value<sup>(1)</sup></u>	<u>Test Method</u>
	CBR Puncture (lbs)	309	ASTM D6241
	Permittivity (1/s)	0.5	ASTM D4491
<b>Subsection:</b>	843.01.01 Geotextile Fabric.		
<b>Table:</b>	TYPE V HIGH STRENGTH GEOTEXTILE FABRIC		
<b>Revision:</b>	Make the following changes to the chart:		
	<u>Property</u>	<u>Minimum Value<sup>(1)</sup></u>	<u>Test Method</u>
	CBR Puncture (lbs)	618	ASTM D6241
	Apparent Opening Size	U.S. #40 <sup>(3)</sup>	ASTM D4751
	<sup>(3)</sup> Maximum average roll value.		

## **SPECIAL NOTE FOR PORTABLE CHANGEABLE MESSAGE SIGNS**

This Special Note will apply when indicated on the plans or in the proposal.

**1.0 DESCRIPTION.** Furnish, install, operate, and maintain variable message signs at the locations shown on the plans or designated by the Engineer. Remove and retain possession of variable message signs when they are no longer needed on the project.

### **2.0 MATERIALS.**

**2.1 General.** Use LED Variable Message Signs Class I, II, or III, as appropriate, from the Department's List of Approved Materials.

Unclassified signs may be submitted for approval by the Engineer. The Engineer may require a daytime and nighttime demonstration. The Engineer will make a final decision within 30 days after all required information is received.

**2.2 Sign and Controls.** All signs must:

- 1) Provide 3-line messages with each line being 8 characters long and at least 18 inches tall. Each character comprises 35 pixels.
- 2) Provide at least 40 preprogrammed messages available for use at any time. Provide for quick and easy change of the displayed message; editing of the message; and additions of new messages.
- 3) Provide a controller consisting of:
  - a) Keyboard or keypad.
  - b) Readout that mimics the actual sign display. (When LCD or LCD type readout is used, include backlighting and heating or otherwise arrange for viewing in cold temperatures.)
  - c) Non-volatile memory or suitable memory with battery backup for storing pre-programmed messages.
  - d) Logic circuitry to control the sequence of messages and flash rate.
- 4) Provide a serial interface that is capable of supporting complete remote control ability through land line and cellular telephone operation. Include communication software capable of immediately updating the message, providing complete sign status, and allowing message library queries and updates.
- 5) Allow a single person easily to raise the sign to a satisfactory height above the pavement during use, and lower the sign during travel.
- 6) Be Highway Orange on all exterior surfaces of the trailer, supports, and controller cabinet.
- 7) Provide operation in ambient temperatures from -30 to + 120 degrees Fahrenheit during snow, rain and other inclement weather.
- 8) Provide the driver board as part of a module. All modules are interchangeable, and have plug and socket arrangements for disconnection and reconnection. Printed circuit boards associated with driver boards have a conformable coating to protect against moisture.
- 9) Provide a sign case sealed against rain, snow, dust, insects, etc. The lens is UV stabilized clear plastic (polycarbonate, acrylic, or other approved material) angled to prevent glare.
- 10) Provide a flat black UV protected coating on the sign hardware, character PCB, and appropriate lens areas.
- 11) Provide a photocell control to provide automatic dimming.

- 12) Allow an on-off flashing sequence at an adjustable rate.
- 13) Provide a sight to aim the message.
- 14) Provide a LED display color of approximately 590 nm amber.
- 15) Provide a controller that is password protected.
- 16) Provide a security device that prevents unauthorized individuals from accessing the controller.
- 17) Provide the following 3-line messages preprogrammed and available for use when the sign unit begins operation:

/KEEP/RIGHT/=>=>=>/	/MIN/SPEED/**MPH/
/KEEP/LEFT/<=<=<=</	/ICY/BRIDGE/AHEAD/ /ONE
/LOOSE/GRAVEL/AHEAD/	LANE/BRIDGE/AHEAD/
/RD WORK/NEXT/**MILES/	/ROUGH/ROAD/AHEAD/
/TWO WAY/TRAFFIC/AHEAD/	/MERGING/TRAFFIC/AHEAD/
/PAINT/CREW/AHEAD/	/NEXT/***/MILES/
/REDUCE/SPEED/**MPH/	/HEAVY/TRAFFIC/AHEAD/
/BRIDGE/WORK/***0 FT/	/SPEED/LIMIT/**MPH/
/MAX/SPEED/**MPH/	/BUMP/AHEAD/
/SURVEY/PARTY/AHEAD/	/TWO/WAY/TRAFFIC/

\*Insert numerals as directed by the Engineer.  
Add other messages during the project when required by the Engineer.

**2.3 Power.**

- 1) Design solar panels to yield 10 percent or greater additional charge than sign consumption. Provide direct wiring for operation of the sign or arrow board from an external power source to provide energy backup for 21 days without sunlight and an on-board system charger with the ability to recharge completely discharged batteries in 24 hours.

**3.0 CONSTRUCTION.** Furnish and operate the variable message signs as designated on the plans or by the Engineer. Ensure the bottom of the message panel is a minimum of 7 feet above the roadway in urban areas and 5 feet above in rural areas when operating. Use Class I, II, or III signs on roads with a speed limit less than 55 mph. Use Class I or II signs on roads with speed limits 55 mph or greater.

Maintain the sign in proper working order, including repair of any damage done by others, until completion of the project. When the sign becomes inoperative, immediately repair or replace the sign. Repetitive problems with the same unit will be cause for rejection and replacement.

Use only project related messages and messages directed by the Engineer, unnecessary messages lessen the impact of the sign. Ensure the message is displayed in either one or 2 phases with each phase having no more than 3 lines of text. When no message is needed, but it is necessary to know if the sign is operable, flash only a pixel.

When the sign is not needed, move it outside the clear zone or where the Engineer directs. Variable Message Signs are the property of the Contractor and shall be removed from the project when no longer needed. The Department will not assume ownership of these signs.

**4.0 MEASUREMENT.** The final quantity of Variable Message Sign will be

11

the actual number of individual signs acceptably furnished and operated during the project. The Department will not measure signs replaced due to damage or rejection.

**5.0 PAYMENT.** The Department will pay for the Variable Message Signs at the unit price each. The Department will not pay for signs replaced due to damage or rejection. Payment is full compensation for furnishing all materials, labor, equipment, and service necessary to, operate, move, repair, and maintain or replace the variable message signs. The Department will make payment for the completed and accepted quantities under the following:

<u>Code</u>	<u>Pay Item</u>	<u>Pay Unit</u>
02671	Portable Changeable Message Sign	Each

Effective June 15, 2012

### 2012 STANDARD DRAWINGS THAT APPLY

TYPICAL GUARDRAIL INSTALLATIONS.....	RBI-001-10
TYPICAL GUARDRAIL INSTALLATIONS.....	RBI-002-06
GUARDRAIL TERMINAL SECTIONS .....	RBR-010-05
PAVED DITCH TYPE 1.....	RDD-001-05
CULVERT, ENTRANCE & STORM SEWER PIPE TYPES & COVER HEIGHTS .....	RDI-001-09
CULVERT, ENTRANCE & STORM SEWER PIPE TYPES & COVER HEIGHTS .....	RDI-002-04
CULVERT & STORM SEWER PIPE TYPES & COVER HEIGHTS.....	RDI-003-04
CULVERT & STORM SEWER PIPE TYPES & COVER HEIGHTS.....	RDI-004-03
CULVERT & STORM SEWER PIPE TYPES & COVER HEIGHTS.....	RDI-005-03
CULVERT & STORM SEWER PIPE TYPES & COVER HEIGHTS.....	RDI-006-03
CULVERT & STORM SEWER PIPE TYPES & COVER HEIGHTS.....	RDI-007-03
CULVERT & STORM SEWER PIPE TYPES & COVER HEIGHTS.....	RDI-008-03
CULVERT, ENTRANCE & STORM SEWER PIPE TYPES & COVER HEIGHTS .....	RDI-011-02
CULVERT & STORM SEWER PIPE TYPES & COVER HEIGHTS.....	RDI-012-02
PIPE BEDDING FOR CULVERTS, ENTRANCE AND STORM SEWER PIPE.....	RDI-020-08
PIPE BEDDING FOR CULVERTS, ENTRANCE AND STORM SEWER REINFORCED CONC. PIPE.....	RDI-021
PIPE BEDDING, TRENCH CONDITION.....	RDI-025-04
PIPE BEDDING, TRENCH CONDITION REINFORCED CONC. PIPE.....	RDI-026
PERFORATED PIPE TYPES AND COVER HEIGHTS .....	RDP-001-05
SILT TRAP - TYPE B .....	RDX-225
CURVE WIDENING AND SUPERELEVATION TRANSITIONS.....	RGS-001-06
SUPERELEVATION FOR MULTILANE PAVEMENTS .....	RGS-002-05
MISCELLANEOUS STANDARDS PART 1 .....	RGX-001-05
CURB AND GUTTER, CURBS AND VALLEY GUTTER.....	RPM-100-09
APPROACHES, ENTRANCES, AND MAIL BOX TURNOUT.....	RPM-110-06
PAVEMENT MARKER ARRANGEMENTS MULTI-LANE ROADWAYS .....	TPM-100-02
PAVEMENT MARKER ARRANGEMENTS MULTI-LANE ROADWAYS .....	TPM-105-02
PAVEMENT MARKER ARRANGEMENTS MULTI-LANE ROADWAYS .....	TPM-110-02
PAVEMENT MARKER ARRANGEMENTS TWO-WAY LEFT TURN LANE .....	TPM-140-02
LANE CLOSURE MULTI-LANE HIGHWAY CASE I.....	TTC-115-02
LANE CLOSURE MULTI-LANE HIGHWAY CASE II.....	TTC-120-02
SHOULDER CLOSURE.....	TTC-135-01
POST SPLICING DETAIL.....	TTD-110-01
PAVEMENT CONDITION WARNING SIGNS.....	TTD-125-01
MOBILE OPERATION FOR PAINT STRIPING CASE III.....	TTS-110-01
MOBILE OPERATION FOR PAINT STRIPING CASE IV.....	TTS-115-01

**NOTES**

1. THE DELINEATOR'S SHAPE AND DIMENSIONS ARE SHOWN FOR ILLUSTRATION PURPOSES ONLY. TYPES OF DELINEATORS PERMITTED SHALL BE FROM THE LIST OF APPROVED MATERIALS.
2. DELINEATOR SHALL BE MEASURED AND PAID FOR AT THE CONTRACT UNIT PRICE EACH AND SHALL INCLUDE ALL MATERIALS AND LABOR NECESSARY FOR ONE COMPLETE INSTALLATION.
3. CODE PAY ITEM  
 1982 DELINEATOR FOR GUARDRAIL - MONO DIRECTIONAL WHITE EACH  
 1983 DELINEATOR FOR GUARDRAIL - MONO DIRECTIONAL YELLOW EACH  
 1987 DELINEATOR FOR GUARDRAIL - BI-DIRECTIONAL WHITE EACH
4. GUARDRAIL DELINEATORS SHALL BE REQUIRED ON ALL GUARDRAIL.
5. DELINEATORS SHALL BE MANUFACTURED FROM 12 GA. GALVANIZED STEEL.
6. DIMENSIONS SHOWN ARE APPROXIMATE AND ARE SUBJECT TO MANUFACTURER'S TOLERANCES.
7. WHEN CONCRETE BARRIERS EXTEND ACROSS BRIDGE STRUCTURES IN LIEU OF STEEL BEAM GUARDRAIL, DELINEATORS SHALL BE INSTALLED AT SAME VERTICAL ALIGNMENT AS ON THE GUARDRAIL, AND DELINEATORS SHALL COMPLY WITH CURRENT SEP1A DRAWING 004.
8. DELINEATORS SHALL BE INSTALLED IN ACCORDANCE WITH MANUFACTURER'S RECOMMENDATIONS.

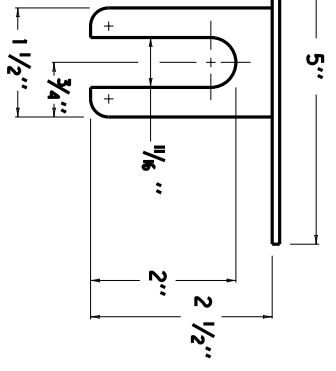

**PLAN VIEW**

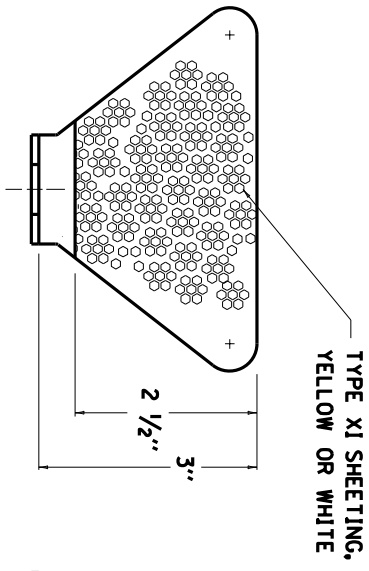

**FRONT VIEW**

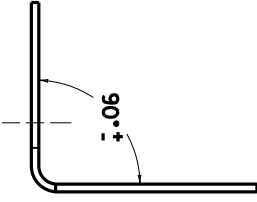

**SIDE VIEW**

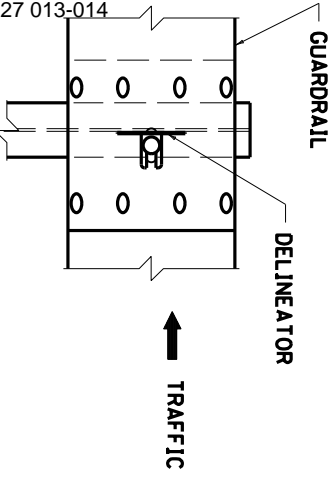

**FRONT VIEW**

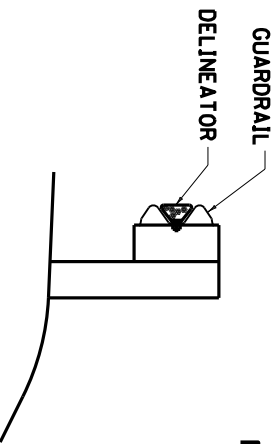

**SIDE VIEW**

NOTE: DIMENSIONS SHOWN ARE FOR ONE VERSION OF A WEB-MOUNTED GUARDRAIL DELINEATOR. DELINEATORS WITH ALTERNATE DIMENSIONS MAY BE CONSIDERED FOR INCLUSION ON THE APPROVED PRODUCTS LIST.

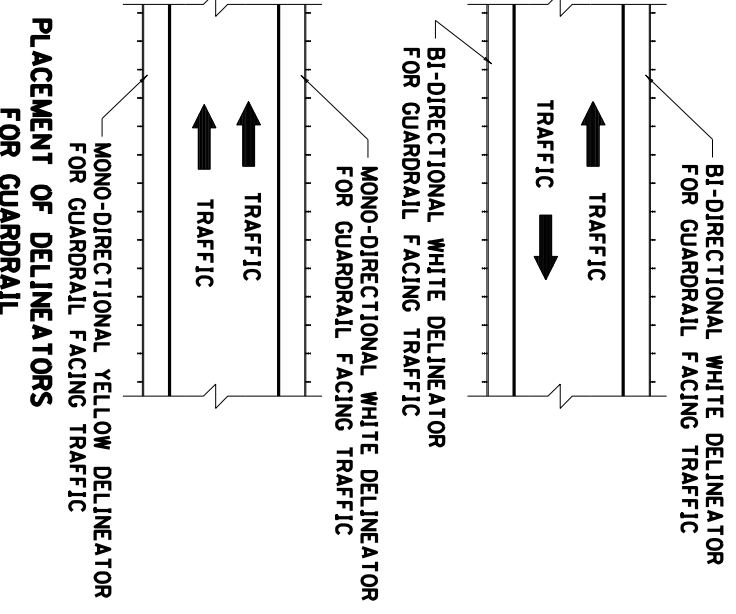

**PLACEMENT OF DELINEATORS FOR GUARDRAIL**

APPROXIMATE DELINEATOR SPACING	
TANGENT	100'
CURVE	50'

SPACING SHOULD BE ADJUSTED IN CURVES SO THAT SEVERAL DELINEATORS ARE ALWAYS SIMULTANEOUSLY VISIBLE TO THE ROAD USER.

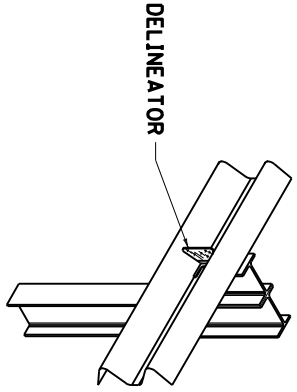

**ISOMETRIC VIEW**

KENTUCKY  
DEPARTMENT OF HIGHWAYS

**DELINEATORS FOR GUARDRAIL**

SUBMITTED: *[Signature]* 6-15-2012  
DATE

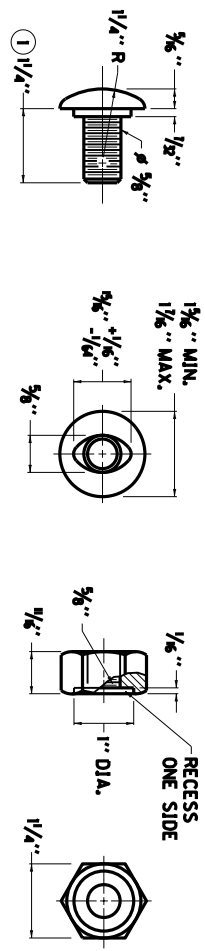

**3/8" BUTTON HEAD BOLT AND RECESSED NUT**

- NOTES**
- ① RAIL BOLT SIMILAR EXCEPT LENGTH.
  - ② THE THRIE BEAM TO "W" BEAM CONNECTOR SHALL COMPLY WITH AASHTO M-180 CLASS A, TYPE 2 EXCEPT WHERE IN CONFLICT WITH THIS DETAIL.

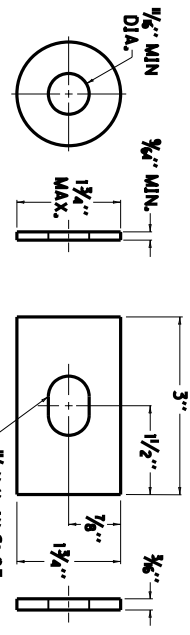

**ROUND WASHER AND RECTANGULAR PLATE WASHER**

SEE CUR. STD.  
DWG. RBR-001  
FOR DIMENSIONS

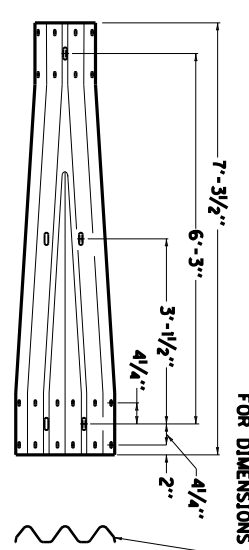

SEE CUR. STD.  
DWG. RBR-100  
FOR DIMENSIONS

**THRIE BEAM TO "W" BEAM CONNECTOR ②**

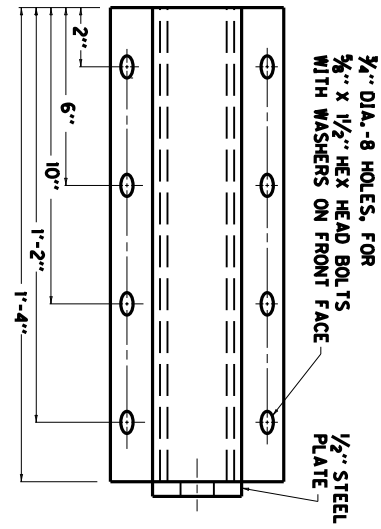

**3/4" DIA.-8 HOLES, FOR  
3/8" X 1/2" HEX HEAD BOLTS  
WITH WASHERS ON FRONT FACE**

**RAIL ANCHOR ASSEMBLY**

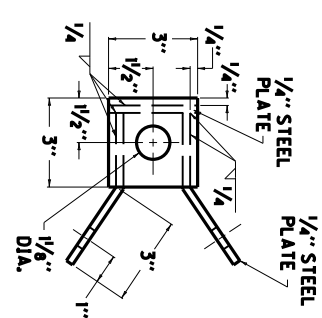

**ALTERNATE NO. 1**

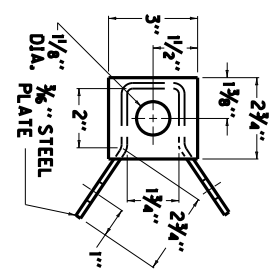

**ALTERNATE NO. 2**

KENTUCKY DEPARTMENT OF HIGHWAYS	
<b>GUARDRAIL COMPONENTS</b>	
SUBMITTED TECH DIVISION OF REGION	DATE 6-15-2012
008	

QUANTITY OF	ITEM NO.	SHEET NO.
-------------	----------	-----------

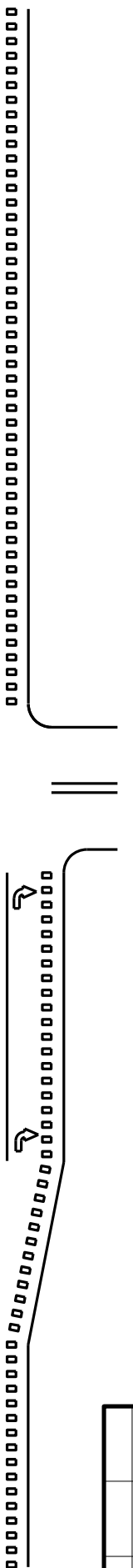

INTERSECTIONS WITH OR WITHOUT RIGHT-TURN LANES ①

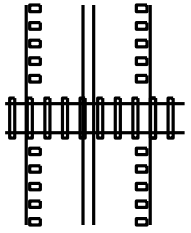

HIGHWAY-RAIL GRADE CROSSINGS ②

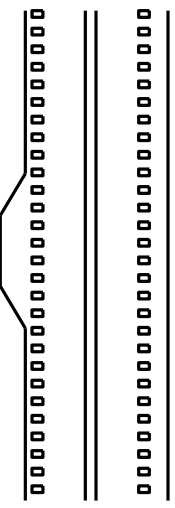

DRIVEWAYS/MINOR COMMERCIAL ENTRANCES ③

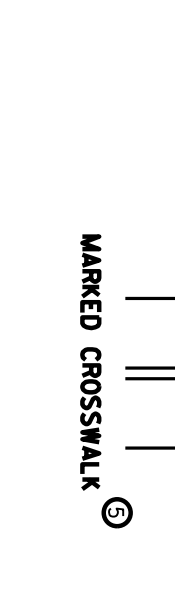

MAILBOX TURNOUTS ④

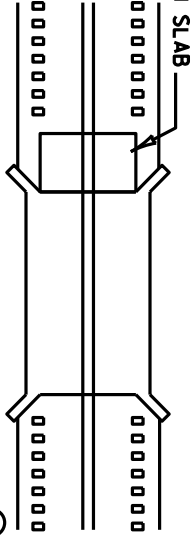

BRIDGE DECK/APPROACH SLAB ⑤

**GENERAL NOTES**

- ① SHOULDER RUMBLE STRIPS SHALL BE OMITTED THROUGH MAJOR INTERSECTIONS WITH OR WITHOUT RIGHT-TURN LANES. RUMBLE STRIPS SHALL BE OMITTED IN THE AREA WHERE EDGE LINE PAVEMENT MARKINGS HAVE BEEN OMITTED (NORMALLY WHERE SIDE STREET RADIUS INTERSECTS MAINLINE). RUMBLE STRIPS SHALL BE OMITTED WHERE THE POSTED SPEED LIMIT IS 45 MPH OR LESS.
- ② SHOULDER RUMBLE STRIPS SHALL NOT BE INSTALLED ACROSS HIGHWAY-RAIL GRADE CROSSINGS.
- ③ SHOULDER RUMBLE STRIPS SHALL BE INSTALLED THROUGH DRIVEWAYS/MINOR COMMERCIAL ENTRANCES.
- ④ SHOULDER RUMBLE STRIPS SHALL BE INSTALLED THROUGH MAILBOX TURNOUTS.
- ⑤ SHOULDER RUMBLE STRIPS SHALL NOT BE INSTALLED THROUGH MARKED CROSSWALKS.
- ⑥ SHOULDER RUMBLE STRIPS SHALL NOT BE INSTALLED ON BRIDGE DECKS OR APPROACH SLABS.

COUNTY OF	ITEM NO.	SHEET NO.

KENTUCKY  
DEPARTMENT OF HIGHWAYS

**SHOULDER RUMBLE STRIPS**

SUBMITTED *R. [Signature]* 10-23-12  
DATE  
011

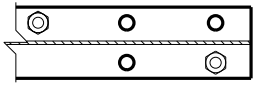
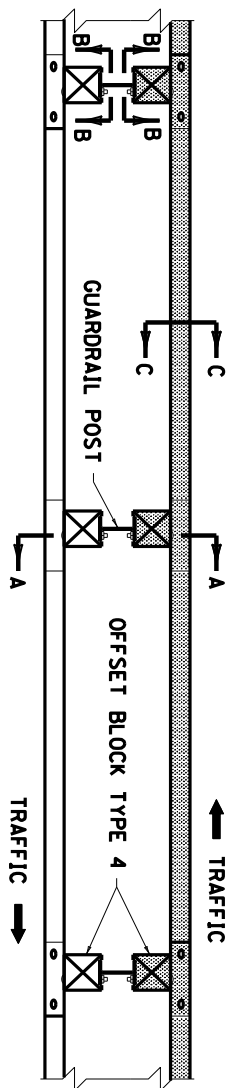
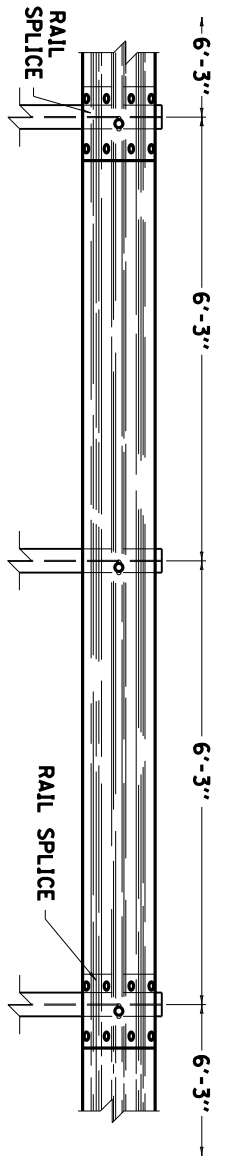

3/4" x 2 1/2" POST BOLT SLOT 6'-3" O. C.

SECTION B-B RAIL SPLICE ②

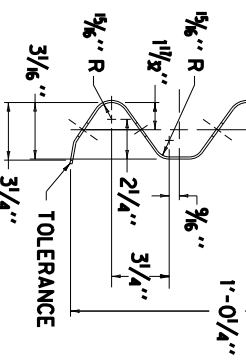

SECTION C-C (RAIL CORRUGATED SHEET STEEL BEAM)

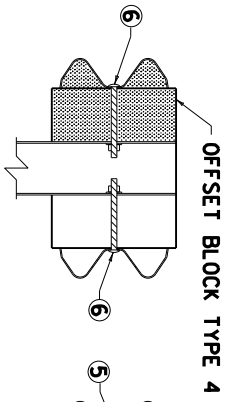

SECTION A-A

DOUBLE FACE RAIL WITH STEEL POST (W6x9) (TIMBER OFFSET BLOCK)

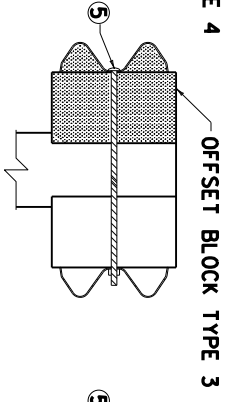

SECTION A-A

DOUBLE FACE RAIL WITH ROUND TIMBER POST

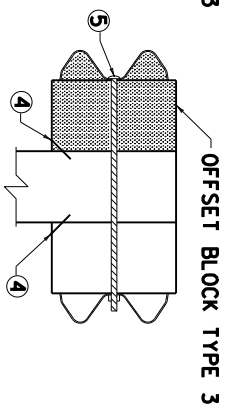

SECTION A-A

DOUBLE FACE RAIL WITH TIMBER POST

COUNTY OF	ITEM NO.	SHEET NO.

NOTES

- 1 TOLERANCE + 1/4", -1/4"
- 2 8 - 5/8" x 1 1/4" LONG BUTTON HEAD BOLTS AND HEX HEAD RECESS NUTS REQUIRED FOR EACH RAIL SPLICE.
- 3 LENGTH EQUALS POST AND BLOCK WIDTH PLUS: 2" FOR BOLT OR 2 1/4" FOR THREADED ROD.
- 4 GALVANIZED STEEL 10d COMMON COATED NAIL (DRIVE POST AT THE TOP OR BOTTOM CENTER OF BLOCK AND NAIL AT THE TOP OR BOTTOM CENTER OF BLOCK AND POST AFTER BOLT IS INSTALLED).
- 5 3/8" x 3 STEEL THREADED ROD AND TWO (2) HEX HEAD NUTS OR 5/8" x 3 BUTTON OR HEX HEAD BOLT AND HEX HEAD NUT.
- 6 5/8" x 8" BUTTON HEAD BOLT, HEX HEAD RECESS NUT AND ONE 3/8" ROUND WASHER (TYP.). BOLT SHALL HAVE A MINIMUM THREAD LENGTH OF 2".
- 7 BOTH 12'-6" AND 25' LENGTHS OF W-BEAM GUARDRAIL SECTIONS WILL BE PERMITTED UNLESS OTHERWISE DIRECTED BY THE ENGINEER.

KENTUCKY  
DEPARTMENT OF HIGHWAYS  
**STEEL BEAM  
GUARDRAIL  
( "W" BEAM )**

SUBMITTED \_\_\_\_\_  
DIRECTION DIVISION OF DESIGN \_\_\_\_\_  
DATE 12-11-12  
012

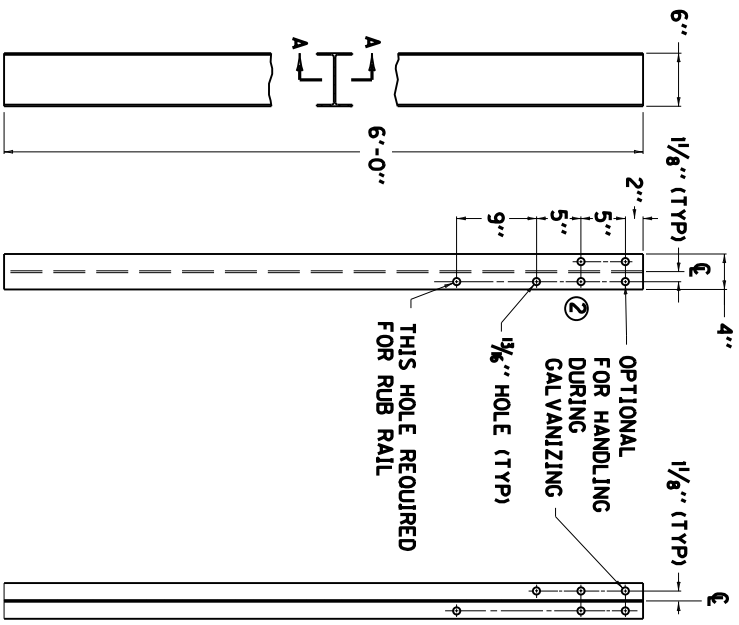

FRONT VIEW SECTION A-A

~ W6 X 9.0 STEEL POST ① ~

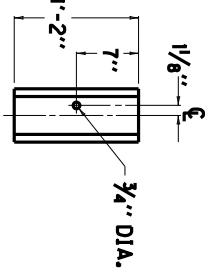

REAR ELEVATION

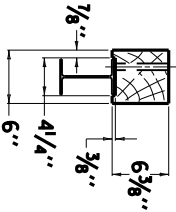

PLAN VIEW

OFFSET BLOCK TYPE 4

(FOR USE WITH STEEL POST ONLY)

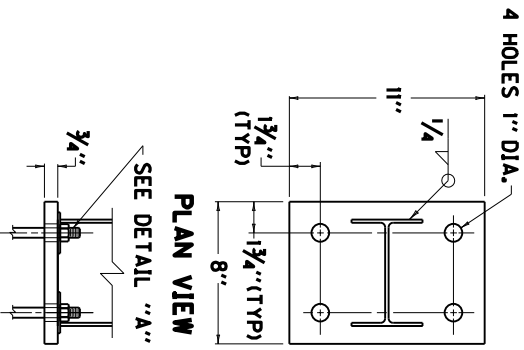

PLAN VIEW

SEE DETAIL "A"

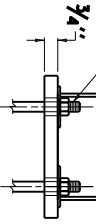

SIDE VIEW ANCHOR PLATE

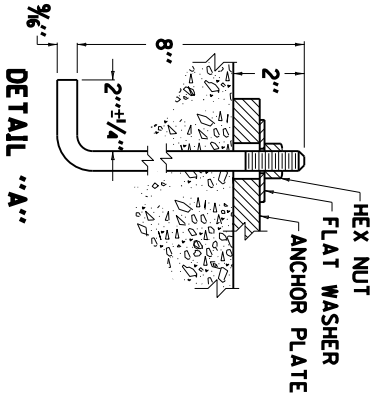

DETAIL "A"

- ~ NOTES ~
- ① W6 X 8.5 IS AN ACCEPTABLE ALTERNATE.
  - ② THESE HOLES REQUIRED FOR ATTACHING RAIL.

KENTUCKY DEPARTMENT OF HIGHWAYS	
<b>GUARDRAIL POSTS</b>	
SUBMITTED:	DATE: 9-27-13
013	

COUNTY OF	ITEM NO.	SHEET

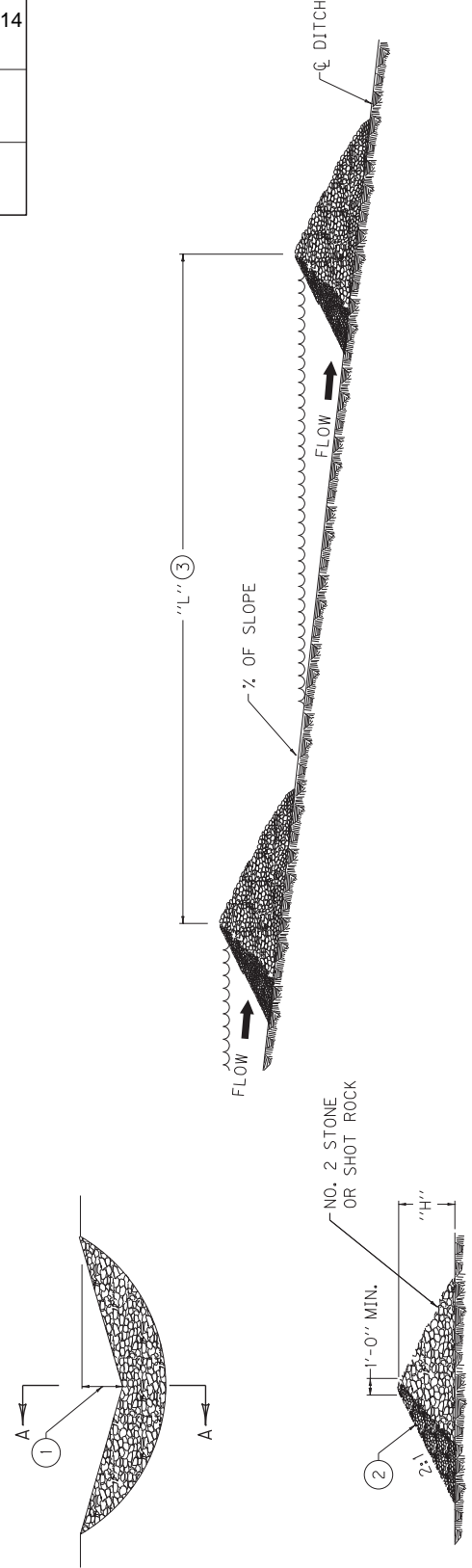

SECTION "A-A"

~NOTES~

- BID ITEM AND UNIT TO BID:
- | CODE | PAY ITEM               | PAY UNIT |
|------|------------------------|----------|
| 2704 | SILT TRAP TYPE B       | EACH     |
| 2707 | CLEAN SILT TRAP TYPE B | EACH     |
- MIDDLE OF SILT TRAP SHALL BE A MINIMUM OF 1'-0" LOWER THAN SIDES SO FLOW WILL NOT BYPASS TRAP OR ERODE BANKS.
  - UPSTREAM FACE OF SILT TRAP SHALL BE A FOUR INCH MIN. LAYER OF CRUSHED AGGREGATE HAVING 100% PASSING A 3" SIEVE AND NO MORE THAN 5% PASSING A NO. 8 SIEVE. (SEE SECTION "A-A").
  - "L" = SLOPE OF DITCH
  - SPACE SILT TRAPS AT LOCATIONS AS SHOWN ON THE PLANS OR AS DIRECTED BY THE ENGINEER.
  - SILT TRAP TYPE B SHALL BE USED ON ALL SLOPES GREATER THAN 2%.
  - SILT TRAP TYPE B MAY BE USED ON ALL SLOPES LESS THAN 2%.

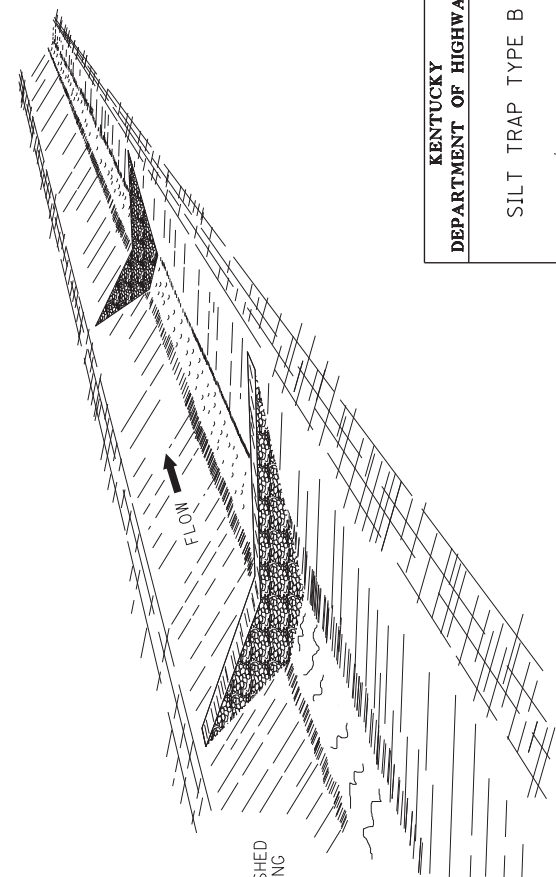

**KENTUCKY**  
**DEPARTMENT OF HIGHWAYS**

SILT TRAP TYPE B

SUBMITTED: *[Signature]* DATE: 7-18-13  
016

## **PART III**

### **EMPLOYMENT, WAGE AND RECORD REQUIREMENTS**

**TRANSPORTATION CABINET  
DEPARTMENT OF HIGHWAYS**

**LABOR AND WAGE REQUIREMENTS  
APPLICABLE TO OTHER THAN FEDERAL-AID SYSTEM PROJECTS**

- I. Application
- II. Nondiscrimination of Employees (KRS 344)
- III. Payment of Predetermined Minimum Wages
- IV. Statements and Payrolls

**I. APPLICATION**

1. These contract provisions shall apply to all work performed on the contract by the contractor with his own organization and with the assistance of workmen under his immediate superintendence and to all work performed on the contract by piecework, station work or by subcontract. The contractor's organization shall be construed to include only workmen employed and paid directly by the contractor and equipment owned or rented by him, with or without operators.

2. The contractor shall insert in each of his subcontracts all of the stipulations contained in these Required Provisions and such other stipulations as may be required.

3. A breach of any of the stipulations contained in these Required Provisions may be grounds for termination of the contract.

**II. NONDISCRIMINATION OF EMPLOYEES**

**AN ACT OF THE KENTUCKY  
GENERAL ASSEMBLY TO PREVENT  
DISCRIMINATION IN EMPLOYMENT  
KRS CHAPTER 344  
EFFECTIVE JUNE 16, 1972**

The contract on this project, in accordance with KRS Chapter 344, provides that during the performance of this contract, the contractor agrees as follows:

1. The contractor shall not fail or refuse to hire, or shall not discharge any individual, or otherwise discriminate against an individual with respect to his compensation, terms, conditions, or privileges of employment, because of such individual's race, color, religion, national origin, sex, disability or age (between forty and seventy); or limit, segregate, or classify his employees in any way which would deprive or tend to deprive an individual of employment opportunities or otherwise adversely affect his status as an employee, because of such individual's race, color, religion, national origin, sex, disability or age (between forty and seventy). The contractor agrees to post in conspicuous places, available to employees and applicants for employment, notices to be provided setting forth the provisions of this nondiscrimination clause.

2. The contractor shall not print or publish or cause to be printed or published a notice or advertisement relating to employment by such an employer or membership in or any classification or referral for employment by the employment agency, indicating any preference, limitation, specification, or discrimination, based on race, color, religion, national origin, sex, disability or age (between forty and seventy), except that such notice or advertisement may indicate a preference, limitation, or specification based on religion, or national origin when religion, or national origin is a bona fide occupational qualification for employment.

3. If the contractor is in control of apprenticeship or other training or retraining, including on-the-job training programs, he shall not discriminate against an individual

because of his race, color, religion, national origin, sex, disability or age (between forty and seventy), in admission to, or employment in any program established to provide apprenticeship or other training.

4. The contractor will send to each labor union or representative of workers with which he has a collective bargaining agreement or other contract or understanding, a notice to be provided advising the said labor union or workers' representative of the contractor's commitments under this section, and shall post copies of the notice in conspicuous places available to employees and applicants for employment. The contractor will take such action with respect to any subcontract or purchase order as the administering agency may direct as a means of enforcing such provisions, including sanctions for non-compliance.

**III. PAYMENT OF PREDETERMINED MINIMUM WAGES**

1. These special provisions are supplemented elsewhere in the contract by special provisions which set forth certain predetermined minimum wage rates. The contractor shall pay not less than those rates.

2. The minimum wage determination schedule shall be posted by the contractor, in a manner prescribed by the Department of Highways, at the site of the work in prominent places where it can be easily seen by the workers.

**IV. STATEMENTS AND PAYROLLS**

1. All contractors and subcontractors affected by the terms of KRS 337.505 to 337.550 shall keep full and accurate payroll records covering all disbursements of wages to their employees to whom they are required to pay not less than the prevailing rate of wages. Payrolls and basic records relating thereto will be maintained during the course of the work and preserved for a period of one (1) year from the date of completion of this contract.

2. The payroll records shall contain the name, address and social security number of each employee, his correct classification, rate of pay, daily and weekly number of hours worked, itemized deductions made and actual wages paid.

3. The contractor shall make his daily records available at the project site for inspection by the State Department of Highways contracting office or his authorized representative.

Periodic investigations shall be conducted as required to assure compliance with the labor provisions of the contract. Interrogation of employees and officials of the contractor shall be permitted during working hours.

Aggrieved workers, Highway Managers, Assistant District Engineers, Resident Engineers and Project Engineers shall report all complaints and violations to the Division of Contract Procurement.

The contractor shall be notified in writing of apparent violations. The contractor may correct the reported violations and notify the Department of Highways of the action taken or may request an informal hearing. The request for hearing shall be in writing within ten (10) days after receipt of the notice of the reported violation. The contractor may submit

records and information which will aid in determining the true facts relating to the reported violations.

Any person or organization aggrieved by the action taken or the findings established as a result of an informal hearing by the Division of Contract Procurement may request a formal hearing.

4. The wages of labor shall be paid in legal tender of the United States, except that this condition will be considered satisfied if payment is made by a negotiable check, on a solvent bank, which may be cashed readily by the employee in the local community for the full amount, without discount or collection charges of any kind. Where checks are used for payments, the contractor shall make all necessary arrangements for them to be cashed and shall give information regarding such arrangements.

5. No fee of any kind shall be asked or accepted by the contractor or any of his agents from any person as a condition of employment on the project.

6. No laborers shall be charged for any tools used in performing their respective duties except for reasonably avoidable loss or damage thereto.

7. Every employee on the work covered by this contract shall be permitted to lodge, board, and trade where and with whom he elects and neither the contractor nor his agents, nor his employees shall directly or indirectly require as a condition of employment that an employee shall lodge, board or trade at a particular place or with a particular person.

8. Every employee on the project covered by this contract shall be an employee of either the prime contractor or an approved subcontractor.

9. No charge shall be made for any transportation furnished by the contractor or his agents to any person employed on the work.

10. No individual shall be employed as a laborer or mechanic on this contract except on a wage basis, but this shall not be construed to prohibit the rental of teams, trucks or other equipment from individuals.

No Covered employee may be employed on the work except in accordance with the classification set forth in the schedule mentioned above; provided, however, that in the event additional classifications are required, application shall be made by the contractor to the Department of Highways and (1) the Department shall request appropriate classifications and rates from the proper agency, or (2) if there is urgent need for additional classification to avoid undue delay in the work, the contractor may employ such workmen at rates deemed comparable to rates established for similar classifications provided he has made written application through the Department of Highways, addressed to the proper agency, for the supplemental rates. The contractor shall retroactively adjust, upon receipt of the supplemental rates schedule, the wages of any employee paid less than the established rate and may adjust the wages of any employee overpaid.

11. No contractor or subcontractor contracting for any part of the contract work which may require or involve the employment of laborers or mechanics shall require or permit any laborer or mechanic in any work-week in which he is employed on such work, to work in excess of eight hours in any calendar day or in excess of forty hours in such work-week unless such laborer or mechanic receives compensation at a rate not less than one and one half times his basic rate of pay for all hours worked in excess of eight hours in any calendar day or in excess of forty hours in such work-week. A laborer, workman or mechanic and an employer may enter into a written agreement or a collective bargaining agreement to work more than eight (8) hours a calendar day but not more than ten (10) hours a calendar day for the straight time hourly rate. This agreement shall be in writing and shall be executed prior to the employee working in excess of eight (8) hours, but not more than ten (10) hours, in any one (1) calendar day.

12. Payments to the contractor may be suspended or withheld due to failure of the contractor to pay any laborer or

mechanic employed or working on the site of the work, all or part of the wages required under the terms of the contract. The Department may suspend or withhold payments only after the contractor has been given written notice of the alleged violation and the contractor has failed to comply with the wage determination of the Department of Highways.

13. Contractors and subcontractors shall comply with the sections of Kentucky Revised Statutes, Chapter 337 relating to contracts for Public Works.

Revised 2-16-95

## EXECUTIVE BRANCH CODE OF ETHICS

In the 1992 regular legislative session, the General Assembly passed and Governor Brereton Jones signed Senate Bill 63 (codified as KRS 11A), the Executive Branch Code of Ethics, which states, in part:

KRS 11A.040 (6) provides:

No present or former public servant shall, within six (6) months of following termination of his office or employment, accept employment, compensation or other economic benefit from any person or business that contracts or does business with the state in matters in which he was directly involved during his tenure. This provision shall not prohibit an individual from returning to the same business, firm, occupation, or profession in which he was involved prior to taking office or beginning his term of employment, provided that, for a period of six (6) months, he personally refrains from working on any matter in which he was directly involved in state government. This subsection shall not prohibit the performance of ministerial functions, including, but not limited to, filing tax returns, filing applications for permits or licenses, or filing incorporation papers.

KRS 11A.040 (8) states:

A former public servant shall not represent a person in a matter before a state agency in which the former public servant was directly involved, for a period of one (1) year after the latter of:

- a) The date of leaving office or termination of employment; or
- b) The date the term of office expires to which the public servant was elected.

This law is intended to promote public confidence in the integrity of state government and to declare as public policy the idea that state employees should view their work as a public trust and not as a way to obtain private benefits.

If you have worked for the executive branch of state government within the past six months, you may be subject to the law's prohibitions. The law's applicability may be different if you hold elected office or are contemplating representation of another before a state agency.

Also, if you are affiliated with a firm which does business with the state and which employs former state executive-branch employees, you should be aware that the law may apply to them.

In case of doubt, the law permits you to request an advisory opinion from the Executive Branch Ethics Commission, Room 136, Capitol Building, 700 Capitol Avenue, Frankfort, Kentucky 40601; telephone (502) 564-7954.

### **Kentucky Equal Employment Opportunity Act of 1978**

The requirements of the Kentucky Equal Employment Opportunity Act of 1978 (KRS 45.560-45.640) shall apply to this Contract. The apparent low Bidder will be required to submit EEO forms to the Division of Construction Procurement, which will then forward to the Finance and Administration Cabinet for review and approval. No award will become effective until all forms are submitted and EEO/CC has certified compliance. The required EEO forms are as follows:

- EEO-1: Employer Information Report
- Affidavit of Intent to Comply
- Employee Data Sheet
- Subcontractor Report

These forms are available on the Finance and Administration's web page under ***Vendor Information, Standard Attachments and General Terms*** at the following address:  
**<https://www.eProcurement.ky.gov>**.

Bidders currently certified as being in compliance by the Finance and Administration Cabinet may submit a copy of their approval letter in lieu of the referenced EEO forms.

For questions or assistance please contact the Finance and Administration Cabinet by email at **[finance.contractcompliance@ky.gov](mailto:finance.contractcompliance@ky.gov)** or by phone at 502-564-2874.

General Decision Number: KY150101 06/19/2015 KY101

Superseded General Decision Number: KY20140101

State: Kentucky

Construction Type: Highway

Counties: Boone, Campbell, Kenton and Pendleton Counties in Kentucky.

HIGHWAY CONSTRUCTION PROJECTS (excluding tunnels, building structures in rest area projects & railroad construction; bascule, suspension & spandrel arch bridges designed for commercial navigation, bridges involving marine construction; and other major bridges).

Note: Executive Order (EO) 13658 establishes an hourly minimum wage of \$10.10 for 2015 that applies to all contracts subject to the Davis-Bacon Act for which the solicitation is issued on or after January 1, 2015. If this contract is covered by the EO, the contractor must pay all workers in any classification listed on this wage determination at least \$10.10 (or the applicable wage rate listed on this wage determination, if it is higher) for all hours spent performing on the contract. The EO minimum wage rate will be adjusted annually. Additional information on contractor requirements and worker protections under the EO is available at [www.dol.gov/whd/govcontracts](http://www.dol.gov/whd/govcontracts).

Modification Number	Publication Date
0	01/02/2015
1	01/23/2015
2	05/01/2015
3	06/05/2015
4	06/19/2015

BRKY0002-005 06/01/2014

	Rates	Fringes
BRICKLAYER.....	\$ 26.50	11.17

BROH0001-005 06/01/2008

	Rates	Fringes
CEMENT MASON/CONCRETE FINISHER...	\$ 25.75	8.60

CARP0698-001 05/01/2014

BOONE, CAMPBELL, KENTON & PENDLETON COUNTIES:

	Rates	Fringes
Carpenter & Piledrivermen.....	\$ 27.27	14.59
Diver.....	\$ 40.58	9.69

\* ELEC0212-007 06/01/2015

	Rates	Fringes
ELECTRICIAN.....	\$ 27.03	17.02

ELEC0212-013 12/01/2014

	Rates	Fringes
Sound & Communication Technician.....	\$ 22.75	10.08

ENGI0018-013 05/01/2014

	Rates	Fringes
POWER EQUIPMENT OPERATOR		
GROUP 1.....	\$ 32.44	13.90
GROUP 2.....	\$ 32.32	13.90
GROUP 3.....	\$ 31.28	13.90
GROUP 4.....	\$ 30.10	13.90
GROUP 5.....	\$ 24.64	13.90
GROUP 6.....	\$ 32.69	13.90
GROUP 7.....	\$ 32.94	13.90

OPERATING ENGINEER CLASSIFICATIONS

GROUP 1 - Air Compressor on Steel Erection; Barrier Moving Machine; Boiler Operator on Compressor or Generator when mounted on a Rig; Cableway; Combination Concrete Mixer & Tower; Concrete Plant (over 4 yd. Capacity); Concrete Pump; Crane (All Types, Including Boom Truck, Cherry Picker); Crane-Compact, Track or Rubber over 4,000 lbs. capacity; Cranes-Self Erecting, Stationary, Track or Truck (All Configurations); Derrick; Dragline; Dredge (Dipper, Clam or Suction); Elevating Grader or Euclid Loader; Floating Equipment (All Types); Gradall; Helicopter Crew (Operator-Hoist or Winch); Hoe (all types); Hoisting Engine on Shaft or Tunnel Work; Hydraulic Gantry (Lifting System); Industrial-Type Tractor; Jet Engine Dryer (D8 or D9) Diesel Tractor; Locomotive (Standard Gauge); Maintenance Operator Class A; Mixer, Paving (Single or Double Drum); Mucking Machine; Multiple Scraper; Piledriving Machine (All Types); Power Shovel; Prentice Loader; Quad 9 (Double Pusher); Rail Tamper (with auto lifting & aligning device); Refrigerating Machine (Freezer Operation); Rotary Drill, on Caisson work; Rough Terrain Fork Lift with Winch/Hoist; Side-Boom; Slip-Form Paver; Tower Derrick; Tree Shredder; Trench Machine (Over 24" wide); Truck Mounted Concrete Pump; Tug Boat; Tunnel Machine and/or Mining Machine; & Wheel Excavator

GROUP 2 - Asphalt Paver; Automatic Subgrader Machine, Self-Propelled (CMI Type); Bobcat Type and/or Skid Steer Loader with Hoe Attachment Greater than 7,000 lbs.; Boring Machine More than 48"; Bulldozer; Endloader; Hydro Milling Machine; Horizontal Directional Drill (over 500,000 ft. lbs. thrust); Kolman-type Loader (production type-Dirt); Lead Greaseman; Lighting & Traffic Signal Installation

Equipment (includes all groups or classifications);  
 Material Transfer Equipment (Shuttle Buggy) Asphalt;  
 Pettibone-Rail Equipment; Power Grader; Power Scraper; Push  
 Cat; Rotomill (all), Grinders & Planers of All types;  
 Trench Machine (24" wide & under); & Vermeer type Concrete  
 Saw

GROUP 3 - A-Frame; Air Compressor on Tunnel Work (low  
 pressure); Asphalt Plant Engineer; Bobcat-type and/or Skid  
 Steer Loader with or without Attachments; Highway Drills  
 (all types); Locomotive (narrow gauge); Material  
 Hoist/Elevator; Mixer, Concrete (more than one bag  
 capacity); Mixer, one bag capacity (Side Loader); Power  
 Boiler (Over 15 lbs. Pressure) Pump Operator installing &  
 operating Well Points; Pump (4" & over discharge); Roller,  
 Asphalt; Rotovator (lime soil stabilizer); Switch & Tie  
 Tampers (without lifting & aligning device); Utility  
 Operator (Small equipment); & Welding Machines

GROUP 4 - Backfiller; Ballast Re-locator; Bars, Joint & Mesh  
 Installing Machine; Batch Plant; Boring Machine Operator  
 (48" or less); Bull Floats; Burlap & Curing Machine;  
 Concrete Plant (capacity 4 yd. & under); Concrete Saw  
 (Multiple); Conveyor (Highway); Crusher; Deckhand;  
 Farm-type Tractor with attachments (highway) except  
 Masonry); Finishing Machine; Fireperson, Floating Equipment  
 (all types); Fork Lift (highway); Form Trencher; Hydro  
 Hammer; Hydro Seeder; Pavement Breaker; Plant Mixer; Post  
 Driver; Post Hole Digger (Power Auger); Power Brush Burner;  
 Power Form Handling Equipment; Road Widening Trencher;  
 Roller (Brick, Grade & Macadam); Self-Propelled Power  
 Spreader; Self-Propelled Power Subgrader; Steam Fireperson;  
 Tractor (Pulling Sheepfoot, Roller or Grader); & Vibratory  
 Compactor with Integral Power

GROUP 5 - Compressor (Portable, Sewer, Heavy & Highway); Drum  
 Fireperson (Asphalt); Generator; Masonry Fork Lift;  
 Inboard-Outboard Motor Boat Launch; Masonry Fork Lift; Oil  
 Heater (asphalt plant); Oiler; Power Driven Heater; Power  
 Sweeper & Scrubber; Pump (under 4" discharge);  
 Signalperson; Tire Repairperson; & VAC/ALLS

GROUP 6 - Master Mechanic & Boom from 150 to 180

GROUP 7 - Boom from 180 and over

-----  
 IRON0044-008 06/01/2015

	Rates	Fringes
Ironworkers:		
Fence Erector.....	\$ 23.76	19.15
Structural.....	\$ 26.40	19.15

-----  
 IRON0372-004 07/01/2014

	Rates	Fringes
IRONWORKER, REINFORCING.....	\$ 26.25	18.45

-----  
 LABO0189-004 07/01/2014

PENDLETON COUNTY:

	Rates	Fringes
LABORER		
GROUP 1.....	\$ 21.80	11.96
GROUP 2.....	\$ 22.05	11.96
GROUP 3.....	\$ 22.10	11.96
GROUP 4.....	\$ 22.70	11.96

LABORERS CLASSIFICATIONS

GROUP 1 - Aging & Curing of Concrete; Asbestos Abatement Worker; Asphalt Plant; Asphalt; Batch Truck Dump; Carpenter Tender; Cement Mason Tender; Cleaning of Machines; Concrete; Demolition; Dredging; Environmental - Nuclear, Radiation, Toxic & Hazardous Waste - Level D; Flagperson; Grade Checker; Hand Digging & Hand Back Filling; Highway Marker Placer; Landscaping, Mesh Handler & Placer; Puddler; Railroad; Rip-rap & Grouter; Right-of-Way; Sign, Guard Rail & Fence Installer; Signal Person; Sound Barrier Installer; Storm & Sanitary Sewer; Swamper; Truck Spotter & Dumper; Wrecking of Concrete Forms; General Cleanup

GROUP 2 - Batter Board Man (Sanitary & Storm Sewer); Brickmason Tender; Mortar Mixer Operator; Scaffold Builder; Burner & Welder; Bushhammer; Chain Saw Operator; Concrete Saw Operator; Deckhand Scow Man; Dry Cement Handler; Environmental - Nuclear, Radiation, Toxic & Hazardous Waste - Level C; Forklift Operator for Masonary; Form Setter; Green Concrete Cutting; Hand Operated Grouter & Grinder Machine Operator; Jackhammer; Pavement Breaker; Paving Joint Machine; Pipelayer; Plastic Pipe Fusion; Power Driven Georgia Buggy & Wheel Barrow; Power Post Hole Digger; Precast Manhole Setter; Walk-Behind Tamper; Walk-Behind Trencher; Sand Blaster; Concrete Chipper; Surface Grinder; Vibrator Operator; Wagon Driller

GROUP 3 - Asphalt Luteman & Raker; Gunnite Nozzleman; Gunnite Operator & Mixer; Grout Pump Operator; Side Rail Setter; Rail Paved Ditches; Screw Operator; Tunnel (Free Air); Water Blaster

GROUP 4 - Caisson Worker (Free Air); Cement Finisher; Environmental - Nuclear, Radiation, Toxic & Hazardous Waste - Levels A & B; Miner & Driller (Free Air); Tunnel Blaster; & Tunnel Mucker (Free Air); Directional & Horizontal Boring; Air Track Driller (All Types); Powderman & Blaster; Troxler & Concrete Tester if Laborer is Utilized

-----  
 LABO0265-009 05/01/2015

BOONE, CAMPBELL & KENTON COUNTIES:

Rates	Fringes
-------	---------

LABORER

GROUP 1.....	\$ 28.72	9.85
GROUP 2.....	\$ 28.89	9.85
GROUP 3.....	\$ 29.22	9.85
GROUP 4.....	\$ 29.67	9.85

LABORER CLASSIFICATIONS

GROUP 1 - Asphalt Laborer; Carpenter Tender; Concrete Curing Applicator; Dump Man (Batch Truck); Guardrail and Fence Installer; Joint Setter; Laborer (Construction); Landscape Laborer; Highway Lighting Worker; Signalization Worker; Mesh Handlers & Placer; Right-of-way Laborer; Riprap Laborer & Grouter; Scaffold Erector; Seal Coating; Surface Treatment or Road Mix Laborer; Sign Installer; Slurry Seal; Utility Man; Bridge Man; Handyman; Waterproofing Laborer; Flagperson; Hazardous Waste (level D); Diver Tender; Zone Person & Traffic Control

GROUP 2 - Skid Steer; Asphalt Raker; Concrete Puddler; Kettle Man (Pipeline); Machine Driven Tools (Gas, Electric, Air); Mason Tender; Brick Paver; Mortar Mixer; Power Buggy or Power Wheelbarrow; Sheeting & Shoring Man; Surface Grinder Man; Plastic Fusing Machine Operator; Pug Mill Operator; & Vacuum Devices (wet or dry); Rodding Machine Operator; Diver; Screwman or Paver; Screed Person; Water Blast, Hand Held Wand; Pumps 4" & Under (Gas, Air or Electric) & Hazardous Waste (level C); Air Track and Wagon Drill; Bottom Person; Cofferdam (below 25 ft. deep); Concrete Saw Person; Cutting with Burning Torch; Form Setter; Hand Spiker (Railroad); Pipelayer; Tunnel Laborer (without air) & Caisson; Underground Person (working in Sewer and Waterline, Cleaning, Repairing & Reconditioning); Sandblaster Nozzle Person; & Hazardous Waste (level B)

GROUP 3 - Blaster; Mucker; Powder Person; Top Lander; Wrencher (Mechanical Joints & Utility Pipeline); Yarnier; Hazardous Waste (level A); Concrete Specialist; Concrete Crew in Tunnels (With Air-pressurized - \$1.00 premium); Curb Setter & Cutter; Grade Checker; Utility Pipeline Tapper; Waterline; and Caulker

GROUP 4 - Miner; & Gunite Nozzle Person

TUNNEL LABORER WITH AIR-PRESSURIZED ADD \$1.00 TO BASE RATE

SIGNAL PERSON WILL RECEIVE THE RATE EQUAL TO THE RATE PAID THE LABORER CLASSIFICATION FOR WHICH HE OR SHE IS SIGNALING.

-----  
 PAIN0012-016 05/01/2015

	Rates	Fringes
PAINTER		
Bridge.....	\$ 24.39	9.06
Bridge Equipment Tender and Containment Builder.....	\$ 20.73	9.06
Brush & Roller.....	\$ 23.39	9.06

Sandblasting & Water		
Blasting.....	\$ 24.14	9.06
Spray.....	\$ 23.89	9.06

-----  
PLUM0392-008 06/01/2014

	Rates	Fringes
PLUMBER.....	\$ 29.80	17.79

-----  
SUKY2010-161 02/05/1996

	Rates	Fringes
Truck drivers:		
GROUP 1.....	\$ 15.85	4.60
GROUP 2.....	\$ 16.29	4.60

TRUCK DRIVER CLASSIFICATIONS

GROUP 1 - Driver

GROUP 2 - Euclid Wagon; End Dump; Lowboy; Heavy Duty  
Equipment; Tractor-Trailer Combination; & Drag

-----  
WELDERS - Receive rate prescribed for craft performing  
operation to which welding is incidental.

=====  
Unlisted classifications needed for work not included within  
the scope of the classifications listed may be added after  
award only as provided in the labor standards contract clauses  
(29CFR 5.5 (a) (1) (ii)).

-----  
The body of each wage determination lists the classification  
and wage rates that have been found to be prevailing for the  
cited type(s) of construction in the area covered by the wage  
determination. The classifications are listed in alphabetical  
order of "identifiers" that indicate whether the particular  
rate is a union rate (current union negotiated rate for local),  
a survey rate (weighted average rate) or a union average rate  
(weighted union average rate).

Union Rate Identifiers

A four letter classification abbreviation identifier enclosed  
in dotted lines beginning with characters other than "SU" or  
"UAVG" denotes that the union classification and rate were  
prevailing for that classification in the survey. Example:  
PLUM0198-005 07/01/2014. PLUM is an abbreviation identifier of  
the union which prevailed in the survey for this  
classification, which in this example would be Plumbers. 0198

indicates the local union number or district council number where applicable, i.e., Plumbers Local 0198. The next number, 005 in the example, is an internal number used in processing the wage determination. 07/01/2014 is the effective date of the most current negotiated rate, which in this example is July 1, 2014.

Union prevailing wage rates are updated to reflect all rate changes in the collective bargaining agreement (CBA) governing this classification and rate.

Survey Rate Identifiers

Classifications listed under the "SU" identifier indicate that no one rate prevailed for this classification in the survey and the published rate is derived by computing a weighted average rate based on all the rates reported in the survey for that classification. As this weighted average rate includes all rates reported in the survey, it may include both union and non-union rates. Example: SULA2012-007 5/13/2014. SU indicates the rates are survey rates based on a weighted average calculation of rates and are not majority rates. LA indicates the State of Louisiana. 2012 is the year of survey on which these classifications and rates are based. The next number, 007 in the example, is an internal number used in producing the wage determination. 5/13/2014 indicates the survey completion date for the classifications and rates under that identifier.

Survey wage rates are not updated and remain in effect until a new survey is conducted.

Union Average Rate Identifiers

Classification(s) listed under the UAVG identifier indicate that no single majority rate prevailed for those classifications; however, 100% of the data reported for the classifications was union data. EXAMPLE: UAVG-OH-0010 08/29/2014. UAVG indicates that the rate is a weighted union average rate. OH indicates the state. The next number, 0010 in the example, is an internal number used in producing the wage determination. 08/29/2014 indicates the survey completion date for the classifications and rates under that identifier.

A UAVG rate will be updated once a year, usually in January of each year, to reflect a weighted average of the current negotiated/CBA rate of the union locals from which the rate is based.

-----  
WAGE DETERMINATION APPEALS PROCESS

1.) Has there been an initial decision in the matter? This can be:

- \* an existing published wage determination
- \* a survey underlying a wage determination
- \* a Wage and Hour Division letter setting forth a position on

- a wage determination matter
- \* a conformance (additional classification and rate) ruling

On survey related matters, initial contact, including requests for summaries of surveys, should be with the Wage and Hour Regional Office for the area in which the survey was conducted because those Regional Offices have responsibility for the Davis-Bacon survey program. If the response from this initial contact is not satisfactory, then the process described in 2.) and 3.) should be followed.

With regard to any other matter not yet ripe for the formal process described here, initial contact should be with the Branch of Construction Wage Determinations. Write to:

Branch of Construction Wage Determinations  
Wage and Hour Division  
U.S. Department of Labor  
200 Constitution Avenue, N.W.  
Washington, DC 20210

2.) If the answer to the question in 1.) is yes, then an interested party (those affected by the action) can request review and reconsideration from the Wage and Hour Administrator (See 29 CFR Part 1.8 and 29 CFR Part 7). Write to:

Wage and Hour Administrator  
U.S. Department of Labor  
200 Constitution Avenue, N.W.  
Washington, DC 20210

The request should be accompanied by a full statement of the interested party's position and by any information (wage payment data, project description, area practice material, etc.) that the requestor considers relevant to the issue.

3.) If the decision of the Administrator is not favorable, an interested party may appeal directly to the Administrative Review Board (formerly the Wage Appeals Board). Write to:

Administrative Review Board  
U.S. Department of Labor  
200 Constitution Avenue, N.W.  
Washington, DC 20210

4.) All decisions by the Administrative Review Board are final.

=====

END OF GENERAL DECISION

Fringe benefit amounts are applicable for all hours worked except when otherwise noted.

These rates are listed pursuant to the Kentucky Determination No. CR-14-IV-HWY dated July 14, 2014.

No laborer, workman or mechanic shall be paid at a rate less than that of a Journeyman except those classified as bona fide apprentices.

Apprentices or trainees shall be permitted to work as such subject to Administrative Regulations adopted by the Commissioner of Workplace Standards. Copies of these regulations will be furnished upon request from any interested person.

Before using apprentices on the job the contractor shall present to the Contracting Officer written evidence of registration of such employees in a program of a State apprenticeship and training agency approved and recognized by the U. S. Bureau of Apprenticeship and Training. In the absence of such a State agency, the contractor shall submit evidence of approval and registration by the U. S. Bureau of Apprenticeship and Training.

The contractor shall submit to the Contracting Officer, written evidence of the established apprenticeship-journeyman ratios and wage rates in the project area, which will be the basis for establishing such ratios and rates for the project under the applicable contract provisions.

**TO: EMPLOYERS/EMPLOYEES**

**PREVAILING WAGE SCHEDULE:**

**The wages indicated on this wage schedule are the least permitted to be paid for the occupations indicated. When an employee works in more than one classification, the employer must record the number of hours worked in each classification at the prescribed hourly base rate.**

**OVERTIME:**

**Overtime is to be paid after an employee works eight (8) hours a day or forty (40) hours a week, whichever gives the employee the greater wages. At least time and one-half the base rate is required for all overtime. A laborer, workman or mechanic and an employer may enter into a written agreement or a collective bargaining agreement to work more than eight (8) hours a calendar day but not more than ten (10) hours a calendar day for the straight time hourly rate. Wage violations or questions should be directed to the designated Engineer or the undersigned.**

Director  
Division of Construction Procurement  
Frankfort, Kentucky 40622  
502-564-3500

**PART IV**  
**INSURANCE**

## INSURANCE

The Contractor shall procure and maintain the following insurance in addition to the insurance required by law:

- 1) Commercial General Liability-Occurrence form – not less than \$2,000,000 General aggregate, \$2,000,000 Products & Completed Aggregate, \$1,000,000 Personal & Advertising, \$1,000,000 each occurrence.
- 2) Automobile Liability- \$1,000,000 per accident
- 3) Employers Liability:
  - a) \$100,000 Each Accident Bodily Injury
  - b) \$500,000 Policy limit Bodily Injury by Disease
  - c) \$100,000 Each Employee Bodily Injury by Disease
- 4) The insurance required above must be evidenced by a Certificate of Insurance and this Certificate of Insurance must contain one of the following statements:
  - a) "policy contains no deductible clauses."
  - b) "policy contains \_\_\_\_\_ (amount) deductible property damage clause but company will pay claim and collect the deductible from the insured."
- 5) **KENTUCKY WORKMEN'S COMPENSATION INSURANCE.** The contractor shall furnish evidence of coverage of all his employees or give evidence of self-insurance by submitting a copy of a certificate issued by the Workmen's Compensation Board.

The cost of insurance is incidental to all contract items. All subcontractors must meet the same minimum insurance requirements.

**PART V**  
**BID ITEMS**

### PROPOSAL BID ITEMS

152269

Page 1 of 2

Report Date 7/6/15

#### Section: 0001 - PAVING

LINE	BID CODE	ALT	DESCRIPTION	QUANTITY	UNIT	UNIT PRIC	FP	AMOUNT
0010	00001		DGA BASE	50.00	TON		\$	
0020	00190		LEVELING & WEDGING PG64-22	25.00	TON		\$	
0030	00223		CL3 ASPH BASE 0.75D PG64-22	50.00	TON		\$	
0040	02676		MOBILIZATION FOR MILL & TEXT	1.00	LS		\$	
0050	02677		ASPHALT PAVE MILLING & TEXTURING	400.00	TON		\$	
0060	06514		PAVE STRIPING-PERM PAINT-4 IN	3,000.00	LF		\$	
0070	06530		PAVE STRIPING REMOVAL-4 IN	900.00	LF		\$	
0080	06600		REMOVE PAVEMENT MARKER TYPE V	38.00	EACH		\$	
0090	20362ES403		SHOULDER RUMBLE STRIPS-SAWED	1,060.00	LF		\$	
0100	22906ES403		CL3 ASPH SURF 0.38A PG64-22	400.00	TON		\$	
0110	24489EC		INLAID PAVEMENT MARKER	42.00	EACH		\$	

#### Section: 0002 - ROADWAY

LINE	BID CODE	ALT	DESCRIPTION	QUANTITY	UNIT	UNIT PRIC	FP	AMOUNT
0120	01904		REMOVE CURB	390.00	LF		\$	
0130	02265		REMOVE FENCE	350.00	LF		\$	
0140	02545		CLEARING AND GRUBBING	1.00	LS		\$	
0150	02562		TEMPORARY SIGNS	190.00	SQFT		\$	
0160	02650		MAINTAIN & CONTROL TRAFFIC	1.00	LS		\$	
0170	02671		PORTABLE CHANGEABLE MESSAGE SIGN	2.00	EACH		\$	
0180	02726		STAKING	1.00	LS		\$	
0190	02775		ARROW PANEL	2.00	EACH		\$	
0200	20257NC		SITE PREPARATION	1.00	LS		\$	

#### Section: 0003 - DRAINAGE

LINE	BID CODE	ALT	DESCRIPTION	QUANTITY	UNIT	UNIT PRIC	FP	AMOUNT
0210	00078		CRUSHED AGGREGATE SIZE NO 2	23,950.00	TON		\$	
0220	00083		CRUSHED AGGREGATE SIZE NO 8	100.00	TON		\$	
0230	00464		CULVERT PIPE-24 IN	68.00	LF		\$	
0240	01001		PERFORATED PIPE-6 IN	380.00	LF		\$	
0250	02157		PAVED DITCH TYPE 1	10.00	SQYD		\$	
0260	02599		FABRIC-GEOTEXTILE TYPE IV	3,200.00	SQYD		\$	
0270	21554EN		EXCAVATION	9,225.00	CUYD		\$	

#### Section: 0004 - GUARDRAIL

LINE	BID CODE	ALT	DESCRIPTION	QUANTITY	UNIT	UNIT PRIC	FP	AMOUNT
0280	01987		DELINEATOR FOR GUARDRAIL BI DIRECTIONAL WHITE	10.00	EACH		\$	
0290	02353		INSTALL GUARDRAIL-STEEL W BM-S FACE	537.50	LF		\$	
0300	02381		REMOVE GUARDRAIL	537.50	LF		\$	
0310	02395		REMOVE GUARDRAIL TERMINAL SECT	2.00	EACH		\$	

152269

### PROPOSAL BID ITEMS

Page 2 of 2

Report Date 7/6/15

#### Section: 0005 - DEMOBILIZATION

LINE	BID CODE	ALT	DESCRIPTION	QUANTITY	UNIT	UNIT PRIC	FP	AMOUNT
0320	02569		DEMOBILIZATION	1.00	LS		\$	