



**CALL NO. 204**

**CONTRACT ID. 244702**

**JEFFERSON - OLDHAM COUNTIES**

**FED/STATE PROJECT NUMBER 121GR24T005-HSIP**

**DESCRIPTION VARIOUS ROUTES IN DISTRICT 5**

**WORK TYPE HIGH FRICTION SURFACE**

**PRIMARY COMPLETION DATE 10/31/2024**

**LETTING DATE: April 25,2024**

Sealed Bids will be received electronically through the Bid Express bidding service until 10:00 AM EASTERN DAYLIGHT TIME April 25,2024. Bids will be publicly announced at 10:00 AM EASTERN DAYLIGHT TIME.

**NO PLANS ASSOCIATED WITH THIS PROJECT.**

**DBE CERTIFICATION REQUIRED - 0%**

**REQUIRED BID PROPOSAL GUARANTY: Not less than 5% of the total bid.**

## TABLE OF CONTENTS

PART I	SCOPE OF WORK
	<ul style="list-style-type: none"><li>• PROJECT(S), COMPLETION DATE(S), &amp; LIQUIDATED DAMAGES</li><li>• CONTRACT NOTES</li><li>• FEDERAL CONTRACT NOTES</li><li>• NATIONAL HIGHWAY</li><li>• SPECIAL NOTE(S) APPLICABLE TO PROJECT</li><li>• LIQUIDATED DAMAGES</li><li>• COORDINATION OF WORK WITH OTHER CONTRACTS</li><li>• TRAFFIC CONTROL PLAN</li><li>• RIGHT OF WAY CERTIFICATION</li><li>• UTILITY IMPACT &amp; RAIL CERTIFICATION NOTES</li><li>• MATERIAL SUMMARY</li><li>• DETAIL SHEET(S)</li></ul>
PART II	SPECIFICATIONS AND STANDARD DRAWINGS
	<ul style="list-style-type: none"><li>• STANDARD AND SUPPLEMENTAL SPECIFICATIONS</li><li>• 2020 STANDARD DRAWINGS THAT APPLY</li></ul>
PART III	EMPLOYMENT, WAGE AND RECORD REQUIREMENTS
	<ul style="list-style-type: none"><li>• FEDERAL-AID CONSTRUCTION CONTRACTS - FHWA 1273</li><li>• NONDISCRIMINATION OF EMPLOYEES</li><li>• EXECUTIVE BRANCH CODE OF ETHICS</li><li>• PROJECT WAGE RATES LOCALITY 3 / FEDERAL</li><li>• NOTICE OF REQUIREMENT FOR AFFIRMATIVE ACTION TO ENSURE EEO JEFFERSON</li><li>• NOTICE OF REQUIREMENT FOR AFFIRMATIVE ACTION TO ENSURE EEO OLDHAM</li></ul>
PART IV	INSURANCE
PART V	BID ITEMS

**PART I**  
**SCOPE OF WORK**

## ADMINISTRATIVE DISTRICT - 05

**CONTRACT ID - 244702**

**121GR24T005-HSIP**

**COUNTY - JEFFERSON**

**PCN - 0505600602401**

**HSIP 9010(601)**

EASTERN PARKWAY (US 60A) (MP 4.212) HFST ON EASTERN PARKWAY (US 60A) (MP 4.337), A DISTANCE OF 0.11 MILES.HIGH FRICTION SURFACE SYP NO. 05-09042.00.

GEOGRAPHIC COORDINATES LATITUDE 38:12:44.65 LONGITUDE 85:44:49.76

ADT 16,480

**PCN - 0505600642401**

**HSIP 9010(586)**

INTERSTATE 64 (I-64 RAMPS 321 AND 322) (MP 0.0) HFST ON INTERSTATE 64 (I-64 RAMPS 321 AND 322) (MP 0.114), A DISTANCE OF 0.14 MILES.HIGH FRICTION SURFACE SYP NO. 05-00956.00.

GEOGRAPHIC COORDINATES LATITUDE 38:15:29.72 LONGITUDE 85:45:54.38

ADT 8,853

**PCN - 0505608642401**

**HSIP 9010(595)**

POPLAR LEVEL ROAD (KY 864) (MP 12.020) HFST ON POPLAR LEVEL ROAD (KY 864) (MP 12.066), A DISTANCE OF 0.05 MILES.HIGH FRICTION SURFACE SYP NO. 05-09036.00.

GEOGRAPHIC COORDINATES LATITUDE 38:12:18.85 LONGITUDE 85:42:46.14

ADT 27,104

**PCN - 0505609072401**

**HSIP 9010(596)**

SOUTHSIDE DRIVE (KY 907) (MP 6.74) HFST ON SOUTHSIDE DRIVE (KY 907) (MP 6.955), A DISTANCE OF 0.22 MILES.HIGH FRICTION SURFACE SYP NO. 05-09037.00.

GEOGRAPHIC COORDINATES LATITUDE 38:09:01.61 LONGITUDE 85:46:08.10

ADT 13,515

**PCN - 0505619312401**

**HSIP 9010(589)**

ST. ANDREWS CHURCH ROAD (KY 1931) (MP 4.200) HFST ON ST ANDREWS CHURCH ROAD (KY 1931) (MP 4.330), A DISTANCE OF 0.13 MILES.HIGH FRICTION SURFACE SYP NO. 05-00959.00.

GEOGRAPHIC COORDINATES LATITUDE 38:09:02.30 LONGITUDE 85:49:18.20

ADT 8,399

**PCN - 0505619312402**

**HSIP 9010(590)**

ST. ANDREWS CHURCH ROAD (KY 1931) (MP 4.359) HFST ON ST ANDREWS CHURCH ROAD (KY 1931) (MP 4.461), A DISTANCE OF 0.11 MILES.HIGH FRICTION SURFACE SYP NO. 05-00960.00.

GEOGRAPHIC COORDINATES LATITUDE 38:09:06.49 LONGITUDE 85:49:10.00

ADT 8,399

**PCN - 0505619312403**

**HSIP 9010(591)**

MANSLICK ROAD (KY 1931) (MP 5.742) HFST ON MANSLICK ROAD (KY 1931) (MP 5.887), A DISTANCE OF 0.15 MILES.HIGH FRICTION SURFACE SYP NO. 05-00961.00.

GEOGRAPHIC COORDINATES LATITUDE 38:09:32.60 LONGITUDE 85:47:53.80

ADT 16,934

**COUNTY - OLDHAM**



**PCN - 0509300422401**  
**HSIP 9010(602)**

FEDERAL ROUTE 42 (US 42) (MP 0.660) HFST ON FEDERAL ROUTE 42 (US 42) (MP 0.798), A DISTANCE OF 0.14 MILES.HIGH FRICTION SURFACE SYP NO. 05-09043.00.  
GEOGRAPHIC COORDINATES LATITUDE 38:22:05.75 LONGITUDE 85:35:45.43  
ADT 13,332

**COMPLETION DATE(S):**

COMPLETED BY 10/31/2024

APPLIES TO ENTIRE PROJECT

## **CONTRACT NOTES**

### **PROPOSAL ADDENDA**

All addenda to this proposal must be applied when calculating bid and certified in the bid packet submitted to the Kentucky Department of Highways. Failure to use the correct and most recent addenda may result in the bid being rejected.

### **BID SUBMITTAL**

Bidder must use the Department's electronic bidding software. The Bidder must download the bid file located on the Bid Express website ([www.bidx.com](http://www.bidx.com)) to prepare a bid packet for submission to the Department. The bidder must submit electronically using Bid Express.

### **JOINT VENTURE BIDDING**

Joint venture bidding is permissible. All companies in the joint venture must be prequalified in one of the work types in the Qualifications for Bidders for the project. The bidders must get a vendor ID for the joint venture from the Division of Construction Procurement and register the joint venture as a bidder on the project. Also, the joint venture must obtain a digital ID from Bid Express to submit a bid. A joint bid bond of 5% may be submitted for both companies or each company may submit a separate bond of 5%.

### **UNDERGROUND FACILITY DAMAGE PROTECTION**

The contractor shall make every effort to protect underground facilities from damage as prescribed in the Underground Facility Damage Protection Act of 1994, Kentucky Revised Statute KRS 367.4901 to 367.4917. It is the contractor's responsibility to determine and take steps necessary to be in compliance with federal and state damage prevention directives. When prescribed in said directives, the contractor shall submit Excavation Locate Requests to the Kentucky Contact Center (KY811) via web ticket entry. The submission of this request does not relieve the contractor from the responsibility of contacting non-member facility owners, whom shall be contacted through their individual Protection Notification Center. Non-compliance with these directives can result in the enforcement of penalties.

### **REGISTRATION WITH THE SECRETARY OF STATE BY A FOREIGN ENTITY**

Pursuant to KRS 176.085(1)(b), an agency, department, office, or political subdivision of the Commonwealth of Kentucky shall not award a state contract to a person that is a foreign entity required by [KRS 14A.9-010](#) to obtain a certificate of authority to transact business in the Commonwealth ("certificate") from the Secretary of State under [KRS 14A.9-030](#) unless the person produces the certificate within fourteen (14) days of the bid or proposal opening. If the foreign entity is not required to obtain a certificate as provided in [KRS 14A.9-010](#), the foreign entity should identify the applicable exception. Foreign entity is defined within [KRS 14A.1-070](#).

**For all foreign entities required to obtain a certificate of authority to transact business in the Commonwealth, if a copy of the certificate is not received by the contracting agency within the time frame identified above, the foreign entity's solicitation response shall be deemed non-responsive or the awarded contract shall be cancelled.**

Businesses can register with the Secretary of State at <https://secure.kentucky.gov/sos/ftbr/welcome.aspx>.

### **SPECIAL NOTE FOR PROJECT QUESTIONS DURING ADVERTISEMENT**

Questions about projects during the advertisement should be submitted in writing to the Division of Construction Procurement. This may be done by email to [kytc.projectquestions@ky.gov](mailto:kytc.projectquestions@ky.gov). The Department will attempt to answer all submitted questions. The Department reserves the right not to answer if the question is not pertinent or does not aid in clarifying the project intent.

The deadline for posting answers will be 3:00 pm Eastern Daylight Time, the day preceding the Letting. Questions may be submitted until this deadline with the understanding that the later a question is submitted, the less likely an answer will be able to be provided.

The questions and answers will be posted for each Letting under the heading "Questions & Answers" on the Construction Procurement website ([www.transportation.ky.gov/construction-procurement](http://www.transportation.ky.gov/construction-procurement)). The answers provided shall be considered part of this Special Note and, in case of a discrepancy, will govern over all other bidding documents.

### **HARDWOOD REMOVAL RESTRICTIONS**

The US Department of Agriculture has imposed a quarantine in Kentucky and several surrounding states, to prevent the spread of an invasive insect, the emerald ash borer. Hardwood cut in conjunction with the project may not be removed from the state. Chipping or burning on site is the preferred method of disposal.

### **INSTRUCTIONS FOR EXCESS MATERIAL SITES AND BORROW SITES**

Identification of excess material sites and borrow sites shall be the responsibility of the Contractor. The Contractor shall be responsible for compliance with all applicable state and federal laws and may wish to consult with the US Fish and Wildlife Service to seek protection under Section 10 of the Endangered Species Act for these activities.

### **ACCESS TO RECORDS**

The contractor, as defined in KRS 45A.030 (9) agrees that the contracting agency, the Finance and Administration Cabinet, the Auditor of Public Accounts, and the Legislative Research Commission, or their duly authorized representatives, shall have access to any books, documents, papers, records, or other evidence, which are directly pertinent to this contract for the purpose of financial audit or program review. Records and other prequalification information confidentially disclosed as part of the bid process shall not be deemed as directly pertinent to the contract and

shall be exempt from disclosure as provided in KRS 61.878(1)(c). The contractor also recognizes that any books, documents, papers, records, or other evidence, received during a financial audit or program review shall be subject to the Kentucky Open Records Act, KRS 61.870 to 61.884.

In the event of a dispute between the contractor and the contracting agency, Attorney General, or the Auditor of Public Accounts over documents that are eligible for production and review, the Finance and Administration Cabinet shall review the dispute and issue a determination, in accordance with Secretary's Order 11-004.

### **BOYCOTT PROVISIONS**

If applicable, the contractor represents that, pursuant to [KRS 45A.607](#), they are not currently engaged in, and will not for the duration of the contract engage in, the boycott of a person or an entity based in or doing business with a jurisdiction with which Kentucky can enjoy open trade. **Note:** The term Boycott does not include actions taken for bona fide business or economic reasons, or actions specifically required by federal or state law.

If applicable, the contractor verifies that, pursuant to KRS 41.480, they do not engage in, and will not for the duration of the contract engage in, in energy company boycotts as defined by KRS 41.472.

### **LOBBYING PROHIBITIONS**

The contractor represents that they, and any subcontractor performing work under the contract, have not violated the agency restrictions contained in [KRS 11A.236](#) during the previous ten (10) years, and pledges to abide by the restrictions set forth in such statute for the duration of the contract awarded.

The contractor further represents that, pursuant to [KRS 45A.328](#), they have not procured an original, subsequent, or similar contract while employing an executive agency lobbyist who was convicted of a crime related to the original, subsequent, or similar contract within five (5) years of the conviction of the lobbyist.

Revised: 2/29/2024

## 1.0 BUY AMERICA REQUIREMENT.

Follow the “Buy America” provisions as required by 23 U.S.C. § 313 and 23 C.F.R. § 635.410. Except as expressly provided herein all manufacturing processes of steel or iron materials including but not limited to structural steel, guardrail materials, corrugated steel, culvert pipe, structural plate, prestressing strands, and steel reinforcing bars shall occur in the United States of America, including the application of:

- Coating,
- Galvanizing,
- Painting, and
- Other coating that protects or enhances the value of steel or iron products.

The following are exempt, unless processed or refined to include substantial amounts of steel or iron material, and may be used regardless of source in the domestic manufacturing process for steel or iron material:

- Pig iron,
- Processed, pelletized, and reduced iron ore material, or
- Processed alloys.

The Contractor shall submit a certification stating that all manufacturing processes involved with the production of steel or iron materials occurred in the United States.

Produce, mill, fabricate, and manufacture in the United States of America all aluminum components of bridges, tunnels, and large sign support systems, for which either shop fabrication, shop inspection, or certified mill test reports are required as the basis of acceptance by the Department.

Use foreign materials only under the following conditions:

- 1) When the materials are not permanently incorporated into the project; or
- 2) When the delivered cost of such materials used does not exceed 0.1 percent of the total Contract amount or \$2,500.00, whichever is greater.

The Contractor shall submit to the Engineer the origin and value of any foreign material used.

## 2.0 – BUILD AMERICA, BUY AMERICA (BABA)

Contractor shall comply with the Federal Highway Administration (FHWA) Buy America Requirement in 23 C.F.R. § 635.410 and all relevant provisions of the Build America, Buy America Act (BABA), contained within the Infrastructure Investment and Jobs Act, Pub. L. No. 117-58, §§ 70901-52 enacted November 15, 2021. The BABA requires iron, steel, manufactured products, and construction materials used in infrastructure projects funded by federal financial assistance to be produced in the United States. Comply with 2 C.F.R § 184.

BABA permits FHWA participation in the Contract only if domestic steel and iron will be used on the Project. To be considered domestic, all steel and iron used, and all products manufactured from steel and iron must be produced in the United States and all manufacturing processes, including application of a coating, for these materials must occur in the United States. Coating includes all processes that protect or enhance the value of the material to which the coating is applied. This requirement does not preclude a minimal use of foreign steel and iron materials, provided the cost of such materials does not exceed 0.1% of the total contract amount under the Contract or \$2,500.00 whichever is greater.

BABA permits FHWA participation in the Contract only if all “construction materials” as defined in the Act are made in the United States. The Buy America preference applies to the following construction materials

SPECIAL NOTE – BUY AMERICA REQUIREMENTS AND BUILD  
AMERICA, BUY AMERICA (BABA) ACT

10/26/2023

incorporated into infrastructure projects: non-ferrous metals; plastic and polymer-based products (including polyvinylchloride, composite building materials, and polymers used in fiber optic cables); glass (including optic glass); Fiber optic cable; optical fiber; lumber; engineered wood; and drywall. Contractor will be required to use construction materials produced in the United States on this Project. The Contractor shall submit a certification stating that all construction materials are certified to be BABA compliant.

Finally, BABA permits the continuation of FHWA's current general applicability waivers for manufactured products, raw materials, and ferryboat parts, but these waivers are subject to reevaluation, specifically the general applicability waiver for manufactured products.

The Contractor has completed and submitted, or shall complete and submit, to the Cabinet a Buy America/Build America, Buy America Certificate prior to the Cabinet issuing the notice to proceed, in the format below. After submittal, the Contractor is bound by its original certification.

A false certification is a criminal act in violation of 18 U.S.C. § 1001. The Contractor has the burden of proof to establish that it is in compliance.

At the Contractor's request, the Cabinet may, but is not obligated to, seek a waiver of Buy America requirements if grounds for the waiver exist under 23 C.F.R. § 635.410(c) or will comply with the applicable Buy America requirements if a waiver of those requirements is not available or not pursued by the Cabinet.

Please refer to the Federal Highway Administration's Buy America webpage for more information.

[Buy America - Construction Program Guide - Contract Administration - Construction - Federal Highway Administration \(dot.gov\)](#)

October 26, 2023 Letting

SPECIAL NOTE – BUY AMERICA REQUIREMENTS AND BUILD AMERICA, BUY AMERICA (BABA) ACT

10/26/2023

**BUY AMERICA / BUILD AMERICA, BUY AMERICA (ACT) MATERIALS CERTIFICATE OF COMPLIANCE**

The Contractor hereby certifies that it will comply with all relevant provisions of the Build America, Buy America Act, contained within the Infrastructure Investment and Jobs Act, Pub. L. NO. 117-58, §§ 70901-52, the requirements of 23 U.S.C. § 313, 23 C.F.R. § 635.410 and 2 C.F.R § 184.

Date Submitted: \_\_\_\_\_

Contractor: \_\_\_\_\_

Signature: \_\_\_\_\_

Printed Name: \_\_\_\_\_

Title: \_\_\_\_\_

**NOTE: THIS CERTIFICATION IS IN ADDITION TO ANY AND ALL REQUIREMENTS OUTLINED IN THE CURRENT EDITION OF THE STANDARD SPECIFICATIONS FOR ROAD AND BRIDGE CONSTRUCTION AND/OR SPECIAL NOTES CONTAINED IN THE PROJECT PROPOSAL.**

### **FEDERAL CONTRACT NOTES**

The Kentucky Department of Highways, in accordance with the Regulations of the United States Department of Transportation 23 CFR 635.112 (h), hereby notifies all bidders that failure by a bidder to comply with all applicable sections of the current Kentucky Standard Specifications, including, but not limited to the following, may result in a bid not being considered responsive and thus not eligible to be considered for award:

- |                                |  |
|--------------------------------|--|
| 102.02 Current Rating          | 102.08 Preparation and Delivery of Proposals |
| 102.13 Irregular Bid Proposals | 102.14 Disqualification of Bidders           |
| 102.09 Proposal Guaranty       |  |

### **CIVIL RIGHTS ACT OF 1964**

The Kentucky Transportation Cabinet, Department of Highways, in accordance with the provisions of Title VI of the Civil Rights Act of 1964 (78 Stat. 252, 42 U.S.C. §§ 2000d to 2000d-4) and the Regulations, hereby notifies all bidders that it will affirmatively ensure that any contract entered into pursuant to this advertisement, disadvantaged business enterprises will be afforded full and fair opportunity to submit bids in response to this invitation and will not be discriminated against on the grounds of race, color, national origin, sex, age (over 40), religion, sexual orientation, gender identity, veteran status, disability, income- level, or Limited English Proficiency (LEP) in consideration for an award.

### **NOTICE TO ALL BIDDERS**

To report bid rigging activities call: 1-800-424-9071.

The U.S. Department of Transportation (DOT) operates the above toll-free “hotline” Monday through Friday, 8:00 a.m. to 5:00 p.m. eastern time. Anyone with knowledge of possible bid rigging, bidder collusion, or other fraudulent activities should use the “hotline” to report such activities.

The “hotline” is part of the DOT’s continuing effort to identify and investigate highway construction contract fraud and abuse and is operated under the direction of the DOT Inspector General. All information will be treated confidentially and caller anonymity will be respected.

### **SECOND TIER SUBCONTRACTS**

Second tier subcontracts are acceptable per Section 108.01 of the Standard Specifications for Road and Bridge Construction. Sub-Contractors fulfilling a disadvantaged business enterprise goal on a project may enter into a 2<sup>nd</sup> tier subcontract with a Non-DBE Subcontractor. However, in this instance, none of the work subcontracted to the Non-DBE Contractor will count toward fulfilling the established Disadvantaged Goal for the project.



### **DISADVANTAGED BUSINESS ENTERPRISE PROGRAM**

It is the policy of the Kentucky Transportation Cabinet (“the Cabinet”) that Disadvantaged Business Enterprises (“DBE”) shall have the opportunity to participate in the performance of highway construction projects financed in whole or in part by Federal Funds in order to create a level playing field for all businesses who wish to contract with the Cabinet. To that end, the Cabinet will comply with the regulations found in 49 CFR Part 26, and the definitions and requirements contained therein shall be adopted as if set out verbatim herein.

The Cabinet, contractors, subcontractors, and sub-recipients shall not discriminate on the basis of race, color, national origin, or sex in the performance of work performed pursuant to Cabinet contracts. The contractor shall carry out applicable requirements of 49 CFR 26 in the award and administration of federally assisted highway construction projects. The contractor will include this provision in all its subcontracts and supply agreements pertaining to contracts with the Cabinet.

Failure by the contractor to carry out these requirements is a material breach of its contract with the Cabinet, which may result in the termination of the contract or such other remedy as the Cabinet deems necessary.

### **DBE GOAL**

The Disadvantaged Business Enterprise (DBE) goal established for this contract, as listed on the front page of the proposal, is the percentage of the total value of the contract.

The contractor shall exercise all necessary and reasonable steps to ensure that Disadvantaged Business Enterprises participate in a least the percent of the contract as set forth above as goals for this contract.

### **OBLIGATION OF CONTRACTORS**

Each contractor prequalified to perform work on Cabinet projects shall designate and make known to the Cabinet a liaison officer who is assigned the responsibility of effectively administering and promoting an active program for utilization of DBEs.

If a formal goal has not been designated for the contract, all contractors are encouraged to consider DBEs for subcontract work as well as for the supply of material and services needed to perform this work.

Contractors are encouraged to use the services of banks owned and controlled by minorities and women.

### **CERTIFICATION OF CONTRACT GOAL**

Contractors shall include the following certification in bids for projects for which a DBE goal has been established. BIDS SUBMITTED WHICH DO NOT INCLUDE CERTIFICATION OF DBE PARTICIPATION WILL NOT BE ACCEPTED. These bids will not be considered for award by the Cabinet and they will be returned to the bidder.

“The bidder certifies that it has secured participation by Disadvantaged Business Enterprises (“DBE”) in the amount of \_\_\_\_\_ percent of the total value of this contract and that the DBE participation is in compliance with the requirements of 49 CFR 26 and the policies of the Kentucky Transportation Cabinet pertaining to the DBE Program.”

**The certification statement is located in the electronic bid file. All contractors must certify their DBE participation on that page. DBEs utilized in achieving the DBE goal must be certified and prequalified for the work items at the time the bid is submitted.**

### **DBE PARTICIPATION PLAN**

Lowest responsive bidders must submit the *DBE Plan/ Subcontractor Request*, form TC 14-35 DBE, within **5** days of the letting. This is necessary before the Awards Committee will review and make a recommendation. **The project will not be considered for award prior to submission and approval of the apparent low bidder’s DBE Plan/Subcontractor Request.**

The DBE Participation Plan shall include the following:

1. Name and address of DBE Subcontractor(s) and/or supplier(s) intended to be used in the proposed project;
2. Description of the work each is to perform including the work item, unit, quantity, unit price and total amount of the work to be performed by the individual DBE. The Proposal Line Number, Category Number, and the Project Line Number can be found in the “material listing” on the Construction Procurement website under the specific letting;
3. The dollar value of each proposed DBE subcontract and the percentage of total project contract value this represents. DBE participation may be counted as follows:
  - a) If DBE suppliers and manufactures assume actual and contractual responsibility, the dollar value of materials to be furnished will be counted toward the goal as follows:
    - The entire expenditure paid to a DBE manufacturer;
    - 60 percent of expenditures to DBE suppliers that are not manufacturers provided the supplier is a regular dealer in the product involved. A regular dealer must be engaged in, as its principal business and in its own name, the sale of products to the public, maintain an inventory and own and operate distribution equipment; and
    - The amount of fees or commissions charged by the DBE firms for a bona fide service, such as professional, technical, consultant, or managerial services and assistance in the procurement of essential personnel, facilities, equipment, materials, supplies, delivery of materials and supplies or for furnishing bonds, or insurance, providing such fees or commissions are determined to be reasonable and customary.
  - b) The dollar value of services provided by DBEs such as quality control testing, equipment repair and maintenance, engineering, staking, etc.;

- c) The dollar value of joint ventures. DBE credit for joint ventures will be limited to the dollar amount of the work actually performed by the DBE in the joint venture;
4. Written and signed documentation of the bidder's commitment to use a DBE contractor whose participation is being utilized to meet the DBE goal; and
5. Written and signed confirmation from the DBE that it is participating in the contract as provided in the prime contractor's commitment.

**AFTER PROJECT AWARD AND BEFORE NOTICE TO PROCEED/WORK ORDER IS ISSUED (SEE SECTION 103.06, STANDARD SPECIFICATIONS FOR ROAD AND BRIDGE CONSTRUCTION**

Prime Contractors awarded a federally funded project with a DBE Goal greater than zero will be required to submit DBE Subcontract Agreement Form, TC 14-36, along with the attached FHWA 1273 and Certificate of Liability Insurance for each DBE Firm submitted as part of the previously approved DBE Utilization Plan (TC 14-35). A signed quote or purchase order shall be attached when the DBE subcontractor is a material supplier or broker.

The Certificate of Liability Insurance submitted must meet the requirements outlined in Section 107.18 of the Standard Specifications for Road and Bridge Construction.

Changes to **APPROVED** DBE Participation Plans must be approved by the Cabinet. The Cabinet may consider extenuating circumstances including, but not limited to, changes in the nature or scope of the project, the inability or unwillingness of a DBE to perform the work in accordance with the bid, and/or other circumstances beyond the control of the prime contractor.

**CONSIDERATION OF GOOD FAITH EFFORTS REQUESTS**

If the DBE participation submitted in the bid by the apparent lowest responsive bidder does not meet or exceed the DBE contract goal, the apparent lowest responsive bidder must submit a Good Faith Effort Package to satisfy the Cabinet that sufficient good faith efforts were made to meet the contract goals prior to submission of the bid. Efforts to increase the goal after bid submission will not be considered in justifying the good faith effort, unless the contractor can show that the proposed DBE was solicited prior to the letting date. DBEs utilized in achieving the DBE goal must be certified and prequalified for the work items at the time the bid is submitted. One complete set (hard copy along with an electronic copy) of this information must be received in the Division of Contract Procurement no later than 12:00 noon of the tenth calendar day after receipt of notification that they are the apparent low bidder.

Where the information submitted includes repetitious solicitation letters it will be acceptable to submit a sample representative letter along with a distribution list of the firms solicited. Documentation of DBE quotations shall be a part of the good faith effort submittal as necessary to demonstrate compliance with the factors listed below which the Cabinet considers in judging good faith efforts. This documentation may include written subcontractors' quotations, telephone log notations of verbal quotations, or other types of quotation documentation.

The Good Faith Effort Package shall include, but may not be limited to information showing evidence of the following:

1. Whether the bidder attended any pre-bid meetings that were scheduled by the Cabinet to inform DBEs of subcontracting opportunities;
2. Whether the bidder provided solicitations through all reasonable and available means;
3. Whether the bidder provided written notice to all DBEs listed in the DBE directory at the time of the letting who are prequalified in the areas of work that the bidder will be subcontracting;
4. Whether the bidder followed up initial solicitations of interest by contacting DBEs to determine with certainty whether they were interested. If a reasonable amount of DBEs within the targeted districts do not provide an intent to quote or no DBEs are prequalified in the subcontracted areas, the bidder must notify the Disadvantaged Enterprise Business Liaison Officer (DEBLO) in the Office for Civil Rights and Small Business Development to give notification of the bidder's inability to get DBE quotes;
5. Whether the bidder selected portions of the work to be performed by DBEs in order to increase the likelihood of meeting the contract goals. This includes, where appropriate, breaking out contract work items into economically feasible units to facilitate DBE participation, even when the prime contractor might otherwise perform these work items with its own forces;
6. Whether the bidder provided interested DBEs with adequate and timely information about the plans, specifications, and requirements of the contract;
7. Whether the bidder negotiated in good faith with interested DBEs not rejecting them as unqualified without sound reasons based on a thorough investigation of their capabilities. Any rejection should be so noted in writing with a description as to why an agreement could not be reached;
8. Whether quotations were received from interested DBE firms but were rejected as unacceptable without sound reasons why the quotations were considered unacceptable. The fact that the DBE firm's quotation for the work is not the lowest quotation received will not in itself be considered as a sound reason for rejecting the quotation as unacceptable. The fact that the bidder has the ability and/or desire to perform the contract work with its own forces will not be considered a sound reason for rejecting a DBE quote. Nothing in this provision shall be construed to require the bidder to accept unreasonable quotes in order to satisfy DBE goals;
9. Whether the bidder specifically negotiated with subcontractors to assume part of the responsibility to meet the contract DBE goal when the work to be subcontracted includes potential DBE participation;
10. Whether the bidder made any efforts and/or offered assistance to interested DBEs in obtaining the necessary equipment, supplies, materials, insurance and/or bonding to satisfy the work requirements of the bid proposal; and
11. Any other evidence that the bidder submits which may show that the bidder has made reasonable good faith efforts to include DBE participation.

### **FAILURE TO MEET GOOD FAITH REQUIREMENT**

Where the apparent lowest responsive bidder fails to submit sufficient participation by DBE firms to meet the contract goal and upon a determination by the Good Faith Committee based upon the information submitted that the apparent lowest responsive bidder failed to make sufficient reasonable efforts to meet the contract goal, the bidder will be offered the opportunity to meet in person for administrative reconsideration. The bidder will be notified of the Committee's decision within 24 hours of its decision. The bidder will have 24 hours to request reconsideration of the Committee's decision. The reconsideration meeting will be held within two days of the receipt of a request by the bidder for reconsideration.

The request for reconsideration will be heard by the Office of the Secretary. The bidder will have the opportunity to present written documentation or argument concerning the issue of whether it met the goal or made an adequate good faith effort. The bidder will receive a written decision on the reconsideration explaining the basis for the finding that the bidder did or did not meet the goal or made adequate Good Faith efforts to do so.

The result of the reconsideration process is not administratively appealable to the Cabinet or to the United States Department of Transportation.

The Cabinet reserves the right to award the contract to the next lowest responsive bidder or to rebid the contract in the event that the contract is not awarded to the low bidder as the result of a failure to meet the good faith requirement.

### **SANCTIONS FOR FAILURE TO MEET DBE REQUIREMENTS OF THE PROJECT**

Failure by the prime contractor to fulfill the DBE requirements of a project under contract or to demonstrate good faith efforts to meet the goal constitutes a breach of contract. When this occurs, the Cabinet will hold the prime contractor accountable, as would be the case with all other contract provisions. Therefore, the contractor's failure to carry out the DBE contract requirements shall constitute a breach of contract and as such the Cabinet reserves the right to exercise all administrative remedies at its disposal including, but not limited to the following:

- Suspension of Prequalification;
- Disallow credit toward the DBE goal;
- Withholding progress payments;
- Withholding payment to the prime in an amount equal to the unmet portion of the contract goal; and/or
- Termination of the contract.

### **PROMPT PAYMENT**

The prime contractor will be required to pay the DBE and Non-DBE Subcontractors within seven (7) working days after he or she has received payment from the Kentucky Transportation Cabinet for work performed or materials furnished.

### **CONTRACTOR REPORTING**

All contractors must keep detailed records and provide reports to the Cabinet on their progress in meeting the DBE requirement on any highway contract. These records may include, but shall not be limited to payroll, lease agreements, cancelled payroll checks, executed subcontracting agreements, etc. Prime contractors will be required to complete and submit a **signed and notarized** Affidavit of Subcontractor Payment (TC 18-7) and copies of checks for any monies paid to each DBE subcontractor or supplier utilized to meet a DBE goal. These documents must be completed and signed within 7 days of being paid by the Cabinet.

Payment information that needs to be reported includes date the payment is sent to the DBE, check number, Contract ID, amount of payment and the check date. Before Final Payment is made on this contract, the Prime Contractor will certify that all payments were made to the DBE subcontractor and/or DBE suppliers.

\*\*\*\*\* IMPORTANT \*\*\*\*\*

**Please mail the original, signed and completed TC (18-7) Affidavit of Subcontractor Payment form and all copies of checks for payments listed above to the following address:**

Office for Civil Rights and Small Business Development  
6<sup>th</sup> Floor West 200 Mero Street  
Frankfort, KY 40622

The prime contractor should notify the KYTC Office for Civil Rights and Small Business Development seven (7) days prior to DBE contractors commencing work on the project. The contact in this office is Mr. Tony Youssefi. Mr. Youssefi's current contact information is email address – [tyousseffi@ky.gov](mailto:tyousseffi@ky.gov) and the telephone number is (502) 564-3601.

### **DEFAULT OR DECERTIFICATION OF THE DBE**

If the DBE subcontractor or supplier is decertified or defaults in the performance of its work, and the overall goal cannot be credited for the uncompleted work, the prime contractor may utilize a substitute DBE or elect to fulfill the DBE goal with another DBE on a different work item. If after exerting good faith effort in accordance with the Cabinet's Good Faith Effort policies and procedures, the prime contractor is unable to replace the DBE, then the unmet portion of the goal may be waived at the discretion of the Cabinet.

### **PROHIBITION ON TELECOMMUNICATIONS EQUIPMENT OR SERVICES**

In accordance with the FY 2019 National Defense Authorization Act (NDAA), 2 CFR 200.216, and 2 CFR 200.471, Federal agencies are prohibited, after August 13, 2020, from obligating or expending financial assistance to obtain certain telecommunications and video surveillance services and equipment from specific producers. As a result of these regulations, contractors and subcontractors are prohibited, on projects with federal funding participation, from providing telecommunication or video surveillance equipment, services, or systems produced by:

- Huawei Technologies Company or ZTE Corporation (or any subsidiary or affiliate of such entities)
- Hytera Communications Corporation, Hangzhou Hikvision Digital Technology Company, or Dahua Technology Company (or any subsidiary or affiliate of such entities)

**LEGAL REQUIREMENTS AND RESPONSIBILITY TO THE PUBLIC – CARGO PREFERENCE ACT (CPA).**

**(REV 12-17-15) (1-16)**

SECTION 7 is expanded by the following new Article:

102.10 **Cargo Preference Act – Use of United States-flag vessels.**

Pursuant to Title 46CFR Part 381, the Contractor agrees

- To utilize privately owned United States-flag commercial vessels to ship at least 50 percent of the gross tonnage (computed separately for dry bulk carriers, dry cargo liners, and tankers) involved, whenever shipping any equipment, material, or commodities pursuant to this contract, to the extent such vessels are available at fair and reasonable rates for United States-flag commercial vessels.
- To furnish within 20 days following the date of loading for shipments originating within the United States or within 30 working days following the date of loading for shipments originating outside the United States, a legible copy of a rated, ‘on-board’ commercial ocean bill-of-lading in English for each shipment of cargo described in paragraph 1 of this section to both the Contracting Officer (through the prime contractor in the case of subcontractor bills-of-lading) and to the Division of National Cargo, Office of Market Development, Maritime Administration, Washington, DC 20590.
- To insert the substance of the provisions of this clause in all subcontracts issued pursuant to this contract.

**NATIONAL HIGHWAY**

Be advised this project is on the NATIONAL HIGHWAY SYSTEM.



## Special Notes Applicable to Project – General Notes & Description of Work

---

Except as specified herein, perform all work in accordance with the Department's Standard Specifications, Supplemental Specifications, applicable Special Notes and Special Provisions, and applicable Standard and Sepia Drawings, current editions. Section references are to the Standard Specifications.

### **CAUTION – PROPOSAL INFORMATION IS APPROXIMATE – PERFORM AN ON-SITE INSPECTION**

Potential bidders are cautioned that the information within this proposal is approximate only and is not to be taken as an exact evaluation of the bid quantities, nor the materials and conditions that may be encountered during construction. As such, before submitting a bid, potential bidders shall make a thorough inspection of the site to examine the conditions to be encountered per Section 104.07. Furthermore, during the execution of the work, the Engineer reserves the right to make changes to the bid item quantities and/or alterations in the work when necessary to complete the project satisfactorily per Section 104.02.

**NOTE:** The Department will pay for bid item quantity overruns, but only if pre-approved by the Engineer.

### **STATIONING**

The contractor is advised that the planned locations of work were established from a beginning station number, which are:

- **5-956.00:** STA 0+00 at the beginning of each ramp onto I-64 and corresponds to mile point 0 along each ramp (Ramps 321 and 322).
- **5-959.00:** STA 0+00 at the Arnoldtown Rd intersection and corresponds to Milepoint 4.114 along KY 1931.
- **5-960.00:** STA 0+00 at the intersection of St Anthony Church Road and corresponds to Milepoint 4.265 along KY 1931.
- **5-961.00:** STA 0+00 at the intersection of Terudon Drive and corresponds to Milepoint 5.689 along KY 1931.
- **5-9036.00:** STA 637+35 at the intersection of Poplar Level Road (KY 864) and Trevilian Way/Belmar Drive, and corresponds to Milepoint 12.071 along Poplar Level Road (KY 864).
- **5-9037.00:** STA 354+34 at the intersection of Southside Drive (KY 907) and Woodmore Avenue, and corresponds to Milepoint 6.711 along Southside Drive (KY 907).
- **5-9042.00:** STA 34+85, and corresponds to Milepoint 0.660 along US 42
- **5-9043.00:** STA 222+39 and corresponds to Milepoint 4.212 along US 60A (Eastern Parkway)

**NOTE:** The existing mile marker signs may not correspond to the proposed work locations.

### **ON-SITE INSPECTION**

Before submitting a bid for the work, make a thorough inspection of the site and determine existing conditions so that the work can be expeditiously performed after a contract is awarded. The Department will consider submission of a bid to be evidence of this inspection having been made. The Department will not honor any claims for money or time extension resulting from site conditions.

### **RIGHT OF WAY LIMITS**

The Department has not established the exact limits of the Right-of-Way. Unless a consent and release form is obtained from the adjoining property owner, limit work activities to the obvious Right-of-Way and staging areas secured and environmentally cleared by the Contractor at no additional cost to the Department. In the event that private improvements (i.e. fences, buildings, etc.) encroach upon the Right-of-Way, the contractor shall notify the Engineer and limit work activities in order to NOT disturb the improvements. If they become necessary, the Department will secure consent and releases from property owners through the Engineer. Be responsible for all encroachments onto private lands.

## General Notes & Description of Work

Page 2 of 2

### **CONTROL**

Perform all work under the absolute control of the Department of Highways. Obtain the Engineer's approval of all designs required to be furnished by the Contractor prior to incorporation into the work. The Department reserves the right to have other work performed by other contractors and its own forces and to permit public utility companies and others to do work during the construction within the limits of, or adjacent to, the project. Conduct operations and cooperate with such other parties so that interference with such other work will be reduced to a minimum. The Department will not honor any claims for money or time extension created by the operations of such other parties. Should a difference of opinion arise as to the rights of the Contractor and others working within the limits of, or adjacent to, the project, the Engineer will decide as to the respective rights of the various parties involved in order to assure the completion of the Department's work in general harmony and in a satisfactory manner, and his/her decision shall be final and binding upon the Contractor.

### **DESCRIPTION OF WORK**

Except as specified herein, perform all work in accordance with the Department's Standard Specifications, Supplemental Specifications, applicable Special Notes and Special Provisions, and applicable Standard and Sepia Drawings, current editions. Furnish all materials, labor, equipment, and incidentals for the following work:

**High Friction Surface Treatment.** A High Friction Surface Treatment (HFST) is to be installed. Locations are noted on the HFST Detail Sheet and the HFST Summary. Refer to the Special Note for Polymer Concrete Overlay Systems and the Special Note for Striping on High Friction Surface for more information on this item of work.

**SPECIAL NOTE FOR POLYMER CONCRETE OVERLAY SYSTEMS**

**I. DESCRIPTION**

This work shall be performed in accordance with the current edition of the Department’s Standard Specifications, and applicable Standard or Sepia Drawings, except as hereafter specified. Article references are to the Standard Specifications.

The Contractor shall furnish all materials, labor, and equipment for the following work:

- (1) Maintaining and Controlling Traffic; (2) Cleaning and preparing the existing surface; (3) Installing a high friction surface treatment in accordance with the contract documents; and (4) All other work as specified as part of this contract.

**II. MATERIALS**

Provide for sampling and testing of all materials in accordance with the Department's Materials Field Sampling and Testing Manual. Make materials available, within the State of Kentucky, for sampling a sufficient time in advance of the use of the materials. Allow a minimum of 15 working days for testing. The Contractor shall use materials listed on the Department’s List of Approved Materials for Polymer Concrete Overlay Systems (High Friction Surface and Bridge Deck Overlays).

**A. Maintain and Control Traffic.** See Traffic Control Plan.

**B. High Friction Surface Treatment.** The high friction surface treatment shall consist of a polymer resin binder and aggregate system chosen from the Department’s List of Approved Materials. The Department will obtain samples of each binder component and aggregate at a frequency of one sample per lot per contract. The Department will obtain one, one-quart (32 ounce) sample of each binder component for testing. The Department will obtain one 60 to 70 pound composite sample of aggregate for testing. Reclaimed aggregate shall not be allowed for use.

- a) **Binder.** The polymer resin binder shall hold the aggregate firmly in position and meet the following requirements:

<b>TWO-PART MODIFIED BINDER REQUIREMENTS</b>		
<b>Property</b>	<b>Specification Limits</b>	<b>Test Method</b>
Ultimate Tensile Strength	17.0 – 25.0 MPa (19.65 MPa)	ASTM D638
Compressive Strength	5mm min.; > 13 MPa	ASTM D695
Gel Time	50 ml; 10 minutes min. (16 minutes)	ASTM D2471
Elongation at break	30% minimum (54.0%)	ASTM D638
Peak Exothermic Temperature	150°F min.	ASTM D2471
Water Absorption	Less than 0.25%	ASTM D570
Shore Hardness	70 min.	ASTM D2240, Shore D
Cure Rate	3 hours max	ASTM D1640 @ 75°F
Mixing Ratio	Per Manufacturer’s Recommendation	n/a

- b) **Aggregate.** Ensure that the aggregate is clean, dry and free from foreign matter and meets the following requirements:

AGGREGATE REQUIREMENTS		
Property	Specification Limits	Test Method
SFC – Side Force Coefficient	0.70 min.	ASTM E670
SN – Skid Number	75 min SN40R	ASTM E274
PSV – Polished Stone Value	75.0 mm max. (70 mm)	ASTM E660
Texture Depth – Sand Patch Method	1 mm min. (1.2 mm)	ASTM E965
AAV – Aggregate Abrasion Value	20 max	AASHTO T96
Aggregate Gradation	95.0 – 100.0% Passing No. 6 0.0 – 5.0% Passing No. 16	AASHTO T27
Aluminum Oxide (Al <sub>2</sub> O <sub>3</sub> )	87 min	ASTM C114

### III. CONSTRUCTION METHODS

Prior to beginning work, provide the Engineer with a certification from the manufacturer of the binder stating that all material used in the work will meet the requirements of Section II B. a. in this Special Note. Also provide the Engineer with a certification stating that all aggregates used in the work will meet the requirements of Section II B. b. of this Special Note.

**A. Maintain and Control Traffic.** See Traffic Control Plan.

**B. Site Preparation.** Be responsible for all site preparation, including but not limited to the following:

- a) **Preparation and Restoration.** Ensure that a manufacturer’s representative is on site to provide technical assistance during the start up operations and as necessary during the surface preparation, material placement, and during any necessary remedial work.
- b) **Protective Coverings.** Utilities, drainage structures, curbs, bridge joints, and any other structure within or adjacent to the high friction surface treatment location shall be protected from surface preparation activities and application of the surface treatment materials. Cover and protect all existing pavement markings that are adjacent to the surface treatment location. Pavement markings that conflict with the surface application shall be removed prior to performing the required surface preparation.
- c) **Surface Preparation.** Prepare all surfaces in accordance with the following requirements. Ensure surfaces are dry and meet the requirements of the section immediately prior to installation of the high friction surface treatment. Surfaces contaminated with oils, greases, or other deleterious materials not removed by the required surface preparation shall be washed with a mild detergent solution, rinsed with clean potable water, and dried using a hot compressed air lance.
- d) **Asphalt Pavement.** Clean asphalt pavement surfaces using mechanical sweepers and high pressure air wash. Mechanically sweep all surfaces to remove dirt, loose aggregate, debris, and deleterious material. Air wash all surfaces using a minimum of 180 CFM clean and dry compressed air. Maintain

Polymer Concrete Overlay Systems  
Page 3 of 5

the air lance perpendicular to the surface and the tip of air lance within 12 inches of the surface. For applications on new asphalt pavement, ensure the surface has cured a minimum of 30 days prior to performing surface preparation and installation of the high friction surface treatment.

- e) **Concrete Pavement.** Clean concrete pavement surfaces by shot blasting and vacuum sweeping. Shot blast all surfaces to remove all curing compound, loosely bonded mortar, surface carbonation, and deleterious material. The prepared surface shall comply with the International Concrete Repair Institute (ICRI) standard for surface roughness CSP 5. After shot blasting, vacuum sweep all surfaces to remove all dust, debris, and deleterious material.
  - f) **Concrete Bridge Deck.** Clean the entire area of the deck surface and vertical faces of curbs, barrier walls and plinths up to a height of one inch above the top elevation of the overlay, and areas to receive epoxy-sand slurry, by shot blasting and vacuum sweeping. Shot blast all surfaces to remove all curing compound, loosely bonded mortar, surface carbonation, and deleterious material. Areas to receive epoxy-sand slurry shall be cleaned to a bright, clean appearance. The prepared bridge deck surface to receive high friction surface treatment shall comply with the International Concrete Repair Institute (ICRI) standard for surface roughness CSP 5. After shot blasting, vacuum sweep all surfaces to remove all dust, debris, and deleterious material.
  - g) **Pre-Treating.** Pre-treat joints and cracks greater than 1/4 inch in width and depth with properly proportioned and mixed polymer resin binder. Once the binder in the pre-treated areas has gelled, the installation of the high friction surface treatment may proceed.
- C. **Mechanized Application.** Do not apply surface treatment on a wet surface, when the ambient air or surface temperature is below 50°F or above 110°F, or when the anticipated weather conditions or surface temperature would prevent the proper application of the surface treatment as determined by the manufacturer.

Apply the polymer resin binder by a truck or trailer mounted application machine that must be capable of continually mixing and delivering the binder components on demand within the temperature range specified in varying widths of up to 12 feet wide at a uniform application thickness. Ensure that the mechanically applied distributing equipment includes accurate measuring devices and/or calibrated containers and thermometers for measuring the binder temperature prior to placement should heating be required. Operations will proceed in such a manner that will not allow the binder material to separate in the mixing lines, cure, dry, or otherwise impair retention bonding of the high friction surfacing aggregate. The application machine shall be equipped with flushing systems such that blockages of lines will not occur, and installation operations are not delayed, stopped, or otherwise compromised. Ensure that mechanical applications are capable of applying binder uniformly at a minimum rate of 10 gallons per minute. The mixed components are mechanically applied onto a prepared surface with a minimum coverage rate of 3.5 square yards per gallon at a minimum uniform thickness of 50 mils onto the surface. In addition, ensure that the application machine complies with the requirements of the binder manufacturer.

The aggregate shall be applied within 120 seconds of the binder application onto the surface. Uniformly spread aggregate immediately without causing excessive overlap of aggregate outside of coverage area. Ensure that the mechanical aggregate spreader is capable of applying a continuous application of varying widths up to 12 feet wide, in a manner to not violently disturb the wet binder film, at a rate of approximately 13-15 lbs per square yard. Complete coverage of the "wet" binder with aggregate is necessary to achieve a uniform surface. No exposed wet spots of the binder shall be visible once the aggregate is installed. The operations should proceed in such a manner that will not allow the mixed binder material to separate, cure, dry, be exposed, or otherwise harden in such a way as to impair retention and bonding of the high friction surfacing aggregate. Do not use reclaimed aggregate. Do not use vibratory or impact type compaction on the aggregate after placement.

- D. **Hand Application.** At the Engineers discretion, corrective work and application to areas such as intersections or areas less than 300 square yards, or where truck mounted application machines are not

Polymer Concrete Overlay Systems  
Page 4 of 5

applicable to the specified locations because of logistical restrictions, may be performed by hand application of the high friction surface treatment.

Do not apply surface treatment on a wet surface, when the ambient air or surface temperature is below 50°F or above 110°F, or when the anticipated weather conditions or surface temperature would prevent the proper application of the surface treatment as determined by the manufacturer.

The polymer resin binder components Part (A) and Part (B) shall be proportioned to the correct ratio (+/- 2% by volume), mixed using a low speed high torque drill fitted with a helical stirrer.

The mixed components shall be hand applied onto a prepared surface at a minimum coverage rate of 3.5 square yards per gallon at a minimum uniform thickness of 50 mils onto the surface. Hand applied binder will be uniformly spread onto the prepared surface by the use of a continuous V notch serrated edged squeegee.

Immediately after placing the binder, apply the aggregate, in a manner to not violently disturb the wet binder film, at a rate of approximately 13-15 lbs per square yard. Do not use reclaimed aggregate. Do not use vibratory or impact type compaction on the aggregate after placement.

- E. Curing of Installed High Friction Surface Treatment.** Allow the installed high friction surface treatment to cure in accordance with manufacturer recommendations (approximately 3 hours at an ambient air temperature of at least 50 degrees Fahrenheit). Protect treated surfaces from traffic and environmental effects until the area has cured.
- F. Removal of Excess Aggregate.** Remove the excess aggregate from the treatment area and all adjacent surfaces by mechanical sweeping or vacuum sweeping the surfaces a minimum of 3 times before applying additional application and/or opening to traffic. In addition, re-sweep the treatment area and adjacent surfaces using mechanical sweeping or vacuum sweeping 48 hours after opening to traffic to remove all additional loose aggregate and aggregate shed by the action of traffic.
- G. Disposal of Waste.** All debris, excess aggregate, materials containers, and other waste shall be disposed of off the Right-of-Way at approved sites obtained by the Contractor at no cost to the Department. No separate payment will be made for the disposal of waste and debris from the project, but shall be incidental to the other items of the work.
- H. Restoration.** Any roadway features disturbed by the work or the Contractor's operations shall be restored in like kind materials and design as directed by the Engineer at no additional cost to the Department.
- I. Property Damage.** Be responsible for all damage to public and/or private property resulting from the work. Repair or replace damaged roadway features in like kind materials and design as directed by the Engineer at no additional cost to the Department. Repair or replace damaged private property in like kind materials and design to the satisfaction of the owner and the Engineer at no additional cost to the Department.
- J. On-Site Inspection.** Before submitting a bid for the work, make a thorough inspection of the site and determine existing conditions so that the work can be expeditiously performed after a contract is awarded. The Department will consider submission of a bid to be evidence of this inspection having been made. The Department will not honor any claims for money or time extension resulting from site conditions.
- K. Right-of-Way Limits.** All work is located within the existing right of way. Limit work activities to the Right-of-Way, and work and staging areas secured by the Contractor, at no additional cost to the Department. Be responsible for all encroachments onto private lands.
- L. Caution.** The information in this proposal and the type of work listed herein are approximate only and are not to be taken as an exact evaluation of the materials and conditions to be encountered during construction; the bidder must draw his/her own conclusions when developing the Unit Bid Prices for each bid item. As such, if the conditions encountered are not in accordance with the information shown, the Department does not

Polymer Concrete Overlay Systems  
Page 5 of 5

guarantee any changes to the Unit Bid Prices nor extension of the contract will be considered. The Department will pay for bid item quantity overruns, but only if pre-approved by the Engineer.

- M. Control.** Perform all work under the absolute control of the Department of Highways. Obtain the Engineer's approval of all designs required to be furnished by the Contractor prior to incorporation into the work. The Department reserves the right to have other work performed by other contractors and its own forces, and to permit public utility companies and others to do work during the construction within the limits of, or adjacent to, the project. Conduct operations and cooperate with such other parties so that interference with such other work will be reduced to a minimum. The Department will not honor any claims for money or time extension created by the operations of such other parties.

Should a difference of opinion arise as to the rights of the Contractor and others working within the limits of, or adjacent to, the project, the Engineer will decide as to the respective rights of the various parties involved in order to assure the completion of the Department's work in general harmony and in a satisfactory manner, and his/her decision shall be final and binding upon the Contractor.

#### IV. FIELD EVALUATION

High friction surface treatment locations that can be safely tested at 40 mph shall be evaluated by locked wheel skid test as per ASTM E274 between 60 and 90 days after installation. A minimum skid number of 75 SN40R is required. Installations that are not conducive to skid testing due to roadway geometrics or speed limitations shall be accepted based upon visual determination of acceptable bond and aggregate exposure.

Surface treatment applications not meeting average minimum skid test results of 75 SN **shall be removed and replaced** at no cost to the Department.

#### V. METHOD OF MEASUREMENT

- A. Maintain and Control Traffic.** See Traffic Control Plan.
- B. Site Preparation.** Other than the bid items listed, site preparation will not be measured for payment, but shall be incidental to high friction surface treatment.
- C. High Friction Surface Treatment.** The Department will measure the surface area coverage of High Friction Surface Treatment in Square Yards.

#### VI. BASIS OF PAYMENT

- A. Maintain and Control Traffic.** See Traffic Control Plan.
- B. High Friction Surface Treatment.** Payment for the accepted quantity at the Contract unit price per Square Yard shall be full compensation for furnishing all labor, materials, equipment, and incidentals for furnishing and installing High Friction Surface Treatment. Payment shall not be made prior to the final and accepted sweeping, 48 hours after installation.

## SPECIAL NOTE FOR STRIPING ON HIGH FRICTION SURFACE TREATMENTS

---

### I. DESCRIPTION

Installation of pavement striping, temporary, durable waterborne markings, and/or thermoplastic markings on High Friction Surface (HFS) Treatments.

### II. CONSTRUCTION

Conduct striping under lane closures meeting the conditions of the MUTCD and Kentucky Standard Drawings and Specifications, current editions. Upon initial completion of the HFS installation, install temporary striping as the Engineer directs. Upon completion of the 48 hour vacuum sweeping, install either durable waterborne markings or thermoplastic markings, whichever the Contract specifies or as directed by the Engineer. Temporary Pavement Striping will comply with all applicable requirements within Section 112. Thermoplastic markings shall comply with all applicable requirements within Section 714. Durable waterborne markings shall comply with all applicable requirements within Section 713. Application rates of durable waterborne striping shall be as follows:

Material	Paint Application Rate	Glass Bead Application Rate
4 inch durable waterborne paint	Min. of 24 gallons/mile	Min. of 6 pounds/gallon
6 inch durable waterborne paint	See Section 713.03.03	See Section 713.03.04

### III. MEASUREMENT

The Department will measure striping quantities in linear feet. NOTE: On HFS installations, the Contractor is advised that it may be necessary to install multiple passes of striping in order to achieve the required specifications. Final payment will be based on the actual length of the final striping regardless of the number passes required to meet specifications.

### IV. PAYMENT

The Department will make payment for the completed and accepted quantities under the following:

<u>Code</u>	<u>Pay Item</u>	<u>Pay Unit</u>
----	Pavement Striping - Temporary	Linear Foot
----	Durable Waterborne Marking, width, color	Linear Foot
----	Pavement Striping - Thermoplastic, width, color	Linear Foot

The Department will consider payment as full compensation for all work required under this note, Section 112, Section 713, and Section 714.



## Special Note for Completion Date & Liquidated Damages

---

### I. COMPLETION DATE

The ultimate fixed completion date for this project will be **October 31, 2024**. Liquidated Damages for failure to complete the project on time will be assessed following Section 108.09.

### II. LIQUIDATED DAMAGES

In addition to the requirements of Section 108.09, the Department will assess Liquidated Damages in the amount of **\$1,000** per hour for each hour, or fraction of an hour, for any and all lane closures that are in place beyond the time frame(s) noted in the Traffic Control Plan and approved by the Engineer.

Contrary to Section 108.09, Liquidated Damages will be assessed regardless of whether seasonal limitations prohibit the Contractor from performing work on the controlling operation.

Contrary to Section 108.09, Liquidated Damages will be assessed for the months of December through March.

All liquidated damages will be applied accumulatively.

All other applicable portions of Section 108 apply.

## **COORDINATION OF WORK WITH OTHER CONTRACTS**

Be advised, there may be an active project(s) adjacent to or within this project. The Engineer will coordinate the work of the Contractors. See Section 105.06.

1-3193 Coordination Contracts  
01/02/2012

## TRAFFIC CONTROL PLAN

---

### TRAFFIC CONTROL GENERAL

Except as provided herein, traffic shall be maintained in accordance with the current editions of the Manual on Uniform Traffic Control Devices (MUTCD), Standard Specifications, Supplemental Specifications, and the Standard and Sepia Drawings. Except for the roadway and traffic control bid items listed, all items of work necessary to maintain and control traffic shall be paid at the lump sum bid price to "Maintain and Control Traffic".

Contrary to Section 106.01, traffic control devices used on this project may be new, or used in like new condition, at the beginning of the work and maintained in like new condition until completion of the work. Any temporary traffic control items, devices, materials, and incidentals shall remain the property of the contractor unless otherwise addressed, when no longer needed.

### PROJECT PHASING & CONSTRUCTION PROCEDURES

**5-956.00 I-64 Ramps 321 and 322:** Complete the High Friction Surface Treatment (HFST) work using a full ramp closure. The Contractor shall submit the proposed ramp closure dates and times to the Engineer at least two weeks in advance for approval. Full single ramp closure shall only occur at night during the following times:

9:00 PM, until 5:00 AM

Only one ramp shall be closed concurrently.

The Department will allow night work on this project. Obtain the Engineer's approval of the method of lighting prior to performing night work.

Take these restrictions into account in submitting bid. The Department will not consider any claims for money or grant contract time extensions for any delays to the Contractor as a result of these restrictions.

**5-9036 KY 864, 5-9042.00 US 60A:** At locations with three or more lanes, maintain one lane of traffic in each direction at all times during construction. At locations with two lanes, maintain alternating one-way traffic during construction and provide a minimum clear lane width of 10 feet. At locations with one lane, such as at exit and entrance ramps, a partial lane closure is permitted during construction, as long as a minimum clear lane width of 10 feet. NOTE: During any lane closure or partial lane closure, make provisions for the passage of vehicles of up to 16 feet in width. If traffic should be stopped due to construction operations, and a school bus or emergency vehicle on an official run arrives on the scene, make provisions for the passage of the school bus or emergency vehicle as quickly as possible.

**5-9043.00 US 42, 5-9037.00 KY 907, 5-959.00 US 42, 5-960.00 KY 1931, 5-961.00 KY 1931:** Maintain alternating one-way traffic during construction. Provide a minimum clear lane width of 10 feet; however, provide for passage of vehicles of up to 16 feet in width. If traffic should be stopped due to construction operations, and a school bus or emergency vehicle on an official run arrives on the scene, make provisions for the passage of the school bus or emergency vehicle as quickly as possible.

Traffic Control Plan  
Page 2 of 8

Unless otherwise approved by the Engineer, no lane closures will be allowed during the following times:

Easter Weekend	3 pm Friday, March 29, 2024 – 8 pm Sunday, March 31, 2024
Memorial Day Weekend	3 pm Friday, May 24, 2024 – 8 pm Monday, May 27, 2024
Independence Day	7 pm Thursday, July 4, 2024 – 8 pm Sunday, July 7, 2024
Labor Day Weekend	3 pm Friday, August 30, 2024 – 8 pm Monday, September 2, 2024
Thanksgiving Holiday	3 pm Wednesday, November 27, 2024 – 8 pm Sunday, December 1, 2024
Christmas Holiday	7 am Tuesday, December 24, 2024 – 8 pm Wednesday, December 25, 2024
New Year's Day Holiday	7 am Tuesday, December 31, 2024 – 8 pm Wednesday, January 1, 2025
Thunder Over Louisville	3 pm Friday, April 19, 2024 – 9 am Monday, April 22, 2024
Kentucky Derby	3 pm Friday, April 26, 2024 – 9 am Monday, May 6, 2024

Do NOT erect lane closures during the following days and/or hours:

Normal Workday Rush Hours

Monday-Friday 7:00 AM – 9:00 AM, and 4:00 PM – 6:00 PM, daily

At the discretion of the Engineer, additional days and hours may be specified when lane closures will not be allowed.

The Contractor shall submit proposed lane closure days and times to the Engineer at least 14 calendar days in advance for approval.

NOTE: In addition to the typical work zone signing, two "LOOSE GRAVEL" signs (W8-7), one sign for each direction of travel, shall be erected prior to the installation of the HFST and shall remain in place until the final 48-hour vacuum sweep has been completed. These signs shall be installed in accordance with the current edition of Standard Drawing TTD-125.

## **LANE CLOSURES**

Long term lane closures shall not be allowed; therefore, lane closures will not be measured for payment. Do not leave lane closures in place during non-working hours and prohibited periods

## **TEMPORARY SIGNS**

Temporary signposts and splices shall be compliant with NCHRP 350 or MASH. Manufacturer's documentation validating this compliance shall be provided to the Engineer prior to installation. Temporary signs, including any splices, shall be installed according to manufacturer's specifications and installation recommendations. Contrary to section 112.04.02, only long-term temporary signs (temporary signs intended to be continuously in place for more than 3 days) will be measured for payment. Short-term temporary signs (temporary signs intended to be left in place for 3 days or less) will not be measured for payment but will be incidental to Maintain and Control Traffic.

Traffic Control Plan  
Page 3 of 8

### **CHANGEABLE MESSAGE SIGNS**

Provide changeable message signs in advance of and within the project at locations determined by the Engineer. If work is in progress concurrently in both directions or if more than one lane closure is in place in the same direction of travel, provide additional changeable message signs as directed by the Engineer. Place changeable message signs approximately one mile in advance of the anticipated queue at each lane closure. As the actual queue lengthens and/or shortens, relocate or provide additional changeable message signs so that traffic has warning of slowed or stopped traffic at least one mile but not more than two miles before reaching the end of the actual queue. The Engineer may vary the designated locations as the work progresses. The Engineer will determine the messages to be displayed. In the event of damage or mechanical/electrical failure, repair or replace the Changeable Message Sign. If the damage or mechanical/electrical failure is identified during active work operations, repair or replace the Changeable Message Sign within 6 hours. If the damage or mechanical/electrical failure is identified when there are no active work operations on the project, repair or replace the Changeable Message Sign within 12 hours. The Department will measure for payment the maximum number of Changeable Message Signs in concurrent use at the same time on a single day on all sections of the contract. The Department will measure individual Changeable Message Signs only once for payment, regardless of how many times they are set, reset, removed, and/or relocated during the duration of the project. The Department will not measure for payment any replacements for damaged Changeable Message Signs or any changeable message signs the Engineer directs to be replaced due to poor condition or readability. Retain possession of the Changeable Message Signs upon completion of the work.

### **TEMPORARY ENTRANCES**

The Engineer will not require the Contractor to provide continuous access to farms, single family, duplex, or triplex residential properties during working hours; however, provide reasonable egress and ingress to each such property when actual operations are not in progress at that location. Limit the time during which a farm or residential entrance is blocked to the minimum length of time required for actual operations, not extended for the Contractor's convenience, and in no case exceeding six (6) hours. Notify all residents twenty-four hours in advance of any driveway or entrance closings and make any accommodations necessary to meet the access needs of disabled residents.

Except as allowed by the Phasing as specified above, maintain direct access to all side streets and roads, schools, churches, commercial properties, and apartments or apartment complexes of four or more units at all times. Access to fire hydrants must also be maintained at all times

### **PAVEMENT MARKINGS**

If there is to be a deviation from the existing striping plan, the Engineer will furnish the Contractor a striping plan prior to placement of the final surface course. Install Temporary Striping according to Section 112 with the following exception:

If the Contractor's operations or phasing requires temporary markings that must subsequently be removed from the final surface course, use an approved removable lane tape; however, the Department will not measure removable lane tape for separate payment, but will measure and pay for removable lane tape as temporary striping.

## USE AND PLACEMENT OF CHANGEABLE MESSAGE SIGNS

The following policy is based upon current Changeable Message Signs (CMS) standards and practice from many sources, including the Federal Highway Administration (FHWA), other State Departments of Transportation, and Traffic Safety Associations. It is understood that each CMS installation or use requires individual consideration due to the specific location or purpose. However, there will be elements that are constant in nearly all applications. Accordingly, these recommended guidelines bring a level of uniformity, while still being open to regional experience and engineering judgment.

### **Application**

The primary purpose of CMS is to advise the driver of unexpected traffic and routing situations. Examples of applications where CMS can be effective include:

- Closures (road, lane, bridge, ramp, shoulder, interstate)
- Changes in alignment or surface conditions
- Significant delays, congestion
- Construction/maintenance activities (delays, future activities)
- Detours/alternative routes
- Special events with traffic and safety implications
- Crash/incidents
- Vehicle restrictions (width, height, weight, flammable)
- Advance notice of new traffic control devices
- Real-time traffic conditions (must be kept up to date)
- Weather /driving conditions, environmental conditions, Roadway Weather Information Systems
- Emergency Situations
- Referral to Highway Advisory Radio (if available)
- Messages as approved by the County Engineer's Office

### **CMS should not be used for:**

- Replacement of static signs (e.g. ROAD WORK AHEAD), regulatory signage (e.g. speed limits), pavement markings, standard traffic control devices, conventional warning or guide signs.
- Replacement of lighted arrow board
- Advertising (Don't advertise the event unless clarifying "action" to be taken by driver – e.g. Speedway traffic next exit)
- Generic messages
- Test messages (portable signs only)
- Describe recurrent congestion (e.g. rush hour)
- Public service announcements (not traffic related)

Traffic Control Plan  
Page 5 of 8

### **Messages**

Basic principles that are important to providing proper messages and ensuring the proper operation of a CMS are:

- Visible for at least ½ mile under ideal daytime and nighttime conditions
- Legible from all lanes a minimum of 650 feet
- Entire message readable twice while traveling at the posted speed
- No more than two message panels should be used (three panels may be used on roadways where vehicles are traveling less than 45 mph). A panel is the message that fits on the face of the sign without flipping or scrolling.
- Each panel should convey a single thought; short and concise
- Do not use two unrelated panels on a sign
- Do not use the sign for two unrelated messages
- Should not scroll text horizontally or vertically
- Should not contain both the words left and right
- Use standardized abbreviations and messages
- Should be accurate and timely
- Avoid filler/unnecessary words and periods (hazardous, a, an, the)
- Avoid use of speed limits
- Use words (not numbers) for dates

### **Placement**

Placement of the CMS is important to ensure that the sign is visible to the driver and provides ample time to take any necessary action. Some of the following principles may only be applicable to controlled access roadways. The basic principles of placement for a CMS are:

- When 2 signs are needed, place on same side of roadway and at least 1,000 feet apart
- Place behind semi-rigid/rigid protection (guardrail, barrier) or outside of the clear zone
- Place 1,000 feet in advance of work zone; at least one mile ahead of decision point
- Normally place on right side of roadway; but should be placed closest to the affected lane so that either side is acceptable
- Signs should not be dual mounted (one on each side of roadway facing same direction)
- Point trailer hitch downstream
- Secure to immovable object to prevent theft (if necessary)
- Do not place in sags or just beyond crest
- Check for reflection of sun to prevent the blinding of motorist
- Should be turned ~3 degrees outward from perpendicular to the edge of pavement
- Bottom of sign should be 7 feet above the elevation of edge of roadway
- Should be removed when not in use

Traffic Control Plan  
Page 6 of 8

**Standard Abbreviations**

The following is a list of standard abbreviations to be used on CMS:

<b><u>Word</u></b>	<b><u>Abbrev</u></b>	<b><u>Example</u></b>
Access	ACCS	CRASH AHEAD/ USE ACCS RD NEXT RIGHT
Alternate	ALT	CRASH AHEAD/ USE ALT RTE NEXT RIGHT
Avenue	AVE	FIFTH AVE CLOSED/ DETOUR NEXT LEFT
Blocked	BLKD	FIFTH AVE BLKD/ MERGE LEFT
Boulevard	BLVD	MAIN BLVD CLOSED/ USE ALT RTE
Bridge	BRDG	SMITH BRDG CLOSED/ USE ALT RTE
Cardinal Directions	N, S, E, W	N I75 CLOSED/ DETOUR EXIT 30
Center	CNTR	CNTR LANE CLOSED/ MERGE LEFT
Commercial	COMM	OVRSZ COMM VEH/ USE I275
Condition	COND	ICY COND POSSIBLE
Congested	CONG	HVY CONG NEXT 3 MI
Construction	CONST	CONST WORK AHEAD/ EXPECT DELAYS
Downtown	DWNTN	DWNTN TRAF USE EX 40
Eastbound	E-BND	E-BND I64 CLOSED/ DETOUR EXIT 20
Emergency	EMER	EMER VEH AHEAD/ PREPARE TO STOP
Entrance, Enter	EX, EXT	DWNTN TRAF USE EX 40
Expressway	EXPWY	WTRSN EXPWY CLOSED/ DETOUR EXIT 10
Freeway	FRWY, FWY	GN SYNDR FWY CLOSED/ DETOUR EXIT 15
Hazardous Materials	HAZMAT	HAZMAT IN ROADWAY/ ALL TRAF EXIT 25
Highway	HWY	CRASH ON AA HWY/ EXPECT DELAYS
Hour	HR	CRASH ON AA HWY/ 2 HR DELAY
Information	INFO	TRAF INFO TUNE TO 1240 AM
Interstate	I	E-BND I64 CLOSED/ DETOUR EXIT 20
Lane	LN	LN CLOSED MERGE LEFT
Left	LFT	LANE CLOSED MERGE LFT
Local	LOC	LOC TRAF USE ALT RTE
Maintenance	MAINT	MAINT WRK ON BRDG/ SLOW
Major	MAJ	MAJ DELAYS I75/ USE ALT RTE
Mile	MI	CRASH 3 MI AHEAD/ USE ALT RTE
Minor	MNR	CRASH 3 MI MNR DELAY
Minutes	MIN	CRASH 3 MI/ 30 MIN DELAY
Northbound	N-BND	N-BND I75 CLOSED/ DETOUR EXIT 50
Oversized	OVRSZ	OVRSZ COMM VEH/ USE I275 NEXT RIGHT
Parking	PKING	EVENT PKING NEXT RGT
Parkway	PKWY	CUM PKWAY TRAF/ DETOUR EXIT 60
Prepare	PREP	CRASH 3 MI/ PREP TO STOP
Right	RGT	EVENT PKING NEXT RGT
Road	RD	HAZMAT IN RD/ ALL TRAF EXIT 25
Roadwork	RDWK	RDWK NEXT 4 MI/ POSSIBLE DELAYS
Route	RTE	MAJ DELAYS I75/ USE ALT RTE
Shoulder	SHLDR	SHLDR CLOSED NEXT 5 MI
Slippery	SLIP	SLIP COND POSSIBLE/ SLOW SPD
Southbound	S-BND	S-BND I75 CLOSED/ DETOUR EXIT 50
Speed	SPD	SLIP COND POSSIBLE/ SLOW SPD



Traffic Control Plan  
Page 7 of 8

**Standard Abbreviations** (cont.)

<u>Word</u>	<u>Abbrev</u>	<u>Example</u>
Street	ST	MAIN ST CLOSED/ USE ALT RTE
Traffic	TRAF	CUM PKWAY TRAF/ DETOUR EXIT 60
Vehicle	VEH	OVRSZ COMM VEH/ USE I275 NEXT RIGHT
Westbound	W-BND	W-BND I64 CLOSED/ DETOUR EXIT 50
Work	WRK	CONST WRK 2MI/ POSSIBLE DELAYS

Certain abbreviations are prone to inviting confusion because another word is abbreviated or could be abbreviated in the same way. DO NOT USE THESE ABBREVIATIONS:

<u>Abbrev</u>	<u>Intended Word</u>	<u>Word Erroneously Given</u>
ACC	Accident	Access (Road)
CLRS	Clears	Colors
DLY	Delay	Daily
FDR	Feeder	Federal
L	Left	Lane (merge)
LOC	Local	Location
LT	Light (traffic)	Left
PARK	Parking	Park
POLL	Pollution (index)	Poll
RED	Reduce	Red
STAD	Stadium	Standard
TEMP	Temporary	Temperature
WRNG	Warning	Wrong

**Typical Messages**

The following is a list of typical messages used on CMS. The list consists of the reason or problem that you want the driver to be aware of and the action that you want the driver to take.

<u>Reason/Problem</u>	<u>Action</u>
CRASH AHEAD	ALL TRAFFIC EXIT RT
CRASH/XX MILES	AVOID DELAY USE XX
XX ROAD CLOSED	CONSIDER ALT ROUTE
XX EXIT CLOSED	DETOUR
BRIDGE CLOSED	DETOUR XX MILES
BRIDGE/(SLIPPERY, ICE, ETC.)	DO NOT PASS
CENTER/LANE/CLOSED	EXPECT DELAYS
DELAY(S), MAJOR/DELAYS	FOLLOW ALT ROUTE
DEBRIS AHEAD	KEEP LEFT
DENSE FOG	KEEP RIGHT
DISABLED/VEHICLE	MERGE XX MILES
EMER/VEHICLES/ONLY	MERGE LEFT
EVENT PARKING	MERGE RIGHT
EXIT XX CLOSED	ONE-WAY TRAFFIC
FLAGGER XX MILES	PASS TO LEFT

Traffic Control Plan  
Page 8 of 8

**Typical Messages** (cont.)

**Reason/Problem**

FOG XX MILES  
FREEWAY CLOSED  
FRESH OIL  
HAZMAT SPILL  
ICE  
INCIDENT AHEAD  
LANES (NARROW, SHIFT, MERGE, ETC.)  
LEFT LANE CLOSED  
LEFT LANE NARROWS  
LEFT 2 LANES CLOSED  
LEFT SHOULDER CLOSED  
LOOSE GRAVEL  
MEDIAN WORK XX MILES  
MOVING WORK ZONE, WORKERS IN ROADWAY  
NEXT EXIT CLOSED  
NO OVERSIZED LOADS  
NO PASSING  
NO SHOULDER  
ONE LANE BRIDGE  
PEOPLE CROSSING  
RAMP CLOSED  
RAMP (SLIPPERY, ICE, ETC.)  
RIGHT LANE CLOSED  
RIGHT LANE NARROWS  
RIGHT SHOULDER CLOSED  
ROAD CLOSED  
ROAD CLOSED XX MILES  
ROAD (SLIPPERY, ICE, ETC.)  
ROAD WORK  
ROAD WORK (OR CONSTRUCTION) (TONIGHT, TODAY, TOMORROW, DATE)  
ROAD WORK XX MILES  
SHOULDER (SLIPPERY, ICE, SOFT, BLOCKED, ETC.)  
NEW SIGNAL XX MILES  
SLOW 1 (OR 2) - WAY TRAFFIC  
SOFT SHOULDER  
STALLED VEHICLES AHEAD  
TRAFFIC BACKUP  
TRAFFIC SLOWS  
TRUCK CROSSING  
TRUCKS ENTERING  
TOW TRUCK AHEAD  
UNEVEN LANES  
WATER ON ROAD  
WET PAINT  
WORK ZONE XX MILES  
WORKERS AHEAD

**Action**

PASS TO RIGHT  
PREPARE TO STOP  
REDUCE SPEED  
SLOW  
SLOW DOWN  
STAY IN LANE  
STOP AHEAD  
STOP XX MILES  
TUNE RADIO 1610 AM  
USE NN ROAD  
USE CENTER LANE  
USE DETOUR ROUTE  
USE LEFT TURN LANE  
USE NEXT EXIT  
USE RIGHT LANE  
WATCH FOR FLAGGER



KENTUCKY TRANSPORTATION CABINET  
Department of Highways  
DIVISION OF RIGHT OF WAY & UTILITIES

TC 62-226  
Rev. 01/2016  
Page 1 of 1

**RIGHT OF WAY CERTIFICATION**

<input checked="" type="checkbox"/>	<b>Original</b>	<input type="checkbox"/>	<b>Re-Certification</b>	<b>RIGHT OF WAY CERTIFICATION</b>
-------------------------------------	-----------------	--------------------------	-------------------------	-----------------------------------

ITEM #	COUNTY	PROJECT # (STATE)	PROJECT # (FEDERAL)
5-956.00	Jefferson	FD52 056 0064 003-004	HSIP 9010(586)

**PROJECT DESCRIPTION**

Install High Friction Surface Treatment on I-64 Ramp 321, MP 0 to 0.166, and Ramp 322, MP 0.075 to 0.12 in Jefferson Co.

**No Additional Right of Way Required**

Construction will be within the limits of the existing right of way. The right of way was acquired in accordance to FHWA regulations under the Uniform Relocation Assistance and Real Property Acquisitions Policy Act of 1970, as amended. No additional right of way or relocation assistance were required for this project.

**Condition # 1 (Additional Right of Way Required and Cleared)**

All necessary right of way, including control of access rights when applicable, have been acquired including legal and physical possession. Trial or appeal of cases may be pending in court but legal possession has been obtained. There may be some improvements remaining on the right-of-way, but all occupants have vacated the lands and improvements, and KYTC has physical possession and the rights to remove, salvage, or demolish all improvements and enter on all land. Just Compensation has been paid or deposited with the court. All relocations have been relocated to decent, safe, and sanitary housing or that KYTC has made available to displaced persons adequate replacement housing in accordance with the provisions of the current FHWA directive.

**Condition # 2 (Additional Right of Way Required with Exception)**

The right of way has not been fully acquired, the right to occupy and to use all rights-of-way required for the proper execution of the project has been acquired. Some parcels may be pending in court and on other parcels full legal possession has not been obtained, but right of entry has been obtained, the occupants of all lands and improvements have vacated, and KYTC has physical possession and right to remove, salvage, or demolish all improvements. Just Compensation has been paid or deposited with the court for most parcels. Just Compensation for all pending parcels will be paid or deposited with the court prior to AWARD of construction contract

**Condition # 3 (Additional Right of Way Required with Exception)**

The acquisition or right of occupancy and use of a few remaining parcels are not complete and/or some parcels still have occupants. All remaining occupants have had replacement housing made available to them in accordance with 49 CFR 24.204. KYTC is hereby requesting authorization to advertise this project for bids and to proceed with bid letting even though the necessary right of way will not be fully acquired, and/or some occupants will not be relocated, and/or the just compensation will not be paid or deposited with the court for some parcels until after bid letting. KYTC will fully meet all the requirements outlined in 23 CFR 635.309(c)(3) and 49 CFR 24.102(j) and will expedite completion of all acquisitions, relocations, and full payments after bid letting and prior to AWARD of the construction contract or force account construction.

Total Number of Parcels on Project	0	EXCEPTION (S) Parcel #	ANTICIPATED DATE OF POSSESSION WITH EXPLANATION
Number of Parcels That Have Been Acquired			
Signed Deed			
Condemnation			
Signed ROE			

**Notes/ Comments (Text is limited. Use additional sheet if necessary.)**

LPA RW Project Manager		Right of Way Supervisor	
Printed Name		Printed Name	
Signature		Signature	Tom Boykin <small>Digitally signed by Tom Boykin Date: 2024.03.07 09:29:38 -05'00'</small>
Date		Date	
Right of Way Director		FHWA	
Printed Name		Printed Name	No Signature Required as per FHWA-KYTC Current Stewardship Agreement
Signature	 <small>Digitally signed by Kelly Divine Date: 2024.03.07 15:26:46 -06'00'</small>	Signature	
Date		Date	



KENTUCKY TRANSPORTATION CABINET  
Department of Highways  
DIVISION OF RIGHT OF WAY & UTILITIES

TC 62-226  
Rev. 01/2016  
Page 1 of 1

**RIGHT OF WAY CERTIFICATION**

<input checked="" type="checkbox"/>	<b>Original</b>	<input type="checkbox"/>	<b>Re-Certification</b>	<b>RIGHT OF WAY CERTIFICATION</b>
-------------------------------------	-----------------	--------------------------	-------------------------	-----------------------------------

ITEM #	COUNTY	PROJECT # (STATE)	PROJECT # (FEDERAL)
5-959.00	Jefferson	FD52 056 1931 004-005	HSIP 9010(589)

**PROJECT DESCRIPTION**

Install High Friction Surface Treatment on KY 1931 in Jefferson County from MP 4.2 to 4.33.

**No Additional Right of Way Required**

Construction will be within the limits of the existing right of way. The right of way was acquired in accordance to FHWA regulations under the Uniform Relocation Assistance and Real Property Acquisitions Policy Act of 1970, as amended. No additional right of way or relocation assistance were required for this project.

**Condition # 1 (Additional Right of Way Required and Cleared)**

All necessary right of way, including control of access rights when applicable, have been acquired including legal and physical possession. Trial or appeal of cases may be pending in court but legal possession has been obtained. There may be some improvements remaining on the right-of-way, but all occupants have vacated the lands and improvements, and KYTC has physical possession and the rights to remove, salvage, or demolish all improvements and enter on all land. Just Compensation has been paid or deposited with the court. All relocations have been relocated to decent, safe, and sanitary housing or that KYTC has made available to displaced persons adequate replacement housing in accordance with the provisions of the current FHWA directive.

**Condition # 2 (Additional Right of Way Required with Exception)**

The right of way has not been fully acquired, the right to occupy and to use all rights-of-way required for the proper execution of the project has been acquired. Some parcels may be pending in court and on other parcels full legal possession has not been obtained, but right of entry has been obtained, the occupants of all lands and improvements have vacated, and KYTC has physical possession and right to remove, salvage, or demolish all improvements. Just Compensation has been paid or deposited with the court for most parcels. Just Compensation for all pending parcels will be paid or deposited with the court prior to AWARD of construction contract

**Condition # 3 (Additional Right of Way Required with Exception)**

The acquisition or right of occupancy and use of a few remaining parcels are not complete and/or some parcels still have occupants. All remaining occupants have had replacement housing made available to them in accordance with 49 CFR 24.204. KYTC is hereby requesting authorization to advertise this project for bids and to proceed with bid letting even though the necessary right of way will not be fully acquired, and/or some occupants will not be relocated, and/or the just compensation will not be paid or deposited with the court for some parcels until after bid letting. KYTC will fully meet all the requirements outlined in 23 CFR 635.309(c)(3) and 49 CFR 24.102(j) and will expedite completion of all acquisitions, relocations, and full payments after bid letting and prior to AWARD of the construction contract or force account construction.

Total Number of Parcels on Project	0	EXCEPTION (S) Parcel #	ANTICIPATED DATE OF POSSESSION WITH EXPLANATION
Number of Parcels That Have Been Acquired			
Signed Deed			
Condemnation			
Signed ROE			

**Notes/ Comments (Text is limited. Use additional sheet if necessary.)**

LPA RW Project Manager		Right of Way Supervisor	
Printed Name		Printed Name	
Signature		Signature	Tom Boykin <small>Digitally signed by Tom Boykin Date: 2024.03.07 09:35:10 -05'00'</small>
Date		Date	
Right of Way Director		FHWA	
Printed Name		Printed Name	
Signature	<small>Digitally signed by Kelly Divine Date: 2024.03.07 15:35:33 -06'00'</small>	Signature	No Signature Required as per FHWA-KYTC Current Stewardship Agreement
Date		Date	



KENTUCKY TRANSPORTATION CABINET  
Department of Highways  
DIVISION OF RIGHT OF WAY & UTILITIES

TC 62-226  
Rev. 01/2016  
Page 1 of 1

**RIGHT OF WAY CERTIFICATION**

<input checked="" type="checkbox"/>	<b>Original</b>	<input type="checkbox"/>	<b>Re-Certification</b>	<b>RIGHT OF WAY CERTIFICATION</b>
-------------------------------------	-----------------	--------------------------	-------------------------	-----------------------------------

ITEM #	COUNTY	PROJECT # (STATE)	PROJECT # (FEDERAL)
5-960.00	Jefferson	FD52 056 1931 004-005	HSIP 9010(590)

**PROJECT DESCRIPTION**

Install High Friction Surface Treatment on KY 1931 in Jefferson County from MP 4.33 to 4.477.

**No Additional Right of Way Required**

Construction will be within the limits of the existing right of way. The right of way was acquired in accordance to FHWA regulations under the Uniform Relocation Assistance and Real Property Acquisitions Policy Act of 1970, as amended. No additional right of way or relocation assistance were required for this project.

**Condition # 1 (Additional Right of Way Required and Cleared)**

All necessary right of way, including control of access rights when applicable, have been acquired including legal and physical possession. Trial or appeal of cases may be pending in court but legal possession has been obtained. There may be some improvements remaining on the right-of-way, but all occupants have vacated the lands and improvements, and KYTC has physical possession and the rights to remove, salvage, or demolish all improvements and enter on all land. Just Compensation has been paid or deposited with the court. All relocations have been relocated to decent, safe, and sanitary housing or that KYTC has made available to displaced persons adequate replacement housing in accordance with the provisions of the current FHWA directive.

**Condition # 2 (Additional Right of Way Required with Exception)**

The right of way has not been fully acquired, the right to occupy and to use all rights-of-way required for the proper execution of the project has been acquired. Some parcels may be pending in court and on other parcels full legal possession has not been obtained, but right of entry has been obtained, the occupants of all lands and improvements have vacated, and KYTC has physical possession and right to remove, salvage, or demolish all improvements. Just Compensation has been paid or deposited with the court for most parcels. Just Compensation for all pending parcels will be paid or deposited with the court prior to AWARD of construction contract

**Condition # 3 (Additional Right of Way Required with Exception)**

The acquisition or right of occupancy and use of a few remaining parcels are not complete and/or some parcels still have occupants. All remaining occupants have had replacement housing made available to them in accordance with 49 CFR 24.204. KYTC is hereby requesting authorization to advertise this project for bids and to proceed with bid letting even though the necessary right of way will not be fully acquired, and/or some occupants will not be relocated, and/or the just compensation will not be paid or deposited with the court for some parcels until after bid letting. KYTC will fully meet all the requirements outlined in 23 CFR 635.309(c)(3) and 49 CFR 24.102(j) and will expedite completion of all acquisitions, relocations, and full payments after bid letting and prior to AWARD of the construction contract or force account construction.

Total Number of Parcels on Project	0	EXCEPTION (S) Parcel #	ANTICIPATED DATE OF POSSESSION WITH EXPLANATION
Number of Parcels That Have Been Acquired			
Signed Deed			
Condemnation			
Signed ROE			

**Notes/ Comments (Text is limited. Use additional sheet if necessary.)**

LPA RW Project Manager		Right of Way Supervisor	
Printed Name		Printed Name	
Signature		Signature	Tom Boykin <small>Digitally signed by Tom Boykin Date: 2024.03.07 09:37:39 -05'00'</small>
Date		Date	
Right of Way Director		FHWA	
Printed Name		Printed Name	
Signature	<small>Digitally signed by Kelly Divine Date: 2024.03.07 15:38:05 -06'00'</small>	Signature	
Date		Date	

**No Signature Required  
as per FHWA-KYTC  
Current Stewardship Agreement**



KENTUCKY TRANSPORTATION CABINET  
Department of Highways  
DIVISION OF RIGHT OF WAY & UTILITIES

TC 62-226  
Rev. 01/2016  
Page 1 of 1

**RIGHT OF WAY CERTIFICATION**

<input checked="" type="checkbox"/>	<b>Original</b>	<input type="checkbox"/>	<b>Re-Certification</b>	<b>RIGHT OF WAY CERTIFICATION</b>
-------------------------------------	-----------------	--------------------------	-------------------------	-----------------------------------

ITEM #	COUNTY	PROJECT # (STATE)	PROJECT # (FEDERAL)
5-961.00	Jefferson	FD52 056 1931 005-006	HSIP 9010(591)

**PROJECT DESCRIPTION**

Install High Friction Surface Treatment on KY 1931 in Jefferson County from MP 5.72 to 5.90.

**No Additional Right of Way Required**

Construction will be within the limits of the existing right of way. The right of way was acquired in accordance to FHWA regulations under the Uniform Relocation Assistance and Real Property Acquisitions Policy Act of 1970, as amended. No additional right of way or relocation assistance were required for this project.

**Condition # 1 (Additional Right of Way Required and Cleared)**

All necessary right of way, including control of access rights when applicable, have been acquired including legal and physical possession. Trial or appeal of cases may be pending in court but legal possession has been obtained. There may be some improvements remaining on the right-of-way, but all occupants have vacated the lands and improvements, and KYTC has physical possession and the rights to remove, salvage, or demolish all improvements and enter on all land. Just Compensation has been paid or deposited with the court. All relocations have been relocated to decent, safe, and sanitary housing or that KYTC has made available to displaced persons adequate replacement housing in accordance with the provisions of the current FHWA directive.

**Condition # 2 (Additional Right of Way Required with Exception)**

The right of way has not been fully acquired, the right to occupy and to use all rights-of-way required for the proper execution of the project has been acquired. Some parcels may be pending in court and on other parcels full legal possession has not been obtained, but right of entry has been obtained, the occupants of all lands and improvements have vacated, and KYTC has physical possession and right to remove, salvage, or demolish all improvements. Just Compensation has been paid or deposited with the court for most parcels. Just Compensation for all pending parcels will be paid or deposited with the court prior to AWARD of construction contract

**Condition # 3 (Additional Right of Way Required with Exception)**

The acquisition or right of occupancy and use of a few remaining parcels are not complete and/or some parcels still have occupants. All remaining occupants have had replacement housing made available to them in accordance with 49 CFR 24.204. KYTC is hereby requesting authorization to advertise this project for bids and to proceed with bid letting even though the necessary right of way will not be fully acquired, and/or some occupants will not be relocated, and/or the just compensation will not be paid or deposited with the court for some parcels until after bid letting. KYTC will fully meet all the requirements outlined in 23 CFR 635.309(c)(3) and 49 CFR 24.102(j) and will expedite completion of all acquisitions, relocations, and full payments after bid letting and prior to AWARD of the construction contract or force account construction.

Total Number of Parcels on Project	0	EXCEPTION (S) Parcel #	ANTICIPATED DATE OF POSSESSION WITH EXPLANATION
Number of Parcels That Have Been Acquired			
Signed Deed			
Condemnation			
Signed ROE			

**Notes/ Comments (Text is limited. Use additional sheet if necessary.)**

LPA RW Project Manager		Right of Way Supervisor	
Printed Name		Printed Name	
Signature		Signature	Tom Boykin <small>Digitally signed by Tom Boykin Date: 2024.03.07 09:39:06 -05'00'</small>
Date		Date	
Right of Way Director		FHWA	
Printed Name		Printed Name	
Signature	<small>Digitally signed by Kelly Divine Date: 2024.03.07 15:40:08 -06'00'</small>	Signature	<b>No Signature Required as per FHWA-KYTC Current Stewardship Agreement</b>
Date		Date	



KENTUCKY TRANSPORTATION CABINET  
Department of Highways  
DIVISION OF RIGHT OF WAY & UTILITIES

TC 62-226  
Rev. 01/2016  
Page 1 of 1

**RIGHT OF WAY CERTIFICATION**

<input checked="" type="checkbox"/>	<b>Original</b>	<input type="checkbox"/>	<b>Re-Certification</b>	<b>RIGHT OF WAY CERTIFICATION</b>
-------------------------------------	-----------------	--------------------------	-------------------------	-----------------------------------

ITEM #	COUNTY	PROJECT # (STATE)	PROJECT # (FEDERAL)
5-9036.00	Jefferson	FD52 056 0864 012-013	HSIP 9010(595)

**PROJECT DESCRIPTION**

Install High Friction Surface Treatment on KY 864 in Jefferson County from MP 12.0 to 12.071.

**No Additional Right of Way Required**

Construction will be within the limits of the existing right of way. The right of way was acquired in accordance to FHWA regulations under the Uniform Relocation Assistance and Real Property Acquisitions Policy Act of 1970, as amended. No additional right of way or relocation assistance were required for this project.

**Condition # 1 (Additional Right of Way Required and Cleared)**

All necessary right of way, including control of access rights when applicable, have been acquired including legal and physical possession. Trial or appeal of cases may be pending in court but legal possession has been obtained. There may be some improvements remaining on the right-of-way, but all occupants have vacated the lands and improvements, and KYTC has physical possession and the rights to remove, salvage, or demolish all improvements and enter on all land. Just Compensation has been paid or deposited with the court. All relocations have been relocated to decent, safe, and sanitary housing or that KYTC has made available to displaced persons adequate replacement housing in accordance with the provisions of the current FHWA directive.

**Condition # 2 (Additional Right of Way Required with Exception)**

The right of way has not been fully acquired, the right to occupy and to use all rights-of-way required for the proper execution of the project has been acquired. Some parcels may be pending in court and on other parcels full legal possession has not been obtained, but right of entry has been obtained, the occupants of all lands and improvements have vacated, and KYTC has physical possession and right to remove, salvage, or demolish all improvements. Just Compensation has been paid or deposited with the court for most parcels. Just Compensation for all pending parcels will be paid or deposited with the court prior to AWARD of construction contract

**Condition # 3 (Additional Right of Way Required with Exception)**

The acquisition or right of occupancy and use of a few remaining parcels are not complete and/or some parcels still have occupants. All remaining occupants have had replacement housing made available to them in accordance with 49 CFR 24.204. KYTC is hereby requesting authorization to advertise this project for bids and to proceed with bid letting even though the necessary right of way will not be fully acquired, and/or some occupants will not be relocated, and/or the just compensation will not be paid or deposited with the court for some parcels until after bid letting. KYTC will fully meet all the requirements outlined in 23 CFR 635.309(c)(3) and 49 CFR 24.102(j) and will expedite completion of all acquisitions, relocations, and full payments after bid letting and prior to AWARD of the construction contract or force account construction.

Total Number of Parcels on Project	0	EXCEPTION (S) Parcel #	ANTICIPATED DATE OF POSSESSION WITH EXPLANATION
Number of Parcels That Have Been Acquired			
Signed Deed			
Condemnation			
Signed ROE			

**Notes/ Comments (Text is limited. Use additional sheet if necessary.)**

LPA RW Project Manager		Right of Way Supervisor	
Printed Name		Printed Name	
Signature		Signature	Tom Boykin <small>Digitally signed by Tom Boykin Date: 2024.03.07 09:45:57 -05'00'</small>
Date		Date	
Right of Way Director		FHWA	
Printed Name		Printed Name	
Signature	<small>Digitally signed by Kelly Divine Date: 2024.03.08 06:57:55 -06'00'</small>	Signature	<b>No Signature Required as per FHWA-KYTC Current Stewardship Agreement</b>
Date		Date	





KENTUCKY TRANSPORTATION CABINET  
Department of Highways  
DIVISION OF RIGHT OF WAY & UTILITIES

TC 62-226  
Rev. 01/2016  
Page 1 of 1

**RIGHT OF WAY CERTIFICATION**

<input checked="" type="checkbox"/>	<b>Original</b>	<input type="checkbox"/>	<b>Re-Certification</b>	<b>RIGHT OF WAY CERTIFICATION</b>
-------------------------------------	-----------------	--------------------------	-------------------------	-----------------------------------

ITEM #	COUNTY	PROJECT # (STATE)	PROJECT # (FEDERAL)
5-9037.00	Jefferson	FD52 056 0907 006-007	HSIP 9010(596)

**PROJECT DESCRIPTION**

Install High Friction Surface Treatment on KY 907 in Jefferson County from MP 6.70 to 7.00.

**No Additional Right of Way Required**

Construction will be within the limits of the existing right of way. The right of way was acquired in accordance to FHWA regulations under the Uniform Relocation Assistance and Real Property Acquisitions Policy Act of 1970, as amended. No additional right of way or relocation assistance were required for this project.

**Condition # 1 (Additional Right of Way Required and Cleared)**

All necessary right of way, including control of access rights when applicable, have been acquired including legal and physical possession. Trial or appeal of cases may be pending in court but legal possession has been obtained. There may be some improvements remaining on the right-of-way, but all occupants have vacated the lands and improvements, and KYTC has physical possession and the rights to remove, salvage, or demolish all improvements and enter on all land. Just Compensation has been paid or deposited with the court. All relocations have been relocated to decent, safe, and sanitary housing or that KYTC has made available to displaced persons adequate replacement housing in accordance with the provisions of the current FHWA directive.

**Condition # 2 (Additional Right of Way Required with Exception)**

The right of way has not been fully acquired, the right to occupy and to use all rights-of-way required for the proper execution of the project has been acquired. Some parcels may be pending in court and on other parcels full legal possession has not been obtained, but right of entry has been obtained, the occupants of all lands and improvements have vacated, and KYTC has physical possession and right to remove, salvage, or demolish all improvements. Just Compensation has been paid or deposited with the court for most parcels. Just Compensation for all pending parcels will be paid or deposited with the court prior to AWARD of construction contract

**Condition # 3 (Additional Right of Way Required with Exception)**

The acquisition or right of occupancy and use of a few remaining parcels are not complete and/or some parcels still have occupants. All remaining occupants have had replacement housing made available to them in accordance with 49 CFR 24.204. KYTC is hereby requesting authorization to advertise this project for bids and to proceed with bid letting even though the necessary right of way will not be fully acquired, and/or some occupants will not be relocated, and/or the just compensation will not be paid or deposited with the court for some parcels until after bid letting. KYTC will fully meet all the requirements outlined in 23 CFR 635.309(c)(3) and 49 CFR 24.102(j) and will expedite completion of all acquisitions, relocations, and full payments after bid letting and prior to AWARD of the construction contract or force account construction.

Total Number of Parcels on Project	0	EXCEPTION (S) Parcel #	ANTICIPATED DATE OF POSSESSION WITH EXPLANATION
Number of Parcels That Have Been Acquired			
Signed Deed			
Condemnation			
Signed ROE			

**Notes/ Comments (Text is limited. Use additional sheet if necessary.)**

LPA RW Project Manager		Right of Way Supervisor	
Printed Name		Printed Name	
Signature		Signature	Tom Boykin <small>Digitally signed by Tom Boykin Date: 2024.03.07 09:47:19 -05'00'</small>
Date		Date	
Right of Way Director		FHWA	
Printed Name		Printed Name	
Signature	<small>Digitally signed by Kelly Divine Date: 2024.03.08 06:59:44 -06'00'</small>	Signature	<b>No Signature Required as per FHWA-KYTC Current Stewardship Agreement</b>
Date		Date	





KENTUCKY TRANSPORTATION CABINET  
Department of Highways  
DIVISION OF RIGHT OF WAY & UTILITIES

TC 62-226  
Rev. 01/2016  
Page 1 of 1

**RIGHT OF WAY CERTIFICATION**

<input checked="" type="checkbox"/>	<b>Original</b>	<input type="checkbox"/>	<b>Re-Certification</b>	<b>RIGHT OF WAY CERTIFICATION</b>
-------------------------------------	-----------------	--------------------------	-------------------------	-----------------------------------

ITEM #	COUNTY	PROJECT # (STATE)	PROJECT # (FEDERAL)
5-9042.00	Jefferson	FD52 056 060A 004-005	HSIP 9010(601)

**PROJECT DESCRIPTION**

Install High Friction Surface Treatment on US 60A in Jefferson County from MP 4.19 to 4.36.

**No Additional Right of Way Required**

Construction will be within the limits of the existing right of way. The right of way was acquired in accordance to FHWA regulations under the Uniform Relocation Assistance and Real Property Acquisitions Policy Act of 1970, as amended. No additional right of way or relocation assistance were required for this project.

**Condition # 1 (Additional Right of Way Required and Cleared)**

All necessary right of way, including control of access rights when applicable, have been acquired including legal and physical possession. Trial or appeal of cases may be pending in court but legal possession has been obtained. There may be some improvements remaining on the right-of-way, but all occupants have vacated the lands and improvements, and KYTC has physical possession and the rights to remove, salvage, or demolish all improvements and enter on all land. Just Compensation has been paid or deposited with the court. All relocations have been relocated to decent, safe, and sanitary housing or that KYTC has made available to displaced persons adequate replacement housing in accordance with the provisions of the current FHWA directive.

**Condition # 2 (Additional Right of Way Required with Exception)**

The right of way has not been fully acquired, the right to occupy and to use all rights-of-way required for the proper execution of the project has been acquired. Some parcels may be pending in court and on other parcels full legal possession has not been obtained, but right of entry has been obtained, the occupants of all lands and improvements have vacated, and KYTC has physical possession and right to remove, salvage, or demolish all improvements. Just Compensation has been paid or deposited with the court for most parcels. Just Compensation for all pending parcels will be paid or deposited with the court prior to AWARD of construction contract

**Condition # 3 (Additional Right of Way Required with Exception)**

The acquisition or right of occupancy and use of a few remaining parcels are not complete and/or some parcels still have occupants. All remaining occupants have had replacement housing made available to them in accordance with 49 CFR 24.204. KYTC is hereby requesting authorization to advertise this project for bids and to proceed with bid letting even though the necessary right of way will not be fully acquired, and/or some occupants will not be relocated, and/or the just compensation will not be paid or deposited with the court for some parcels until after bid letting. KYTC will fully meet all the requirements outlined in 23 CFR 635.309(c)(3) and 49 CFR 24.102(j) and will expedite completion of all acquisitions, relocations, and full payments after bid letting and prior to AWARD of the construction contract or force account construction.

Total Number of Parcels on Project	0	EXCEPTION (S) Parcel #	ANTICIPATED DATE OF POSSESSION WITH EXPLANATION
Number of Parcels That Have Been Acquired			
Signed Deed			
Condemnation			
Signed ROE			

**Notes/ Comments (Text is limited. Use additional sheet if necessary.)**

LPA RW Project Manager		Right of Way Supervisor	
Printed Name		Printed Name	
Signature		Signature	Tom Boykin <small>Digitally signed by Tom Boykin Date: 2024.03.07 09:54:24 -05'00'</small>
Date		Date	
Right of Way Director		FHWA	
Printed Name		Printed Name	<b>No Signature Required as per FHWA-KYTC Current Stewardship Agreement</b>
Signature	Digitally signed by Kelly Divine Date: 2024.03.08 07:09:11 -06'00'	Signature	
Date		Date	



KENTUCKY TRANSPORTATION CABINET  
Department of Highways  
DIVISION OF RIGHT OF WAY & UTILITIES

TC 62-226  
Rev. 01/2016  
Page 1 of 1

**RIGHT OF WAY CERTIFICATION**

<input checked="" type="checkbox"/>	<b>Original</b>	<input type="checkbox"/>	<b>Re-Certification</b>	<b>RIGHT OF WAY CERTIFICATION</b>
-------------------------------------	-----------------	--------------------------	-------------------------	-----------------------------------

ITEM #	COUNTY	PROJECT # (STATE)	PROJECT # (FEDERAL)
5-9043.00	Oldham	FD52 093 0042 000-001	HSIP 9010(602)

**PROJECT DESCRIPTION**

Install High Friction Surface Treatment on US 42 in Oldham County from MP 0.63 to 0.83.

**No Additional Right of Way Required**

Construction will be within the limits of the existing right of way. The right of way was acquired in accordance to FHWA regulations under the Uniform Relocation Assistance and Real Property Acquisitions Policy Act of 1970, as amended. No additional right of way or relocation assistance were required for this project.

**Condition # 1 (Additional Right of Way Required and Cleared)**

All necessary right of way, including control of access rights when applicable, have been acquired including legal and physical possession. Trial or appeal of cases may be pending in court but legal possession has been obtained. There may be some improvements remaining on the right-of-way, but all occupants have vacated the lands and improvements, and KYTC has physical possession and the rights to remove, salvage, or demolish all improvements and enter on all land. Just Compensation has been paid or deposited with the court. All relocations have been relocated to decent, safe, and sanitary housing or that KYTC has made available to displaced persons adequate replacement housing in accordance with the provisions of the current FHWA directive.

**Condition # 2 (Additional Right of Way Required with Exception)**

The right of way has not been fully acquired, the right to occupy and to use all rights-of-way required for the proper execution of the project has been acquired. Some parcels may be pending in court and on other parcels full legal possession has not been obtained, but right of entry has been obtained, the occupants of all lands and improvements have vacated, and KYTC has physical possession and right to remove, salvage, or demolish all improvements. Just Compensation has been paid or deposited with the court for most parcels. Just Compensation for all pending parcels will be paid or deposited with the court prior to AWARD of construction contract

**Condition # 3 (Additional Right of Way Required with Exception)**

The acquisition or right of occupancy and use of a few remaining parcels are not complete and/or some parcels still have occupants. All remaining occupants have had replacement housing made available to them in accordance with 49 CFR 24.204. KYTC is hereby requesting authorization to advertise this project for bids and to proceed with bid letting even though the necessary right of way will not be fully acquired, and/or some occupants will not be relocated, and/or the just compensation will not be paid or deposited with the court for some parcels until after bid letting. KYTC will fully meet all the requirements outlined in 23 CFR 635.309(c)(3) and 49 CFR 24.102(j) and will expedite completion of all acquisitions, relocations, and full payments after bid letting and prior to AWARD of the construction contract or force account construction.

Total Number of Parcels on Project	0	EXCEPTION (S) Parcel #	ANTICIPATED DATE OF POSSESSION WITH EXPLANATION
Number of Parcels That Have Been Acquired			
Signed Deed			
Condemnation			
Signed ROE			

**Notes/ Comments (Text is limited. Use additional sheet if necessary.)**

LPA RW Project Manager		Right of Way Supervisor	
Printed Name		Printed Name	
Signature		Signature	Tom Boykin <small>Digitally signed by Tom Boykin Date: 2024.03.07 09:55:34 -05'00'</small>
Date		Date	
Right of Way Director		FHWA	
Printed Name		Printed Name	
Signature	 <small>Digitally signed by Kelly Divine Date: 2024.03.08 07:10:51 -06'00'</small>	Signature	<b>No Signature Required as per FHWA-KYTC Current Stewardship Agreement</b>
Date		Date	

## UTILITIES AND RAIL CERTIFICATION NOTE

5-956.00	Jefferson County	HSIP 9010(586)	FD52 056 0064 000-001	I-64 Ramps 321 and 322 MP 0.0-0.114
5-959.00	Jefferson County	HSIP 9010(589)	FD52 056 1931 004-005	KY 1931 from MP 4.2 to 4.33
5-960.00	Jefferson County	HSIP 9010(590)	FD52 056 1931 004-005	KY 1931 from MP 4.33 to 4.477
5-961.00	Jefferson County	HSIP 9010(591)	FD52 056 1931 005-006	KY 1931 from MP 5.72 to 5.899
5-9036.00	Jefferson County	HSIP 9010(595)	FD52 056 0864 012-013	KY 864 from MP 12.02 to 12.066
5-9037.00	Jefferson County	HSIP 9010(596)	FD52 056 0907 006-007	KY 907 from MP 6.7 to 6.85
5-9042.00	Jefferson County	HSIP 9010(601)	FD52 056 060A 004-005	US 60A from MP 4.19 to 4.36
5-9043.00	Jefferson County	HSIP 9010(602)	FD52 056 0042 000-001	US 42 from MP 0.63 to 0.83

Utility coordination efforts conducted by the project sponsor have determined that no utility relocation work is required to complete the project.

### THE FOLLOWING RAIL COMPANIES HAVE FACILITIES IN CONJUNCTION WITH THIS PROJECT AS NOTED

- No Rail Involved       Minimal Rail Involved (See Below)       Rail Involved (See Below)

### UNDERGROUND FACILITY DAMAGE PROTECTION – BEFORE YOU DIG

The contractor shall make every effort to protect underground facilities from damage as prescribed in the Underground Facility Damage Protection Act of 1994, Kentucky Revised Statute KRS 367.4901 to 367.4917. It is the contractor’s responsibility to determine and take steps necessary to be in compliance with federal and state damage prevention directives. The contractor is instructed to contact KY 811 for the location of existing underground utilities. Contact shall be made a minimum of two (2) and no more than ten (10) business days prior to excavation.

The contractor shall submit Excavation Locate Requests to the Kentucky Contact Center (KY 811) via web ticket entry. The submission of this request does not relieve the contractor from the responsibility of contacting non-member facility owners, whom are to be contacted through their individual Protection Notification Center. It may be necessary for the contractor to contact the County Court Clerk to determine what utility companies have facilities in the area. Non-compliance with these directives can result in the enforcement of penalties.

### SPECIAL CAUTION NOTE – PROTECTION OF UTILITIES

The contractor will be responsible for contacting all utility facility owners on the subject project to coordinate his activities. The contractor will coordinate his activities to minimize and, where possible, avoid conflicts with utility facilities. Due to the nature of the work proposed, it is unlikely to conflict with the existing utilities beyond minor facility adjustments. Where conflicts with utility facilities are unavoidable, the contractor will coordinate any necessary relocation work with the facility owner and the Engineer. The Kentucky Transportation Cabinet maintains the right to remove or alter portions of this contract if a utility conflict occurs.

The utility facilities as noted in the previous section(s) have been determined using data garnered by varied means and with varying degrees of accuracy: from the facility owners, a result of S.U.E., field inspections, and/or reviews of record drawings. The facilities defined may not be inclusive of all utilities in the project scope and are not Level A quality, unless specified as such. It is the contractor’s responsibility to verify all utilities and their respective locations before excavating. *Please Note: The information presented in this Utility Note is informational in nature and the information contained herein is not guaranteed.*

# MATERIAL SUMMARY

**CONTRACT ID: 244702**

**121GR24T005-HSIP**

**0505600602401**

EASTERN PARKWAY (US 60A) HFST ON EASTERN PARKWAY (US 60A) HIGH FRICTION SURFACE, A DISTANCE OF .11 MILES.

Project Line No	Bid Code	DESCRIPTION	Quantity	Unit
0155	02562	TEMPORARY SIGNS	200.00	SQFT
0160	02650	MAINTAIN & CONTROL TRAFFIC	1.00	LS
0165	02671	PORTABLE CHANGEABLE MESSAGE SIGN	2.00	EACH
0170	02775	ARROW PANEL	2.00	EACH
0175	06568	PAVE MARKING-THERMO STOP BAR-24IN	48.00	LF
0180	20099ES842	PAVE MARK TEMP PAINT STOP BAR	48.00	LF
0185	23229EC	HIGH FRICTION SURFACE TREATMENT	1,338.00	SQYD
0190	40045	PAVEMENT MARKING REMOVAL	96.00	SQFT
0195	02569	DEMOBILIZATION	1.00	LS

**CONTRACT ID: 244702**

**121GR24T005-HSIP**

**0505600642401**

INTERSTATE 64 (I-64 RAMPS 321 AND 322) HFST ON INTERSTATE 64 (I-64 RAMPS 321 AND 322) HIGH FRICTION SURFACE, A DISTANCE OF .14 MILES.

Project Line No	Bid Code	DESCRIPTION	Quantity	Unit
0225	02014	BARRICADE-TYPE III	2.00	EACH
0230	02562	TEMPORARY SIGNS	200.00	SQFT
0235	02650	MAINTAIN & CONTROL TRAFFIC	1.00	LS
0240	02671	PORTABLE CHANGEABLE MESSAGE SIGN	3.00	EACH
0245	02775	ARROW PANEL	2.00	EACH
0250	23229EC	HIGH FRICTION SURFACE TREATMENT	907.00	SQYD
0255	02569	DEMOBILIZATION	1.00	LS

# MATERIAL SUMMARY

**CONTRACT ID: 244702**

**121GR24T005-HSIP**

**0505608642401**

POPLAR LEVEL ROAD (KY 864) HFST ON POPLAR LEVEL ROAD (KY 864) HIGH FRICTION SURFACE, A DISTANCE OF .05 MILES.

Project Line No	Bid Code	DESCRIPTION	Quantity	Unit
0260	02562	TEMPORARY SIGNS	200.00	SQFT
0265	02650	MAINTAIN & CONTROL TRAFFIC	1.00	LS
0270	02671	PORTABLE CHANGEABLE MESSAGE SIGN	2.00	EACH
0275	02775	ARROW PANEL	2.00	EACH
0280	06568	PAVE MARKING-THERMO STOP BAR-24IN	22.00	LF
0285	06598	PAVEMENT MARKING REMOVAL	44.00	SQFT
0290	20099ES842	PAVE MARK TEMP PAINT STOP BAR	22.00	LF
0295	23229EC	HIGH FRICTION SURFACE TREATMENT	611.00	SQYD
0300	02569	DEMOBILIZATION	1.00	LS

**CONTRACT ID: 244702**

**121GR24T005-HSIP**

**0505609072401**

SOUTHSIDE DRIVE (KY 907) HFST ON SOUTHSIDE DRIVE (KY 907) HIGH FRICTION SURFACE, A DISTANCE OF .22 MILES.

Project Line No	Bid Code	DESCRIPTION	Quantity	Unit
0200	02562	TEMPORARY SIGNS	200.00	SQFT
0205	02650	MAINTAIN & CONTROL TRAFFIC	1.00	LS
0210	02671	PORTABLE CHANGEABLE MESSAGE SIGN	2.00	EACH
0215	23229EC	HIGH FRICTION SURFACE TREATMENT	2,647.00	SQYD
0220	02569	DEMOBILIZATION	1.00	LS

**CONTRACT ID: 244702**

**121GR24T005-HSIP**

**0505619312401**

ST. ANDREWS CHURCH ROAD (KY 1931) HFST ON ST ANDREWS CHURCH ROAD (KY 1931) HIGH FRICTION SURFACE, A DISTANCE OF .13 MILES.

Project Line No	Bid Code	DESCRIPTION	Quantity	Unit
0050	02562	TEMPORARY SIGNS	200.00	SQFT
0055	02650	MAINTAIN & CONTROL TRAFFIC	1.00	LS
0060	02671	PORTABLE CHANGEABLE MESSAGE SIGN	2.00	EACH
0065	02775	ARROW PANEL	2.00	EACH
0070	23229EC	HIGH FRICTION SURFACE TREATMENT	556.00	SQYD
0075	02569	DEMOBILIZATION	1.00	LS

# MATERIAL SUMMARY

**CONTRACT ID: 244702**

**121GR24T005-HSIP**

**0505619312402**

ST. ANDREWS CHURCH ROAD (KY 1931) HFST ON ST ANDREWS CHURCH ROAD (KY 1931) HIGH FRICTION SURFACE, A DISTANCE OF .11 MILES.

Project Line No	Bid Code	DESCRIPTION	Quantity	Unit
0080	02562	TEMPORARY SIGNS	200.00	SQFT
0085	02650	MAINTAIN & CONTROL TRAFFIC	1.00	LS
0090	02671	PORTABLE CHANGEABLE MESSAGE SIGN	2.00	EACH
0095	02775	ARROW PANEL	2.00	EACH
0100	06568	PAVE MARKING-THERMO STOP BAR-24IN	48.00	LF
0105	06574	PAVE MARKING-THERMO CURV ARROW	4.00	EACH
0110	20099ES842	PAVE MARK TEMP PAINT STOP BAR	48.00	LF
0115	23229EC	HIGH FRICTION SURFACE TREATMENT	600.00	SQYD
0120	40045	PAVEMENT MARKING REMOVAL	143.00	SQFT
0125	02569	DEMOBILIZATION	1.00	LS

**CONTRACT ID: 244702**

**121GR24T005-HSIP**

**0505619312403**

MANSLICK ROAD (KY 1931) HFST ON MANSLICK ROAD (KY 1931) HIGH FRICTION SURFACE, A DISTANCE OF .15 MILES.

Project Line No	Bid Code	DESCRIPTION	Quantity	Unit
0130	02562	TEMPORARY SIGNS	150.00	SQFT
0135	02650	MAINTAIN & CONTROL TRAFFIC	1.00	LS
0140	02671	PORTABLE CHANGEABLE MESSAGE SIGN	2.00	EACH
0145	23229EC	HIGH FRICTION SURFACE TREATMENT	2,040.00	SQYD
0150	02569	DEMOBILIZATION	1.00	LS

# MATERIAL SUMMARY

**CONTRACT ID: 244702**

**121GR24T005-HSIP**

**0509300422401**

FEDERAL ROUTE 42 (US 42) HFST ON FEDERAL ROUTE 42 (US 42) HIGH FRICTION SURFACE, A DISTANCE OF .14 MILES.

Project Line No	Bid Code	DESCRIPTION	Quantity	Unit
0005	02562	TEMPORARY SIGNS	200.00	SQFT
0010	02650	MAINTAIN & CONTROL TRAFFIC	1.00	LS
0015	02671	PORTABLE CHANGEABLE MESSAGE SIGN	2.00	EACH
0020	02775	ARROW PANEL	2.00	EACH
0025	06568	PAVE MARKING-THERMO STOP BAR-24IN	24.00	LF
0030	06598	PAVEMENT MARKING REMOVAL	48.00	SQFT
0035	20099ES842	PAVE MARK TEMP PAINT STOP BAR	24.00	LF
0040	23229EC	HIGH FRICTION SURFACE TREATMENT	829.00	SQYD
0045	02569	DEMOBILIZATION	1.00	LS



# COMMONWEALTH OF KENTUCKY DEPARTMENT OF HIGHWAYS

## JEFFERSON COUNTY

I-64 — Ramps 321 and 322  
5-956.00

COUNTY OF	ITEM NO.
JEFFERSON	5-956.00

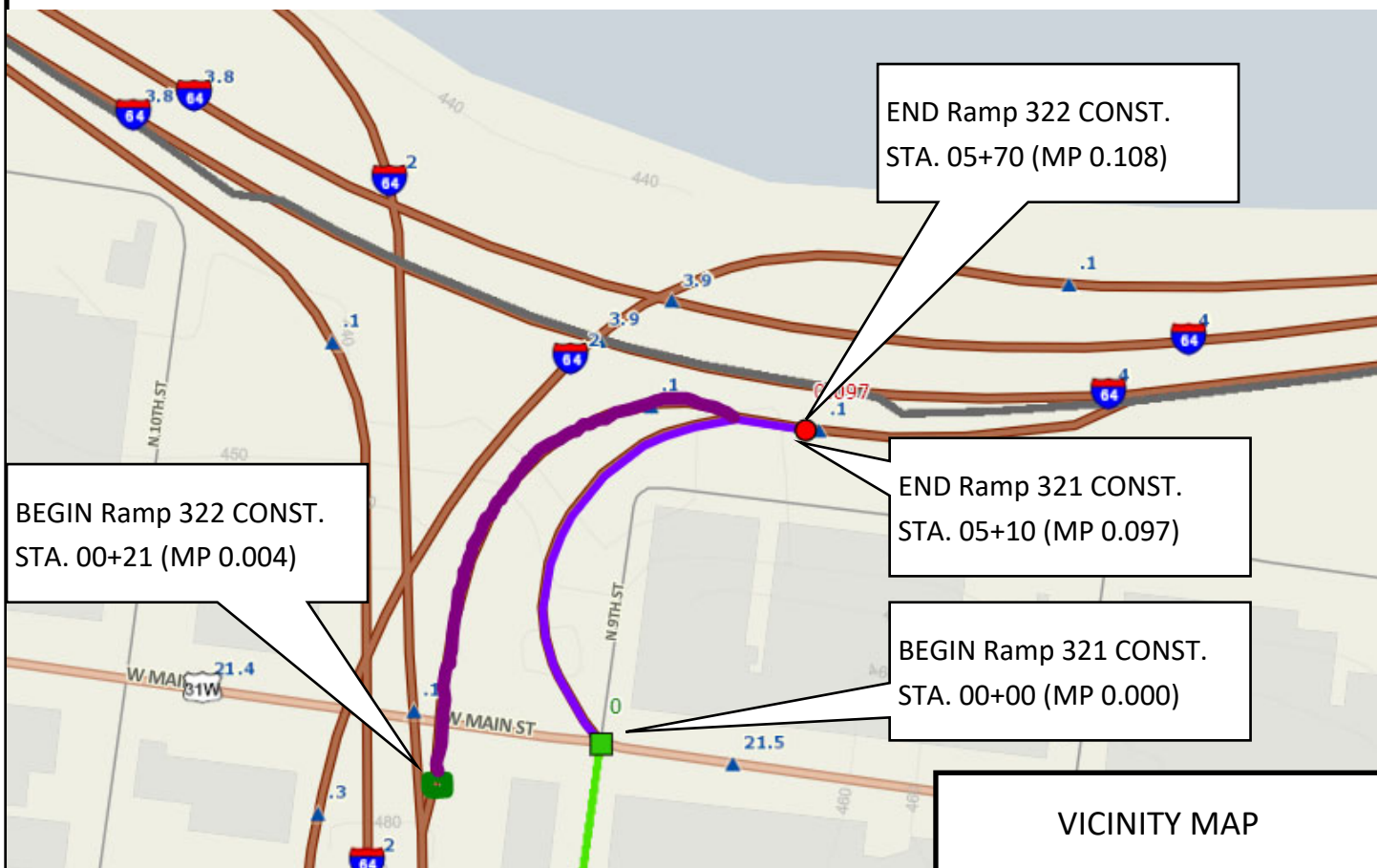
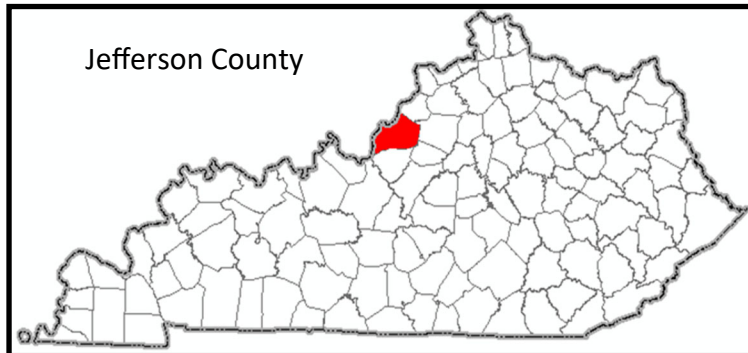



**COMMONWEALTH OF KENTUCKY**  
**DEPARTMENT OF HIGHWAYS**

**JEFFERSON COUNTY**  
US 31W to EB I-64 Ramp  
5-956.00

COUNTY OF	ITEM NO.
JEFFERSON	5-956.00

**GENERAL SUMMARY**

BID CODE	DESCRIPTION	UNIT	QTY
2014	BARRICADE	EACH	2
2562	TEMPORARY SIGNS	SQFT	200
2650	MAINTAIN AND CONTROL TRAFFIC	LS	1
2671	PORTABLE CHANGEABLE MESSAGE SIGN	EACH	3
23229EC	HIGH FRICTION SURFACE TREATMENT	SQYD	907
2569	DEMOBILIZATION	LS	1

GENERAL SUMMARY

# COMMONWEALTH OF KENTUCKY DEPARTMENT OF HIGHWAYS

## JEFFERSON COUNTY

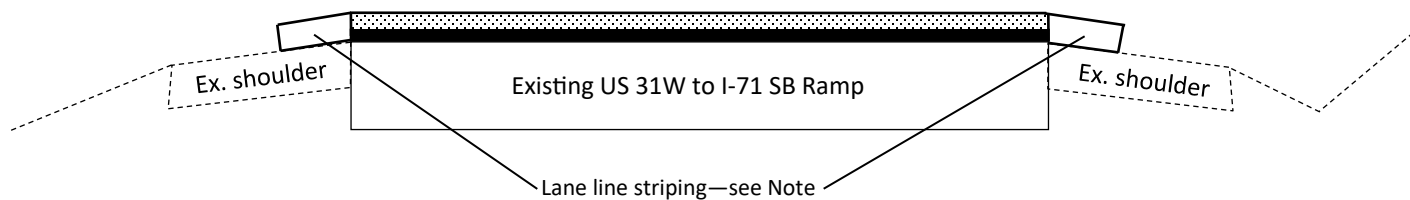
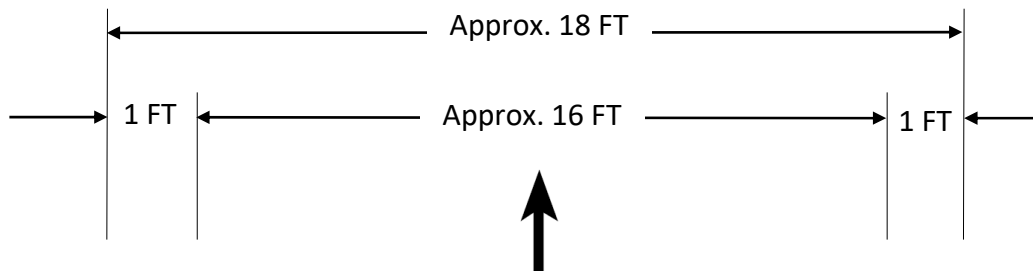

I 64 — Ramp 321  
5-956.00

COUNTY OF	ITEM NO.
JEFFERSON	5-956.00



**Ramp Milepoint 0.000 to Ramp Milepoint 0.097**

**Note:** The HFST should extend to, but not over, the lane line striping and rumble strip. Protect the lane line striping and rumble strip in accordance with the Special Note for Polymer Concrete Overlay Systems.

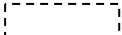
-  HFS Aggregate
-  Polymer Resin Binder
-  Lane Line Striping

N.T.S.

**TYPICAL SECTION**

**COMMONWEALTH OF KENTUCKY  
DEPARTMENT OF HIGHWAYS**

**JEFFERSON COUNTY**

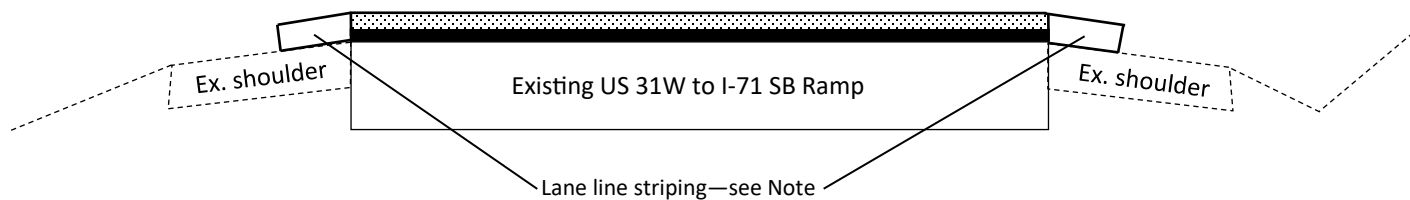
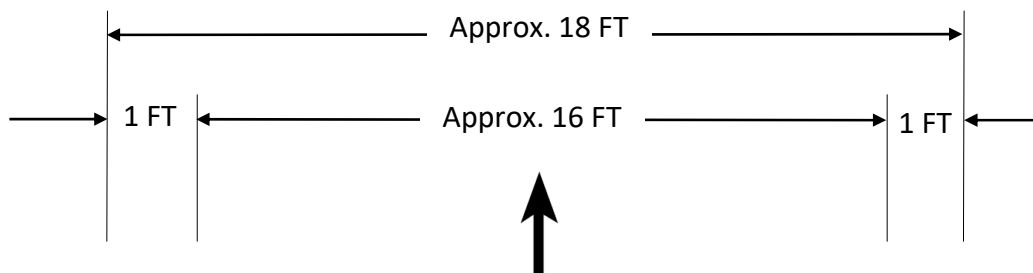

I 64 — Ramp 322  
5-956.00

COUNTY OF	ITEM NO.
JEFFERSON	5-956.00



**Ramp Milepoint 0.004 to Ramp Milepoint 0.108**

**Note:** The HFST should extend to, but not over, the lane line striping and rumble strip. Protect the lane line striping and rumble strip in accordance with the Special Note for Polymer Concrete Overlay Systems.

-  HFS Aggregate
-  Polymer Resin Binder
-  Lane Line Striping

N.T.S.

**TYPICAL SECTION**

# COMMONWEALTH OF KENTUCKY DEPARTMENT OF HIGHWAYS

COUNTY OF	ITEM NO.
JEFFERSON	5-956.00

**JEFFERSON COUNTY**  
I 64 — Ramps 321 and 322  
5-956.00

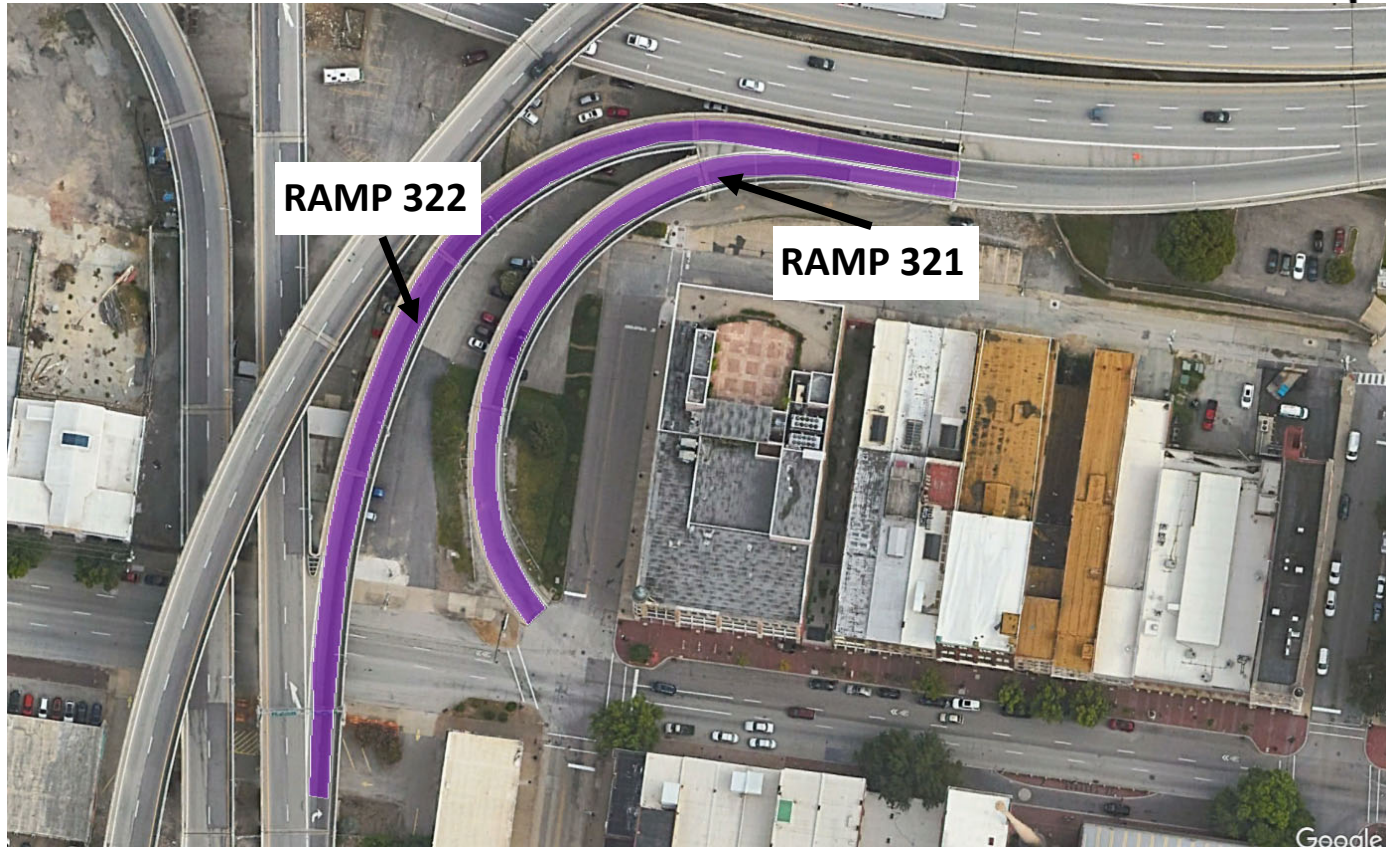

**Notes:**

- The beginning and ending points shown on this detail are approximate. The intent is for the High Friction Surface (HFST) along ramp 322 to begin approximately 10 feet after the curve arrow, and end approximately at the beginning of the gore with I-64 EB. The intent is for the High Friction Surface (HFST) along ramp 321 to begin approximately at the beginning of the ramp, and end approximately at the beginning of the gore with I-64 EB
- HFST shall only be placed on pavement that is in relatively good condition. The Engineer shall determine if the pavement is in acceptable condition prior to installing a HFST. If in doubt, the Engineer may contact CO HSIP staff to determine if pavement conditions have deteriorated significantly since the HFST site was identified.
- The Engineer shall mark the beginning and ending points for the HFST in the field at the time of construction.

<b>Legend</b>
HFST Location 

**DETAIL SHEET**



# COMMONWEALTH OF KENTUCKY DEPARTMENT OF HIGHWAYS

## JEFFERSON COUNTY

KY 1931— St Andrews Church Road  
5-959.00

COUNTY OF	ITEM NO.
JEFFERSON	5-959.00

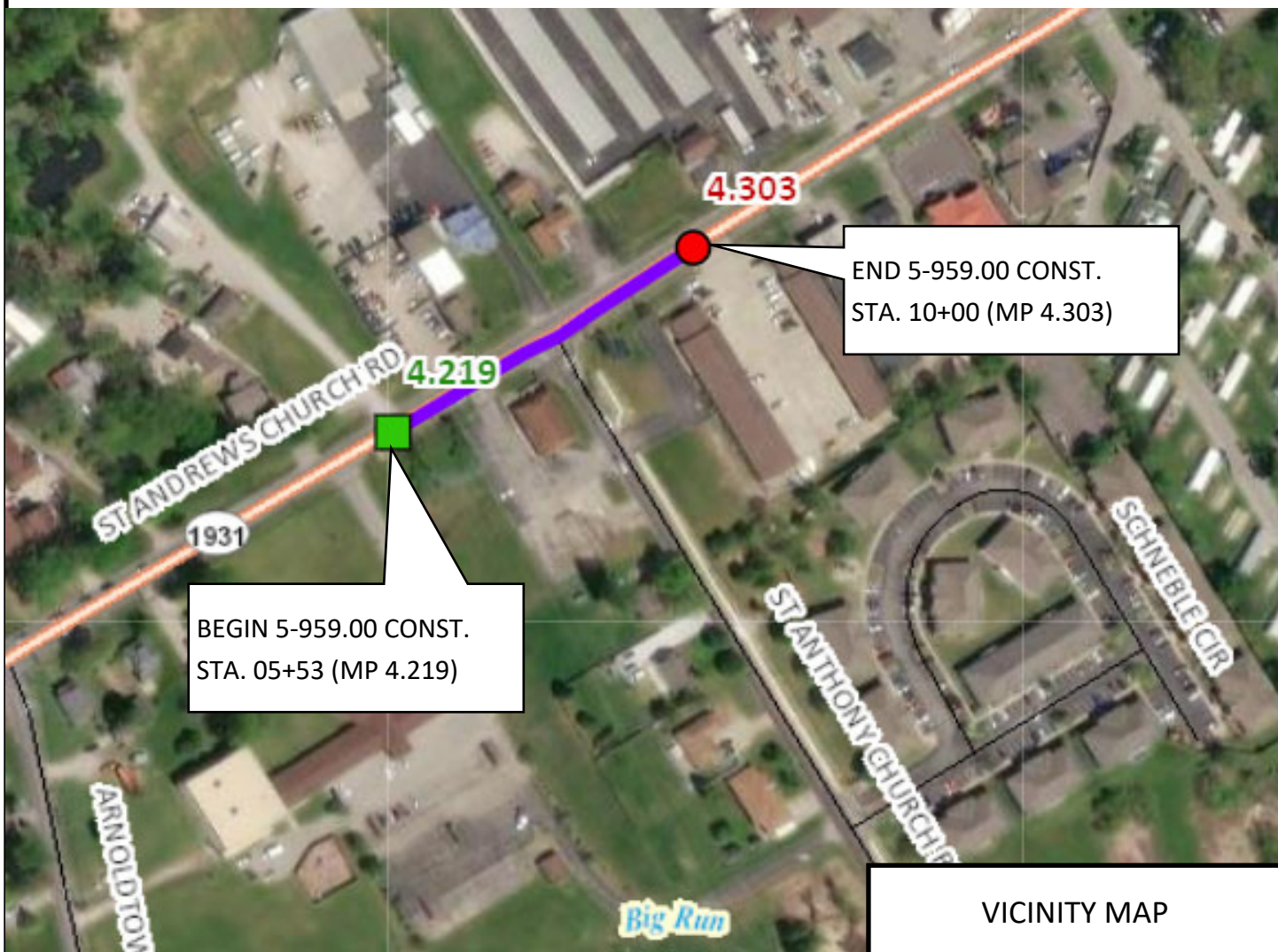
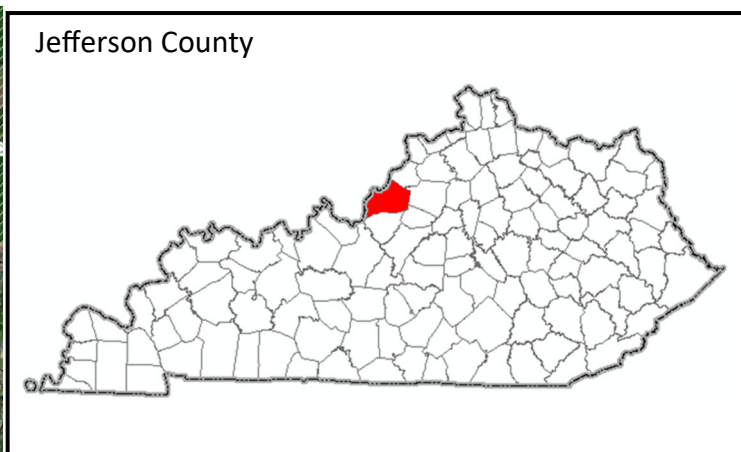

**COMMONWEALTH OF KENTUCKY**  
**DEPARTMENT OF HIGHWAYS**

**JEFFERSON COUNTY**

KY 1931 St Andrews Church Road  
5-959.00

COUNTY OF	ITEM NO.
JEFFERSON	5-959.00

**GENERAL SUMMARY**

BID CODE	DESCRIPTION	UNIT	QTY
2562	TEMPORARY SIGNS	SQFT	200
2650	MAINTAIN AND CONTROL TRAFFIC	LS	1
2671	PORTABLE CHANGEABLE MESSAGE SIGN	EACH	2
2775	ARROW PANEL	EACH	2
23229EC	HIGH FRICTION SURFACE TREATMENT	SQYD	556
2569	DEMOBILIZATION	LS	1

GENERAL SUMMARY

**COMMONWEALTH OF KENTUCKY  
DEPARTMENT OF HIGHWAYS  
JEFFERSON COUNTY**

KY 1931 St Andrews Church Road  
5-959.00

COUNTY OF	ITEM NO.
JEFFERSON	5-959.00

**HIGH FRICTION SURFACE TREATMENT SUMMARY**

Station		Length (FT)	Width (FT)	Area (SQYD)	Notes
Begin	End				
005+53	008+03	250	10	278	Through Lane
007+50	010+00	250	10	278	Through Lane
			Total	556	

BID CODE	DESCRIPTION	UNIT	QTY
23229EC	HIGH FRICTION SURFACE TREATMENT	SQYD	556

PAVEMENT MARKING  
& HFST SUMMARY

**COMMONWEALTH OF KENTUCKY**  
**DEPARTMENT OF HIGHWAYS**

**JEFFERSON COUNTY**

KY 1931 — ST ANDREWS CHURCH ROAD  
5-959.00

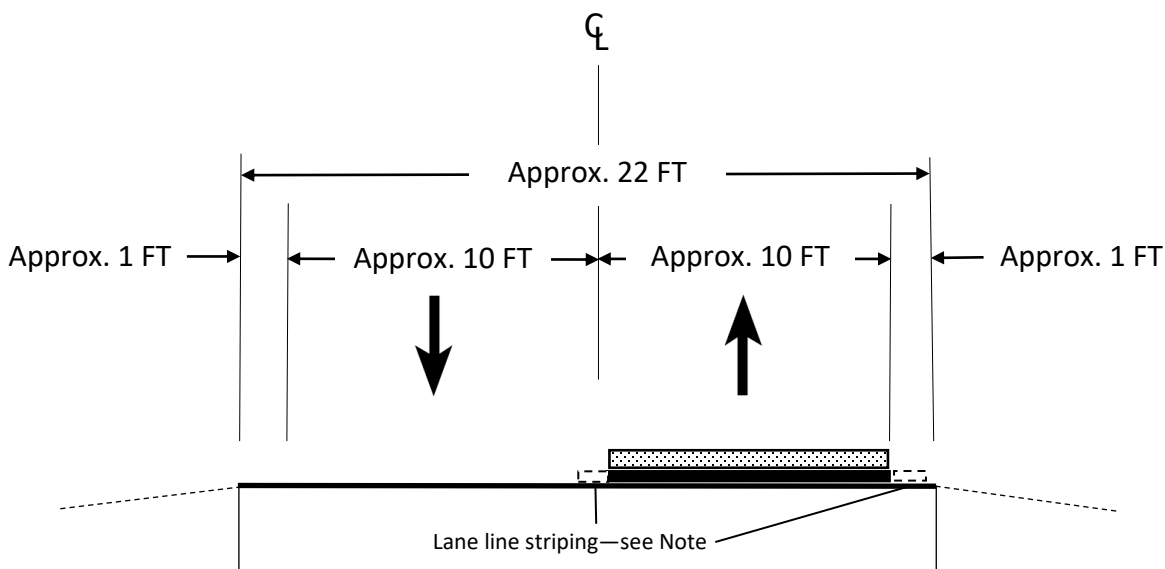

COUNTY OF	ITEM NO.
JEFFERSON	5-959.00



Approx. MP 4.219— MP 4.266

Eastbound Only

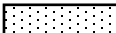
**Note:** The HFST should extend to, but not over, the lane line striping and rumble strip. Protect the lane line striping and rumble strip in accordance with the Special Note for Polymer Concrete Overlay Systems.

-  HFST Aggregate
-  Polymer Resin Binder
-  Lane Line Striping

**TYPICAL SECTION**



# COMMONWEALTH OF KENTUCKY DEPARTMENT OF HIGHWAYS

## JEFFERSON COUNTY

KY 1931 — ST ANDREWS CHURCH ROAD  
5-959.00

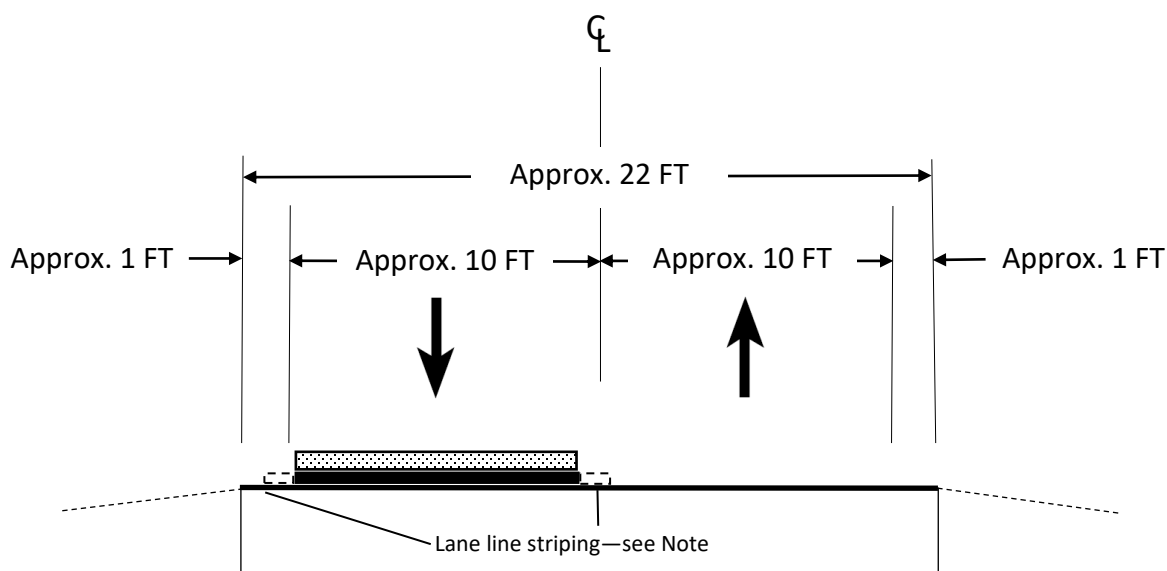

COUNTY OF	ITEM NO.
JEFFERSON	5-959.00



Approx. MP 4.256— MP 4.303

Westbound Only

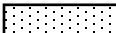
**Note:** The HFST should extend to, but not over, the lane line striping and rumble strip. Protect the lane line striping and rumble strip in accordance with the Special Note for Polymer Concrete Overlay Systems.

-  HFST Aggregate
-  Polymer Resin Binder
-  Lane Line Striping

TYPICAL SECTION

# COMMONWEALTH OF KENTUCKY DEPARTMENT OF HIGHWAYS

## JEFFERSON COUNTY

KY 1931 — ST ANDREWS CHURCH RD  
5-959.00

COUNTY OF	ITEM NO.
JEFFERSON	5-959.00

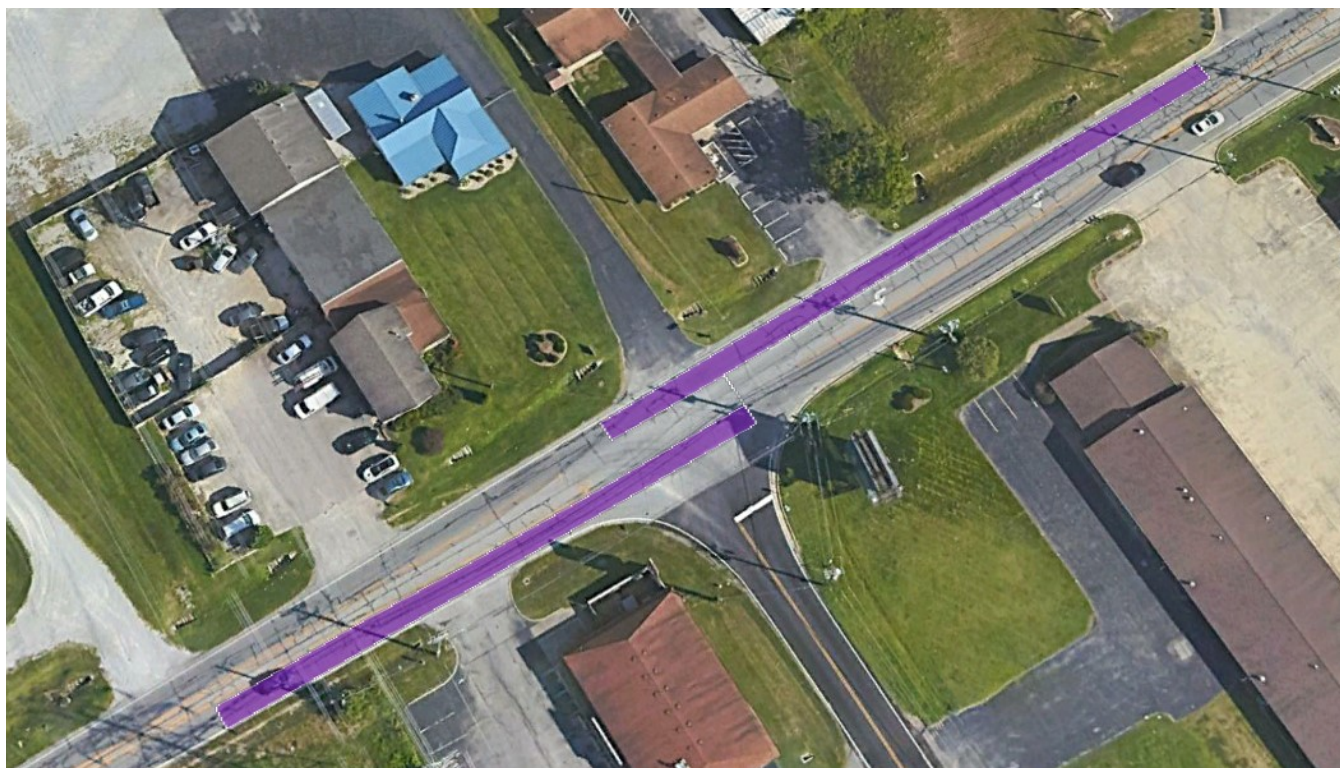

### Notes:

- The beginning and ending points shown on this detail are approximate. The intent is for the High Friction Surface (HFST) placed eastbound to begin approximately 250 feet prior to the west radius of St Anthony Church Rd intersection and end approximately at the west radius of St Anthony Church Rd. The intent is for the HFST placed westbound to begin approximately at the east end of the curve and end approximately 250 feet after the east radius of St Anthony Church Rd.
- HFST shall only be placed on pavement that is in relatively good condition. The Engineer shall determine if the pavement is in acceptable condition prior to installing a HFST. If in doubt, the Engineer may contact CO HSIP staff to determine if pavement conditions have deteriorated significantly since the HFST site was identified.

### Legend

HFST Location 

DETAIL SHEET

# COMMONWEALTH OF KENTUCKY DEPARTMENT OF HIGHWAYS

## JEFFERSON COUNTY

KY 1931 — ST ANDREWS CHURCH ROAD  
5-960.00

COUNTY OF	ITEM NO.
JEFFERSON	5-960.00

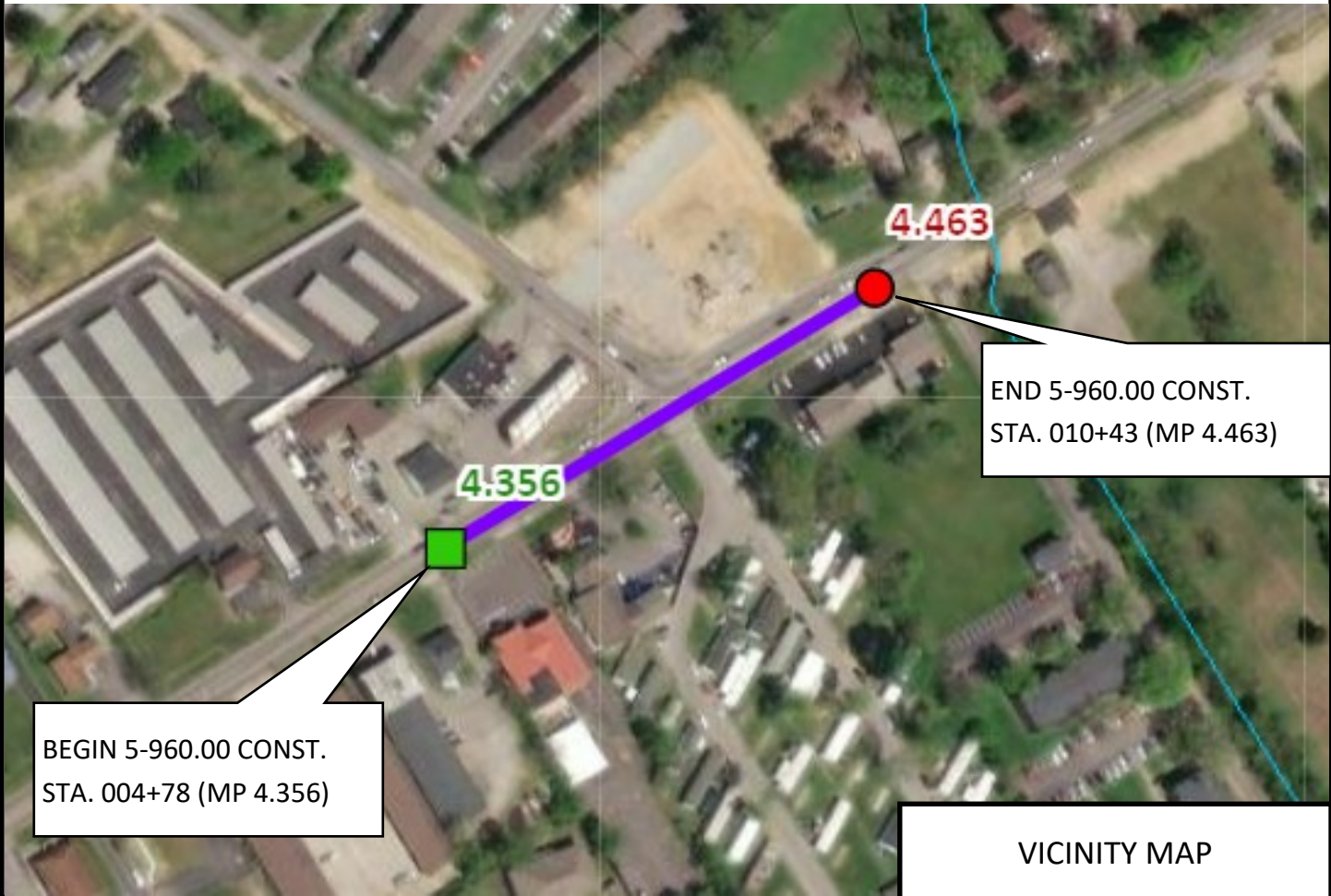
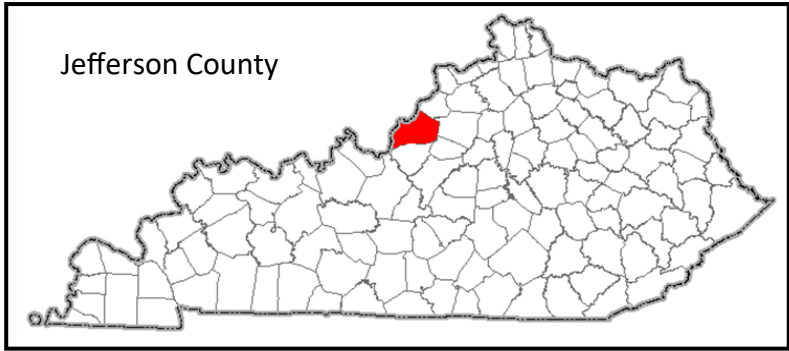

VICINITY MAP

**COMMONWEALTH OF KENTUCKY  
DEPARTMENT OF HIGHWAYS**

**JEFFERSON COUNTY**

KY 1931 St Andrews Church Road  
5-960.00

COUNTY OF	ITEM NO.
JEFFERSON	5-960.00

**GENERAL SUMMARY**

BID CODE	DESCRIPTION	UNIT	QTY
2562	TEMPORARY SIGNS	SQFT	200
2650	MAINTAIN AND CONTROL TRAFFIC	LS	1
2671	PORTABLE CHANGEABLE MESSAGE SIGN	EACH	2
2775	ARROW PANEL	EACH	2
6574	PAVE MARKING-THERMO CURV ARROW	EACH	4
6568	PAVE MARKING-THERMO STOP BAR-24 IN	LF	48
20099ES842	PAVE MARK TEMP PAINT STOP BAR	LF	48
6598	PAVEMENT MARKING REMOVAL	SF	143
23229EC	HIGH FRICTION SURFACE TREATMENT	SQYD	600
2569	DEMOBILIZATION	LS	1

GENERAL SUMMARY

**COMMONWEALTH OF KENTUCKY  
DEPARTMENT OF HIGHWAYS**

**JEFFERSON COUNTY**

KY 1931 St Andrews Church Road  
5-960.00

COUNTY OF	ITEM NO.
JEFFERSON	5-960.00

**PAVEMENT MARKING SUMMARY**

Station	PAVEMENT MARKINGS					Notes
	Curve Arrow	Stop Bar	Straight Arrow	Comb. Arrow	Removal	
	(EACH)	(LF)	(EACH)	(EACH)	(SF)	
007+18		24			48	EB Approach
006+71	1				16	Left turn lane (EB)
008+03		24			48	WB Approach
008+41	2				31	Left turn and right turn lane (WB)
008+89	1				16	Right Turn lane (WB)
Total		4	48	0	0	143

**HIGH FRICTION SURFACE TREATMENT SUMMARY**

Station		Length (FT)	Width (FT)	Area (SQYD)	Notes
Begin	End				
004+78	007+28	250	12	333	Through Lane (EB)
006+28	007+28	100	12	133	Left Turn Lane (EB)
007+93	008+93	100	12	133	Right Turn Lane (WB)
007+93	010+43	250	12	333	Through Lane (WB)
007+93	008+93	100	12	133	Left Turn Lane (WB)
Total				600	

BID CODE	DESCRIPTION	UNIT	QTY
6574	PAVE MARKING-THERMO CURV ARROW	EACH	4
6568	PAVE MARKING-THERMO STOP BAR-24 IN	LF	48
6598	PAVEMENT MARKING REMOVAL	SF	143
20099ES842	PAVE MARK TEMP PAINT STOP BAR	LF	48
23229EC	HIGH FRICTION SURFACE TREATMENT	SQYD	600

PAVEMENT MARKING  
& HFST SUMMARY

**COMMONWEALTH OF KENTUCKY  
 DEPARTMENT OF HIGHWAYS**

**JEFFERSON COUNTY**

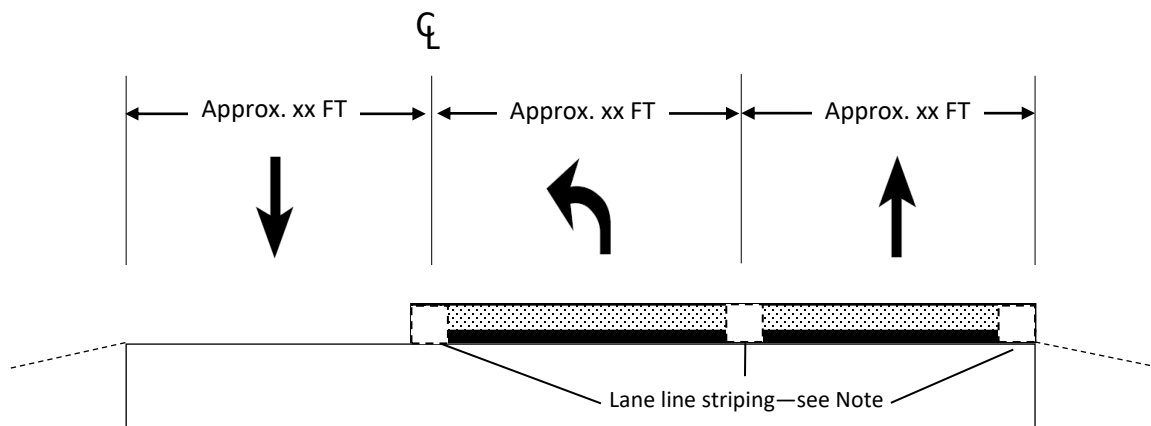

KY 1931 — ST ANDREWS CHURCH ROAD  
 5-960.00

COUNTY OF	ITEM NO.
JEFFERSON	5-960.00



**Approx. MP 4.356 — MP 4.403  
 EASTBOUND APPROACH**

**Note:** The HFST should extend to, but not over, the lane line striping and rumble strip. Protect the lane line striping and rumble strip in accordance with the Special Note for Polymer Concrete Overlay Systems.

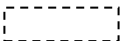
-  HFS Aggregate
-  Polymer Resin Binder
-  Lane Line Striping

N.T.S.

**TYPICAL SECTION**

**COMMONWEALTH OF KENTUCKY  
DEPARTMENT OF HIGHWAYS**

**JEFFERSON COUNTY**

KY 1931 — ST ANDREWS CHURCH ROAD  
5-960.00

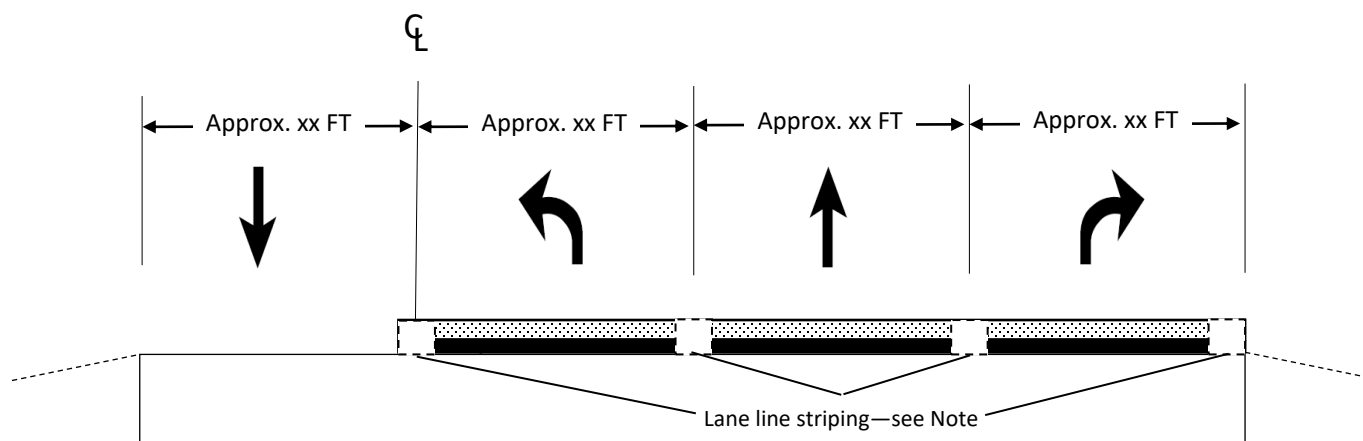

COUNTY OF	ITEM NO.
JEFFERSON	5-960.00



Approx. MP 4.415 — MP 4.463

**WESTBOUND APPROACH**

**Note:** The HFST should extend to, but not over, the lane line striping and rumble strip. Protect the lane line striping and rumble strip in accordance with the Special Note for Polymer Concrete Overlay Systems.

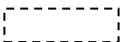
-  HFS Aggregate
-  Polymer Resin Binder
-  Lane Line Striping

**TYPICAL SECTION**

N.T.S.



# COMMONWEALTH OF KENTUCKY DEPARTMENT OF HIGHWAYS

## JEFFERSON COUNTY

KY 1931 — ST ANDREWS CHURCH RD  
5-960.00

COUNTY OF	ITEM NO.
JEFFERSON	5-960.00



**Notes:**

- The beginning and ending points shown on this detail are approximate. The intent is for the High Friction Surface (HFST) to be placed approximately at the following locations:  
 EB through lane—begin 240 feet prior to the stop bar, and end approximately 10 feet past the stop bar.  
 EB left turn lane—begin 90 feet prior to the stop bar, and end approximately 10 feet past the stop bar.  
 WB left turn lane—begin 90 feet prior to the stop bar, and end approximately 10 feet past the stop bar.  
 WB through lane—begin 240 feet prior to the stop bar, and end approximately 10 feet past the stop bar.  
 WB right turn lane—begin 90 feet prior to the stop bar, and end approximately 10 feet past the stop bar.
- HFST shall only be placed on pavement that is in relatively good condition. The Engineer shall determine if the pavement is in acceptable condition prior to installing a HFST. If in doubt, the Engineer may contact CO HSIP staff to determine if pavement conditions have deteriorated significantly since the HFST site was identified.
- The Engineer shall mark the beginning and ending points for the HFST in the field at the time of construction.

<b>Legend</b>
HFST Location 

DETAIL SHEET



# COMMONWEALTH OF KENTUCKY DEPARTMENT OF HIGHWAYS

## JEFFERSON COUNTY KY 1931 — MANSLICK ROAD 5-961.00

COUNTY OF	ITEM NO.
JEFFERSON	5-961.00

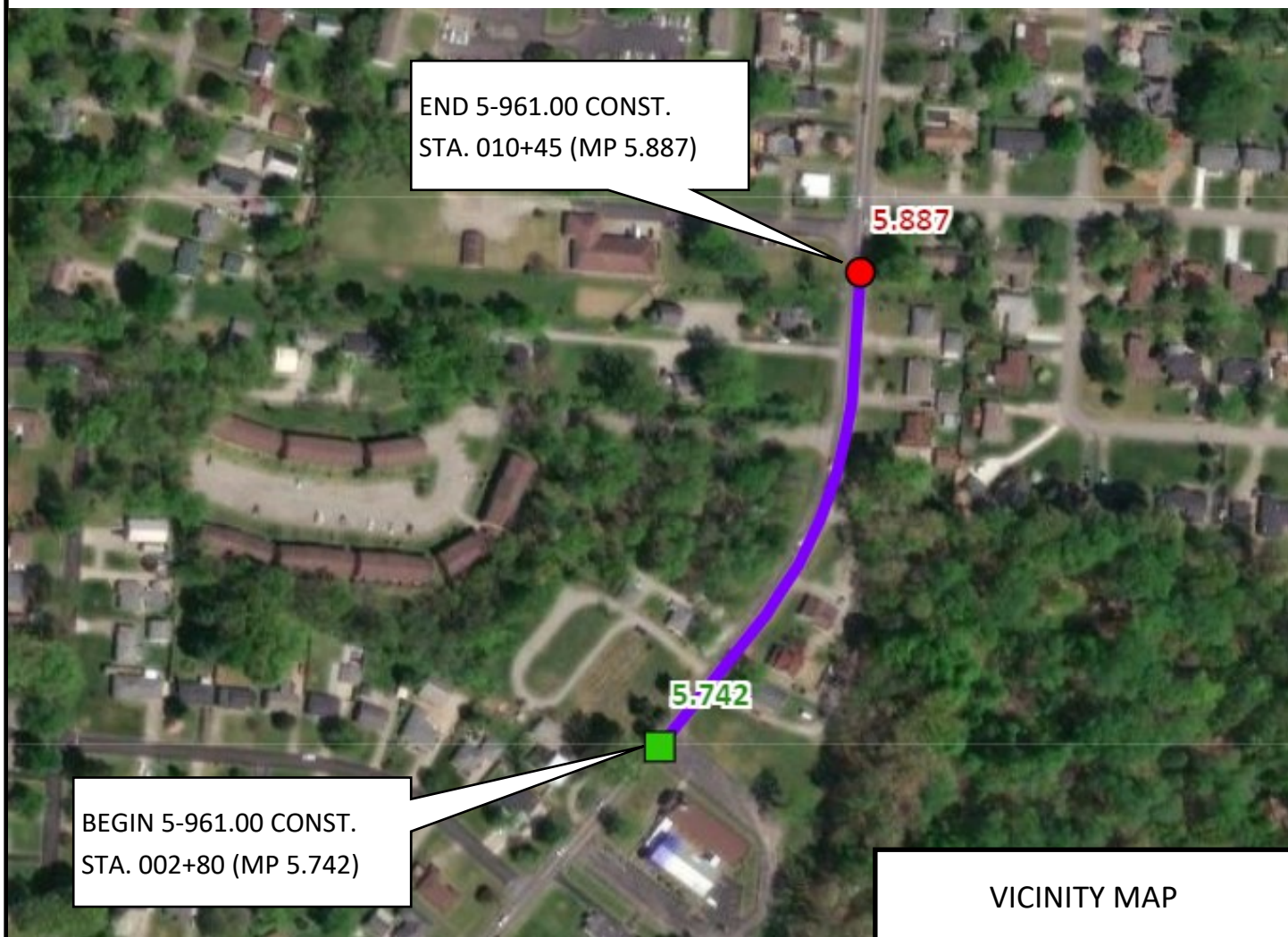
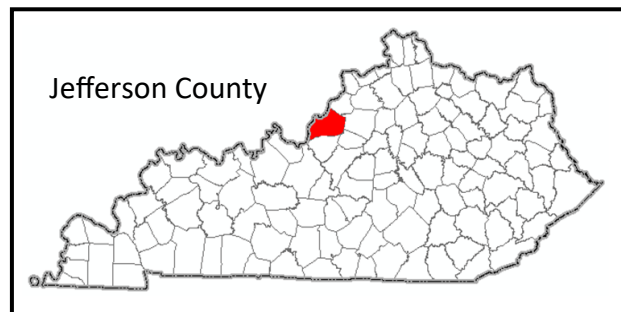
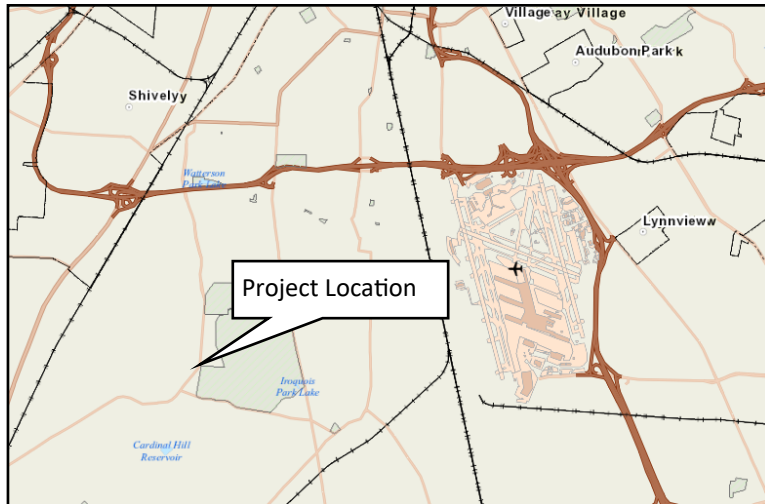

**COMMONWEALTH OF KENTUCKY**  
**DEPARTMENT OF HIGHWAYS**

**JEFFERSON COUNTY**  
KY 1931 — Manslick Road  
5-961.00

COUNTY OF	ITEM NO.
JEFFERSON	5-961.00

**GENERAL SUMMARY**

BID CODE	DESCRIPTION	UNITS	QTY
2562	TEMPORARY SIGNS	SQFT	150
2650	MAINTAIN AND CONTROL TRAFFIC	LS	1
2671	PORTABLE CHANGEABLE MESSAGE SIGN	EACH	2
23229EC	HIGH FRICTION SURFACE TREATMENT	SQYD	2,040
2569	DEMOBILIZATION	LS	1

GENERAL SUMMARY

# COMMONWEALTH OF KENTUCKY DEPARTMENT OF HIGHWAYS

JEFFERSON COUNTY  
KY 1931 — MANSLICK ROAD  
5-961.00

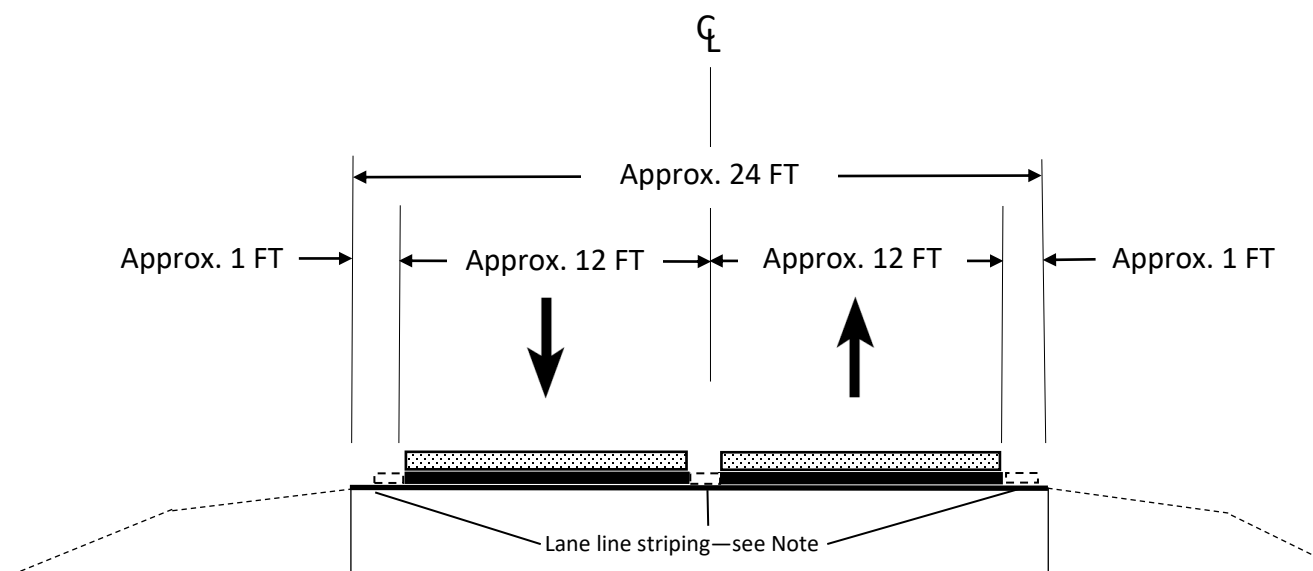

COUNTY OF	ITEM NO.
JEFFERSON	5-961.00



Approx. MP 5.742— MP 5.887

Both Directions

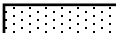
**Note:** The HFST should extend to, but not over, the lane line striping and rumble strip. Protect the lane line striping and rumble strip in accordance with the Special Note for Polymer Concrete Overlay Systems.

-  HFST Aggregate
-  Polymer Resin Binder
-  Lane Line Striping

TYPICAL SECTION

# COMMONWEALTH OF KENTUCKY DEPARTMENT OF HIGHWAYS

JEFFERSON COUNTY  
KY 1931 — MANSLICK ROAD  
5-961.00

COUNTY OF	ITEM NO.
JEFFERSON	5-961.00

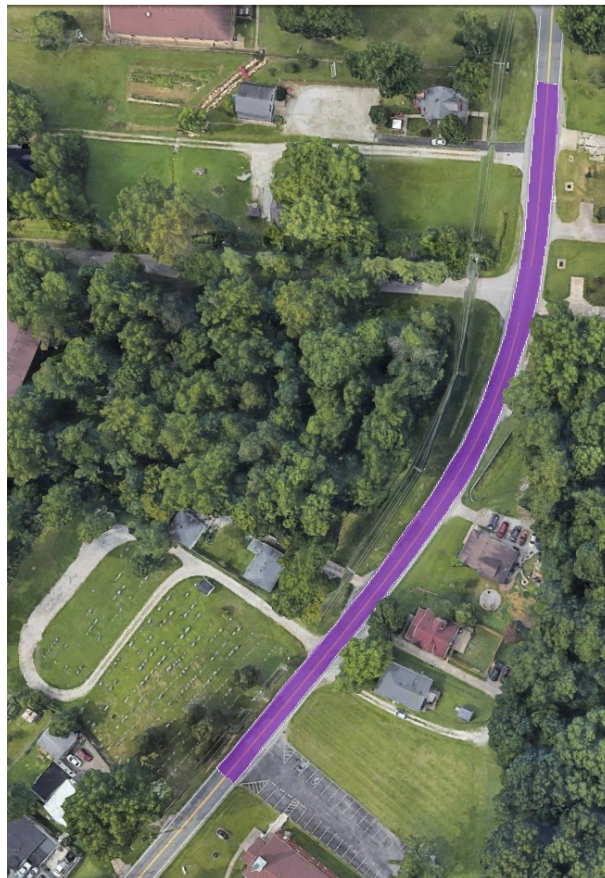

**Notes:**

- The beginning and ending points shown on this detail are approximate. The intent is for the High Friction Surface (HFST) to begin approximately 100 feet prior to the beginning of the curve, and end approximately 100 feet past the end of the curve. The beginning of the curve is at milepoint 5.761 and the end of the curve is at milepoint 5.868.
- HFST shall only be placed on pavement that is in relatively good condition. The Engineer shall determine if the pavement is in acceptable condition prior to installing a HFST. If in doubt, the Engineer may contact CO HSIP staff to determine if pavement conditions have deteriorated significantly since the HFST site was identified.
- The Engineer shall mark the beginning and ending points for the HFST in the field at the time of construction.

**Legend**

HFST Location 

DETAIL SHEET



# COMMONWEALTH OF KENTUCKY DEPARTMENT OF HIGHWAYS

## JEFFERSON COUNTY

KY 864 — POPLAR LEVEL ROAD  
5-9036.00

COUNTY OF

ITEM NO.

JEFFERSON

5-9036.00

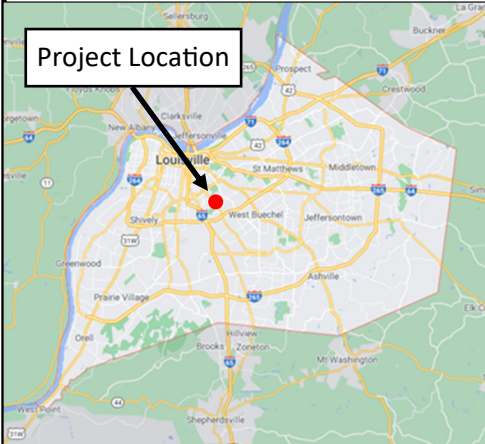

Jefferson County

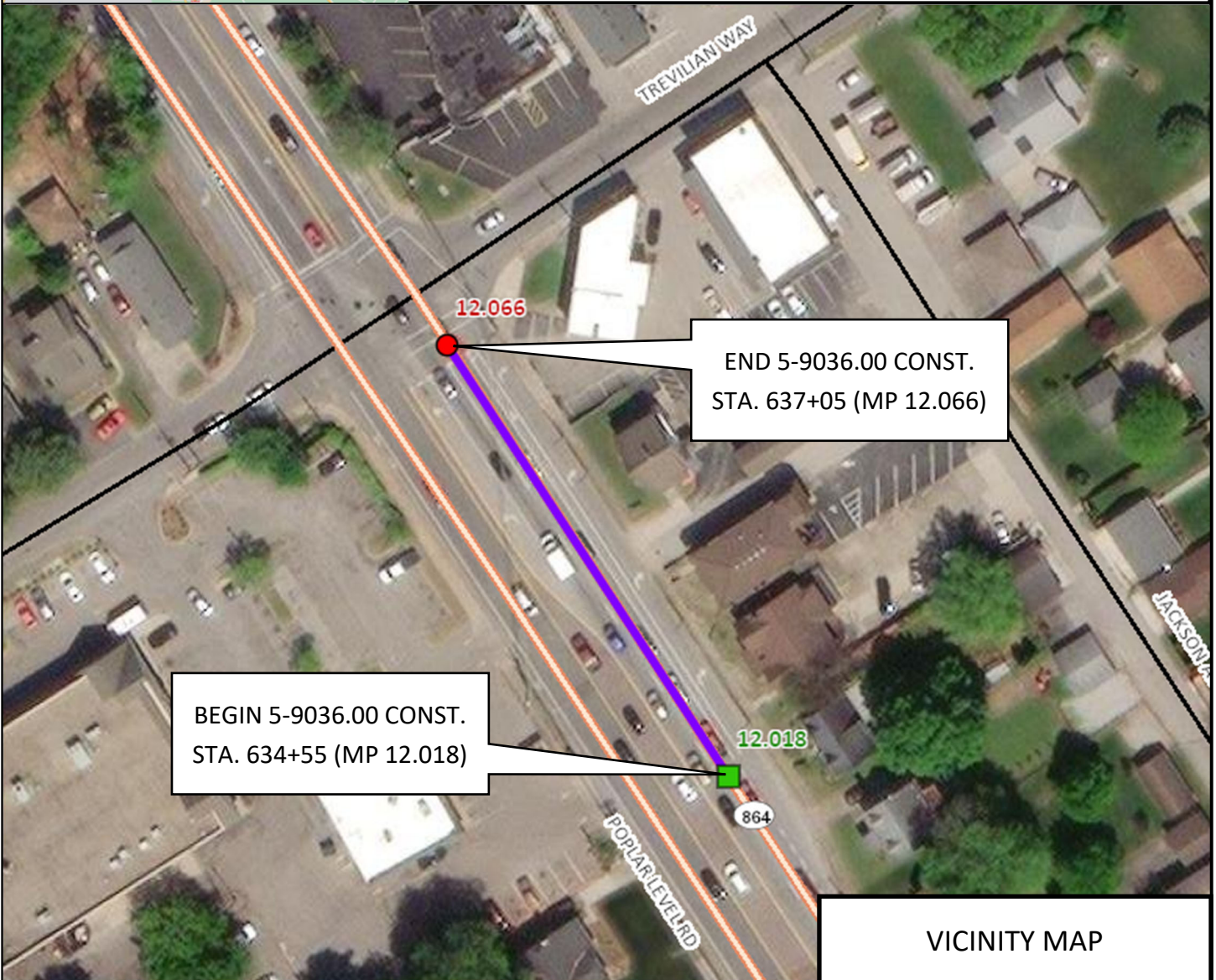
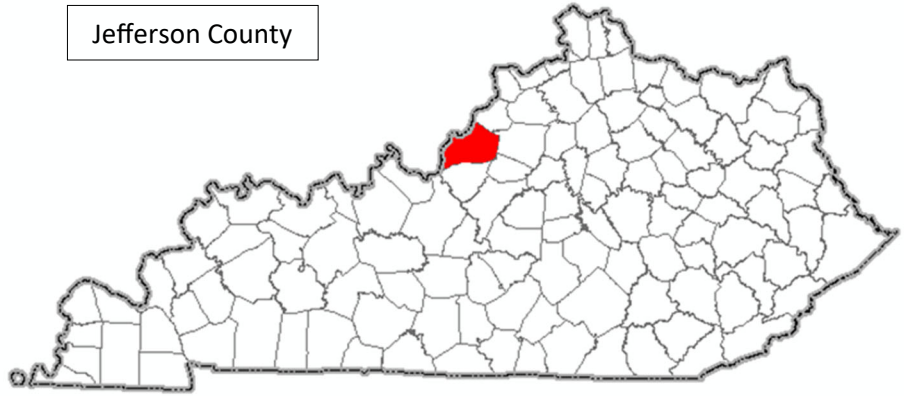

VICINITY MAP

**COMMONWEALTH OF KENTUCKY  
DEPARTMENT OF HIGHWAYS**

**JEFFERSON COUNTY**  
KY 864 (Poplar Level Road)  
5-9036.00

COUNTY OF	ITEM NO.
JEFFERSON	5-9036.00

**GENERAL SUMMARY**

BID CODE	DESCRIPTION	UNIT	QTY
2562	TEMPORARY SIGNS	SQFT	200
2650	MAINTAIN AND CONTROL TRAFFIC	LS	1
2671	PORTABLE CHANGEABLE MESSAGE SIGN	EACH	2
2775	ARROW PANEL	EACH	2
6568	PAVE MARKING-THERMO STOP BAR-24 IN	LF	22
6598	PAVE MARKING REMOVAL	SQFT	44
20099ES842	PAVE MARK TEMP PAINT STOP BAR	LF	22
23229EC	HIGH FRICTION SURFACE TREATMENT	SQYD	611
2569	DEMOBILIZATION	LS	1

GENERAL SUMMARY

**COMMONWEALTH OF KENTUCKY  
DEPARTMENT OF HIGHWAYS**

**JEFFERSON COUNTY**  
KY 864 (Poplar Level Road)  
5-9036.00

COUNTY OF	ITEM NO.
JEFFERSON	5-9036.00

**PAVEMENT MARKING SUMMARY**

Station		Length (LF)	PAVEMENT MARKINGS			Notes
Begin	End		Stop Bar	Pave Marking	Removal	
			(LF)	(SQFT)		
636+95			22	44		NB
Total			22	44		

**HIGH FRICTION SURFACE TREATMENT SUMMARY**

Station		Length (FT)	Width (FT)	Area (SQYD)	Notes
Begin	End				
634+55	637+05	250	22	611	NB
Total				611	

BID CODE	DESCRIPTION	UNIT	QTY
6568	PAVE MARKING-THERMO STOP BAR-24 IN	LF	22
6598	PAVE MARKING REMOVAL	SQFT	44
20099ES842	PAVE MARK TEMP PAINT STOP BAR	LF	22
23229EC	HIGH FRICTION SURFACE TREATMENT	SQYD	611

PAVEMENT MARKING  
& HFST SUMMARY

**COMMONWEALTH OF KENTUCKY  
DEPARTMENT OF HIGHWAYS**



**JEFFERSON COUNTY**

KY 864 — POPLAR LEVEL ROAD  
5-9036.00

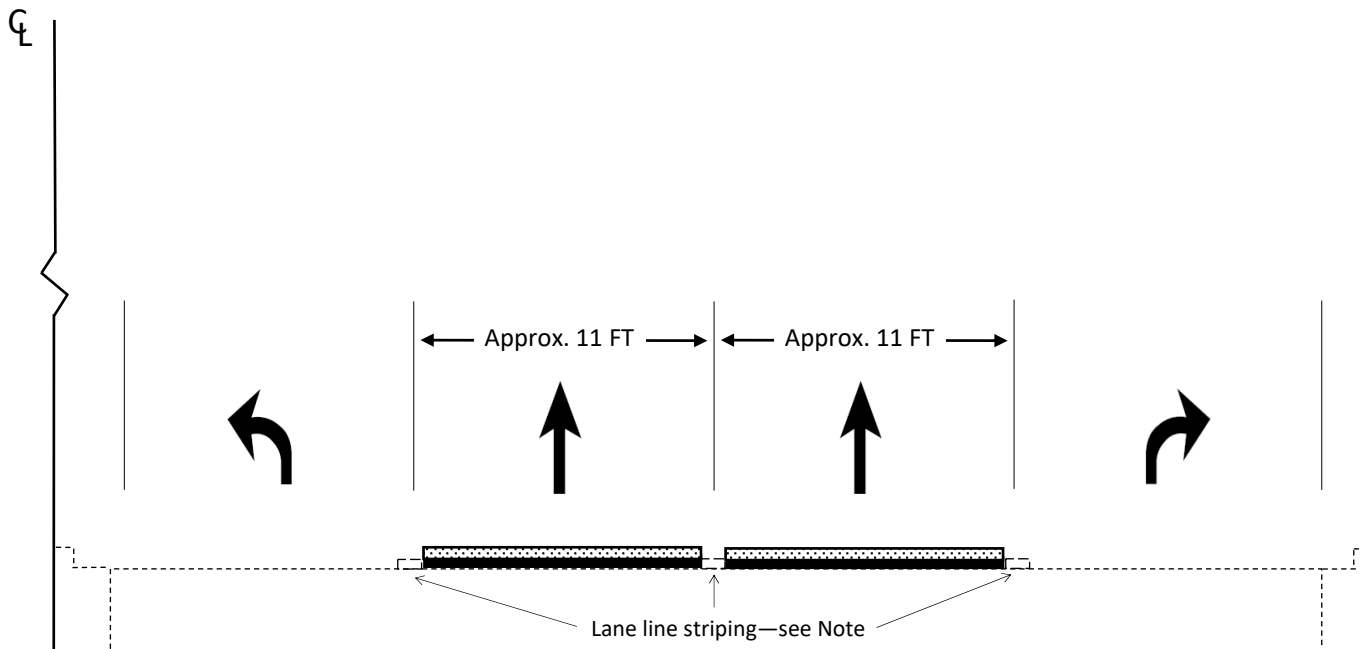
COUNTY OF	ITEM NO.
JEFFERSON	5-9036.00

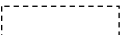

**Northbound Lanes—Approx. MP 12.018 — MP 12.066**

-  HFS Aggregate
-  Polymer Resin Binder
-  Centerline/Edgeline Striping/Rumble Strip

**Note:** The HFST should extend to, but not over, the lane line striping and/or rumble strip. Protect the lane line striping and/or rumble strip in accordance with the Special Note for Polymer Concrete Overlay Systems.

N.T.S.

**TYPICAL SECTION**



# COMMONWEALTH OF KENTUCKY DEPARTMENT OF HIGHWAYS

## JEFFERSON COUNTY

KY 864 — POPLAR LEVEL ROAD  
5-9036.00

COUNTY OF

ITEM NO.

JEFFERSON

5-9036.00



### Notes:

- The beginning and ending points shown on this detail are approximate. The intent is for the High Friction Surface (HFST) to begin approximately 240 feet prior to the centerline of the stop bar and end approximately 10 feet past the centerline of the stop bar.
- HFST shall only be placed on pavement that is in relatively good condition. The Engineer shall determine if the pavement is in acceptable condition prior to installing a HFST. If in doubt, the Engineer may contact CO HSIP staff to determine if pavement conditions have deteriorated significantly since the HFST site was identified.
- The Engineer shall mark the beginning and ending points for the HFST in the field at the time of construction.

### Legend

HFST Location 

DETAIL SHEET



# COMMONWEALTH OF KENTUCKY DEPARTMENT OF HIGHWAYS

## JEFFERSON COUNTY

KY 907 — SOUTHSIDE DRIVE  
5-9037.00

COUNTY OF	ITEM NO.
JEFFERSON	5-9037.00

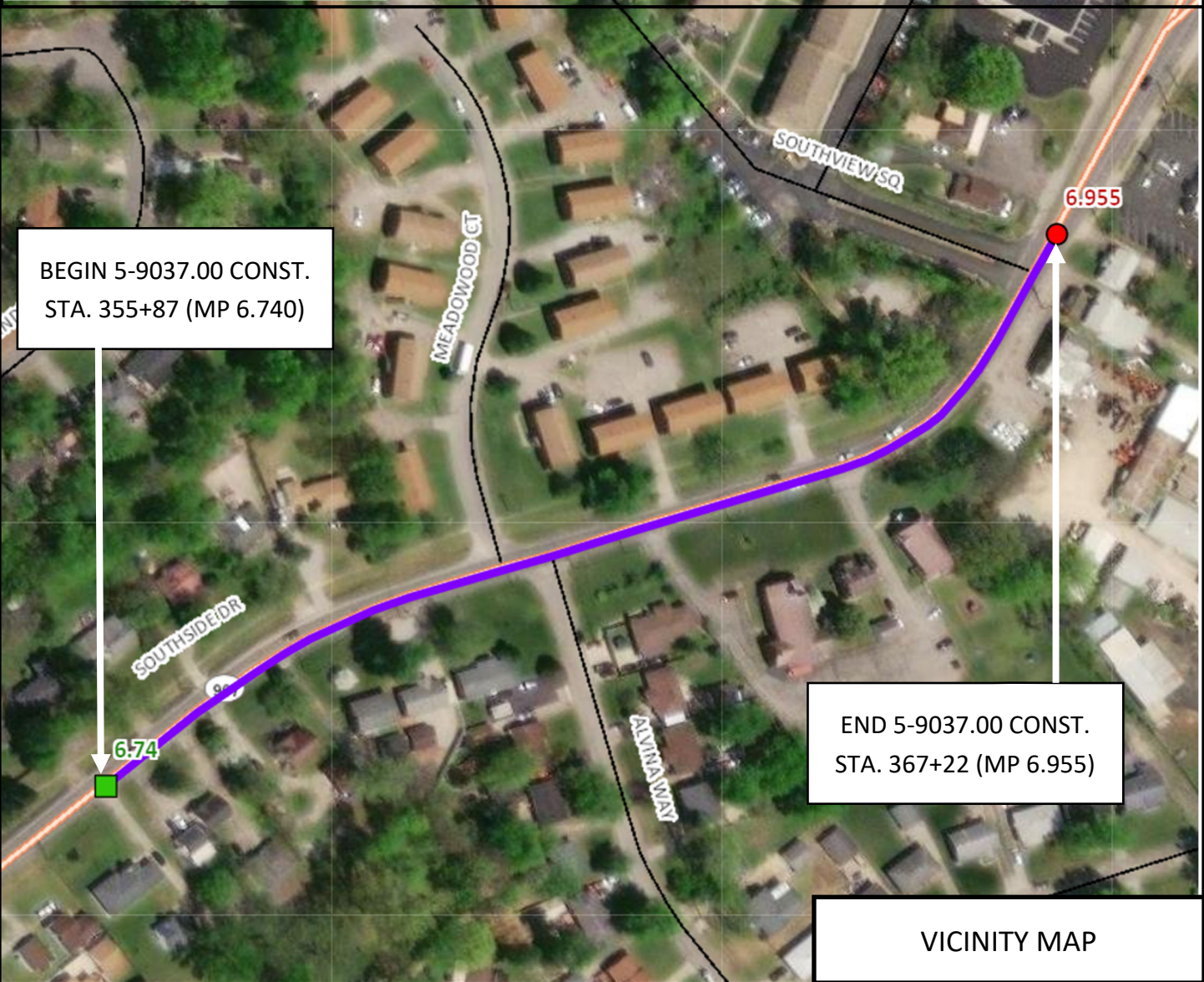
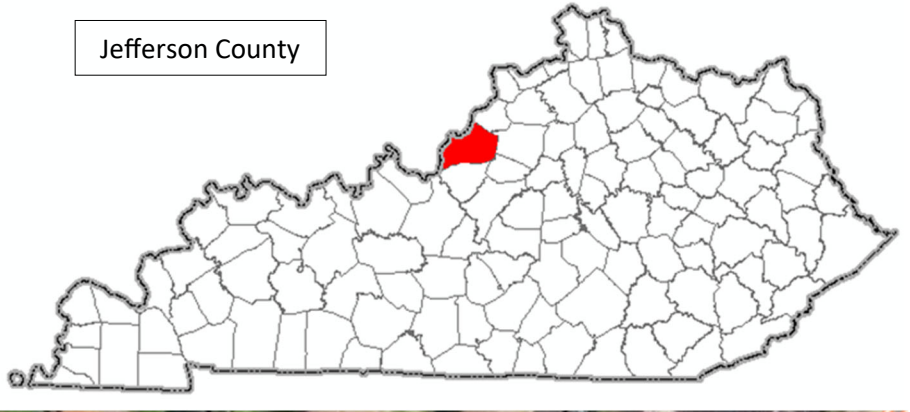
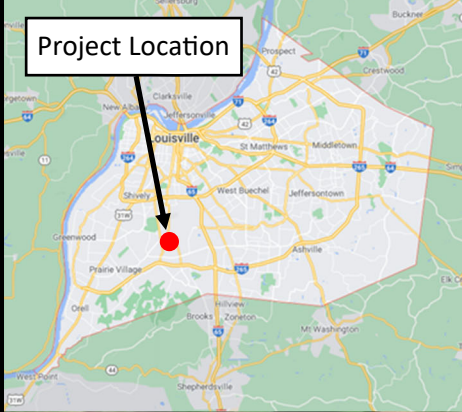

**COMMONWEALTH OF KENTUCKY**  
**DEPARTMENT OF HIGHWAYS**  
**JEFFERSON COUNTY**  
KY 907 — SOUTHSIDE DRIVE  
5-9037.00

COUNTY OF	ITEM NO.
JEFFERSON	5-9037.00

**GENERAL SUMMARY**

BID CODE	DESCRIPTION	UNITS	QTY
2562	TEMPORARY SIGNS	SQFT	200
2650	MAINTAIN AND CONTROL TRAFFIC	LS	1
2671	PORTABLE CHANGEABLE MESSAGE SIGN	EACH	2
23229EC	HIGH FRICTION SURFACE TREATMENT	SQYD	2,647
2569	DEMOBILIZATION	LS	1

GENERAL SUMMARY



# COMMONWEALTH OF KENTUCKY DEPARTMENT OF HIGHWAYS

JEFFERSON COUNTY  
KY 907 — SOUTHSIDE DRIVE  
5-9037.00

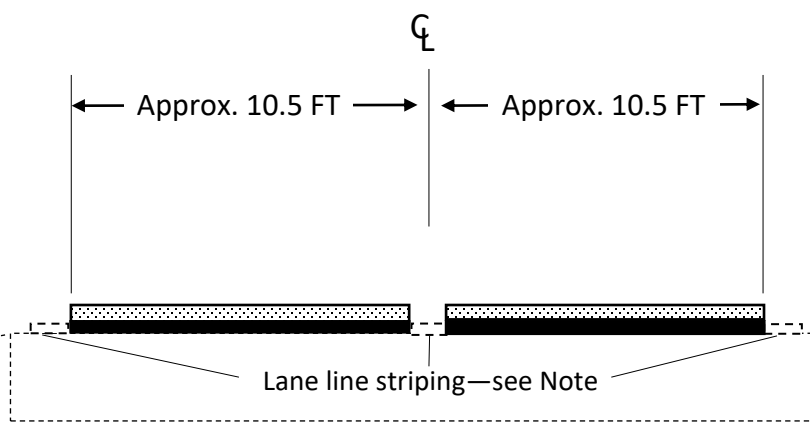
COUNTY OF	ITEM NO.
JEFFERSON	5-9037.00



Approx. MP 6.740 —MP 6.955

-  HFS Aggregate
-  Polymer Resin Binder
-  Centerline/Edgeline Striping/Rumble Strip

**Note:** The HFST should extend to, but not over, the lane line striping and/or rumble strip. Protect the lane line striping and/or rumble strip in accordance with the Special Note for Polymer Concrete Overlay Systems.

N.T.S.

**TYPICAL SECTION**



# COMMONWEALTH OF KENTUCKY DEPARTMENT OF HIGHWAYS

JEFFERSON COUNTY  
KY 907 — SOUTHSIDE DRIVE  
05-9037.00

COUNTY OF	ITEM NO.
JEFFERSON	05-9037.00



BEGIN 5-9037.00 CONST.  
STA. 355+87 (MP 6.740)

END 5-9037.00 CONST.  
STA. 367+22 (MP 6.955)

**Notes:**

- The beginning and ending points shown on this detail are approximate. The intent is for the High Friction Surface (HFST) to begin approximately 160 feet past the intersection of Southside Drive (KY 907) and Woodmore Avenue, and end approximately 50 feet past the intersection of Southside Drive (KY 907) and Southview Square. Distances shall be measured from the centerline of each intersection.
- HFST shall only be placed on pavement that is in relatively good condition. The Engineer shall determine if the pavement is in acceptable condition prior to installing a HFST. If in doubt, the Engineer may contact CO HSIP staff to determine if pavement conditions have deteriorated significantly since the HFST site was identified.
- The Engineer shall mark the beginning and ending points for the HFST in the field at the time of construction.

**Legend**

HFST Location 

DETAIL SHEET



# COMMONWEALTH OF KENTUCKY DEPARTMENT OF HIGHWAYS

COUNTY OF	ITEM NO.
JEFFERSON	5-9042.00

**JEFFERSON COUNTY**  
US 60A—Eastern Parkway  
5-9042.00

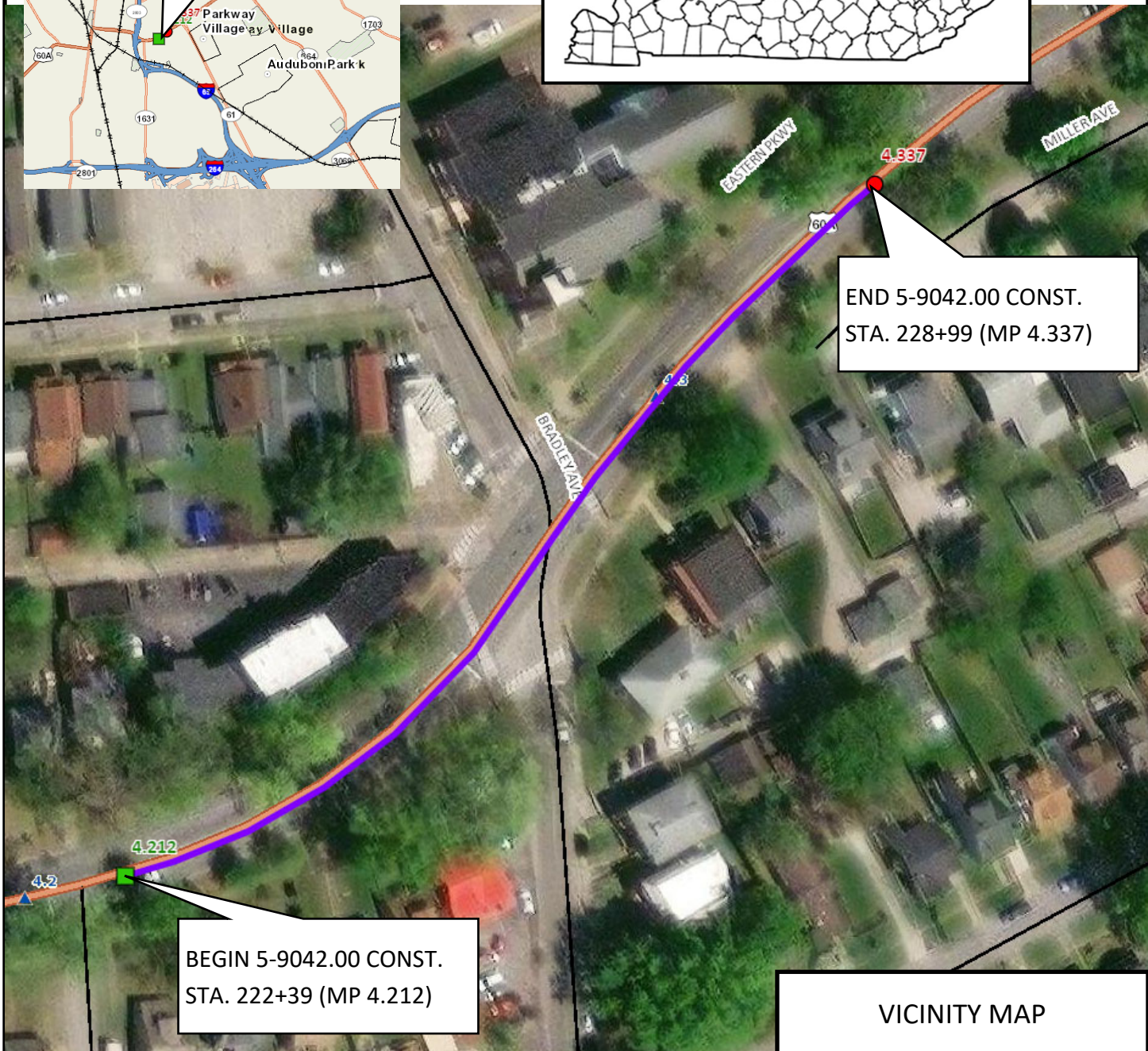
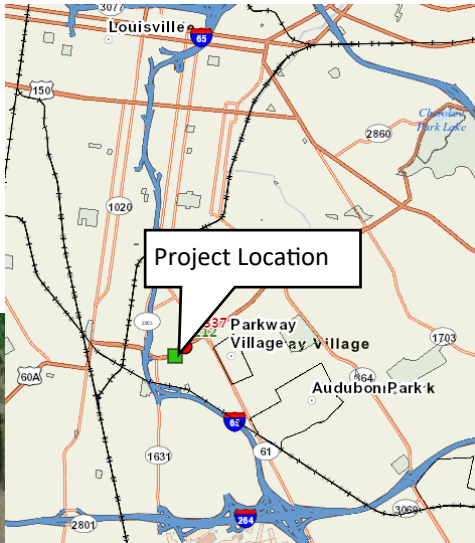

END 5-9042.00 CONST.  
STA. 228+99 (MP 4.337)

BEGIN 5-9042.00 CONST.  
STA. 222+39 (MP 4.212)

VICINITY MAP

**COMMONWEALTH OF KENTUCKY  
DEPARTMENT OF HIGHWAYS**

**JEFFERSON COUNTY**  
Eastern Parkway (US 60A)  
5-9042.00

COUNTY OF	ITEM NO.
JEFFERSON	5-9042.00

**GENERAL SUMMARY**

BID CODE	DESCRIPTION	UNIT	QTY
2562	TEMPORARY SIGNS	SQFT	150
2650	MAINTAIN AND CONTROL TRAFFIC	LS	1
2671	PORTABLE CHANGEABLE MESSAGE SIGN	EACH	2
2775	ARROW PANEL	EACH	2
6568	PAVE MARKING-THERMO STOP BAR-24 IN	LF	48
6598	PAVE MARKING REMOVAL	SQFT	96
20099ES842	PAVE MARK TEMP PAINT STOP BAR	LF	48
23229EC	HIGH FRICTION SURFACE TREATMENT	SQYD	1,338
2569	DEMOBILIZATION	LS	1

GENERAL SUMMARY

**COMMONWEALTH OF KENTUCKY  
DEPARTMENT OF HIGHWAYS**

**JEFFERSON COUNTY**  
Eastern Parkway (US 60A)

COUNTY OF	ITEM NO.
JEFFERSON	5-9042.00

**PAVEMENT MARKING SUMMARY**

Station		Length (LF)	PAVEMENT MARKINGS			Notes
Begin	End		Stop Bar	Curved Arrow	Comb. Arrow	
			(LF)	(EACH)	(EACH)	
037+86			24			2 EB Lanes
039+12			24			2 WB Lanes
		Total	48	0	0	

**HIGH FRICTION SURFACE TREATMENT SUMMARY**

Station		Length (FT)	Width (FT)	Area (SQYD)	Notes
Begin	End				
222+39	224+93	253	24	676	2 EB Lanes
226+51	228+99	248	24	662	2 WB Lanes
			Total	1,338	

BID CODE	DESCRIPTION	UNIT	QTY
6568	PAVE MARKING-THERMO STOP BAR-24 IN	LF	48
6598	PAVE MARKING REMOVAL	SQFT	96
20099ES842	PAVE MARK TEMP PAINT STOP BAR	LF	48
23229EC	HIGH FRICTION SURFACE TREATMENT	SQYD	1,338

PAVEMENT MARKING  
& HFST SUMMARY



# COMMONWEALTH OF KENTUCKY DEPARTMENT OF HIGHWAYS



## JEFFERSON COUNTY

US 60A — EASTERN PARKWAY  
5-9042.00

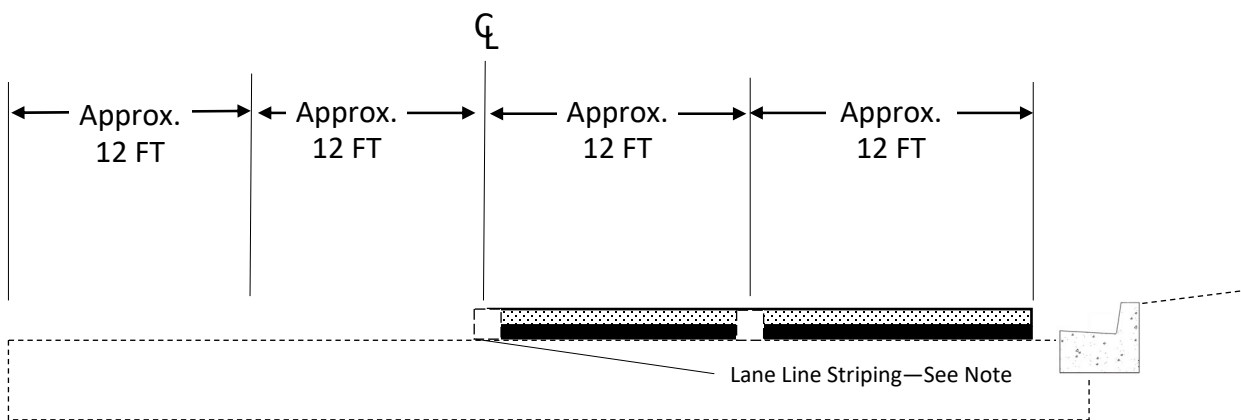
COUNTY OF	ITEM NO.
JEFFERSON	5-9042.00

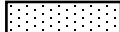

Approx. MP 4.212—4.337

-  HFS Aggregate
-  Polymer Resin Binder
-  Centerline/Edgeline Striping/Rumble Strip

**Note:** The HFST should extend to, but not over, the lane line striping and/or rumble strip. Protect the lane line striping and/or rumble strip in accordance with the Special Note for Polymer Concrete Overlay Systems.

N.T.S.

**TYPICAL SECTION**

# COMMONWEALTH OF KENTUCKY DEPARTMENT OF HIGHWAYS

**JEFFERSON COUNTY**  
US 60A — Eastern Parkway  
5-9042.00

COUNTY OF	ITEM NO.
JEFFERSON	5-9042.00



END 5-9042.00 CONST.  
STA. 228+99 (MP 4.337)

BEGIN 5-9042.00 CONST.  
STA. 222+39 (MP 4.212)

- Notes:
- The beginning and ending points shown on this detail are approximate. The intent is for the High Friction Surface (HFST) to begin approximately 250 feet prior to the stop bar, and end approximately 10 feet past the stop bar in the eastbound and westbound directions.
  - HFST shall only be placed on pavement that is in relatively good condition. The Engineer shall determine if the pavement is in acceptable condition prior to installing a HFST. If in doubt, the Engineer may contact CO HSIP staff to determine if pavement conditions have deteriorated significantly since the HFST site was identified.
  - The Engineer shall mark the beginning and ending points for the HFST in the field at the time of construction.

**Legend**

HFST Location 

DETAIL SHEET



# COMMONWEALTH OF KENTUCKY DEPARTMENT OF HIGHWAYS

## OLDHAM COUNTY

US 42  
5-9043.00

COUNTY OF	ITEM NO.
OLDHAM	5-9043.00

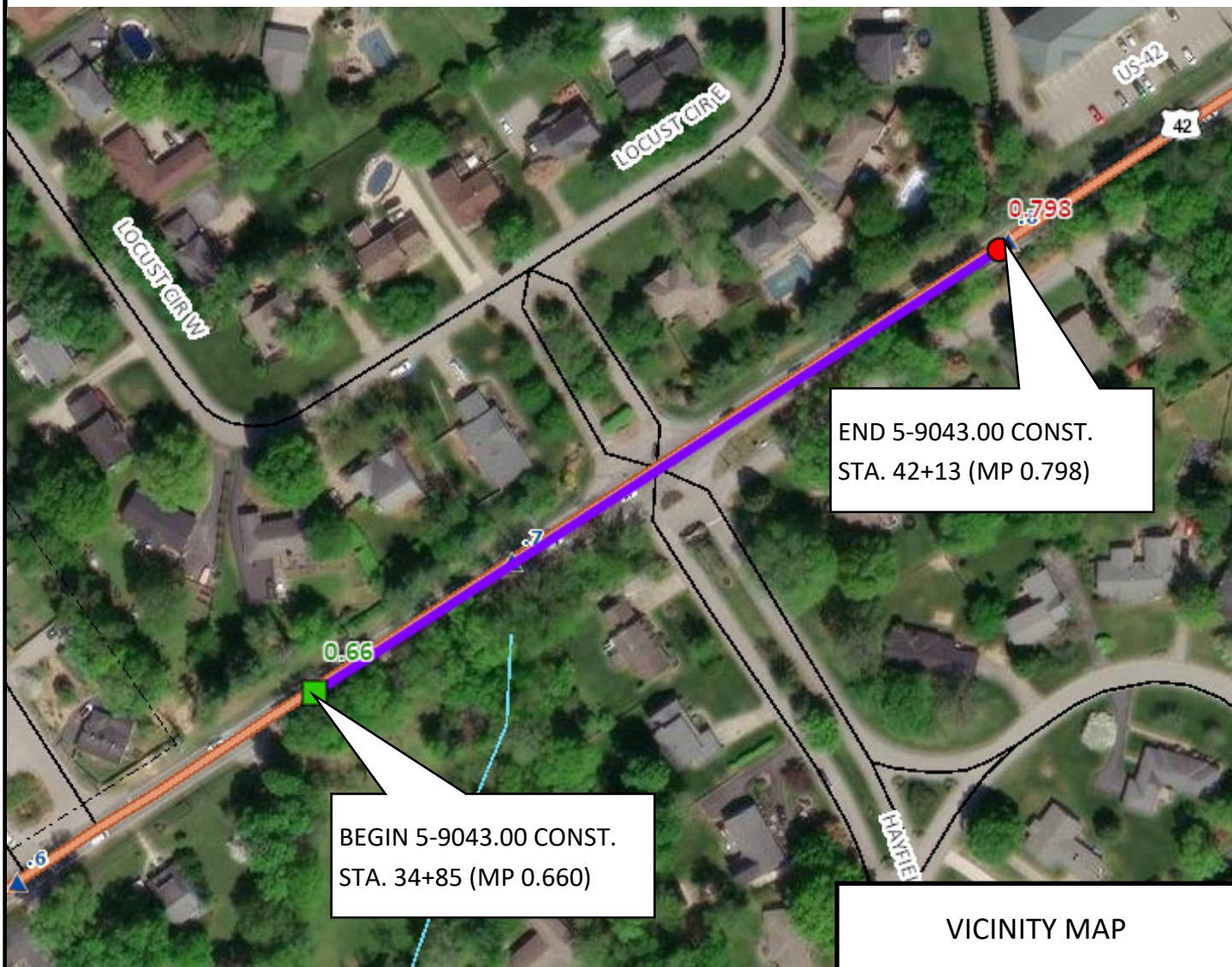
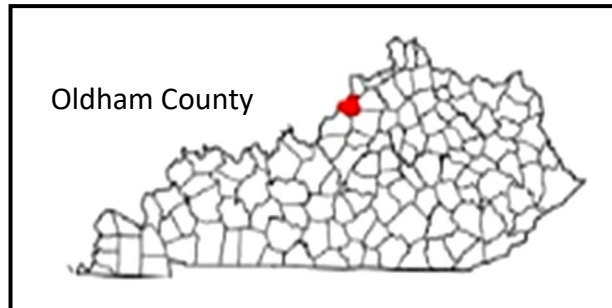
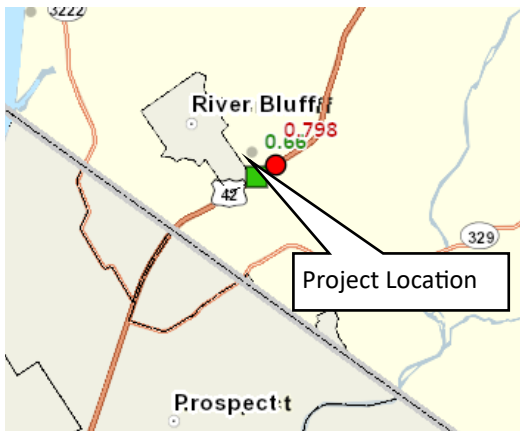

**COMMONWEALTH OF KENTUCKY**  
**DEPARTMENT OF HIGHWAYS**  
**OLDHAM COUNTY**  
 US 42  
 5-9043.00

COUNTY OF	ITEM NO.
OLDHAM	5-9043.00

**GENERAL SUMMARY**

BID CODE	DESCRIPTION	UNIT	QTY
2562	TEMPORARY SIGNS	SQFT	150
2650	MAINTAIN AND CONTROL TRAFFIC	LS	1
2671	PORTABLE CHANGEABLE MESSAGE SIGN	EACH	2
2775	ARROW PANEL	EACH	2
6568	PAVE MARKING-THERMO STOP BAR-24 IN	LF	24
6598	PAVE MARKING REMOVAL	SQFT	48
20099ES842	PAVE MARK TEMP PAINT STOP BAR	LF	24
23229EC	HIGH FRICTION SURFACE TREATMENT	SQYD	829
2569	DEMOBILIZATION	LS	1

GENERAL SUMMARY

**COMMONWEALTH OF KENTUCKY  
DEPARTMENT OF HIGHWAYS  
OLDHAM COUNTY  
US 42**

COUNTY OF	ITEM NO.
OLDHAM	5-9043.00

**PAVEMENT MARKING SUMMARY**

Station		Length (LF)	PAVEMENT MARKINGS			Notes
Begin	End		Stop Bar	Curved Arrow	Comb. Arrow	
			(LF)	(EACH)	(EACH)	
037+86			12			EB Lane
039+12			12			WB Lane
		Total	24	0	0	

**HIGH FRICTION SURFACE TREATMENT SUMMARY**

Station		Length (FT)	Width (FT)	Area (SQYD)	Notes
Begin	End				
034+85	037+96	311	12	415	EB Lane
039+02	042+13	311	12	415	WB Lane
		Total		829	

BID CODE	DESCRIPTION	UNIT	QTY
6568	PAVE MARKING-THERMO STOP BAR-24 IN	LF	24
6598	PAVE MARKING REMOVAL	SQFT	48
20099ES842	PAVE MARK TEMP PAINT STOP BAR	LF	24
23229EC	HIGH FRICTION SURFACE TREATMENT	SQYD	829

PAVEMENT MARKING  
& HFST SUMMARY

**COMMONWEALTH OF KENTUCKY  
DEPARTMENT OF HIGHWAYS**

COUNTY OF	ITEM NO.
OLDHAM	5-9043.00

**OLDHAM COUNTY**

US 42  
5-9043.00

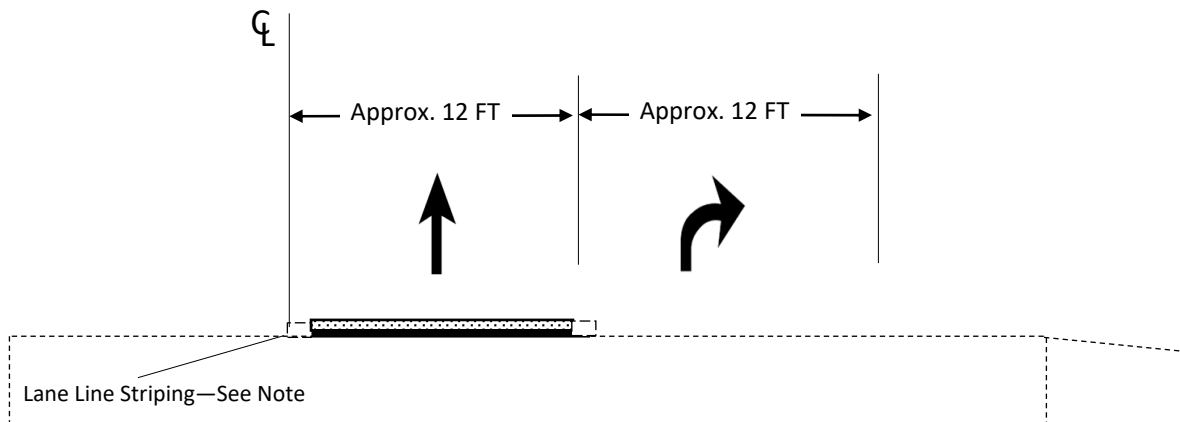

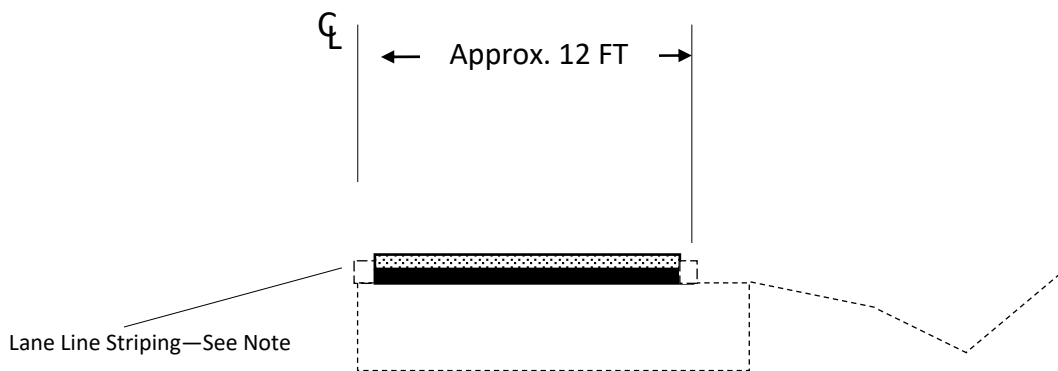

**Approx. MP 0.66 — MP 0.719**



**Approx. MP 0.739 — MP 0.798**

**Note:** The HFST should extend to, but not over, the lane line striping and/or rumble strip. Protect the lane line striping and/or rumble strip in accordance with the Special Note for Polymer Concrete Overlay Systems.

-  HFS Aggregate
-  Polymer Resin Binder
-  Centerline/Edgeline Striping/Rumble Strip

**TYPICAL SECTION**

N.T.S.



# COMMONWEALTH OF KENTUCKY DEPARTMENT OF HIGHWAYS

## OLDHAM COUNTY

US 42  
5-9043.00

COUNTY OF	ITEM NO.
OLDHAM	5-9043.00



**Notes:**

- The beginning and ending points shown on this detail are approximate. The intent is for the High Friction Surface (HFST) to begin approximately 300 feet prior to the stop bar, and end 10' beyond the stop bar along US 42 through lanes.
- HFST shall only be placed on pavement that is in relatively good condition. The Engineer shall determine if the pavement is in acceptable condition prior to installing a HFST. If in doubt, the Engineer may contact CO HSIP staff to determine if pavement conditions have deteriorated significantly since the HFST site was identified.
- The Engineer shall mark the beginning and ending points for the HFST in the field at the time of construction.

**Legend**

HFST Location 

DETAIL SHEET

## **PART II**

### **SPECIFICATIONS AND STANDARD DRAWINGS**



### **STANDARD SPECIFICATIONS**

Any reference in the plans or proposal to previous editions of the *Standard Specifications for Road and Bridge Construction* and *Standard Drawings* are superseded by *Standard Specifications for Road and Bridge Construction, Edition of 2019* and *Standard Drawings, Edition of 2020*.

### **SUPPLEMENTAL SPECIFICATIONS**

The contractor shall use the Supplemental Specifications that are effective at the time of letting. The Supplemental Specifications can be found at the following link:  
<http://transportation.ky.gov/Construction/Pages/Kentucky-Standard-Specifications.aspx>

## 2020 STANDARD DRAWINGS THAT APPLY

---

*~ TEMPORARY ~*  
TRAFFIC CONTROL

LANE CLOSURE TWO-LANE HIGHWAY .....	TTC-100-05
LANE CLOSURE MULTI-LANE HIGHWAY CASE.....	TTC-115-04
SHOULDER CLOSURE.....	TTC-135-03

DEVICES

PAVEMENT CONDITION WARNING SIGNS.....	TTD-125-03
---------------------------------------	------------

STRIPING OPERATIONS

MOBILE OPERATION FOR PAINT STRIPING CASE I.....	TTS-100-02
MOBILE OPERATION FOR PAINT STRIPING CASE II .....	TTS-105-02

## **PART III**

### **EMPLOYMENT, WAGE AND RECORD REQUIREMENTS**

FHWA-1273 – Revised October 23, 2023

**REQUIRED CONTRACT PROVISIONS  
FEDERAL-AID CONSTRUCTION CONTRACTS**

- I. General
- II. Nondiscrimination
- III. Non-segregated Facilities
- IV. Davis-Bacon and Related Act Provisions
- V. Contract Work Hours and Safety Standards Act Provisions
- VI. Subletting or Assigning the Contract
- VII. Safety: Accident Prevention
- VIII. False Statements Concerning Highway Projects
- IX. Implementation of Clean Air Act and Federal Water Pollution Control Act
- X. Certification Regarding Debarment, Suspension, Ineligibility and Voluntary Exclusion
- XI. Certification Regarding Use of Contract Funds for Lobbying
- XII. Use of United States-Flag Vessels:

**ATTACHMENTS**

A. Employment and Materials Preference for Appalachian Development Highway System or Appalachian Local Access Road Contracts (included in Appalachian contracts only)

**I. GENERAL**

1. Form FHWA-1273 must be physically incorporated in each construction contract funded under title 23, United States Code, as required in 23 CFR 633.102(b) (excluding emergency contracts solely intended for debris removal). The contractor (or subcontractor) must insert this form in each subcontract and further require its inclusion in all lower tier subcontracts (excluding purchase orders, rental agreements and other agreements for supplies or services). 23 CFR 633.102(e).

The applicable requirements of Form FHWA-1273 are incorporated by reference for work done under any purchase order, rental agreement or agreement for other services. The prime contractor shall be responsible for compliance by any subcontractor, lower-tier subcontractor or service provider. 23 CFR 633.102(e).

Form FHWA-1273 must be included in all Federal-aid design-build contracts, in all subcontracts and in lower tier subcontracts (excluding subcontracts for design services, purchase orders, rental agreements and other agreements for supplies or services) in accordance with 23 CFR 633.102. The design-builder shall be responsible for compliance by any subcontractor, lower-tier subcontractor or service provider.

Contracting agencies may reference Form FHWA-1273 in solicitation-for-bids or request-for-proposals documents, however, the Form FHWA-1273 must be physically incorporated (not referenced) in all contracts, subcontracts and lower-tier subcontracts (excluding purchase orders, rental agreements and other agreements for supplies or services related to a construction contract). 23 CFR 633.102(b).

2. Subject to the applicability criteria noted in the following sections, these contract provisions shall apply to all work

performed on the contract by the contractor's own organization and with the assistance of workers under the contractor's immediate superintendence and to all work performed on the contract by piecework, station work, or by subcontract. 23 CFR 633.102(d).

3. A breach of any of the stipulations contained in these Required Contract Provisions may be sufficient grounds for withholding of progress payments, withholding of final payment, termination of the contract, suspension / debarment or any other action determined to be appropriate by the contracting agency and FHWA.

4. Selection of Labor: During the performance of this contract, the contractor shall not use convict labor for any purpose within the limits of a construction project on a Federal-aid highway unless it is labor performed by convicts who are on parole, supervised release, or probation. 23 U.S.C. 114(b). The term Federal-aid highway does not include roadways functionally classified as local roads or rural minor collectors. 23 U.S.C. 101(a).

**II. NONDISCRIMINATION (23 CFR 230.107(a); 23 CFR Part 230, Subpart A, Appendix A; EO 11246)**

The provisions of this section related to 23 CFR Part 230, Subpart A, Appendix A are applicable to all Federal-aid construction contracts and to all related construction subcontracts of \$10,000 or more. The provisions of 23 CFR Part 230 are not applicable to material supply, engineering, or architectural service contracts.

In addition, the contractor and all subcontractors must comply with the following policies: Executive Order 11246, 41 CFR Part 60, 29 CFR Parts 1625-1627, 23 U.S.C. 140, Section 504 of the Rehabilitation Act of 1973, as amended (29 U.S.C. 794), Title VI of the Civil Rights Act of 1964, as amended (42 U.S.C. 2000d et seq.), and related regulations including 49 CFR Parts 21, 26, and 27; and 23 CFR Parts 200, 230, and 633.

The contractor and all subcontractors must comply with: the requirements of the Equal Opportunity Clause in 41 CFR 60-1.4(b) and, for all construction contracts exceeding \$10,000, the Standard Federal Equal Employment Opportunity Construction Contract Specifications in 41 CFR 60-4.3.

Note: The U.S. Department of Labor has exclusive authority to determine compliance with Executive Order 11246 and the policies of the Secretary of Labor including 41 CFR Part 60, and 29 CFR Parts 1625-1627. The contracting agency and the FHWA have the authority and the responsibility to ensure compliance with 23 U.S.C. 140, Section 504 of the Rehabilitation Act of 1973, as amended (29 U.S.C. 794), and Title VI of the Civil Rights Act of 1964, as amended (42 U.S.C. 2000d et seq.), and related regulations including 49 CFR Parts 21, 26, and 27; and 23 CFR Parts 200, 230, and 633.

The following provision is adopted from 23 CFR Part 230, Subpart A, Appendix A, with appropriate revisions to conform to the U.S. Department of Labor (US DOL) and FHWA requirements.

**1. Equal Employment Opportunity:** Equal Employment Opportunity (EEO) requirements not to discriminate and to take affirmative action to assure equal opportunity as set forth under laws, executive orders, rules, regulations (see 28 CFR Part 35, 29 CFR Part 1630, 29 CFR Parts 1625-1627, 41 CFR Part 60 and 49 CFR Part 27) and orders of the Secretary of Labor as modified by the provisions prescribed herein, and imposed pursuant to 23 U.S.C. 140, shall constitute the EEO and specific affirmative action standards for the contractor's project activities under this contract. The provisions of the Americans with Disabilities Act of 1990 (42 U.S.C. 12101 et seq.) set forth under 28 CFR Part 35 and 29 CFR Part 1630 are incorporated by reference in this contract. In the execution of this contract, the contractor agrees to comply with the following minimum specific requirement activities of EEO:

a. The contractor will work with the contracting agency and the Federal Government to ensure that it has made every good faith effort to provide equal opportunity with respect to all of its terms and conditions of employment and in their review of activities under the contract. 23 CFR 230.409 (g)(4) & (5).

b. The contractor will accept as its operating policy the following statement:

"It is the policy of this Company to assure that applicants are employed, and that employees are treated during employment, without regard to their race, religion, sex, sexual orientation, gender identity, color, national origin, age or disability. Such action shall include: employment, upgrading, demotion, or transfer; recruitment or recruitment advertising; layoff or termination; rates of pay or other forms of compensation; and selection for training, including apprenticeship, pre-apprenticeship, and/or on-the-job training."

**2. EEO Officer:** The contractor will designate and make known to the contracting officers an EEO Officer who will have the responsibility for and must be capable of effectively administering and promoting an active EEO program and who must be assigned adequate authority and responsibility to do so.

**3. Dissemination of Policy:** All members of the contractor's staff who are authorized to hire, supervise, promote, and discharge employees, or who recommend such action or are substantially involved in such action, will be made fully cognizant of and will implement the contractor's EEO policy and contractual responsibilities to provide EEO in each grade and classification of employment. To ensure that the above agreement will be met, the following actions will be taken as a minimum:

a. Periodic meetings of supervisory and personnel office employees will be conducted before the start of work and then not less often than once every six months, at which time the contractor's EEO policy and its implementation will be reviewed and explained. The meetings will be conducted by the EEO Officer or other knowledgeable company official.

b. All new supervisory or personnel office employees will be given a thorough indoctrination by the EEO Officer, covering all major aspects of the contractor's EEO obligations within thirty days following their reporting for duty with the contractor.

c. All personnel who are engaged in direct recruitment for the project will be instructed by the EEO Officer in the contractor's procedures for locating and hiring minorities and women.

d. Notices and posters setting forth the contractor's EEO policy will be placed in areas readily accessible to employees, applicants for employment and potential employees.

e. The contractor's EEO policy and the procedures to implement such policy will be brought to the attention of employees by means of meetings, employee handbooks, or other appropriate means.

**4. Recruitment:** When advertising for employees, the contractor will include in all advertisements for employees the notation: "An Equal Opportunity Employer." All such advertisements will be placed in publications having a large circulation among minorities and women in the area from which the project work force would normally be derived.

a. The contractor will, unless precluded by a valid bargaining agreement, conduct systematic and direct recruitment through public and private employee referral sources likely to yield qualified minorities and women. To meet this requirement, the contractor will identify sources of potential minority group employees and establish with such identified sources procedures whereby minority and women applicants may be referred to the contractor for employment consideration.

b. In the event the contractor has a valid bargaining agreement providing for exclusive hiring hall referrals, the contractor is expected to observe the provisions of that agreement to the extent that the system meets the contractor's compliance with EEO contract provisions. Where implementation of such an agreement has the effect of discriminating against minorities or women, or obligates the contractor to do the same, such implementation violates Federal nondiscrimination provisions.

c. The contractor will encourage its present employees to refer minorities and women as applicants for employment. Information and procedures with regard to referring such applicants will be discussed with employees.

**5. Personnel Actions:** Wages, working conditions, and employee benefits shall be established and administered, and personnel actions of every type, including hiring, upgrading, promotion, transfer, demotion, layoff, and termination, shall be taken without regard to race, color, religion, sex, sexual orientation, gender identity, national origin, age or disability. The following procedures shall be followed:

a. The contractor will conduct periodic inspections of project sites to ensure that working conditions and employee facilities do not indicate discriminatory treatment of project site personnel.

b. The contractor will periodically evaluate the spread of wages paid within each classification to determine any evidence of discriminatory wage practices.

c. The contractor will periodically review selected personnel actions in depth to determine whether there is evidence of discrimination. Where evidence is found, the contractor will promptly take corrective action. If the review indicates that the discrimination may extend beyond the actions reviewed, such corrective action shall include all affected persons.

d. The contractor will promptly investigate all complaints of alleged discrimination made to the contractor in connection with its obligations under this contract, will attempt to resolve such complaints, and will take appropriate corrective action

within a reasonable time. If the investigation indicates that the discrimination may affect persons other than the complainant, such corrective action shall include such other persons. Upon completion of each investigation, the contractor will inform every complainant of all of their avenues of appeal.

**6. Training and Promotion:**

a. The contractor will assist in locating, qualifying, and increasing the skills of minorities and women who are applicants for employment or current employees. Such efforts should be aimed at developing full journey level status employees in the type of trade or job classification involved.

b. Consistent with the contractor's work force requirements and as permissible under Federal and State regulations, the contractor shall make full use of training programs (i.e., apprenticeship and on-the-job training programs for the geographical area of contract performance). In the event a special provision for training is provided under this contract, this subparagraph will be superseded as indicated in the special provision. The contracting agency may reserve training positions for persons who receive welfare assistance in accordance with 23 U.S.C. 140(a).

c. The contractor will advise employees and applicants for employment of available training programs and entrance requirements for each.

d. The contractor will periodically review the training and promotion potential of employees who are minorities and women and will encourage eligible employees to apply for such training and promotion.

**7. Unions:** If the contractor relies in whole or in part upon unions as a source of employees, the contractor will use good faith efforts to obtain the cooperation of such unions to increase opportunities for minorities and women. 23 CFR 230.409. Actions by the contractor, either directly or through a contractor's association acting as agent, will include the procedures set forth below:

a. The contractor will use good faith efforts to develop, in cooperation with the unions, joint training programs aimed toward qualifying more minorities and women for membership in the unions and increasing the skills of minorities and women so that they may qualify for higher paying employment.

b. The contractor will use good faith efforts to incorporate an EEO clause into each union agreement to the end that such union will be contractually bound to refer applicants without regard to their race, color, religion, sex, sexual orientation, gender identity, national origin, age, or disability.

c. The contractor is to obtain information as to the referral practices and policies of the labor union except that to the extent such information is within the exclusive possession of the labor union and such labor union refuses to furnish such information to the contractor, the contractor shall so certify to the contracting agency and shall set forth what efforts have been made to obtain such information.

d. In the event the union is unable to provide the contractor with a reasonable flow of referrals within the time limit set forth in the collective bargaining agreement, the contractor will, through independent recruitment efforts, fill the employment vacancies without regard to race, color, religion, sex, sexual orientation, gender identity, national origin, age, or disability; making full efforts to obtain qualified and/or qualifiable minorities and women. The failure of a union to provide

sufficient referrals (even though it is obligated to provide exclusive referrals under the terms of a collective bargaining agreement) does not relieve the contractor from the requirements of this paragraph. In the event the union referral practice prevents the contractor from meeting the obligations pursuant to Executive Order 11246, as amended, and these special provisions, such contractor shall immediately notify the contracting agency.

**8. Reasonable Accommodation for Applicants / Employees with Disabilities:** The contractor must be familiar with the requirements for and comply with the Americans with Disabilities Act and all rules and regulations established thereunder. Employers must provide reasonable accommodation in all employment activities unless to do so would cause an undue hardship.

**9. Selection of Subcontractors, Procurement of Materials and Leasing of Equipment:** The contractor shall not discriminate on the grounds of race, color, religion, sex, sexual orientation, gender identity, national origin, age, or disability in the selection and retention of subcontractors, including procurement of materials and leases of equipment. The contractor shall take all necessary and reasonable steps to ensure nondiscrimination in the administration of this contract.

a. The contractor shall notify all potential subcontractors, suppliers, and lessors of their EEO obligations under this contract.

b. The contractor will use good faith efforts to ensure subcontractor compliance with their EEO obligations.

**10. Assurances Required:**

a. The requirements of 49 CFR Part 26 and the State DOT's FHWA-approved Disadvantaged Business Enterprise (DBE) program are incorporated by reference.

b. The contractor, subrecipient or subcontractor shall not discriminate on the basis of race, color, national origin, or sex in the performance of this contract. The contractor shall carry out applicable requirements of 49 CFR part 26 in the award and administration of DOT-assisted contracts. Failure by the contractor to carry out these requirements is a material breach of this contract, which may result in the termination of this contract or such other remedy as the recipient deems appropriate, which may include, but is not limited to:

- (1) Withholding monthly progress payments;
- (2) Assessing sanctions;
- (3) Liquidated damages; and/or
- (4) Disqualifying the contractor from future bidding as non-responsible.

c. The Title VI and nondiscrimination provisions of U.S. DOT Order 1050.2A at Appendixes A and E are incorporated by reference. 49 CFR Part 21.

**11. Records and Reports:** The contractor shall keep such records as necessary to document compliance with the EEO requirements. Such records shall be retained for a period of three years following the date of the final payment to the contractor for all contract work and shall be available at reasonable times and places for inspection by authorized representatives of the contracting agency and the FHWA.

a. The records kept by the contractor shall document the following:

(1) The number and work hours of minority and non-minority group members and women employed in each work classification on the project;

(2) The progress and efforts being made in cooperation with unions, when applicable, to increase employment opportunities for minorities and women; and

(3) The progress and efforts being made in locating, hiring, training, qualifying, and upgrading minorities and women.

b. The contractors and subcontractors will submit an annual report to the contracting agency each July for the duration of the project indicating the number of minority, women, and non-minority group employees currently engaged in each work classification required by the contract work. This information is to be reported on [Form FHWA-1391](#). The staffing data should represent the project work force on board in all or any part of the last payroll period preceding the end of July. If on-the-job training is being required by special provision, the contractor will be required to collect and report training data. The employment data should reflect the work force on board during all or any part of the last payroll period preceding the end of July.

### III. NONSEGREGATED FACILITIES

This provision is applicable to all Federal-aid construction contracts and to all related construction subcontracts of more than \$10,000. 41 CFR 60-1.5.

As prescribed by 41 CFR 60-1.8, the contractor must ensure that facilities provided for employees are provided in such a manner that segregation on the basis of race, color, religion, sex, sexual orientation, gender identity, or national origin cannot result. The contractor may neither require such segregated use by written or oral policies nor tolerate such use by employee custom. The contractor's obligation extends further to ensure that its employees are not assigned to perform their services at any location under the contractor's control where the facilities are segregated. The term "facilities" includes waiting rooms, work areas, restaurants and other eating areas, time clocks, restrooms, washrooms, locker rooms and other storage or dressing areas, parking lots, drinking fountains, recreation or entertainment areas, transportation, and housing provided for employees. The contractor shall provide separate or single-user restrooms and necessary dressing or sleeping areas to assure privacy between sexes.

### IV. DAVIS-BACON AND RELATED ACT PROVISIONS

This section is applicable to all Federal-aid construction projects exceeding \$2,000 and to all related subcontracts and lower-tier subcontracts (regardless of subcontract size), in accordance with 29 CFR 5.5. The requirements apply to all projects located within the right-of-way of a roadway that is functionally classified as Federal-aid highway. 23 U.S.C. 113. This excludes roadways functionally classified as local roads or rural minor collectors, which are exempt. 23 U.S.C. 101. Where applicable law requires that projects be treated as a project on a Federal-aid highway, the provisions of this subpart will apply regardless of the location of the project. Examples include: Surface Transportation Block Grant Program projects funded under 23 U.S.C. 133 [excluding recreational trails projects], the Nationally Significant Freight and Highway

Projects funded under 23 U.S.C. 117, and National Highway Freight Program projects funded under 23 U.S.C. 167.

The following provisions are from the U.S. Department of Labor regulations in 29 CFR 5.5 "Contract provisions and related matters" with minor revisions to conform to the FHWA-1273 format and FHWA program requirements.

#### 1. Minimum wages (29 CFR 5.5)

a. *Wage rates and fringe benefits.* All laborers and mechanics employed or working upon the site of the work (or otherwise working in construction or development of the project under a development statute), will be paid unconditionally and not less often than once a week, and without subsequent deduction or rebate on any account (except such payroll deductions as are permitted by regulations issued by the Secretary of Labor under the Copeland Act ([29 CFR part 3](#))), the full amount of basic hourly wages and bona fide fringe benefits (or cash equivalents thereof) due at time of payment computed at rates not less than those contained in the wage determination of the Secretary of Labor which is attached hereto and made a part hereof, regardless of any contractual relationship which may be alleged to exist between the contractor and such laborers and mechanics. As provided in paragraphs (d) and (e) of 29 CFR 5.5, the appropriate wage determinations are effective by operation of law even if they have not been attached to the contract. Contributions made or costs reasonably anticipated for bona fide fringe benefits under the Davis-Bacon Act ([40 U.S.C. 3141\(2\)\(B\)](#)) on behalf of laborers or mechanics are considered wages paid to such laborers or mechanics, subject to the provisions of paragraph 1.e. of this section; also, regular contributions made or costs incurred for more than a weekly period (but not less often than quarterly) under plans, funds, or programs which cover the particular weekly period, are deemed to be constructively made or incurred during such weekly period. Such laborers and mechanics must be paid the appropriate wage rate and fringe benefits on the wage determination for the classification(s) of work actually performed, without regard to skill, except as provided in paragraph 4. of this section. Laborers or mechanics performing work in more than one classification may be compensated at the rate specified for each classification for the time actually worked therein: *Provided*, That the employer's payroll records accurately set forth the time spent in each classification in which work is performed. The wage determination (including any additional classifications and wage rates conformed under paragraph 1.c. of this section) and the Davis-Bacon poster (WH-1321) must be posted at all times by the contractor and its subcontractors at the site of the work in a prominent and accessible place where it can be easily seen by the workers.

b. *Frequently recurring classifications.* (1) In addition to wage and fringe benefit rates that have been determined to be prevailing under the procedures set forth in [29 CFR part 1](#), a wage determination may contain, pursuant to § 1.3(f), wage and fringe benefit rates for classifications of laborers and mechanics for which conformance requests are regularly submitted pursuant to paragraph 1.c. of this section, provided that:

(i) The work performed by the classification is not performed by a classification in the wage determination for which a prevailing wage rate has been determined;

(ii) The classification is used in the area by the construction industry; and

(iii) The wage rate for the classification bears a reasonable relationship to the prevailing wage rates contained in the wage determination.

(2) The Administrator will establish wage rates for such classifications in accordance with paragraph 1.c.(1)(iii) of this section. Work performed in such a classification must be paid at no less than the wage and fringe benefit rate listed on the wage determination for such classification.

c. *Conformance.* (1) The contracting officer must require that any class of laborers or mechanics, including helpers, which is not listed in the wage determination and which is to be employed under the contract be classified in conformance with the wage determination. Conformance of an additional classification and wage rate and fringe benefits is appropriate only when the following criteria have been met:

(i) The work to be performed by the classification requested is not performed by a classification in the wage determination; and

(ii) The classification is used in the area by the construction industry; and

(iii) The proposed wage rate, including any bona fide fringe benefits, bears a reasonable relationship to the wage rates contained in the wage determination.

(2) The conformance process may not be used to split, subdivide, or otherwise avoid application of classifications listed in the wage determination.

(3) If the contractor and the laborers and mechanics to be employed in the classification (if known), or their representatives, and the contracting officer agree on the classification and wage rate (including the amount designated for fringe benefits where appropriate), a report of the action taken will be sent by the contracting officer by email to [DBAconformance@dol.gov](mailto:DBAconformance@dol.gov). The Administrator, or an authorized representative, will approve, modify, or disapprove every additional classification action within 30 days of receipt and so advise the contracting officer or will notify the contracting officer within the 30-day period that additional time is necessary.

(4) In the event the contractor, the laborers or mechanics to be employed in the classification or their representatives, and the contracting officer do not agree on the proposed classification and wage rate (including the amount designated for fringe benefits, where appropriate), the contracting officer will, by email to [DBAconformance@dol.gov](mailto:DBAconformance@dol.gov), refer the questions, including the views of all interested parties and the recommendation of the contracting officer, to the Administrator for determination. The Administrator, or an authorized representative, will issue a determination within 30 days of receipt and so advise the contracting officer or will notify the contracting officer within the 30-day period that additional time is necessary.

(5) The contracting officer must promptly notify the contractor of the action taken by the Wage and Hour Division

under paragraphs 1.c.(3) and (4) of this section. The contractor must furnish a written copy of such determination to each affected worker or it must be posted as a part of the wage determination. The wage rate (including fringe benefits where appropriate) determined pursuant to paragraph 1.c.(3) or (4) of this section must be paid to all workers performing work in the classification under this contract from the first day on which work is performed in the classification.

d. *Fringe benefits not expressed as an hourly rate.* Whenever the minimum wage rate prescribed in the contract for a class of laborers or mechanics includes a fringe benefit which is not expressed as an hourly rate, the contractor may either pay the benefit as stated in the wage determination or may pay another bona fide fringe benefit or an hourly cash equivalent thereof.

e. *Unfunded plans.* If the contractor does not make payments to a trustee or other third person, the contractor may consider as part of the wages of any laborer or mechanic the amount of any costs reasonably anticipated in providing bona fide fringe benefits under a plan or program, *Provided*, That the Secretary of Labor has found, upon the written request of the contractor, in accordance with the criteria set forth in § 5.28, that the applicable standards of the Davis-Bacon Act have been met. The Secretary of Labor may require the contractor to set aside in a separate account assets for the meeting of obligations under the plan or program.

f. *Interest.* In the event of a failure to pay all or part of the wages required by the contract, the contractor will be required to pay interest on any underpayment of wages.

## 2. Withholding (29 CFR 5.5)

a. *Withholding requirements.* The contracting agency may, upon its own action, or must, upon written request of an authorized representative of the Department of Labor, withhold or cause to be withheld from the contractor so much of the accrued payments or advances as may be considered necessary to satisfy the liabilities of the prime contractor or any subcontractor for the full amount of wages and monetary relief, including interest, required by the clauses set forth in this section for violations of this contract, or to satisfy any such liabilities required by any other Federal contract, or federally assisted contract subject to Davis-Bacon labor standards, that is held by the same prime contractor (as defined in § 5.2). The necessary funds may be withheld from the contractor under this contract, any other Federal contract with the same prime contractor, or any other federally assisted contract that is subject to Davis-Bacon labor standards requirements and is held by the same prime contractor, regardless of whether the other contract was awarded or assisted by the same agency, and such funds may be used to satisfy the contractor liability for which the funds were withheld. In the event of a contractor's failure to pay any laborer or mechanic, including any apprentice or helper working on the site of the work all or part of the wages required by the contract, or upon the contractor's failure to submit the required records as discussed in paragraph 3.d. of this section, the contracting agency may on its own initiative and after written notice to the contractor, take such action as may be necessary to cause the suspension of any further payment, advance, or guarantee of funds until such violations have ceased.

b. *Priority to withheld funds.* The Department has priority to funds withheld or to be withheld in accordance with paragraph



2.a. of this section or Section V, paragraph 3.a., or both, over claims to those funds by:

- (1) A contractor's surety(ies), including without limitation performance bond sureties and payment bond sureties;
- (2) A contracting agency for its procurement costs;
- (3) A trustee(s) (either a court-appointed trustee or a U.S. trustee, or both) in bankruptcy of a contractor, or a contractor's bankruptcy estate;
- (4) A contractor's assignee(s);
- (5) A contractor's successor(s); or
- (6) A claim asserted under the Prompt Payment Act, [31 U.S.C. 3901–3907](#).

### 3. Records and certified payrolls (29 CFR 5.5)

a. *Basic record requirements (1) Length of record retention.* All regular payrolls and other basic records must be maintained by the contractor and any subcontractor during the course of the work and preserved for all laborers and mechanics working at the site of the work (or otherwise working in construction or development of the project under a development statute) for a period of at least 3 years after all the work on the prime contract is completed.

(2) *Information required.* Such records must contain the name; Social Security number; last known address, telephone number, and email address of each such worker; each worker's correct classification(s) of work actually performed; hourly rates of wages paid (including rates of contributions or costs anticipated for bona fide fringe benefits or cash equivalents thereof of the types described in [40 U.S.C. 3141\(2\)\(B\)](#) of the Davis-Bacon Act); daily and weekly number of hours actually worked in total and on each covered contract; deductions made; and actual wages paid.

(3) *Additional records relating to fringe benefits.* Whenever the Secretary of Labor has found under paragraph 1.e. of this section that the wages of any laborer or mechanic include the amount of any costs reasonably anticipated in providing benefits under a plan or program described in [40 U.S.C. 3141\(2\)\(B\)](#) of the Davis-Bacon Act, the contractor must maintain records which show that the commitment to provide such benefits is enforceable, that the plan or program is financially responsible, and that the plan or program has been communicated in writing to the laborers or mechanics affected, and records which show the costs anticipated or the actual cost incurred in providing such benefits.

(4) *Additional records relating to apprenticeship.* Contractors with apprentices working under approved programs must maintain written evidence of the registration of apprenticeship programs, the registration of the apprentices, and the ratios and wage rates prescribed in the applicable programs.

b. *Certified payroll requirements (1) Frequency and method of submission.* The contractor or subcontractor must submit weekly, for each week in which any DBA- or Related Acts-covered work is performed, certified payrolls to the contracting

agency. The prime contractor is responsible for the submission of all certified payrolls by all subcontractors. A contracting agency or prime contractor may permit or require contractors to submit certified payrolls through an electronic system, as long as the electronic system requires a legally valid electronic signature; the system allows the contractor, the contracting agency, and the Department of Labor to access the certified payrolls upon request for at least 3 years after the work on the prime contract has been completed; and the contracting agency or prime contractor permits other methods of submission in situations where the contractor is unable or limited in its ability to use or access the electronic system.

(2) *Information required.* The certified payrolls submitted must set out accurately and completely all of the information required to be maintained under paragraph 3.a.(2) of this section, except that full Social Security numbers and last known addresses, telephone numbers, and email addresses must not be included on weekly transmittals. Instead, the certified payrolls need only include an individually identifying number for each worker ( e.g., the last four digits of the worker's Social Security number). The required weekly certified payroll information may be submitted using Optional Form WH-347 or in any other format desired. Optional Form WH-347 is available for this purpose from the Wage and Hour Division website at <https://www.dol.gov/sites/dolgov/files/WHD/legacy/files/wh347.pdf> or its successor website. It is not a violation of this section for a prime contractor to require a subcontractor to provide full Social Security numbers and last known addresses, telephone numbers, and email addresses to the prime contractor for its own records, without weekly submission by the subcontractor to the contracting agency.

(3) *Statement of Compliance.* Each certified payroll submitted must be accompanied by a "Statement of Compliance," signed by the contractor or subcontractor, or the contractor's or subcontractor's agent who pays or supervises the payment of the persons working on the contract, and must certify the following:

(i) That the certified payroll for the payroll period contains the information required to be provided under paragraph 3.b. of this section, the appropriate information and basic records are being maintained under paragraph 3.a. of this section, and such information and records are correct and complete;

(ii) That each laborer or mechanic (including each helper and apprentice) working on the contract during the payroll period has been paid the full weekly wages earned, without rebate, either directly or indirectly, and that no deductions have been made either directly or indirectly from the full wages earned, other than permissible deductions as set forth in [29 CFR part 3](#); and

(iii) That each laborer or mechanic has been paid not less than the applicable wage rates and fringe benefits or cash equivalents for the classification(s) of work actually performed, as specified in the applicable wage determination incorporated into the contract.

(4) *Use of Optional Form WH-347.* The weekly submission of a properly executed certification set forth on the reverse side of Optional Form WH-347 will satisfy the requirement for submission of the "Statement of Compliance" required by paragraph 3.b.(3) of this section.

(5) *Signature.* The signature by the contractor, subcontractor, or the contractor's or subcontractor's agent must be an original handwritten signature or a legally valid electronic signature.

(6) *Falsification.* The falsification of any of the above certifications may subject the contractor or subcontractor to civil or criminal prosecution under [18 U.S.C. 1001](#) and [31 U.S.C. 3729](#).

(7) *Length of certified payroll retention.* The contractor or subcontractor must preserve all certified payrolls during the course of the work and for a period of 3 years after all the work on the prime contract is completed.

c. *Contracts, subcontracts, and related documents.* The contractor or subcontractor must maintain this contract or subcontract and related documents including, without limitation, bids, proposals, amendments, modifications, and extensions. The contractor or subcontractor must preserve these contracts, subcontracts, and related documents during the course of the work and for a period of 3 years after all the work on the prime contract is completed.

d. *Required disclosures and access (1) Required record disclosures and access to workers.* The contractor or subcontractor must make the records required under paragraphs 3.a. through 3.c. of this section, and any other documents that the contracting agency, the State DOT, the FHWA, or the Department of Labor deems necessary to determine compliance with the labor standards provisions of any of the applicable statutes referenced by § 5.1, available for inspection, copying, or transcription by authorized representatives of the contracting agency, the State DOT, the FHWA, or the Department of Labor, and must permit such representatives to interview workers during working hours on the job.

(2) *Sanctions for non-compliance with records and worker access requirements.* If the contractor or subcontractor fails to submit the required records or to make them available, or refuses to permit worker interviews during working hours on the job, the Federal agency may, after written notice to the contractor, sponsor, applicant, owner, or other entity, as the case may be, that maintains such records or that employs such workers, take such action as may be necessary to cause the suspension of any further payment, advance, or guarantee of funds. Furthermore, failure to submit the required records upon request or to make such records available, or to permit worker interviews during working hours on the job, may be grounds for debarment action pursuant to § 5.12. In addition, any contractor or other person that fails to submit the required records or make those records available to WHD within the time WHD requests that the records be produced will be precluded from introducing as evidence in an administrative proceeding under [29 CFR part 6](#) any of the required records that were not provided or made available to WHD. WHD will take into consideration a reasonable request from the contractor or person for an extension of the time for submission of records. WHD will determine the reasonableness of the request and may consider, among other things, the location of the records and the volume of production.

(3) *Required information disclosures.* Contractors and subcontractors must maintain the full Social Security number and last known address, telephone number, and email address

of each covered worker, and must provide them upon request to the contracting agency, the State DOT, the FHWA, the contractor, or the Wage and Hour Division of the Department of Labor for purposes of an investigation or other compliance action.

#### **4. Apprentices and equal employment opportunity (29 CFR 5.5)**

a. *Apprentices (1) Rate of pay.* Apprentices will be permitted to work at less than the predetermined rate for the work they perform when they are employed pursuant to and individually registered in a bona fide apprenticeship program registered with the U.S. Department of Labor, Employment and Training Administration, Office of Apprenticeship (OA), or with a State Apprenticeship Agency recognized by the OA. A person who is not individually registered in the program, but who has been certified by the OA or a State Apprenticeship Agency (where appropriate) to be eligible for probationary employment as an apprentice, will be permitted to work at less than the predetermined rate for the work they perform in the first 90 days of probationary employment as an apprentice in such a program. In the event the OA or a State Apprenticeship Agency recognized by the OA withdraws approval of an apprenticeship program, the contractor will no longer be permitted to use apprentices at less than the applicable predetermined rate for the work performed until an acceptable program is approved.

(2) *Fringe benefits.* Apprentices must be paid fringe benefits in accordance with the provisions of the apprenticeship program. If the apprenticeship program does not specify fringe benefits, apprentices must be paid the full amount of fringe benefits listed on the wage determination for the applicable classification. If the Administrator determines that a different practice prevails for the applicable apprentice classification, fringe benefits must be paid in accordance with that determination.

(3) *Apprenticeship ratio.* The allowable ratio of apprentices to journeyworkers on the job site in any craft classification must not be greater than the ratio permitted to the contractor as to the entire work force under the registered program or the ratio applicable to the locality of the project pursuant to paragraph 4.a.(4) of this section. Any worker listed on a payroll at an apprentice wage rate, who is not registered or otherwise employed as stated in paragraph 4.a.(1) of this section, must be paid not less than the applicable wage rate on the wage determination for the classification of work actually performed. In addition, any apprentice performing work on the job site in excess of the ratio permitted under this section must be paid not less than the applicable wage rate on the wage determination for the work actually performed.

(4) *Reciprocity of ratios and wage rates.* Where a contractor is performing construction on a project in a locality other than the locality in which its program is registered, the ratios and wage rates (expressed in percentages of the journeyworker's hourly rate) applicable within the locality in which the construction is being performed must be observed. If there is no applicable ratio or wage rate for the locality of the project, the ratio and wage rate specified in the contractor's registered program must be observed.

b. *Equal employment opportunity.* The use of apprentices and journeyworkers under this part must be in conformity with

the equal employment opportunity requirements of Executive Order 11246, as amended, and [29 CFR part 30](#).

c. Apprentices and Trainees (programs of the U.S. DOT).

Apprentices and trainees working under apprenticeship and skill training programs which have been certified by the Secretary of Transportation as promoting EEO in connection with Federal-aid highway construction programs are not subject to the requirements of paragraph 4 of this Section IV. 23 CFR 230.111(e)(2). The straight time hourly wage rates for apprentices and trainees under such programs will be established by the particular programs. The ratio of apprentices and trainees to journeyworkers shall not be greater than permitted by the terms of the particular program.

**5. Compliance with Copeland Act requirements.** The contractor shall comply with the requirements of 29 CFR part 3, which are incorporated by reference in this contract as provided in 29 CFR 5.5.

**6. Subcontracts.** The contractor or subcontractor must insert FHWA-1273 in any subcontracts, along with the applicable wage determination(s) and such other clauses or contract modifications as the contracting agency may by appropriate instructions require, and a clause requiring the subcontractors to include these clauses and wage determination(s) in any lower tier subcontracts. The prime contractor is responsible for the compliance by any subcontractor or lower tier subcontractor with all the contract clauses in this section. In the event of any violations of these clauses, the prime contractor and any subcontractor(s) responsible will be liable for any unpaid wages and monetary relief, including interest from the date of the underpayment or loss, due to any workers of lower-tier subcontractors, and may be subject to debarment, as appropriate. 29 CFR 5.5.

**7. Contract termination: debarment.** A breach of the contract clauses in 29 CFR 5.5 may be grounds for termination of the contract, and for debarment as a contractor and a subcontractor as provided in 29 CFR 5.12.

**8. Compliance with Davis-Bacon and Related Act requirements.** All rulings and interpretations of the Davis-Bacon and Related Acts contained in 29 CFR parts 1, 3, and 5 are herein incorporated by reference in this contract as provided in 29 CFR 5.5.

**9. Disputes concerning labor standards.** As provided in 29 CFR 5.5, disputes arising out of the labor standards provisions of this contract shall not be subject to the general disputes clause of this contract. Such disputes shall be resolved in accordance with the procedures of the Department of Labor set forth in 29 CFR parts 5, 6, and 7. Disputes within the meaning of this clause include disputes between the contractor (or any of its subcontractors) and the contracting agency, the U.S. Department of Labor, or the employees or their representatives.

**10. Certification of eligibility.** a. By entering into this contract, the contractor certifies that neither it nor any person or firm who has an interest in the contractor's firm is a person or firm ineligible to be awarded Government contracts by virtue of [40 U.S.C. 3144\(b\)](#) or § 5.12(a).

b. No part of this contract shall be subcontracted to any person or firm ineligible for award of a Government contract by virtue of [40 U.S.C. 3144\(b\)](#) or § 5.12(a).

c. The penalty for making false statements is prescribed in the U.S. Code, Title 18 Crimes and Criminal Procedure, [18 U.S.C. 1001](#).

**11. Anti-retaliation.** It is unlawful for any person to discharge, demote, intimidate, threaten, restrain, coerce, blacklist, harass, or in any other manner discriminate against, or to cause any person to discharge, demote, intimidate, threaten, restrain, coerce, blacklist, harass, or in any other manner discriminate against, any worker or job applicant for:

a. Notifying any contractor of any conduct which the worker reasonably believes constitutes a violation of the DBA, Related Acts, this part, or [29 CFR part 1](#) or [3](#);

b. Filing any complaint, initiating or causing to be initiated any proceeding, or otherwise asserting or seeking to assert on behalf of themselves or others any right or protection under the DBA, Related Acts, this part, or [29 CFR part 1](#) or [3](#);

c. Cooperating in any investigation or other compliance action, or testifying in any proceeding under the DBA, Related Acts, this part, or [29 CFR part 1](#) or [3](#); or

d. Informing any other person about their rights under the DBA, Related Acts, this part, or [29 CFR part 1](#) or [3](#).

## V. CONTRACT WORK HOURS AND SAFETY STANDARDS ACT

Pursuant to 29 CFR 5.5(b), the following clauses apply to any Federal-aid construction contract in an amount in excess of \$100,000 and subject to the overtime provisions of the Contract Work Hours and Safety Standards Act. These clauses shall be inserted in addition to the clauses required by 29 CFR 5.5(a) or 29 CFR 4.6. As used in this paragraph, the terms laborers and mechanics include watchpersons and guards.

**1. Overtime requirements.** No contractor or subcontractor contracting for any part of the contract work which may require or involve the employment of laborers or mechanics shall require or permit any such laborer or mechanic in any workweek in which he or she is employed on such work to work in excess of forty hours in such workweek unless such laborer or mechanic receives compensation at a rate not less than one and one-half times the basic rate of pay for all hours worked in excess of forty hours in such workweek. 29 CFR 5.5.

**2. Violation; liability for unpaid wages; liquidated damages.** In the event of any violation of the clause set forth in paragraph 1. of this section the contractor and any subcontractor responsible therefor shall be liable for the unpaid wages and interest from the date of the underpayment. In addition, such contractor and subcontractor shall be liable to the United States (in the case of work done under contract for the District of Columbia or a territory, to such District or to such territory), for liquidated damages. Such liquidated damages shall be computed with respect to each individual laborer or

mechanic, including watchpersons and guards, employed in violation of the clause set forth in paragraph 1. of this section, in the sum currently provided in 29 CFR 5.5(b)(2)\* for each calendar day on which such individual was required or permitted to work in excess of the standard workweek of forty hours without payment of the overtime wages required by the clause set forth in paragraph 1. of this section.

\* \$31 as of January 15, 2023 (See 88 FR 88 FR 2210) as may be adjusted annually by the Department of Labor, pursuant to the Federal Civil Penalties Inflation Adjustment Act of 1990.

**3. Withholding for unpaid wages and liquidated damages**

a. *Withholding process.* The FHWA or the contracting agency may, upon its own action, or must, upon written request of an authorized representative of the Department of Labor, withhold or cause to be withheld from the contractor so much of the accrued payments or advances as may be considered necessary to satisfy the liabilities of the prime contractor or any subcontractor for any unpaid wages; monetary relief, including interest; and liquidated damages required by the clauses set forth in this section on this contract, any other Federal contract with the same prime contractor, or any other federally assisted contract subject to the Contract Work Hours and Safety Standards Act that is held by the same prime contractor (as defined in § 5.2). The necessary funds may be withheld from the contractor under this contract, any other Federal contract with the same prime contractor, or any other federally assisted contract that is subject to the Contract Work Hours and Safety Standards Act and is held by the same prime contractor, regardless of whether the other contract was awarded or assisted by the same agency, and such funds may be used to satisfy the contractor liability for which the funds were withheld.

b. *Priority to withheld funds.* The Department has priority to funds withheld or to be withheld in accordance with Section IV paragraph 2.a. or paragraph 3.a. of this section, or both, over claims to those funds by:

- (1) A contractor's surety(ies), including without limitation performance bond sureties and payment bond sureties;
- (2) A contracting agency for its procurement costs;
- (3) A trustee(s) (either a court-appointed trustee or a U.S. trustee, or both) in bankruptcy of a contractor, or a contractor's bankruptcy estate;
- (4) A contractor's assignee(s);
- (5) A contractor's successor(s); or
- (6) A claim asserted under the Prompt Payment Act, [31 U.S.C. 3901](#)–3907.

**4. Subcontracts.** The contractor or subcontractor must insert in any subcontracts the clauses set forth in paragraphs 1. through 5. of this section and a clause requiring the subcontractors to include these clauses in any lower tier subcontracts. The prime contractor is responsible for compliance by any subcontractor or lower tier subcontractor with the clauses set forth in paragraphs 1. through 5. In the

event of any violations of these clauses, the prime contractor and any subcontractor(s) responsible will be liable for any unpaid wages and monetary relief, including interest from the date of the underpayment or loss, due to any workers of lower-tier subcontractors, and associated liquidated damages and may be subject to debarment, as appropriate.

**5. Anti-retaliation.** It is unlawful for any person to discharge, demote, intimidate, threaten, restrain, coerce, blacklist, harass, or in any other manner discriminate against, or to cause any person to discharge, demote, intimidate, threaten, restrain, coerce, blacklist, harass, or in any other manner discriminate against, any worker or job applicant for:

- a. Notifying any contractor of any conduct which the worker reasonably believes constitutes a violation of the Contract Work Hours and Safety Standards Act (CWHSSA) or its implementing regulations in this part;
- b. Filing any complaint, initiating or causing to be initiated any proceeding, or otherwise asserting or seeking to assert on behalf of themselves or others any right or protection under CWHSSA or this part;
- c. Cooperating in any investigation or other compliance action, or testifying in any proceeding under CWHSSA or this part; or
- d. Informing any other person about their rights under CWHSSA or this part.

**VI. SUBLETTING OR ASSIGNING THE CONTRACT**

This provision is applicable to all Federal-aid construction contracts on the National Highway System pursuant to 23 CFR 635.116.

1. The contractor shall perform with its own organization contract work amounting to not less than 30 percent (or a greater percentage if specified elsewhere in the contract) of the total original contract price, excluding any specialty items designated by the contracting agency. Specialty items may be performed by subcontract and the amount of any such specialty items performed may be deducted from the total original contract price before computing the amount of work required to be performed by the contractor's own organization (23 CFR 635.116).

a. The term "perform work with its own organization" in paragraph 1 of Section VI refers to workers employed or leased by the prime contractor, and equipment owned or rented by the prime contractor, with or without operators. Such term does not include employees or equipment of a subcontractor or lower tier subcontractor, agents of the prime contractor, or any other assignees. The term may include payments for the costs of hiring leased employees from an employee leasing firm meeting all relevant Federal and State regulatory requirements. Leased employees may only be included in this term if the prime contractor meets all of the following conditions: (based on longstanding interpretation)

- (1) the prime contractor maintains control over the supervision of the day-to-day activities of the leased employees;
- (2) the prime contractor remains responsible for the quality of the work of the leased employees;

- (3) the prime contractor retains all power to accept or exclude individual employees from work on the project; and
- (4) the prime contractor remains ultimately responsible for the payment of predetermined minimum wages, the submission of payrolls, statements of compliance and all other Federal regulatory requirements.

b. "Specialty Items" shall be construed to be limited to work that requires highly specialized knowledge, abilities, or equipment not ordinarily available in the type of contracting organizations qualified and expected to bid or propose on the contract as a whole and in general are to be limited to minor components of the overall contract. 23 CFR 635.102.

2. Pursuant to 23 CFR 635.116(a), the contract amount upon which the requirements set forth in paragraph (1) of Section VI is computed includes the cost of material and manufactured products which are to be purchased or produced by the contractor under the contract provisions.

3. Pursuant to 23 CFR 635.116(c), the contractor shall furnish (a) a competent superintendent or supervisor who is employed by the firm, has full authority to direct performance of the work in accordance with the contract requirements, and is in charge of all construction operations (regardless of who performs the work) and (b) such other of its own organizational resources (supervision, management, and engineering services) as the contracting officer determines is necessary to assure the performance of the contract.

4. No portion of the contract shall be sublet, assigned or otherwise disposed of except with the written consent of the contracting officer, or authorized representative, and such consent when given shall not be construed to relieve the contractor of any responsibility for the fulfillment of the contract. Written consent will be given only after the contracting agency has assured that each subcontract is evidenced in writing and that it contains all pertinent provisions and requirements of the prime contract. (based on long-standing interpretation of 23 CFR 635.116).

5. The 30-percent self-performance requirement of paragraph (1) is not applicable to design-build contracts; however, contracting agencies may establish their own self-performance requirements. 23 CFR 635.116(d).

## VII. SAFETY: ACCIDENT PREVENTION

This provision is applicable to all Federal-aid construction contracts and to all related subcontracts.

1. In the performance of this contract the contractor shall comply with all applicable Federal, State, and local laws governing safety, health, and sanitation (23 CFR Part 635). The contractor shall provide all safeguards, safety devices and protective equipment and take any other needed actions as it determines, or as the contracting officer may determine, to be reasonably necessary to protect the life and health of employees on the job and the safety of the public and to protect property in connection with the performance of the work covered by the contract. 23 CFR 635.108.

2. It is a condition of this contract, and shall be made a condition of each subcontract, which the contractor enters into pursuant to this contract, that the contractor and any subcontractor shall not permit any employee, in performance of the contract, to work in surroundings or under conditions which are unsanitary, hazardous or dangerous to his/her health or safety, as determined under construction safety and

health standards (29 CFR Part 1926) promulgated by the Secretary of Labor, in accordance with Section 107 of the Contract Work Hours and Safety Standards Act (40 U.S.C. 3704). 29 CFR 1926.10.

3. Pursuant to 29 CFR 1926.3, it is a condition of this contract that the Secretary of Labor or authorized representative thereof, shall have right of entry to any site of contract performance to inspect or investigate the matter of compliance with the construction safety and health standards and to carry out the duties of the Secretary under Section 107 of the Contract Work Hours and Safety Standards Act (40 U.S.C. 3704).

## VIII. FALSE STATEMENTS CONCERNING HIGHWAY PROJECTS

This provision is applicable to all Federal-aid construction contracts and to all related subcontracts.

In order to assure high quality and durable construction in conformity with approved plans and specifications and a high degree of reliability on statements and representations made by engineers, contractors, suppliers, and workers on Federal-aid highway projects, it is essential that all persons concerned with the project perform their functions as carefully, thoroughly, and honestly as possible. Willful falsification, distortion, or misrepresentation with respect to any facts related to the project is a violation of Federal law. To prevent any misunderstanding regarding the seriousness of these and similar acts, Form FHWA-1022 shall be posted on each Federal-aid highway project (23 CFR Part 635) in one or more places where it is readily available to all persons concerned with the project:

18 U.S.C. 1020 reads as follows:

"Whoever, being an officer, agent, or employee of the United States, or of any State or Territory, or whoever, whether a person, association, firm, or corporation, knowingly makes any false statement, false representation, or false report as to the character, quality, quantity, or cost of the material used or to be used, or the quantity or quality of the work performed or to be performed, or the cost thereof in connection with the submission of plans, maps, specifications, contracts, or costs of construction on any highway or related project submitted for approval to the Secretary of Transportation; or

Whoever knowingly makes any false statement, false representation, false report or false claim with respect to the character, quality, quantity, or cost of any work performed or to be performed, or materials furnished or to be furnished, in connection with the construction of any highway or related project approved by the Secretary of Transportation; or

Whoever knowingly makes any false statement or false representation as to material fact in any statement, certificate, or report submitted pursuant to provisions of the Federal-aid Roads Act approved July 11, 1916, (39 Stat. 355), as amended and supplemented;

Shall be fined under this title or imprisoned not more than 5 years or both."



**IX. IMPLEMENTATION OF CLEAN AIR ACT AND FEDERAL WATER POLLUTION CONTROL ACT (42 U.S.C. 7606; 2 CFR 200.88; EO 11738)**

This provision is applicable to all Federal-aid construction contracts in excess of \$150,000 and to all related subcontracts. 48 CFR 2.101; 2 CFR 200.327.

By submission of this bid/proposal or the execution of this contract or subcontract, as appropriate, the bidder, proposer, Federal-aid construction contractor, subcontractor, supplier, or vendor agrees to comply with all applicable standards, orders or regulations issued pursuant to the Clean Air Act (42 U.S.C. 7401-7671q) and the Federal Water Pollution Control Act, as amended (33 U.S.C. 1251-1387). Violations must be reported to the Federal Highway Administration and the Regional Office of the Environmental Protection Agency. 2 CFR Part 200, Appendix II.

The contractor agrees to include or cause to be included the requirements of this Section in every subcontract, and further agrees to take such action as the contracting agency may direct as a means of enforcing such requirements. 2 CFR 200.327.

**X. CERTIFICATION REGARDING DEBARMENT, SUSPENSION, INELIGIBILITY AND VOLUNTARY EXCLUSION**

This provision is applicable to all Federal-aid construction contracts, design-build contracts, subcontracts, lower-tier subcontracts, purchase orders, lease agreements, consultant contracts or any other covered transaction requiring FHWA approval or that is estimated to cost \$25,000 or more – as defined in 2 CFR Parts 180 and 1200. 2 CFR 180.220 and 1200.220.

**1. Instructions for Certification – First Tier Participants:**

- a. By signing and submitting this proposal, the prospective first tier participant is providing the certification set out below.
- b. The inability of a person to provide the certification set out below will not necessarily result in denial of participation in this covered transaction. The prospective first tier participant shall submit an explanation of why it cannot provide the certification set out below. The certification or explanation will be considered in connection with the department or agency's determination whether to enter into this transaction. However, failure of the prospective first tier participant to furnish a certification or an explanation shall disqualify such a person from participation in this transaction. 2 CFR 180.320.
- c. The certification in this clause is a material representation of fact upon which reliance was placed when the contracting agency determined to enter into this transaction. If it is later determined that the prospective participant knowingly rendered an erroneous certification, in addition to other remedies available to the Federal Government, the contracting agency may terminate this transaction for cause of default. 2 CFR 180.325.
- d. The prospective first tier participant shall provide immediate written notice to the contracting agency to whom this proposal is submitted if any time the prospective first tier participant learns that its certification was erroneous when submitted or has become erroneous by reason of changed circumstances. 2 CFR 180.345 and 180.350.

e. The terms "covered transaction," "debarred," "suspended," "ineligible," "participant," "person," "principal," and "voluntarily excluded," as used in this clause, are defined in 2 CFR Parts 180, Subpart I, 180.900-180.1020, and 1200. "First Tier Covered Transactions" refers to any covered transaction between a recipient or subrecipient of Federal funds and a participant (such as the prime or general contract). "Lower Tier Covered Transactions" refers to any covered transaction under a First Tier Covered Transaction (such as subcontracts). "First Tier Participant" refers to the participant who has entered into a covered transaction with a recipient or subrecipient of Federal funds (such as the prime or general contractor). "Lower Tier Participant" refers any participant who has entered into a covered transaction with a First Tier Participant or other Lower Tier Participants (such as subcontractors and suppliers).

f. The prospective first tier participant agrees by submitting this proposal that, should the proposed covered transaction be entered into, it shall not knowingly enter into any lower tier covered transaction with a person who is debarred, suspended, declared ineligible, or voluntarily excluded from participation in this covered transaction, unless authorized by the department or agency entering into this transaction. 2 CFR 180.330.

g. The prospective first tier participant further agrees by submitting this proposal that it will include the clause titled "Certification Regarding Debarment, Suspension, Ineligibility and Voluntary Exclusion-Lower Tier Covered Transactions," provided by the department or contracting agency, entering into this covered transaction, without modification, in all lower tier covered transactions and in all solicitations for lower tier covered transactions exceeding the \$25,000 threshold. 2 CFR 180.220 and 180.300.

h. A participant in a covered transaction may rely upon a certification of a prospective participant in a lower tier covered transaction that is not debarred, suspended, ineligible, or voluntarily excluded from the covered transaction, unless it knows that the certification is erroneous. 2 CFR 180.300; 180.320, and 180.325. A participant is responsible for ensuring that its principals are not suspended, debarred, or otherwise ineligible to participate in covered transactions. 2 CFR 180.335. To verify the eligibility of its principals, as well as the eligibility of any lower tier prospective participants, each participant may, but is not required to, check the System for Award Management website (<https://www.sam.gov>). 2 CFR 180.300, 180.320, and 180.325.

i. Nothing contained in the foregoing shall be construed to require the establishment of a system of records in order to render in good faith the certification required by this clause. The knowledge and information of the prospective participant is not required to exceed that which is normally possessed by a prudent person in the ordinary course of business dealings.

j. Except for transactions authorized under paragraph (f) of these instructions, if a participant in a covered transaction knowingly enters into a lower tier covered transaction with a person who is suspended, debarred, ineligible, or voluntarily excluded from participation in this transaction, in addition to other remedies available to the Federal Government, the department or agency may terminate this transaction for cause or default. 2 CFR 180.325.

\* \* \* \* \*

**2. Certification Regarding Debarment, Suspension, Ineligibility and Voluntary Exclusion – First Tier Participants:**

a. The prospective first tier participant certifies to the best of its knowledge and belief, that it and its principals:

(1) Are not presently debarred, suspended, proposed for debarment, declared ineligible, or voluntarily excluded from participating in covered transactions by any Federal department or agency, 2 CFR 180.335;

(2) Have not within a three-year period preceding this proposal been convicted of or had a civil judgment rendered against them for commission of fraud or a criminal offense in connection with obtaining, attempting to obtain, or performing a public (Federal, State, or local) transaction or contract under a public transaction; violation of Federal or State antitrust statutes or commission of embezzlement, theft, forgery, bribery, falsification or destruction of records, making false statements, or receiving stolen property, 2 CFR 180.800;

(3) Are not presently indicted for or otherwise criminally or civilly charged by a governmental entity (Federal, State or local) with commission of any of the offenses enumerated in paragraph (a)(2) of this certification, 2 CFR 180.700 and 180.800; and

(4) Have not within a three-year period preceding this application/proposal had one or more public transactions (Federal, State or local) terminated for cause or default. 2 CFR 180.335(d).

(5) Are not a corporation that has been convicted of a felony violation under any Federal law within the two-year period preceding this proposal (USDOT Order 4200.6 implementing appropriations act requirements); and

(6) Are not a corporation with any unpaid Federal tax liability that has been assessed, for which all judicial and administrative remedies have been exhausted, or have lapsed, and that is not being paid in a timely manner pursuant to an agreement with the authority responsible for collecting the tax liability (USDOT Order 4200.6 implementing appropriations act requirements).

b. Where the prospective participant is unable to certify to any of the statements in this certification, such prospective participant should attach an explanation to this proposal. 2 CFR 180.335 and 180.340.

\*\*\*\*\*

**3. Instructions for Certification - Lower Tier Participants:**

(Applicable to all subcontracts, purchase orders, and other lower tier transactions requiring prior FHWA approval or estimated to cost \$25,000 or more - 2 CFR Parts 180 and 1200). 2 CFR 180.220 and 1200.220.

a. By signing and submitting this proposal, the prospective lower tier participant is providing the certification set out below.

b. The certification in this clause is a material representation of fact upon which reliance was placed when this transaction was entered into. If it is later determined that the prospective lower tier participant knowingly rendered an erroneous certification, in addition to other remedies available to the Federal Government, the department, or agency with which

this transaction originated may pursue available remedies, including suspension and/or debarment.

c. The prospective lower tier participant shall provide immediate written notice to the person to which this proposal is submitted if at any time the prospective lower tier participant learns that its certification was erroneous by reason of changed circumstances. 2 CFR 180.365.

d. The terms "covered transaction," "debarred," "suspended," "ineligible," "participant," "person," "principal," and "voluntarily excluded," as used in this clause, are defined in 2 CFR Parts 180, Subpart I, 180.900 – 180.1020, and 1200. You may contact the person to which this proposal is submitted for assistance in obtaining a copy of those regulations. "First Tier Covered Transactions" refers to any covered transaction between a recipient or subrecipient of Federal funds and a participant (such as the prime or general contract). "Lower Tier Covered Transactions" refers to any covered transaction under a First Tier Covered Transaction (such as subcontracts). "First Tier Participant" refers to the participant who has entered into a covered transaction with a recipient or subrecipient of Federal funds (such as the prime or general contractor). "Lower Tier Participant" refers any participant who has entered into a covered transaction with a First Tier Participant or other Lower Tier Participants (such as subcontractors and suppliers).

e. The prospective lower tier participant agrees by submitting this proposal that, should the proposed covered transaction be entered into, it shall not knowingly enter into any lower tier covered transaction with a person who is debarred, suspended, declared ineligible, or voluntarily excluded from participation in this covered transaction, unless authorized by the department or agency with which this transaction originated. 2 CFR 1200.220 and 1200.332.

f. The prospective lower tier participant further agrees by submitting this proposal that it will include this clause titled "Certification Regarding Debarment, Suspension, Ineligibility and Voluntary Exclusion-Lower Tier Covered Transaction," without modification, in all lower tier covered transactions and in all solicitations for lower tier covered transactions exceeding the \$25,000 threshold. 2 CFR 180.220 and 1200.220.

g. A participant in a covered transaction may rely upon a certification of a prospective participant in a lower tier covered transaction that is not debarred, suspended, ineligible, or voluntarily excluded from the covered transaction, unless it knows that the certification is erroneous. A participant is responsible for ensuring that its principals are not suspended, debarred, or otherwise ineligible to participate in covered transactions. To verify the eligibility of its principals, as well as the eligibility of any lower tier prospective participants, each participant may, but is not required to, check the System for Award Management website (<https://www.sam.gov/>), which is compiled by the General Services Administration. 2 CFR 180.300, 180.320, 180.330, and 180.335.

h. Nothing contained in the foregoing shall be construed to require establishment of a system of records in order to render in good faith the certification required by this clause. The knowledge and information of participant is not required to exceed that which is normally possessed by a prudent person in the ordinary course of business dealings.

i. Except for transactions authorized under paragraph e of these instructions, if a participant in a covered transaction knowingly enters into a lower tier covered transaction with a person who is suspended, debarred, ineligible, or voluntarily



excluded from participation in this transaction, in addition to other remedies available to the Federal Government, the department or agency with which this transaction originated may pursue available remedies, including suspension and/or debarment. 2 CFR 180.325.

\*\*\*\*\*

**4. Certification Regarding Debarment, Suspension, Ineligibility and Voluntary Exclusion--Lower Tier Participants:**

a. The prospective lower tier participant certifies, by submission of this proposal, that neither it nor its principals:

(1) is presently debarred, suspended, proposed for debarment, declared ineligible, or voluntarily excluded from participating in covered transactions by any Federal department or agency, 2 CFR 180.355;

(2) is a corporation that has been convicted of a felony violation under any Federal law within the two-year period preceding this proposal (USDOT Order 4200.6 implementing appropriations act requirements); and

(3) is a corporation with any unpaid Federal tax liability that has been assessed, for which all judicial and administrative remedies have been exhausted, or have lapsed, and that is not being paid in a timely manner pursuant to an agreement with the authority responsible for collecting the tax liability. (USDOT Order 4200.6 implementing appropriations act requirements)

b. Where the prospective lower tier participant is unable to certify to any of the statements in this certification, such prospective participant should attach an explanation to this proposal.

\*\*\*\*\*

**XI. CERTIFICATION REGARDING USE OF CONTRACT FUNDS FOR LOBBYING**

This provision is applicable to all Federal-aid construction contracts and to all related subcontracts which exceed \$100,000. 49 CFR Part 20, App. A.

1. The prospective participant certifies, by signing and submitting this bid or proposal, to the best of his or her knowledge and belief, that:

a. No Federal appropriated funds have been paid or will be paid, by or on behalf of the undersigned, to any person for influencing or attempting to influence an officer or employee of any Federal agency, a Member of Congress, an officer or employee of Congress, or an employee of a Member of Congress in connection with the awarding of any Federal contract, the making of any Federal grant, the making of any Federal loan, the entering into of any cooperative agreement, and the extension, continuation, renewal, amendment, or modification of any Federal contract, grant, loan, or cooperative agreement.

b. If any funds other than Federal appropriated funds have been paid or will be paid to any person for influencing or attempting to influence an officer or employee of any Federal agency, a Member of Congress, an officer or employee of Congress, or an employee of a Member of Congress in connection with this Federal contract, grant, loan, or

cooperative agreement, the undersigned shall complete and submit Standard Form-LLL, "Disclosure Form to Report Lobbying," in accordance with its instructions.

2. This certification is a material representation of fact upon which reliance was placed when this transaction was made or entered into. Submission of this certification is a prerequisite for making or entering into this transaction imposed by 31 U.S.C. 1352. Any person who fails to file the required certification shall be subject to a civil penalty of not less than \$10,000 and not more than \$100,000 for each such failure.

3. The prospective participant also agrees by submitting its bid or proposal that the participant shall require that the language of this certification be included in all lower tier subcontracts, which exceed \$100,000 and that all such recipients shall certify and disclose accordingly.

**XII. USE OF UNITED STATES-FLAG VESSELS:**

This provision is applicable to all Federal-aid construction contracts, design-build contracts, subcontracts, lower-tier subcontracts, purchase orders, lease agreements, or any other covered transaction. 46 CFR Part 381.

This requirement applies to material or equipment that is acquired for a specific Federal-aid highway project. 46 CFR 381.7. It is not applicable to goods or materials that come into inventories independent of an FHWA funded-contract.

When oceanic shipments (or shipments across the Great Lakes) are necessary for materials or equipment acquired for a specific Federal-aid construction project, the bidder, proposer, contractor, subcontractor, or vendor agrees:

1. To utilize privately owned United States-flag commercial vessels to ship at least 50 percent of the gross tonnage (computed separately for dry bulk carriers, dry cargo liners, and tankers) involved, whenever shipping any equipment, material, or commodities pursuant to this contract, to the extent such vessels are available at fair and reasonable rates for United States-flag commercial vessels. 46 CFR 381.7.

2. To furnish within 20 days following the date of loading for shipments originating within the United States or within 30 working days following the date of loading for shipments originating outside the United States, a legible copy of a rated, 'on-board' commercial ocean bill-of-lading in English for each shipment of cargo described in paragraph (b)(1) of this section to both the Contracting Officer (through the prime contractor in the case of subcontractor bills-of-lading) and to the Office of Cargo and Commercial Sealift (MAR-620), Maritime Administration, Washington, DC 20590. (MARAD requires copies of the ocean carrier's (master) bills of lading, certified onboard, dated, with rates and charges. These bills of lading may contain business sensitive information and therefore may be submitted directly to MARAD by the Ocean Transportation Intermediary on behalf of the contractor). 46 CFR 381.7.

**ATTACHMENT A - EMPLOYMENT AND MATERIALS  
PREFERENCE FOR APPALACHIAN DEVELOPMENT  
HIGHWAY SYSTEM OR APPALACHIAN LOCAL ACCESS  
ROAD CONTRACTS** (23 CFR 633, Subpart B, Appendix B)

This provision is applicable to all Federal-aid projects funded under the Appalachian Regional Development Act of 1965.

1. During the performance of this contract, the contractor undertaking to do work which is, or reasonably may be, done as on-site work, shall give preference to qualified persons who regularly reside in the labor area as designated by the DOL wherein the contract work is situated, or the subregion, or the Appalachian counties of the State wherein the contract work is situated, except:

a. To the extent that qualified persons regularly residing in the area are not available.

b. For the reasonable needs of the contractor to employ supervisory or specially experienced personnel necessary to assure an efficient execution of the contract work.

c. For the obligation of the contractor to offer employment to present or former employees as the result of a lawful collective bargaining contract, provided that the number of nonresident persons employed under this subparagraph (1c) shall not exceed 20 percent of the total number of employees employed by the contractor on the contract work, except as provided in subparagraph (4) below.

2. The contractor shall place a job order with the State Employment Service indicating (a) the classifications of the laborers, mechanics and other employees required to perform the contract work, (b) the number of employees required in each classification, (c) the date on which the participant estimates such employees will be required, and (d) any other pertinent information required by the State Employment Service to complete the job order form. The job order may be placed with the State Employment Service in writing or by telephone. If during the course of the contract work, the information submitted by the contractor in the original job order is substantially modified, the participant shall promptly notify the State Employment Service.

3. The contractor shall give full consideration to all qualified job applicants referred to him by the State Employment Service. The contractor is not required to grant employment to any job applicants who, in his opinion, are not qualified to perform the classification of work required.

4. If, within one week following the placing of a job order by the contractor with the State Employment Service, the State Employment Service is unable to refer any qualified job applicants to the contractor, or less than the number requested, the State Employment Service will forward a certificate to the contractor indicating the unavailability of applicants. Such certificate shall be made a part of the contractor's permanent project records. Upon receipt of this certificate, the contractor may employ persons who do not normally reside in the labor area to fill positions covered by the certificate, notwithstanding the provisions of subparagraph (1c) above.

5. The provisions of 23 CFR 633.207(e) allow the contracting agency to provide a contractual preference for the use of mineral resource materials native to the Appalachian region.

6. The contractor shall include the provisions of Sections 1 through 4 of this Attachment A in every subcontract for work which is, or reasonably may be, done as on-site work.

**KENTUCKY TRANSPORTATION CABINET  
DEPARTMENT OF HIGHWAYS**

**EMPLOYMENT REQUIREMENTS  
RELATING TO  
NONDISCRIMINATION OF EMPLOYEES  
(APPLICABLE TO FEDERAL-AID SYSTEM CONTRACTS)**

**AN ACT OF THE KENTUCKY GENERAL ASSEMBLY  
TO PREVENT DISCRIMINATION IN EMPLOYMENT**

**KRS CHAPTER 344  
EFFECTIVE JUNE 16, 1972**

The contract on this project, in accordance with KRS Chapter 344, provides that during the performance of this contract, the contractor agrees as follows:

1. The contractor shall not fail or refuse to hire, or shall not discharge any individual, or otherwise discriminate against an individual with respect to his compensation, terms, conditions, or privileges of employment, because of such individual's race, color, religion, national origin, sex, disability or age (forty and above); or limit, segregate, or classify his employees in any way which would deprive or tend to deprive an individual of employment opportunities or otherwise adversely affect his status as an employee, because of such individual's race, color, religion, national origin, sex, disability or age forty (40) and over. The contractor agrees to post in conspicuous places, available to employees and applicants for employment, notices to be provided setting forth the provisions of this nondiscrimination clause.

2. The contractor shall not print or publish or cause to be printed or published a notice or advertisement relating to employment by such an employer or membership in or any classification or referral for employment by the employment agency, indicating any preference, limitation, specification, or discrimination, based on race, color, religion, national origin, sex, or age forty (40) and over, or because the person is a qualified individual with a disability, except that such a notice or advertisement may indicate a preference, limitation, or specification based on religion, national origin, sex, or age forty (40) and over, or because the person is a qualified individual with a disability, when religion, national origin, sex, or age forty (40) and over, or because the person is a qualified individual with a disability, is a bona fide occupational qualification for employment.

3. If the contractor is in control of apprenticeship or other training or retraining, including on-the-job training programs, he shall not discriminate against an individual because of his race, color, religion, national origin, sex, disability or age forty (40) and over, in admission to, or employment in any program established to provide apprenticeship or other training.

4. The contractor will send to each labor union or representative of workers with which he has a collective bargaining agreement or other contract or understanding, a notice to be provided advising the said labor union or workers' representative of the contractor's commitments under this section, and shall post copies of the notice in conspicuous places available to employees and applicants for employment. The contractor will take such action with respect to any subcontract or purchase order as the administering agency may direct as a means of enforcing such provisions, including sanctions for non-compliance.

Revised: January 25, 2017

### Standard Title VI/Non-Discrimination Assurances

During the performance of this contract, the contractor, for itself, its assignees, and successors in interest (hereinafter referred to as the "contractor") agrees as follows:

1. **Compliance with Regulations:** The contractor (hereinafter includes consultants) will comply with the Acts and the Regulations relative to Non-discrimination in Federally-assisted programs of the U.S. Department of Transportation, **Federal Highway Administration**, as they may be amended from time to time, which are herein incorporated by reference and made a part of this contract.
2. **Non-discrimination:** The contractor, with regard to the work performed by it during the contract, will not discriminate on the grounds of race, color, or national origin in the selection and retention of subcontractors, including procurements of materials and leases of equipment. The contractor will not participate directly or indirectly in the discrimination prohibited by the Acts and the Regulations, including employment practices when the contract covers any activity, project, or program set forth in Appendix B of 49 CFR Part 21.
3. **Solicitations for Subcontracts, Including Procurements of Materials and Equipment:** In all solicitations, either by competitive bidding, or negotiation made by the contractor for work to be performed under a subcontract, including procurements of materials, or leases of equipment, each potential subcontractor or supplier will be notified by the contractor of the contractor's obligations under this contract and the Acts and the Regulations relative to Non-discrimination on the grounds of race, color, or national origin.
4. **Information and Reports:** The contractor will provide all information and reports required by the Acts, the Regulations, and directives issued pursuant thereto and will permit access to its books, records, accounts, other sources of information, and its facilities as may be determined by the Recipient or the **Federal Highway Administration** to be pertinent to ascertain compliance with such Acts, Regulations, and instructions. Where any information required of a contractor is in the exclusive possession of another who fails or refuses to furnish the information, the contractor will so certify to the Recipient or the **Federal Highway Administration**, as appropriate, and will set forth what efforts it has made to obtain the information.
5. **Sanctions for Noncompliance:** In the event of a contractor's noncompliance with the Non-discrimination provisions of this contract, the Recipient will impose such contract sanctions as it or the **Federal Highway Administration** may determine to be appropriate, including, but not limited to:
  - a. withholding payments to the contractor under the contract until the contractor complies; and/or
  - b. cancelling, terminating, or suspending a contract, in whole or in part.
6. **Incorporation of Provisions:** The contractor will include the provisions of paragraphs one through six in every subcontract, including procurements of materials and leases of equipment, unless exempt by the Acts, the Regulations and directives issued pursuant thereto. The contractor will take action with respect to any subcontract or procurement as the Recipient or the **Federal Highway Administration** may direct as a means of enforcing such provisions including sanctions for noncompliance. Provided, that if the contractor becomes involved in, or is threatened with litigation by a subcontractor, or supplier because of such direction, the contractor may request the Recipient to enter into any litigation to protect the interests of the Recipient. In addition, the contractor may request the United States to enter into the litigation to protect the interests of the United States.

### Standard Title VI/Non-Discrimination Statutes and Authorities

During the performance of this contract, the contractor, for itself, its assignees, and successors in interest (hereinafter referred to as the “contractor”) agrees to comply with the following non-discrimination statutes and authorities; including but not limited to:

- Title VI of the Civil Rights Act of 1964 (42 U.S.C. § 2000d *et seq.*, 78 stat. 252), (prohibits discrimination on the basis of race, color, national origin); and 49 CFR Part 21;
- The Uniform Relocation Assistance and Real Property Acquisition Policies Act of 1970, (42 U.S.C. § 4601), (prohibits unfair treatment of persons displaced or whose property has been acquired because of Federal or Federal-aid programs and projects);
- Federal-Aid Highway Act of 1973, (23 U.S.C. § 324 *et seq.*), (prohibits discrimination on the basis of sex);
- Section 504 of the Rehabilitation Act of 1973, (29 U.S.C. § 794 *et seq.*), as amended, (prohibits discrimination on the basis of disability); and 49 CFR Part 27;
- The Age Discrimination Act of 1975, as amended, (42 U.S.C. § 6101 *et seq.*), (prohibits discrimination on the basis of age);
- Airport and Airway Improvement Act of 1982, (49 USC § 471, Section 47123), as amended, (prohibits discrimination based on race, creed, color, national origin, or sex);
- The Civil Rights Restoration Act of 1987, (PL 100-209), (Broadened the scope, coverage and applicability of Title VI of the Civil Rights Act of 1964, The Age Discrimination Act of 1975 and Section 504 of the Rehabilitation Act of 1973, by expanding the definition of the terms “programs or activities” to include all of the programs or activities of the Federal-aid recipients, sub-recipients and contractors, whether such programs or activities are Federally funded or not);
- Titles II and III of the Americans with Disabilities Act, which prohibit discrimination on the basis of disability in the operation of public entities, public and private transportation systems, places of public accommodation, and certain testing entities (42 U.S.C. §§ 12131 -- 12189) as implemented by Department of Transportation regulations at 49 C.F.R. parts 37 and 38;
- The Federal Aviation Administration’s Non-discrimination statute (49 U.S.C. § 47123) (prohibits discrimination on the basis of race, color, national origin, and sex);
- Executive Order 12898, Federal Actions to Address Environmental Justice in Minority Populations and Low-Income Populations, which ensures non-discrimination against minority populations by discouraging programs, policies, and activities with disproportionately high and adverse human health or environmental effects on minority and low-income populations;
- Executive Order 13166, Improving Access to Services for Persons with Limited English Proficiency, and resulting agency guidance, national origin discrimination includes discrimination because of limited English proficiency (LEP). To ensure compliance with Title VI, you must take reasonable steps to ensure that LEP persons have meaningful access to your programs (70 Fed. Reg. at 74087 to 74100);
- Title IX of the Education Amendments of 1972, as amended, which prohibits you from discriminating because of sex in education programs or activities (20 U.S.C. 1681 *et seq.*)

## EXECUTIVE BRANCH CODE OF ETHICS

In the 1992 regular legislative session, the General Assembly passed and Governor Brereton Jones signed Senate Bill 63 (codified as KRS 11A), the Executive Branch Code of Ethics, which states, in part:

KRS 11A.040 (7) provides:

No present or former public servant shall, within six (6) months following termination of his office or employment, accept employment, compensation, or other economic benefit from any person or business that contracts or does business with, or is regulated by, the state in matters in which he was directly involved during the last thirty-six (36) months of his tenure. This provision shall not prohibit an individual from returning to the same business, firm, occupation, or profession in which he was involved prior to taking office or beginning his term of employment, or for which he received, prior to his state employment, a professional degree or license, provided that, for a period of six (6) months, he personally refrains from working on any matter in which he was directly involved during the last thirty-six (36) months of his tenure in state government. This subsection shall not prohibit the performance of ministerial functions, including but not limited to filing tax returns, filing applications for permits or licenses, or filing incorporation papers, nor shall it prohibit the former officer or public servant from receiving public funds disbursed through entitlement programs.

KRS 11A.040 (9) states:

A former public servant shall not represent a person or business before a state agency in a matter in which the former public servant was directly involved during the last thirty-six (36) months of his tenure, for a period of one (1) year after the latter of:

- a) The date of leaving office or termination of employment; or
- b) The date the term of office expires to which the public servant was elected.

This law is intended to promote public confidence in the integrity of state government and to declare as public policy the idea that state employees should view their work as a public trust and not as a way to obtain private benefits.

If you have worked for the executive branch of state government within the past six months, you may be subject to the law's prohibitions. The law's applicability may be different if you hold elected office or are contemplating representation of another before a state agency.

Also, if you are affiliated with a firm which does business with the state and which employs former state executive-branch employees, you should be aware that the law may apply to them.

In case of doubt, the law permits you to request an advisory opinion from the Executive Branch Ethics Commission, 1025 Capital Center Drive, Suite 104, Frankfort, Kentucky 40601; telephone (502) 564-7954.

Revised: May 23, 2022

"General Decision Number: KY20240038 03/22/2024

Superseded General Decision Number: KY20230038

State: Kentucky

Construction Type: Highway

Counties: Anderson, Bath, Bourbon, Boyd, Boyle, Bracken, Breckinridge, Bullitt, Carroll, Carter, Clark, Elliott, Fayette, Fleming, Franklin, Gallatin, Grant, Grayson, Greenup, Hardin, Harrison, Henry, Jefferson, Jessamine, Larue, Lewis, Madison, Marion, Mason, Meade, Mercer, Montgomery, Nelson, Nicholas, Oldham, Owen, Robertson, Rowan, Scott, Shelby, Spencer, Trimble, Washington and Woodford Counties in Kentucky.

HIGHWAY CONSTRUCTION PROJECTS (excluding tunnels, building structures in rest area projects & railroad construction; bascule, suspension & spandrel arch bridges designed for commercial navigation, bridges involving marine construction; and other major bridges).

Note: Contracts subject to the Davis-Bacon Act are generally required to pay at least the applicable minimum wage rate required under Executive Order 14026 or Executive Order 13658. Please note that these Executive Orders apply to covered contracts entered into by the federal government that are subject to the Davis-Bacon Act itself, but do not apply to contracts subject only to the Davis-Bacon Related Acts, including those set forth at 29 CFR 5.1(a)(1).

<p>If the contract is entered into on or after January 30, 2022, or the contract is renewed or extended (e.g., an option is exercised) on or after January 30, 2022:</p>	<ul style="list-style-type: none"> <li>. Executive Order 14026 generally applies to the contract.</li> <li>. The contractor must pay all covered workers at least \$17.20 per hour (or the applicable wage rate listed on this wage determination, if it is higher) for all hours spent performing on the contract in 2024.</li> </ul>
<p>If the contract was awarded on or between January 1, 2015 and January 29, 2022, and the contract is not renewed or extended on or after January 30, 2022:</p>	<ul style="list-style-type: none"> <li>. Executive Order 13658 generally applies to the contract.</li> <li>. The contractor must pay all covered workers at least \$12.90 per hour (or the applicable wage rate listed on this wage determination, if it is higher) for all hours spent performing on that contract in 2024.</li> </ul>

The applicable Executive Order minimum wage rate will be adjusted annually. If this contract is covered by one of the Executive Orders and a classification considered necessary for performance of work on the contract does not appear on this wage determination, the contractor must still submit a



conformance request.

Additional information on contractor requirements and worker protections under the Executive Orders is available at <http://www.dol.gov/whd/govcontracts>.

Modification Number	Publication Date
0	01/05/2024
1	02/09/2024
2	03/01/2024
3	03/15/2024
4	03/22/2024

BRIN0004-003 06/01/2023

BRECKENRIDGE COUNTY

	Rates	Fringes
BRICKLAYER.....	\$ 34.17	19.60

BRKY0001-005 06/01/2023

BULLITT, CARROLL, GRAYSON, HARDIN, HENRY, JEFFERSON, LARUE, MARION, MEADE, NELSON, OLDHAM, SHELBY, SPENCER, & TRIMBLE COUNTIES:

	Rates	Fringes
BRICKLAYER.....	\$ 33.48	15.92

BRKY0002-006 06/01/2023

BRACKEN, GALLATIN, GRANT, MASON & ROBERTSON COUNTIES:

	Rates	Fringes
BRICKLAYER.....	\$ 33.48	15.92

BRKY0007-004 06/01/2023

BOYD, CARTER, ELLIOT, FLEMING, GREENUP, LEWIS & ROWAN COUNTIES:

	Rates	Fringes
BRICKLAYER.....	\$ 39.46	20.14

BRKY0017-004 06/01/2023

ANDERSON, BATH, BOURBON, BOYLE, CLARK, FAYETTE, FRANKLIN, HARRISON, JESSAMINE, MADISON, MERCER, MONTGOMERY, NICHOLAS, OWEN, SCOTT, WASHINGTON & WOODFORD COUNTIES:

	Rates	Fringes
BRICKLAYER.....	\$ 33.48	15.92

CARP0064-001 04/01/2023

	Rates	Fringes
CARPENTER.....	\$ 31.81	22.86

Diver.....	\$ 48.09	22.86
PILEDRIVERMAN.....	\$ 32.06	22.86

-----  
\* ELEC0212-008 06/05/2023

BRACKEN, GALLATIN and GRANT COUNTIES

	Rates	Fringes
ELECTRICIAN.....	\$ 34.41	21.55

-----  
\* ELEC0212-014 11/27/2023

BRACKEN, GALLATIN & GRANT COUNTIES:

	Rates	Fringes
Sound & Communication Technician.....	\$ 27.20	14.54

-----  
ELEC0317-012 05/29/2023

BOYD, CARTER, ELLIOT & ROWAN COUNTIES:

	Rates	Fringes
ELECTRICIAN (Wiremen).....	\$ 37.15	22.73

-----  
ELEC0369-007 05/28/2023

ANDERSON, BATH, BOURBON, BOYLE, BRECKINRIDGE, BULLITT, CARROLL,  
CLARK, FAYETTE, FRAONKLIN, GRAYSON, HARDIN, HARRISON, HENRY,  
JEFFERSON, JESSAMINE, LARUE, MADISON, MARION, MEADE, MERCER,  
MONTGOMERY, NELSON, NICHOLAS, OLDHAM, OWEN, ROBERTSON, SCOTT,  
SHELBY, SPENCER, TRIMBLE, WASHINGTON, & WOODFORD COUNTIES:

	Rates	Fringes
ELECTRICIAN.....	\$ 35.39	20.45

-----  
ELEC0575-002 05/29/2023

FLEMING, GREENUP, LEWIS & MASON COUNTIES:

	Rates	Fringes
ELECTRICIAN.....	\$ 37.00	22.26

-----  
ENGI0181-018 07/01/2023

	Rates	Fringes
POWER EQUIPMENT OPERATOR		
GROUP 1.....	\$ 38.55	18.60
GROUP 2.....	\$ 35.69	18.60
GROUP 3.....	\$ 36.14	18.60
GROUP 4.....	\$ 35.37	18.60

OPERATING ENGINEER CLASSIFICATIONS

GROUP 1 - A-Frame Winch Truck; Auto Patrol; Backfiller;  
Batcher Plant; Bituminous Paver; Bituminous Transfer  
Machine; Boom Cat; Bulldozer; Mechanic; Cableway; Carry-All  
Scoop; Carry Deck Crane; Central Compressor Plant; Cherry

Picker; Clamshell; Concrete Mixer (21 cu. ft. or Over); Concrete Paver; Truck-Mounted Concrete Pump; Core Drill; Crane; Crusher Plant; Derrick; Derrick Boat; Ditching & Trenching Machine; Dragline; Dredge Operator; Dredge Engineer; Elevating Grader & Loaders; Grade-All; Gurries; Heavy Equipment Robotics Operator/Mechanic; High Lift; Hoe-Type Machine; Hoist (Two or More Drums); Hoisting Engine (Two or More Drums); Horizontal Directional Drill Operator; Hydrocrane; Hyster; KeCal Loader; LeTourneau; Locomotive; Mechanic; Mechanically Operated Laser Screed; Mechanic Welder; Mucking Machine; Motor Scraper; Orangepeel Bucket; Overhead Crane; Piledriver; Power Blade; Pumpcrete; Push Dozer; Rock Spreader, attached to equipment; Rotary Drill; Roller (Bituminous); Rough Terrain Crane; Scarifier; Scoopmobile; Shovel; Side Boom; Subgrader; Tailboom; Telescoping Type Forklift; Tow or Push Boat; Tower Crane (French, German & other types); Tractor Shovel; Truck Crane; Tunnel Mining Machines, including Moles, Shields or similar types of Tunnel Mining Equipment

GROUP 2 - Air Compressor (Over 900 cu. ft. per min.); Bituminous Mixer; Boom Type Tamping Machine; Bull Float; Concrete Mixer (Under 21 cu. ft.); Dredge Engineer; Electric Vibrator; Compactor/Self-Propelled Compactor; Elevator (One Drum or Buck Hoist); Elevator (When used to Hoist Building Material); Finish Machine; Firemen & Hoist (One Drum); Flexplane; Forklift (Regardless of Lift Height); Form Grader; Joint Sealing Machine; Outboard Motor Boat; Power Sweeper (Riding Type); Roller (Rock); Ross Carrier; Skid Mounted or Trailer Mounted Concrete Pump; Skid Steer Machine with all Attachments; Switchman or Brakeman; Throttle Valve Person; Tractair & Road Widening Trencher; Tractor (50 H.P. or Over); Truck Crane Oiler; Tugger; Welding Machine; Well Points; & Whirley Oiler

GROUP 3 - All Off Road Material Handling Equipment, including Articulating Dump Trucks; Greaser on Grease Facilities servicing Heavy Equipment

GROUP 4 - Bituminous Distributor; Burlap & Curing Machine; Cement Gun; Concrete Saw; Conveyor; Deckhand Oiler; Grout Pump; Hydraulic Post Driver; Hydro Seeder; Mud Jack; Oiler; Paving Joint Machine; Power Form Handling Equipment; Pump; Roller (Earth); Steerman; Tamping Machine; Tractor (Under 50 H.P.); & Vibrator

CRANES - with booms 150 ft. & Over (Including JIB), and where the length of the boom in combination with the length of the piling leads equals or exceeds 150 ft. - \$1.00 over Group 1 rate

EMPLOYEES ASSIGNED TO WORK BELOW GROUND LEVEL ARE TO BE PAID 10%

ABOVE BASIC WAGE RATE. THIS DOES NOT APPLY TO OPEN CUT WORK.

-----  
IRON0044-009 06/01/2023

BRACKEN, GALLATIN, GRANT, HARRISON, ROBERTSON,  
BOURBON (Northern third, including Townships of Jackson, Millersburg, Ruddel Mills & Shawhan);  
CARROLL (Eastern third, including the Township of Ghent);  
FLEMING (Western part, excluding Townships of Beechburg, Colfax, Elizaville, Flemingsburg, Flemingsburg Junction, Foxport, Grange City, Hillsboro, Hilltop, Mount Carmel, Muses Mills,

Nepton, Pecksridge, Plummers Landing, Plummers Mill, Poplar Plains, Ringos Mills, Tilton & Wallingford);  
 MASON (Western two-thirds, including Townships of Dover, Lewisburg, Mays Lick, Maysville, Minerva, Moranburg, Murphysville, Ripley, Sardis, Shannon, South Ripley & Washington);  
 NICHOLAS (Townships of Barefoot, Barterville, Carlisle, Ellisville, Headquarters, Henryville, Morningglory, Myers & Oakland Mills);  
 OWEN (Townships of Beechwood, Bromley, Fairbanks, Holbrook, Jonesville, Long Ridge, Lusby's Mill, New, New Columbus, New Liberty, Owenton, Poplar Grove, Rockdale, Sanders, Teresita & Wheatley);  
 SCOTT (Northern two-thirds, including Townships of Biddle, Davis, Delaplain, Elmville, Longlick, Muddy Ford, Oxford, Rogers Gap, Sadieville, Skimmersburg & Stonewall)

	Rates	Fringes
IRONWORKER		
Fence Erector.....	\$ 30.75	22.70
Structural.....	\$ 32.37	22.70

-----  
 IRON0070-006 06/01/2023

ANDERSON, BOYLE, BRECKINRIDGE, BULLITT, FAYETTE, FRANKLIN, GRAYSON, HARDIN, HENRY, JEFFERSON, JESSAMINE, LARUE, MADISON, MARION, MEADE, MERCER, NELSON, OLDHAM, SHELBY, SPENCER, TRIMBLE, WASHINGTON & WOODFORD  
 BOURBON (Southern two-thirds, including Townships of Austerlity, Centerville, Clintonville, Elizabeth, Hutchison, Littlerock, North Middletown & Paris);  
 CARROLL (Western two-thirds, including Townships of Carrollton, Easterday, English, Locust, Louis, Prestonville & Worthville);  
 CLARK (Western two-thirds, including Townships of Becknerville, Flanagan, Ford, Pine Grove, Winchester & Wyandotte);  
 OWEN (Eastern eighth, including Townships of Glenmary, Gratz, Monterey, Perry Park & Tacketts Mill);  
 SCOTT (Southern third, including Townships of Georgetown, Great Crossing, Newtown, Stampling Ground & Woodlake);

	Rates	Fringes
IRONWORKER.....	\$ 32.59	24.50

-----  
 IRON0769-007 06/01/2023

BATH, BOYD, CARTER, ELLIOTT, GREENUP, LEWIS, MONTGOMERY & ROWAN  
 CLARK (Eastern third, including townships of Bloomingdale, Hunt, Indian Fields, Kiddville, Loglick, Rightangele & Thomson);  
 FLEMING (Townships of Beechburg, Colfax, Elizaville, Flemingsburg, Flemingsburg Junction, Foxport, Grange City, Hillsboro, Hilltop, Mount Carmel, Muses Mills, Nepton, Pecksridge, Plummers Landing, Plummers Mill, Poplar Plains, Ringos Mills, Tilton & Wallingford);  
 MASON (Eastern third, including Townships of Helena, Marshall, Orangeburg, Plumville & Springdale);  
 NICHOLAS (Eastern eighth, including the Township of Moorefield Sprout)

	Rates	Fringes
--	-------	---------

IRONWORKER

ZONE 1.....	\$ 36.16	28.34
ZONE 2.....	\$ 36.56	28.34
ZONE 3.....	\$ 38.16	28.34

ZONE 1 - (no base rate increase) Up to 10 mile radius of Union Hall, 1643 Greenup Ave, Ashland, KY.

ZONE 2 - (add \$0.40 per hour to base rate) 10 to 50 mile radius of Union Hall, 1643 Greenup Ave, Ashland, KY.

ZONE 3 - (add \$2.00 per hour to base rate) 50 mile radius & over of Union Hall, 1643 Greenup Ave, Ashland, KY.

-----  
LAB00189-003 07/01/2023

BATH, BOURBON, BOYD, BOYLE, BRACKEN, CARTER, CLARK, ELLIOTT, FAYETTE, FLEMING, FRANKLIN, GALLATIN, GRANT, GREENUP, HARRISON, JESSAMINE, LEWIS, MADISON, MASON, MERCER, MONTGOMERY, NICHOLAS, OWEN, ROBERTSON, ROWAN, SCOTT, & WOOLFORD COUNTIES

Rates Fringes

Laborers:

GROUP 1.....	\$ 23.96	17.57
GROUP 2.....	\$ 24.21	17.57
GROUP 3.....	\$ 24.26	17.57
GROUP 4.....	\$ 24.86	17.57

LABORERS CLASSIFICATIONS

GROUP 1 - Aging & Curing of Concrete; Asbestos Abatement Worker; Asphalt Plant; Asphalt; Batch Truck Dump; Carpenter Tender; Cement Mason Tender; Cleaning of Machines; Concrete; Demolition; Dredging; Environmental - Nuclear, Radiation, Toxic & Hazardous Waste - Level D; Flagperson; Grade Checker; Hand Digging & Hand Back Filling; Highway Marker Placer; Landscaping, Mesh Handler & Placer; Puddler; Railroad; Rip-rap & Grouter; Right-of-Way; Sign, Guard Rail & Fence Installer; Signal Person; Sound Barrier Installer; Storm & Sanitary Sewer; Swamper; Truck Spotter & Dumper; Wrecking of Concrete Forms; General Cleanup

GROUP 2 - Batter Board Man (Sanitary & Storm Sewer); Brickmason Tender; Mortar Mixer Operator; Scaffold Builder; Burner & Welder; Bushhammer; Chain Saw Operator; Concrete Saw Operator; Deckhand Scow Man; Dry Cement Handler; Environmental - Nuclear, Radiation, Toxic & Hazardous Waste - Level C; Forklift Operator for Masonary; Form Setter; Green Concrete Cutting; Hand Operated Grouter & Grinder Machine Operator; Jackhammer; Pavement Breaker; Paving Joint Machine; Pipelayer; Plastic Pipe Fusion; Power Driven Georgia Buggy & Wheel Barrow; Power Post Hole Digger; Precast Manhole Setter; Walk-Behind Tamper; Walk-Behind Trencher; Sand Blaster; Concrete Chipper; Surface Grinder; Vibrator Operator; Wagon Driller

GROUP 3 - Asphalt Luteman & Raker; Gunnite Nozzleman; Gunnite Operator & Mixer; Grout Pump Operator; Side Rail Setter; Rail Paved Ditches; Screw Operator; Tunnel (Free Air); Water Blaster

GROUP 4 - Caisson Worker (Free Air); Cement Finisher;

Environmental - Nuclear, Radiation, Toxic & Hazardous Waste  
- Levels A & B; Miner & Driller (Free Air); Tunnel Blaster;  
& Tunnel Mucker (Free Air); Directional & Horizontal  
Boring; Air Track Drillers (All Types); Powdermen &  
Blasters; Troxler & Concrete Tester if Laborer is Utilized

-----  
LAB00189-008 07/01/2023

ANDERSON, BULLITT, CARROLL, HARDIN, HENRY, JEFFERSON, LARUE,  
MARION, MEADE, NELSON, OLDHAM, SHELBY, SPENCER, TRIMBLE &  
WASHINGTON COUNTIES

Rates Fringes

Laborers:

GROUP 1.....	\$ 23.96	17.57
GROUP 2.....	\$ 24.21	17.57
GROUP 3.....	\$ 24.26	17.57
GROUP 4.....	\$ 24.86	17.57

LABORERS CLASSIFICATIONS

GROUP 1 - Aging & Curing of Concrete; Asbestos Abatement  
Worker; Asphalt Plant; Asphalt; Batch Truck Dump; Carpenter  
Tender; Cement Mason Tender; Cleaning of Machines;  
Concrete; Demolition; Dredging; Environmental - Nuclear,  
Radiation, Toxic & Hazardous Waste - Level D; Flagperson;  
Grade Checker; Hand Digging & Hand Back Filling; Highway  
Marker Placer; Landscaping, Mesh Handler & Placer; Puddler;  
Railroad; Rip-rap & Grouter; Right-of-Way; Sign, Guard Rail  
& Fence Installer; Signal Person; Sound Barrier Installer;  
Storm & Sanitary Sewer; Swamper; Truck Spotter & Dumper;  
Wrecking of Concrete Forms; General Cleanup

GROUP 2 - Batter Board Man (Sanitary & Storm Sewer);  
Brickmason Tender; Mortar Mixer Operator; Scaffold Builder;  
Burner & Welder; Bushhammer; Chain Saw Operator; Concrete  
Saw Operator; Deckhand Scow Man; Dry Cement Handler;  
Environmental - Nuclear, Radiation, Toxic & Hazardous Waste  
- Level C; Forklift Operator for Masonary; Form Setter;  
Green Concrete Cutting; Hand Operated Grouter & Grinder  
Machine Operator; Jackhammer; Pavement Breaker; Paving  
Joint Machine; Pipelayer; Plastic Pipe Fusion; Power Driven  
Georgia Buggy & Wheel Barrow; Power Post Hole Digger;  
Precast Manhole Setter; Walk-Behind Tamper; Walk-Behind  
Trencher; Sand Blaster; Concrete Chipper; Surface Grinder;  
Vibrator Operator; Wagon Driller

GROUP 3 - Asphalt Luteman & Raker; Gunnite Nozzleman;  
Gunnite Operator & Mixer; Grout Pump Operator; Side Rail  
Setter; Rail Paved Ditches; Screw Operator; Tunnel (Free  
Air); Water Blaster

GROUP 4 - Caisson Worker (Free Air); Cement Finisher;  
Environmental - Nuclear, Radiation, Toxic & Hazardous Waste  
- Levels A & B; Miner & Driller (Free Air); Tunnel Blaster;  
& Tunnel Mucker (Free Air); Directional & Horizontal  
Boring; Air Track Drillers (All Types); Powdermen &  
Blasters; Troxler & Concrete Tester if Laborer is Utilized

-----  
LAB00189-009 07/01/2023

BRECKINRIDGE & GRAYSON COUNTIES

	Rates	Fringes
Laborers:		
GROUP 1.....	\$ 23.96	17.57
GROUP 2.....	\$ 24.21	17.57
GROUP 3.....	\$ 24.26	17.57
GROUP 4.....	\$ 24.86	17.57

LABORERS CLASSIFICATIONS

GROUP 1 - Aging & Curing of Concrete; Asbestos Abatement Worker; Asphalt Plant; Asphalt; Batch Truck Dump; Carpenter Tender; Cement Mason Tender; Cleaning of Machines; Concrete; Demolition; Dredging; Environmental - Nuclear, Radiation, Toxic & Hazardous Waste - Level D; Flagperson; Grade Checker; Hand Digging & Hand Back Filling; Highway Marker Placer; Landscaping, Mesh Handler & Placer; Puddler; Railroad; Rip-rap & Grouter; Right-of-Way; Sign, Guard Rail & Fence Installer; Signal Person; Sound Barrier Installer; Storm & Sanitary Sewer; Swamper; Truck Spotter & Dumper; Wrecking of Concrete Forms; General Cleanup

GROUP 2 - Batter Board Man (Sanitary & Storm Sewer); Brickmason Tender; Mortar Mixer Operator; Scaffold Builder; Burner & Welder; Bushhammer; Chain Saw Operator; Concrete Saw Operator; Deckhand Scow Man; Dry Cement Handler; Environmental - Nuclear, Radiation, Toxic & Hazardous Waste - Level C; Forklift Operator for Masonary; Form Setter; Green Concrete Cutting; Hand Operated Grouter & Grinder Machine Operator; Jackhammer; Pavement Breaker; Paving Joint Machine; Pipelayer; Plastic Pipe Fusion; Power Driven Georgia Buggy & Wheel Barrow; Power Post Hole Digger; Precast Manhole Setter; Walk-Behind Tamper; Walk-Behind Trencher; Sand Blaster; Concrete Chipper; Surface Grinder; Vibrator Operator; Wagon Driller

GROUP 3 - Asphalt Luteman & Raker; Gunnite Nozzleman; Gunnite Operator & Mixer; Grout Pump Operator; Side Rail Setter; Rail Paved Ditches; Screw Operator; Tunnel (Free Air); Water Blaster

GROUP 4 - Caisson Worker (Free Air); Cement Finisher; Environmental - Nuclear, Radiation, Toxic & Hazardous Waste - Levels A & B; Miner & Driller (Free Air); Tunnel Blaster; & Tunnel Mucker (Free Air); Directional & Horizontal Boring; Air Track Drillers (All Types); Powdermen & Blasters; Troxler & Concrete Tester if Laborer is Utilized

-----  
PAIN0012-005 06/11/2005

BATH, BOURBON, BOYLE, CLARK, FAYETTE, FLEMING, FRANKLIN, HARRISON, JESSAMINE, MADISON, MERCER, MONTGOMERY, NICHOLAS, ROBERTSON, SCOTT & WOODFORD COUNTIES:

	Rates	Fringes
PAINTER		
Bridge/Equipment Tender and/or Containment Builder..	\$ 18.90	5.90
Brush & Roller.....	\$ 21.30	5.90
Elevated Tanks;		



Steeplejack Work; Bridge & Lead Abatement.....	\$ 22.30	5.90
Sandblasting & Waterblasting.....	\$ 22.05	5.90
Spray.....	\$ 21.80	5.90

-----  
PAIN0012-017 05/01/2015

BRACKEN, GALLATIN, GRANT, MASON & OWEN COUNTIES:

	Rates	Fringes
PAINTER (Heavy & Highway Bridges - Guardrails - Lightpoles - Striping)		
Bridge Equipment Tender and Containment Builder.....	\$ 20.73	9.06
Brush & Roller.....	\$ 23.39	9.06
Elevated Tanks; Steeplejack Work; Bridge & Lead Abatement.....	\$ 24.39	9.06
Sandblasting & Water Blasting.....	\$ 24.14	9.06
Spray.....	\$ 23.89	9.06

-----  
PAIN0118-004 06/01/2018

ANDERSON, BRECKINRIDGE, BULLITT, CARROLL, GRAYSON, HARDIN,  
HENRY, JEFFERSON, LARUE, MARION, MEADE, NELSON, OLDHAM, SHELBY,  
SPENCER, TRIMBLE & WASHINGTON COUNTIES:

	Rates	Fringes
PAINTER		
Brush & Roller.....	\$ 22.00	12.52
Spray, Sandblast, Power Tools, Waterblast & Steam Cleaning.....	\$ 23.00	12.52

-----  
PAIN1072-003 12/01/2023

BOYD, CARTER, ELLIOTT, GREENUP, LEWIS and ROWAN COUNTIES

	Rates	Fringes
Painters:		
Bridges; Locks; Dams; Tension Towers & Energized Substations.....	\$ 35.64	23.69
Power Generating Facilities.....	\$ 32.40	23.69

-----  
PLUM0248-003 06/01/2023

BOYD, CARTER, ELLIOTT, GREENUP, LEWIS & ROWAN COUNTIES:

	Rates	Fringes
Plumber and Steamfitter.....	\$ 41.00	22.95

-----  
PLUM0392-007 06/01/2023

BRACKEN, CARROLL (Eastern Half), GALLATIN, GRANT, MASON, OWEN &  
ROBERTSON COUNTIES:

	Rates	Fringes
Plumbers and Pipefitters.....	\$ 38.62	25.73
-----		
PLUM0502-003 08/01/2021		

BRECKINRIDGE, BULLITT, CARROLL (Western Half), FRANKLIN  
(Western three-fourths), GRAYSON, HARDIN, HENRY, JEFFERSON,  
LARUE, MARION, MEADE, NELSON, OLDHAM, SHELBY, SPENCER, TRIMBLE &  
WASHINGTON COUNTIES

	Rates	Fringes
PLUMBER.....	\$ 38.07	20.78
-----		
* SUKY2010-160 10/08/2001		

	Rates	Fringes
Truck drivers:		
GROUP 1.....	\$ 16.57 **	7.34
GROUP 2.....	\$ 16.68 **	7.34
GROUP 3.....	\$ 16.86 **	7.34
GROUP 4.....	\$ 16.96 **	7.34

TRUCK DRIVER CLASSIFICATIONS

GROUP 1 - Mobile Batch Truck Tender

GROUP 2 - Greaser; Tire Changer; & Mechanic Tender

GROUP 3 - Single Axle Dump; Flatbed; Semi-trailer or Pole  
Trailer when used to pull building materials and equipment;  
Tandem Axle Dump; Distributor; Mixer; & Truck Mechanic

GROUP 4 - Euclid & Other Heavy Earthmoving Equipment &  
Lowboy; Articulator Cat; 5-Axle Vehicle; Winch & A-Frame  
when used in transporting materials; Ross Carrier; Forklift  
when used to transport building materials; & Pavement  
Breaker

-----  
WELDERS - Receive rate prescribed for craft performing  
operation to which welding is incidental.

=====  
\*\* Workers in this classification may be entitled to a higher  
minimum wage under Executive Order 14026 (\$17.20) or 13658  
(\$12.90). Please see the Note at the top of the wage  
determination for more information. Please also note that the  
minimum wage requirements of Executive Order 14026 are not  
currently being enforced as to any contract or subcontract to  
which the states of Texas, Louisiana, or Mississippi, including  
their agencies, are a party.

Note: Executive Order (EO) 13706, Establishing Paid Sick Leave  
for Federal Contractors applies to all contracts subject to the  
Davis-Bacon Act for which the contract is awarded (and any  
solicitation was issued) on or after January 1, 2017. If this  
contract is covered by the EO, the contractor must provide  
employees with 1 hour of paid sick leave for every 30 hours

they work, up to 56 hours of paid sick leave each year. Employees must be permitted to use paid sick leave for their own illness, injury or other health-related needs, including preventive care; to assist a family member (or person who is like family to the employee) who is ill, injured, or has other health-related needs, including preventive care; or for reasons resulting from, or to assist a family member (or person who is like family to the employee) who is a victim of, domestic violence, sexual assault, or stalking. Additional information on contractor requirements and worker protections under the EO is available at <https://www.dol.gov/agencies/whd/government-contracts>.

Unlisted classifications needed for work not included within the scope of the classifications listed may be added after award only as provided in the labor standards contract clauses (29CFR 5.5 (a) (1) (iii)).

-----

The body of each wage determination lists the classification and wage rates that have been found to be prevailing for the cited type(s) of construction in the area covered by the wage determination. The classifications are listed in alphabetical order of ""identifiers"" that indicate whether the particular rate is a union rate (current union negotiated rate for local), a survey rate (weighted average rate) or a union average rate (weighted union average rate).

#### Union Rate Identifiers

A four letter classification abbreviation identifier enclosed in dotted lines beginning with characters other than ""SU"" or ""UAVG"" denotes that the union classification and rate were prevailing for that classification in the survey. Example: PLUM0198-005 07/01/2014. PLUM is an abbreviation identifier of the union which prevailed in the survey for this classification, which in this example would be Plumbers. 0198 indicates the local union number or district council number where applicable, i.e., Plumbers Local 0198. The next number, 005 in the example, is an internal number used in processing the wage determination. 07/01/2014 is the effective date of the most current negotiated rate, which in this example is July 1, 2014.

Union prevailing wage rates are updated to reflect all rate changes in the collective bargaining agreement (CBA) governing this classification and rate.

#### Survey Rate Identifiers

Classifications listed under the ""SU"" identifier indicate that no one rate prevailed for this classification in the survey and the published rate is derived by computing a weighted average rate based on all the rates reported in the survey for that classification. As this weighted average rate includes all rates reported in the survey, it may include both union and non-union rates. Example: SULA2012-007 5/13/2014. SU indicates the rates are survey rates based on a weighted average calculation of rates and are not majority rates. LA indicates the State of Louisiana. 2012 is the year of survey on which these classifications and rates are based. The next number, 007 in the example, is an internal number used in producing the

wage determination. 5/13/2014 indicates the survey completion date for the classifications and rates under that identifier.

Survey wage rates are not updated and remain in effect until a new survey is conducted.

#### Union Average Rate Identifiers

Classification(s) listed under the UAVG identifier indicate that no single majority rate prevailed for those classifications; however, 100% of the data reported for the classifications was union data. EXAMPLE: UAVG-OH-0010 08/29/2014. UAVG indicates that the rate is a weighted union average rate. OH indicates the state. The next number, 0010 in the example, is an internal number used in producing the wage determination. 08/29/2014 indicates the survey completion date for the classifications and rates under that identifier.

A UAVG rate will be updated once a year, usually in January of each year, to reflect a weighted average of the current negotiated/CBA rate of the union locals from which the rate is based.

---

#### WAGE DETERMINATION APPEALS PROCESS

1.) Has there been an initial decision in the matter? This can be:

- \* an existing published wage determination
- \* a survey underlying a wage determination
- \* a Wage and Hour Division letter setting forth a position on a wage determination matter
- \* a conformance (additional classification and rate) ruling

On survey related matters, initial contact, including requests for summaries of surveys, should be with the Wage and Hour National Office because National Office has responsibility for the Davis-Bacon survey program. If the response from this initial contact is not satisfactory, then the process described in 2.) and 3.) should be followed.

With regard to any other matter not yet ripe for the formal process described here, initial contact should be with the Branch of Construction Wage Determinations. Write to:

Branch of Construction Wage Determinations  
Wage and Hour Division  
U.S. Department of Labor  
200 Constitution Avenue, N.W.  
Washington, DC 20210

2.) If the answer to the question in 1.) is yes, then an interested party (those affected by the action) can request review and reconsideration from the Wage and Hour Administrator (See 29 CFR Part 1.8 and 29 CFR Part 7). Write to:

Wage and Hour Administrator  
U.S. Department of Labor  
200 Constitution Avenue, N.W.  
Washington, DC 20210

The request should be accompanied by a full statement of the interested party's position and by any information (wage payment data, project description, area practice material, etc.) that the requestor considers relevant to the issue.

3.) If the decision of the Administrator is not favorable, an interested party may appeal directly to the Administrative Review Board (formerly the Wage Appeals Board). Write to:

Administrative Review Board  
U.S. Department of Labor  
200 Constitution Avenue, N.W.  
Washington, DC 20210

4.) All decisions by the Administrative Review Board are final.

=====

END OF GENERAL DECISION"

Fringe benefit amounts are applicable for all hours worked except when otherwise noted.

No laborer, workman or mechanic shall be paid at a rate less than that of a Journeyman except those classified as bona fide apprentices.

Apprentices or trainees shall be permitted to work as such subject to Administrative Regulations adopted by the Commissioner of Workplace Standards. Copies of these regulations will be furnished upon request from any interested person.

Before using apprentices on the job the contractor shall present to the Contracting Officer written evidence of registration of such employees in a program of a State apprenticeship and training agency approved and recognized by the U. S. Bureau of Apprenticeship and Training. In the absence of such a State agency, the contractor shall submit evidence of approval and registration by the U. S. Bureau of Apprenticeship and Training.

The contractor shall submit to the Contracting Officer, written evidence of the established apprenticeship-journeyman ratios and wage rates in the project area, which will be the basis for establishing such ratios and rates for the project under the applicable contract provisions.

**TO: EMPLOYERS/EMPLOYEES**

**PREVAILING WAGE SCHEDULE:**

**The wages indicated on this wage schedule are the least permitted to be paid for the occupations indicated. When an employee works in more than one classification, the employer must record the number of hours worked in each classification at the prescribed hourly base rate.**

**OVERTIME:**

**Overtime is to be paid to an employee at a rate not less than one and one-half times the basic rate of pay for all hours worked in excess of forty (40) hours in such workweek. Wage violations or questions should be directed to the designated Engineer or the undersigned.**

Director  
Division of Construction Procurement  
Frankfort, Kentucky 40622  
502-564-3500

**NOTICE OF REQUIREMENT FOR AFFIRMATIVE ACTION  
TO ENSURE EQUAL EMPLOYMENT OPPORTUNITY  
(Executive Order 11246)**

1. The Offeror's or Bidder's attention is called to the "Equal Opportunity Clause" and the "Standard Federal Equal Employment Specifications" set forth herein.
2. The goals and timetables for minority and female participation, expressed in percentage terms for the Contractor's aggregate work force in each trade on all construction work in the covered area, are as follows:

<b>GOALS FOR MINORITY PARTICIPATION IN EACH TRADE</b>	<b>GOALS FOR FEMALE PARTICIPATION IN EACH TRADE</b>
11.2%	6.9%

These goals are applicable to all the Contractor's construction work (whether or not it is Federal or federally-assisted) performed in the covered area. If the contractor performs construction work in a geographical area located outside of the covered area, it shall apply the goals established for such geographical area where the work is actually performed. With regard to this second area, the contractor also is subject to the goals for both its federally involved and non-federally involved construction.

The Contractor's compliance with the Executive Order and the regulations in CFR Part 60-4 shall be based on its implementation of the Equal Opportunity Clause, specific affirmative action obligations required by the specifications set forth in 41 CFR 60-4, 3(a), and its efforts to meet the goals. The hours of minority and female employment and training must be substantially uniform throughout the length of the contract, and in each trade, and the contractor shall make a good faith effort to employ minorities and women evenly on each of its projects. The transfer of minority or female employees or trainees from Contractor to Contractor or from project to project for the sole purpose of meeting the Contractor's goals shall be a violation of the contract, the Executive Order and the regulations in 41 CFR Part 60-4. Compliance with the goals will be measured against the total work hours performed.

3. The Notification of Construction Contract Award Portal (NCAP) is OFCCP's preferred method for receiving construction contract award notifications. The NCAP can be found on OFCCP's website at <https://www.dol.gov/agencies/ofccp/ncap>. Users who prefer not to use the portal maintain the option to send their notifications via mail, email and facsimile to the OFCCP Regional office in which the work will be performed. The Contractor shall provide written notification to the Director of the Office of Federal Contract Compliance Programs within ten (10) working days of award of any construction subcontract in excess of \$10,000.00 at any tier for construction work under the contract resulting from this solicitation. The notification must include: Prime Contract Number (issued by the federal agency or applicant); Name of Awarding Federal Agency, Applicant or Contractor; Contracting Officer, Applicant Representative or Contractor Representative Submitting Notification with name, phone number, email address; Contractor Awarded Contract or Subcontract with name, address, phone number, email address, EIN, dollar amount of the contract, estimated start date of the contract, estimated completion date of the contract, geographical area in which the contract is to be performed (state, county's city (if applicable)).

The notification shall be mailed to:

**Regional Director**  
**Office of Federal Contract Compliance Programs**  
**61 Forsyth Street, SW, Suite 7B75**  
**Atlanta, Georgia 30303-8931**  
**Main Number: 404-893-4545 Fax: 404-893-4546**  
**Regional Director Contact: [OFCCP-SE@dol.gov](mailto:OFCCP-SE@dol.gov)**  
**Construction Award Email: [OFCCP-SE-ConstructionAward@dol.gov](mailto:OFCCP-SE-ConstructionAward@dol.gov)**

4. As used in this Notice, and in the contract resulting from this solicitation, the "covered area" is Jefferson County.



**NOTICE OF REQUIREMENT FOR AFFIRMATIVE ACTION  
TO ENSURE EQUAL EMPLOYMENT OPPORTUNITY  
(Executive Order 11246)**

1. The Offeror's or Bidder's attention is called to the "Equal Opportunity Clause" and the "Standard Federal Equal Employment Specifications" set forth herein.
2. The goals and timetables for minority and female participation, expressed in percentage terms for the Contractor's aggregate work force in each trade on all construction work in the covered area, are as follows:

<b>GOALS FOR MINORITY PARTICIPATION IN EACH TRADE</b>	<b>GOALS FOR FEMALE PARTICIPATION IN EACH TRADE</b>
11.2%	6.9%

These goals are applicable to all the Contractor's construction work (whether or not it is Federal or federally-assisted) performed in the covered area. If the contractor performs construction work in a geographical area located outside of the covered area, it shall apply the goals established for such geographical area where the work is actually performed. With regard to this second area, the contractor also is subject to the goals for both its federally involved and non-federally involved construction.

The Contractor's compliance with the Executive Order and the regulations in CFR Part 60-4 shall be based on its implementation of the Equal Opportunity Clause, specific affirmative action obligations required by the specifications set forth in 41 CFR 60-4, 3(a), and its efforts to meet the goals. The hours of minority and female employment and training must be substantially uniform throughout the length of the contract, and in each trade, and the contractor shall make a good faith effort to employ minorities and women evenly on each of its projects. The transfer of minority or female employees or trainees from Contractor to Contractor or from project to project for the sole purpose of meeting the Contractor's goals shall be a violation of the contract, the Executive Order and the regulations in 41 CFR Part 60-4. Compliance with the goals will be measured against the total work hours performed.

3. The Notification of Construction Contract Award Portal (NCAP) is OFCCP's preferred method for receiving construction contract award notifications. The NCAP can be found on OFCCP's website at <https://www.dol.gov/agencies/ofccp/ncap>. Users who prefer not to use the portal maintain the option to send their notifications via mail, email and facsimile to the OFCCP Regional office in which the work will be performed. The Contractor shall provide written notification to the Director of the Office of Federal Contract Compliance Programs within ten (10) working days of award of any construction subcontract in excess of \$10,000.00 at any tier for construction work under the contract resulting from this solicitation. The notification must include: Prime Contract Number (issued by the federal agency or applicant); Name of Awarding Federal Agency, Applicant or Contractor; Contracting Officer, Applicant Representative or Contractor Representative Submitting Notification with name, phone number, email address; Contractor Awarded Contract or Subcontract with name, address, phone number, email address, EIN, dollar amount of the contract, estimated start date of the contract, estimated completion date of the contract, geographical area in which the contract is to be performed (state, county's city (if applicable)).

The notification shall be mailed to:

**Regional Director**  
**Office of Federal Contract Compliance Programs**  
**61 Forsyth Street, SW, Suite 7B75**  
**Atlanta, Georgia 30303-8931**  
**Main Number: 404-893-4545 Fax: 404-893-4546**  
**Regional Director Contact: [OFCCP-SE@dol.gov](mailto:OFCCP-SE@dol.gov)**  
**Construction Award Email: [OFCCP-SE-ConstructionAward@dol.gov](mailto:OFCCP-SE-ConstructionAward@dol.gov)**

4. As used in this Notice, and in the contract resulting from this solicitation, the "covered area" is Oldham County.

**PART IV**  
**INSURANCE**

Refer to  
*Kentucky Standard Specifications for Road and Bridge Construction,*  
current edition

**PART V**  
**BID ITEMS**

**PROPOSAL BID ITEMS**

244702

Page 1 of 1

Report Date 3/27/24

**Section: 0001 - ROADWAY**

LINE	BID CODE	ALT	DESCRIPTION	QUANTITY	UNIT	UNIT PRIC	FP	AMOUNT
0010	02014		BARRICADE-TYPE III	2.00	EACH		\$	
0020	02562		TEMPORARY SIGNS	1,550.00	SQFT		\$	
0030	02650		MAINTAIN & CONTROL TRAFFIC	1.00	LS		\$	
0040	02650		MAINTAIN & CONTROL TRAFFIC	1.00	LS		\$	
0050	02650		MAINTAIN & CONTROL TRAFFIC	1.00	LS		\$	
0060	02650		MAINTAIN & CONTROL TRAFFIC	1.00	LS		\$	
0070	02650		MAINTAIN & CONTROL TRAFFIC	1.00	LS		\$	
0080	02650		MAINTAIN & CONTROL TRAFFIC	1.00	LS		\$	
0090	02650		MAINTAIN & CONTROL TRAFFIC	1.00	LS		\$	
0100	02650		MAINTAIN & CONTROL TRAFFIC	1.00	LS		\$	
0110	02671		PORTABLE CHANGEABLE MESSAGE SIGN	17.00	EACH		\$	
0120	02775		ARROW PANEL	12.00	EACH		\$	
0130	06568		PAVE MARKING-THERMO STOP BAR-24IN	142.00	LF		\$	
0140	06574		PAVE MARKING-THERMO CURV ARROW	4.00	EACH		\$	
0150	06598		PAVEMENT MARKING REMOVAL	92.00	SQFT		\$	
0160	20099ES842		PAVE MARK TEMP PAINT STOP BAR	142.00	LF		\$	
0170	23229EC		HIGH FRICTION SURFACE TREATMENT	9,528.00	SQYD		\$	
0180	40045		PAVEMENT MARKING REMOVAL	239.00	SQFT		\$	

**Section: 0002 - DEMOBILIZATION**

LINE	BID CODE	ALT	DESCRIPTION	QUANTITY	UNIT	UNIT PRIC	FP	AMOUNT
0190	02569		DEMOBILIZATION	1.00	LS		\$	