



CALL NO. 115

CONTRACT ID. 224316

VARIOUS COUNTIES

FED/STATE PROJECT NUMBER HSIP 9010(457)

DESCRIPTION VARIOUS ROUTES IN DISTRICT 1

WORK TYPE PAVEMENT MARKERS & REFLECTORS

PRIMARY COMPLETION DATE 10/31/2023

LETTING DATE: June 23,2022

Sealed Bids will be received electronically through the Bid Express bidding service until 10:00 AM EASTERN DAYLIGHT TIME June 23,2022. Bids will be publicly announced at 10:00 AM EASTERN DAYLIGHT TIME.

NO PLANS ASSOCIATED WITH THIS PROJECT.

DBE CERTIFICATION REQUIRED - 0%

REQUIRED BID PROPOSAL GUARANTY: Not less than 5% of the total bid.

TABLE OF CONTENTS

PART I	SCOPE OF WORK <ul style="list-style-type: none">• PROJECT(S), COMPLETION DATE(S), & LIQUIDATED DAMAGES• CONTRACT NOTES• FEDERAL CONTRACT NOTES• NATIONAL HIGHWAY• SPECIAL NOTE(S) APPLICABLE TO PROJECT• LIQUIDATED DAMAGES• COORDINATION OF WORK WITH OTHER CONTRACTS• TRAFFIC CONTROL PLAN• RIGHT OF WAY CERTIFICATION• UTILITY IMPACT & RAIL CERTIFICATION NOTES• SKETCH MAP(S)• SUMMARY SHEET(S)
PART II	SPECIFICATIONS AND STANDARD DRAWINGS <ul style="list-style-type: none">• SPECIFICATIONS REFERENCE• SUPPLEMENTAL SPECIFICATION• 2020 STANDARD DRAWINGS THAT APPLY• INLAID PAVEMENT MARKER ARRANGEMENTS MULTI-LANE ROADWAYS• INLAID PAVEMENT MARKER ARRANGEMENTS MULTI-LANE ROADWAYS• INLAID PAVEMENT MARKER ARRANGEMENTS MULTI-LANE ROADWAYS• INLAID PAVEMENT MARKER ARRANGEMENTS TWO-LANE ROADWAYS• INLAID PAVEMENT MARKER ARRANGEMENTS TWO-LANE TO FOUR LANE TRANSITIONS• INLAID PAVEMENT MARKER ARRANGEMENT EXIT GORE AND OFF-RAMP• INLAID PAVEMENT MARKER ARRANGEMENT FOR PARALLEL DECELERATION LANE• INLAID PAVEMENT MARKER ARRANGEMENT ON-RAMP WITH TAPERED ACCELERATION LANE• INLAID PAVEMENT MARKER ARRANGEMENT ON-RAMP WITH PARALLEL ACCELERATION LANE• INLAID PAVEMENT MARKER ARRANGEMENTS TWO-WAY, LEFT-TURN LANE• INLAID PAVEMENT MARKER ARRANGEMENT CHANNELIZED INTERSECTION
PART III	EMPLOYMENT, WAGE AND RECORD REQUIREMENTS <ul style="list-style-type: none">• FEDERAL-AID CONSTRUCTION CONTRACTS - FHWA 1273• NONDISCRIMINATION OF EMPLOYEES• EXECUTIVE BRANCH CODE OF ETHICS• PROJECT WAGE RATES LOCALITY 1 / FEDERAL• NOTICE OF REQUIREMENT FOR AFFIRMATIVE ACTION TO ENSURE EEO CALLOWAY• NOTICE OF REQUIREMENT FOR AFFIRMATIVE ACTION TO ENSURE EEO GRAVES• NOTICE OF REQUIREMENT FOR AFFIRMATIVE ACTION TO ENSURE EEO MCCracken

- NOTICE OF REQUIREMENT FOR AFFIRMATIVE ACTION TO ENSURE EEO MARSHALL
- NOTICE OF REQUIREMENT FOR AFFIRMATIVE ACTION TO ENSURE EEO TRIGG

PART IV INSURANCE

PART V BID ITEMS

PART I
SCOPE OF WORK

ADMINISTRATIVE DISTRICT - 01

CONTRACT ID - 224316

HSIP 9010(457)

COUNTY - VARIOUS

PCN - 0112199992201

HSIP 9010(457)

VARIOUS ROUTES IN DISTRICT 1 INSTALLATION OF PAVEMENT MARKERS IN VARIOUS COUNTIESPAVEMENT
MARKERS & REFLECTORS SYP NO. 01-00985.00.

GEOGRAPHIC COORDINATES LATITUDE 36:47:00.00 LONGITUDE 88:37:51.00

ADT

COMPLETION DATE(S):

COMPLETED BY 10/31/2023

APPLIES TO ENTIRE CONTRACT

COMPLETED BY 07/31/2023

MILESTONE DATE (SEE SN FOR
COMPLETION DATES)

COMPLETED BY 05/31/2023

MILESTONE DATE (SEE SN FOR
COMPLETION DATES)

CONTRACT NOTES

PROPOSAL ADDENDA

All addenda to this proposal must be applied when calculating bid and certified in the bid packet submitted to the Kentucky Department of Highways. Failure to use the correct and most recent addenda may result in the bid being rejected.

BID SUBMITTAL

Bidder must use the Department's electronic bidding software. The Bidder must download the bid file located on the Bid Express website (www.bidx.com) to prepare a bid packet for submission to the Department. The bidder must submit electronically using Bid Express.

JOINT VENTURE BIDDING

Joint venture bidding is permissible. All companies in the joint venture must be prequalified in one of the work types in the Qualifications for Bidders for the project. The bidders must get a vendor ID for the joint venture from the Division of Construction Procurement and register the joint venture as a bidder on the project. Also, the joint venture must obtain a digital ID from Bid Express to submit a bid. A joint bid bond of 5% may be submitted for both companies or each company may submit a separate bond of 5%.

UNDERGROUND FACILITY DAMAGE PROTECTION

The contractor shall make every effort to protect underground facilities from damage as prescribed in the Underground Facility Damage Protection Act of 1994, Kentucky Revised Statute KRS 367.4901 to 367.4917. It is the contractor's responsibility to determine and take steps necessary to be in compliance with federal and state damage prevention directives. When prescribed in said directives, the contractor shall submit Excavation Locate Requests to the Kentucky Contact Center (KY811) via web ticket entry. The submission of this request does not relieve the contractor from the responsibility of contacting non-member facility owners, whom shall be contacted through their individual Protection Notification Center. Non-compliance with these directives can result in the enforcement of penalties.

REGISTRATION WITH THE SECRETARY OF STATE BY A FOREIGN ENTITY

Pursuant to KRS 176.085(1)(b), an agency, department, office, or political subdivision of the Commonwealth of Kentucky shall not award a state contract to a person that is a foreign entity required by [KRS 14A.9-010](#) to obtain a certificate of authority to transact business in the Commonwealth ("certificate") from the Secretary of State under [KRS 14A.9-030](#) unless the person produces the certificate within fourteen (14) days of the bid or proposal opening. If the foreign entity is not required to obtain a certificate as provided in [KRS 14A.9-010](#), the foreign entity should identify the applicable exception. Foreign entity is defined within [KRS 14A.1-070](#).

For all foreign entities required to obtain a certificate of authority to transact business in the Commonwealth, if a copy of the certificate is not received by the contracting agency within the time frame identified above, the foreign entity's solicitation response shall be deemed non-responsive or the awarded contract shall be cancelled.

Businesses can register with the Secretary of State at <https://secure.kentucky.gov/sos/ftbr/welcome.aspx>.

SPECIAL NOTE FOR PROJECT QUESTIONS DURING ADVERTISEMENT

Questions about projects during the advertisement should be submitted in writing to the Division of Construction Procurement. This may be done by fax (502) 564-7299 or email to kytc.projectquestions@ky.gov. The Department will attempt to answer all submitted questions. The Department reserves the right not to answer if the question is not pertinent or does not aid in clarifying the project intent.

The deadline for posting answers will be 3:00 pm Eastern Daylight Time, the day preceding the Letting. Questions may be submitted until this deadline with the understanding that the later a question is submitted, the less likely an answer will be able to be provided.

The questions and answers will be posted for each Letting under the heading "Questions & Answers" on the Construction Procurement website (www.transportation.ky.gov/contract). The answers provided shall be considered part of this Special Note and, in case of a discrepancy, will govern over all other bidding documents.

HARDWOOD REMOVAL RESTRICTIONS

The US Department of Agriculture has imposed a quarantine in Kentucky and several surrounding states, to prevent the spread of an invasive insect, the emerald ash borer. Hardwood cut in conjunction with the project may not be removed from the state. Chipping or burning on site is the preferred method of disposal.

INSTRUCTIONS FOR EXCESS MATERIAL SITES AND BORROW SITES

Identification of excess material sites and borrow sites shall be the responsibility of the Contractor. The Contractor shall be responsible for compliance with all applicable state and federal laws and may wish to consult with the US Fish and Wildlife Service to seek protection under Section 10 of the Endangered Species Act for these activities.

ACCESS TO RECORDS

The contractor, as defined in KRS 45A.030 (9) agrees that the contracting agency, the Finance and Administration Cabinet, the Auditor of Public Accounts, and the Legislative Research Commission, or their duly authorized representatives, shall have access to any books, documents, papers, records, or other evidence, which are directly pertinent to this contract for the purpose of financial audit or program review. Records and other prequalification information confidentially

disclosed as part of the bid process shall not be deemed as directly pertinent to the contract and shall be exempt from disclosure as provided in KRS 61.878(1)(c). The contractor also recognizes that any books, documents, papers, records, or other evidence, received during a financial audit or program review shall be subject to the Kentucky Open Records Act, KRS 61.870 to 61.884.

In the event of a dispute between the contractor and the contracting agency, Attorney General, or the Auditor of Public Accounts over documents that are eligible for production and review, the Finance and Administration Cabinet shall review the dispute and issue a determination, in accordance with Secretary's Order 11-004.

April 30, 2018

FEDERAL CONTRACT NOTES

The Kentucky Department of Highways, in accordance with the Regulations of the United States Department of Transportation 23 CFR 635.112 (h), hereby notifies all bidders that failure by a bidder to comply with all applicable sections of the current Kentucky Standard Specifications, including, but not limited to the following, may result in a bid not being considered responsive and thus not eligible to be considered for award:

- | | |
|--------------------------------|--|
| 102.02 Current Rating | 102.08 Preparation and Delivery of Proposals |
| 102.13 Irregular Bid Proposals | 102.14 Disqualification of Bidders |
| 102.09 Proposal Guaranty | |

CIVIL RIGHTS ACT OF 1964

The Kentucky Transportation Cabinet, Department of Highways, in accordance with the provisions of Title VI of the Civil Rights Act of 1964 (78 Stat. 252, 42 U.S.C. §§ 2000d to 2000d-4) and the Regulations, hereby notifies all bidders that it will affirmatively ensure that any contract entered into pursuant to this advertisement, disadvantaged business enterprises will be afforded full and fair opportunity to submit bids in response to this invitation and will not be discriminated against on the grounds of race, color, national origin, sex, age (over 40), religion, sexual orientation, gender identity, veteran status, disability, income- level, or Limited English Proficiency (LEP) in consideration for an award.

NOTICE TO ALL BIDDERS

To report bid rigging activities call: 1-800-424-9071.

The U.S. Department of Transportation (DOT) operates the above toll-free “hotline” Monday through Friday, 8:00 a.m. to 5:00 p.m. eastern time. Anyone with knowledge of possible bid rigging, bidder collusion, or other fraudulent activities should use the “hotline” to report such activities.

The “hotline” is part of the DOT’s continuing effort to identify and investigate highway construction contract fraud and abuse and is operated under the direction of the DOT Inspector General. All information will be treated confidentially and caller anonymity will be respected.

SECOND TIER SUBCONTRACTS

Second tier subcontracts are acceptable per Section 108.01 of the Standard Specifications for Road and Bridge Construction. Sub-Contractors fulfilling a disadvantaged business enterprise goal on a project may enter into a 2nd tier subcontract with a Non-DBE Subcontractor. However, in this instance, none of the work subcontracted to the Non-DBE Contractor will count toward fulfilling the established Disadvantaged Goal for the project.

DISADVANTAGED BUSINESS ENTERPRISE PROGRAM

It is the policy of the Kentucky Transportation Cabinet (“the Cabinet”) that Disadvantaged Business Enterprises (“DBE”) shall have the opportunity to participate in the performance of highway construction projects financed in whole or in part by Federal Funds in order to create a level playing field for all businesses who wish to contract with the Cabinet. To that end, the Cabinet will comply with the regulations found in 49 CFR Part 26, and the definitions and requirements contained therein shall be adopted as if set out verbatim herein.

The Cabinet, contractors, subcontractors, and sub-recipients shall not discriminate on the basis of race, color, national origin, or sex in the performance of work performed pursuant to Cabinet contracts. The contractor shall carry out applicable requirements of 49 CFR 26 in the award and administration of federally assisted highway construction projects. The contractor will include this provision in all its subcontracts and supply agreements pertaining to contracts with the Cabinet.

Failure by the contractor to carry out these requirements is a material breach of its contract with the Cabinet, which may result in the termination of the contract or such other remedy as the Cabinet deems necessary.

DBE GOAL

The Disadvantaged Business Enterprise (DBE) goal established for this contract, as listed on the front page of the proposal, is the percentage of the total value of the contract.

The contractor shall exercise all necessary and reasonable steps to ensure that Disadvantaged Business Enterprises participate in a least the percent of the contract as set forth above as goals for this contract.

OBLIGATION OF CONTRACTORS

Each contractor prequalified to perform work on Cabinet projects shall designate and make known to the Cabinet a liaison officer who is assigned the responsibility of effectively administering and promoting an active program for utilization of DBEs.

If a formal goal has not been designated for the contract, all contractors are encouraged to consider DBEs for subcontract work as well as for the supply of material and services needed to perform this work.

Contractors are encouraged to use the services of banks owned and controlled by minorities and women.

CERTIFICATION OF CONTRACT GOAL

Contractors shall include the following certification in bids for projects for which a DBE goal has been established. BIDS SUBMITTED WHICH DO NOT INCLUDE CERTIFICATION OF DBE PARTICIPATION WILL NOT BE ACCEPTED. These bids will not be considered for award by the Cabinet and they will be returned to the bidder.

“The bidder certifies that it has secured participation by Disadvantaged Business Enterprises (“DBE”) in the amount of _____ percent of the total value of this contract and that the DBE participation is in compliance with the requirements of 49 CFR 26 and the policies of the Kentucky Transportation Cabinet pertaining to the DBE Program.”

The certification statement is located in the electronic bid file. All contractors must certify their DBE participation on that page. DBEs utilized in achieving the DBE goal must be certified and prequalified for the work items at the time the bid is submitted.

DBE PARTICIPATION PLAN

Lowest responsive bidders must submit the *DBE Plan/ Subcontractor Request*, form TC 14-35 DBE, within **5** days of the letting. This is necessary before the Awards Committee will review and make a recommendation. **The project will not be considered for award prior to submission and approval of the apparent low bidder’s DBE Plan/Subcontractor Request.**

The DBE Participation Plan shall include the following:

1. Name and address of DBE Subcontractor(s) and/or supplier(s) intended to be used in the proposed project;
2. Description of the work each is to perform including the work item, unit, quantity, unit price and total amount of the work to be performed by the individual DBE. The Proposal Line Number, Category Number, and the Project Line Number can be found in the “material listing” on the Construction Procurement website under the specific letting;
3. The dollar value of each proposed DBE subcontract and the percentage of total project contract value this represents. DBE participation may be counted as follows:
 - a. If DBE suppliers and manufactures assume actual and contractual responsibility, the dollar value of materials to be furnished will be counted toward the goal as follows:
 - The entire expenditure paid to a DBE manufacturer;
 - 60 percent of expenditures to DBE suppliers that are not manufacturers provided the supplier is a regular dealer in the product involved. A regular dealer must be engaged in, as its principal business and in its own name, the sale of products to the public, maintain an inventory and own and operate distribution equipment; and
 - The amount of fees or commissions charged by the DBE firms for a bona fide service, such as professional, technical, consultant, or managerial services and assistance in the procurement of essential personnel, facilities, equipment, materials, supplies, delivery of materials and supplies or for furnishing bonds, or insurance, providing such fees or commissions are determined to be reasonable and customary.

- b) The dollar value of services provided by DBEs such as quality control testing, equipment repair and maintenance, engineering, staking, etc.;
- c) The dollar value of joint ventures. DBE credit for joint ventures will be limited to the dollar amount of the work actually performed by the DBE in the joint venture;
- 4. Written and signed documentation of the bidder's commitment to use a DBE contractor whose participation is being utilized to meet the DBE goal; and
- 5. Written and signed confirmation from the DBE that it is participating in the contract as provided in the prime contractor's commitment.

UPON AWARD AND BEFORE A WORK ORDER WILL BE ISSUED

Contractors must submit the signed subcontract between the contractor and the DBE contractor, along with the DBE's certificate of insurance. If the DBE is a supplier of materials for the project, a signed purchase order must be submitted to the Division of Construction Procurement.

Changes to DBE Participation Plans must be approved by the Cabinet. The Cabinet may consider extenuating circumstances including, but not limited to, changes in the nature or scope of the project, the inability or unwillingness of a DBE to perform the work in accordance with the bid, and/or other circumstances beyond the control of the prime contractor.

CONSIDERATION OF GOOD FAITH EFFORTS REQUESTS

If the DBE participation submitted in the bid by the apparent lowest responsive bidder does not meet or exceed the DBE contract goal, the apparent lowest responsive bidder must submit a Good Faith Effort Package to satisfy the Cabinet that sufficient good faith efforts were made to meet the contract goals prior to submission of the bid. Efforts to increase the goal after bid submission will not be considered in justifying the good faith effort, unless the contractor can show that the proposed DBE was solicited prior to the letting date. DBEs utilized in achieving the DBE goal must be certified and prequalified for the work items at the time the bid is submitted. One complete set (hard copy along with an electronic copy) of this information must be received in the Division of Contract Procurement no later than 12:00 noon of the tenth calendar day after receipt of notification that they are the apparent low bidder.

Where the information submitted includes repetitious solicitation letters it will be acceptable to submit a sample representative letter along with a distribution list of the firms solicited. Documentation of DBE quotations shall be a part of the good faith effort submittal as necessary to demonstrate compliance with the factors listed below which the Cabinet considers in judging good faith efforts. This documentation may include written subcontractors' quotations, telephone log notations of verbal quotations, or other types of quotation documentation.

The Good Faith Effort Package shall include, but may not be limited to information showing evidence of the following:

1. Whether the bidder attended any pre-bid meetings that were scheduled by the Cabinet to inform DBEs of subcontracting opportunities;
2. Whether the bidder provided solicitations through all reasonable and available means;
3. Whether the bidder provided written notice to all DBEs listed in the DBE directory at the time of the letting who are prequalified in the areas of work that the bidder will be subcontracting;
4. Whether the bidder followed up initial solicitations of interest by contacting DBEs to determine with certainty whether they were interested. If a reasonable amount of DBEs within the targeted districts do not provide an intent to quote or no DBEs are prequalified in the subcontracted areas, the bidder must notify the Disadvantaged Enterprise Business Liaison Officer (DEBLO) in the Office for Civil Rights and Small Business Development to give notification of the bidder's inability to get DBE quotes;
5. Whether the bidder selected portions of the work to be performed by DBEs in order to increase the likelihood of meeting the contract goals. This includes, where appropriate, breaking out contract work items into economically feasible units to facilitate DBE participation, even when the prime contractor might otherwise perform these work items with its own forces;
6. Whether the bidder provided interested DBEs with adequate and timely information about the plans, specifications, and requirements of the contract;
7. Whether the bidder negotiated in good faith with interested DBEs not rejecting them as unqualified without sound reasons based on a thorough investigation of their capabilities. Any rejection should be so noted in writing with a description as to why an agreement could not be reached;
8. Whether quotations were received from interested DBE firms but were rejected as unacceptable without sound reasons why the quotations were considered unacceptable. The fact that the DBE firm's quotation for the work is not the lowest quotation received will not in itself be considered as a sound reason for rejecting the quotation as unacceptable. The fact that the bidder has the ability and/or desire to perform the contract work with its own forces will not be considered a sound reason for rejecting a DBE quote. Nothing in this provision shall be construed to require the bidder to accept unreasonable quotes in order to satisfy DBE goals;
9. Whether the bidder specifically negotiated with subcontractors to assume part of the responsibility to meet the contract DBE goal when the work to be subcontracted includes potential DBE participation;
10. Whether the bidder made any efforts and/or offered assistance to interested DBEs in obtaining the necessary equipment, supplies, materials, insurance and/or bonding to satisfy the work requirements of the bid proposal; and
11. Any other evidence that the bidder submits which may show that the bidder has made reasonable good faith efforts to include DBE participation.

FAILURE TO MEET GOOD FAITH REQUIREMENT

Where the apparent lowest responsive bidder fails to submit sufficient participation by DBE firms to meet the contract goal and upon a determination by the Good Faith Committee based upon the information submitted that the apparent lowest responsive bidder failed to make sufficient reasonable efforts to meet the contract goal, the bidder will be offered the opportunity to meet in person for administrative reconsideration. The bidder will be notified of the Committee's decision within 24 hours of its decision. The bidder will have 24 hours to request reconsideration of the Committee's decision. The reconsideration meeting will be held within two days of the receipt of a request by the bidder for reconsideration.

The request for reconsideration will be heard by the Office of the Secretary. The bidder will have the opportunity to present written documentation or argument concerning the issue of whether it met the goal or made an adequate good faith effort. The bidder will receive a written decision on the reconsideration explaining the basis for the finding that the bidder did or did not meet the goal or made adequate Good Faith efforts to do so.

The result of the reconsideration process is not administratively appealable to the Cabinet or to the United States Department of Transportation.

The Cabinet reserves the right to award the contract to the next lowest responsive bidder or to rebid the contract in the event that the contract is not awarded to the low bidder as the result of a failure to meet the good faith requirement.

SANCTIONS FOR FAILURE TO MEET DBE REQUIREMENTS OF THE PROJECT

Failure by the prime contractor to fulfill the DBE requirements of a project under contract or to demonstrate good faith efforts to meet the goal constitutes a breach of contract. When this occurs, the Cabinet will hold the prime contractor accountable, as would be the case with all other contract provisions. Therefore, the contractor's failure to carry out the DBE contract requirements shall constitute a breach of contract and as such the Cabinet reserves the right to exercise all administrative remedies at its disposal including, but not limited to the following:

- Suspension of Prequalification;
- Disallow credit toward the DBE goal;
- Withholding progress payments;
- Withholding payment to the prime in an amount equal to the unmet portion of the contract goal; and/or
- Termination of the contract.

PROMPT PAYMENT

The prime contractor will be required to pay the DBE and Non-DBE Subcontractors within seven (7) working days after he or she has received payment from the Kentucky Transportation Cabinet for work performed or materials furnished.

CONTRACTOR REPORTING

All contractors must keep detailed records and provide reports to the Cabinet on their progress in meeting the DBE requirement on any highway contract. These records may include, but shall not be limited to payroll, lease agreements, cancelled payroll checks, executed subcontracting agreements, etc. Prime contractors will be required to complete and submit a **signed and notarized** Affidavit of Subcontractor Payment (TC 18-7) and copies of checks for any monies paid to each DBE subcontractor or supplier utilized to meet a DBE goal. These documents must be completed and signed within 7 days of being paid by the Cabinet.

Payment information that needs to be reported includes date the payment is sent to the DBE, check number, Contract ID, amount of payment and the check date. Before Final Payment is made on this contract, the Prime Contractor will certify that all payments were made to the DBE subcontractor and/or DBE suppliers.

***** IMPORTANT *****

Please mail the original, signed and completed TC (18-7) Affidavit of Subcontractor Payment form and all copies of checks for payments listed above to the following address:

Office for Civil Rights and Small Business Development
6th Floor West 200 Mero Street
Frankfort, KY 40622

The prime contractor should notify the KYTC Office for Civil Rights and Small Business Development seven (7) days prior to DBE contractors commencing work on the project. The contact in this office is Mr. Melvin Bynes. Mr. Bynes' current contact information is email address – melvin.bynes2@ky.gov and the telephone number is (502) 564-3601.

DEFAULT OR DECERTIFICATION OF THE DBE

If the DBE subcontractor or supplier is decertified or defaults in the performance of its work, and the overall goal cannot be credited for the uncompleted work, the prime contractor may utilize a substitute DBE or elect to fulfill the DBE goal with another DBE on a different work item. If after exerting good faith effort in accordance with the Cabinet's Good Faith Effort policies and procedures, the prime contractor is unable to replace the DBE, then the unmet portion of the goal may be waived at the discretion of the Cabinet.

PROHIBITION ON TELECOMMUNICATIONS EQUIPMENT OR SERVICES

In accordance with the FY 2019 National Defense Authorization Act (NDAA), 2 CFR 200.216, and 2 CFR 200.471, Federal agencies are prohibited, after August 13, 2020, from obligating or expending financial assistance to obtain certain telecommunications and video surveillance services and equipment from specific producers. As a result of these regulations, contractors and subcontractors are prohibited, on projects with federal funding participation, from providing telecommunication or video surveillance equipment, services, or systems produced by:

- Huawei Technologies Company or ZTE Corporation (or any subsidiary or affiliate of such entities)
- Hytera Communications Corporation, Hangzhou Hikvision Digital Technology Company, or Dahua Technology Company (or any subsidiary or affiliate of such entities)

LEGAL REQUIREMENTS AND RESPONSIBILITY TO THE PUBLIC – CARGO PREFERENCE ACT (CPA).

(REV 12-17-15) (1-16)

SECTION 7 is expanded by the following new Article:

102.10 **Cargo Preference Act – Use of United States-flag vessels.**

Pursuant to Title 46CFR Part 381, the Contractor agrees

- To utilize privately owned United States-flag commercial vessels to ship at least 50 percent of the gross tonnage (computed separately for dry bulk carriers, dry cargo liners, and tankers) involved, whenever shipping any equipment, material, or commodities pursuant to this contract, to the extent such vessels are available at fair and reasonable rates for United States-flag commercial vessels.
- To furnish within 20 days following the date of loading for shipments originating within the United States or within 30 working days following the date of loading for shipments originating outside the United States, a legible copy of a rated, 'on-board' commercial ocean bill-of-lading in English for each shipment of cargo described in paragraph 1 of this section to both the Contracting Officer (through the prime contractor in the case of subcontractor bills-of-lading) and to the Division of National Cargo, Office of Market Development, Maritime Administration, Washington, DC 20590.
- To insert the substance of the provisions of this clause in all subcontracts issued pursuant to this contract.

NATIONAL HIGHWAY

Be advised this project is on the NATIONAL HIGHWAY SYSTEM.

General Project Notes for Pavement Markers

1. General. The intent of this contract is to furnish and install Inlaid Pavement Markers for newly resurfaced roads and maintenance of existing markers on select routes. The roadway segments listed in the summary have been identified as either being **TIER 1**, **TIER 2**, or **TIER 3**.

TIER 1 routes are defined as:

- roadway segments with existing pavement markers that need a portion of the lenses replaced or are in need of additional pavement markers
- roadway segments that have recently been surfaced and are currently ready for installation of pavement markers

TIER 2 routes are defined as:

- roadway segments that are under contract for pavement surfacing or preventative maintenance and are anticipated to be surfaced on or before 9/30/2022

TIER 3 routes are defined as:

- roadway segments that are scheduled for pavement surfacing or preventative maintenance where the surfacing work is not anticipated to be completed on or before 9/30/2022

If the Engineer, through coordination with the pavement surfacing contractor, determines that a **TIER 3** route will be surfaced earlier than 9/30/2022, the Engineer has the discretion to change the designation of such a route from **TIER 3** to **TIER 2**, provided the Engineer notifies the Pavement Marker Contractor in writing before August 1, 2022. If the Engineer, through coordination with the pavement surfacing contractor, determines that a **TIER 2** route will not be surfaced on or before than 9/30/2022, the Engineer will change the designation of such a route from **TIER 2** to **TIER 3**. The Engineer will communicate such a change to the Pavement Marker Contractor once the Department becomes aware of this situation.

The Pavement Marker Contractor should begin coordination with the Engineer early to identify the expected completion of the surfacing of Tier 2 and Tier 3 routes, so that new pavement markers can be installed shortly after the surfacing is completed.

The Engineer has the discretion to remove any route from the contract.

2. Completion Date. See the Special Note for Completion Dates & Liquidated Damages.

3. Conflicts. When other construction projects are in progress within the limits of the designated work areas, install no pavement markers that will be removed or damaged by immediate subsequent construction. The Engineer will give notification of all conflicting construction projects. Schedule the installation of pavement markers after completion of the conflicting construction. When scheduling is impossible or creates an undue hardship, the Engineer will remove the site from this project.

4. Caution. The information in this proposal and the type of work listed herein are approximate only and are not to be taken as an exact evaluation of the materials and conditions to be encountered during construction;

General Project Notes for Pavement Markers
Page 2 of 2

the bidder must draw his/her own conclusions when developing the Unit Bid Prices for each bid item. As such, if the conditions encountered are not in accordance with the information shown, the Department does not guarantee any changes to the Unit Bid Prices nor extension of the contract. The Department will pay for bid item quantity overruns, but only if pre-approved by the Engineer.

5. Control. Perform all work under the absolute control of the Department of Highways. Obtain the Engineer's approval of all designs required to be furnished by the Contractor prior to incorporation into the work. The Department reserves the right to have other work performed by other contractors and its own forces and to permit public utility companies and others to do work during the construction within the limits of, or adjacent to, the project. Conduct operations and cooperate with such other parties so that interference with such other work will be reduced to a minimum. The Department will not honor any claims for money or time extension created by the operations of such other parties. Should a difference of opinion arise as to the rights of the Contractor and others working within the limits of, or adjacent to, the project, the Engineer will decide as to the respective rights of the various parties involved in order to assure the completion of the Department's work in general harmony and in a satisfactory manner, and his/her decision shall be final and binding upon the Contractor.

Special Notes for Completion Dates & Liquidated Damages

For the routes indicated as **TIER 1**, there is a fixed milestone date of **May 31, 2023**. For the routes indicated as **TIER 2**, there is a fixed milestone date of **July 31, 2023**. For the routes indicated as **TIER 3**, and all other work within this contract, the ultimate fixed completion date is **October 31, 2023**.

Failure to complete a **TIER 1** route by the corresponding fixed milestone date for **TIER 1** routes will result in a 10% penalty of the total cost of the pavement markers for that route.

Failure to complete a **TIER 2** route by the corresponding fixed milestone date for **TIER 2** routes will result in a 10% penalty of the total cost of the pavement markers for that route. The Engineer has the discretion to waive this penalty due to unforeseen circumstances, such as excessive poor weather, that prevent the installation of pavement markers before the fixed milestone date.

The Engineer has the discretion to bump any route down to a lower tier or remove any route from the contract if necessary.

Contrary to Section 108.09, Liquidated Damages will be assessed for the months of December through March.

Contrary to Section 108.09, Liquidated Damages will be assessed regardless of whether seasonal limitations prohibit the Contractor from performing work on the controlling operation.

All liquidated damages will be applied accumulatively.

All other applicable portions of Section 108 apply.

COORDINATION OF WORK WITH OTHER CONTRACTS

Be advised, there may be an active project(s) adjacent to or within this project. The Engineer will coordinate the work of the Contractors. See Section 105.06.

1-3193 Coordination Contracts
01/02/2012

TRAFFIC CONTROL PLAN

PAVEMENT MARKER INSTALLATION

TRAFFIC CONTROL GENERAL

Except as provided herein, maintain and control traffic in accordance with the Standard and Supplemental Specifications and the Standard and Sepia Drawings, current editions. Except for the roadway and traffic control bid items listed, all items of work necessary to maintain and control traffic will be paid at the lump sum bid price to "Maintain and Control Traffic".

Contrary to Section 106.01, furnish new, or used in like new condition, traffic control devices at the beginning of the work and maintain in like new condition until completion of the work.

Do not install Inlaid Pavement Markers on bridge decks. If pavement markers are specified for bridge decks, use flush-mounted Type IV-A markers. Install all necessary traffic control devices before beginning work. Provide egress and ingress to all ramps, side roads, and entrances at all times. After the pavement markers have been placed on the roadway, leave traffic control devices in place to protect the markers from damage by traffic until the Engineer determines the adhesive epoxy has sufficiently hardened. When work is suspended or completed and the Engineer determines the pavement markers are completely bonded to the pavement, immediately remove the traffic control devices.

Provide the Engineer with a proposed work schedule and traffic control plans for review a minimum of two weeks prior to beginning work.

TWO-LANE, TWO-WAY ROADWAYS

The Department will consider installation of raised pavement markers on two-lane, two-way roadway sections to be short-duration operations. Accomplish the work in only one lane and affect the adjacent lane as little as possible. Sign approaches to the immediate work area in accordance with Standard Drawing TTC-100, current edition. Install the signs on approved temporary mountings.

As a minimum, equip all work vehicles used in the roadway with flashing LED warning lights. If a flashing arrow board is mounted directly on a work vehicle, operate the board in caution mode only; do not use a flashing arrow indication. The Department will not require the use of a Truck Mounted Attenuator (TMA) on two-lane, two-way roadway sections.

Maintain a minimum lane width of 10 feet (including paved shoulders). Do not use consecutive lane closures unless they are separated by two (2) miles or more. Use signs G20-1 and G20-2A to indicate the limits of the planned work area in a given shift.

MULTI-LANE ROADWAYS (NON-INTERSTATES)

Place raised pavement markers behind stationary lane closures. Obtain the Engineer's approval for stationary lane closures prior to use. Sign approved stationary lane closures according to Standard Drawings TTC-115 and

Traffic Control Plan

Page 2 of 4

TTC-125, current editions. Grabber cones will be acceptable for day and night work to provide adequate lane widths. If the Contractor desires an interior lane closure, prepare a plan and obtain the Engineer's approval prior to use. Install all necessary traffic control devices before beginning work.

Protect the work zone with a TMA conforming to Section 725.02.05 and 725.03.03. Place the TMA within the lane closure at locations approved by the Engineer.

Restrict the work area to not more than one lane of traffic plus 24 inches maximum of only one adjacent lane in each direction of travel. Provide a minimum lane width of 10 feet on surface streets; however, provide for passage of vehicles of up to 16 feet in width. Limit the length of a lane closure to not exceed 1 mile in urban areas or 3 miles in rural areas as designated by the Engineer. Do not erect more than one lane closure in each direction of travel unless there is at least 2 miles of separation between lane closures.

INTERSTATES

Place raised pavement markers behind stationary lane closures. Obtain the Engineer's approval for stationary lane closures prior to use. Sign approved stationary lane closures according to Standard Drawings TTC-115 and TTC-125, current editions. Grabber cones will be acceptable for day and night work to provide adequate lane widths. Barrels shall be required in all lane closure tapers on all interstates and entrance and exit ramps. If the Contractor desires an interior lane closure, prepare a plan and obtain the Engineer's approval prior to use. Install all necessary traffic control devices before beginning work.

Protect the work zone with a TMA conforming to Sections 725.02.05 and 725.03.03. Place the TMA within the lane closure at locations approved by the Engineer. Contrary to Section 725.03.03, retain possession of the TMA upon completion of the work.

Restrict the work area to not more than one lane of traffic plus 24 inches maximum of only one adjacent lane in each direction of travel. On routes with three (3) or more lanes in a direction, multiple lanes may be closed simultaneously; however, the quantity of lanes to be closed and working hours shall be designated by the Engineer. Provide a minimum lane width of 11 feet, including entrance and exit ramps. Provide for passage of vehicles of up to 16 feet in width. Limit the length of a lane closure to not exceed 2 miles in urban areas or 4 miles in rural areas or as directed by the Engineer. Do not erect more than one lane closure in each direction of travel unless there is at least 2 miles of separation between lane closures.

If requested by the Contractor, the Engineer may approve Law Enforcement Officer Police Support on Interstate highways when pavement marker operations are taking place. If the Contractor requests Law Enforcement Officer Police Support on other than Interstate Highways, provide written justification for the Engineer's approval. If approved, provide one (1) police support unit for each lane closure, each unit consisting of an off-duty law enforcement officer from any police agency having lawful jurisdiction and a police car equipped with externally mounted flashing blue lights. Place the police support unit at a location that is most effective to alert traffic of the work, but safe for the workers and the officer. The Department will measure and pay for each approved individual police support unit on a per hour basis for the officer with the police vehicle. If police support is utilized without prior approval by the Engineer, the Department may deny payment for any invoiced hours prior to the approval date.

WORKING HOURS

The Contractor shall submit weekly project updates to the Engineer by the close of business every Thursday. These shall include times and locations of anticipated work for the following week (Monday-Sunday). This information will be used to schedule the inspection staff, coordinate with other projects, possible events and disseminated to the public and local media. All new and revised traffic control plans in all counties and working hour requests for Jefferson County shall be submitted to the Engineer for review a minimum of 14 calendar days prior to beginning the subject work.

LANE CLOSURES ARE NOT PERMITTED DURING THE FOLLOWING PERIODS:

Easter Weekend	3 pm Friday, April 15, 2022 – 8 pm Sunday, April 17, 2022
Memorial Day Weekend	3 pm Friday, May 27, 2022 – 8 pm Monday, May 30, 2022
Independence Day	7 am Saturday, July 2, 2022 – 11 pm Monday, July 4, 2022
Labor Day Weekend	3 pm Friday, September 2, 2022 – 8 pm Monday, September 5, 2022
Thanksgiving Holiday	3 pm Wednesday, November 23, 2022 – 8 pm Sunday, November 27, 2022
Christmas Holiday	3 pm Friday, December 23, 2022 – 8 pm Sunday, December 25, 2022
New Year’s Day Holiday	7 am Saturday, December 31, 2022 – 8 pm Sunday, January 1, 2023
Easter Weekend	3 pm Friday, April 7, 2023 – 8 pm Sunday, April 9, 2023
Memorial Day Weekend	3 pm Friday, May 26, 2023 – 8 pm Monday, May 29, 2023
Independence Day	7 am Saturday, July 1, 2023 – 11 pm Tuesday, July 4, 2023
Labor Day Weekend	3 pm Friday, September 1, 2023 – 8 pm Monday, September 4, 2023

LANE CLOSURES ARE PERMITTED DURING THE FOLLOWING HOURS:

INTERSTATES AND RAMPS IN ALL COUNTIES

- Nightly between 8:00 P.M. – 5:00 A.M. for single lane closures
- Hours for multiple lane closures shall be determined by the Engineer & specific to each location

NON-INTERSTATE ROUTES IN ALL COUNTIES

- Monday through Friday 9:00 A.M. – 3:00 P.M.
- Monday through Thursday nights 7:00 P.M. – 6:00 A.M.
- Friday night through Monday morning 7:00 P.M. – 6:00 A.M.

The Engineer may specify additional days and hours when lane closures will not be allowed.

LANE CLOSURE LIQUIDATED DAMAGES

Do not leave lane closures in place during non-working hours. In the event that lane closures on non-interstate routes are in place outside of the days and/or times listed above or outside of any time period approved by the Engineer, Liquidated Damages shall be applied as follows:

- \$ 2,500 for the first hour or fraction thereof
- \$ 5,000 for any additional hour or fraction thereof

In the event that lane closures on an interstate or ramp are in place outside of the days and/or times listed above or outside of any time period approved by the Engineer, Liquidated Damages shall be applied as follows:

- \$ 5,000 for the first hour or fraction thereof
- \$ 10,000 for any additional hour or fraction thereof

Traffic Control Plan
Page 4 of 4

A lane closure shall be defined as any traffic control device, worker, or vehicle owned/operated by the Contractor or the Contractor's worker(s) in the traveled way that could potentially impact the flow of traffic. This includes but is not limited to signs, barricades, barrels, cones, arrow boards, flaggers, and equipment.

See the Special Note for Completion Dates & Liquidated Damages for additional Liquidated Damages.

ARROW PANELS

Use arrow panels as shown on the Standard Drawings or as directed by the Engineer. Contrary to Section 112 of the Standard Specifications, the Department will not measure arrow panels for payment but will consider them incidental to the bid item MAINTAIN & CONTROL TRAFFIC.

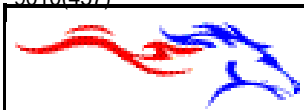

KENTUCKY TRANSPORTATION CABINET
Department of Highways
DIVISION OF RIGHT OF WAY & UTILITIES

TC 62-226
Rev. 01/2016
Page 1 of 1

RIGHT OF WAY CERTIFICATION

<input checked="" type="checkbox"/>	Original	<input type="checkbox"/>	Re-Certification	RIGHT OF WAY CERTIFICATION			
ITEM #		COUNTY		PROJECT # (STATE)		PROJECT # (FEDERAL)	
1-985.00		Various		FD52 121 9999 000-000		HSIP 9010(457)	
PROJECT DESCRIPTION							
Installation of Pavement Markers on Various Routes in District 1							
<input checked="" type="checkbox"/>	No Additional Right of Way Required						
Construction will be within the limits of the existing right of way. The right of way was acquired in accordance to FHWA regulations under the Uniform Relocation Assistance and Real Property Acquisitions Policy Act of 1970, as amended. No additional right of way or relocation assistance were required for this project.							
<input type="checkbox"/>	Condition # 1 (Additional Right of Way Required and Cleared)						
All necessary right of way, including control of access rights when applicable, have been acquired including legal and physical possession. Trial or appeal of cases may be pending in court but legal possession has been obtained. There may be some improvements remaining on the right-of-way, but all occupants have vacated the lands and improvements, and KYTC has physical possession and the rights to remove, salvage, or demolish all improvements and enter on all land. Just Compensation has been paid or deposited with the court. All relocations have been relocated to decent, safe, and sanitary housing or that KYTC has made available to displaced persons adequate replacement housing in accordance with the provisions of the current FHWA directive.							
<input type="checkbox"/>	Condition # 2 (Additional Right of Way Required with Exception)						
The right of way has not been fully acquired, the right to occupy and to use all rights-of-way required for the proper execution of the project has been acquired. Some parcels may be pending in court and on other parcels full legal possession has not been obtained, but right of entry has been obtained, the occupants of all lands and improvements have vacated, and KYTC has physical possession and right to remove, salvage, or demolish all improvements. Just Compensation has been paid or deposited with the court for most parcels. Just Compensation for all pending parcels will be paid or deposited with the court prior to AWARD of construction contract							
<input type="checkbox"/>	Condition # 3 (Additional Right of Way Required with Exception)						
The acquisition or right of occupancy and use of a few remaining parcels are not complete and/or some parcels still have occupants. All remaining occupants have had replacement housing made available to them in accordance with 49 CFR 24.204. KYTC is hereby requesting authorization to advertise this project for bids and to proceed with bid letting even though the necessary right of way will not be fully acquired, and/or some occupants will not be relocated, and/or the just compensation will not be paid or deposited with the court for some parcels until after bid letting. KYTC will fully meet all the requirements outlined in 23 CFR 635.309(c)(3) and 49 CFR 24.102(j) and will expedite completion of all acquisitions, relocations, and full payments after bid letting and prior to AWARD of the construction contract or force account construction.							
Total Number of Parcels on Project		0	EXCEPTION (S) Parcel #		ANTICIPATED DATE OF POSSESSION WITH EXPLANATION		
Number of Parcels That Have Been Acquired							
Signed Deed							
Condemnation							
Signed ROE							
Notes/ Comments (Use Additional Sheet if necessary)							
LPA RW Project Manager				Right of Way Supervisor			
Printed Name				Printed Name		Greg L. Morgan	
Signature				Signature			
Date				Date			
Right of Way Director				FHWA			
Printed Name				Printed Name			
Signature				Signature			
Date				Date			

UTILITIES AND RAIL CERTIFICATION NOTE

HSIP 9010(457)
FD52 121 9999 000-000
Installation of Pavement Markers on Various Routes in District 1
Item No. 1-985

GENERAL PROJECT NOTES ON UTILITIES

For all projects over 2000 linear feet, which are defined as a “Large Project” in KRS 367.4903(18), the awarded contractor shall initially mark the first 2000 linear feet minimally of proposed excavation or construction boundaries of the project to be worked using the procedure set forth in KRS 367.4909(9)(k). This temporary field locating of the project excavation boundary shall take place prior to submitting an excavation location request to the underground utility protection Kentucky Contact Center. For large projects, the awarded contractor shall work with the impacted utilities to determine when additional white lining of the remainder of the project site will take place. This provision shall not alter or relieve the awarded contractor from complying with requirements of KRS 367.4905 to 367.4917 in their entirety.

NOTE: The information presented in this Utility Note is informational in nature and the information contained herein is not guaranteed.

The contractor will be responsible for contacting all utility facility owners on the subject project to coordinate his/her activities. The contractor will coordinate his/her activities to minimize and, where possible, avoid conflicts with utility facilities. Due to the nature of the work proposed, it is unlikely to conflict with the existing utilities beyond minor facility adjustments. Where conflicts with utility facilities are unavoidable, the contractor will coordinate any necessary relocation work with the facility owner and Resident Engineer. The Kentucky Transportation Cabinet maintains the right to remove or alter portions of this contract if a utility conflict occurs. The utility facilities as noted in the previous section(s) have been determined using data garnered by varied means and with varying degrees of accuracy: from the facility owners, a result of S.U.E., field inspections, and/or reviews of record drawings. The facilities defined may not be inclusive of all utilities in the project scope and are not Level A quality, unless specified as such. It is the contractor’s responsibility to verify all utilities and their respective locations before excavating.

The contractor shall make every effort to protect underground facilities from damage as prescribed in the Underground Facility Damage Protection Act of 1994, Kentucky Revised Statute KRS 367.4901 to 367.4917. It is the contractor’s responsibility to determine and take steps necessary to be in compliance with federal and state damage prevention directives. The contractor is instructed to contact KY 811 for the location of existing underground utilities. Contact shall be made a minimum of two (2) and no more than ten (10) business days prior to excavation. The contractor shall submit Excavation Locate Requests to the Kentucky Contact Center (KY 811) via web ticket entry. The submission of this request does not relieve the contractor from the responsibility of contacting non-member facility owners, whom are to be contacted through their individual Protection Notification Center. It may be necessary for the contractor to contact the County Court Clerk to determine what utility companies have facilities in the area. Non-compliance with these directives can result in the enforcement of penalties.

UTILITIES AND RAIL CERTIFICATION NOTE

**HSIP 9010(457)
FD52 121 9999 000-000
Installation of Pavement Markers on Various Routes in District 1
Item No. 1-985**

NOTE: DO NOT DISTURB THE FOLLOWING UTILITIES LOCATED WITHIN THE PROJECT DISTURB LIMITS

There are no known utility relocations within the project limits. If an unknown utility is encountered, the contractor will be responsible for arranging an on-site meeting with the utility owner/representative(s) and the Engineer to discuss potential impacts and solutions to either avoid the utility or relocate the utility. Depending on the solution selected, the Engineer will determine whether or not additional contract time is appropriate.

The Contractor is fully responsible for protection of all utilities encountered

THE FOLLOWING COMPANIES ARE RELOCATING/ADJUSTING THEIR UTILITIES WITHIN THE PROJECT LIMITS AND WILL BE COMPLETE PRIOR TO CONSTRUCTION

None

THE FOLLOWING COMPANIES HAVE FACILITIES TO BE RELOCATED/ADJUSTED BY THE COMPANY OR THE COMPANY'S SUBCONTRACTOR AND IS TO BE COORDINATED WITH THE ROAD CONTRACT

None

THE FOLLOWING COMPANIES HAVE FACILITIES TO BE RELOCATED/ADJUSTED BY THE ROAD CONTRACTOR AS INCLUDED IN THIS CONTRACT

None

RAIL COMPANIES HAVE FACILITIES IN CONJUNCTION WITH THIS PROJECT AS NOTED

No Rail Involvement Rail Involved Rail Adjacent

DISTRICT 1

Calloway Co.

KY-80 MP 0.000 - 2.786
KY-80 MP 10.204 - 22.683

Trigg Co.

US-68 MP 20.657 - 24.168

Graves Co.

US-45 MP 19.600 - 20.600

McCracken Co.

US-45 MP 9.224 - 9.824
US-45 MP 9.870 - 10.806
US-45X MP 2.119 - 2.435
US-45X MP 2.807 - 2.946
US-45X MP 2.795 - 2.039 (One-Way)
US-60 MP 2.218 - 7.700
US-60 MP 13.195 - 16.420
US-60 MP 19.496 - 20.015
US-60X MP 0.900 - 2.910
US-60X MP 3.025 - 3.112
US-60X MP 2.166 - 1.060 (One-Way)
US-62 MP 14.042 - 15.188

Marshall Co.

US-641 MP 1.224 - 3.000
US-641S MP 0.000 - 1.324
US-641S MP 1.840 - 3.250



General Summary

Bid Code	Bid Description	QTY	Unit
2650	Maintain & Control Traffic	1	LS
6610	Inlaid Pavement Marker-MW	1,635	EACH
6612	Inlaid Pavement Marker-BY	745	EACH
6613	Inlaid Pavement Marker-B W/R	4,410	EACH
6614	Inlaid Pavement Marker-B Y/R	33	EACH
2569	Demobilization	1	LS

Pavement Marker and Lens Replacement Recommendations

*** The details, quantities, and information listed are approximate and are not to be taken as an exact evaluation of the materials and conditions to be encountered during construction. ***

District 1

County	Route		Milepoints		Surface	TIER (1, 2 or 3)	4 Lane Divided (median ≥30')	4 Lane Divided (median <30')	4 Lane Undiv.	3 Lane (CLTL)	5 Lane (CLTL)	Other	Turn Lanes		Gore Areas/Ramps		Marker Type		Comments <small>(Please describe specifics of highway section here, if applicable)</small>
	Prefix	Number	Suffix	Begin									End	Number	Average Length	Number of Gores-Avg. Length / Number of Ramps-Avg. Length	Inlaid/Casing	Marker/Lens	
Calloway	KY	80		0.000	2.786	BIT	X						19	320	Inlaid	Marker			
McCracken	US	60		13.402	16.324	BIT/CONC			X				11	200	Inlaid	Marker			
McCracken	US	60		16.324	16.420	BIT		X					2	160	Inlaid	Marker			
McCracken	US	45		9.870	10.806	BIT				X			10	100	Inlaid	Marker			
McCracken	US	60		13.195	13.402	BIT				X					Inlaid	Marker			
Marshall	US	641	S	1.840	3.250	BIT	X						7	230	Inlaid	Marker			CID 212456 Completion Date: 9/30/2022
Trigg	US	68		20.657	23.796	BIT	X						16	355	Inlaid	Marker			Westbound Direction ONLY CID 212374 Completion Date: 6/30/2022
Trigg	US	68		23.796	24.168	BIT			X				4	340	Inlaid	Marker			2-Lane, One-Way Roadway CID 212238 Completion Date: 6/30/2022
Calloway	KY	80		10.204	16.484	BIT	X						41	335	Inlaid	Marker			2-Lane, One-Way Roadway CID 212238 Completion Date: 6/30/2022
Calloway	KY	80		16.484	22.683	BIT	X						19	300	Inlaid	Marker			2-Lane, One-Way Roadway CID 212238 Completion Date: 6/30/2022
McCracken	US	60	X	0.900	1.823	BIT						X			Inlaid	Marker			2-Lane, One-Way Roadway CID 212238 Completion Date: 6/30/2022
McCracken	US	45 (One-Way)	X	2.795	2.550	BIT						X			Inlaid	Marker			2-Lane, One-Way Roadway CID 212238 Completion Date: 6/30/2022
McCracken	US	45 (One-Way)	X	2.505	2.039	BIT						X			Inlaid	Marker			2-Lane, One-Way Roadway CID 212238 Completion Date: 6/30/2022
McCracken	US	60	X	1.823	2.030	BIT						X			Inlaid	Marker			2-Lane, One-Way Roadway CID 212238 Completion Date: 6/30/2022
McCracken	US	60 (One-Way)	X	2.166	1.832	BIT						X			Inlaid	Marker			2-Lane, One-Way Roadway CID 212238 Completion Date: 6/30/2022
McCracken	US	45	X	2.119	2.435	BIT						X			Inlaid	Marker			2-Lane, One-Way Roadway CID 212238 Completion Date: 6/30/2022
McCracken	US	45	X	2.807	2.946	BIT						X			Inlaid	Marker			2-Lane, One-Way Roadway CID 212238 Completion Date: 6/30/2022
McCracken	US	60 (One-Way)	X	1.832	1.060	BIT						X	1	100	Inlaid	Marker			2-Lane, One-Way Roadway CID 212238 Completion Date: 6/30/2022
McCracken	US	60		2.218	7.700	BIT	X						16	310	Inlaid	Marker			CID 212190 Completion Date: 6/30/2022
McCracken	US	45		9.224	9.327	BIT		X					2	350	Inlaid	Marker			Curb within 8 ft of fast lane CID 222049 Completion Date: 11/15/2022
McCracken	US	45		9.327	9.512	BIT					X		1	120	Inlaid	Marker			CID 222049 Completion Date: 11/15/2022
McCracken	US	45		9.512	9.824	BIT			X				1	120	Inlaid	Marker			CID 222049 Completion Date: 11/15/2022
McCracken	US	60		19.496	20.015	BIT						X	1	300	Inlaid	Marker			Eastbound Direction ONLY CID 222046 Completion Date: 11/15/2022

Pavement Marker and Lens Replacement Recommendations

***The details, quantities, and information listed are approximate and are not to be taken as an exact evaluation of the materials and conditions to be encountered during construction. ***

District 1

County	Route		Milepoints		Surface (BIT/CONC)	TIER (1, 2 or 3)	4 Lane Divided (median ≥30')	4 Lane Divided (median <30')	4 Lane Undiv.	3 Lane (CLTL)	5 Lane (CLTL)	Other	Turn Lanes		Gore Areas/Ramps		Marker Type		Comments (Please describe specifics of highway section here, if applicable)
	Prefix	Number	Begin	End									Number	Average Length	Number of Gores-Avg. Length / Number of Ramps-Avg. Length	Inlaid/Casting	Marker/Lens		
McCracken	US	60	2.230	2.910	BIT	3			X							Inlaid	Marker	CID 222041 Completion Date: 11/15/2022	
McCracken	US	60	3.025	3.112	BIT	3			X							Inlaid	Marker		
McCracken	US	62	14.042	15.188	BIT	3	X						8	110		Inlaid	Marker	CID 222243 Completion Date: 11/15/2022	
Marshall	US	641	1.224	3.000	BIT	3	X									Inlaid	Marker	CID 222195 Completion Date: 11/15/2022	
Marshall	US	641	0.000	1.324	BIT	3	X						3	200		Inlaid	Marker	CID 222195 Completion Date: 11/15/2022	
Graves	US	45	19.600	20.600	BIT	3			X							Inlaid	Marker		

Pavement Marker and Lens Replacement Recommendations

*** The details, quantities, and information listed are approximate and are not to be taken as an exact evaluation of the materials and conditions to be encountered during construction. ***

Description of Types:

1	4-Lane, Divided (Median ≥ 30') or Barrier	4	3-Lane, CLTL	7	2-Lane
2	4-Lane, Divided (Median < 30')	5	5-Lane, CLTL	8	3-Lane, TCL
3	4-Lane Undivided	6	Other		

Type	County	Route		Milepoints		Surface	TIER (1, 2 or 3)	Lens Replacement - Pavement Marker Type IV				In-laid Pavement Marker Installation								
		Prefix	Number	Suffix	Begin			End	Mono-Direction	Bi-Direction	Bi-Direction	Bi-Direction	Mono-Direction	Yellow	White	Yellow	White / Red	Yellow / Red		
1	Calloway	KY	80		0.000	2.786	BIT	1										530		
3	McCracken	US	60		13.402	16.324	BIT/CONC	1					386			193				
2	McCracken	US	60		16.324	16.420	BIT	1					14		28					
4	McCracken	US	45		9.870	10.806	BIT	1					124		247					
4	McCracken	US	60		13.195	13.402	BIT	1					28		56					
1	Marshall	US	641	S	1.840	3.250	BIT	1									237			33
1	Trigg	US	68		20.657	23.796	BIT	1									574			
3	Trigg	US	68		23.796	24.168	BIT	1								41			88	
1	Calloway	KY	80		10.204	16.484	BIT	2											1215	
1	Calloway	KY	80		16.484	22.683	BIT	2											570	
6	McCracken	US	60	X	0.900	1.823	BIT	2									122			
6	McCracken	US	45 (One-Way)	X	2.795	2.550	BIT	2									32			
6	McCracken	US	45 (One-Way)	X	2.505	2.039	BIT	2									62			
6	McCracken	US	60	X	1.823	2.030	BIT	2									27			
6	McCracken	US	60 (One-Way)	X	2.166	1.832	BIT	2									44			
6	McCracken	US	45	X	2.119	2.435	BIT	2									42			
6	McCracken	US	45	X	2.807	2.946	BIT	2									18			
6	McCracken	US	60 (One-Way)	X	1.832	1.060	BIT	2									102			
1	McCracken	US	60		2.218	7.700	BIT	2											724	
2	McCracken	US	45		9.224	9.327	BIT	3									14		14	
5	McCracken	US	45		9.327	9.512	BIT	3									24		24	
3	McCracken	US	45		9.512	9.824	BIT	3									41		41	
6	McCracken	US	60		19.496	20.015	BIT	3									69			

PART II
SPECIFICATIONS AND STANDARD DRAWINGS

SPECIFICATIONS REFERENCE

Any reference in the plans or proposal to previous editions of the *Standard Specifications for Road and Bridge Construction* and *Standard Drawings* are superseded by *Standard Specifications for Road and Bridge Construction, Edition of 2019* and *Standard Drawings, Edition of 2020*.

SUPPLEMENTAL SPECIFICATIONS

The contractor shall use the Supplemental Specifications that are effective at the time of letting.
The Supplemental Specifications can be found at the following link:

<http://transportation.ky.gov/Construction/Pages/Kentucky-Standard-Specifications.aspx>

2020 STANDARD DRAWINGS THAT APPLY

TRAFFIC

~ PERMANENT ~

MARKERS

INLAID PAVEMENT MARKER ARRANGEMENTS MULTI-LANE ROADWAYS.....	Sepia 006
INLAID PAVEMENT MARKER ARRANGEMENTS MULTI-LANE ROADWAYS.....	Sepia 007
INLAID PAVEMENT MARKER ARRANGEMENTS MULTI-LANE ROADWAYS.....	Sepia 008
INLAID PAVEMENT MARKER ARRANGEMENTS TWO-LANE TWO-WAY ROADWAYS	Sepia 009
INLAID PAVEMENT MARKER ARRANGEMENT TWO-LANE TO FOUR-LANE TRANSITIONS	Sepia 010
INLAID PAVEMENT MARKER ARRANGEMENT EXIT-GORE AND OFF-RAMP	Sepia 011
INLAID PAVEMENT MARKER ARRANGEMENTS FOR PARALLEL DECELERATION LANE.....	Sepia 012
INLAID PAVEMENT MARKER ARRANGEMENTS ON-RAMP WITH TAPERED ACCELERATION LANE	Sepia 013
INLAID PAVEMENT MARKER ARRANGEMENT ON-RAMP WITH PARALLEL ACCELERATION LANE	Sepia 014
INLAID PAVEMENT MARKER ARRANGEMENTS TWO-WAY LEFT TURN LANE	Sepia 015
INLAID PAVEMENT MARKER ARRANGEMENT CHANNELIZED INTERSECTION	Sepia 016

~ TEMPORARY ~

TRAFFIC CONTROL

LANE CLOSURE TWO-LANE HIGHWAY.....	TTC-100-05
LANE CLOSURE MULTI-LANE HIGHWAY CASE I	TTC-115-04
DOUBLE LANE CLOSURE	TTC-125-04
SHOULDER CLOSURE	TTC-135-03

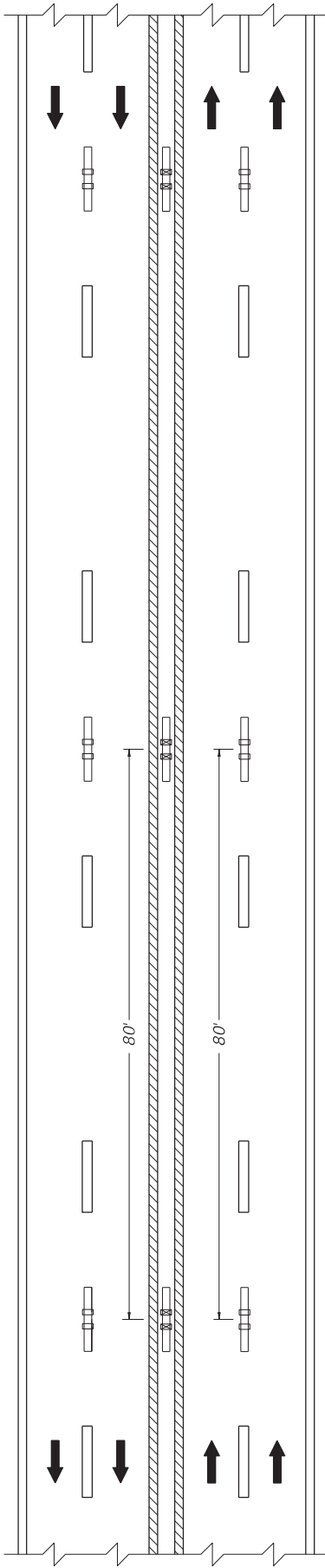

ARRANGEMENT "A" (UNDIVIDED HIGHWAY)

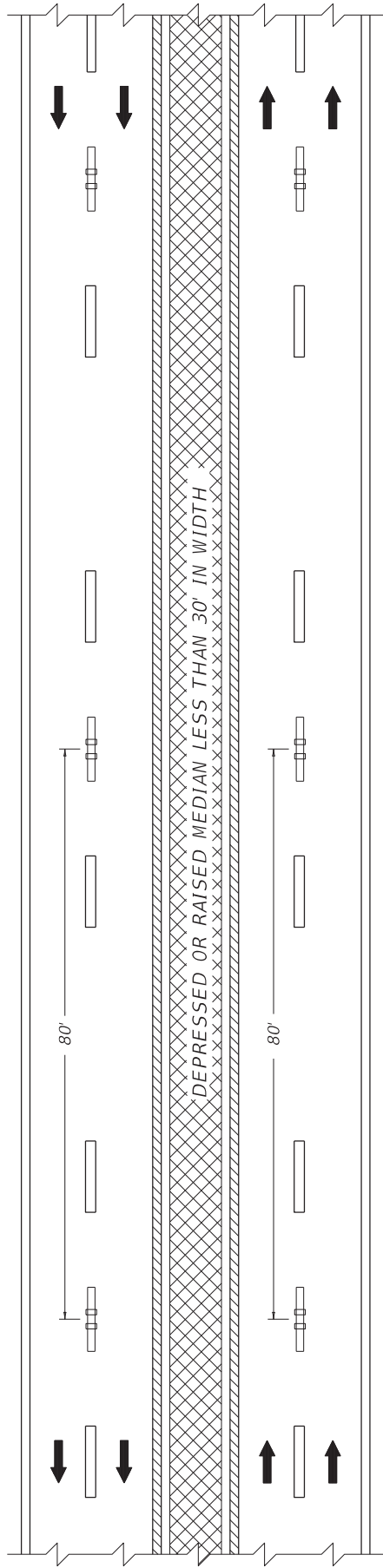

ARRANGEMENT "B" (DIVIDED HIGHWAY WITH DEPRESSED OR RAISED MEDIAN LESS THAN 30' IN WIDTH)

- ~ NOTES ~
1. MARKERS INSTALLED WITH DOUBLE YELLOW CENTERLINES SHOULD BE PLACED BETWEEN THE TWO LINES.
 2. MARKERS INSTALLED ALONG LANE LINES SHOULD BE PLACED BETWEEN AND IN LINE WITH THE SKIPS.
 3. MARKERS SHALL NOT BE INSTALLED ON TOP OF THE PAVEMENT JOINT. OFFSET MARKERS A MINIMUM OF 2" FROM THE PAVEMENT JOINT. ENSURE THAT THE FINISHED LINE OF MARKERS IS STRAIGHT WITH MINIMAL LATERAL DEVIATION. MARKERS MAY BE ELIMINATED OR PLACEMENT ADJUSTED AT THE DISCRETION OF THE ENGINEER.
 4. MARKERS SHALL BE INSTALLED AT 40' SPACING ALONG SOLID WHITE AUXILIARY LANES. MARKER COLOR SHALL MATCH THE MARKERS INSTALLED ALONG THE WHITE LANE LINES.
 BID ITEMS
 06610 - INLAID PAVEMENT MARKER - MW
 06612 - INLAID PAVEMENT MARKER - BY
 UNIT TO BID
 EACH
 EACH

LEGEND

	BI-DIRECTIONAL PAVEMENT MARKER (YELLOW)
	MONO-DIRECTIONAL PAVEMENT MARKER (WHITE)
	MARKINGS (YELLOW)
	MARKINGS (WHITE)
	DEPRESSED OR RAISED MEDIAN

DRAWING NOT TO SCALE

KENTUCKY DEPARTMENT OF HIGHWAYS
INLAID PAVEMENT MARKER ARRANGEMENTS MULTI-LANE ROADWAYS

SUBMITTED DIVISION DIRECTOR
06-09-21 DATE
006

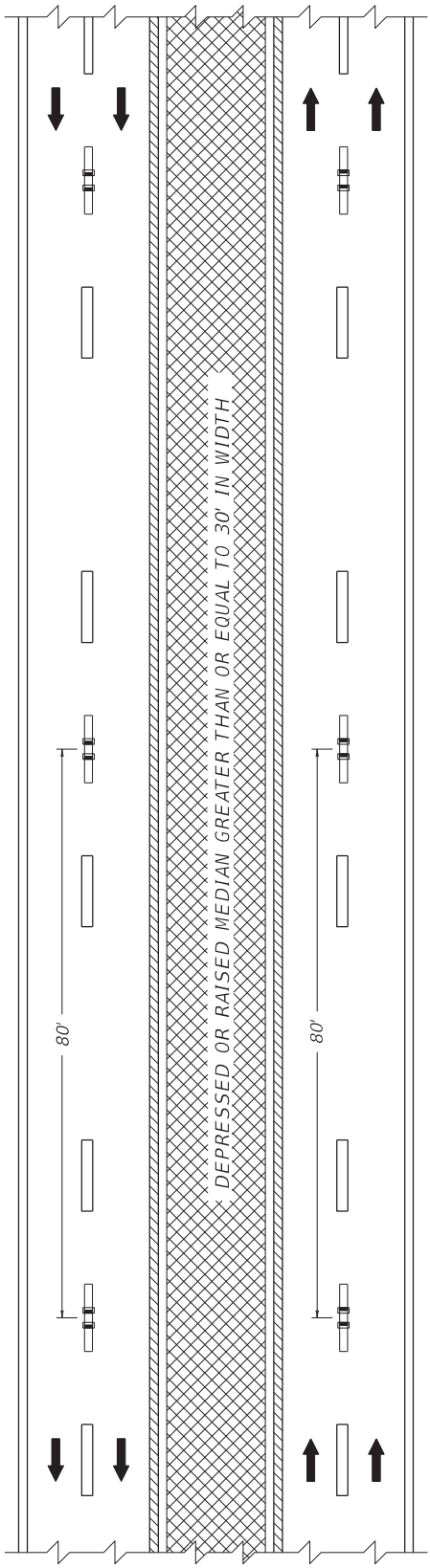

ARRANGEMENT "C" (DIVIDED HIGHWAY WITH DEPRESSED OR RAISED MEDIAN GREATER THAN OR EQUAL TO 30' IN WIDTH)

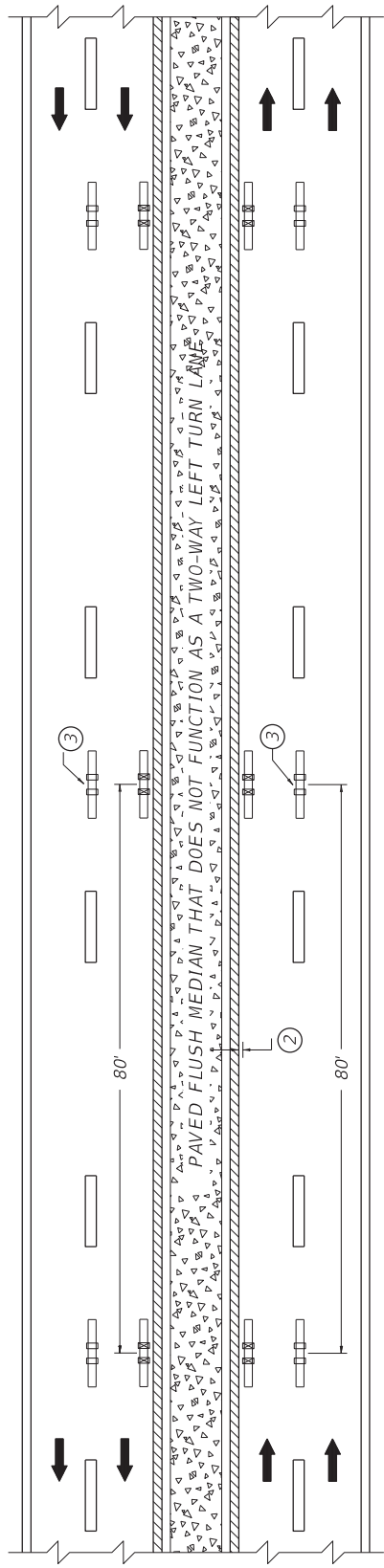

ARRANGEMENT "D" (DIVIDED HIGHWAY WITH PAVED FLUSH MEDIAN THAT DOES NOT FUNCTION AS A TWO-WAY LEFT TURN LANE)

- ~ NOTES ~
1. MARKERS INSTALLED ALONG LANE LINES SHOULD BE PLACED BETWEEN AND IN LINE WITH THE SKIPS.
 2. MARKERS INSTALLED ALONG EDGE LINES SHOULD BE PLACED SO THAT THE NEAR EDGE OF THE GROOVE IS NO MORE THAN 1" FROM THE NEAR EDGE OF THE LINE.
 3. IF WIDTH OF PAVED FLUSH MEDIAN IS GREATER THAN OR EQUAL TO 30', BI-DIRECTIONAL (WHITE-RED) MARKERS SHALL BE USED ALONG THE LANE LINES IN LIEU OF MONO-DIRECTIONAL (WHITE) MARKERS.
 4. MARKERS SHALL NOT BE INSTALLED ON TOP OF THE PAVEMENT JOINT. OFFSET MARKERS A MINIMUM OF 2" FROM THE PAVEMENT JOINT. ENSURE THAT THE FINISHED LINE OF MARKERS IS STRAIGHT WITH MINIMAL LATERAL DEVIATION. MARKERS MAY BE ELIMINATED OR PLACEMENT ADJUSTED AT THE DISCRETION OF THE ENGINEER.
 5. MARKERS SHALL BE INSTALLED AT 40' SPACING ALONG SOLID WHITE AUXILIARY LINES. MARKER COLOR SHALL MATCH THE MARKERS INSTALLED ALONG THE WHITE LANE LINES.
- BID ITEMS
 06610 - INLAID PAVEMENT MARKER - MW
 06612 - INLAID PAVEMENT MARKER - BY
 06613 - INLAID PAVEMENT MARKER - B W/R

LEGEND

	BI-DIRECTIONAL PAVEMENT MARKER (YELLOW)
	BI-DIRECTIONAL PAVEMENT MARKER (WHITE-RED)
	MONO-DIRECTIONAL PAVEMENT MARKER (WHITE)
	MARKINGS (YELLOW)
	MARKINGS (WHITE)
	FLUSH MEDIAN
	DEPRESSED OR RAISED MEDIAN

DRAWING NOT TO SCALE

KENTUCKY
DEPARTMENT OF HIGHWAYS
INLAID PAVEMENT MARKER
ARRANGEMENTS
MULTI-LANE ROADWAYS

SUBMITTED _____ 06-09-21
DIVISION DIRECTOR _____ DATE
Jim A.
007

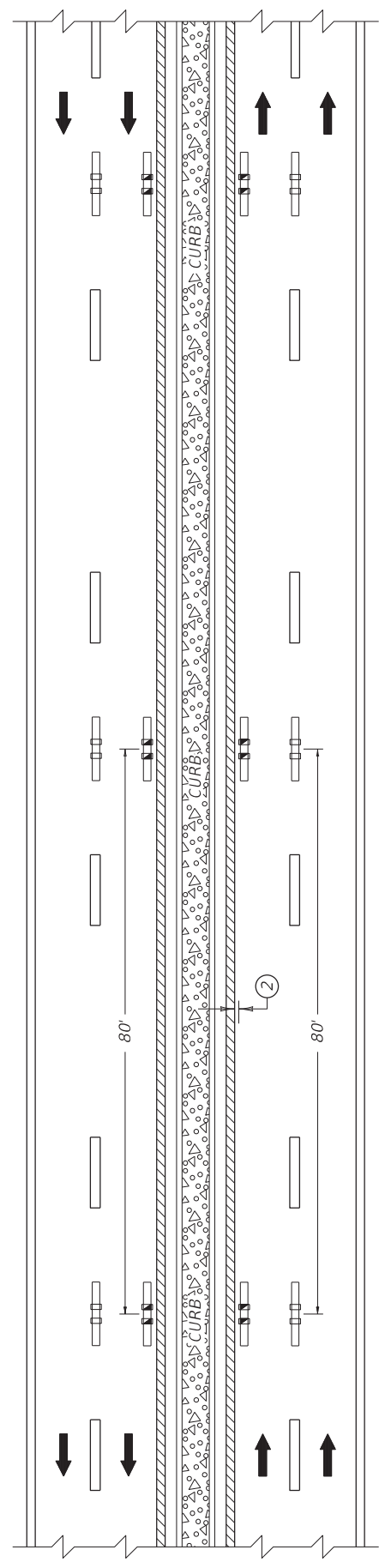

ARRANGEMENT "E" (DIVIDED HIGHWAY WITH CURB WITHIN 8' OF DRIVING LANE)

LEGEND

	MONO-DIRECTIONAL PAVEMENT MARKER (YELLOW)
	MONO-DIRECTIONAL PAVEMENT MARKER (WHITE)
	MARKINGS (YELLOW)
	MARKINGS (WHITE)

~ NOTES ~

1. MARKERS INSTALLED ALONG LANE LINES SHALL BE PLACED BETWEEN AND IN LINE WITH THE SKIPS.
 - ② MARKERS INSTALLED ALONG EDGE LINES SHALL BE PLACED SO THAT THE NEAR EDGE OF THE GROOVE IS NO MORE THAN 1" FROM THE NEAR EDGE OF THE LINE.
 3. MARKERS SHALL NOT BE INSTALLED ON TOP OF THE PAVEMENT JOINT. OFFSET MARKERS A MINIMUM OF 2" FROM THE PAVEMENT JOINT. ENSURE THAT THE FINISHED LINE OF MARKERS IS STRAIGHT WITH MINIMAL LATERAL DEVIATION. MARKERS MAY BE ELIMINATED OR PLACEMENT ADJUSTED AT THE DISCRETION OF THE ENGINEER.
 4. MARKERS SHALL BE INSTALLED AT 40' SPACING ALONG SOLID WHITE AUXILIARY LANES. MARKER COLOR SHALL MATCH THE MARKERS INSTALLED ALONG THE WHITE LANE LINES.
- BID ITEMS:
06610 - INLAID PAVEMENT MARKER - MW EACH
06611 - INLAID PAVEMENT MARKER - MY EACH

DRAWING NOT TO SCALE

KENTUCKY DEPARTMENT OF HIGHWAYS
INLAID PAVEMENT MARKER ARRANGEMENTS MULTI-LANE ROADWAYS
SUBMITTED _____ 06-09-21 DIVISION DIRECTOR _____ DATE 008

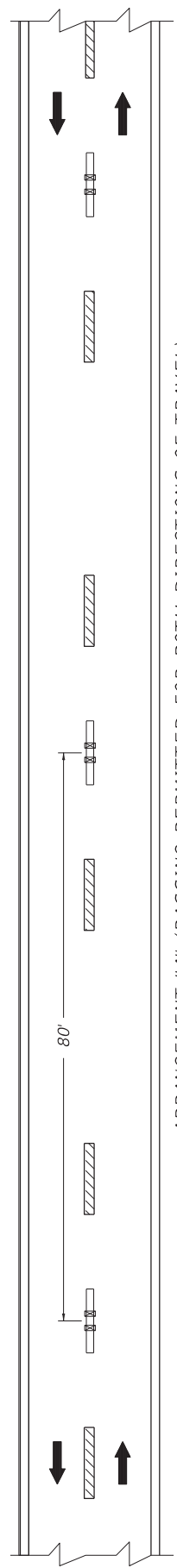

ARRANGEMENT "A" (PASSING PERMITTED FOR BOTH DIRECTIONS OF TRAVEL)

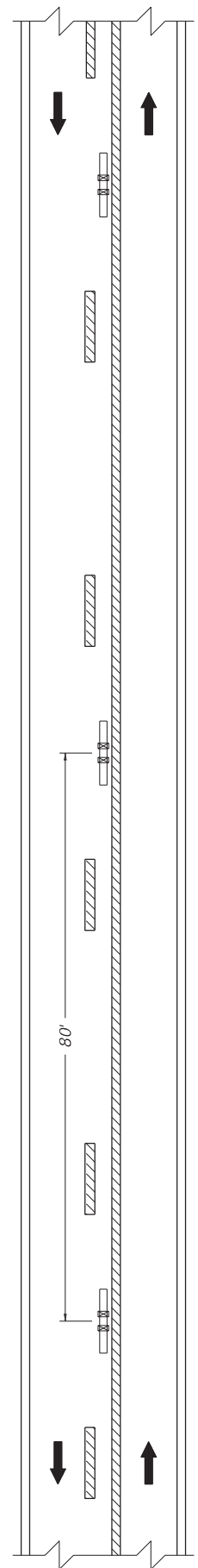

ARRANGEMENT "B" (PASSING PERMITTED FOR ONE DIRECTION OF TRAVEL)

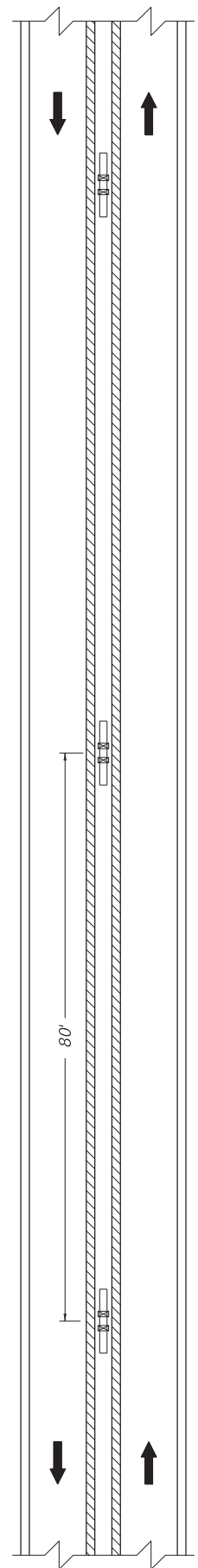

ARRANGEMENT "C" (PASSING PROHIBITED FOR BOTH DIRECTIONS OF TRAVEL)

~ NOTES ~

1. MARKERS INSTALLED ALONG DASHED YELLOW CENTERLINES SHALL BE PLACED BETWEEN AND IN LINE WITH THE DASHES.
2. MARKERS INSTALLED WITH DOUBLE YELLOW CENTERLINES SHALL BE PLACED BETWEEN THE TWO LINES.
3. MARKERS SHALL NOT BE INSTALLED ON TOP OF THE PAVEMENT JOINT. OFFSET MARKERS A MINIMUM OF 2' FROM THE PAVEMENT JOINT. ENSURE THAT THE FINISHED LINE OF MARKERS IS STRAIGHT WITH MINIMAL LATERAL DEVIATION. MARKERS MAY BE ELIMINATED OR PLACEMENT ADJUSTED AT THE DISCRETION OF THE ENGINEER.

UNIT TO BID
EACH

BID ITEMS
06612 - INLAID PAVEMENT MARKER - BY

LEGEND	
	BI-DIRECTIONAL PAVEMENT MARKER (YELLOW)
	MARKINGS (YELLOW)
	MARKINGS (WHITE)

KENTUCKY DEPARTMENT OF HIGHWAYS	INLAID PAVEMENT MARKER ARRANGEMENTS TWO-LANE, TWO-WAY ROADWAYS
	SUBMITTED _____ 06-09-21 DIVISION DIRECTOR _____

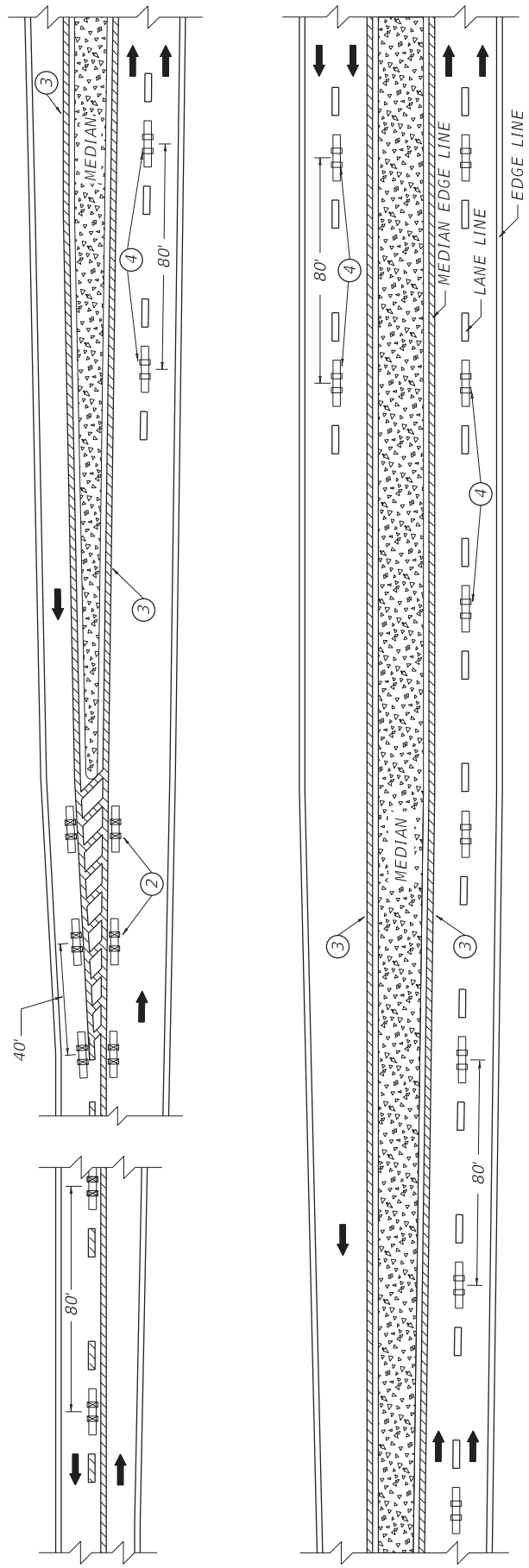

TWO LANE TO FOUR LANE PAVEMENT TRANSITIONS

LEGEND	
	BI-DIRECTIONAL PAVEMENT MARKER (YELLOW)
	MONO-DIRECTIONAL PAVEMENT MARKER (WHITE) ④
	MARKINGS (YELLOW)
	MARKINGS (WHITE)

~ NOTES ~

1. MARKERS INSTALLED ALONG LANE LINES OR DASHED YELLOW CENTERLINES SHALL BE PLACED BETWEEN AND IN LINE WITH THE DASHES.
- ② MARKERS INSTALLED ALONG EDGE LINES SHALL BE PLACED SO THAT THE NEAR EDGE OF THE GROOVE IS NO MORE THAN 1" FROM THE NEAR EDGE OF THE LINE.
- ③ MARKERS MAY BE REQUIRED ALONG THE MEDIAN EDGE LINES DEPENDING ON TYPE AND WIDTH OF MEDIAN. SEE TPM-100, TPM-105, AND TPM-110 FOR GUIDANCE.
- ④ IF MEDIAN WIDTH IS GREATER THAN OR EQUAL TO 30', BI-DIRECTIONAL (WHITE-RED) MARKERS SHALL BE USED ALONG THE LANE LINES IN LIEU OF MONO-DIRECTIONAL (WHITE) MARKERS.
5. MARKERS SHALL NOT BE INSTALLED ON TOP OF THE PAVEMENT JOINT. OFFSET MARKERS A MINIMUM OF 2" FROM THE PAVEMENT JOINT. ENSURE THAT THE FINISHED LINE OF MARKERS IS STRAIGHT WITH MINIMAL LATERAL DEVIATION. MARKERS MAY BE ELIMINATED AT THE DISCRETION OF THE ENGINEER.

UNIT TO BID
EACH
EACH

BID ITEMS
06610 - INLAID PAVEMENT MARKER - MW
06612 - INLAID PAVEMENT MARKER - BY

DRAWING NOT TO SCALE.
USE WITH CUR. STD. DWGS.
TPM-100 TPM-105 TPM-110

KENTUCKY	
DEPARTMENT OF HIGHWAYS	
INLAID PAVEMENT MARKER	
ARRANGEMENT	
TWO-LANE TO FOUR-LANE	
TRANSITIONS	

SUBMITTED _____ 06-09-21
DIVISION DIRECTOR _____
000

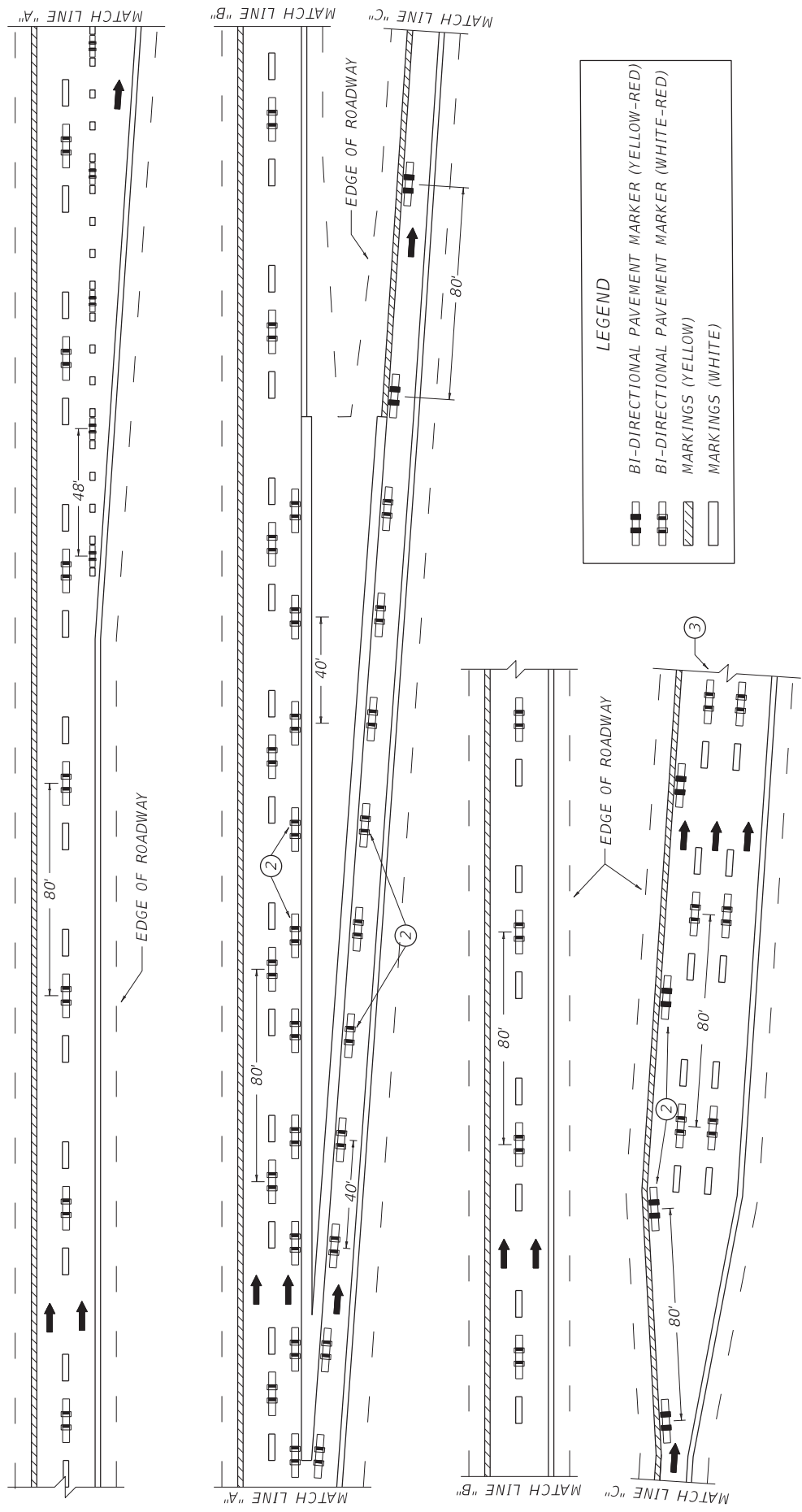

~ NOTES ~

1. MARKERS INSTALLED ALONG LANE LINES SHALL BE PLACED BETWEEN AND IN LINE WITH THE SKIPS.
2. MARKERS INSTALLED ALONG EDGE LINES SHALL BE PLACED SO THAT THE NEAR EDGE OF THE GROOVE IS NO MORE THAN 1" FROM THE NEAR EDGE OF THE LINE.
3. MARKERS SHALL BE CONTINUED ALONG THE ENTIRE LENGTH OF THE RAMP UNTIL THE INTERSECTION WITH THE CROSS-STREET.
4. MARKERS SHALL NOT BE INSTALLED ON TOP OF THE PAVEMENT JOINT. OFFSET MARKERS A MINIMUM OF 2" FROM THE PAVEMENT JOINT. ENSURE THAT THE FINISHED LINE OF MARKERS IS STRAIGHT WITH MINIMAL LATERAL DEVIATION. MARKERS MAY BE ELIMINATED OR PLACEMENT ADJUSTED AT THE DISCRETION OF THE ENGINEER.

DRAWING NOT TO SCALE
USE WITH CUR. STD. DWG.
TPM-201

KENTUCKY DEPARTMENT OF HIGHWAYS	
INLAID PAVEMENT MARKER ARRANGEMENT	EXIT GORE AND OFF-RAMP
SUBMITTED	06-09-21 DATE
011	

BID ITEMS
06613 - INLAID PAVEMENT MARKER - B-W/R
06614 - INLAID PAVEMENT MARKER - B-Y/R

UNIT TO BID
EACH
EACH

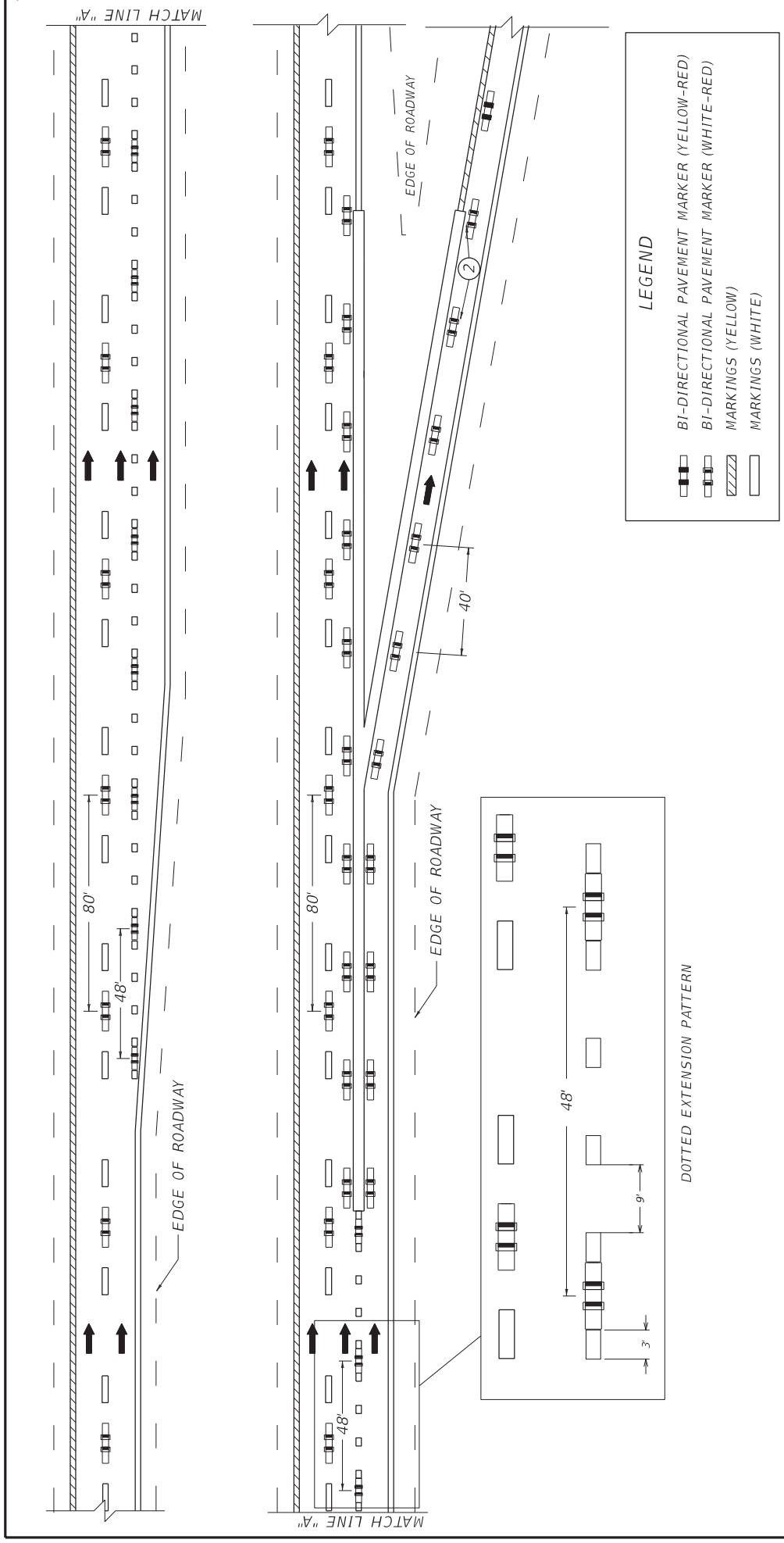

~ NOTES ~

1. MARKERS INSTALLED ALONG LANE LINES SHALL BE PLACED BETWEEN AND IN LINE WITH THE SKIPS.
2. MARKERS INSTALLED ALONG EDGE LINES SHALL BE PLACED SO THAT THE NEAR EDGE OF THE GROOVE IS NO MORE THAN 1" FROM THE NEAR EDGE OF THE LINE.
3. MARKERS SHALL BE CONTINUED ALONG THE ENTIRE LENGTH OF THE RAMP UNTIL THE INTERSECTION WITH THE CROSS-STREET.
4. ON TWO-LANE, TWO-WAY HIGHWAYS, MARKERS INSTALLED ALONG GORE MARKINGS SHALL BE MONO-DIRECTIONAL (WHITE).
5. MARKERS SHALL NOT BE INSTALLED ON TOP OF THE PAVEMENT JOINT. OFFSET MARKERS A MINIMUM OF 2" FROM THE PAVEMENT JOINT. ENSURE THAT THE FINISHED LINE OF MARKERS IS STRAIGHT WITH MINIMAL LATERAL DEVIATION. MARKERS MAY BE ELIMINATED AT THE DISCRETION OF THE ENGINEER.
6. MARKERS INSTALLED ALONG THE RAMP EDGELINE SHALL BE SPACED AT 80' INTERVALS.
 BID ITEMS:
 06613 - INLAID PAVEMENT MARKER - B-W/R
 06614 - INLAID PAVEMENT MARKER - B-Y/R

DRAWING NOT TO SCALE.

KENTUCKY DEPARTMENT OF HIGHWAYS
INLAID PAVEMENT MARKER ARRANGEMENT FOR PARALLEL DECELERATION LANE

SUBMITTED <i>[Signature]</i> DIVISION DIRECTOR	06-09-21 DATE
012	

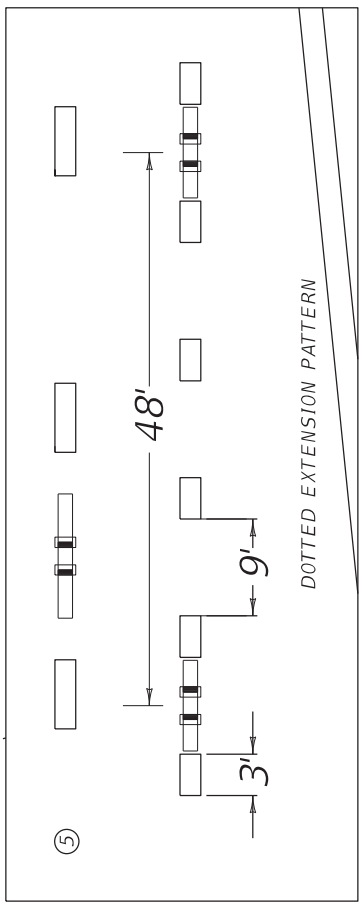
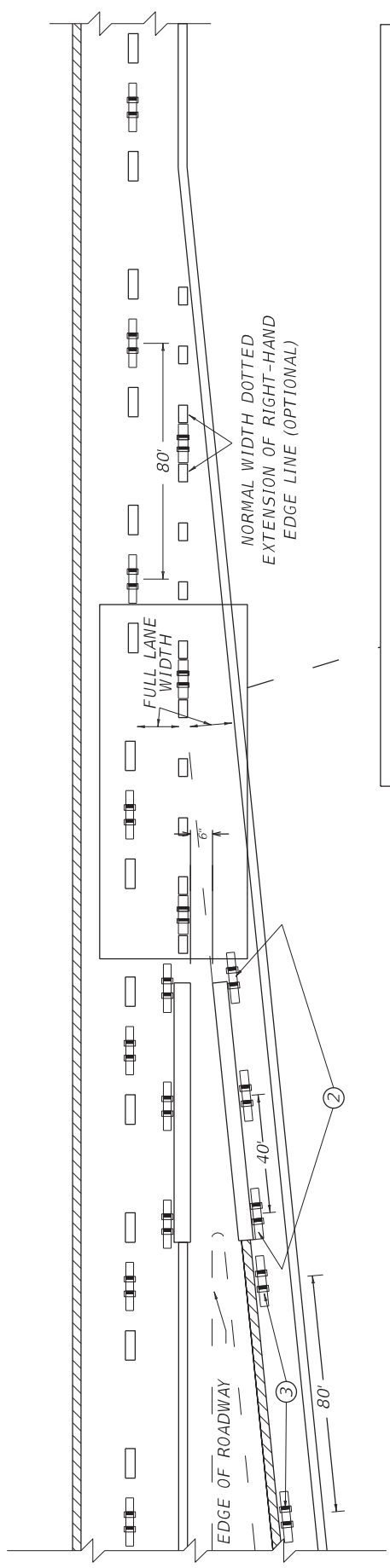

LEGEND

	BI-DIRECTIONAL PAVEMENT MARKER (YELLOW-RED)
	BI-DIRECTIONAL PAVEMENT MARKER (WHITE-RED)
	MARKINGS (YELLOW)
	MARKINGS (WHITE)

~ NOTES ~

1. MARKERS INSTALLED ALONG LANE LINES SHALL BE PLACED BETWEEN AND IN LINE WITH THE SKIPS.
2. MARKERS INSTALLED ALONG EDGE LINES SHALL BE PLACED SO THAT THE NEAR EDGE OF THE GROOVE IS NO MORE THAN 1" FROM THE NEAR EDGE OF THE LINE.
3. BI-DIRECTIONAL (YELLOW-RED) MARKERS ARE TO BE PLACED ALONG THE ENTIRE LENGTH OF THE YELLOW EDGE LINE FROM THE INTERSECTION OF THE CROSS-STREET TO THE BEGINNING OF THE GORE AREA.
4. ON TWO-LANE, TWO-WAY HIGHWAYS, MARKERS INSTALLED ALONG GORE MARKINGS SHALL BE MONO-DIRECTIONAL (WHITE).
5. IF DOTTED EXTENSIONS ARE USED IN THE TAPERED ACCELERATION LANE, MARKERS SHALL BE INSTALLED AS DEPICTED. MARKERS SHALL NOT BE INSTALLED ON TOP OF THE PAVEMENT JOINT. OFFSET MARKERS A MINIMUM OF 2" FROM THE PAVEMENT JOINT. ENSURE THAT THE FINISHED LINE OF MARKERS IS STRAIGHT WITH MINIMAL LATERAL DEVIATION. MARKERS MAY BE ELIMINATED OR PLACEMENT ADJUSTED AT THE DISCRETION OF THE ENGINEER.

DRAWING NOT TO SCALE
USE WITH CUR. STD. DWG.
TPM-200

KENTUCKY
DEPARTMENT OF HIGHWAYS
INLAID PAVEMENT MARKER
ARRANGEMENT
ON-RAMP WITH TAPERED
ACCELERATION LANE

SUBMITTED _____ 06-09-21
DIVISION DIRECTOR _____
013

BID ITEMS
06613 - INLAID PAVEMENT MARKER - B-W/R
06614 - INLAID PAVEMENT MARKER - B-Y/R
UNIT TO BID
EACH
EACH

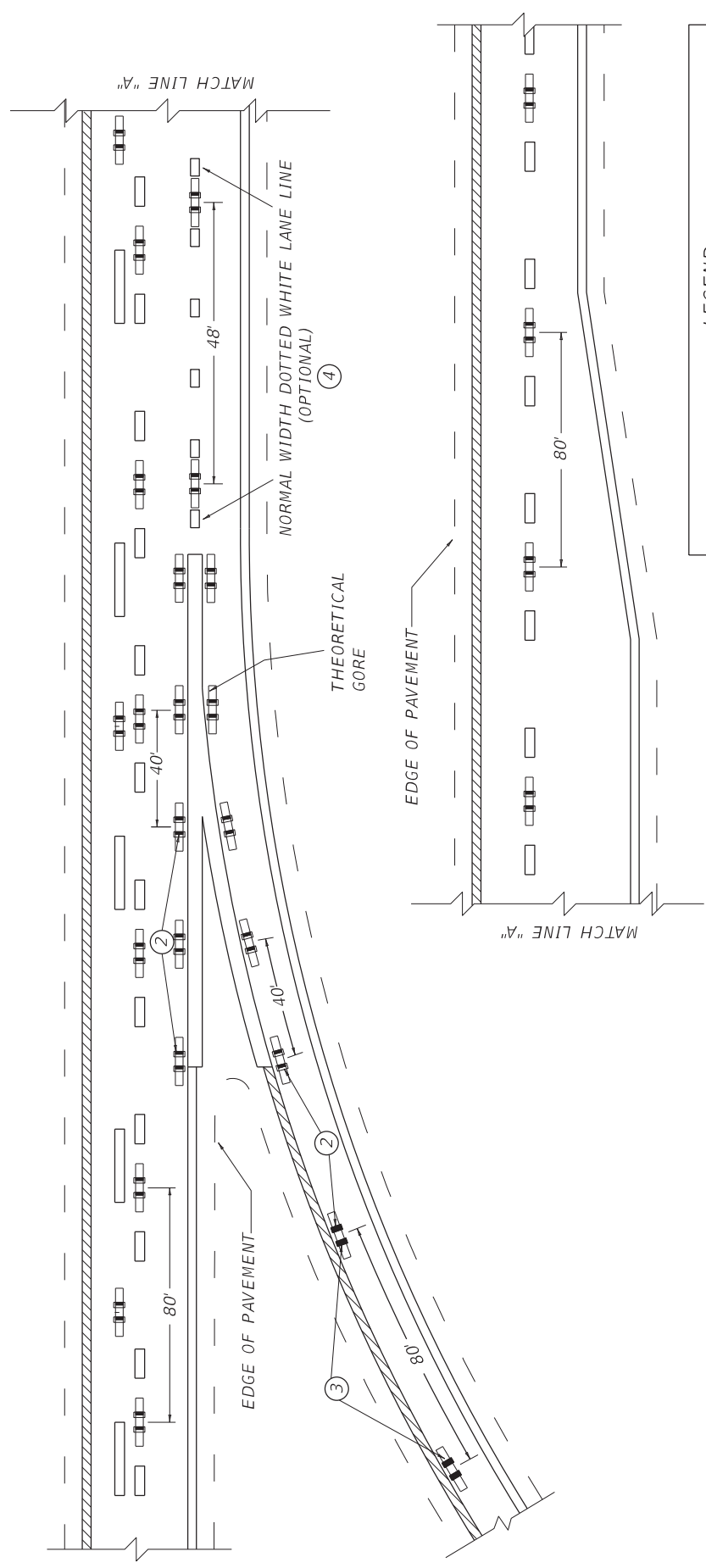

LEGEND

	BI-DIRECTIONAL PAVEMENT MARKER (YELLOW-RED)
	BI-DIRECTIONAL PAVEMENT MARKER (WHITE-RED)
	MARKINGS (YELLOW)
	MARKINGS (WHITE)

~ NOTES ~

1. MARKERS INSTALLED ALONG LANE LINES SHALL BE PLACED BETWEEN AND IN LINE WITH THE SKIPS.
2. MARKERS INSTALLED ALONG EDGE LINES SHALL BE PLACED SO THAT THE NEAR EDGE OF THE GROOVE IS NO MORE THAN 1" FROM THE NEAR EDGE OF THE LINE.
3. BI-DIRECTIONAL (YELLOW-RED) MARKERS ARE TO BE PLACED ALONG THE ENTIRE LENGTH OF THE YELLOW EDGE LINE FROM THE INTERSECTION OF THE CROSS-STREET TO THE BEGINNING OF THE GORE AREA.
4. IF DOTTED EXTENSIONS ARE USED IN THE TAPERED ACCELERATION LANE, MARKERS SHALL BE INSTALLED AS DEPICTED. MARKERS SHALL NOT BE INSTALLED ON TOP OF THE PAVEMENT JOINT. OFFSET MARKERS A MINIMUM OF 2" FROM THE PAVEMENT JOINT. ENSURE THAT THE FINISHED LINE OF MARKERS IS STRAIGHT WITH MINIMAL LATERAL DEVIATION. MARKERS MAY BE ELIMINATED OR PLACEMENT ADJUSTED AT THE DISCRETION OF THE ENGINEER.
6. THE NORMAL WIDTH DOTTED WHITE LANE LINE SHALL EXTEND FOR AT LEAST HALF THE LENGTH OF THE FULL-WIDTH ACCELERATION LANE PLUS TAPER MEASURED FROM THE THEORETICAL GORE.

BID ITEMS AND UNIT TO BID
INLAID PAVEMENT MARKER (B-W/R, B-Y/R, BY, MW, MY) EACH

DRAWING NOT TO SCALE
USE WITH CUR. STD. DWG.
TPM-200

KENTUCKY DEPARTMENT OF HIGHWAYS	INLAID PAVEMENT MARKER ARRANGEMENT ON-RAMP WITH PARALLEL ACCELERATION LANE
SUBMITTED _____ DIVISION DIRECTOR	06-09-21 DATE 011

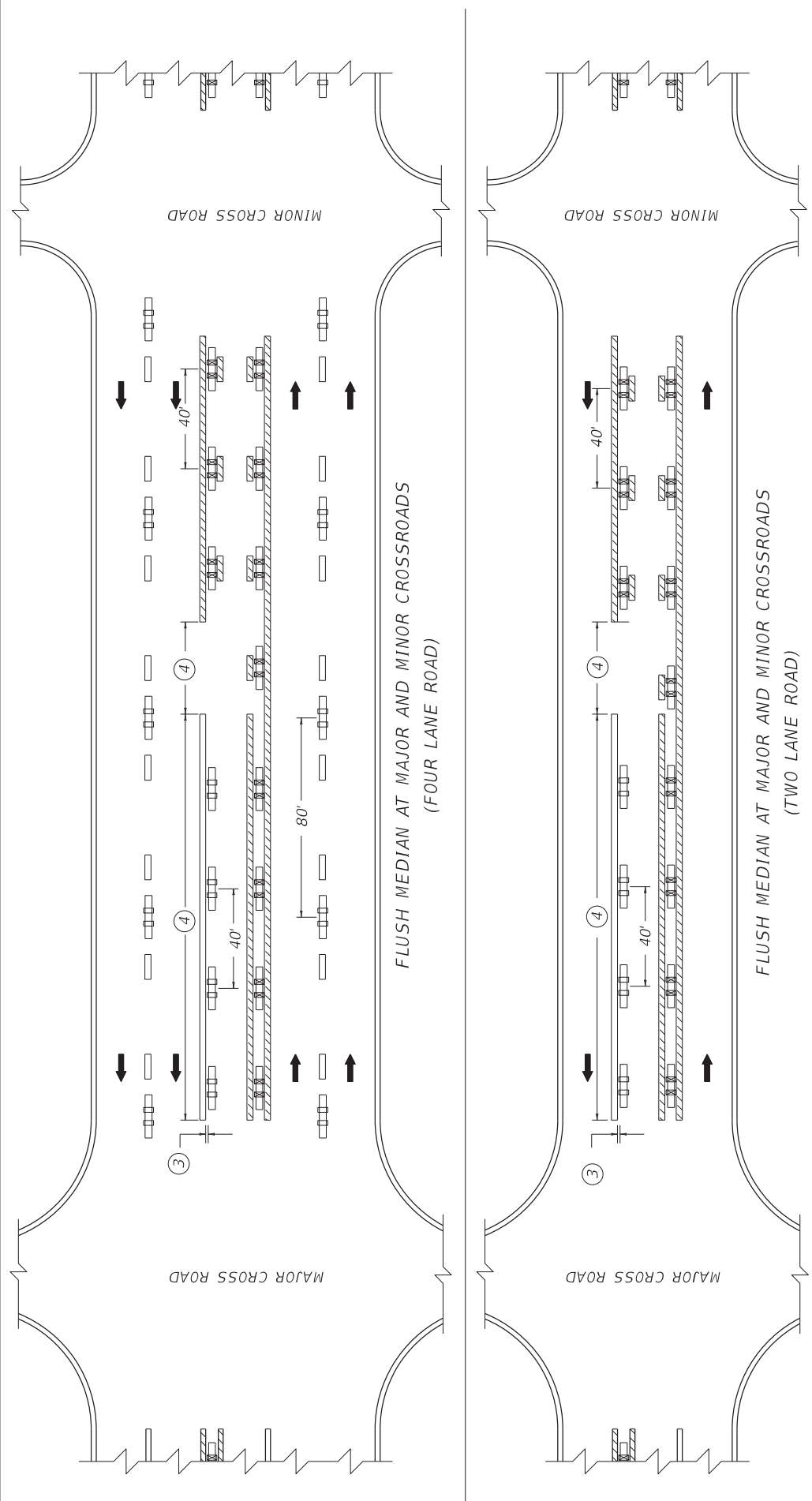

DRAWING NOT TO SCALE
USE WITH CUR. STD. DWG.
TPM-207

KENTUCKY
DEPARTMENT OF HIGHWAYS
INLAID PAVEMENT MARKER
ARRANGEMENTS
TWO-WAY, LEFT-TURN LANE

SUBMITTED: *John A. [Signature]*
DIVISION DIRECTOR

06-09-21
DATE

015

LEGEND

	BI-DIRECTIONAL PAVEMENT MARKER (YELLOW)
	MONO-DIRECTIONAL PAVEMENT MARKER (WHITE)
	MARKINGS (YELLOW)
	MARKINGS (WHITE)

- ~ NOTES ~
1. MARKERS INSTALLED AT DOUBLE YELLOW CENTERLINES SHALL BE PLACED BETWEEN THE TWO LINES.
 2. MARKERS INSTALLED ALONG LANE LINES OR DASHED YELLOW CENTERLINES SHALL BE PLACED BETWEEN AND IN LINE WITH THE SKIPS.
 3. MARKERS INSTALLED ALONG EDGE LINES SHALL BE PLACED SO THAT THE NEAR EDGE OF THE GROOVE IS NO MORE THAN 1" FROM THE NEAR EDGE OF THE LINE.
 4. LENGTH TO BE DETERMINED ON A PROJECT BY PROJECT BASIS.
 5. MARKERS SHALL NOT BE INSTALLED ON TOP OF THE PAVEMENT JOINT. OFFSET MARKERS A MINIMUM OF 2" FROM THE PAVEMENT JOINT. ENSURE THAT THE FINISHED LINE OF MARKERS IS STRAIGHT WITH MINIMAL LATERAL DEVIATION. MARKERS MAY BE ELIMINATED OR PLACEMENT ADJUSTED AT THE DISCRETION OF THE ENGINEER.
- BID ITEMS
06610 - INLAID PAVEMENT MARKER - MW
06612 - INLAID PAVEMENT MARKER - BY
- UNIT TO BID
EACH
EACH

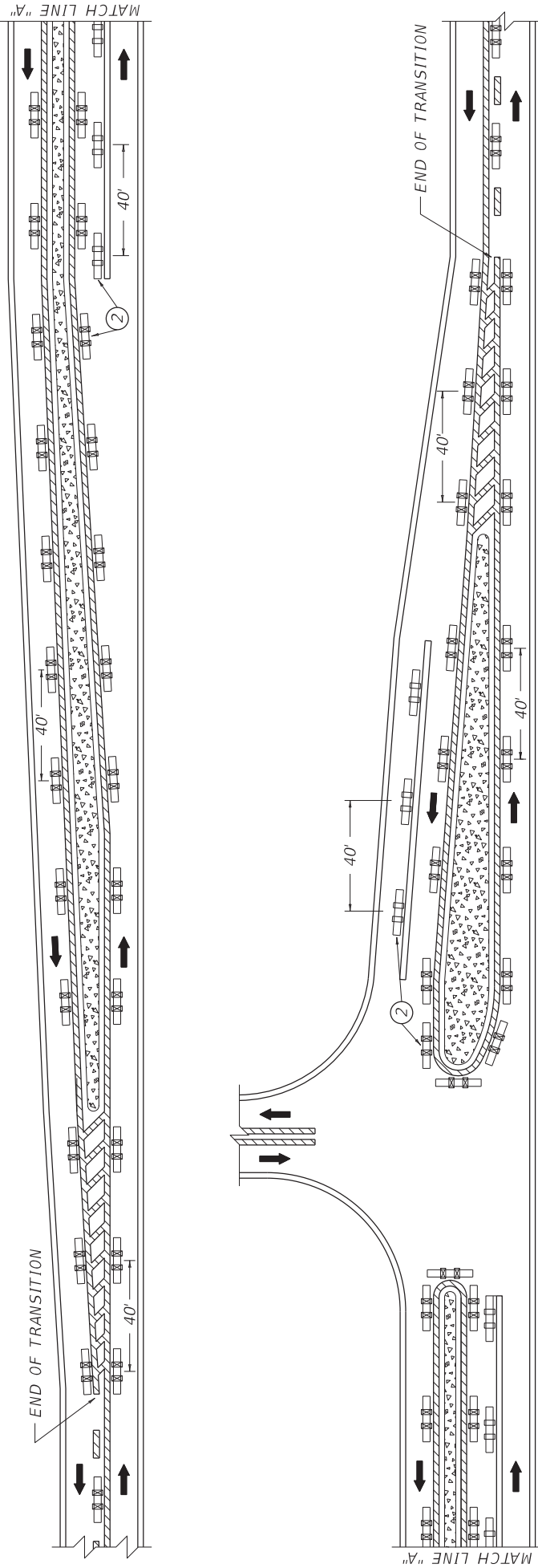

CHANNELIZED INTERSECTION ON A TWO DIRECTIONAL TWO LANE FACILITY

LEGEND

	BI-DIRECTIONAL PAVEMENT MARKER (YELLOW)
	MONO-DIRECTIONAL PAVEMENT MARKER (WHITE)
	CURBED OR FLUSH MEDIAN
	MARKINGS (YELLOW)
	MARKINGS (WHITE)

DRAWING NOT TO SCALE
USE WITH CUR. STD. DWG.
TPM-205

~ NOTES ~

- MARKERS INSTALLED ALONG DASHED CENTERLINES SHALL BE PLACED BETWEEN AND IN LINE WITH THE SKIPS.
- MARKERS INSTALLED ALONG EDGE LINES OR CHANNELIZING LINES SHALL BE PLACED SO THAT THE NEAR EDGE OF THE GROOVE IS NO MORE THAN 1" FROM THE NEAR EDGE OF THE LINE.
- MARKERS SHALL NOT BE INSTALLED ON TOP OF THE PAVEMENT JOINT. OFFSET MARKERS A MINIMUM OF 2" FROM THE PAVEMENT JOINT. ENSURE THAT THE FINISHED LINE OF MARKERS IS STRAIGHT WITH MINIMAL LATERAL DEVIATION. MARKERS MAY BE ELIMINATED OR PLACEMENT ADJUSTED AT THE DISCRETION OF THE ENGINEER.

BID ITEMS
06610 - INLAID PAVEMENT MARKER - MW
06612 - INLAID PAVEMENT MARKER - BY
UNIT TO BID
EACH
EACH

KENTUCKY
DEPARTMENT OF HIGHWAYS
INLAID PAVEMENT MARKER
ARRANGEMENT
CHANNELIZED
INTERSECTION

SUBMITTED DIVISION DIRECTOR
06-09-21
016

PART III

EMPLOYMENT, WAGE AND RECORD REQUIREMENTS

FHWA-1273 -- Revised May 1, 2012

**REQUIRED CONTRACT PROVISIONS
FEDERAL-AID CONSTRUCTION CONTRACTS**

- I. General
- II. Nondiscrimination
- III. Nonsegregated Facilities
- IV. Davis-Bacon and Related Act Provisions
- V. Contract Work Hours and Safety Standards Act Provisions
- VI. Subletting or Assigning the Contract
- VII. Safety: Accident Prevention
- VIII. False Statements Concerning Highway Projects
- IX. Implementation of Clean Air Act and Federal Water Pollution Control Act
- X. Compliance with Governmentwide Suspension and Debarment Requirements
- XI. Certification Regarding Use of Contract Funds for Lobbying

3. A breach of any of the stipulations contained in these Required Contract Provisions may be sufficient grounds for withholding of progress payments, withholding of final payment, termination of the contract, suspension / debarment or any other action determined to be appropriate by the contracting agency and FHWA.

4. Selection of Labor: During the performance of this contract, the contractor shall not use convict labor for any purpose within the limits of a construction project on a Federal-aid highway unless it is labor performed by convicts who are on parole, supervised release, or probation. The term Federal-aid highway does not include roadways functionally classified as local roads or rural minor collectors.

ATTACHMENTS

A. Employment and Materials Preference for Appalachian Development Highway System or Appalachian Local Access Road Contracts (included in Appalachian contracts only)

II. NONDISCRIMINATION

The provisions of this section related to 23 CFR Part 230 are applicable to all Federal-aid construction contracts and to all related construction subcontracts of \$10,000 or more. The provisions of 23 CFR Part 230 are not applicable to material supply, engineering, or architectural service contracts.

I. GENERAL

1. Form FHWA-1273 must be physically incorporated in each construction contract funded under Title 23 (excluding emergency contracts solely intended for debris removal). The contractor (or subcontractor) must insert this form in each subcontract and further require its inclusion in all lower tier subcontracts (excluding purchase orders, rental agreements and other agreements for supplies or services).

In addition, the contractor and all subcontractors must comply with the following policies: Executive Order 11246, 41 CFR 60, 29 CFR 1625-1627, Title 23 USC Section 140, the Rehabilitation Act of 1973, as amended (29 USC 794), Title VI of the Civil Rights Act of 1964, as amended, and related regulations including 49 CFR Parts 21, 26 and 27; and 23 CFR Parts 200, 230, and 633.

The applicable requirements of Form FHWA-1273 are incorporated by reference for work done under any purchase order, rental agreement or agreement for other services. The prime contractor shall be responsible for compliance by any subcontractor, lower-tier subcontractor or service provider.

The contractor and all subcontractors must comply with: the requirements of the Equal Opportunity Clause in 41 CFR 60-1.4(b) and, for all construction contracts exceeding \$10,000, the Standard Federal Equal Employment Opportunity Construction Contract Specifications in 41 CFR 60-4.3.

Form FHWA-1273 must be included in all Federal-aid design-build contracts, in all subcontracts and in lower tier subcontracts (excluding subcontracts for design services, purchase orders, rental agreements and other agreements for supplies or services). The design-builder shall be responsible for compliance by any subcontractor, lower-tier subcontractor or service provider.

Note: The U.S. Department of Labor has exclusive authority to determine compliance with Executive Order 11246 and the policies of the Secretary of Labor including 41 CFR 60, and 29 CFR 1625-1627. The contracting agency and the FHWA have the authority and the responsibility to ensure compliance with Title 23 USC Section 140, the Rehabilitation Act of 1973, as amended (29 USC 794), and Title VI of the Civil Rights Act of 1964, as amended, and related regulations including 49 CFR Parts 21, 26 and 27; and 23 CFR Parts 200, 230, and 633.

Contracting agencies may reference Form FHWA-1273 in bid proposal or request for proposal documents, however, the Form FHWA-1273 must be physically incorporated (not referenced) in all contracts, subcontracts and lower-tier subcontracts (excluding purchase orders, rental agreements and other agreements for supplies or services related to a construction contract).

The following provision is adopted from 23 CFR 230, Appendix A, with appropriate revisions to conform to the U.S. Department of Labor (US DOL) and FHWA requirements.

2. Subject to the applicability criteria noted in the following sections, these contract provisions shall apply to all work performed on the contract by the contractor's own organization and with the assistance of workers under the contractor's immediate superintendence and to all work performed on the contract by piecework, station work, or by subcontract.

1. Equal Employment Opportunity: Equal employment opportunity (EEO) requirements not to discriminate and to take affirmative action to assure equal opportunity as set forth under laws, executive orders, rules, regulations (28 CFR 35, 29 CFR 1630, 29 CFR 1625-1627, 41 CFR 60 and 49 CFR 27) and orders of the Secretary of Labor as modified by the provisions prescribed herein, and imposed pursuant to 23 U.S.C. 140 shall constitute the EEO and specific affirmative action standards for the contractor's project activities under

this contract. The provisions of the Americans with Disabilities Act of 1990 (42 U.S.C. 12101 et seq.) set forth under 28 CFR 35 and 29 CFR 1630 are incorporated by reference in this contract. In the execution of this contract, the contractor agrees to comply with the following minimum specific requirement activities of EEO:

a. The contractor will work with the contracting agency and the Federal Government to ensure that it has made every good faith effort to provide equal opportunity with respect to all of its terms and conditions of employment and in their review of activities under the contract.

b. The contractor will accept as its operating policy the following statement:

"It is the policy of this Company to assure that applicants are employed, and that employees are treated during employment, without regard to their race, religion, sex, color, national origin, age or disability. Such action shall include: employment, upgrading, demotion, or transfer; recruitment or recruitment advertising; layoff or termination; rates of pay or other forms of compensation; and selection for training, including apprenticeship, pre-apprenticeship, and/or on-the-job training."

2. EEO Officer: The contractor will designate and make known to the contracting officers an EEO Officer who will have the responsibility for and must be capable of effectively administering and promoting an active EEO program and who must be assigned adequate authority and responsibility to do so.

3. Dissemination of Policy: All members of the contractor's staff who are authorized to hire, supervise, promote, and discharge employees, or who recommend such action, or who are substantially involved in such action, will be made fully cognizant of, and will implement, the contractor's EEO policy and contractual responsibilities to provide EEO in each grade and classification of employment. To ensure that the above agreement will be met, the following actions will be taken as a minimum:

a. Periodic meetings of supervisory and personnel office employees will be conducted before the start of work and then not less often than once every six months, at which time the contractor's EEO policy and its implementation will be reviewed and explained. The meetings will be conducted by the EEO Officer.

b. All new supervisory or personnel office employees will be given a thorough indoctrination by the EEO Officer, covering all major aspects of the contractor's EEO obligations within thirty days following their reporting for duty with the contractor.

c. All personnel who are engaged in direct recruitment for the project will be instructed by the EEO Officer in the contractor's procedures for locating and hiring minorities and women.

d. Notices and posters setting forth the contractor's EEO policy will be placed in areas readily accessible to employees, applicants for employment and potential employees.

e. The contractor's EEO policy and the procedures to implement such policy will be brought to the attention of employees by means of meetings, employee handbooks, or other appropriate means.

4. Recruitment: When advertising for employees, the contractor will include in all advertisements for employees the notation: "An Equal Opportunity Employer." All such advertisements will be placed in publications having a large circulation among minorities and women in the area from which the project work force would normally be derived.

a. The contractor will, unless precluded by a valid bargaining agreement, conduct systematic and direct recruitment through public and private employee referral sources likely to yield qualified minorities and women. To meet this requirement, the contractor will identify sources of potential minority group employees, and establish with such identified sources procedures whereby minority and women applicants may be referred to the contractor for employment consideration.

b. In the event the contractor has a valid bargaining agreement providing for exclusive hiring hall referrals, the contractor is expected to observe the provisions of that agreement to the extent that the system meets the contractor's compliance with EEO contract provisions. Where implementation of such an agreement has the effect of discriminating against minorities or women, or obligates the contractor to do the same, such implementation violates Federal nondiscrimination provisions.

c. The contractor will encourage its present employees to refer minorities and women as applicants for employment. Information and procedures with regard to referring such applicants will be discussed with employees.

5. Personnel Actions: Wages, working conditions, and employee benefits shall be established and administered, and personnel actions of every type, including hiring, upgrading, promotion, transfer, demotion, layoff, and termination, shall be taken without regard to race, color, religion, sex, national origin, age or disability. The following procedures shall be followed:

a. The contractor will conduct periodic inspections of project sites to insure that working conditions and employee facilities do not indicate discriminatory treatment of project site personnel.

b. The contractor will periodically evaluate the spread of wages paid within each classification to determine any evidence of discriminatory wage practices.

c. The contractor will periodically review selected personnel actions in depth to determine whether there is evidence of discrimination. Where evidence is found, the contractor will promptly take corrective action. If the review indicates that the discrimination may extend beyond the actions reviewed, such corrective action shall include all affected persons.

d. The contractor will promptly investigate all complaints of alleged discrimination made to the contractor in connection with its obligations under this contract, will attempt to resolve such complaints, and will take appropriate corrective action within a reasonable time. If the investigation indicates that the discrimination may affect persons other than the complainant, such corrective action shall include such other persons. Upon completion of each investigation, the contractor will inform every complainant of all of their avenues of appeal.

6. Training and Promotion:

a. The contractor will assist in locating, qualifying, and increasing the skills of minorities and women who are

applicants for employment or current employees. Such efforts should be aimed at developing full journey level status employees in the type of trade or job classification involved.

b. Consistent with the contractor's work force requirements and as permissible under Federal and State regulations, the contractor shall make full use of training programs, i.e., apprenticeship, and on-the-job training programs for the geographical area of contract performance. In the event a special provision for training is provided under this contract, this subparagraph will be superseded as indicated in the special provision. The contracting agency may reserve training positions for persons who receive welfare assistance in accordance with 23 U.S.C. 140(a).

c. The contractor will advise employees and applicants for employment of available training programs and entrance requirements for each.

d. The contractor will periodically review the training and promotion potential of employees who are minorities and women and will encourage eligible employees to apply for such training and promotion.

7. Unions: If the contractor relies in whole or in part upon unions as a source of employees, the contractor will use good faith efforts to obtain the cooperation of such unions to increase opportunities for minorities and women. Actions by the contractor, either directly or through a contractor's association acting as agent, will include the procedures set forth below:

a. The contractor will use good faith efforts to develop, in cooperation with the unions, joint training programs aimed toward qualifying more minorities and women for membership in the unions and increasing the skills of minorities and women so that they may qualify for higher paying employment.

b. The contractor will use good faith efforts to incorporate an EEO clause into each union agreement to the end that such union will be contractually bound to refer applicants without regard to their race, color, religion, sex, national origin, age or disability.

c. The contractor is to obtain information as to the referral practices and policies of the labor union except that to the extent such information is within the exclusive possession of the labor union and such labor union refuses to furnish such information to the contractor, the contractor shall so certify to the contracting agency and shall set forth what efforts have been made to obtain such information.

d. In the event the union is unable to provide the contractor with a reasonable flow of referrals within the time limit set forth in the collective bargaining agreement, the contractor will, through independent recruitment efforts, fill the employment vacancies without regard to race, color, religion, sex, national origin, age or disability; making full efforts to obtain qualified and/or qualifiable minorities and women. The failure of a union to provide sufficient referrals (even though it is obligated to provide exclusive referrals under the terms of a collective bargaining agreement) does not relieve the contractor from the requirements of this paragraph. In the event the union referral practice prevents the contractor from meeting the obligations pursuant to Executive Order 11246, as amended, and these special provisions, such contractor shall immediately notify the contracting agency.

8. Reasonable Accommodation for Applicants / Employees with Disabilities: The contractor must be familiar

with the requirements for and comply with the Americans with Disabilities Act and all rules and regulations established there under. Employers must provide reasonable accommodation in all employment activities unless to do so would cause an undue hardship.

9. Selection of Subcontractors, Procurement of Materials and Leasing of Equipment: The contractor shall not discriminate on the grounds of race, color, religion, sex, national origin, age or disability in the selection and retention of subcontractors, including procurement of materials and leases of equipment. The contractor shall take all necessary and reasonable steps to ensure nondiscrimination in the administration of this contract.

a. The contractor shall notify all potential subcontractors and suppliers and lessors of their EEO obligations under this contract.

b. The contractor will use good faith efforts to ensure subcontractor compliance with their EEO obligations.

10. Assurance Required by 49 CFR 26.13(b):

a. The requirements of 49 CFR Part 26 and the State DOT's U.S. DOT-approved DBE program are incorporated by reference.

b. The contractor or subcontractor shall not discriminate on the basis of race, color, national origin, or sex in the performance of this contract. The contractor shall carry out applicable requirements of 49 CFR Part 26 in the award and administration of DOT-assisted contracts. Failure by the contractor to carry out these requirements is a material breach of this contract, which may result in the termination of this contract or such other remedy as the contracting agency deems appropriate.

11. Records and Reports: The contractor shall keep such records as necessary to document compliance with the EEO requirements. Such records shall be retained for a period of three years following the date of the final payment to the contractor for all contract work and shall be available at reasonable times and places for inspection by authorized representatives of the contracting agency and the FHWA.

a. The records kept by the contractor shall document the following:

(1) The number and work hours of minority and non-minority group members and women employed in each work classification on the project;

(2) The progress and efforts being made in cooperation with unions, when applicable, to increase employment opportunities for minorities and women; and

(3) The progress and efforts being made in locating, hiring, training, qualifying, and upgrading minorities and women;

b. The contractors and subcontractors will submit an annual report to the contracting agency each July for the duration of the project, indicating the number of minority, women, and non-minority group employees currently engaged in each work classification required by the contract work. This information is to be reported on [Form FHWA-1391](#). The staffing data should represent the project work force on board in all or any part of the last payroll period preceding the end of July. If on-the-job training is being required by special provision, the contractor

will be required to collect and report training data. The employment data should reflect the work force on board during all or any part of the last payroll period preceding the end of July.

III. NONSEGREGATED FACILITIES

This provision is applicable to all Federal-aid construction contracts and to all related construction subcontracts of \$10,000 or more.

The contractor must ensure that facilities provided for employees are provided in such a manner that segregation on the basis of race, color, religion, sex, or national origin cannot result. The contractor may neither require such segregated use by written or oral policies nor tolerate such use by employee custom. The contractor's obligation extends further to ensure that its employees are not assigned to perform their services at any location, under the contractor's control, where the facilities are segregated. The term "facilities" includes waiting rooms, work areas, restaurants and other eating areas, time clocks, restrooms, washrooms, locker rooms, and other storage or dressing areas, parking lots, drinking fountains, recreation or entertainment areas, transportation, and housing provided for employees. The contractor shall provide separate or single-user restrooms and necessary dressing or sleeping areas to assure privacy between sexes.

IV. DAVIS-BACON AND RELATED ACT PROVISIONS

This section is applicable to all Federal-aid construction projects exceeding \$2,000 and to all related subcontracts and lower-tier subcontracts (regardless of subcontract size). The requirements apply to all projects located within the right-of-way of a roadway that is functionally classified as Federal-aid highway. This excludes roadways functionally classified as local roads or rural minor collectors, which are exempt. Contracting agencies may elect to apply these requirements to other projects.

The following provisions are from the U.S. Department of Labor regulations in 29 CFR 5.5 "Contract provisions and related matters" with minor revisions to conform to the FHWA-1273 format and FHWA program requirements.

1. Minimum wages

a. All laborers and mechanics employed or working upon the site of the work, will be paid unconditionally and not less often than once a week, and without subsequent deduction or rebate on any account (except such payroll deductions as are permitted by regulations issued by the Secretary of Labor under the Copeland Act (29 CFR part 3)), the full amount of wages and bona fide fringe benefits (or cash equivalents thereof) due at time of payment computed at rates not less than those contained in the wage determination of the Secretary of Labor which is attached hereto and made a part hereof, regardless of any contractual relationship which may be alleged to exist between the contractor and such laborers and mechanics.

Contributions made or costs reasonably anticipated for bona fide fringe benefits under section 1(b)(2) of the Davis-Bacon Act on behalf of laborers or mechanics are considered wages paid to such laborers or mechanics, subject to the provisions

of paragraph 1.d. of this section; also, regular contributions made or costs incurred for more than a weekly period (but not less often than quarterly) under plans, funds, or programs which cover the particular weekly period, are deemed to be constructively made or incurred during such weekly period. Such laborers and mechanics shall be paid the appropriate wage rate and fringe benefits on the wage determination for the classification of work actually performed, without regard to skill, except as provided in 29 CFR 5.5(a)(4). Laborers or mechanics performing work in more than one classification may be compensated at the rate specified for each classification for the time actually worked therein: Provided, That the employer's payroll records accurately set forth the time spent in each classification in which work is performed. The wage determination (including any additional classification and wage rates conformed under paragraph 1.b. of this section) and the Davis-Bacon poster (WH-1321) shall be posted at all times by the contractor and its subcontractors at the site of the work in a prominent and accessible place where it can be easily seen by the workers.

b.(1) The contracting officer shall require that any class of laborers or mechanics, including helpers, which is not listed in the wage determination and which is to be employed under the contract shall be classified in conformance with the wage determination. The contracting officer shall approve an additional classification and wage rate and fringe benefits therefore only when the following criteria have been met:

- (i) The work to be performed by the classification requested is not performed by a classification in the wage determination; and
- (ii) The classification is utilized in the area by the construction industry; and
- (iii) The proposed wage rate, including any bona fide fringe benefits, bears a reasonable relationship to the wage rates contained in the wage determination.

(2) If the contractor and the laborers and mechanics to be employed in the classification (if known), or their representatives, and the contracting officer agree on the classification and wage rate (including the amount designated for fringe benefits where appropriate), a report of the action taken shall be sent by the contracting officer to the Administrator of the Wage and Hour Division, Employment Standards Administration, U.S. Department of Labor, Washington, DC 20210. The Administrator, or an authorized representative, will approve, modify, or disapprove every additional classification action within 30 days of receipt and so advise the contracting officer or will notify the contracting officer within the 30-day period that additional time is necessary.

(3) In the event the contractor, the laborers or mechanics to be employed in the classification or their representatives, and the contracting officer do not agree on the proposed classification and wage rate (including the amount designated for fringe benefits, where appropriate), the contracting officer shall refer the questions, including the views of all interested parties and the recommendation of the contracting officer, to the Wage and Hour Administrator for determination. The Wage and Hour Administrator, or an authorized representative, will issue a determination within 30 days of receipt and so advise the contracting officer or

will notify the contracting officer within the 30-day period that additional time is necessary.

(4) The wage rate (including fringe benefits where appropriate) determined pursuant to paragraphs 1.b.(2) or 1.b.(3) of this section, shall be paid to all workers performing work in the classification under this contract from the first day on which work is performed in the classification.

c. Whenever the minimum wage rate prescribed in the contract for a class of laborers or mechanics includes a fringe benefit which is not expressed as an hourly rate, the contractor shall either pay the benefit as stated in the wage determination or shall pay another bona fide fringe benefit or an hourly cash equivalent thereof.

d. If the contractor does not make payments to a trustee or other third person, the contractor may consider as part of the wages of any laborer or mechanic the amount of any costs reasonably anticipated in providing bona fide fringe benefits under a plan or program. Provided, That the Secretary of Labor has found, upon the written request of the contractor, that the applicable standards of the Davis-Bacon Act have been met. The Secretary of Labor may require the contractor to set aside in a separate account assets for the meeting of obligations under the plan or program.

2. Withholding

The contracting agency shall upon its own action or upon written request of an authorized representative of the Department of Labor, withhold or cause to be withheld from the contractor under this contract, or any other Federal contract with the same prime contractor, or any other federally-assisted contract subject to Davis-Bacon prevailing wage requirements, which is held by the same prime contractor, so much of the accrued payments or advances as may be considered necessary to pay laborers and mechanics, including apprentices, trainees, and helpers, employed by the contractor or any subcontractor the full amount of wages required by the contract. In the event of failure to pay any laborer or mechanic, including any apprentice, trainee, or helper, employed or working on the site of the work, all or part of the wages required by the contract, the contracting agency may, after written notice to the contractor, take such action as may be necessary to cause the suspension of any further payment, advance, or guarantee of funds until such violations have ceased.

3. Payrolls and basic records

a. Payrolls and basic records relating thereto shall be maintained by the contractor during the course of the work and preserved for a period of three years thereafter for all laborers and mechanics working at the site of the work. Such records shall contain the name, address, and social security number of each such worker, his or her correct classification, hourly rates of wages paid (including rates of contributions or costs anticipated for bona fide fringe benefits or cash equivalents thereof of the types described in section 1(b)(2)(B) of the Davis-Bacon Act), daily and weekly number of hours worked, deductions made and actual wages paid. Whenever the Secretary of Labor has found under 29 CFR 5.5(a)(1)(iv) that the wages of any laborer or mechanic include the amount of any costs reasonably anticipated in providing benefits under a plan or program described in section 1(b)(2)(B) of the Davis-

Bacon Act, the contractor shall maintain records which show that the commitment to provide such benefits is enforceable, that the plan or program is financially responsible, and that the plan or program has been communicated in writing to the laborers or mechanics affected, and records which show the costs anticipated or the actual cost incurred in providing such benefits. Contractors employing apprentices or trainees under approved programs shall maintain written evidence of the registration of apprenticeship programs and certification of trainee programs, the registration of the apprentices and trainees, and the ratios and wage rates prescribed in the applicable programs.

b.(1) The contractor shall submit weekly for each week in which any contract work is performed a copy of all payrolls to the contracting agency. The payrolls submitted shall set out accurately and completely all of the information required to be maintained under 29 CFR 5.5(a)(3)(i), except that full social security numbers and home addresses shall not be included on weekly transmittals. Instead the payrolls shall only need to include an individually identifying number for each employee (e.g., the last four digits of the employee's social security number). The required weekly payroll information may be submitted in any form desired. Optional Form WH-347 is available for this purpose from the Wage and Hour Division Web site at <http://www.dol.gov/esa/whd/forms/wh347instr.htm> or its successor site. The prime contractor is responsible for the submission of copies of payrolls by all subcontractors. Contractors and subcontractors shall maintain the full social security number and current address of each covered worker, and shall provide them upon request to the contracting agency for transmission to the State DOT, the FHWA or the Wage and Hour Division of the Department of Labor for purposes of an investigation or audit of compliance with prevailing wage requirements. It is not a violation of this section for a prime contractor to require a subcontractor to provide addresses and social security numbers to the prime contractor for its own records, without weekly submission to the contracting agency..

(2) Each payroll submitted shall be accompanied by a "Statement of Compliance," signed by the contractor or subcontractor or his or her agent who pays or supervises the payment of the persons employed under the contract and shall certify the following:

(i) That the payroll for the payroll period contains the information required to be provided under §5.5 (a)(3)(ii) of Regulations, 29 CFR part 5, the appropriate information is being maintained under §5.5 (a)(3)(i) of Regulations, 29 CFR part 5, and that such information is correct and complete;

(ii) That each laborer or mechanic (including each helper, apprentice, and trainee) employed on the contract during the payroll period has been paid the full weekly wages earned, without rebate, either directly or indirectly, and that no deductions have been made either directly or indirectly from the full wages earned, other than permissible deductions as set forth in Regulations, 29 CFR part 3;

(iii) That each laborer or mechanic has been paid not less than the applicable wage rates and fringe benefits or cash equivalents for the classification of work performed, as specified in the applicable wage determination incorporated into the contract.

(3) The weekly submission of a properly executed certification set forth on the reverse side of Optional Form WH-347 shall satisfy the requirement for submission of the "Statement of Compliance" required by paragraph 3.b.(2) of this section.

(4) The falsification of any of the above certifications may subject the contractor or subcontractor to civil or criminal prosecution under section 1001 of title 18 and section 231 of title 31 of the United States Code.

c. The contractor or subcontractor shall make the records required under paragraph 3.a. of this section available for inspection, copying, or transcription by authorized representatives of the contracting agency, the State DOT, the FHWA, or the Department of Labor, and shall permit such representatives to interview employees during working hours on the job. If the contractor or subcontractor fails to submit the required records or to make them available, the FHWA may, after written notice to the contractor, the contracting agency or the State DOT, take such action as may be necessary to cause the suspension of any further payment, advance, or guarantee of funds. Furthermore, failure to submit the required records upon request or to make such records available may be grounds for debarment action pursuant to 29 CFR 5.12.

4. Apprentices and trainees

a. Apprentices (programs of the USDOL).

Apprentices will be permitted to work at less than the predetermined rate for the work they performed when they are employed pursuant to and individually registered in a bona fide apprenticeship program registered with the U.S. Department of Labor, Employment and Training Administration, Office of Apprenticeship Training, Employer and Labor Services, or with a State Apprenticeship Agency recognized by the Office, or if a person is employed in his or her first 90 days of probationary employment as an apprentice in such an apprenticeship program, who is not individually registered in the program, but who has been certified by the Office of Apprenticeship Training, Employer and Labor Services or a State Apprenticeship Agency (where appropriate) to be eligible for probationary employment as an apprentice.

The allowable ratio of apprentices to journeymen on the job site in any craft classification shall not be greater than the ratio permitted to the contractor as to the entire work force under the registered program. Any worker listed on a payroll at an apprentice wage rate, who is not registered or otherwise employed as stated above, shall be paid not less than the applicable wage rate on the wage determination for the classification of work actually performed. In addition, any apprentice performing work on the job site in excess of the ratio permitted under the registered program shall be paid not less than the applicable wage rate on the wage determination for the work actually performed. Where a contractor is performing construction on a project in a locality other than that in which its program is registered, the ratios and wage rates (expressed in percentages of the journeyman's hourly rate) specified in the contractor's or subcontractor's registered program shall be observed.

Every apprentice must be paid at not less than the rate specified in the registered program for the apprentice's level of progress, expressed as a percentage of the journeymen hourly

rate specified in the applicable wage determination. Apprentices shall be paid fringe benefits in accordance with the provisions of the apprenticeship program. If the apprenticeship program does not specify fringe benefits, apprentices must be paid the full amount of fringe benefits listed on the wage determination for the applicable classification. If the Administrator determines that a different practice prevails for the applicable apprentice classification, fringes shall be paid in accordance with that determination.

In the event the Office of Apprenticeship Training, Employer and Labor Services, or a State Apprenticeship Agency recognized by the Office, withdraws approval of an apprenticeship program, the contractor will no longer be permitted to utilize apprentices at less than the applicable predetermined rate for the work performed until an acceptable program is approved.

b. Trainees (programs of the USDOL).

Except as provided in 29 CFR 5.16, trainees will not be permitted to work at less than the predetermined rate for the work performed unless they are employed pursuant to and individually registered in a program which has received prior approval, evidenced by formal certification by the U.S. Department of Labor, Employment and Training Administration.

The ratio of trainees to journeymen on the job site shall not be greater than permitted under the plan approved by the Employment and Training Administration.

Every trainee must be paid at not less than the rate specified in the approved program for the trainee's level of progress, expressed as a percentage of the journeyman hourly rate specified in the applicable wage determination. Trainees shall be paid fringe benefits in accordance with the provisions of the trainee program. If the trainee program does not mention fringe benefits, trainees shall be paid the full amount of fringe benefits listed on the wage determination unless the Administrator of the Wage and Hour Division determines that there is an apprenticeship program associated with the corresponding journeyman wage rate on the wage determination which provides for less than full fringe benefits for apprentices. Any employee listed on the payroll at a trainee rate who is not registered and participating in a training plan approved by the Employment and Training Administration shall be paid not less than the applicable wage rate on the wage determination for the classification of work actually performed. In addition, any trainee performing work on the job site in excess of the ratio permitted under the registered program shall be paid not less than the applicable wage rate on the wage determination for the work actually performed.

In the event the Employment and Training Administration withdraws approval of a training program, the contractor will no longer be permitted to utilize trainees at less than the applicable predetermined rate for the work performed until an acceptable program is approved.

c. Equal employment opportunity. The utilization of apprentices, trainees and journeymen under this part shall be in conformity with the equal employment opportunity requirements of Executive Order 11246, as amended, and 29 CFR part 30.

d. Apprentices and Trainees (programs of the U.S. DOT).

Apprentices and trainees working under apprenticeship and skill training programs which have been certified by the Secretary of Transportation as promoting EEO in connection with Federal-aid highway construction programs are not subject to the requirements of paragraph 4 of this Section IV. The straight time hourly wage rates for apprentices and trainees under such programs will be established by the particular programs. The ratio of apprentices and trainees to journeymen shall not be greater than permitted by the terms of the particular program.

5. Compliance with Copeland Act requirements. The contractor shall comply with the requirements of 29 CFR part 3, which are incorporated by reference in this contract.

6. Subcontracts. The contractor or subcontractor shall insert Form FHWA-1273 in any subcontracts and also require the subcontractors to include Form FHWA-1273 in any lower tier subcontracts. The prime contractor shall be responsible for the compliance by any subcontractor or lower tier subcontractor with all the contract clauses in 29 CFR 5.5.

7. Contract termination: debarment. A breach of the contract clauses in 29 CFR 5.5 may be grounds for termination of the contract, and for debarment as a contractor and a subcontractor as provided in 29 CFR 5.12.

8. Compliance with Davis-Bacon and Related Act requirements. All rulings and interpretations of the Davis-Bacon and Related Acts contained in 29 CFR parts 1, 3, and 5 are herein incorporated by reference in this contract.

9. Disputes concerning labor standards. Disputes arising out of the labor standards provisions of this contract shall not be subject to the general disputes clause of this contract. Such disputes shall be resolved in accordance with the procedures of the Department of Labor set forth in 29 CFR parts 5, 6, and 7. Disputes within the meaning of this clause include disputes between the contractor (or any of its subcontractors) and the contracting agency, the U.S. Department of Labor, or the employees or their representatives.

10. Certification of eligibility.

a. By entering into this contract, the contractor certifies that neither it (nor he or she) nor any person or firm who has an interest in the contractor's firm is a person or firm ineligible to be awarded Government contracts by virtue of section 3(a) of the Davis-Bacon Act or 29 CFR 5.12(a)(1).

b. No part of this contract shall be subcontracted to any person or firm ineligible for award of a Government contract by virtue of section 3(a) of the Davis-Bacon Act or 29 CFR 5.12(a)(1).

c. The penalty for making false statements is prescribed in the U.S. Criminal Code, 18 U.S.C. 1001.

V. CONTRACT WORK HOURS AND SAFETY STANDARDS ACT

The following clauses apply to any Federal-aid construction contract in an amount in excess of \$100,000 and subject to the overtime provisions of the Contract Work Hours and Safety Standards Act. These clauses shall be inserted in addition to the clauses required by 29 CFR 5.5(a) or 29 CFR 4.6. As used in this paragraph, the terms laborers and mechanics include watchmen and guards.

1. Overtime requirements. No contractor or subcontractor contracting for any part of the contract work which may require or involve the employment of laborers or mechanics shall require or permit any such laborer or mechanic in any workweek in which he or she is employed on such work to work in excess of forty hours in such workweek unless such laborer or mechanic receives compensation at a rate not less than one and one-half times the basic rate of pay for all hours worked in excess of forty hours in such workweek.

2. Violation; liability for unpaid wages; liquidated damages. In the event of any violation of the clause set forth in paragraph (1.) of this section, the contractor and any subcontractor responsible therefor shall be liable for the unpaid wages. In addition, such contractor and subcontractor shall be liable to the United States (in the case of work done under contract for the District of Columbia or a territory, to such District or to such territory), for liquidated damages. Such liquidated damages shall be computed with respect to each individual laborer or mechanic, including watchmen and guards, employed in violation of the clause set forth in paragraph (1.) of this section, in the sum of \$10 for each calendar day on which such individual was required or permitted to work in excess of the standard workweek of forty hours without payment of the overtime wages required by the clause set forth in paragraph (1.) of this section.

3. Withholding for unpaid wages and liquidated damages. The FHWA or the contracting agency shall upon its own action or upon written request of an authorized representative of the Department of Labor withhold or cause to be withheld, from any moneys payable on account of work performed by the contractor or subcontractor under any such contract or any other Federal contract with the same prime contractor, or any other federally-assisted contract subject to the Contract Work Hours and Safety Standards Act, which is held by the same prime contractor, such sums as may be determined to be necessary to satisfy any liabilities of such contractor or subcontractor for unpaid wages and liquidated damages as provided in the clause set forth in paragraph (2.) of this section.

4. Subcontracts. The contractor or subcontractor shall insert in any subcontracts the clauses set forth in paragraph (1.) through (4.) of this section and also a clause requiring the subcontractors to include these clauses in any lower tier subcontracts. The prime contractor shall be responsible for compliance by any subcontractor or lower tier subcontractor with the clauses set forth in paragraphs (1.) through (4.) of this section.

VI. SUBLETTING OR ASSIGNING THE CONTRACT

This provision is applicable to all Federal-aid construction contracts on the National Highway System.

1. The contractor shall perform with its own organization contract work amounting to not less than 30 percent (or a greater percentage if specified elsewhere in the contract) of the total original contract price, excluding any specialty items designated by the contracting agency. Specialty items may be performed by subcontract and the amount of any such specialty items performed may be deducted from the total original contract price before computing the amount of work required to be performed by the contractor's own organization (23 CFR 635.116).

a. The term "perform work with its own organization" refers to workers employed or leased by the prime contractor, and equipment owned or rented by the prime contractor, with or without operators. Such term does not include employees or equipment of a subcontractor or lower tier subcontractor, agents of the prime contractor, or any other assignees. The term may include payments for the costs of hiring leased employees from an employee leasing firm meeting all relevant Federal and State regulatory requirements. Leased employees may only be included in this term if the prime contractor meets all of the following conditions:

- (1) the prime contractor maintains control over the supervision of the day-to-day activities of the leased employees;
- (2) the prime contractor remains responsible for the quality of the work of the leased employees;
- (3) the prime contractor retains all power to accept or exclude individual employees from work on the project; and
- (4) the prime contractor remains ultimately responsible for the payment of predetermined minimum wages, the submission of payrolls, statements of compliance and all other Federal regulatory requirements.

b. "Specialty Items" shall be construed to be limited to work that requires highly specialized knowledge, abilities, or equipment not ordinarily available in the type of contracting organizations qualified and expected to bid or propose on the contract as a whole and in general are to be limited to minor components of the overall contract.

2. The contract amount upon which the requirements set forth in paragraph (1) of Section VI is computed includes the cost of material and manufactured products which are to be purchased or produced by the contractor under the contract provisions.

3. The contractor shall furnish (a) a competent superintendent or supervisor who is employed by the firm, has full authority to direct performance of the work in accordance with the contract requirements, and is in charge of all construction operations (regardless of who performs the work) and (b) such other of its own organizational resources (supervision, management, and engineering services) as the contracting officer determines is necessary to assure the performance of the contract.

4. No portion of the contract shall be sublet, assigned or otherwise disposed of except with the written consent of the contracting officer, or authorized representative, and such consent when given shall not be construed to relieve the contractor of any responsibility for the fulfillment of the contract. Written consent will be given only after the contracting agency has assured that each subcontract is

evidenced in writing and that it contains all pertinent provisions and requirements of the prime contract.

5. The 30% self-performance requirement of paragraph (1) is not applicable to design-build contracts; however, contracting agencies may establish their own self-performance requirements.

VII. SAFETY: ACCIDENT PREVENTION

This provision is applicable to all Federal-aid construction contracts and to all related subcontracts.

1. In the performance of this contract the contractor shall comply with all applicable Federal, State, and local laws governing safety, health, and sanitation (23 CFR 635). The contractor shall provide all safeguards, safety devices and protective equipment and take any other needed actions as it determines, or as the contracting officer may determine, to be reasonably necessary to protect the life and health of employees on the job and the safety of the public and to protect property in connection with the performance of the work covered by the contract.

2. It is a condition of this contract, and shall be made a condition of each subcontract, which the contractor enters into pursuant to this contract, that the contractor and any subcontractor shall not permit any employee, in performance of the contract, to work in surroundings or under conditions which are unsanitary, hazardous or dangerous to his/her health or safety, as determined under construction safety and health standards (29 CFR 1926) promulgated by the Secretary of Labor, in accordance with Section 107 of the Contract Work Hours and Safety Standards Act (40 U.S.C. 3704).

3. Pursuant to 29 CFR 1926.3, it is a condition of this contract that the Secretary of Labor or authorized representative thereof, shall have right of entry to any site of contract performance to inspect or investigate the matter of compliance with the construction safety and health standards and to carry out the duties of the Secretary under Section 107 of the Contract Work Hours and Safety Standards Act (40 U.S.C.3704).

VIII. FALSE STATEMENTS CONCERNING HIGHWAY PROJECTS

This provision is applicable to all Federal-aid construction contracts and to all related subcontracts.

In order to assure high quality and durable construction in conformity with approved plans and specifications and a high degree of reliability on statements and representations made by engineers, contractors, suppliers, and workers on Federal-aid highway projects, it is essential that all persons concerned with the project perform their functions as carefully, thoroughly, and honestly as possible. Willful falsification, distortion, or misrepresentation with respect to any facts related to the project is a violation of Federal law. To prevent any misunderstanding regarding the seriousness of these and similar acts, Form FHWA-1022 shall be posted on each Federal-aid highway project (23 CFR 635) in one or more places where it is readily available to all persons concerned with the project:

18 U.S.C. 1020 reads as follows:

"Whoever, being an officer, agent, or employee of the United States, or of any State or Territory, or whoever, whether a person, association, firm, or corporation, knowingly makes any false statement, false representation, or false report as to the character, quality, quantity, or cost of the material used or to be used, or the quantity or quality of the work performed or to be performed, or the cost thereof in connection with the submission of plans, maps, specifications, contracts, or costs of construction on any highway or related project submitted for approval to the Secretary of Transportation; or

Whoever knowingly makes any false statement, false representation, false report or false claim with respect to the character, quality, quantity, or cost of any work performed or to be performed, or materials furnished or to be furnished, in connection with the construction of any highway or related project approved by the Secretary of Transportation; or

Whoever knowingly makes any false statement or false representation as to material fact in any statement, certificate, or report submitted pursuant to provisions of the Federal-aid Roads Act approved July 1, 1916, (39 Stat. 355), as amended and supplemented;

Shall be fined under this title or imprisoned not more than 5 years or both."

IX. IMPLEMENTATION OF CLEAN AIR ACT AND FEDERAL WATER POLLUTION CONTROL ACT

This provision is applicable to all Federal-aid construction contracts and to all related subcontracts.

By submission of this bid/proposal or the execution of this contract, or subcontract, as appropriate, the bidder, proposer, Federal-aid construction contractor, or subcontractor, as appropriate, will be deemed to have stipulated as follows:

1. That any person who is or will be utilized in the performance of this contract is not prohibited from receiving an award due to a violation of Section 508 of the Clean Water Act or Section 306 of the Clean Air Act.
2. That the contractor agrees to include or cause to be included the requirements of paragraph (1) of this Section X in every subcontract, and further agrees to take such action as the contracting agency may direct as a means of enforcing such requirements.

X. CERTIFICATION REGARDING DEBARMENT, SUSPENSION, INELIGIBILITY AND VOLUNTARY EXCLUSION

This provision is applicable to all Federal-aid construction contracts, design-build contracts, subcontracts, lower-tier subcontracts, purchase orders, lease agreements, consultant contracts or any other covered transaction requiring FHWA approval or that is estimated to cost \$25,000 or more – as defined in 2 CFR Parts 180 and 1200.

1. Instructions for Certification – First Tier Participants:

- a. By signing and submitting this proposal, the prospective first tier participant is providing the certification set out below.
- b. The inability of a person to provide the certification set out below will not necessarily result in denial of participation in this

covered transaction. The prospective first tier participant shall submit an explanation of why it cannot provide the certification set out below. The certification or explanation will be considered in connection with the department or agency's determination whether to enter into this transaction. However, failure of the prospective first tier participant to furnish a certification or an explanation shall disqualify such a person from participation in this transaction.

c. The certification in this clause is a material representation of fact upon which reliance was placed when the contracting agency determined to enter into this transaction. If it is later determined that the prospective participant knowingly rendered an erroneous certification, in addition to other remedies available to the Federal Government, the contracting agency may terminate this transaction for cause of default.

d. The prospective first tier participant shall provide immediate written notice to the contracting agency to whom this proposal is submitted if any time the prospective first tier participant learns that its certification was erroneous when submitted or has become erroneous by reason of changed circumstances.

e. The terms "covered transaction," "debarred," "suspended," "ineligible," "participant," "person," "principal," and "voluntarily excluded," as used in this clause, are defined in 2 CFR Parts 180 and 1200. "First Tier Covered Transactions" refers to any covered transaction between a grantee or subgrantee of Federal funds and a participant (such as the prime or general contract). "Lower Tier Covered Transactions" refers to any covered transaction under a First Tier Covered Transaction (such as subcontracts). "First Tier Participant" refers to the participant who has entered into a covered transaction with a grantee or subgrantee of Federal funds (such as the prime or general contractor). "Lower Tier Participant" refers any participant who has entered into a covered transaction with a First Tier Participant or other Lower Tier Participants (such as subcontractors and suppliers).

f. The prospective first tier participant agrees by submitting this proposal that, should the proposed covered transaction be entered into, it shall not knowingly enter into any lower tier covered transaction with a person who is debarred, suspended, declared ineligible, or voluntarily excluded from participation in this covered transaction, unless authorized by the department or agency entering into this transaction.

g. The prospective first tier participant further agrees by submitting this proposal that it will include the clause titled "Certification Regarding Debarment, Suspension, Ineligibility and Voluntary Exclusion-Lower Tier Covered Transactions," provided by the department or contracting agency, entering into this covered transaction, without modification, in all lower tier covered transactions and in all solicitations for lower tier covered transactions exceeding the \$25,000 threshold.

h. A participant in a covered transaction may rely upon a certification of a prospective participant in a lower tier covered transaction that is not debarred, suspended, ineligible, or voluntarily excluded from the covered transaction, unless it knows that the certification is erroneous. A participant is responsible for ensuring that its principals are not suspended, debarred, or otherwise ineligible to participate in covered transactions. To verify the eligibility of its principals, as well as the eligibility of any lower tier prospective participants, each participant may, but is not required to, check the Excluded Parties List System website (<https://www.epls.gov/>), which is compiled by the General Services Administration.

i. Nothing contained in the foregoing shall be construed to require the establishment of a system of records in order to render in good faith the certification required by this clause. The knowledge and information of the prospective participant is not required to exceed that which is normally possessed by a prudent person in the ordinary course of business dealings.

j. Except for transactions authorized under paragraph (f) of these instructions, if a participant in a covered transaction knowingly enters into a lower tier covered transaction with a person who is suspended, debarred, ineligible, or voluntarily excluded from participation in this transaction, in addition to other remedies available to the Federal Government, the department or agency may terminate this transaction for cause or default.

2. Certification Regarding Debarment, Suspension, Ineligibility and Voluntary Exclusion – First Tier Participants:

a. The prospective first tier participant certifies to the best of its knowledge and belief, that it and its principals:

- (1) Are not presently debarred, suspended, proposed for debarment, declared ineligible, or voluntarily excluded from participating in covered transactions by any Federal department or agency;
- (2) Have not within a three-year period preceding this proposal been convicted of or had a civil judgment rendered against them for commission of fraud or a criminal offense in connection with obtaining, attempting to obtain, or performing a public (Federal, State or local) transaction or contract under a public transaction; violation of Federal or State antitrust statutes or commission of embezzlement, theft, forgery, bribery, falsification or destruction of records, making false statements, or receiving stolen property;
- (3) Are not presently indicted for or otherwise criminally or civilly charged by a governmental entity (Federal, State or local) with commission of any of the offenses enumerated in paragraph (a)(2) of this certification; and
- (4) Have not within a three-year period preceding this application/proposal had one or more public transactions (Federal, State or local) terminated for cause or default.

b. Where the prospective participant is unable to certify to any of the statements in this certification, such prospective participant shall attach an explanation to this proposal.

2. Instructions for Certification - Lower Tier Participants:

(Applicable to all subcontracts, purchase orders and other lower tier transactions requiring prior FHWA approval or estimated to cost \$25,000 or more - 2 CFR Parts 180 and 1200)

a. By signing and submitting this proposal, the prospective lower tier is providing the certification set out below.

b. The certification in this clause is a material representation of fact upon which reliance was placed when this transaction was entered into. If it is later determined that the prospective lower tier participant knowingly rendered an erroneous certification, in addition to other remedies available to the Federal Government, the department, or agency with which

this transaction originated may pursue available remedies, including suspension and/or debarment.

c. The prospective lower tier participant shall provide immediate written notice to the person to which this proposal is submitted if at any time the prospective lower tier participant learns that its certification was erroneous by reason of changed circumstances.

d. The terms "covered transaction," "debarred," "suspended," "ineligible," "participant," "person," "principal," and "voluntarily excluded," as used in this clause, are defined in 2 CFR Parts 180 and 1200. You may contact the person to which this proposal is submitted for assistance in obtaining a copy of those regulations. "First Tier Covered Transactions" refers to any covered transaction between a grantee or subgrantee of Federal funds and a participant (such as the prime or general contract). "Lower Tier Covered Transactions" refers to any covered transaction under a First Tier Covered Transaction (such as subcontracts). "First Tier Participant" refers to the participant who has entered into a covered transaction with a grantee or subgrantee of Federal funds (such as the prime or general contractor). "Lower Tier Participant" refers any participant who has entered into a covered transaction with a First Tier Participant or other Lower Tier Participants (such as subcontractors and suppliers).

e. The prospective lower tier participant agrees by submitting this proposal that, should the proposed covered transaction be entered into, it shall not knowingly enter into any lower tier covered transaction with a person who is debarred, suspended, declared ineligible, or voluntarily excluded from participation in this covered transaction, unless authorized by the department or agency with which this transaction originated.

f. The prospective lower tier participant further agrees by submitting this proposal that it will include this clause titled "Certification Regarding Debarment, Suspension, Ineligibility and Voluntary Exclusion-Lower Tier Covered Transaction," without modification, in all lower tier covered transactions and in all solicitations for lower tier covered transactions exceeding the \$25,000 threshold.

g. A participant in a covered transaction may rely upon a certification of a prospective participant in a lower tier covered transaction that is not debarred, suspended, ineligible, or voluntarily excluded from the covered transaction, unless it knows that the certification is erroneous. A participant is responsible for ensuring that its principals are not suspended, debarred, or otherwise ineligible to participate in covered transactions. To verify the eligibility of its principals, as well as the eligibility of any lower tier prospective participants, each participant may, but is not required to, check the Excluded Parties List System website (<https://www.epls.gov/>), which is compiled by the General Services Administration.

h. Nothing contained in the foregoing shall be construed to require establishment of a system of records in order to render in good faith the certification required by this clause. The knowledge and information of participant is not required to exceed that which is normally possessed by a prudent person in the ordinary course of business dealings.

i. Except for transactions authorized under paragraph e of these instructions, if a participant in a covered transaction knowingly enters into a lower tier covered transaction with a person who is suspended, debarred, ineligible, or voluntarily excluded from participation in this transaction, in addition to other remedies available to the Federal Government, the

department or agency with which this transaction originated may pursue available remedies, including suspension and/or debarment.

* * * * *

Certification Regarding Debarment, Suspension, Ineligibility and Voluntary Exclusion--Lower Tier Participants:

1. The prospective lower tier participant certifies, by submission of this proposal, that neither it nor its principals is presently debarred, suspended, proposed for debarment, declared ineligible, or voluntarily excluded from participating in covered transactions by any Federal department or agency.

2. Where the prospective lower tier participant is unable to certify to any of the statements in this certification, such prospective participant shall attach an explanation to this proposal.

* * * * *

XI. CERTIFICATION REGARDING USE OF CONTRACT FUNDS FOR LOBBYING

This provision is applicable to all Federal-aid construction contracts and to all related subcontracts which exceed \$100,000 (49 CFR 20).

1. The prospective participant certifies, by signing and submitting this bid or proposal, to the best of his or her knowledge and belief, that:

a. No Federal appropriated funds have been paid or will be paid, by or on behalf of the undersigned, to any person for influencing or attempting to influence an officer or employee of any Federal agency, a Member of Congress, an officer or employee of Congress, or an employee of a Member of Congress in connection with the awarding of any Federal contract, the making of any Federal grant, the making of any Federal loan, the entering into of any cooperative agreement, and the extension, continuation, renewal, amendment, or modification of any Federal contract, grant, loan, or cooperative agreement.

b. If any funds other than Federal appropriated funds have been paid or will be paid to any person for influencing or attempting to influence an officer or employee of any Federal agency, a Member of Congress, an officer or employee of Congress, or an employee of a Member of Congress in connection with this Federal contract, grant, loan, or cooperative agreement, the undersigned shall complete and submit Standard Form-LLL, "Disclosure Form to Report Lobbying," in accordance with its instructions.

2. This certification is a material representation of fact upon which reliance was placed when this transaction was made or entered into. Submission of this certification is a prerequisite for making or entering into this transaction imposed by 31 U.S.C. 1352. Any person who fails to file the required certification shall be subject to a civil penalty of not less than \$10,000 and not more than \$100,000 for each such failure.

3. The prospective participant also agrees by submitting its bid or proposal that the participant shall require that the language of this certification be included in all lower tier subcontracts, which exceed \$100,000 and that all such recipients shall certify and disclose accordingly.

**ATTACHMENT A - EMPLOYMENT AND MATERIALS
PREFERENCE FOR APPALACHIAN DEVELOPMENT
HIGHWAY SYSTEM OR APPALACHIAN LOCAL ACCESS
ROAD CONTRACTS**

This provision is applicable to all Federal-aid projects funded under the Appalachian Regional Development Act of 1965.

1. During the performance of this contract, the contractor undertaking to do work which is, or reasonably may be, done as on-site work, shall give preference to qualified persons who regularly reside in the labor area as designated by the DOL wherein the contract work is situated, or the subregion, or the Appalachian counties of the State wherein the contract work is situated, except:

a. To the extent that qualified persons regularly residing in the area are not available.

b. For the reasonable needs of the contractor to employ supervisory or specially experienced personnel necessary to assure an efficient execution of the contract work.

c. For the obligation of the contractor to offer employment to present or former employees as the result of a lawful collective bargaining contract, provided that the number of nonresident persons employed under this subparagraph (1c) shall not exceed 20 percent of the total number of employees employed by the contractor on the contract work, except as provided in subparagraph (4) below.

2. The contractor shall place a job order with the State Employment Service indicating (a) the classifications of the laborers, mechanics and other employees required to perform the contract work, (b) the number of employees required in each classification, (c) the date on which the participant estimates such employees will be required, and (d) any other pertinent information required by the State Employment Service to complete the job order form. The job order may be placed with the State Employment Service in writing or by telephone. If during the course of the contract work, the information submitted by the contractor in the original job order is substantially modified, the participant shall promptly notify the State Employment Service.

3. The contractor shall give full consideration to all qualified job applicants referred to him by the State Employment Service. The contractor is not required to grant employment to any job applicants who, in his opinion, are not qualified to perform the classification of work required.

4. If, within one week following the placing of a job order by the contractor with the State Employment Service, the State Employment Service is unable to refer any qualified job applicants to the contractor, or less than the number requested, the State Employment Service will forward a certificate to the contractor indicating the unavailability of applicants. Such certificate shall be made a part of the contractor's permanent project records. Upon receipt of this certificate, the contractor may employ persons who do not normally reside in the labor area to fill positions covered by the certificate, notwithstanding the provisions of subparagraph (1c) above.

5. The provisions of 23 CFR 633.207(e) allow the contracting agency to provide a contractual preference for the use of mineral resource materials native to the Appalachian region.

6. The contractor shall include the provisions of Sections 1 through 4 of this Attachment A in every subcontract for work which is, or reasonably may be, done as on-site work.

**KENTUCKY TRANSPORTATION CABINET
DEPARTMENT OF HIGHWAYS**

**EMPLOYMENT REQUIREMENTS
RELATING TO
NONDISCRIMINATION OF EMPLOYEES
(APPLICABLE TO FEDERAL-AID SYSTEM CONTRACTS)**

**AN ACT OF THE KENTUCKY GENERAL ASSEMBLY
TO PREVENT DISCRIMINATION IN EMPLOYMENT**

**KRS CHAPTER 344
EFFECTIVE JUNE 16, 1972**

The contract on this project, in accordance with KRS Chapter 344, provides that during the performance of this contract, the contractor agrees as follows:

1. The contractor shall not fail or refuse to hire, or shall not discharge any individual, or otherwise discriminate against an individual with respect to his compensation, terms, conditions, or privileges of employment, because of such individual's race, color, religion, national origin, sex, disability or age (forty and above); or limit, segregate, or classify his employees in any way which would deprive or tend to deprive an individual of employment opportunities or otherwise adversely affect his status as an employee, because of such individual's race, color, religion, national origin, sex, disability or age forty (40) and over. The contractor agrees to post in conspicuous places, available to employees and applicants for employment, notices to be provided setting forth the provisions of this nondiscrimination clause.

2. The contractor shall not print or publish or cause to be printed or published a notice or advertisement relating to employment by such an employer or membership in or any classification or referral for employment by the employment agency, indicating any preference, limitation, specification, or discrimination, based on race, color, religion, national origin, sex, or age forty (40) and over, or because the person is a qualified individual with a disability, except that such a notice or advertisement may indicate a preference, limitation, or specification based on religion, national origin, sex, or age forty (40) and over, or because the person is a qualified individual with a disability, when religion, national origin, sex, or age forty (40) and over, or because the person is a qualified individual with a disability, is a bona fide occupational qualification for employment.

3. If the contractor is in control of apprenticeship or other training or retraining, including on-the-job training programs, he shall not discriminate against an individual because of his race, color, religion, national origin, sex, disability or age forty (40) and over, in admission to, or employment in any program established to provide apprenticeship or other training.

4. The contractor will send to each labor union or representative of workers with which he has a collective bargaining agreement or other contract or understanding, a notice to be provided advising the said labor union or workers' representative of the contractor's commitments under this section, and shall post copies of the notice in conspicuous places available to employees and applicants for employment. The contractor will take such action with respect to any subcontract or purchase order as the administering agency may direct as a means of enforcing such provisions, including sanctions for non-compliance.

Revised: January 25, 2017

Standard Title VI/Non-Discrimination Assurances

During the performance of this contract, the contractor, for itself, its assignees, and successors in interest (hereinafter referred to as the "contractor") agrees as follows:

1. **Compliance with Regulations:** The contractor (hereinafter includes consultants) will comply with the Acts and the Regulations relative to Non-discrimination in Federally-assisted programs of the U.S. Department of Transportation, **Federal Highway Administration**, as they may be amended from time to time, which are herein incorporated by reference and made a part of this contract.
2. **Non-discrimination:** The contractor, with regard to the work performed by it during the contract, will not discriminate on the grounds of race, color, or national origin in the selection and retention of subcontractors, including procurements of materials and leases of equipment. The contractor will not participate directly or indirectly in the discrimination prohibited by the Acts and the Regulations, including employment practices when the contract covers any activity, project, or program set forth in Appendix B of 49 CFR Part 21.
3. **Solicitations for Subcontracts, Including Procurements of Materials and Equipment:** In all solicitations, either by competitive bidding, or negotiation made by the contractor for work to be performed under a subcontract, including procurements of materials, or leases of equipment, each potential subcontractor or supplier will be notified by the contractor of the contractor's obligations under this contract and the Acts and the Regulations relative to Non-discrimination on the grounds of race, color, or national origin.
4. **Information and Reports:** The contractor will provide all information and reports required by the Acts, the Regulations, and directives issued pursuant thereto and will permit access to its books, records, accounts, other sources of information, and its facilities as may be determined by the Recipient or the **Federal Highway Administration** to be pertinent to ascertain compliance with such Acts, Regulations, and instructions. Where any information required of a contractor is in the exclusive possession of another who fails or refuses to furnish the information, the contractor will so certify to the Recipient or the **Federal Highway Administration**, as appropriate, and will set forth what efforts it has made to obtain the information.
5. **Sanctions for Noncompliance:** In the event of a contractor's noncompliance with the Non-discrimination provisions of this contract, the Recipient will impose such contract sanctions as it or the **Federal Highway Administration** may determine to be appropriate, including, but not limited to:
 - a. withholding payments to the contractor under the contract until the contractor complies; and/or
 - b. cancelling, terminating, or suspending a contract, in whole or in part.
6. **Incorporation of Provisions:** The contractor will include the provisions of paragraphs one through six in every subcontract, including procurements of materials and leases of equipment, unless exempt by the Acts, the Regulations and directives issued pursuant thereto. The contractor will take action with respect to any subcontract or procurement as the Recipient or the **Federal Highway Administration** may direct as a means of enforcing such provisions including sanctions for noncompliance. Provided, that if the contractor becomes involved in, or is threatened with litigation by a subcontractor, or supplier because of such direction, the contractor may request the Recipient to enter into any litigation to protect the interests of the Recipient. In addition, the contractor may request the United States to enter into the litigation to protect the interests of the United States.

Standard Title VI/Non-Discrimination Statutes and Authorities

During the performance of this contract, the contractor, for itself, its assignees, and successors in interest (hereinafter referred to as the “contractor”) agrees to comply with the following non-discrimination statutes and authorities; including but not limited to:

- Title VI of the Civil Rights Act of 1964 (42 U.S.C. § 2000d *et seq.*, 78 stat. 252), (prohibits discrimination on the basis of race, color, national origin); and 49 CFR Part 21;
- The Uniform Relocation Assistance and Real Property Acquisition Policies Act of 1970, (42 U.S.C. § 4601), (prohibits unfair treatment of persons displaced or whose property has been acquired because of Federal or Federal-aid programs and projects);
- Federal-Aid Highway Act of 1973, (23 U.S.C. § 324 *et seq.*), (prohibits discrimination on the basis of sex);
- Section 504 of the Rehabilitation Act of 1973, (29 U.S.C. § 794 *et seq.*), as amended, (prohibits discrimination on the basis of disability); and 49 CFR Part 27;
- The Age Discrimination Act of 1975, as amended, (42 U.S.C. § 6101 *et seq.*), (prohibits discrimination on the basis of age);
- Airport and Airway Improvement Act of 1982, (49 USC § 471, Section 47123), as amended, (prohibits discrimination based on race, creed, color, national origin, or sex);
- The Civil Rights Restoration Act of 1987, (PL 100-209), (Broadened the scope, coverage and applicability of Title VI of the Civil Rights Act of 1964, The Age Discrimination Act of 1975 and Section 504 of the Rehabilitation Act of 1973, by expanding the definition of the terms “programs or activities” to include all of the programs or activities of the Federal-aid recipients, sub-recipients and contractors, whether such programs or activities are Federally funded or not);
- Titles II and III of the Americans with Disabilities Act, which prohibit discrimination on the basis of disability in the operation of public entities, public and private transportation systems, places of public accommodation, and certain testing entities (42 U.S.C. §§ 12131 -- 12189) as implemented by Department of Transportation regulations at 49 C.F.R. parts 37 and 38;
- The Federal Aviation Administration’s Non-discrimination statute (49 U.S.C. § 47123) (prohibits discrimination on the basis of race, color, national origin, and sex);
- Executive Order 12898, Federal Actions to Address Environmental Justice in Minority Populations and Low-Income Populations, which ensures non-discrimination against minority populations by discouraging programs, policies, and activities with disproportionately high and adverse human health or environmental effects on minority and low-income populations;
- Executive Order 13166, Improving Access to Services for Persons with Limited English Proficiency, and resulting agency guidance, national origin discrimination includes discrimination because of limited English proficiency (LEP). To ensure compliance with Title VI, you must take reasonable steps to ensure that LEP persons have meaningful access to your programs (70 Fed. Reg. at 74087 to 74100);
- Title IX of the Education Amendments of 1972, as amended, which prohibits you from discriminating because of sex in education programs or activities (20 U.S.C. 1681 *et seq.*)

EXECUTIVE BRANCH CODE OF ETHICS

In the 1992 regular legislative session, the General Assembly passed and Governor Brereton Jones signed Senate Bill 63 (codified as KRS 11A), the Executive Branch Code of Ethics, which states, in part:

KRS 11A.040 (7) provides:

No present or former public servant shall, within six (6) months following termination of his office or employment, accept employment, compensation, or other economic benefit from any person or business that contracts or does business with, or is regulated by, the state in matters in which he was directly involved during the last thirty-six (36) months of his tenure. This provision shall not prohibit an individual from returning to the same business, firm, occupation, or profession in which he was involved prior to taking office or beginning his term of employment, or for which he received, prior to his state employment, a professional degree or license, provided that, for a period of six (6) months, he personally refrains from working on any matter in which he was directly involved during the last thirty-six (36) months of his tenure in state government. This subsection shall not prohibit the performance of ministerial functions, including but not limited to filing tax returns, filing applications for permits or licenses, or filing incorporation papers, nor shall it prohibit the former officer or public servant from receiving public funds disbursed through entitlement programs.

KRS 11A.040 (9) states:

A former public servant shall not represent a person or business before a state agency in a matter in which the former public servant was directly involved during the last thirty-six (36) months of his tenure, for a period of one (1) year after the latter of:

- a) The date of leaving office or termination of employment; or
- b) The date the term of office expires to which the public servant was elected.

This law is intended to promote public confidence in the integrity of state government and to declare as public policy the idea that state employees should view their work as a public trust and not as a way to obtain private benefits.

If you have worked for the executive branch of state government within the past six months, you may be subject to the law's prohibitions. The law's applicability may be different if you hold elected office or are contemplating representation of another before a state agency.

Also, if you are affiliated with a firm which does business with the state and which employs former state executive-branch employees, you should be aware that the law may apply to them.

In case of doubt, the law permits you to request an advisory opinion from the Executive Branch Ethics Commission, 1025 Capital Center Drive, Suite 104, Frankfort, Kentucky 40601; telephone (502) 564-7954.

Revised: May 23, 2022

"General Decision Number: KY20220040 05/06/2022

Superseded General Decision Number: KY20210040

State: Kentucky

Construction Type: Highway

Counties: Allen, Ballard, Butler, Caldwell, Calloway, Carlisle, Christian, Crittenden, Daviess, Edmonson, Fulton, Graves, Hancock, Henderson, Hickman, Hopkins, Livingston, Logan, Lyon, Marshall, McCracken, McLean, Muhlenberg, Ohio, Simpson, Todd, Trigg, Union, Warren and Webster Counties in Kentucky.

HIGHWAY CONSTRUCTION PROJECTS (excluding tunnels, building structures in rest area projects & railroad construction; bascule, suspension & spandrel arch bridges designed for commercial navigation, bridges involving marine construction; and other major bridges).

Note: Contracts subject to the Davis-Bacon Act are generally required to pay at least the applicable minimum wage rate required under Executive Order 14026 or Executive Order 13658. Please note that these Executive Orders apply to covered contracts entered into by the federal government that are subject to the Davis-Bacon Act itself, but do not apply to contracts subject only to the Davis-Bacon Related Acts, including those set forth at 29 CFR 5.1(a)(2)-(60).

<p>If the contract is entered into on or after January 30, 2022, or the contract is renewed or extended (e.g., an option is exercised) on or after January 30, 2022:</p>	<ul style="list-style-type: none"> . Executive Order 14026 generally applies to the contract. . The contractor must pay all covered workers at least \$15.00 per hour (or the applicable wage rate listed on this wage determination, if it is higher) for all hours spent performing on the contract in 2022.
<p>If the contract was awarded on or between January 1, 2015 and January 29, 2022, and the contract is not renewed or extended on or after January 30, 2022:</p>	<ul style="list-style-type: none"> . Executive Order 13658 generally applies to the contract. . The contractor must pay all covered workers at least \$11.25 per hour (or the applicable wage rate listed on this wage determination, if it is higher) for all hours spent performing on that contract in 2022.

The applicable Executive Order minimum wage rate will be adjusted annually. If this contract is covered by one of the Executive Orders and a classification considered necessary for performance of work on the contract does not appear on this wage determination, the contractor must still submit a conformance request.

Additional information on contractor requirements and worker protections under the Executive Orders is available at <https://www.dol.gov/agencies/whd/government-contracts>.

Modification Number	Publication Date
0	01/07/2022
1	01/14/2022
2	02/11/2022
3	02/18/2022
4	02/25/2022
5	05/06/2022

BRIN0004-002 06/01/2021

BALLARD, BUTLER, CALDWELL, CARLISLE, CRITTENDEN, DAVIESS, EDMONSON, FULTON, GRAVES, HANCOCK, HENDERSON, HICKMAN, HOPKINS, LIVINGSTON, LYON, MARSHALL, MCCRACKEN, MCLEAN, MUHLENBERG, OHIO, UNION, and WEBSTER COUNTIES

	Rates	Fringes
BRICKLAYER		
Ballard, Caldwell, Carlisle, Crittenden, Fulton, Graves, Hickman, Livingston, Lyon, Marshall, and McCracken Counties.....	\$ 30.50	15.16
Butler, Edmonson, Hopkins, Muhlenberg, and Ohio Counties.....	\$ 26.80	12.38
Daviess, Hancock, Henderson, McLean, Union, and Webster Counties.....	\$ 29.57	14.75

 BRTN0004-005 06/01/2021

ALLEN, CALLOWAY, CHRISTIAN, LOGAN, SIMPSON, TODD, TRIGG, and WARREN COUNTIES

	Rates	Fringes
BRICKLAYER.....	\$ 29.75	14.75

 * CARP0357-002 04/01/2022

	Rates	Fringes
CARPENTER.....	\$ 30.84	22.15
DIVER.....	\$ 46.64	22.15
PILEDRIVERMAN.....	\$ 31.09	22.15

 ELEC0369-006 05/31/2021

BUTLER, EDMONSON, LOGAN, TODD & WARREN COUNTIES:

	Rates	Fringes
ELECTRICIAN.....	\$ 33.85	18.72

 ELEC0429-001 01/01/2020

ALLEN & SIMPSON COUNTIES:

	Rates	Fringes
ELECTRICIAN.....	\$ 27.72	13.48

ELEC0816-002 06/01/2021		

BALLARD, CALDWELL, CALLOWAY, CARLISLE, CHRISTIAN, CRITTENDEN,
 FULTON (Except a 5 mile radius of City Hall in Fulton), GRAVES,
 HICKMAN, LIVINGSTON, LYON, MARSHALL, MCCrackEN & TRIGG COUNTIES:

	Rates	Fringes
ELECTRICIAN.....	\$ 34.48	26.5%+7.25

ELEC1701-003 06/01/2021		

Cable spicers receive \$.25 per hour additional.

DAVISS, HANCOCK, HENDERSON, HOPKINS, MCLEAN, MUHLENBERG, OHIO,
 UNION & WEBSTER COUNTIES:

	Rates	Fringes
ELECTRICIAN.....	\$ 33.30	28.8%+\$7.25

ELEC1925-002 01/01/2022		

Cable spicers receive \$.25 per hour additional.

FULTON COUNTY (Up to a 5 mile radius of City Hall in Fulton):

	Rates	Fringes
CABLE SPLICER.....	\$ 26.85	14.81
ELECTRICIAN.....	\$ 26.35	14.79

ENGI0181-017 07/01/2021		

	Rates	Fringes
POWER EQUIPMENT OPERATOR		
GROUP 1.....	\$ 34.80	17.85
GROUP 2.....	\$ 31.94	17.85
GROUP 3.....	\$ 32.39	17.85
GROUP 4.....	\$ 31.62	17.85

OPERATING ENGINEER CLASSIFICATIONS

GROUP 1 - A-Frame Winch Truck; Auto Patrol; Backfiller;
 Batcher Plant; Bituminous Paver; Bituminous Transfer
 Machine; Boom Cat; Bulldozer; Mechanic; Cableway; Carry-All
 Scoop; Carry Deck Crane; Central Compressor Plant; Cherry
 Picker; Clamshell; Concrete Mixer (21 cu. ft. or Over);
 Concrete Paver; Truck-Mounted Concrete Pump; Core Drill;
 Crane; Crusher Plant; Derrick; Derrick Boat; Ditching &
 Trenching Machine; Dragline; Dredge Operator; Dredge
 Engineer; Elevating Grader & Loaders; Grade-All; Gurries;
 Heavy Equipment Robotics Operator/Mechanic; High Lift;
 Hoe-Type Machine; Hoist (Two or More Drums); Hoisting
 Engine (Two or More Drums); Horizontal Directional Drill

Operator; Hydrocrane; Hyster; KeCal Loader; LeTourneau;
Locomotive; Mechanic; Mechanically Operated Laser Screed;
Mechanic Welder; Mucking Machine; Motor Scraper; Orangepeel
Bucket; Overhead Crane; Piledriver; Power Blade; Pumpcrete;
Push Dozer; Rock Spreader, attached to equipment; Rotary
Drill; Roller (Bituminous); Rough Terrain Crane; Scarifier;
Scoopmobile; Shovel; Side Boom; Subgrader; Tailboom;
Telescoping Type Forklift; Tow or Push Boat; Tower Crane
(French, German & other types); Tractor Shovel; Truck
Crane; Tunnel Mining Machines, including Moles, Shields or
similar types of Tunnel Mining Equipment

GROUP 2 - Air Compressor (Over 900 cu. ft. per min.);
Bituminous Mixer; Boom Type Tamping Machine; Bull Float;
Concrete Mixer (Under 21 cu. ft.); Dredge Engineer;
Electric Vibrator; Compactor/Self-Propelled Compactor;
Elevator (One Drum or Buck Hoist); Elevator (When used to
Hoist Building Material); Finish Machine; Firemen & Hoist
(One Drum); Flexplane; Forklift (Regardless of Lift
Height); Form Grader; Joint Sealing Machine; Outboard Motor
Boat; Power Sweeper (Riding Type); Roller (Rock); Ross
Carrier; Skid Mounted or Trailer Mounted Concrete Pump; Skid
Steer Machine with all Attachments; Switchman or Brakeman;
Throttle Valve Person; Tractair & Road Widening Trencher;
Tractor (50 H.P. or Over); Truck Crane Oiler; Tugger;
Welding Machine; Well Points;& Whirley Oiler

GROUP 3 -All Off Road Material Handling Equipment, including
Articulating Dump Trucks; Greaser on Grease Facilities
servicing Heavy Equipment

GROUP 4 - Bituminous Distributor; Burlap & Curing Machine;
Cement Gun; Concrete Saw; Conveyor; Deckhand Oiler; Grout
Pump; Hydraulic Post Driver; Hydro Seeder; Mud Jack; Oiler;
Paving Joint Machine; Power Form Handling Equipment; Pump;
Roller (Earth); Steerman; Tamping Machine; Tractor (Under
50 H.P.); & Vibrator

CRANES - with booms 150 ft. & Over (Including JIB), and where
the length of the boom in combination with the length of
the piling equals or exceeds 150 ft. - \$1.00 above Group 1
rate

EMPLOYEES ASSIGNED TO WORK BELOW GROUND LEVEL ARE TO BE PAID
10% ABOVE BASIC WAGE RATE. THIS DOES NOT APPLY TO OPEN CUT
WORK.

IRON0070-005 06/01/2021

BUTLER COUNTY (Eastern eighth, including the Townships of
Decker, Lee & Tilford);
EDMONSON COUNTY (Northern three-fourths, including the
Townships of Asphalt, Bee Spring, Brownsville, Grassland, Huff,
Kyrock, Lindseyville, Mammoth Cave, Ollie, Prosperity, Rhoda,
Sunfish & Sweden)

Rates Fringes

IRONWORKER

Structural; Ornamental;		
Reinforcing; Precast		
Concrete Erectors.....	\$ 31.09	23.75

IRON0103-004 08/01/2021

DAVISS, HANCOCK, HENDERSON, HOPKINS, MCLEAN, OHIO, UNION & WEBSTER COUNTIES
 BUTLER COUNTY (Townships of Aberdeen, Bancock, Casey, Dexterville, Dunbar, Elfie, Gilstrap, Huntsville, Logansport, Monford, Morgantown, Provo, Rochester, South Hill & Welchs Creek);
 CALDWELL COUNTY (Northeastern third, including the Township of Creswell);
 CHRISTIAN COUNTY (Northern third, including the Townships of Apex, Crofton, Kelly, Mannington & Wynns);
 CRITTENDEN COUNTY (Northeastern half, including the Townships of Grove, Mattoon, Repton, Shady Grove & Tribune);
 MUHLENBERG COUNTY (Townships of Bavier, Beech Creek Junction, Benton, Brennen, Browder, Central City, Cleaton, Depoy, Drakesboro, Eunis, Graham, Hillside, Luzerne, Lynn City, Martwick, McNary, Millport, Moorman, Nelson, Paradise, Powderly, South Carrollton, Tarina & Weir)

	Rates	Fringes
Ironworkers:.....	\$ 30.00	25.29

IRON0492-003 05/01/2021

ALLEN, LOGAN, SIMPSON, TODD & WARREN COUNTIES
 BUTLER COUNTY (Southern third, including the Townships of Boston, Berrys Lick, Dimple, Jetson, Quality, Sharer, Sugar Grove & Woodbury);
 CHRISTIAN COUNTY (Eastern two-thirds, including the Townships of Bennettstown, Casky, Herndon, Hopkinsville, Howell, Masonville, Pembroke & Thompsonville);
 EDMONSON COUNTY (Southern fourth, including the Townships of Chalybeate & Rocky Hill);
 MUHLENBERG COUNTY (Southern eighth, including the Townships of Dunnior, Penrod & Rosewood)

	Rates	Fringes
Ironworkers:.....	\$ 30.35	15.36

IRON0782-006 08/01/2021

BALLARD, CALLOWAY, CARLISLE, FULTON, GRAVES, HICKMAN, LIVINGSTON, LYON, MARSHALL, MCCRACKEN & TRIGG COUNTIES
 CALDWELL COUNTY (Southwestern two-thirds, including the Townships of Cedar Bluff, Cider, Claxton, Cobb, Crowtown, Dulaney, Farmersville, Fredonia, McGowan, Otter Pond & Princeton);
 CHRISTIAN COUNTY (Western third, Excluding the Townships of Apex, Crofton, Kelly, Mannington, Wynns, Bennettstown, Casky, Herndon, Hopkinsville, Howell, Masonville, Pembroke & Thompsonville);
 CRITTENDEN COUNTY (Southwestern half, including the Townships of Crayne, Dycusburg, Frances, Marion, Mexico, Midway, Sheridan & Told)

	Rates	Fringes
Ironworkers:		
Projects with a total		

contract cost of		
\$20,000,000.00 or above.....\$	30.83	25.52
All Other Work.....\$	29.24	23.22

 LAB00189-005 07/01/2021

BALLARD, CALLOWAY, CARLISLE, FULTON, GRAVES, HICKMAN,
 LIVINGSTON, LYON, MARSHALL & MCCRACKEN COUNTIES

	Rates	Fringes
Laborers:		
GROUP 1.....\$	23.51	16.22
GROUP 2.....\$	23.76	16.22
GROUP 3.....\$	23.81	16.22
GROUP 4.....\$	24.41	16.22

LABORER CLASSIFICATIONS

GROUP 1 - Aging & Curing of Concrete; Asbestos Abatement Worker; Asphalt Plant; Asphalt; Batch Truck Dump; Carpenter Tender; Cement Mason Tender; Cleaning of Machines; Concrete; Demolition; Dredging; Environmental - Nuclear, Radiation, Toxic & Hazardous Waste - Level D; Flagperson; Grade Checker; Hand Digging & Hand Back Filling; Highway Marker Placer; Landscaping, Mesh Handler & Placer; Puddler; Railroad; Rip-rap & Grouter; Right-of-Way; Sign, Guard Rail & Fence Installer; Signal Person; Sound Barrier Installer; Storm & Sanitary Sewer; Swamper; Truck Spotter & Dumper; Wrecking of Concrete Forms; General Cleanup

GROUP 2 - Batter Board Man (Sanitary & Storm Sewer); Brickmason Tender; Mortar Mixer Operator; Scaffold Builder; Burner & Welder; Bushhammer; Chain Saw Operator; Concrete Saw Operator; Deckhand Scow Man; Dry Cement Handler; Environmental - Nuclear, Radiation, Toxic & Hazardous Waste - Level C; Forklift Operator for Masonary; Form Setter; Green Concrete Cutting; Hand Operated Grouter & Grinder Machine Operator; Jackhammer; Pavement Breaker; Paving Joint Machine; Pipelayer; Plastic Pipe Fusion; Power Driven Georgia Buggy & Wheel Barrow; Power Post Hole Digger; Precast Manhole Setter; Walk-Behind Tamper; Walk-Behind Trencher; Sand Blaster; Concrete Chipper; Surface Grinder; Vibrator Operator; Wagon Driller

GROUP 3 - Asphalt Luteman & Raker; Gunnite Nozzleman; Gunnite Operator & Mixer; Grout Pump Operator; Blaster; Side Rail Setter; Rail Paved Ditches; Screw Operator; Tunnel (Free Air); Water Blaster

GROUP 4 - Caisson Worker (Free Air); Cement Finisher; Environmental - Nuclear, Radiation, Toxic & Hazardous Waste - Levels A & B; Miner & Driller (Free Air); Tunnel Blaster; & Tunnel Mucker (Free Air); Directional & Horizontal Boring; Air Track Drillers (All Types); Powdermen & Blasters; Troxler & Concrete Tester if Laborer is Utilized

 LAB00189-006 07/01/2021

ALLEN, BUTLER, CALDWELL, CHRISTIAN, DAVIESS, EDMONSON, HANCOCK,
 HOPKINS, LOGAN, MCLEAN, MUHLENBERG, OHIO, SIMPSON, TODD, TRIGG
 & WARREN COUNTIES

	Rates	Fringes
Laborers:		
GROUP 1.....	\$ 23.51	16.22
GROUP 2.....	\$ 23.76	16.22
GROUP 3.....	\$ 23.81	16.22
GROUP 4.....	\$ 24.41	16.22

LABORER CLASSIFICATIONS

GROUP 1 - Aging & Curing of Concrete; Asbestos Abatement Worker; Asphalt Plant; Asphalt; Batch Truck Dump; Carpenter Tender; Cement Mason Tender; Cleaning of Machines; Concrete; Demolition; Dredging; Environmental - Nuclear, Radiation, Toxic & Hazardous Waste - Level D; Flagperson; Grade Checker; Hand Digging & Hand Back Filling; Highway Marker Placer; Landscaping, Mesh Handler & Placer; Puddler; Railroad; Rip-rap & Grouter; Right-of-Way; Sign, Guard Rail & Fence Installer; Signal Person; Sound Barrier Installer; Storm & Sanitary Sewer; Swamper; Truck Spotter & Dumper; Wrecking of Concrete Forms; General Cleanup

GROUP 2 - Batter Board Man (Sanitary & Storm Sewer); Brickmason Tender; Mortar Mixer Operator; Scaffold Builder; Burner & Welder; Bushhammer; Chain Saw Operator; Concrete Saw Operator; Deckhand Scow Man; Dry Cement Handler; Environmental - Nuclear, Radiation, Toxic & Hazardous Waste - Level C; Forklift Operator for Masonary; Form Setter; Green Concrete Cutting; Hand Operated Grouter & Grinder Machine Operator; Jackhammer; Pavement Breaker; Paving Joint Machine; Pipelayer; Plastic Pipe Fusion; Power Driven Georgia Buggy & Wheel Barrow; Power Post Hole Digger; Precast Manhole Setter; Walk-Behind Tamper; Walk-Behind Trencher; Sand Blaster; Concrete Chipper; Surface Grinder; Vibrator Operator; Wagon Driller

GROUP 3 - Asphalt Luteman & Raker; Gunnite Nozzleman; Gunnite Operator & Mixer; Grout Pump Operator; Blaster; Side Rail Setter; Rail Paved Ditches; Screw Operator; Tunnel (Free Air); Water Blaster

GROUP 4 - Caisson Worker (Free Air); Cement Finisher; Environmental - Nuclear, Radiation, Toxic & Hazardous Waste - Levels A & B; Miner & Driller (Free Air); Tunnel Blaster; & Tunnel Mucker (Free Air); Directional & Horizontal Boring; Air Track Drillers (All Types); Powdermen & Blasters; Troxler & Concrete Tester if Laborer is Utilized

 LAB00561-001 07/01/2021

CRITTENDEN, HENDERSON, UNION & WEBSTER COUNTIES

	Rates	Fringes
Laborers:		
GROUP 1.....	\$ 24.01	16.60
GROUP 2.....	\$ 24.26	16.60
GROUP 3.....	\$ 24.31	16.60
GROUP 4.....	\$ 24.91	16.60

LABORER CLASSIFICATIONS

GROUP 1 - Aging & Curing of Concrete; Asbestos Abatement

Worker; Asphalt Plant; Asphalt; Batch Truck Dump; Carpenter Tender; Cement Mason Tender; Cleaning of Machines; Concrete; Demolition; Dredging; Environmental - Nuclear, Radiation, Toxic & Hazardous Waste - Level D; Flagperson; Grade Checker; Hand Digging & Hand Back Filling; Highway Marker Placer; Landscaping, Mesh Handler & Placer; Puddler; Railroad; Rip-rap & Grouter; Right-of-Way; Sign, Guard Rail & Fence Installer; Signal Person; Sound Barrier Installer; Storm & Sanitary Sewer; Swamper; Truck Spotter & Dumper; Wrecking of Concrete Forms; General Cleanup

GROUP 2 - Batter Board Man (Sanitary & Storm Sewer); Brickmason Tender; Mortar Mixer Operator; Scaffold Builder; Burner & Welder; Bushhammer; Chain Saw Operator; Concrete Saw Operator; Deckhand Scow Man; Dry Cement Handler; Environmental - Nuclear, Radiation, Toxic & Hazardous Waste - Level C; Forklift Operator for Masonary; Form Setter; Green Concrete Cutting; Hand Operated Grouter & Grinder Machine Operator; Jackhammer; Pavement Breaker; Paving Joint Machine; Pipelayer; Plastic Pipe Fusion; Power Driven Georgia Buggy & Wheel Barrow; Power Post Hole Digger; Precast Manhole Setter; Walk-Behind Tamper; Walk-Behind Trencher; Sand Blaster; Concrete Chipper; Surface Grinder; Vibrator Operator; Wagon Driller

GROUP 3 - Asphalt Luteman & Raker; Gunnite Nozzleman; Gunnite Operator & Mixer; Grout Pump Operator; Blaster; Side Rail Setter; Rail Paved Ditches; Screw Operator; Tunnel (Free Air); Water Blaster

GROUP 4 - Caisson Worker (Free Air); Cement Finisher; Environmental - Nuclear, Radiation, Toxic & Hazardous Waste - Levels A & B; Miner & Driller (Free Air); Tunnel Blaster; & Tunnel Mucker (Free Air); Directional & Horizontal Boring; Air Track Drillers (All Types); Powdermen & Blasters; Troxler & Concrete Tester if Laborer is Utilized

 PAIN0032-002 09/01/2020

BALLARD COUNTY

	Rates	Fringes
Painters:		
Bridges.....	\$ 35.01	17.93
All Other Work.....	\$ 32.71	17.93
Spray, Blast, Steam, High & Hazardous (Including Lead Abatement) and All Epoxy - \$1.00 Premium		

 PAIN0118-003 06/01/2014

EDMONSON COUNTY:

	Rates	Fringes
Painters:		
Brush & Roller.....	\$ 18.50	11.97
Spray, Sandblast, Power Tools, Waterblast & Steam Cleaning.....	\$ 19.50	11.97

 * PAIN0156-006 04/01/2022

DAVIESS, HANCOCK, HENDERSON, MCLEAN, OHIO, UNION & WEBSTER
 COUNTIES

	Rates	Fringes
Painters:		
BRIDGES		
GROUP 1.....	\$ 28.45	18.98
GROUP 3.....	\$ 29.45	18.98
GROUP 4.....	\$ 30.70	18.98
ALL OTHER WORK:		
GROUP 1.....	\$ 27.30	18.98
GROUP 2.....	\$ 27.55	18.98
GROUP 3.....	\$ 28.30	18.98
GROUP 4.....	\$ 29.55	18.98

PAINTER CLASSIFICATIONS

GROUP 1 - Brush & Roller

GROUP 2 - Plasterers

GROUP 3 - Spray; Sandblast; Power Tools; Waterblast;
 Steamcleaning; Brush & Roller of Mastics, Creosotes, Kwinch
 Koate & Coal Tar Epoxy

GROUP 4 - Spray of Mastics, Creosotes, Kwinch Koate & Coal
 Tar Epoxy

 PAIN0500-002 06/01/2020

CALDWELL, CALLOWAY, CARLISLE, CHRISTIAN, CRITTENDEN, FULTON,
 GRAVES, HICKMAN, HOPKINS, LIVINGSTON, LYON, MARSHALL, MCCRACKEN
 & TRIGG COUNTIES:

	Rates	Fringes
Painters:		
Bridges.....	\$ 27.75	15.10
All Other Work.....	\$ 21.50	15.10

Waterblasting units with 3500 PSI and above - \$.50 premium
 Spraypainting and all abrasive blasting - \$1.00 premium
 Work 40 ft. and above ground level - \$1.00 premium

 PLUM0184-002 07/01/2021

BALLARD, CALDWELL, CALLOWAY, CARLISLE, CHRISTIAN, CRITTENDEN,
 FULTON, GRAVES, HICKMAN, LIVINGSTON, LYON, MARSHALL, MCCRACKEN
 and TRIGG COUNTIES

	Rates	Fringes
Plumber; Steamfitter.....	\$ 37.16	19.03

 PLUM0502-004 08/01/2021

ALLEN, BUTLER, EDMONSON, SIMPSON & WARREN

	Rates	Fringes
Plumber; Steamfitter.....	\$ 38.07	20.78

PLUM0633-002 07/01/2021		

DAVISS, HANCOCK, HENDERSON, HOPKINS, LOGAN, MCLEAN,
 MUHLENBERG, OHIO, TODD, UNION & WEBSTER COUNTIES:

	Rates	Fringes
PLUMBER/PIPEFITTER.....	\$ 33.17	19.30

TEAM0089-003 04/01/2020		

ALLEN, BUTLER, EDMONSON, LOGAN, SIMPSON & WARREN COUNTIES

	Rates	Fringes
Truck drivers:		
Zone 1:		
Group 1.....	\$ 20.82	23.49
Group 2.....	\$ 21.00	23.49
Group 3.....	\$ 21.08	23.49
Group 4.....	\$ 21.10	23.49

GROUP 1 - Greaser; Tire Changer

GROUP 2 - Truck Mechanic; Single Axle Dump; Flat Bed; All Terrain Vehicles when used to haul materials; Semi Trailer or Pole Trailer when used to pull building materials and equipment; Tandem Axle Dump; Driver of Distributors

GROUP 3 - Mixer All Types

GROUP 4 - Winch and A-Frame when used in transporting materials; Ross Carrier; Fork Lift when used to transport building materials; Driver on Pavement Breaker; Euclid and Other Heavy Earth Moving Equipment; Low Boy; Articulator Cat; Five Axle Vehicle

TEAM0215-003 04/01/2020		

DAVISS, HANCOCK, HENDERSON, HOPKINS, MCLEAN, MUHLENBERG, OHIO & WEBSTER COUNTIES

	Rates	Fringes
TRUCK DRIVER		
Group 1.....	\$ 22.45	23.49
Group 2.....	\$ 22.68	23.49
Group 3.....	\$ 22.75	23.49
Group 4.....	\$ 22.76	23.49

GROUP 1: Greaser, Tire Changer

GROUP 2: Truck Mechanic

GROUP 3: Single Axle Dump; Flat Bed; All Terrain Vehicle when used to haul materials; Semi Trailer or Pole Trailer when used to pull building materials and equipment; Tandem Axle Dump; Driver of Distributors; Mixer All Types

GROUP 4: Euclid and other heavy earth moving equipment; Low Boy; Articulator Cat; 5 Axle Vehicle; Winch and A- Frame when used in transporting materials; Ross Carrier; Fork Lift when used to transport building materials; Driver on Pavement Breaker

TEAM0236-001 04/01/2020

BALLARD, CALDWELL, CALLOWAY, CARLISLE, CHRISTIAN, CRITTENDEN, FULTON, GRAVES, HICKMAN, LIVINGSTON, LYON, MARSHALL, MCCracken, TODD & TRIGG COUNTIES

	Rates	Fringes
TRUCK DRIVER		
Group 1.....	\$ 20.82	23.49
Group 2.....	\$ 21.00	23.49
Group 3.....	\$ 21.00	23.49
Group 4.....	\$ 21.00	23.49
Group 5.....	\$ 21.08	23.49

GROUP 1: Greaser, Tire Changer

GROUP 2: Truck Mechanic

GROUP 3: Single Axle Dump; Flat Bed; All Terrain Vehicle when used to haul materials; Semi Trailer or Pole Trailer when used to pull building materials and equipment; Tandem Axle Dump; Drivers of Distributors

GROUP 4: Euclid and other heavy earth moving equipment; Low Boy; Articulator Cat; Five Axle Vehicle; Winch and A-Frame when used in transporting materials; Ross Carrier

GROUP 5: Mixer All Types

WELDERS - Receive rate prescribed for craft performing operation to which welding is incidental.

=====

Note: Executive Order (EO) 13706, Establishing Paid Sick Leave for Federal Contractors applies to all contracts subject to the Davis-Bacon Act for which the contract is awarded (and any solicitation was issued) on or after January 1, 2017. If this contract is covered by the EO, the contractor must provide employees with 1 hour of paid sick leave for every 30 hours they work, up to 56 hours of paid sick leave each year. Employees must be permitted to use paid sick leave for their own illness, injury or other health-related needs, including preventive care; to assist a family member (or person who is like family to the employee) who is ill, injured, or has other health-related needs, including preventive care; or for reasons resulting from, or to assist a family member (or person who is like family to the employee) who is a victim of, domestic violence, sexual assault, or stalking. Additional information on contractor requirements and worker protections under the EO is available at <https://www.dol.gov/agencies/whd/government-contracts>.

Unlisted classifications needed for work not included within the scope of the classifications listed may be added after award only as provided in the labor standards contract clauses (29CFR 5.5 (a) (1) (ii)).

The body of each wage determination lists the classification and wage rates that have been found to be prevailing for the cited type(s) of construction in the area covered by the wage determination. The classifications are listed in alphabetical order of ""identifiers"" that indicate whether the particular rate is a union rate (current union negotiated rate for local), a survey rate (weighted average rate) or a union average rate (weighted union average rate).

Union Rate Identifiers

A four letter classification abbreviation identifier enclosed in dotted lines beginning with characters other than ""SU"" or ""UAVG"" denotes that the union classification and rate were prevailing for that classification in the survey. Example: PLUM0198-005 07/01/2014. PLUM is an abbreviation identifier of the union which prevailed in the survey for this classification, which in this example would be Plumbers. 0198 indicates the local union number or district council number where applicable, i.e., Plumbers Local 0198. The next number, 005 in the example, is an internal number used in processing the wage determination. 07/01/2014 is the effective date of the most current negotiated rate, which in this example is July 1, 2014.

Union prevailing wage rates are updated to reflect all rate changes in the collective bargaining agreement (CBA) governing this classification and rate.

Survey Rate Identifiers

Classifications listed under the ""SU"" identifier indicate that no one rate prevailed for this classification in the survey and the published rate is derived by computing a weighted average rate based on all the rates reported in the survey for that classification. As this weighted average rate includes all rates reported in the survey, it may include both union and non-union rates. Example: SULA2012-007 5/13/2014. SU indicates the rates are survey rates based on a weighted average calculation of rates and are not majority rates. LA indicates the State of Louisiana. 2012 is the year of survey on which these classifications and rates are based. The next number, 007 in the example, is an internal number used in producing the wage determination. 5/13/2014 indicates the survey completion date for the classifications and rates under that identifier.

Survey wage rates are not updated and remain in effect until a new survey is conducted.

Union Average Rate Identifiers

Classification(s) listed under the UAVG identifier indicate that no single majority rate prevailed for those classifications; however, 100% of the data reported for the classifications was union data. EXAMPLE: UAVG-OH-0010 08/29/2014. UAVG indicates that the rate is a weighted union

average rate. OH indicates the state. The next number, 0010 in the example, is an internal number used in producing the wage determination. 08/29/2014 indicates the survey completion date for the classifications and rates under that identifier.

A UAVG rate will be updated once a year, usually in January of each year, to reflect a weighted average of the current negotiated/CBA rate of the union locals from which the rate is based.

WAGE DETERMINATION APPEALS PROCESS

1.) Has there been an initial decision in the matter? This can be:

- * an existing published wage determination
- * a survey underlying a wage determination
- * a Wage and Hour Division letter setting forth a position on a wage determination matter
- * a conformance (additional classification and rate) ruling

On survey related matters, initial contact, including requests for summaries of surveys, should be with the Wage and Hour National Office because National Office has responsibility for the Davis-Bacon survey program. If the response from this initial contact is not satisfactory, then the process described in 2.) and 3.) should be followed.

With regard to any other matter not yet ripe for the formal process described here, initial contact should be with the Branch of Construction Wage Determinations. Write to:

Branch of Construction Wage Determinations
Wage and Hour Division
U.S. Department of Labor
200 Constitution Avenue, N.W.
Washington, DC 20210

2.) If the answer to the question in 1.) is yes, then an interested party (those affected by the action) can request review and reconsideration from the Wage and Hour Administrator (See 29 CFR Part 1.8 and 29 CFR Part 7). Write to:

Wage and Hour Administrator
U.S. Department of Labor
200 Constitution Avenue, N.W.
Washington, DC 20210

The request should be accompanied by a full statement of the interested party's position and by any information (wage payment data, project description, area practice material, etc.) that the requestor considers relevant to the issue.

3.) If the decision of the Administrator is not favorable, an interested party may appeal directly to the Administrative Review Board (formerly the Wage Appeals Board). Write to:

Administrative Review Board
U.S. Department of Labor
200 Constitution Avenue, N.W.
Washington, DC 20210

4.) All decisions by the Administrative Review Board are final.

=====

END OF GENERAL DECISIO"

Fringe benefit amounts are applicable for all hours worked except when otherwise noted.

No laborer, workman or mechanic shall be paid at a rate less than that of a Journeyman except those classified as bona fide apprentices.

Apprentices or trainees shall be permitted to work as such subject to Administrative Regulations adopted by the Commissioner of Workplace Standards. Copies of these regulations will be furnished upon request from any interested person.

Before using apprentices on the job the contractor shall present to the Contracting Officer written evidence of registration of such employees in a program of a State apprenticeship and training agency approved and recognized by the U. S. Bureau of Apprenticeship and Training. In the absence of such a State agency, the contractor shall submit evidence of approval and registration by the U. S. Bureau of Apprenticeship and Training.

The contractor shall submit to the Contracting Officer, written evidence of the established apprenticeship-journeyman ratios and wage rates in the project area, which will be the basis for establishing such ratios and rates for the project under the applicable contract provisions.

TO: EMPLOYERS/EMPLOYEES

PREVAILING WAGE SCHEDULE:

The wages indicated on this wage schedule are the least permitted to be paid for the occupations indicated. When an employee works in more than one classification, the employer must record the number of hours worked in each classification at the prescribed hourly base rate.

OVERTIME:

Overtime is to be paid to an employee at a rate not less than one and one-half times the basic rate of pay for all hours worked in excess of forty (40) hours in such workweek. Wage violations or questions should be directed to the designated Engineer or the undersigned.

Director
Division of Construction Procurement
Frankfort, Kentucky 40622
502-564-3500

**NOTICE OF REQUIREMENT FOR AFFIRMATIVE ACTION
TO ENSURE EQUAL EMPLOYMENT OPPORTUNITY
(Executive Order 11246)**

1. The Offeror's or Bidder's attention is called to the "Equal Opportunity Clause" and the "Standard Federal Equal Employment Specifications" set forth herein.
2. The goals and timetables for minority and female participation, expressed in percentage terms for the Contractor's aggregate work force in each trade on all construction work in the covered area, are as follows:

GOALS FOR MINORITY PARTICIPATION IN EACH TRADE	GOALS FOR FEMALE PARTICIPATION IN EACH TRADE
5.2%	6.9%

These goals are applicable to all the Contractor's construction work (whether or not it is Federal or federally-assisted) performed in the covered area. If the contractor performs construction work in a geographical area located outside of the covered area, it shall apply the goals established for such geographical area where the work is actually performed. With regard to this second area, the contractor also is subject to the goals for both its federally involved and non-federally involved construction.

The Contractor's compliance with the Executive Order and the regulations in CFR Part 60-4 shall be based on its implementation of the Equal Opportunity Clause, specific affirmative action obligations required by the specifications set forth in 41 CFR 60-4, 3(a), and its efforts to meet the goals. The hours of minority and female employment and training must be substantially uniform throughout the length of the contract, and in each trade, and the contractor shall make a good faith effort to employ minorities and women evenly on each of its projects. The transfer of minority or female employees or trainees from Contractor to Contractor or from project to project for the sole purpose of meeting the Contractor's goals shall be a violation of the contract, the Executive Order and the regulations in 41 CFR Part 60-4. Compliance with the goals will be measured against the total work hours performed.

3. The Contractor shall provide written notification to the Director of the Office of Federal Contract Compliance Programs within ten (10) working days of award of any construction subcontract in excess of \$10,000.00 at any tier for construction work under the contract resulting from this solicitation. The notification shall list the name, address and telephone number of the subcontractor; employer identification number of the subcontractor; estimated dollar amount of the subcontract; estimated starting and completion dates of the subcontract; and the geographical area in which the subcontract is to be performed. The notification shall be mailed to:

**Evelyn Teague, Regional Director
Office of Federal Contract Compliance Programs
61 Forsyth Street, SW, Suite 7B75
Atlanta, Georgia 30303-8609**

4. As used in this Notice, and in the contract resulting from this solicitation, the "**covered area**" is Calloway County.

**NOTICE OF REQUIREMENT FOR AFFIRMATIVE ACTION
TO ENSURE EQUAL EMPLOYMENT OPPORTUNITY
(Executive Order 11246)**

1. The Offeror's or Bidder's attention is called to the "Equal Opportunity Clause" and the "Standard Federal Equal Employment Specifications" set forth herein.
2. The goals and timetables for minority and female participation, expressed in percentage terms for the Contractor's aggregate work force in each trade on all construction work in the covered area, are as follows:

GOALS FOR MINORITY PARTICIPATION IN EACH TRADE	GOALS FOR FEMALE PARTICIPATION IN EACH TRADE
5.2%	6.9%

These goals are applicable to all the Contractor's construction work (whether or not it is Federal or federally-assisted) performed in the covered area. If the contractor performs construction work in a geographical area located outside of the covered area, it shall apply the goals established for such geographical area where the work is actually performed. With regard to this second area, the contractor also is subject to the goals for both its federally involved and non-federally involved construction.

The Contractor's compliance with the Executive Order and the regulations in CFR Part 60-4 shall be based on its implementation of the Equal Opportunity Clause, specific affirmative action obligations required by the specifications set forth in 41 CFR 60-4, 3(a), and its efforts to meet the goals. The hours of minority and female employment and training must be substantially uniform throughout the length of the contract, and in each trade, and the contractor shall make a good faith effort to employ minorities and women evenly on each of its projects. The transfer of minority or female employees or trainees from Contractor to Contractor or from project to project for the sole purpose of meeting the Contractor's goals shall be a violation of the contract, the Executive Order and the regulations in 41 CFR Part 60-4. Compliance with the goals will be measured against the total work hours performed.

3. The Contractor shall provide written notification to the Director of the Office of Federal Contract Compliance Programs within ten (10) working days of award of any construction subcontract in excess of \$10,000.00 at any tier for construction work under the contract resulting from this solicitation. The notification shall list the name, address and telephone number of the subcontractor; employer identification number of the subcontractor; estimated dollar amount of the subcontract; estimated starting and completion dates of the subcontract; and the geographical area in which the subcontract is to be performed. The notification shall be mailed to:

**Evelyn Teague, Regional Director
Office of Federal Contract Compliance Programs
61 Forsyth Street, SW, Suite 7B75
Atlanta, Georgia 30303-8609**

4. As used in this Notice, and in the contract resulting from this solicitation, the "**covered area**" is Graves County.

**NOTICE OF REQUIREMENT FOR AFFIRMATIVE ACTION
TO ENSURE EQUAL EMPLOYMENT OPPORTUNITY
(Executive Order 11246)**

1. The Offeror's or Bidder's attention is called to the "Equal Opportunity Clause" and the "Standard Federal Equal Employment Specifications" set forth herein.
2. The goals and timetables for minority and female participation, expressed in percentage terms for the Contractor's aggregate work force in each trade on all construction work in the covered area, are as follows:

GOALS FOR MINORITY PARTICIPATION IN EACH TRADE	GOALS FOR FEMALE PARTICIPATION IN EACH TRADE
5.2%	6.9%

These goals are applicable to all the Contractor's construction work (whether or not it is Federal or federally-assisted) performed in the covered area. If the contractor performs construction work in a geographical area located outside of the covered area, it shall apply the goals established for such geographical area where the work is actually performed. With regard to this second area, the contractor also is subject to the goals for both its federally involved and non-federally involved construction.

The Contractor's compliance with the Executive Order and the regulations in CFR Part 60-4 shall be based on its implementation of the Equal Opportunity Clause, specific affirmative action obligations required by the specifications set forth in 41 CFR 60-4, 3(a), and its efforts to meet the goals. The hours of minority and female employment and training must be substantially uniform throughout the length of the contract, and in each trade, and the contractor shall make a good faith effort to employ minorities and women evenly on each of its projects. The transfer of minority or female employees or trainees from Contractor to Contractor or from project to project for the sole purpose of meeting the Contractor's goals shall be a violation of the contract, the Executive Order and the regulations in 41 CFR Part 60-4. Compliance with the goals will be measured against the total work hours performed.

3. The Contractor shall provide written notification to the Director of the Office of Federal Contract Compliance Programs within ten (10) working days of award of any construction subcontract in excess of \$10,000.00 at any tier for construction work under the contract resulting from this solicitation. The notification shall list the name, address and telephone number of the subcontractor; employer identification number of the subcontractor; estimated dollar amount of the subcontract; estimated starting and completion dates of the subcontract; and the geographical area in which the subcontract is to be performed. The notification shall be mailed to:

**Evelyn Teague, Regional Director
Office of Federal Contract Compliance Programs
61 Forsyth Street, SW, Suite 7B75
Atlanta, Georgia 30303-8609**

4. As used in this Notice, and in the contract resulting from this solicitation, the "**covered area**" is McCracken County.

**NOTICE OF REQUIREMENT FOR AFFIRMATIVE ACTION
TO ENSURE EQUAL EMPLOYMENT OPPORTUNITY
(Executive Order 11246)**

1. The Offeror's or Bidder's attention is called to the "Equal Opportunity Clause" and the "Standard Federal Equal Employment Specifications" set forth herein.
2. The goals and timetables for minority and female participation, expressed in percentage terms for the Contractor's aggregate work force in each trade on all construction work in the covered area, are as follows:

GOALS FOR MINORITY PARTICIPATION IN EACH TRADE	GOALS FOR FEMALE PARTICIPATION IN EACH TRADE
5.2%	6.9%

These goals are applicable to all the Contractor's construction work (whether or not it is Federal or federally-assisted) performed in the covered area. If the contractor performs construction work in a geographical area located outside of the covered area, it shall apply the goals established for such geographical area where the work is actually performed. With regard to this second area, the contractor also is subject to the goals for both its federally involved and non-federally involved construction.

The Contractor's compliance with the Executive Order and the regulations in CFR Part 60-4 shall be based on its implementation of the Equal Opportunity Clause, specific affirmative action obligations required by the specifications set forth in 41 CFR 60-4, 3(a), and its efforts to meet the goals. The hours of minority and female employment and training must be substantially uniform throughout the length of the contract, and in each trade, and the contractor shall make a good faith effort to employ minorities and women evenly on each of its projects. The transfer of minority or female employees or trainees from Contractor to Contractor or from project to project for the sole purpose of meeting the Contractor's goals shall be a violation of the contract, the Executive Order and the regulations in 41 CFR Part 60-4. Compliance with the goals will be measured against the total work hours performed.

3. The Contractor shall provide written notification to the Director of the Office of Federal Contract Compliance Programs within ten (10) working days of award of any construction subcontract in excess of \$10,000.00 at any tier for construction work under the contract resulting from this solicitation. The notification shall list the name, address and telephone number of the subcontractor; employer identification number of the subcontractor; estimated dollar amount of the subcontract; estimated starting and completion dates of the subcontract; and the geographical area in which the subcontract is to be performed. The notification shall be mailed to:

**Evelyn Teague, Regional Director
Office of Federal Contract Compliance Programs
61 Forsyth Street, SW, Suite 7B75
Atlanta, Georgia 30303-8609**

4. As used in this Notice, and in the contract resulting from this solicitation, the "**covered area**" is Marshall County.

**NOTICE OF REQUIREMENT FOR AFFIRMATIVE ACTION
TO ENSURE EQUAL EMPLOYMENT OPPORTUNITY
(Executive Order 11246)**

1. The Offeror's or Bidder's attention is called to the "Equal Opportunity Clause" and the "Standard Federal Equal Employment Specifications" set forth herein.
2. The goals and timetables for minority and female participation, expressed in percentage terms for the Contractor's aggregate work force in each trade on all construction work in the covered area, are as follows:

GOALS FOR MINORITY PARTICIPATION IN EACH TRADE	GOALS FOR FEMALE PARTICIPATION IN EACH TRADE
12.0%	6.9%

These goals are applicable to all the Contractor's construction work (whether or not it is Federal or federally-assisted) performed in the covered area. If the contractor performs construction work in a geographical area located outside of the covered area, it shall apply the goals established for such geographical area where the work is actually performed. With regard to this second area, the contractor also is subject to the goals for both its federally involved and non-federally involved construction.

The Contractor's compliance with the Executive Order and the regulations in CFR Part 60-4 shall be based on its implementation of the Equal Opportunity Clause, specific affirmative action obligations required by the specifications set forth in 41 CFR 60-4, 3(a), and its efforts to meet the goals. The hours of minority and female employment and training must be substantially uniform throughout the length of the contract, and in each trade, and the contractor shall make a good faith effort to employ minorities and women evenly on each of its projects. The transfer of minority or female employees or trainees from Contractor to Contractor or from project to project for the sole purpose of meeting the Contractor's goals shall be a violation of the contract, the Executive Order and the regulations in 41 CFR Part 60-4. Compliance with the goals will be measured against the total work hours performed.

3. The Contractor shall provide written notification to the Director of the Office of Federal Contract Compliance Programs within ten (10) working days of award of any construction subcontract in excess of \$10,000.00 at any tier for construction work under the contract resulting from this solicitation. The notification shall list the name, address and telephone number of the subcontractor; employer identification number of the subcontractor; estimated dollar amount of the subcontract; estimated starting and completion dates of the subcontract; and the geographical area in which the subcontract is to be performed. The notification shall be mailed to:

**Evelyn Teague, Regional Director
Office of Federal Contract Compliance Programs
61 Forsyth Street, SW, Suite 7B75
Atlanta, Georgia 30303-8609**

4. As used in this Notice, and in the contract resulting from this solicitation, the "**covered area**" is Trigg County.

PART IV
INSURANCE

Refer to
Kentucky Standard Specifications for Road and Bridge Construction,
current edition

PART V
BID ITEMS

224316

PROPOSAL BID ITEMS

Page 1 of 1

Report Date 5/25/22

Section: 0001 - ROADWAY

LINE	BID CODE	ALT	DESCRIPTION	QUANTITY	UNIT	UNIT PRIC	FP	AMOUNT
0010	02650		MAINTAIN & CONTROL TRAFFIC (DISTRICT 1 PAVEMENT MARKERS)	1.00	LS		\$	
0020	06610		INLAID PAVEMENT MARKER-MW	1,635.00	EACH		\$	
0030	06612		INLAID PAVEMENT MARKER-BY	745.00	EACH		\$	
0040	06613		INLAID PAVEMENT MARKER-B W/R	4,410.00	EACH		\$	
0050	06614		INLAID PAVEMENT MARKER-B Y/R	33.00	EACH		\$	

Section: 0002 - DEMOBILIZATION

LINE	BID CODE	ALT	DESCRIPTION	QUANTITY	UNIT	UNIT PRIC	FP	AMOUNT
0060	02569		DEMOBILIZATION	1.00	LS		\$	