

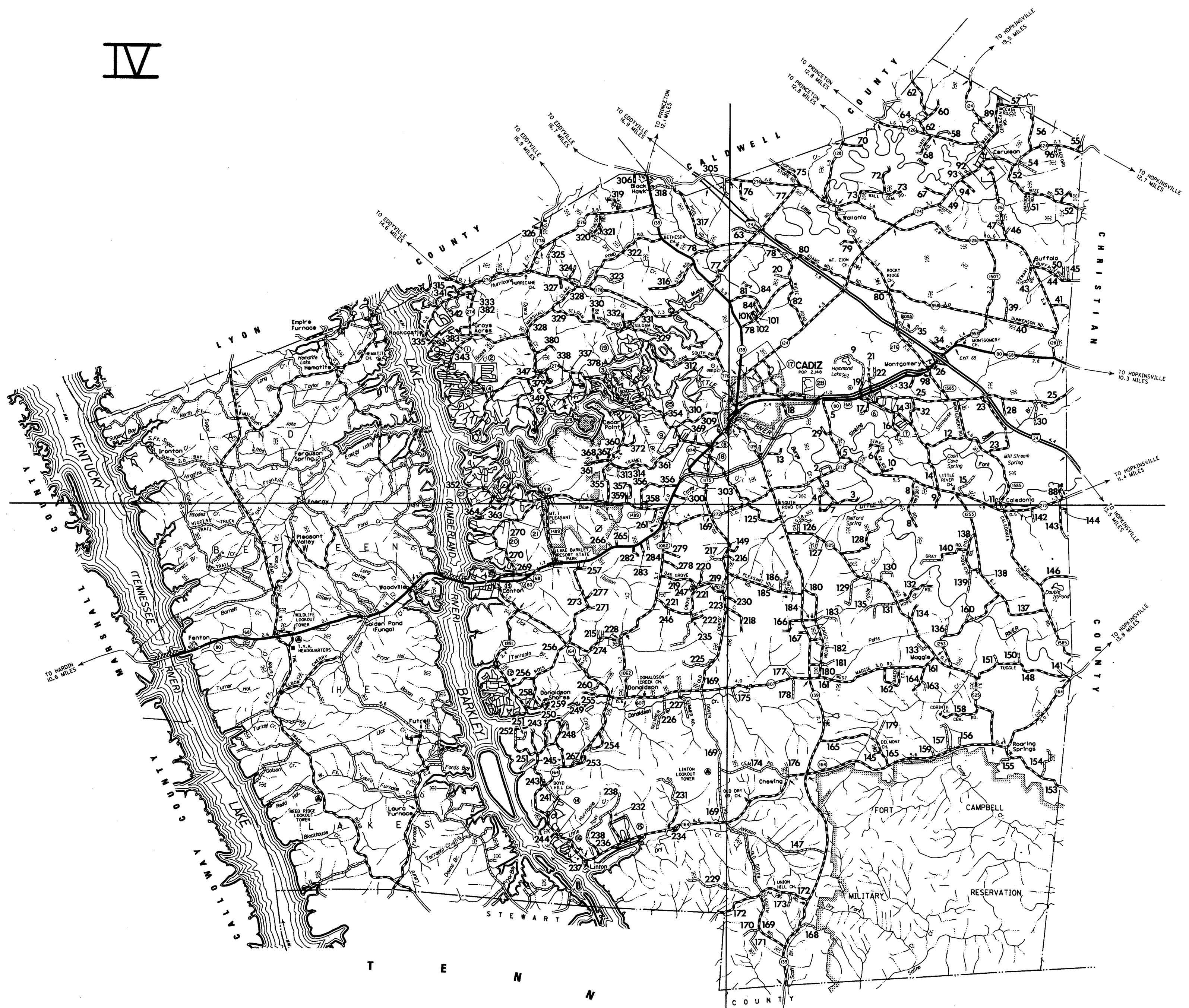

IV

I



SHEET I OF 4

1996

COUNTY ROAD SERIES MAP

TRIGG COUNTY

KENTUCKY

SCALE 1:25000

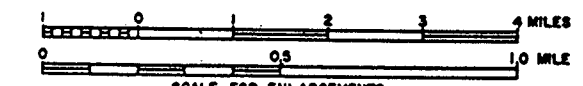

SCALE FOR ENLARGEMENTS
POLYCONIC PROJECTION

DATE APPROVED BY FISCAL COURT 11-21-95

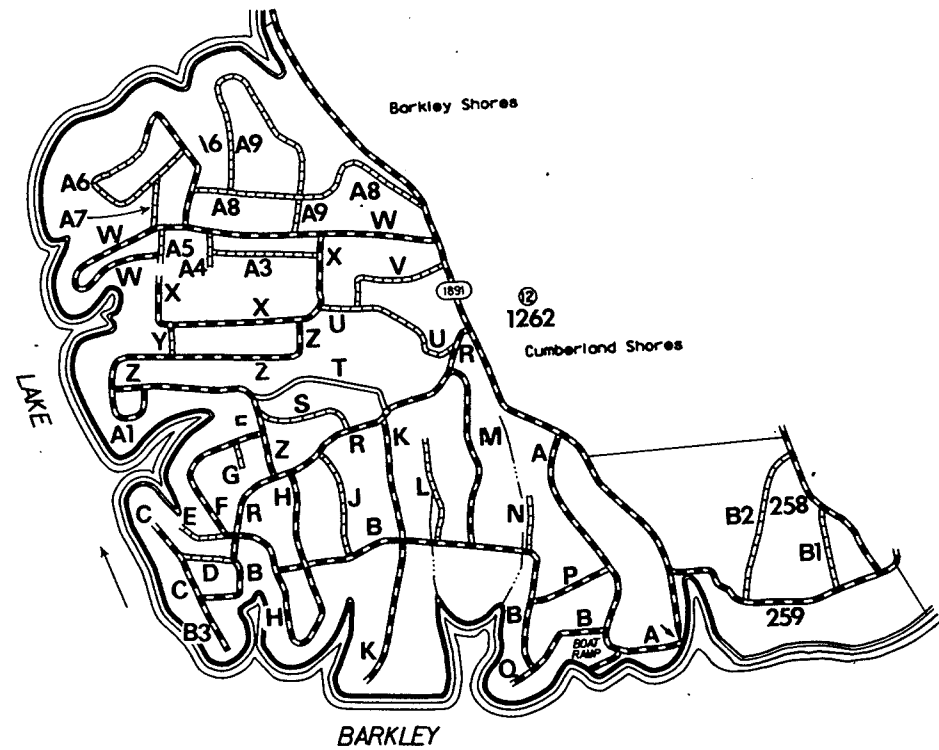
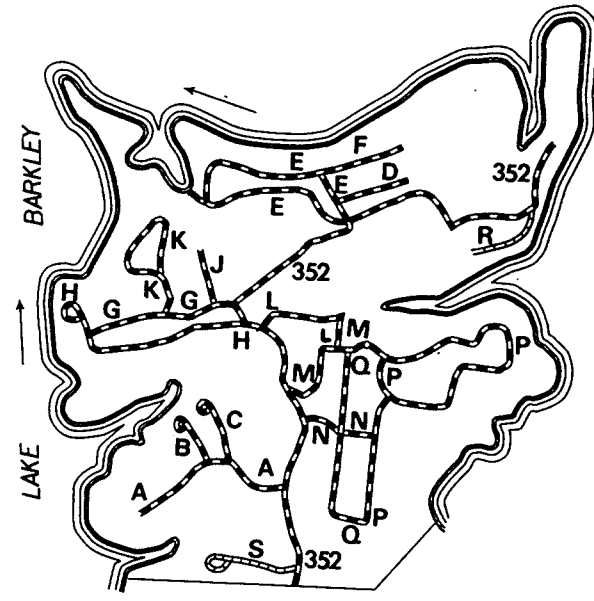
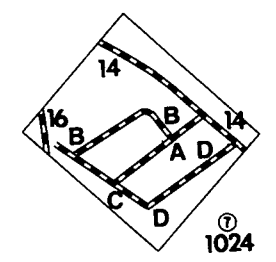
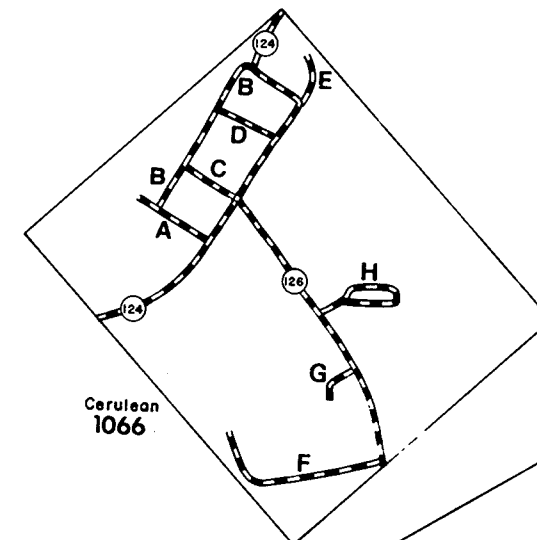
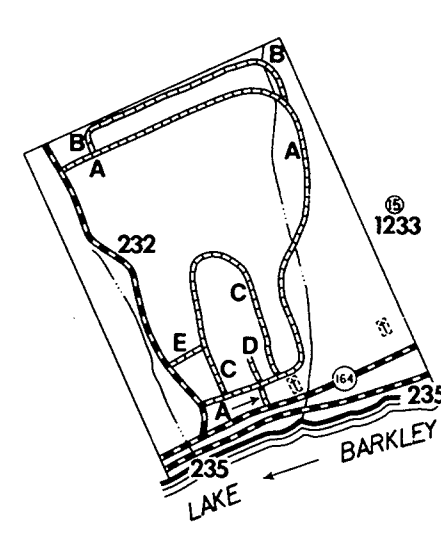
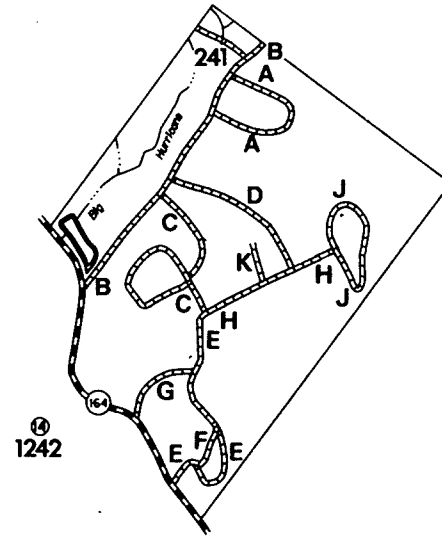
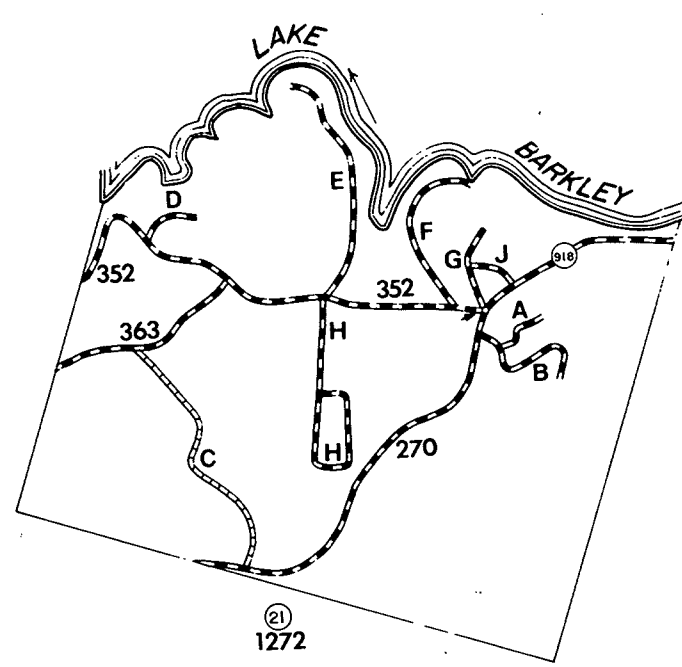
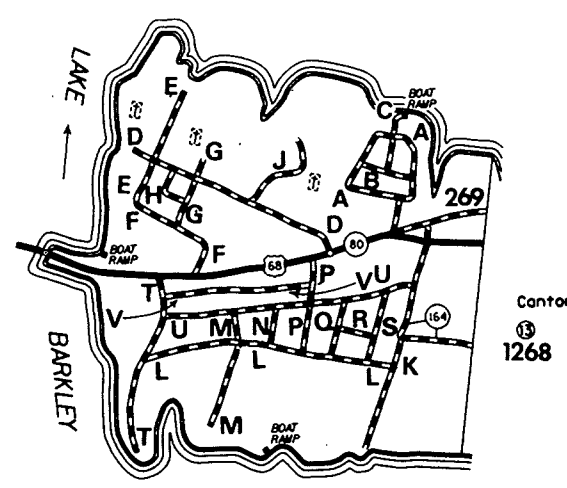
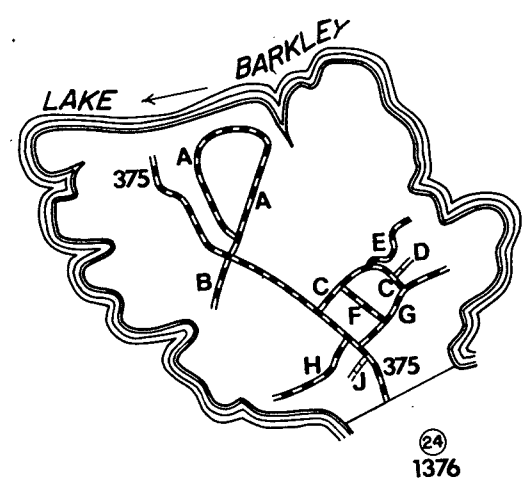

III

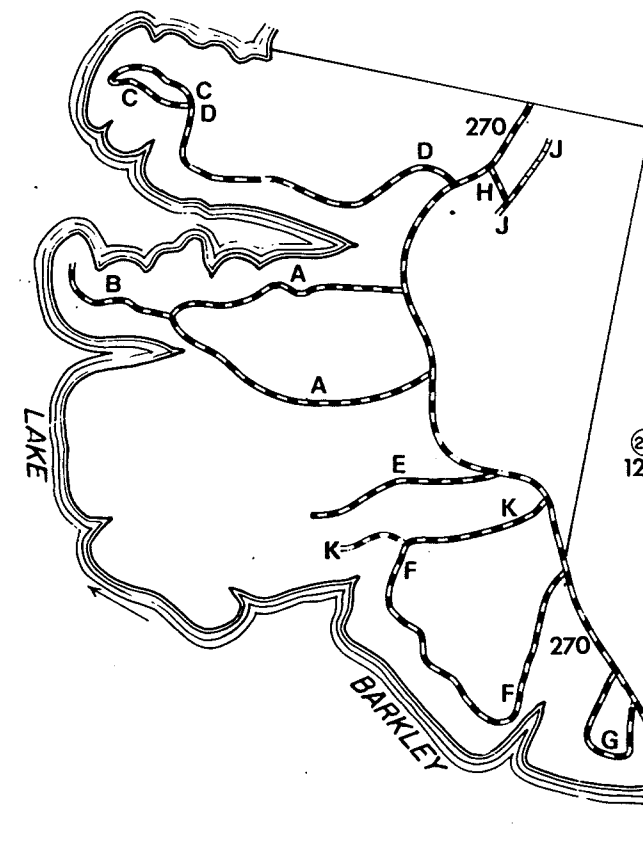
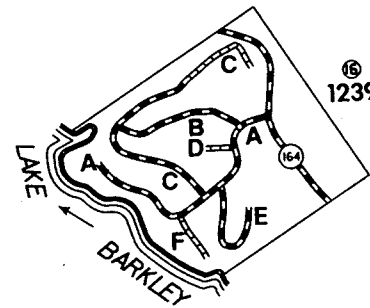

I

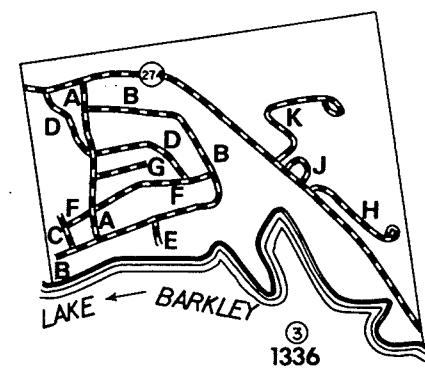
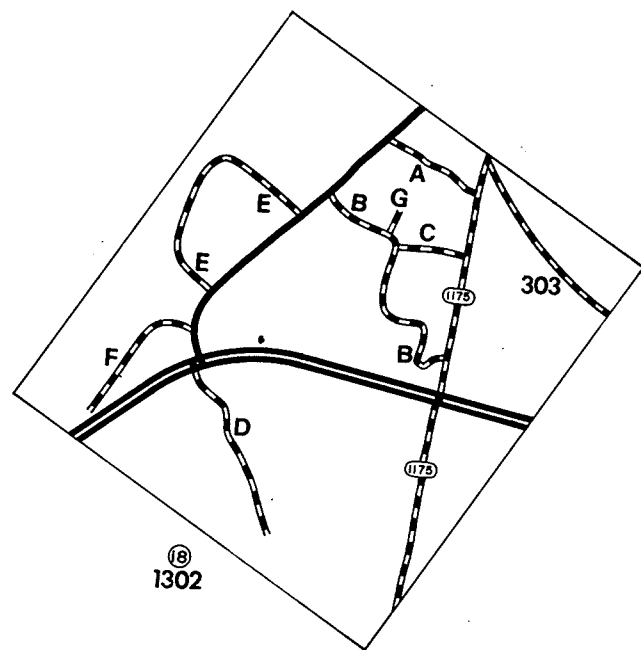
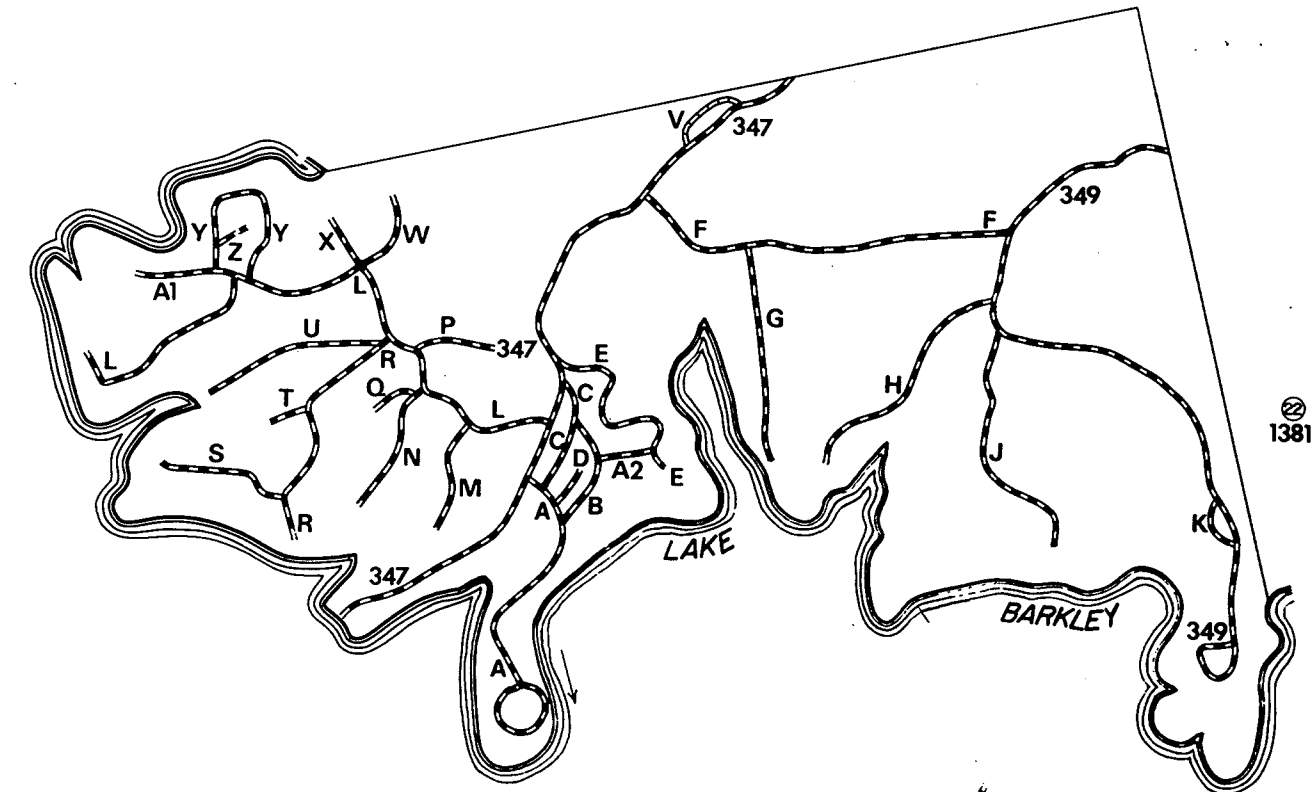
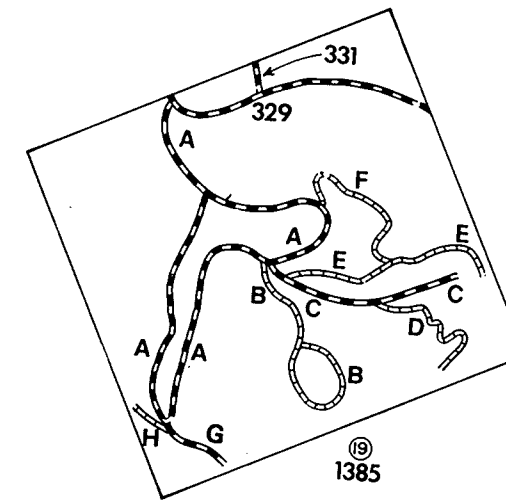
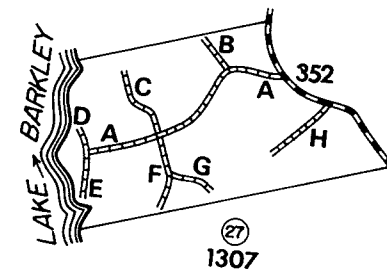
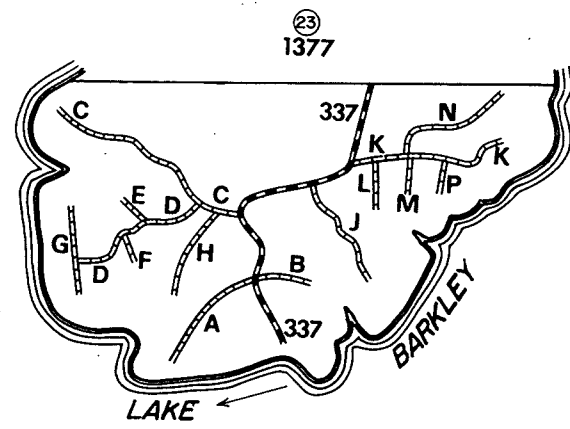
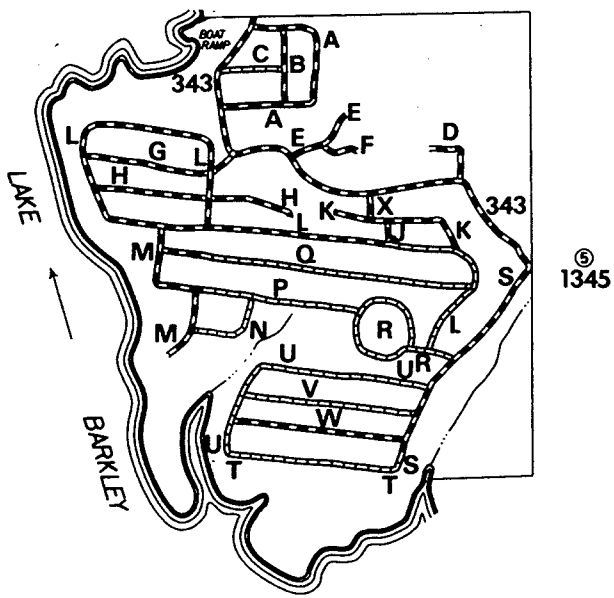
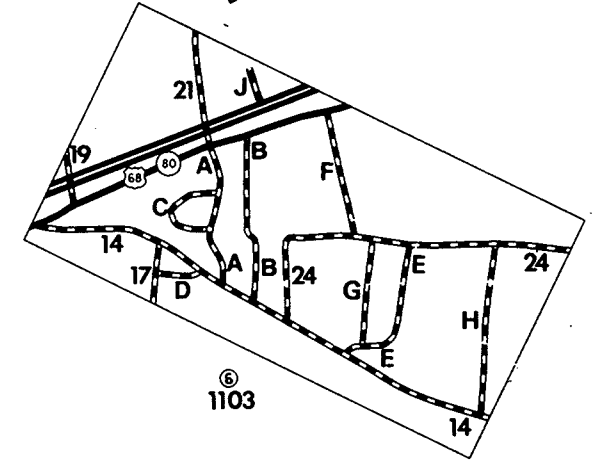
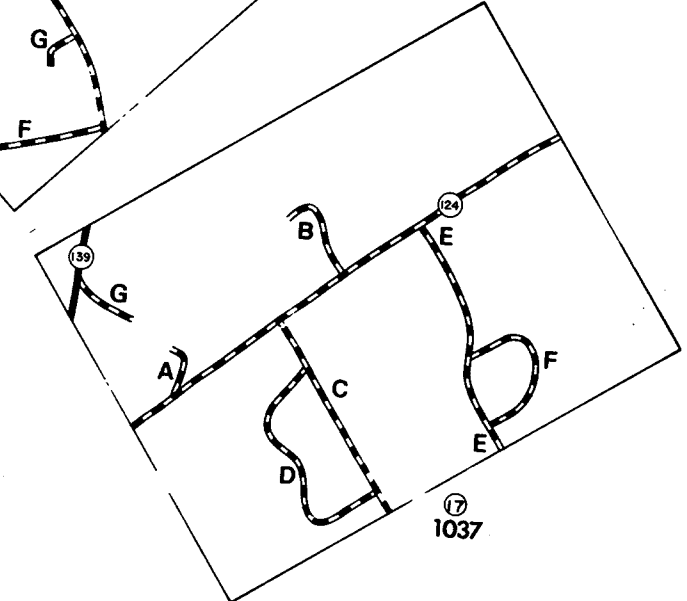
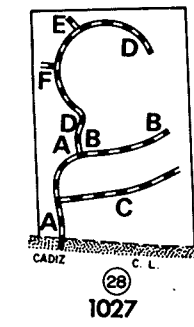

IV

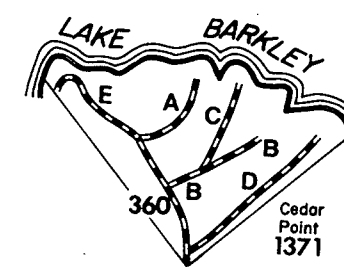
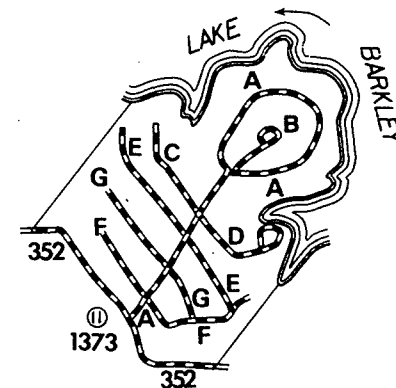
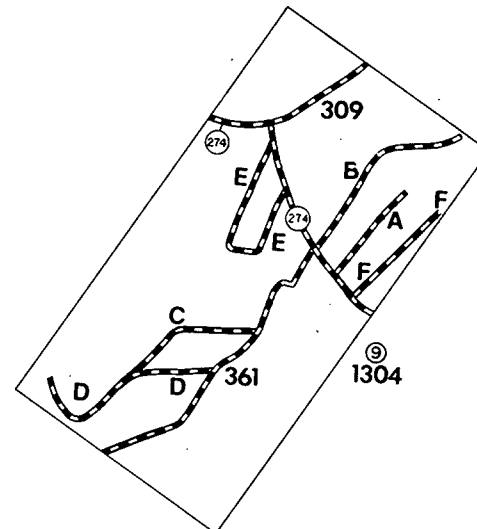
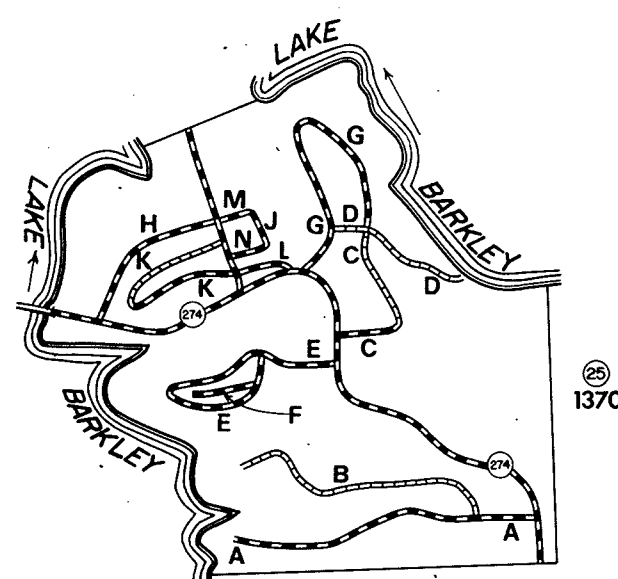
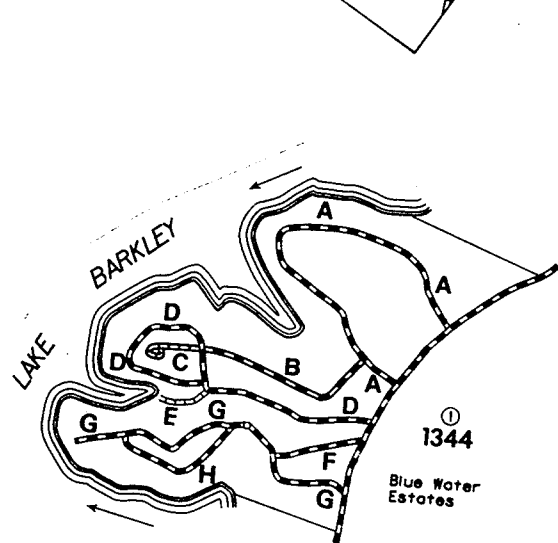
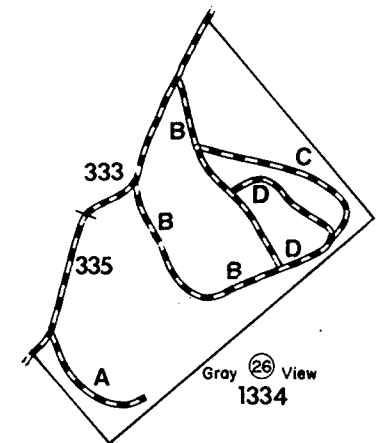
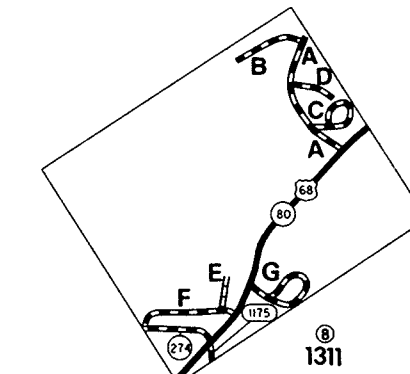
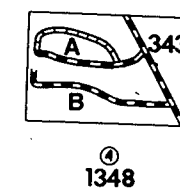
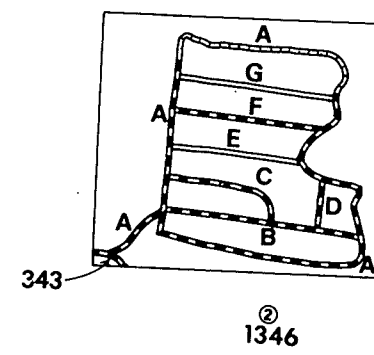

SHEET 2 OF 4

1996

COUNTY ROAD SERIES MAP

TRIGG COUNTY

KENTUCKY

QUADRANT I

QUADRANT II

QUADRANT III

NO.	ROAD NAME	LGTH.
1001	OAKLAWN FARM EAST	0.15
1002	CLIFFWOOD DRIVE	0.50
1003	GRIGSBY LANE	1.55
1004	BETHEL CHURCH	0.60
1005	GLENWOOD MILL	2.00
1006	SINKING FORK	1.10
1007	GINGER LANE	0.50
1008	RIVERBEND	1.30
1009	LINDSAY LANE	0.60
1010	WRONG WAY LANE	0.20
1011	LOCUST GROVE CHURCH	0.15
1012	COOL SPRINGS COVE	1.15
1013	OAKLAWN FARM WEST	0.40
1014	KINGS CHAPEL	3.50
1015	COLONEL MEREDITH	0.45
1016	HUMPHRIES	0.90
1017	RAMON OLIVER	0.35
1018	LAKOTA DRIVE	0.65
1019	HAMMOND LAKE	1.15
1020	JESSE ADAMS CEMETERY	0.20
1021	GREEN	0.40
1022	ROBERT GREEN	0.30
1023	SMITH LANE	2.10
1024	ROADS IN ENLARGEMENT NO. 7	
A	CANDY DRIVE	0.20
B	PATRICK DRIVE	0.25
C	CHRISTOPHER DRIVE	0.20
D	SCOTTSDALE DRIVE	0.20
1025	OLD HOPKINSVILLE	5.10
1026	BROADBENT SQUARE	0.20
1027	ROADS IN ENLARGEMENT NO. 28	
A	DENNIS THOMAS DRIVE	0.10
B	AMBER DRIVE	0.18
C	RHETT BOULEVARD	0.25
D	CHASITY DRIVE	0.38
E	DANA DRIVE	0.02
F	BRANDY DRIVE	0.02
1028	OLD SMITH LANE	0.58
1029	JENNY LANE	0.22
1030	CLYDE THOMAS	0.60
1031	CAMELOT DRIVE	0.80
1032	LANCELOT DRIVE	0.18
1033	INDUSTRIAL DRIVE	0.30
1034	HERNDON	0.48
1035	EDWARDS CEMETERY	0.30
1036		0.00
1037	ROADS IN ENLARGEMENT NO. 17	
A	MAYS VILLAGE	0.10
B	LANDFILL	0.15
C	WEST END STREET	0.40
D	HILLTOP DRIVE	0.40
E	JOEY DRIVE	0.30
F	VIRGINIA CIRCLE	0.25
G	MCCLOUD	0.10
1038		0.00
1039	TOWLER	0.52
1040	DUNKERSON	1.90
1041	LANDER CEMETERY	0.55
1042		0.00
1043	EAST STEWART	0.60
1044	BUFFALO	1.15
1045	RENNISON	0.30
1046	IRVIN	0.10
1047	OLD HORSE CREEK	0.20
1048		0.00
1049	RUINN	0.30
1050	STILLHOUSE BRANCH	0.35
1051	HAYDON	0.55
1052	J. MIZE	2.50
1053	LAKELAND DRIVE	0.40
1054	VINE	0.60
1055	STONE QUARRY	0.20
1056	CORNELIUS	0.90
1057	MCCAIN	0.70
1058	QUARRY	0.15
1059		0.00
1060	CHILDRESS	0.45
1061		0.00
1062	ED MITCHELL	1.80
1063	RAMSEYERS LANE	0.45
1064	CARL STUART	0.40
1065		0.00
1066	ROADS IN CERULEAN	
A	OAK STREET	0.15
B	WASHINGTON AVENUE	0.35
C	ROBINSON STREET	0.15
D	TURNER-RAWLS STREET	0.15
E	CAVE SPRINGS STREET	0.07
F	KNIGHT	0.30
G	HENDRIX STREET	0.05
H	CERULEAN CEMETERY	0.25
1067	ORTEN	0.70
1068	HART	0.55
1069		0.00
1070	PERRY	0.40
1071		0.00
1072	KELLY	0.60
1073	WALL CEMETERY	1.30
1074		0.00
1075	HOPSON STORE	0.10
1076	DYER	0.70
1077	BUSH	3.70
1078	ADAMS MILL EAST	2.60
1079	MARTIN LANE	0.40

NO.	ROAD NAME	LGTH.
1080	ADAMS MILL	5.25
1081	COMPLEX	0.70
1082	JOHN F. WHITE	1.45
1083		0.00
1084	HERNDON CIRCLE	0.90
1085		0.00
1086		0.00
1087		0.00
1088	THACKER	0.40
1089	CERULEAN-DAWSON SPRING	1.10
1090		0.00
1091		0.00
1092	WADLINGTON	0.10
1093	GUYETTE DRIVE	0.10
1094	BLANKS	0.50
1095		0.00
1096	J. STEWART CEMETERY	0.35
1097		0.00
1098	CADIZ MILL	0.25
1099		0.00
1100		0.00
1101	OAKHURST CIRCLE	0.40
1102	MELODY	0.18
1103	ROADS IN ENLARGEMENT NO. 6	
A	MAPLE	0.30
B	DOGWOOD DRIVE	0.35
C	MASON CIRCLE	0.20
D	GLENN ALLEN	0.05
E	BRIAR FIELD LANE	0.30
F	OLIVER	0.25
G	CRESTVIEW LANE	0.20
H	DEEPWOOD ESTATES	0.35
J	ROGER THOMAS	0.10

NO.	ROAD NAME	LGTH.
1125	SOUTH TANYARD	1.35
1126	GRIGSBY CEMETERY	0.60
1127	MEADOWS CEMETERY	0.20
1128	FREEMAN	1.85
1129	RANDOLPH	1.00
1130	CLAY BANKS	0.50
1131	GRIGSBY	0.50
1132	NEW HOPE CHURCH	1.00
1133	PRATHER	0.20
1134	JACK HUMPHRIES	0.30
1135	GRIGSBY SPUR	0.25
1136	H. C. FUTRELL	0.25
1137	MCATEE	1.60
1138	OLD ROCKY POINT	1.20
1139	TAYLOR BLUFF	0.50
1140	LONG FORD BRIDGE	1.60
1141	BORN	0.20
1142	BOYD LAKE BRANCH	0.35
1143	EAST LAKE	1.00
1144	BUCK MITCHELL	0.20
1145	DELMONT CEMETERY	0.15
1146	WE LIKE IT LANE	0.80
1147	JOHNSON HOLLOW	1.50
1148	TUGGLE	2.90
1149	ROCK FRONT LOOP	0.15
1150	WILSON	0.30
1151	CASEY HILL	0.30
1152		0.00
1153	ROARING SPRINGS-LAFAYETTE	1.90
1154	GARY CEMETERY	0.80
1155	COMPTON	0.20
1156	CASEY CREEK	0.25
1157	BURKLEY	0.75
1158	CORINTH CHURCH	1.05
1159	SHORT RUN	0.12
1160	H. CARLOUS CEMETERY	0.30
1161	WEST MAGGIE	3.80
1162	BAKER COURT	1.20
1163	CORINTH SCHOOL	0.25
1164	MCGEE	0.70
1165	DELMONT CHURCH	2.30
1166	TOM JONES	0.55
1167	NELUMS	0.25
1168	PUGH FLAT CHURCH	0.80
1169	OLD DOVER	12.50
1170	ROCKCASTLE SPRINGS	0.40
1171	SAMSIL CEMETERY	0.60
1172	CROSSROADS SCHOOL	2.70
1173	HILLTOP	0.35
1174	ATKINS CEMETERY	2.20
1175	DARNALL	0.20
1176	BORN CEMETERY	0.30
1177	THOMAS CEMETERY	0.10
1178	TYLERTON	0.60
1179	SAMMY GUNN	0.60
1180	OLD CADIZ-LINTON	2.70
1181	SUMNER LANE	0.55
1182	BOBBY ALLEN	0.35
1183	RANDOLPH CEMETERY	0.50
1184	OAKLAND CHURCH	0.40
1185	PLEASANT HILL	2.10
1186	DAVE SCHOLAR	0.40

NO.	ROAD NAME	LGTH.
1215	RICKY JONES	0.10
1216	CLAYTON LIGHT	0.30
1217	W. THOMAS	0.20
1218	D. THOMAS	0.80
1219	OAK GROVE CHURCH	2.10
1220	WHITE OAK LANE	0.40
1221	FLOYD SUMNER	1.90
1222	TOM SUMNER	0.20
1223	STARKIE THOMAS CEMETERY	0.10
1224		0.00
1225	FELIX WALDINGTON	0.60
1226	SKINNER	0.90
1227	SUMNER-KING LANE	0.35
1228	RED CEDAR LANE	0.10
1229	LINE PORT	1.80
1230	CHARLES E. THOMAS	0.20
1231	MCNICHOLS	0.20
1232	MCCOY HOLLOW	0.95
1233	ROADS IN ENLARGEMENT NO. 15	
A	APPLE VALLEY DRIVE	1.30
B	BARRON DRIVE	0.50
C	BRANDON	0.75
D	LINTON DRIVE	0.15
E	HILLTOP SPUR	0.10
1234	LAKE VISTA DRIVE	0.10
1235	E. SUMNER DRIVE	0.05
1236	LINTON LANE	0.10
1237	FERRY LANDING	0.20
1238	HARREL	2.40
1239	ROADS IN ENLARGEMENT NO. 16	
A	LAKE VISTA DRIVE	0.50
B	HILLS HOLLOW DRIVE	0.30
C	WATTS DRIVE	0.60
D	VIEW DRIVE	0.05
E	LINTON BAY DRIVE	0.20
F	BLUFF DRIVE	0.10
1240		0.00
1241	HURRICANE CREEK	0.55
1242	ROADS IN ENLARGEMENT NO. 14	
A	HURRICANE CEMETERY	0.60
B	HOWDY DOODY	0.55
C	HURRICANE CIRCLE	0.55
D	CARSON LANE	0.30
E	HILLTOP LANE	0.45
F	HARBOR LANE	0.20
G	BOOMERANG DRIVE	0.10
H	ANONYMOUS	0.30
J	PEPPER	0.05
K	RED OAK CIRCLE	0.30
1243	WOODSPOINT	1.70
1244	HARBOR DRIVE	0.40
1245	PINEY WOODS	1.35
1246	RUSTY BRIDGES LANE	0.10
1247	GENTRY	0.20
1248	SKIP JACK LANE	0.70
1249	JEOPARDY LANE	0.30
1250	FISHERMANS LANE	0.60
1251	LIBERTY LANE	1.00
1252	BEAVER POND	0.15
1253	LUTTRELL	0.30
1254	CRAIG BRANCH	0.90
1255	LOWER DONALDSON CREEK	0.65
1256	EAST ROSS SCHOOL	2.10
1257	DEER RUN	0.20
1258	DIXON	0.90
1259	DONALDSON SHORES DRIVE	0.65
1260	DIXON CEMETERY	0.20
1261	OLD WARRENTON SCHOOL	0.45
1262	ROADS IN ENLARGEMENT NO. 12	
A	BEAR RUN	0.60
B	BAYVIEW DRIVE	1.15
C	NORTH LAKE SHORE DRIVE	0.20
D	SCENIC DRIVE	0.12
E	RED OAK DRIVE	0.15
F	CHARLOTTE COVE	0.30
G	TENNESSEE CIRCLE	0.05
H	HORSESHOE DRIVE	0.58
J	HICKORY DRIVE	0.22
K	BEECHWOOD DRIVE	0.50
L	BLUEBIRD DRIVE	0.20
M	REDBIRD DRIVE	0.35
N	RASPBERRY DRIVE	0.12
P	SUNNY LANE	0.15
Q	EAGLE POINT	0.10
R	WEST ROSS SCHOOL	0.85
S	ILLINOIS STREET	0.20
T	INDIANA STREET	0.55
U	LOCK E	0.30
V	BLUEBIRD LANE	0.25
W	RIDGE DRIVE	1.00
X	RANDY DRIVE	0.50
Y	RANDY DRIVE EXIT	0.10
Z	CUMBERLAND DRIVE	0.95
A1	EDGEWATER DRIVE	0.15
A2		0.00

NO.	ROAD NAME	LGTH.
A3	HEATHER HILLS	0.25
A4	FARMERS LANE	0.10
A5	HARBOR NORTH DRIVE	0.15
A6	BAKER LANE	0.70
A7	GREENBRIAR LANE	0.12
A8	HONEYSUCKLE LANE	0.45
A9	MORNING GLORY DRIVE	0.65
B1	DONALDSON SPUR	0.20
B2	CALHOUN AVENUE	0.30
B3	SOUTH LAKE SHORE DRIVE	0.10
1263		0.00
1264		0.00
1265	THOMAS TRACE	0.10
1266	ANDREW CALHOUN LANE	0.10
1267	FULLER CEMETERY	0.10
1268	ROADS IN ENLARGEMENT NO. 13	
A	CANTON LAKE SHORE CIRCLE	0.50
B	CROSS STREET	0.15
C	CENTERVIEW DRIVE	0.17
D	BOYD'S LANDING	0.42
E	MOUND LANE	0.20
F	LAST CHANCE	0.20
G	CANTON FIRST STREET	0.12
H	CANTON SECOND STREET	0.10
J	CANTON CEMETERY	0.13
K	DEVILS-ELBOW	0.18
L	FRONTIER AVENUE	0.55
M	BARKLEY TRAIL	0.25
N	PINE LANE	0.10
P	OAK LANE	0.20
Q	CEDAR COURT	0.15
R	WOODY LITTLE JOHN	0.10
S	WEST MAPLE	0.17
T	ARROWHEAD TRAIL	0.30
U	TERRANCE LANE	0.50
V	CANTON LANE	0.30
1269	OLD US 68	1.25
1270	CANTON-BLUE SPRING	3.00
1271	SAM DOWNS SPUR	0.15
1272	ROADS IN ENLARGEMENT NO. 21	
A	JEAN SPANN WILSON	0.20
B	MILLER LANE	0.25
C	CUT OFF	0.50
D	PERSIMMON PLACE	0.10
E	ROCK HOUSE WAY	0.50
F	STALLONS	0.30
G	MOUNT PLEASANT CHURCH	0.25
H	COLSON-HILLVIEW DRIVE	0.60
J	BLUE SPRINGS SCHOOLHOUSE SPUR	0.10
1273	SAM DOWNS	1.50
1274	BEECHY FORK	1.70
1275		0.00
1276		0.00
1277	SAINT MARTIN LANE	0.20
1278	BOBBY LIGHT	0.35
1279	LANCASTER	0.50
1280		0.00
1281		0.00
1282	PETE LIGHT SPRINGS	0.20
1283	AVERITT	0.10
1284	DYERS HILL	0.30
1285	ROADS IN ENLARGEMENT NO. 20	
A	CANTON HEIGHTS NO. 2 CIRCLE	0.60
B	KAINTUCK KEY	0.25
C	CARDINAL CIRCLE	0.40
D	HOLIDAY WAY	0.70
E	TOWER LANE	0.25
F	BAY LANE	0.80
G	DRIFTWOOD ESTATES	0.40
H	BARSTOWN	0.10
J	SOUTH WOODWARD	0.20
K	WATER PLANT	0.40

QUADRANT IV

QUADRANT IV

QUADRANT IV

NO.	ROAD NAME	LGTH.
1300	MACK CUNNINGHAM	0.50
1301		0.00
1302	ROADS IN ENLARGEMENT NO. 18	
A	MELWOOD DRIVE	0.20
B	STEPHENS LANE	0.50
C	DEEPWOOD ESTATE DRIVE	0.15
D	CLARKSDALE DRIVE	0.30
E	ALLEN CIRCLE	0.50
F	BRABOY HANDLEY LANE	0.25
G	DEEPWOOD CIRCLE	0.05
1303	NORTH TANYARD	0.70
1304	ROADS IN ENLARGEMENT NO. 9	
A	GREENWOOD DRIVE	0.20
B	PAIUTE DRIVE	0.35
C	HARMON THOMAS	0.30
D	DUNNING CEMETERY	0.35
E	BARKLEY CIRCLE	0.40
F	CALVARY CHURCH LANE	0.20
1305	ANDREW MEREDITH	0.50
1306	CLINT LANE	0.12
1307	ROADS IN ENLARGEMENT NO. 27	
A	MANTUCKET AVENUE	0.35
B	COZY COVE LANE	0.05
C	TALL OAKS CIRCLE	0.20
D	CHANNEL COURT	0.05
E	WHISPERING WINDS	0.10
F	TIMBERLANE	0.15
G	MIMOSA COURT	0.08
H	FALCON LANE	0.10
1308		0.00
1309	POLLARD WHITE	1.20
1310	HOPPER	0.50
1311	ROADS IN ENLARGEMENT NO. 8	
A	JACKSON TERRACE	0.30
B	WALNUT WAY	0.20
C	SWIMMING POOL CIRCLE	0.20
D	INDIAN TRACE	0.10
E	JAKE HILL	0.05
F	OLD RILEY HOLLOW	0.25
G	TOMMY THOMAS	0.20
1312	GENTRY GRAY	2.10
1313	B. FLOOD	0.15
1314	RALSTON DRIVE	0.15
1315	HURRICANE CAMPGROUND	0.25
1316	STONE	1.30
1317	P. POOL	2.10
1318	TYLER	0.75
1319	P. KING	0.40
1320	BETHESDA SCHOOLHOUSE	0.70
1321	FAUGHN	0.20
1322	REDDICK POND	2.70
1323	TOOKE	0.30
1324	ZANE WILLIAMSON	0.40
1325	PANSY WOODS	1.20
1326	JAMES THORPE	0.20
1327	PINE HOLLOW	0.30
1328	MARSHALL CLARK	1.90
1329	NORTH SILOAM	3.20
1330	ADAMS	0.40
1331	ALEXANDER	0.90
1332	JACKIE ALEXANDER	0.25
1333	PRIZER POINT	1.40

NO.	ROAD NAME	LGTH.
1334	ROADS IN ENLARGEMENT NO. 26	
A	ROPER JOYCE	0.15
B	GRAYS HILLVIEW DRIVE	0.80
C	GRAYS SHADY LANE	0.35
D	GRAYS HILLSIDE CIRCLE	0.35
1335	WEST OLD ROCKCASTLE	0.60
1336	ROADS IN ENLARGEMENT NO. 3	
A	LITTLE RIVER BOULEVARD	0.35
B	RIVERVIEW TRAIL	0.70
C	GABBY LANE	0.10
D	RABBIT RIDGE	0.45
E	SHAWNEE COURT	0.07
F	JEFF OAKLEY DRIVE	0.30
G	LITTLE RIVER COURT	0.10
H	OAKLEY DRIVE	0.10
J	AUBRY LANE	0.10
K	SIMMON	0.25
1337	CRISP	1.20
1338	AL HENN	0.65
1339		0.00
1340		0.00
1341	BAKER CEMETERY	0.10
1342	PLEASURE RIDGE	0.70
1343	GOOSE HOLLOW	2.75
1344	ROADS IN ENLARGEMENT NO. 1	
A	SOLOMON DRIVE	0.85
B	ROCKY SPRINGS	0.35
C	CHAISE CIRCLE	0.12
D	CARRIAGE COVE DRIVE	0.80
E	NICKLES	0.20
F	HAYDEN DRIVE	0.20
G	BLUE RIVER	1.00
H	SOUTH VIEW DRIVE	0.30
1345	ROADS IN ENLARGEMENT NO. 5	
A	FERRELL CIRCLE	0.50
B	KENTUCKY DRIVE	0.15
C	COPPER LANE	0.13
D	OAK COURT	0.10
E	GOLDEN ROD LANE	0.15
F	DOGWOOD COURT	0.05
G	CAROL DRIVE	0.30
H	NANCY AVENUE	0.40
J	A. R. BRIGGS	0.06
K	LAKE SHORE COURT	0.30
L	R. C. LAKE SHORE DRIVE	1.60
M	LANDS END	0.30
N	REDWOOD DRIVE	0.15
P	POPLAR STREET	0.40
Q	WALNUT DRIVE	0.65
R	PINES CIRCLE	0.50
S	WILLOW LANE	0.45
T	CHERRY DRIVE	0.35
U	PLUM DRIVE	0.55
V	PEACH DRIVE	0.35
W	APPLE DRIVE	0.35
X	LONNIE AVENUE	0.06
1346	ROADS IN ENLARGEMENT NO. 2	
A	RICH DRIVE	1.80
B	YELLOW BIRD LANE	0.45
C	BLUE SPRUCE LANE	0.25
D	YELLOW BIRD CUT OFF	0.05
E	GREEN VALLEY DRIVE	0.25

NO.	ROAD NAME	LGTH.
F	PINK SWALLOW LANE	0.28
G	RED CORAL LANE	0.30
1347	PARKVIEW SHORES	2.60
1348	ROADS IN ENLARGEMENT NO. 4	
A	WALLACE CEMETERY	0.40
B	BIRCHWOOD DRIVE	0.40
CUNNINGHAM LANE		2.30
1350		0.00
1351		0.00
1352	BLUE SPRING-SHAWNEE	3.00
1353	ROADS IN ENLARGEMENT NO. 10	
A	SANDS BARKLEY DRIVE	0.15
B	ELLENWOOD DRIVE	0.10
C	RINO DRIVE	0.10
D	CHINABERRY COURT	0.15
E	RIMCREST CIRCLE	0.70
F	CHEEKWOOD LANE	0.15
G	CHEROKEE DRIVE	0.35
H	SHAWNEE TRAIL DRIVE	0.50
J	ARROWHEAD	0.15
K	APACHE TRAIL	0.15
L	OTTAWA	0.25
M	SEMINOLE DRIVE	0.25
N	HOLIDAY DRIVE	0.15
P	BAY SHORE DRIVE	1.20
Q	DAFFODIL DRIVE	0.40
R	SHAWNEE TRAIL	0.15
S	DOGWOOD COVE	0.20
1354	BLUFF TOP	0.30
1355	GRESHAM	1.25
1356	MALONE	1.50
1357	MEADOW BROOKE DRIVE	0.50
1358	FRANCIS LANE	0.20
1359	BAKERSFIELD DRIVE	0.30
1360	BEECH SPRINGS	1.40
1361	RILEY HOLLOW	3.00
1362		0.00
1363	SHINE LANE	1.15
1364	SHINE LANE CUT OFF	0.55
1365		0.00
1366		0.00
1367	HILLCREST DRIVE	0.15
1368	BEALMEAR	0.10
1369	STONEY LANE	0.20
1370	ROADS IN ENLARGEMENT NO. 25	
A	BEACH BEND DRIVE	0.60
B	CREEKSIDE DRIVE	0.50
C	FERNWOOD DRIVE	0.30
D	ELMWOOD DRIVE	0.30
E	POLLARD CIRCLE	0.60
F	POINT DRIVE	0.12
G	FOREST CIRCLE DRIVE	0.60
H	CHERRY BAY SUBDIVISION	0.25
J	CATFISH LANE	0.11
K	BAY COLONY	0.40
L	CRAPPIE	0.10
M	BASS LANE	0.07
N	BLUE GILL LANE	0.07
1371	ROADS IN CEDAR POINT	
A	CEDAR POINT	0.15
B	TANGLEWOOD DRIVE	0.15
C	FAWNWOOD COURT	0.15

NO.	ROAD NAME	LGTH.
D	SUNSET COURT	0.30
E	BEECH POINT	0.10
1372	MITCHELL	0.35
1373	ROADS IN ENLARGEMENT NO. 11	
A	BLUE SPRINGS BOULEVARD	0.90
B	WILKINS	0.13
C	PARK PLACE WEST	0.20
D	PARK PLACE EAST	0.60
E	SUNRISE DRIVE	0.40
F	VALLEY DRIVE	0.40
G	BOOTS LANE	0.35
1374		0.00
1375	B. HALL	1.00
1376	ROADS IN ENLARGEMENT NO. 24	
A	BIRDSONG ESTATE DRIVE	0.55
B	NATCHEZ TRACE	0.25
C	EDGEWOOD DRIVE	0.20
D	BEECHWOOD COURT	0.05
E	MAJOR WALLACE	0.20
F	RIDGEWOOD CUT OFF	0.15
G	RIDGEWOOD DRIVE	0.25
H	CHEROKEE COURT	0.15
J	DAKOTA	0.05
1377	ROADS IN ENLARGEMENT NO. 23	
A	TREE TOP LANE	0.15
B	WOODMOUNT DRIVE	0.10
C	MARINER'S MILL COURT	0.40
D	ELK PORK DRIVE	0.30
E	IVY DRIVE	0.05
F	SHADY GLENN	0.05
G	FOX HUNT LANE	0.15
H	WAGON WHEEL	0.15
J	ROBIN HOOD LANE	0.25
K	OVERLOOK DRIVE	0.30
L	HITCHING POST LANE	0.05
M	MOSS HALL LANE	0.05
N	CROSS CREEK	0.20
P	SHADY GROVE LANE	0.05
1378	TWIN TREES	0.40
1379	TRIGGWOOD	0.60
1380	HALL CEMETERY	0.40
1381	ROADS IN ENLARGEMENT NO. 22	
A	SKYLINE DRIVE	0.90
B	PARKVIEW	0.40
C	PARKVIEW CUT OFF	0.20
D	SERVICE	0.10
E	BACHMAN TURNER DRIVE	0.70
F	EVERLASTING SPRINGS	0.75
G	PARTRIDGE POINT	0.40
H	DRY RIDGE	0.60
J	POE'S ACRES	0.50
K	MCGEE ENCHANTED SHORES	0.15
L	WOODFIELD ESTATES DRIVE	1.30
M	WHISPERWOOD WAY	0.20
N	HILL WINDS LANE	0.25
P	SUNNYWAY DRIVE	0.15
Q	LAKESIDE CIRCLE	0.10
R	QUAIL RIDGE	0.45
S	WEDGEFIELD LANE	0.25
T	DEERFIELD COURT	0.08
U	GRAND VIEW DRIVE	0.28
V	PLOMER CLARK	0.15

NO.	ROAD NAME	LGTH.
W	JOURNEY'S END LANE	0.15
X	RIVER'S END COURT	0.10
Y	CRYSTAL CREEK CIRCLE	0.25
Z	ROYAL OAKS COURT	0.05
A1	GOOSE CREEK DRIVE	0.20
A2	BACHMAN TURNER SPUR	0.05
1382	HARPER	0.40
1383	CARL GRAY	0.40
1384		0.00
1385	ROADS IN ENLARGEMENT NO. 19	
A	WOODLAND DRIVE	1.90
B	WOODBINE	0.55
C	MEADOW DRIVE	0.30
D	BLUE WATER	0.40
E	MAYAPPLE DRIVE	0.45
F	EAGLE DRIVE	0.20
G	SHORE DRIVE	0.20
H	SHORE DRIVE SPUR	0.25