

Division of Construction Procurement

Phone Number: 502-564-3500

Fax: 502-564-8961

Email: [kytc.projectquestions@ky.gov](mailto:kytc.projectquestions@ky.gov)

Or see the website at: <http://transportation.ky.gov/Construction-Procurement/Pages/default.aspx/>

Addenda to this solicitation may be necessary prior to the closing date and will be furnished by mail, email, or the web to all prospective DBTs if prior to receipt date and to all DBTs determined to be eligible for award if after receipt date. The KYTC will respond to questions that are received by 4:00 pm (Eastern Time) 7 days prior to the bid submittal. The responses will be posted 3 days prior to the submittal deadline.

#### **4. PRE-QUALIFICATION OF DESIGN-BUILD TEAM (DBT)**

It is required that the bidder be a KYTC pre-qualified Contractor who has engaged the services of KYTC pre-qualified Design Consultant(s) to perform all work required in this RFP. If the Design Consultant(s) submitted does not meet all the required qualifications, KYTC may reject the DBT's proposal. All subconsultants and subcontractors utilized by the DBT on this project shall be pre-qualified to perform work for KYTC or their services shall not be allowed.

##### **4.1 Contractors Prequalification**

Consistent with Section 102.01 of Kentucky's 2012 Standard Specifications for Road and Bridge Construction ("Standard Specifications") all organizations and individuals bidding on Department projects and accepting subcontracts on Department of Highways ("Department") projects shall apply for and receive Department prequalification and possess a Certificate of Eligibility as provided in regulations published by the Department according to KRS 176.140. The lead entity for the DBT shall be prequalified prior to submission of the Letter of Qualifications. Organizations and individuals providing other services shall be prequalified and possess a Certificate of Eligibility prior to performing the work.

##### **4.2 Professional Services Prequalification**

The DBT shall provide all necessary services to design and construct all permanent and temporary portions of the project. Work shall conform to current KYTC, federal, and AASHTO standards, practices, policies, guidelines and specifications where applicable. Additional documents identified within the scope of work shall be provided under separate cover as part of the contract documents. KYTC standards, practices, policies, guidelines and specifications shall control in case of a conflict. The standard of care for all such services performed or furnished under this Agreement shall be the care and skill ordinarily used by members of the engineering profession practicing under similar conditions at the same time and locality.

Design firms prequalified shall perform only those tasks which they are prequalified to complete. The DBT will need to have KYTC prequalifications in a variety of disciplines in order to perform the required services in this proposal. KYTC prequalification's shall include but not be limited to:

Structure Design  
Geotechnical  
Geotechnical

Spans Under 500 Ft  
Laboratory Testing Services  
Drilling Services

mitigation required as Reasonable Conservation Measures under an issued Biological Opinion. Furthermore, the Service is afforded 135 days to prepare its Biological Opinion following acceptance of a request from the federal agency (USACE) to enter into formal consultation. The DBT should consider both the cost of mitigation as well as the time required to complete the consultation when developing a schedule and evaluating the costs of endangered species compliance.

The Service has recently listed the northern long-eared bat as threatened under the Endangered Species Act. Loss of tree habitat is considered likely to adversely affect the northern long-eared bat and the endangered Indiana bat unless the species can be demonstrated, through survey, not to be present. To facilitate consultation for impacts to forest habitat for Indiana and northern long-eared bats, the Service has developed a programmatic approach that will allow for payment into the Imperiled Bat Conservation Fund (IBCF) under a Conservation Memorandum of Agreement (CMOA). A payment into the IBCF to address likely adverse effects is calculated based upon the acres of trees to be removed, the sensitivity of the habitat and the time of year that the trees are to be removed. The DBT shall be responsible for any mitigation payments to be made in lieu of conducting surveys or as a result of a Biological Opinion. The process may only be used where impacts to forested habitat is fewer than 100 acres. For more information on the Service’s programmatic approach to Indiana and northern-long-eared bats, please see the Services website at [http://www.fws.gov/frankfort/indiana\\_bat\\_procedures.html](http://www.fws.gov/frankfort/indiana_bat_procedures.html)

## 10.6 Submittal Reviews

All work prepared for the purpose of obtaining a permit from a resource agency shall be submitted to KYTC for review and submittal to the appropriate agency. KYTC shall have 14 calendar days to review the information and if revisions are requested KYTC shall have 7 calendar days for review. The length of time to obtain a permit after submittal depends on the intensity of the impact, the sensitivity of resources impacted and workload of the permitting agency.

<b>Table A: Section 7 Endangered Species Act Consultation List Hardin County, Kentucky</b>		
<b>Common Name</b>	<b>Scientific_Name</b>	<b>Status</b>
<b>Gray Bat</b>	<i>Myotis grisescens</i>	Endangered
<b>Indiana Bat</b>	<i>Myotis sodalis</i>	Endangered
<b>Northern long-eared bat</b>	<i>Myotis septentrionalis</i>	Threatened
<b>Clubshell mussel</b>	<i>Pleurobema clava</i>	Endangered
<b>Fat Pocketbook mussel</b>	<i>Potamilus capax</i>	Endangered
<b>Northern Riffleshell mussel</b>	<i>Epioblasma torulosa rangiana</i>	Endangered
<b>Orangefoot Pimpleback mussel</b>	<i>Plethobasus cooperianus</i>	Endangered
<b>Rabbitsfoot mussel</b>	<i>Quadrula cylindrica cylindrica</i>	Endangered
<b>Rayed Bean mussel</b>	<i>Villosa fabalis</i>	Endangered
<b>Rough Pigtoe mussel</b>	<i>Pleurobema plenum</i>	Endangered
<b>Sheepnose mussel</b>	<i>Plethobasus cyphus</i>	Endangered

## 11. RIGHT OF WAY (ROW)

### GENERAL REQUIREMENTS

The selected Consultant(s) may be responsible for all or any of the following: appraisals; appraisal reviews; negotiations; relocation assistance; project management; titles and closings; property management, and other related acquisition services.

The selected Consultant agrees that upon request, staff will be available to assist in responding to FHWA or State inquiries or citations.

Pre Right of Way Activities Meeting – Prior to initiating any ROW activities, the DBT shall have a meeting with the District to discuss, at a minimum, the following: Introduction to the District ROW staff of DBT's ROW team; KYTC ROW Project Manager's, DBT Right of Way Project Manager & DBT Right of Way Property Manager's contact information; review of DBT's supporting units and information provided in Proposal; required submittals with examples; DBT's proposed plan/schedule for ROW meeting(s) and acquisitions; anticipated response/approval times; discussion/resolution of any outstanding or anticipated ROW or Legal Services issues.

Project Report – It will be the responsibility of the selected Consultant to compile a draft Project Report prior to the above meeting. The Report shall summarize in detail all anticipated relocations, i.e. residential, non-residential, miscellaneous moves, & outdoor advertising based on the current roadway plans. (Project Report shall be written by a qualified person(s).) Note: The Cost of the Project Report shall be part of the proposal

Submittal Reviews – KYTC shall review condemnation packets, submitted per section 11.9, for comment or approval within 14 calendar days. All other required ROW submittals shall be reviewed or approved by KYTC within 7 calendar days. Submittals reviewed and returned to the DBT with comments required to be addressed before approval shall receive an additional review period as outlined above.

### 11.1 TITLES

a) Attorneys for title and closing services must be selected from the KYTC Office of Legal Services statewide list for title services.

### 11.2 APPRAISALS/APPRAISAL REVIEWS

a) Appraisers must be selected from the KYTC ROW list of pre-qualified real estate appraisers. Please contact Eric Monhollon at [Eric.Monhollon@ky.gov](mailto:Eric.Monhollon@ky.gov) for a copy of the list.

### **13. DESIGN AND CONSTRUCTION REQUIREMENTS: MAINTENANCE OF TRAFFIC (MOT)**

Maintenance of Traffic (MOT) Special Provisions in addition to the Governing Regulations listed in Section 8.1 of this document: The DBT shall submit an approach for MOT for the project that incorporates the elements listed as well as propose any innovative ideas that may expedite the work. A Traffic Management Plan shall need to be submitted and approved.

**13.1 General:** All temporary MOT devices shall comply with the National Cooperative Highway Research Program (NCHRP) 350 Hardware report.

#### **13.2 MOT Restrictions:**

All maintenance of traffic procedures shall be in accordance with MUTCD. No lane closures shall be allowed during the observance of all National Holidays identified in Section 101 of the Standard Specifications, **other than as allowed below for structure replacement.** Under special circumstances, KYTC reserves the right to restrict the use of lane closures due to unforeseen special events. In principle, the DBT shall maintain the current lane configuration, **with 10 ft minimum lane widths** (or better), for the life of the project including access to all adjoining properties. Suggestions for additional working hours may be proposed by the DBT to KYTC as a part of the DBT project proposal. Construction operations using shoulder closures may be allowed during all daylight hours (except holidays) provided any resulting temporary drop-off conditions and signing requirements are adequately addressed. In general, any drop-off condition 4" or less shall be protected by barrels or delineators spaced every 40 feet. Drop-off's greater than 4" shall be wedged with DGA or other suitable materials on a 3:1 or greater slope in conjunction with barrels spaced every 40 feet. If a positive separation of 8 feet desirable (5 feet minimum if approved by the Engineer) or greater may be achieved between traffic and the drop-off, no wedging shall be required. Temporary drop-offs during working hours that construction operations are taking place should be kept to a minimum. Drop-offs greater than 4", resulting from excavations directly adjacent to traffic (with no positive separation), shall be limited to 500 feet in length. The intent of this requirement is to keep the temporary "wedging operation" in close proximity to the work to promote safety for the motorist. **Drop-offs greater than 3ft shall be protected by temporary guardrail or barrier wall.**

**One (1) road closure of KY434 shall be allowed between June 1 and August 1 to facilitate structure replacement. KY434 may be signed and closed within the project limits but local traffic and access to all adjoining properties must be maintained. The DBT is responsible for signing any and all required detours via state routes.**

**The DBT will be allowed the limited use of temporary traffic signals (TTS) to reduce traffic to one lane. TTS may be utilized for lane closures no longer than ½ mile in length. Use of TTS shall be limited to one (1) location within the project limits simultaneously. Consideration must be given and reasonable access maintained for any access points within the TTS. Traffic may be run on Crushed Stone Base or Dense Graded Aggregate, with proper signage, during non-working hours only in areas reduced to one lane by TTS.**

The DBT shall submit the MOT plan to KYTC for approval. The KYTC will approve or provide comments within 14 calendar days. Selection and award of project to DBT does not imply acceptance of MOT plan.

- **Proposed Schedule (15 points)** (see Section 8.1) submission shall include a CPM schedule to clearly demonstrate the DBT approach with the following specific dates (at a minimum):

Phase II

- 1) Right-of-Way Plans Submittal
  - 2) Right-of-Way Information Meeting
  - 3) Final Plans-in-Hand and Drainage Inspection Date:
  - 4) Maintenance of Traffic Plan Submittal Date:
  - 5) Submittal of Review Plans Date:
  - 6) Final Plan Submittal Date (see also “Buildable Units” Section 19):
  - 7) Construction Start Date:
  - 8) Substantial Completion Date:
- **Capacity (5 Points)** Current projects and availability of DBT members (Switching of DBT members after the award of this project shall only be allowed upon written approval by the KYTC.)

**B. Innovation / Project Management (30 Points)**

This section shall contain information about the DBT’s proposal for completing the project. The Scoring Committee will evaluate based on the following:

- Design Quality & Qualification
- Innovative Construction Proposal
- Project Management & Coordination

**17.2 Evaluation of Mandatory Requirements**

The Scoring Committee members shall evaluate and score the technical proposal. This evaluation shall be based on the information contained in the DBT’s technical proposal concerning the DBT’s Schedule/Capacity and Innovative/Project Management Ideas.

**17.3 Price Proposal (50 points)**

Price Proposals are qualified based on sections 6.11, 8.1 and 8.2 and evaluated on the basis of Section 17.4:

- Price Proposal (Lump Sum Bid) 50 points

**17.4 Value Based Formula Used for Selection**

Scoring of the Technical Proposal and Price Proposal plan shall be combined using a normalized weighted formula as follows:

$$SB = 100 [0.50 (TB/TH) + 0.50 (PL/PB)]$$

Where

- PB = DBT’s Price Proposal
- PL = Lowest Price Proposal (all DBTs)
- TB = DBT’s Technical Proposal Score
- TH = Highest Technical Proposal Score (all DBTs)

The DBT’s Overall Score (SB) shall be rounded to a tenth of a point. Rounding of Scores to the nearest tenth of a point shall be accomplished by the round-up method: e.g., 75.45, 75.46, 75.47, 75.48, and 75.49 would be rounded up to 75.5; and 75.41, 75.42, 75.43, and 75.44 shall be rounded to 75.4. The DBT with the highest overall score shall be recommended to the KYTC Awards Committee for Contract Award. In the event that two or more DBTs achieve the same rounded final score (SB), the "tied" DBT with the lowest Price Proposal (PB) shall be recommended to the KYTC Awards Committee for Contract

# Appendix A

## Pavement Design

Revised 10-07-2015  
Draft Pavement Design  
Folder Added

# KENTUCKY TRANSPORTATION CABINET



## PAVEMENT DESIGN FOLDER



County Hardin Item No. 4-153.01 UPN [Redacted]

Road KY 251 Route No. [Redacted]

Sta. to Sta. [Redacted] MP to MP [Redacted] to [Redacted]

Consultant Bacon Farmer Workman Engineers Project Length [Redacted] miles

**Pavement Type Selection** Design ESAL's 1,200,000

Alternate Bid

Asphalt: Max Asphalt  Max Aggregate  Current Letting Date [Redacted]

Concrete

### DOCUMENTATION

- |  |  |
|--|--|
| <input checked="" type="checkbox"/> Design Executive Summary | <input checked="" type="checkbox"/> Typical Sections and Details |
| <input checked="" type="checkbox"/> Pavement Design TC61-29  | <input type="checkbox"/> Comparison of Alternatives              |
| <input type="checkbox"/> Special Notes and Provisions        | <input type="checkbox"/> Initial Cost                            |
| <input type="checkbox"/> Type Selection Summary              | <input type="checkbox"/> Life Cycle Cost                         |
| <input checked="" type="checkbox"/> Geotechnical Information | <input type="checkbox"/> Other Documentation                     |
| <input checked="" type="checkbox"/> Traffic Information      | List:  |

**SUBMITTED:** Bacon Farmer Workman Designer Date: 9/22/2015

# KENTUCKY TRANSPORTATION CABINET



## PAVEMENT DESIGN FOLDER



County Hardin Item No. 4-153.01 UPN [Redacted]

Road KY 434 Route No. [Redacted]

Sta. to Sta. [Redacted] MP to MP [Redacted] to [Redacted]

Consultant Bacon Farmer Workman Engineers Project Length 3.1 miles

**Pavement Type Selection** Design ESAL's 1,500,000

Alternate Bid   
Asphalt: Max Asphalt  Max Aggregate   
Concrete   
Current Letting Date 10/1/2015\

### DOCUMENTATION

- |  |  |
|--|--|
| <input checked="" type="checkbox"/> Design Executive Summary | <input checked="" type="checkbox"/> Typical Sections and Details |
| <input checked="" type="checkbox"/> Pavement Design TC61-29  | <input type="checkbox"/> Comparison of Alternatives              |
| <input type="checkbox"/> Special Notes and Provisions        | <input type="checkbox"/> Initial Cost                            |
| <input type="checkbox"/> Type Selection Summary              | <input type="checkbox"/> Life Cycle Cost                         |
| <input checked="" type="checkbox"/> Geotechnical Information | <input type="checkbox"/> Other Documentation                     |
| <input checked="" type="checkbox"/> Traffic Information      | List:  |

SUBMITTED: BFW Engineering Designer Date: 9/22/2015



**TRANSPORTATION CABINET**  
Frankfort, Kentucky 40622  
[www.transportation.ky.gov/](http://www.transportation.ky.gov/)

**Steven L. Beshear**  
Governor

**Michael W. Hancock, P.E.**  
Secretary

---

---

**MEMORANDUM**

---

---

**TO:** Patricia Dunaway, P.E.  
Chief District Engineer  
District 4 – Elizabethtown

**ATTN:** Charlie Allen, P.E.

**FROM:** John Moore, P.E.   
Director  
Division of Planning

**DATE:** December 3, 2014

**SUBJECT:** Hardin County Traffic Forecast  
Minor Widening and Spot Improvement of KY 251 and KY 434  
Item No. 4-153.01

In response to your May 15, 2014 request, we are providing the following forecasts on the attached report:

- 2014 and 2035 Average Daily Traffic and Design Hour Volumes
- 2014 and 2035 Daily and Design Hour Turning Movements
- Truck Percentages and 20-year ESALs

If you have any questions, please contact Jay Balaji of this Division at (502) 782-5045.

JM/JB/BC

**Attachments**

c/att: Randy Turner  
Brad Bottoms  
Joe Tucker  
Dan Hite



# *Executive Summary*

**Traffic Forecast Report and Bike/Ped  
Recommendations  
Hardin County  
Minor Widening and Spot Improvement on KY 251 and  
KY 434  
Item No. 4-153.01**

Prepared for:



Prepared by:  
**Jayalakshmi Balaji, P.E.**  
Division of Planning  
Kentucky Transportation Cabinet  
December 3, 2014

## Table of Contents

Figure 1: Vicinity Map.....	Page 2
Executive Summary.....	Page 3
Population Summary.....	Page 5
Figure 2: Summary Map.....	Page 6
Turn Movements.....	Page 7
20 Year ESAL Spreadsheets.....	Page 17
Bike/Ped Recommendations.....	Page 22

## Commonly Used Abbreviations and their Descriptions

ADT	Average Daily Traffic	Without any adjustment
DHV	Design Hour Volume	30 <sup>th</sup> highest hour of a <u>year</u>
ESAL	Equivalent Single Axle Load	A measure of traffic's impact on roadway
%T	Truck Percentage	The percentage of trucks to total volume
FC	Functional Class	Refers to a road's importance
GR	Growth Rate	A value normally compounded annually
PHF	Peak Hour Factor	Considers a 15 minute spike in an hourly count
K-Factor	K-30 <sup>th</sup> hour Factor	DHV divided by ADT (DHV/ADT)
D-Factor	Directional Factor	Percentage of dominant flow to total
MP	Mile Point	Miles increase easterly and northerly
ATR	Automatic Traffic Recorder	A permanent & continuous recording station
KYSTM	Kentucky Statewide Model	A computerized representation of KY roads

### Vicinity Map

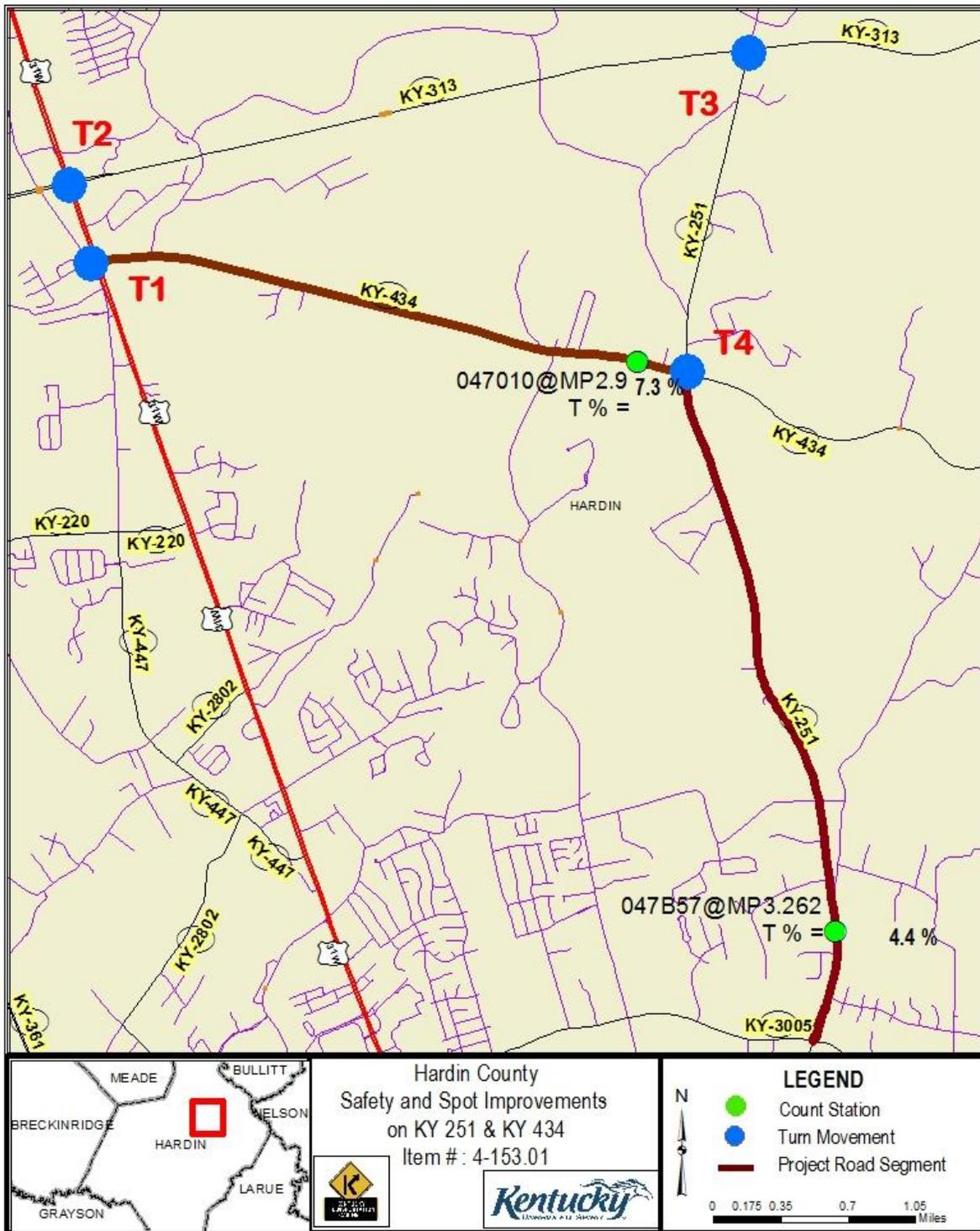

## **Traffic Forecast Executive Summary**

### **Hardin County: Minor Widening and Spot Improvement**

#### **Item No. 4-153.01**

#### **FORECAST SUMMARY**

The project calls for the minor widening and spot improvements to improve safety on KY 251 from KY 3005 to KY 434 and KY 434 from KY 251 to the US 31 W Bypass. The purpose of this report is to analyze current and future traffic utilizing Sheperdsville Road from MP 2.681 to MP 6.288 and Battle Training Road from MP 0.025 to MP 3.158

#### **FORECAST TYPE**

The following types of forecasts were developed:

- 2014 and 2035 Average Daily and Design Hourly Truck Percent Forecasts
- 2014 and 2035 Turning Movements
- 2014 and 2035 ADT and DHV values
- Peak Hour Factor
- 20-year ESALs

#### **CURRENT-YEAR VOLUMES**

The 2014 ADT volume is based on the most recent hourly volume data collected at count stations 047B57 on KY 251 (MP 3.262) and 047010 on KY 434 (MP 2.9) and the turning movement counts. All figures are subject to rounding.

#### **DESIGN-YEAR/GROWTH FACTORS**

Kentucky State Data Center suggests population for Hardin County to grow 0.83% annually. Exponential analyses performed on historical data at traffic stations 047B57 and 047010 estimated growth rates of 2.0% and 1.8% respectively. Therefore for the purpose of this forecast a growth rate of 2.0% for KY 251 and 1.8% for KY 434 were used.

#### **DESIGN HOUR FACTORS**

DHVs were estimated by analyzing the hourly volume data and the turn movements collected for this forecast. The peak AM and PM volumes were derived by dividing the highest hourly volumes from these counts by the daily total. Functional class design hour factors based on the day and month of these counts were then applied. Finally, the calculated K-factors were used in combination with the ADT forecast to produce DHVs for 2014 and 2035.

#### **TRUCK PERCENTAGE**

The truck percentage was calculated using a 2010 vehicle classification count at count station 047B57 (4.4 %) and a 2014 vehicle classification count at count station 047010 (7.3%). These truck percentages are comparable to the functional class average for similar roads. Therefore a T% of 4.4% for KY 251 and 7.3% for KY 434 and a growth rate of 0.5 % were used.

## **ESALs**

Functional class averages from ATR data, traffic counts, and the 2035 ADT projections were used to estimate 20-year ESALs on the project road segment. The 2007 aggregated ESAL report, generated by the Kentucky Transportation Center in collaboration with the Kentucky Transportation Cabinet, was used to grow the important ESAL calculation variables. The DHVs in the ESAL sheet for KY 434 does not match with the turning movement volumes. This is due to the fact the highest volume on the project road segment occurs near the intersection of Ring Road and KY 251. For more information, please see the attached ESAL calculation sheets.

## **TURN MOVEMENTS**

Four turn movements were requested for this project. They were

- T1: US 31 W and KY 434
- T2: US 31 W and KY 313
- T3: KY 251 and KY 313
- T4: KY 251 and KY 434

The intersections do not match due to presence of many access points in between them. The counts were then factored to determine current year ADT and DHV turn movements. The current year turn movements were grown using methods described above to determine future year turn movements.

**HISTORICAL POPULATION SUMMARY**

	1960	1970	1980	1990	2000	2010	60 - 70	70 - 80	80 - 90	90 - 00	00 - 10
	Population	Population	Population	Population	Population	Population	Pct	Pct	Pct	Pct	Pct
Kentucky	3,038,156	3,220,711	3,660,334	3,686,892	4,041,769	4,339,367	6.0%	13.6%	0.7%	9.6%	7.4%
Hardin Co	-	78,421	88,911	89,240	94,174	105,543	-	13.4%	0.4%	5.5%	12.1%
							Change	Change	Change	Change	Change

Sources: US Bureau of the Census; Kentucky State Data Center

**FUTURE POPULATION PROJECTIONS SUMMARY**

	2010	2015	2020	2025	2030	2035	10 - 15	15 - 20	20 - 25	25 - 30	30 - 35
	Projection	Projection	Projection	Projection	Projection	Projection	Pct	Pct	Pct	Pct	Pct
Kentucky	4,339,367	4,509,429	4,672,754	4,820,390	4,951,178	5,063,331	3.9%	3.6%	3.2%	2.7%	2.3%
Hardin Co	105,543	111,225	116,612	121,541	125,898	129,612	5.4%	4.8%	4.2%	3.6%	3.0%
							Change	Change	Change	Change	Change

Sources: US Bureau of the Census; Kentucky State Data Center

**ANNUAL POPULATION GROWTH RATES FROM HISTORICAL DATA AND PROJECTIONS**

	60 - 70	70 - 80	80 - 90	90 - 00	05 - 10	10 - 15	15 - 20	20 - 25	25 - 30	10 - 30
	GR	GR	GR	GR	GR	GR	GR	GR	GR	GR
Kentucky	0.59%	1.29%	0.07%	0.92%	0.77%	0.71%	0.62%	0.54%	0.45%	0.62%
Hardin Co	-	1.26%	0.04%	0.54%	1.05%	0.95%	0.83%	0.71%	0.58%	0.71%

## Summary Map

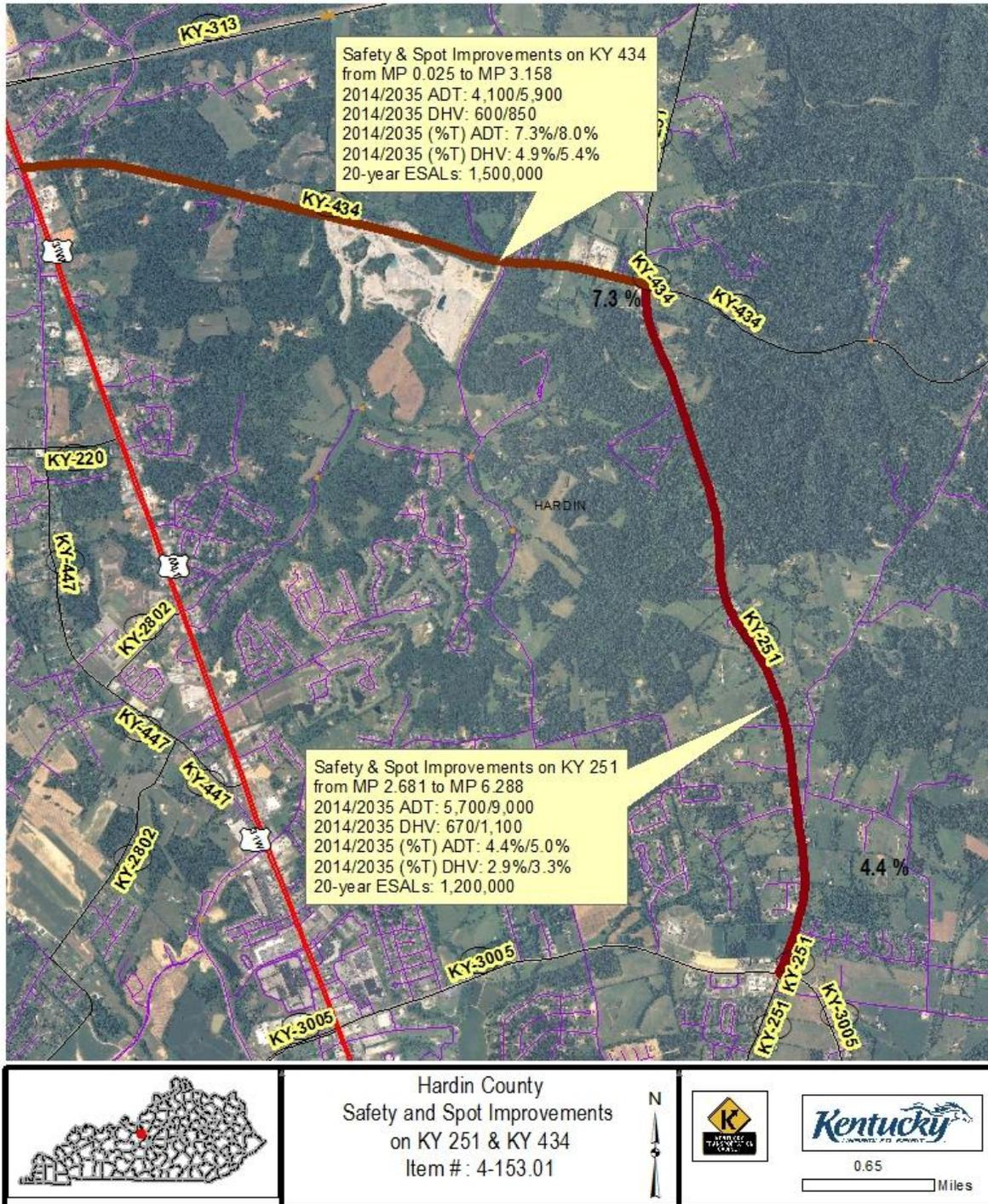

# **TURN MOVEMENT 2014**

**T1: US 31 W AND KY 434**

**T2: US 31 W AND KY 313**

**T3: KY 251 AND KY 313**

**T4: KY 251 AND KY 434**

Traffic Forecast Technical Report  
 Hardin County: Minor Widening of KY 251 and KY 434  
 Item No. 4-153.01

PROJECT: Safety & Spot improvements on KY 251 and KY 434  
 ITEM NUMBER: 4-153.01  
 MARS NUMBER: 8658313P  
 REQUEST DATE: 5/15/2014  
 ANALYST: J.BALAJI  
 SCENARIO: 2014 ADT and Design Hour Volumes  
 INTERSECTION: T1: US 31W @ KY 434

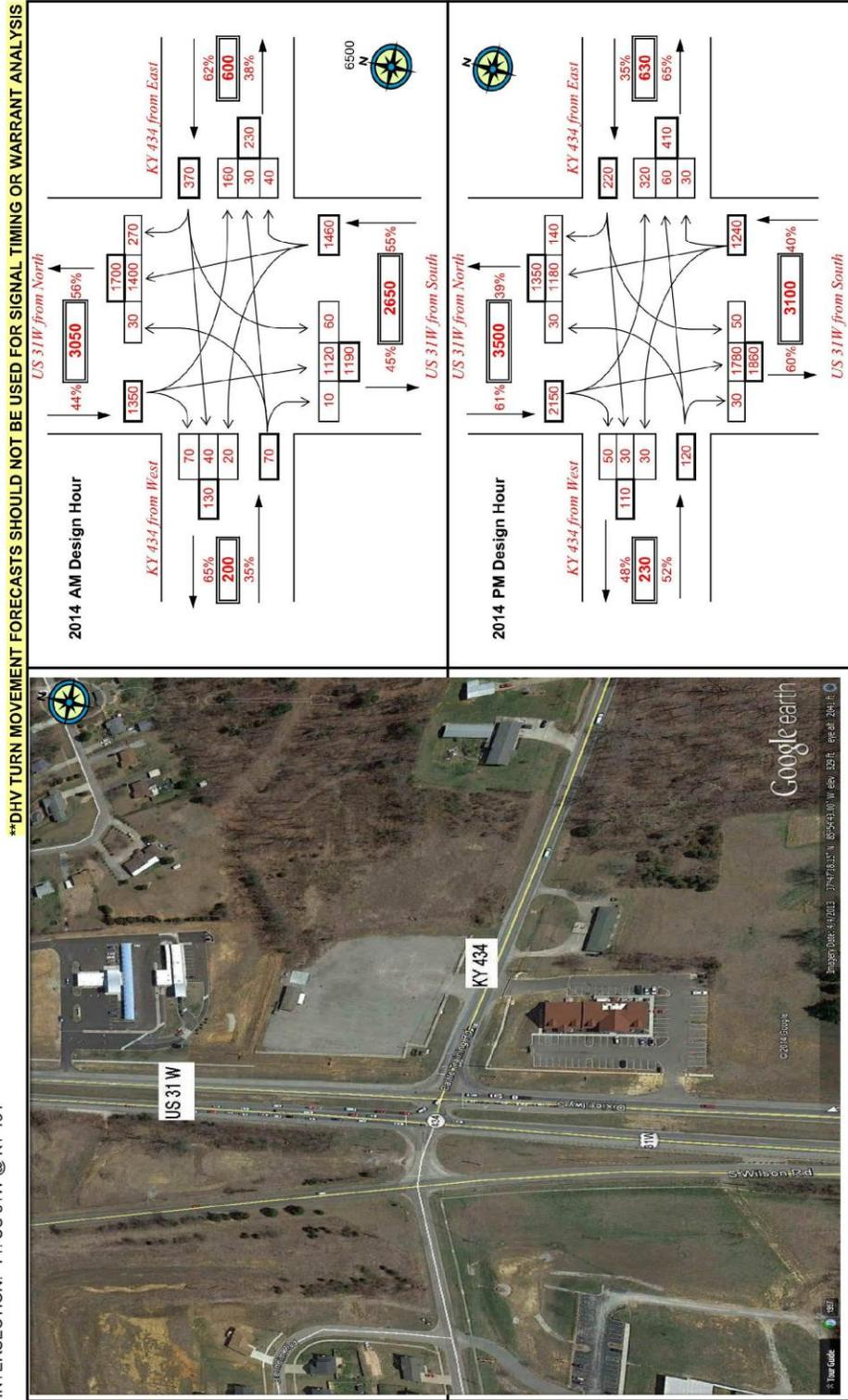

Traffic Forecast Technical Report  
 Hardin County: Minor Widening of KY 251 and KY 434  
 Item No. 4-153.01

PROJECT: Safety & Spot improvements on KY 251 and KY 434  
 ITEM NUMBER: 4-153.01  
 MARS NUMBER: 8658313P  
 REQUEST DATE: 5/15/2014  
 ANALYST: J.BALAJI  
 SCENARIO: 2014 ADT and Design Hour Volumes  
 INTERSECTION: T2: US 31W @ KY 313

**\*\*DHW TURN MOVEMENT FORECASTS SHOULD NOT BE USED FOR SIGNAL TIMING OR WARRANT ANALYSIS**

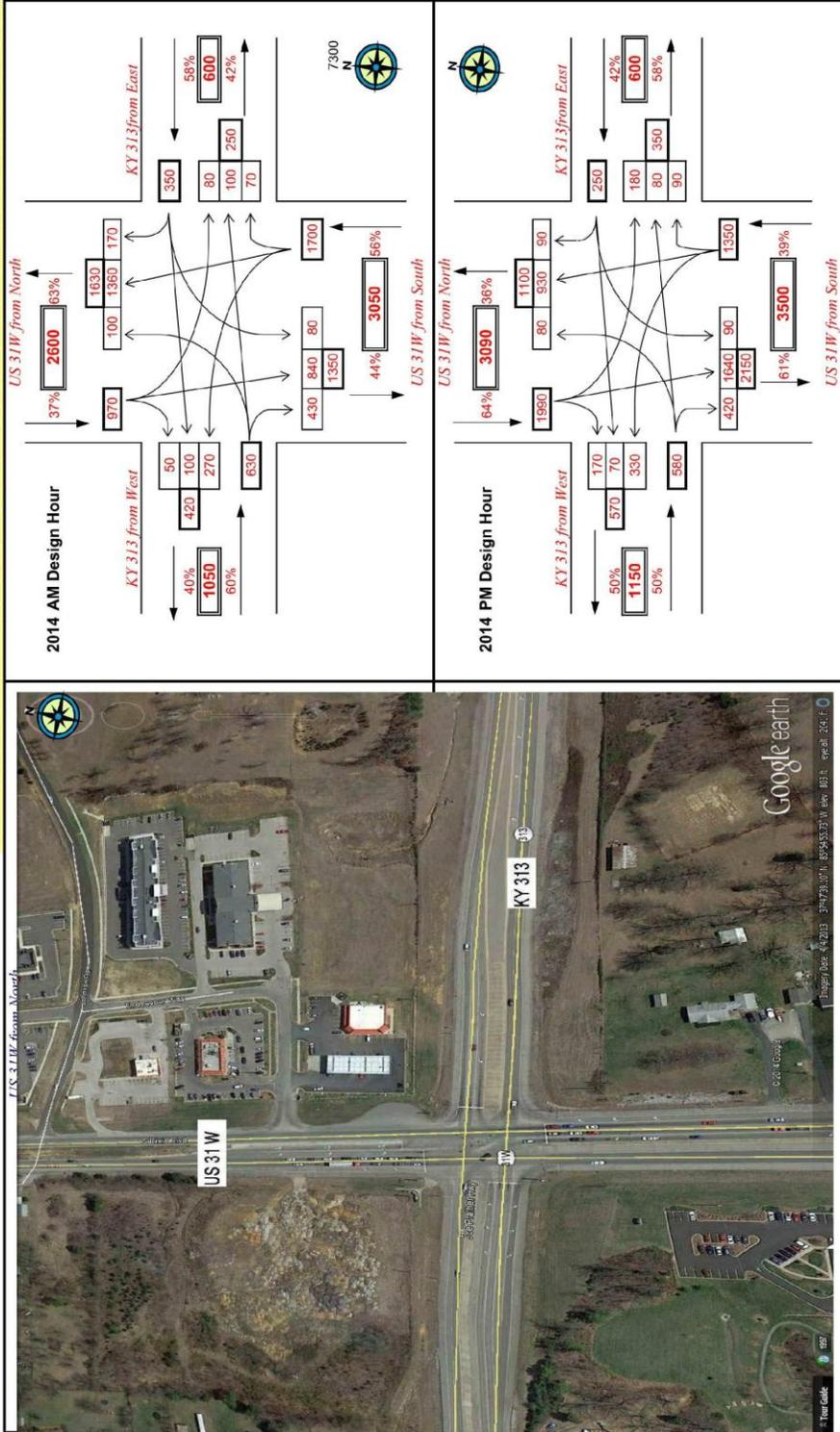

Traffic Forecast Technical Report  
 Hardin County: Minor Widening of KY 251 and KY 434  
 Item No. 4-153.01

PROJECT: Safety & Spot Improvements on KY 251 and KY 434  
 ITEM NUMBER: 4-153.01  
 MARS NUMBER: 8658313P  
 REQUEST DATE: 5/15/2014  
 ANALYST: J.BALAJI  
 SCENARIO: 2014 ADT and Design Hour Volumes  
 INTERSECTION: T3: KY 313 @ KY 251

\*\*DHV TURN MOVEMENT FORECASTS SHOULD NOT BE USED FOR SIGNAL TIMING OR WARRANT ANALYSIS

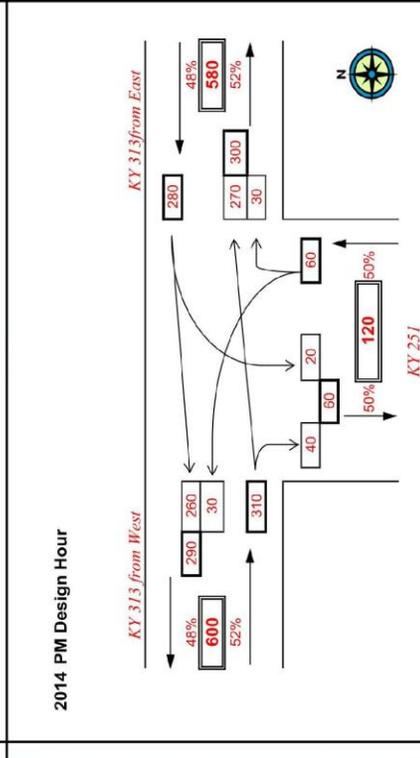
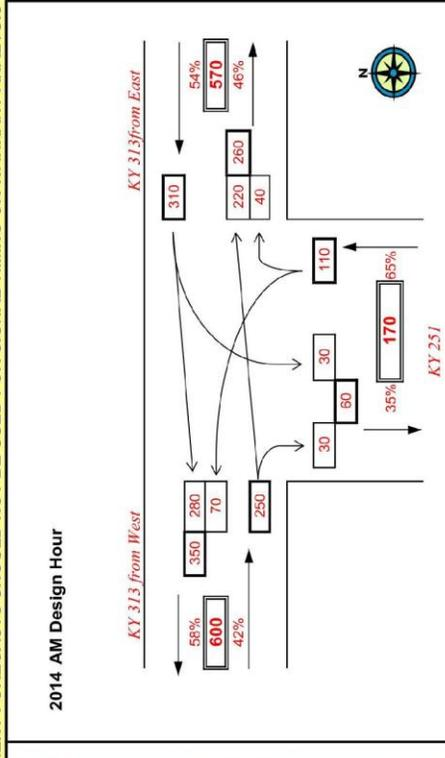
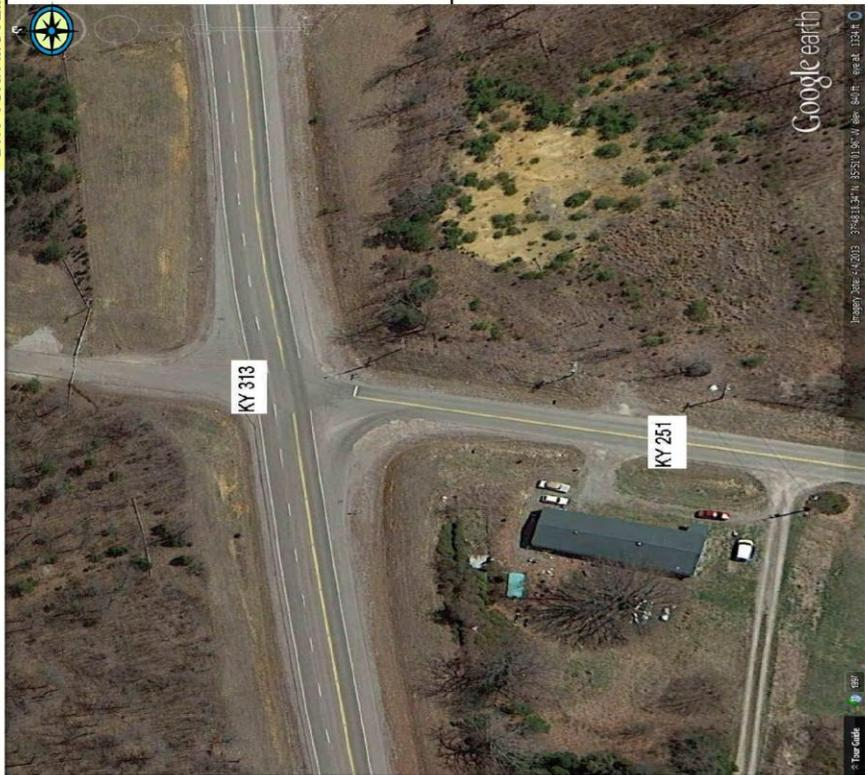

Traffic Forecast Technical Report  
 Hardin County: Minor Widening of KY 251 and KY 434  
 Item No. 4-153.01

PROJECT: Safety & Spot Improvements on KY 251 and KY 434  
 ITEM NUMBER: 4-153.01  
 MARS NUMBER: 8658313P  
 REQUEST DATE: 5/15/2014  
 ANALYST: J.BALAJI  
 SCENARIO: 2014 ADT and Design Hour Volumes  
 INTERSECTION: T4: KY 251 @ KY 434

\*\*DHW TURN MOVEMENT FORECASTS SHOULD NOT BE USED FOR SIGNAL TIMING OR WARRANT ANALYSIS

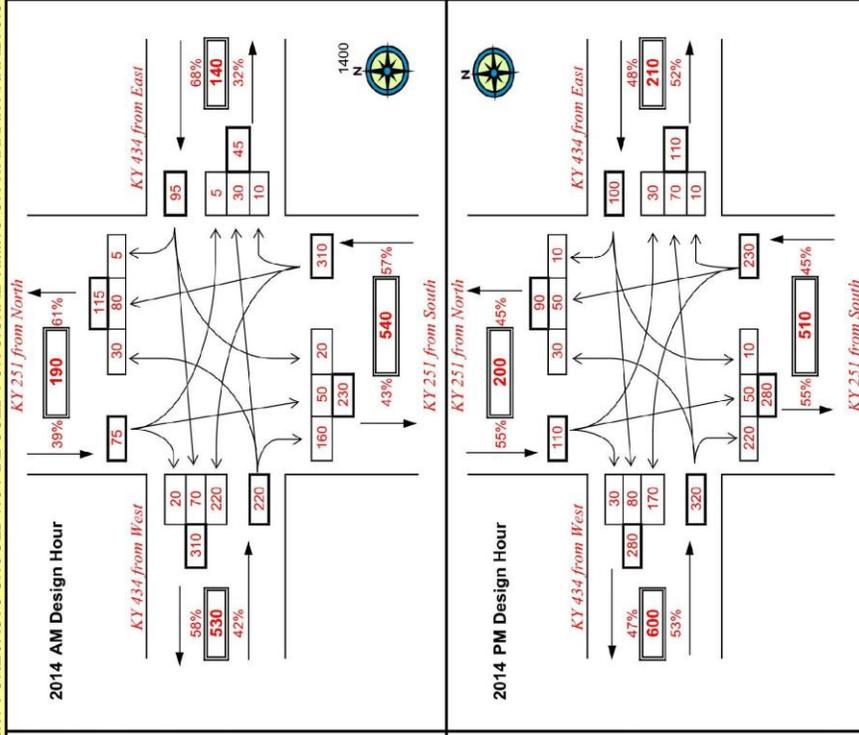

**2035**

**T1: US 31 W AND KY 434  
T2: US 31 W AND KY 313  
T3: KY 251 AND KY 313  
T4: KY 251 AND KY 434**

Traffic Forecast Technical Report  
 Hardin County: Minor Widening of KY 251 and KY 434  
 Item No. 4-153.01

PROJECT: Safety & Spot improvements on KY 251 and KY 434  
 ITEM NUMBER: 4-153.01  
 MARS NUMBER: 8658313P  
 REQUEST DATE: 5/15/2014  
 ANALYST: J.BALAJI  
 SCENARIO: 2035 ADT and Design Hour Volumes  
 INTERSECTION: T1: US 31W @ KY 434

**\*\*DHV TURN MOVEMENT FORECASTS SHOULD NOT BE USED FOR SIGNAL TIMING OR WARRANT ANALYSIS**

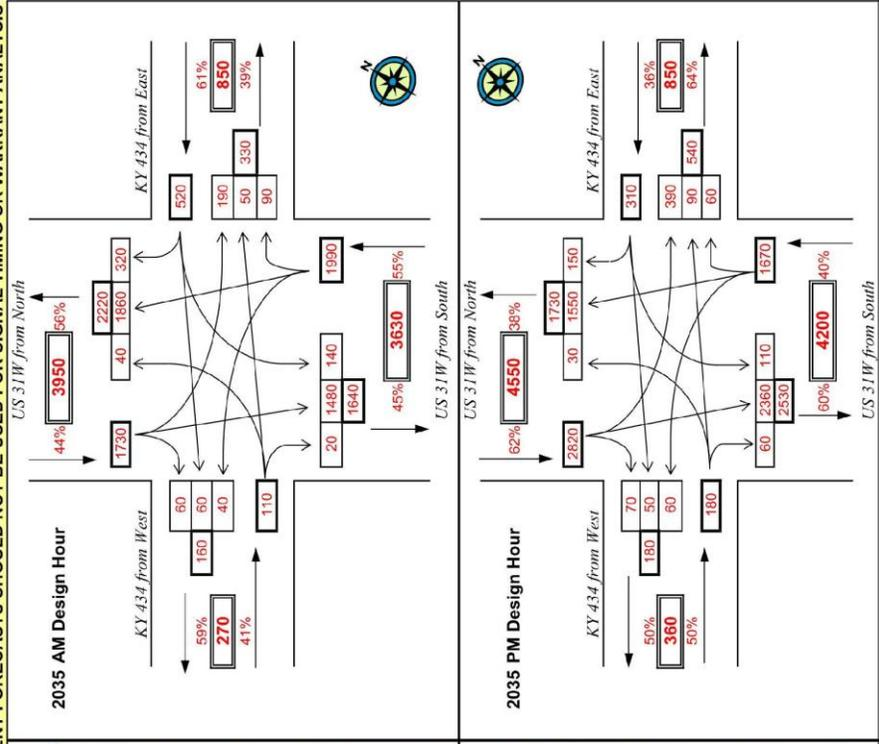
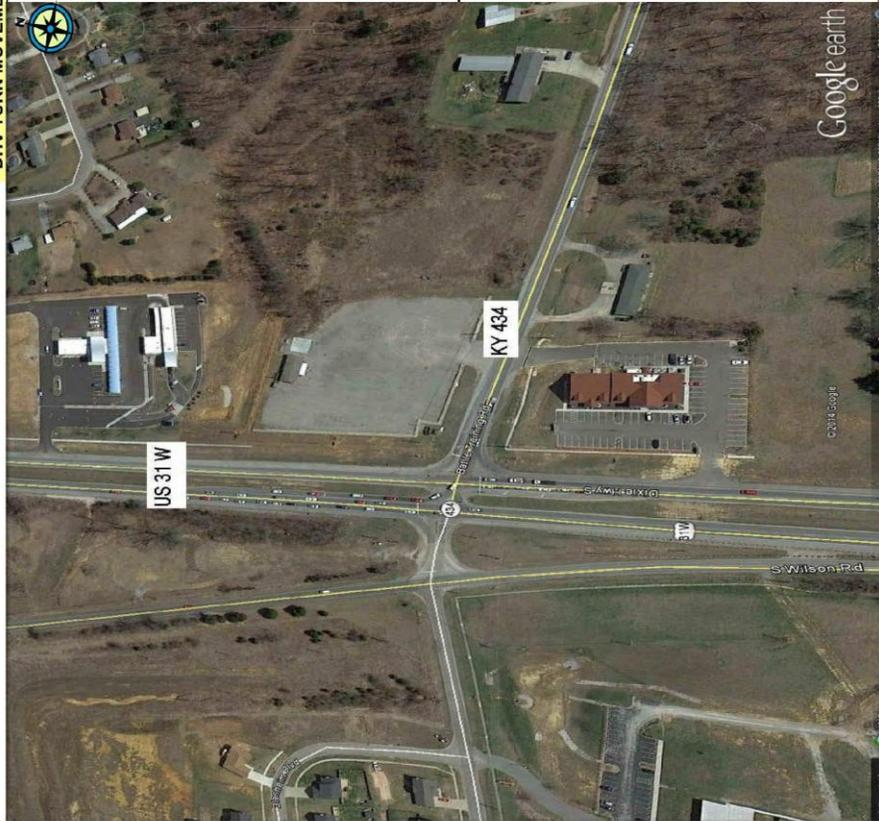

Traffic Forecast Technical Report  
 Hardin County: Minor Widening of KY 251 and KY 434  
 Item No. 4-153.01

PROJECT: Safety & Spot improvements on KY 251 and KY 434  
 ITEM NUMBER: 4-153.01  
 MARS NUMBER: 8658313P  
 REQUEST DATE: 5/15/2014  
 ANALYST: J.BALAJI  
 SCENARIO: 2035 ADT and Design Hour Volumes  
 INTERSECTION: T2: US 31W @ KY 313

\*\*DHV TURN MOVEMENT FORECASTS SHOULD NOT BE USED FOR SIGNAL TIMING OR WARRANT ANALYSIS

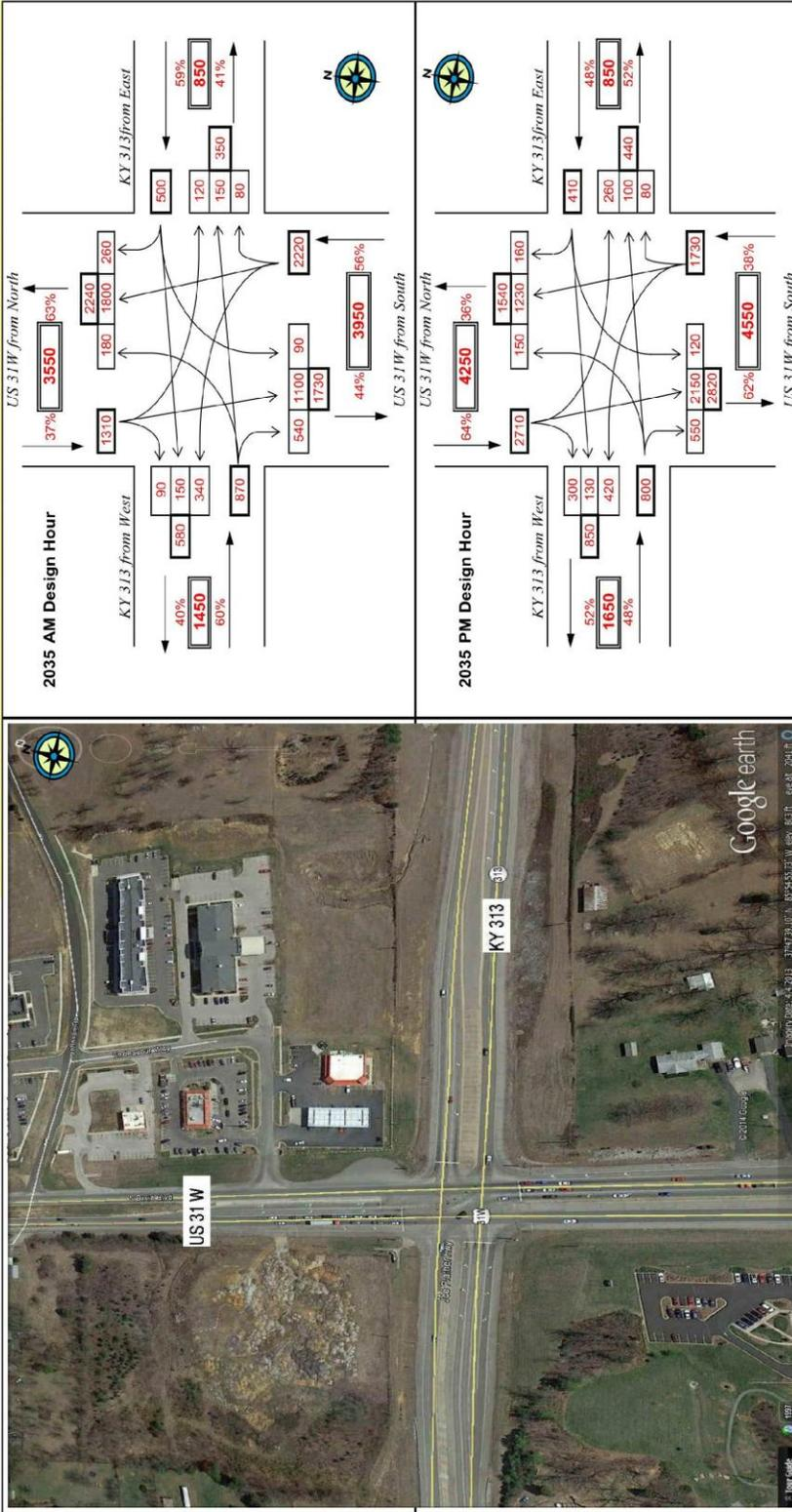

Traffic Forecast Technical Report  
 Hardin County: Minor Widening of KY 251 and KY 434  
 Item No. 4-153.01

PROJECT: Safety & Spot Improvements on KY 251 and KY 434  
 ITEM NUMBER: 4-153.01  
 MARS NUMBER: 8658313P  
 REQUEST DATE: 5/15/2014  
 ANALYST: J.BALAJI  
 SCENARIO: 2040 ADT and Design Hour Volumes  
 INTERSECTION: T3: KY 313 @ KY 251

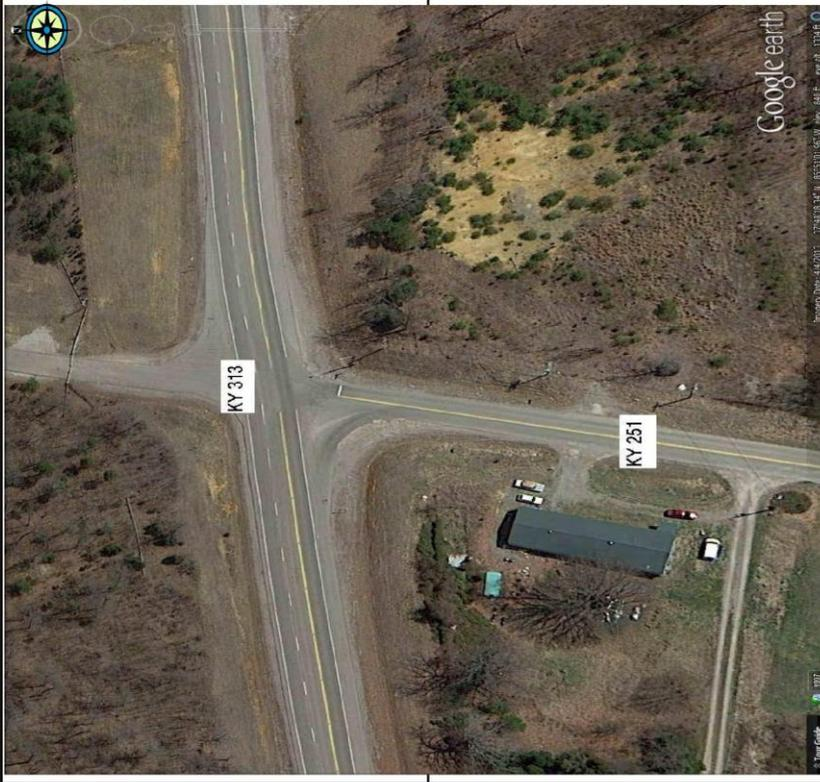

\*\*DHV TURN MOVEMENT FORECASTS SHOULD NOT BE USED FOR SIGNAL TIMING OR WARRANT ANALYSIS

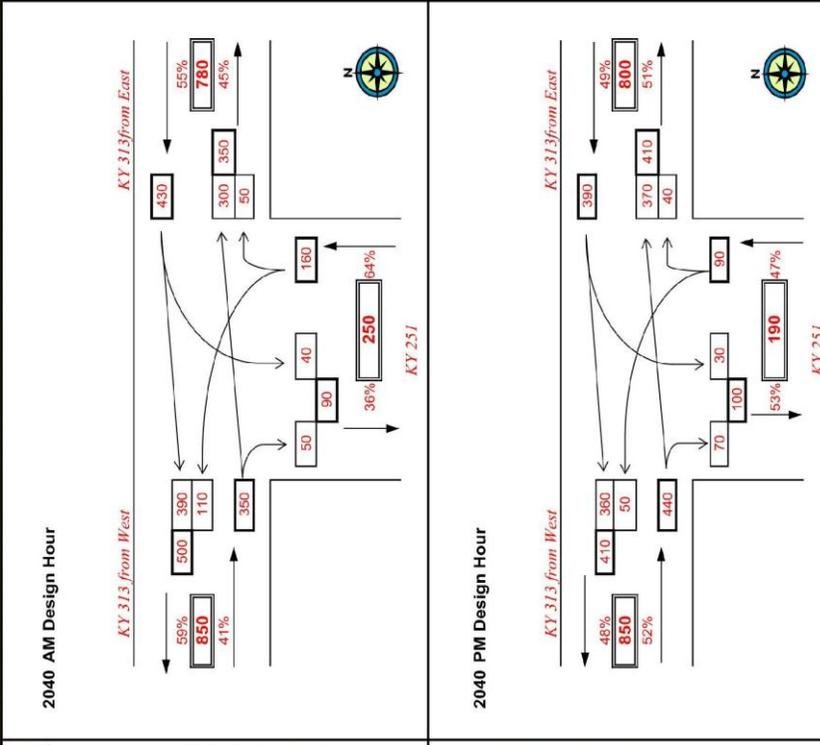

Traffic Forecast Technical Report  
 Hardin County: Minor Widening of KY 251 and KY 434  
 Item No. 4-153.01

PROJECT: Safety & Spot improvements on KY 251 and KY 434  
 ITEM NUMBER: 4-153.01  
 MAPS NUMBER: 8658313P  
 REQUEST DATE: 5/15/2014  
 ANALYST: J.BALAJI  
 SCENARIO: 2035 ADT and Design Hour Volumes  
 INTERSECTION: T4: KY 251 @ KY 434

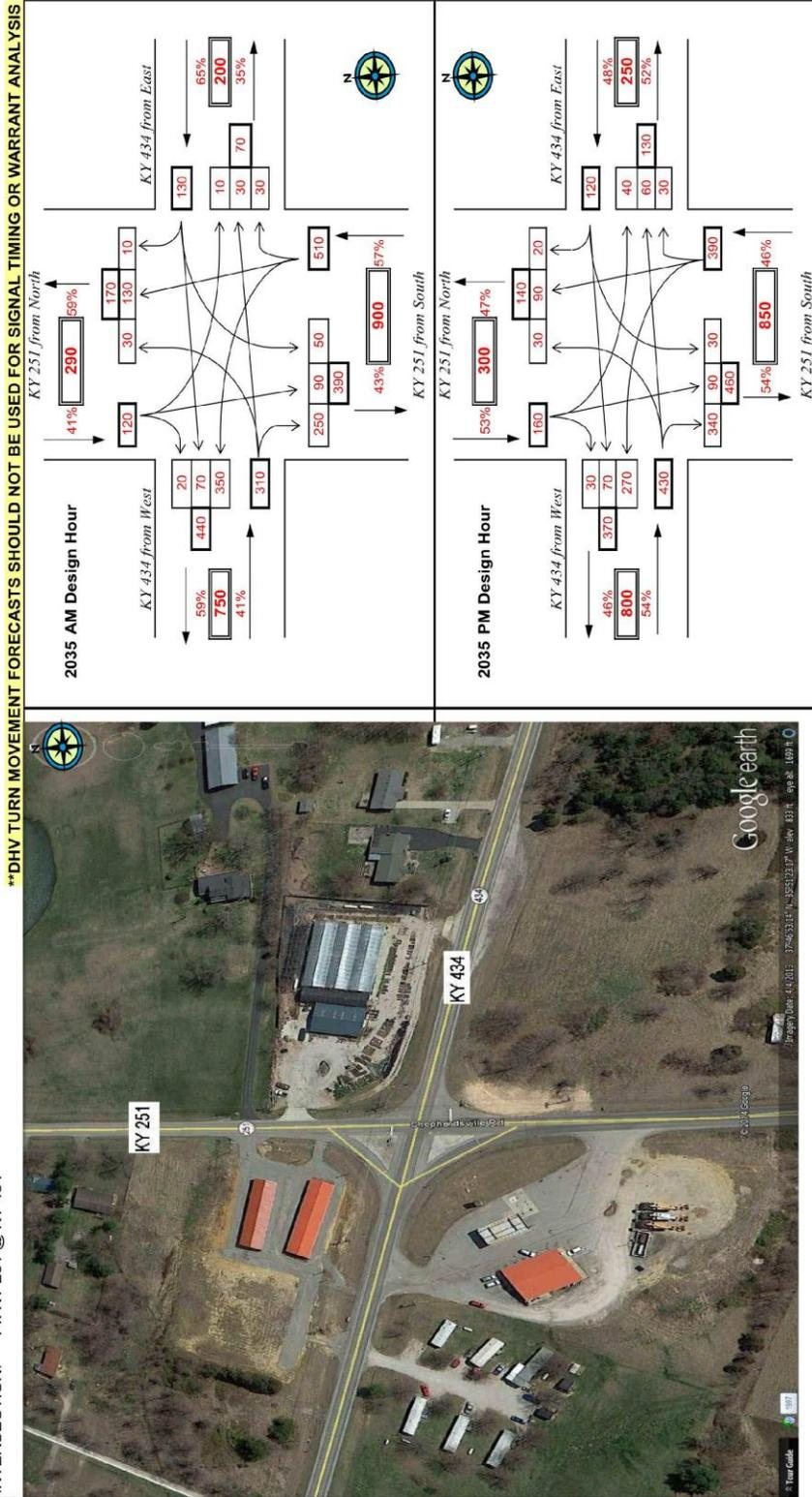

# **ESAL**

Traffic Forecast Technical Report  
 Hardin County: Minor Widening of KY 251 and KY 434  
 Item No. 4-153.01

**FORECAST OF EQUIVALENT SINGLE AXLE LOAD ACCUMULATIONS (20-year)**

**ROUTE ID:**

County	Hardin	Date	11/20/14
Road Name	Battle Training Road	Forecaster	Jay Balaji
Functional Class	8 - Rural Minor Collector	MARS No.	8383101D
Project Description	Safety and Spot improvements on KY 434 and KY 251	Item No.	4-153.01
Scenario	Build	Route No.	KY 434
Segment Description	KY 434 from KY 251 to US 13 W	Beg. MP	0.025
		End MP	3.158
		T.F. No.	TF14-004
		No. of Lanes	2
		1 or 2 way	2

**REFERENCES:**

Previous Forecasts	N/A	K- Factor Value	13.9%
Traffic Volume	047010	K-Factor Source	047010
Milepoint	2.45	PHF	0.91
Truck Percent	047010	Full Route Unique Identifier	047-KY 0434 -000
Milepoint	2.45		
ESAL Information	2.45		
Growth Rate	1.80%		

**TRAFFIC PARAMETERS:**

		Present Year	Growth Rate	Construction Year	Median Year	Design Year
		2014		2015	2025	2035
Volume	(AADT)	4100	1.80%	4200	5000	5900
Percent Trucks	(%T)	7.3%	0.5%	7.4%	8.0%	8.0%
Number of Trucks		300	2.3%	310	400	470
Percent Trucks Hauling Coal	(%CT)	0.0%	0.0%	0.0%	0.0%	0.0%
<i>Non-Coal Trucks:</i>						
Axles/Truck	(A/T)	2.880	0.70%	2.900	3.110	3.334
ESALs/Axle	(ESAL/A)	0.254	1.60%	0.258	0.302	0.354
<i>Coal Trucks:</i>						
Axles/Truck	(A/CT)	0	0.0%	0.000	0.000	0.000
ESALs/Axle	(ESAL/CA)	0	0.0%	0.000	0.000	0.000

**ESAL CALCULATIONS:** SEE ATTACHED ESAL CALCULATION SHEET

Design ESALs in Critical Lane 1,500,000

General Comments:

Traffic Forecast Technical Report  
 Hardin County: Minor Widening of KY 251 and KY 434  
 Item No. 4-153.01

**Safety and Spot improvements on KY 434 and KY 251(ESAL for KY 434)**

Year	ADT	Car %	Truck %	Cars	Trucks	CT%	AX/T	ESAL/AX	AX/CT	ESAL/JCA	LDF	ESALs
2015	4,174	92.6%	7.4%	3866	308	0.00%	2.90	0.26	0	0	0.500	45,582
2016	4,249	92.6%	7.4%	3934	315	0.00%	2.92	0.26	0	0	0.500	47,609
2017	4,325	92.5%	7.5%	4003	322	0.00%	2.94	0.27	0	0	0.500	49,729
2018	4,403	92.5%	7.5%	4074	330	0.00%	2.96	0.27	0	0	0.500	51,947
2019	4,483	92.5%	7.5%	4145	337	0.00%	2.98	0.27	0	0	0.500	54,267
2020	4,563	92.4%	7.6%	4218	345	0.00%	3.00	0.28	0	0	0.500	56,692
2021	4,645	92.4%	7.6%	4292	353	0.00%	3.02	0.28	0	0	0.500	59,230
2022	4,729	92.4%	7.6%	4368	361	0.00%	3.05	0.29	0	0	0.500	61,884
2023	4,814	92.3%	7.7%	4445	370	0.00%	3.07	0.29	0	0	0.500	64,660
2024	4,901	92.3%	7.7%	4523	378	0.00%	3.09	0.30	0	0	0.500	67,563
2025	4,989	92.2%	7.8%	4602	387	0.00%	3.11	0.30	0	0	0.500	70,601
2026	5,079	92.2%	7.8%	4683	396	0.00%	3.13	0.31	0	0	0.500	73,778
2027	5,170	92.2%	7.8%	4765	405	0.00%	3.15	0.31	0	0	0.500	77,101
2028	5,263	92.1%	7.9%	4849	414	0.00%	3.18	0.32	0	0	0.500	80,578
2029	5,358	92.1%	7.9%	4934	424	0.00%	3.20	0.32	0	0	0.500	84,215
2030	5,454	92.1%	7.9%	5021	434	0.00%	3.22	0.33	0	0	0.500	88,019
2031	5,553	92.0%	8.0%	5109	444	0.00%	3.24	0.33	0	0	0.500	91,999
2032	5,653	92.0%	8.0%	5199	454	0.00%	3.27	0.34	0	0	0.500	96,163
2033	5,754	91.9%	8.1%	5290	464	0.00%	3.29	0.34	0	0	0.500	100,518
2034	5,858	91.9%	8.1%	5383	475	0.00%	3.31	0.35	0	0	0.500	105,075
2035	5,963	91.8%	8.2%	5477	486	0.00%	3.33	0.35	0	0	0.500	109,843

5-yr ESALS  
300,000

10-yr ESALS  
600,000

15-yr ESALS  
1,000,000

20-yr ESALS  
1,500,000

*Traffic Forecast Technical Report  
Hardin County: Minor Widening of KY 251 and KY 434  
Item No. 4-153.01*

**FORECAST OF EQUIVALENT SINGLE AXLE LOAD ACCUMULATIONS (20-year)**

**ROUTE ID:**

County	Hardin	Date	11/20/14
Road Name	Sheperdsville Road	Forecaster	Jay Balaji
Functional Class	16 - Urban Minor Arterial	MARS No.	8383101D
Project Description	Safety and Spot improvements on KY 434 and KY 251	Item No.	4-153.01
Scenario	Build	Route No.	KY 251
Segment Description	KY 251 from KY 3005 to KY 434	Beg. MP	2.681
		End MP	6.288
		T.F. No.	TF14-004
		No. of Lanes	2
		1 or 2 way	2

**REFERENCES:**

Previous Forecasts	N/A	K- Factor Value	11.8%
Traffic Volume	047B57	K-Factor Source	047B57
Milepoint	3.5	PHF	0.91
Truck Percent	047B57	Full Route Unique Identifier	
Milepoint	3.5		047-KY 0251 -000
ESAL Information	3.5		
Growth Rate	2.00%		

**TRAFFIC PARAMETERS:**

		Present Year	Growth Rate	Construction Year	Median Year	Design Year
		2014		2015	2025	2035
Volume	(AADT)	5700	2.00%	5800	7100	9000
Percent Trucks	(%T)	4.4%	0.5%	4%	5%	5%
Number of Trucks		250	2.5%	260	330	450
Percent Trucks Hauling Coal	(%CT)	0%	0.0%	0%	0%	0%
<i>Non-Coal Trucks:</i>						
Axles/Truck	(A/T)	2.980	1.00%	3.010	3.325	3.673
ESALs/Axle	(ESAL/A)	0.200	2.00%	0.204	0.249	0.303
<i>Coal Trucks:</i>						
Axles/Truck	(A/CT)	0	0.00%	0.000	0.000	0.000
ESALs/Axle	(ESAL/CA)	0	0.00%	0.000	0.000	0.000

**ESAL CALCULATIONS:** SEE ATTACHED ESAL CALCULATION SHEET

Design ESALs in Critical Lane 1,200,000

General Comments:

Traffic Forecast Technical Report  
 Hardin County: Minor Widening of KY 251 and KY 434  
 Item No. 4-153.01

**Safety and Spot Improvements on KY 434 and KY 251(ESAL for KY 251)**

Year	ADT	Car %	Truck %	Cars	Trucks	CT%	AX/T	ESAL/AX	AX/CT	ESAL/CA	LDF	ESALS
2015	5,814	95.6%	4.4%	5557	257	0.00%	3.01	0.20	0	0	0.500	33,879
2016	5,930	95.6%	4.4%	5667	264	0.00%	3.04	0.21	0	0	0.500	35,595
2017	6,049	95.5%	4.5%	5779	270	0.00%	3.07	0.21	0	0	0.500	37,402
2018	6,170	95.5%	4.5%	5893	277	0.00%	3.10	0.22	0	0	0.500	39,308
2019	6,293	95.5%	4.5%	6009	284	0.00%	3.13	0.22	0	0	0.500	41,316
2020	6,419	95.5%	4.5%	6128	291	0.00%	3.16	0.23	0	0	0.500	43,433
2021	6,548	95.4%	4.6%	6249	298	0.00%	3.19	0.23	0	0	0.500	45,665
2022	6,678	95.4%	4.6%	6373	306	0.00%	3.23	0.23	0	0	0.500	48,018
2023	6,812	95.4%	4.6%	6499	313	0.00%	3.26	0.24	0	0	0.500	50,498
2024	6,948	95.4%	4.6%	6627	321	0.00%	3.29	0.24	0	0	0.500	53,114
2025	7,087	95.4%	4.6%	6758	329	0.00%	3.32	0.25	0	0	0.500	55,872
2026	7,229	95.3%	4.7%	6891	338	0.00%	3.36	0.25	0	0	0.500	58,780
2027	7,374	95.3%	4.7%	7027	346	0.00%	3.39	0.26	0	0	0.500	61,847
2028	7,521	95.3%	4.7%	7166	355	0.00%	3.43	0.26	0	0	0.500	65,081
2029	7,671	95.3%	4.7%	7308	364	0.00%	3.46	0.27	0	0	0.500	68,492
2030	7,825	95.2%	4.8%	7452	373	0.00%	3.49	0.27	0	0	0.500	72,089
2031	7,981	95.2%	4.8%	7599	382	0.00%	3.53	0.28	0	0	0.500	75,883
2032	8,141	95.2%	4.8%	7749	392	0.00%	3.56	0.29	0	0	0.500	79,885
2033	8,304	95.2%	4.8%	7902	402	0.00%	3.60	0.29	0	0	0.500	84,107
2034	8,470	95.1%	4.9%	8058	412	0.00%	3.64	0.30	0	0	0.500	88,560
2035	8,639	95.1%	4.9%	8217	422	0.00%	3.67	0.30	0	0	0.500	93,257

5-yr ESALS  
200,000

10-yr ESALS  
500,000

15-yr ESALS  
800,000

20-yr ESALS  
1,200,000

## **Bicycle and Pedestrian Review for Project #4-153.01**

### **Project Overview:**

Project includes minor widening and spot improvements on KY-251 from KY-3005 to KY-434. Also includes minor widening and spot improvements on KY-434 from KY-251 to US-31W. Project improvements recommended by a 2012 KYTC Planning Study.

### **Local/regional Planning:**

No known specific bicycle or pedestrian planning for this area

### **Existing conditions:**

- KY-251 MP 2.7-6.3
  - a) ADT is 5320 (2011) at MP 3.3 Sta#B57
  - b) ADT is 4450 (2011) at MP 4.3 Sta#087
  - c) Posted Speed Limit from MP 2.7-2.95 is 35MPH
  - d) Posted Speed Limit from MP 2.95-6.3 is 55MPH
  - e) Curb and gutter from MP 2.7-2.95
  - f) Rural cross section with no shoulder MP 2.95-6.3
  - g) Bicyclists Comfort Index (BCI) rating is an D (MP 2.7-2.95)
  - h) Bicyclists Comfort Index (BCI) rating is an E (MP 2.95-6.3)
- KY-434 MP 0.0-3.1
  - a) ADT is 4167 (2012) at MP 2.9 Sta#010
  - b) ADT is 9040 (2011) at MP 0.3 Sta#D68
  - c) Posted Speed Limit is 55MP
  - d) No shoulder
  - e) Bicyclists Comfort Index (BCI) rating is an E

### **The KYTC Bicycle and Pedestrian program team recommendations are:**

The Bicycle and Pedestrian program team's recommendations are:

- KY-251 MP 2.7-6.3

**Best:**

  - a. Continue the side walk section located at MP 2.95 if the curb and gutter design is chosen through the extent of the project.
  - b. If the design is a rural cross section, construct a shoulder of 8 feet (or more) within the highway. The shoulder would accommodate cyclist by providing a gap spacing of 10-14 feet within the rumble strips every 40-60 feet. This would provide a BCI of C

**Good:**

Provide a shoulder of 6 feet (or more) within the highway. The shoulder would accommodate cyclist by providing a gap spacing of 10-14 feet within the rumble strips every 40-60 feet. This would provide a BCI of C

0

*Traffic Forecast Technical Report  
Hardin County: Minor Widening of KY 251 and KY 434  
Item No. 4-153.01*

**Fair:**

Provide a shoulder of 6 feet (or more) within the highway.

- KY-434 MP 0.0-3.1

**Best:**

Provide a shoulder of 8 feet (or more) within the highway. The shoulder would accommodate cyclist by providing a gap spacing of 10-14 feet within the rumble strips every 40-60 feet. This would provide a BCI of C

**Good:**

Provide a shoulder of 6 feet (or more) within the highway. The shoulder would accommodate cyclist by providing a gap spacing of 10-14 feet within the rumble strips every 40-60 feet. This would provide a BCI of C

**Fair:**

Provide a shoulder of 6 feet (or more) within the highway.

❖ BCI: <http://transportation.ky.gov/Bike-Walk/Documents/Bicyclists%20Comfort%20Index.pdf>

Prepared by:  
**Troy Hearn, Bicycle & Pedestrian Program Coordinator**  
Division of Planning, [www.transportation.ky.gov/Bike-Walk](http://www.transportation.ky.gov/Bike-Walk)  
Kentucky Transportation Cabinet  
December 3, 2014

**MEMORANDUM**

**(R-032-2015)**

**TO: Larry Krueger, PE  
Transportation Engineer Supervisor  
District 4, Project Development - Design**

**FROM: Bart Asher, PE, PLS  
Geotechnical Branch Manager  
Division of Structural Design**

**BY: J.C. Wilhoite, PE  
Geotechnical Branch**

**DATE: September 18, 2015**

**SUBJECT: Hardin County  
JP02 047 0251 002-007 D  
KY 251 and KY 434 Safety and Spot Improvements  
KY 251 Station 175+00.00 to 348+00.00  
KY 434 Station 500+00.00 to 665+00.00  
Item # 04-0153.01  
Mars # 8383101D  
Geotechnical Exploration and Test Summary**

A geotechnical exploration and test summary has been completed for the subject project. Drilling and sampling were performed by HDR/ICA. Laboratory testing was performed by the Geotechnical Branch. The purpose of this report is to provide the designer with pavement and soil subgrade information. This project involves safety and spot improvements to KY 251 and KY 434. At the request of District 4 personnel, six locations were drilled to determine the pavement composition, thickness, and the properties of the underlying subgrade soils. The locations for the borings were provided by the district.

Of the six samples taken, five samples were low plasticity clays and one was a high plasticity clay. The California Bearing Ratio (CBR) test results ranged from 1.1 to 9.6 with five of the six samples exceeding a CBR of 4. The lone sample consisting of high plasticity clay was the only CBR test result to fall below 4. This sample was encountered below the pavement section along KY 434 at station 644+99.96.

All of the sample locations encountered a layer of asphalt at the surface ranging from 0.6 to 1.0 feet in thickness. The sample locations along KY 251 encountered a layer of DGA directly beneath the asphalt with thicknesses ranging from 0.5 to 0.8 feet. The sample locations along KY 434 encountered a concrete layer directly beneath the asphalt with thicknesses ranging from 0.6 to 0.7 feet. The following table summarizes the results of the findings from the drilling and testing.

Road	Station	Asphalt (ft)	DGA (ft)	Concrete (ft)	CBR	Subgrade
<b>KY 251</b>	185+00.02, 5.4' RT	1.0	0.5	-	5.5	Soft, moist, brown clay (CL)
	260+00.05, 4.5' RT	1.0	0.5	-	9.6	Soft, brown clay (CL)
	335+00.01, 4.9' RT	0.7	0.8	-	4.4	Moist, reddish brown clay (CL)
<b>KY 434</b>	529+99.92, 7.0' RT	0.8	-	0.6	5.0	Moist, brown clay (CL)
	590+00.12, 6.5' RT	0.6	-	0.7	8.2	Moist, brown clay (CL)
	644+99.96, 5.9' RT	0.8	-	0.7	1.1	Moist, light brown clay (CH)

If you have any questions, please contact the Division of Structural Design, Geotechnical Branch.

Project Description: 4-153.01 0 Hardin County KY 251  
 Analysis Date: 6/16/2015

Note: Fields in yellow/require user input. Fields in orange/low user input. Material type selection lists may be edited in the "Bid Items" Worksheet

Structural Design Inputs

Design CBR 4.4  
 Design ESAL's 1,200,000  
 Construction Year ADT 5,700  
 Construction Year Truck Percentage 4.4  
 Design Life (years) 20  
 Analysis Period (years) 40  
 Check if User will define layer thickness   
 Length of Project (miles) 0  
 Total Number of Lanes, One Direction  
 Lane Width (feet)  
 Number of Directions (1 or 2)  
 Inside Paved Shoulder width (feet)  
 Outside Paved Shoulder width (feet)  
 Length of Initial Construction (Default 120 days) 120  
 Daily User Cost (\$) 0  
 (Width of individual lane)

Subgrade stabilization:  None

Lime  Cement  Rock & Fabric  
 Stabilization Thickness = inches (Default thickness is 8 inches for lime/cement and 12 inches for rock)

Pavement Structural Design From Design Catalog

Required Structural Number 4.49 (Designed Pavement structure should satisfy Required Structural Number to within +/- 0.05)  
 Required JPC Pavement Thickness 8.00 (Minimum Concrete Pavement Thickness is 8 inches)

Unit Costs for this project were provided by the Engineering Estimating Section

NOTE: Verify material types for each design to insure the cost calculations are correct.

**Maximum Asphalt Design**

	Default Layer Thickness (in.)				User Defined Thickness (in.)			Final Design Thickness (in.)		
	Design	SN	Nominal	SN	Mainline	Shoulder	SN	Mainline	Shoulder	SN
Surface	1.25	0.55	1.25	0.55	1.25	1.25	0.55	1.25	1.25	0.55
Base Total (in) 8.4										
Layer 1	4.22	1.69	3.00	1.20	3.00	3.00	1.20	3.00	3.00	1.20
Layer 2	4.22	1.69	3.00	1.20	3.00	3.00	1.20	3.00	3.00	1.20
Layer 3	0.00	0.00	3.00	1.20	3.00	3.00	1.20	3.00	3.00	1.20
Layer 4	0.00	0.00	0.00	0.00			0.00	0.00	0.00	0.00
Drainage Blanket-Ty II-Asphalt	0.00	0.00	0.00	0.00			0.00	0.00	0.00	0.00
Crushed Stone Base	4.00	0.56	4.00	0.56	4.00	4.00	0.56	4.00	4.00	0.56
Stabilized Roadbed	0.00	0.00	0.00	0.00	0.00	0.00	0.00	0.00	0.00	0.00
	4.49		SN 4.71				Total SN 4.71			Total SN 4.71

**Maximum Asphalt Design** Initial Cost: 0 #/N/A #/N/A lowest initial cost alternate

Driving Lane Material Selection			Shoulder Material Selection		
Item Code	Description	Unit Cost	Item Code	Description	Unit Cost
307	CL 2 ASPH SURF 0.38B PG64-22	66.75	301	CL 2 ASPH SURF 0.38D PG64-22	67.72
212	CL 2 ASPH BASE 1.00D PG64-22	55.78	212	CL 2 ASPH BASE 1.00D PG64-22	55.78
212	CL 2 ASPH BASE 1.00D PG64-22	55.78	212	CL 2 ASPH BASE 1.00D PG64-22	55.78
212	CL 2 ASPH BASE 1.00D PG64-22	55.78	212	CL 2 ASPH BASE 1.00D PG64-22	55.78
#/N/A		#/N/A	#/N/A		#/N/A
#/N/A		#/N/A	#/N/A		#/N/A
3	Crushed Stone Base	17.50	3	Crushed Stone Base	17.50
#/N/A		0	#/N/A		0

**Maximum Aggregate Design**

	Default Layer Thickness (in.)				User Defined Thickness (in.)			Final Design Thickness (in.)		
	Design	SN	Nominal	SN	Mainline	Shoulder	SN	Mainline	Shoulder	SN
Surface	1.25	0.55	1.25	0.55			0.00	0.00	0.00	0.00
Base Total (in) 5.7										
Layer 1	2.82	1.13	2.75	1.10			0.00	0.00	0.00	0.00
Layer 2	2.83	1.13	3.00	1.20			0.00	0.00	0.00	0.00
Layer 3	0.00	0.00	0.00	0.00			0.00	0.00	0.00	0.00
Layer 4	0.00	0.00	0.00	0.00			0.00	0.00	0.00	0.00
Drainage Blanket-Ty II-Asphalt	0.00	0.00	0.00	0.00			0.00	0.00	0.00	0.00
Crushed Stone Base	13.80	1.93	14.00	1.96			0.00	0.00	0.00	0.00
Stabilized Roadbed	0.00	0.00	0.00	0.00	0.00	0.00	0.00	0.00	0.00	0.00
	4.74		SN 4.81				Total SN 0.00			Total SN 0.00

**Maximum Aggregate Design** Initial Cost: 0 #/N/A #/N/A lowest initial cost alternate

Driving Lane Material Selection			Shoulder Material Selection		
Item Code	Description	Unit Cost	Item Code	Description	Unit Cost
307	CL 2 ASPH SURF 0.38B PG64-22	66.75	301	CL 2 ASPH SURF 0.38D PG64-22	67.72
221	CL 2 ASPH BASE 0.75D PG64-22	63.18	221	CL 2 ASPH BASE 0.75D PG64-22	63.18
#/N/A		#/N/A	#/N/A		#/N/A
#/N/A		#/N/A	#/N/A		#/N/A
#/N/A		#/N/A	#/N/A		#/N/A
#/N/A		#/N/A	#/N/A		#/N/A
3	Crushed Stone Base	17.50	3	Crushed Stone Base	17.50
#/N/A		0	#/N/A		0

**Concrete Pavement Design**

	Default Layer Thickness (in.)				User Defined Thickness (in.)			Final Design Thickness (in.)		
	Design	SN	Nominal	SN	Mainline	Shoulder	SN	Mainline	Shoulder	SN
JPC Pavement Thickness (in)	8.0		8.0		8.0			8.0		
AC Shoulder Surface								0.00		
AC Shoulder Base								0.00		
Layer 1								0.00		
Layer 2								0.00		
Layer 3								0.00		
Layer 4								0.00		
JPC Pavement Drainage Blanket	0.0		0.0					0.00		
Crushed Stone Base	4.0		4.0					0.00		

**Concrete Pavement Design** Initial Cost: #/N/A #/N/A #/N/A lowest initial cost alternate

Driving Lane Material Selection			Shoulder Material Selection		
Item Code	Description	Unit Cost	Item Code	Description	Unit Cost
#/N/A		#/N/A	JPC Shoulder		#/N/A
#/N/A		#/N/A	Asphalt Shoulder Surface		#/N/A
#/N/A		#/N/A	Asphalt Shoulder Base		#/N/A
#/N/A		#/N/A	Layer 1		#/N/A
#/N/A		#/N/A	Layer 2		#/N/A
#/N/A		#/N/A	Layer 3		#/N/A
#/N/A		#/N/A	Layer 4		#/N/A
#/N/A		#/N/A	Drainage Blanket		#/N/A
3	Crushed Stone Base	17.50	3	Crushed Stone Base	17.50



Project Description: 4-153.01 0 Hardin County KY 434  
 Analysis Date: 6/16/2015

Note: Fields in yellow/require user input. Fields in orange/low user input. Material type selection lists may be edited in the "Bid Items" Worksheet

Structural Design Inputs

Design CBR 5.5  
 Design ESAL's 1,500,000  
 Construction Year ADT 4,100  
 Construction Year Truck Percentage 7.3  
 Design Life (years) 20  
 Analysis Period (years) 40  
 Check if User will define layer thickness   
 Subgrade stabilization:  None  
 Lime  Cement  Rock & Fabric  
 Stabilization Thickness = inches (Default thickness is 8 inches for lime/cement and 12 inches for rock)  
 Length of Project (miles) 3.1  
 Total Number of Lanes, One Direction  
 Lane Width (feet)  
 Number of Directions (1 or 2)  
 Inside Paved Shoulder width (feet)  
 Outside Paved Shoulder width (feet)  
 Length of Initial Construction (Default 120 days) 120  
 Daily User Cost (\$) 0  
 (Width of individual lane)

Pavement Structural Design From Design Catalog

Required Structural Number 4.40 (Designed Pavement structure should satisfy Required Structural Number to within +/- 0.05)  
 Required JPC Pavement Thickness 8.00 (Minimum Concrete Pavement Thickness is 8 inches)

Unit Costs for this project were provided by the Engineering Estimating Section

NOTE: Verify material types for each design to insure the cost calculations are correct.

**Maximum Asphalt Design**

	Default Layer Thickness (in.)				User Defined Thickness (in.)			Final Design Thickness (in.)		
	Design	SN	Nominal	SN	Mainline	Shoulder	SN	Mainline	Shoulder	SN
Surface	1.25	0.55	1.25	0.55	1.25	1.25	0.55	1.25	1.25	0.55
Base Total (in) 8.2										
Layer 1	4.11	1.64	3.00	1.20	3.00	3.00	1.20	3.00	3.00	1.20
Layer 2	4.11	1.64	3.00	1.20	3.00	3.00	1.20	3.00	3.00	1.20
Layer 3	0.00	0.00	3.00	1.20	3.00	3.00	1.20	3.00	3.00	1.20
Layer 4	0.00	0.00	0.00	0.00			0.00	0.00	0.00	0.00
Drainage Blanket-Ty II-Asphalt	0.00	0.00	0.00	0.00			0.00	0.00	0.00	0.00
Crushed Stone Base	4.00	0.56	4.00	0.56	4.00	4.00	0.56	4.00	4.00	0.56
Stabilized Roadbed	0.00	0.00	0.00	0.00	0.00	0.00	0.00	0.00	0.00	0.00
	4.40						4.71			4.71

**Maximum Asphalt Design** Initial Cost: 31,000 #/N/A #/N/A lowest initial cost alternate

Driving Lane Material Selection				Shoulder Material Selection			
Item Code	Description	Unit Cost	Item Code	Description	Unit Cost	Item Code	Description
301	CL 2 ASPH SURF 0.38D PG64-22	67.72	301	CL 2 ASPH SURF 0.38D PG64-22	67.72		
212	CL 2 ASPH BASE 1.00D PG64-22	55.78	212	CL 2 ASPH BASE 1.00D PG64-22	55.78		
212	CL 2 ASPH BASE 1.00D PG64-22	55.78	212	CL 2 ASPH BASE 1.00D PG64-22	55.78		
212	CL 2 ASPH BASE 1.00D PG64-22	55.78	212	CL 2 ASPH BASE 1.00D PG64-22	55.78		
#/N/A		#/N/A	#/N/A		#/N/A	#/N/A	
#/N/A		#/N/A	3	Crushed Stone Base	17.50	#/N/A	
#/N/A		#/N/A			0	#/N/A	

**Maximum Aggregate Design**

	Default Layer Thickness (in.)				User Defined Thickness (in.)			Final Design Thickness (in.)		
	Design	SN	Nominal	SN	Mainline	Shoulder	SN	Mainline	Shoulder	SN
Surface	1.25	0.55	1.25	0.55			0.00	0.00	0.00	0.00
Base Total (in) 5.4										
Layer 1	2.72	1.09	2.75	1.10			0.00	0.00	0.00	0.00
Layer 2	2.72	1.09	2.75	1.10			0.00	0.00	0.00	0.00
Layer 3	0.00	0.00	0.00	0.00			0.00	0.00	0.00	0.00
Layer 4	0.00	0.00	0.00	0.00			0.00	0.00	0.00	0.00
Drainage Blanket-Ty II-Asphalt	0.00	0.00	0.00	0.00			0.00	0.00	0.00	0.00
Crushed Stone Base	13.39	1.87	13.50	1.89			0.00	0.00	0.00	0.00
Stabilized Roadbed	0.00	0.00	0.00	0.00	0.00	0.00	0.00	0.00	0.00	0.00
	4.60						0.00			0.00

**Maximum Aggregate Design** Initial Cost: 31,000 #/N/A #/N/A lowest initial cost alternate

Driving Lane Material Selection				Shoulder Material Selection			
Item Code	Description	Unit Cost	Item Code	Description	Unit Cost	Item Code	Description
301	CL 2 ASPH SURF 0.38D PG64-22	67.72	301	CL 2 ASPH SURF 0.38D PG64-22	67.72		
221	CL 2 ASPH BASE 0.75D PG64-22	63.18	221	CL 2 ASPH BASE 0.75D PG64-22	63.18		
#/N/A		#/N/A	#/N/A		#/N/A	#/N/A	
#/N/A		#/N/A	#/N/A		#/N/A	#/N/A	
#/N/A		#/N/A	#/N/A		#/N/A	#/N/A	
#/N/A		#/N/A	3	Crushed Stone Base	17.50	#/N/A	
#/N/A		#/N/A			0	#/N/A	

**Concrete Pavement Design**

	Default Layer Thickness (in.)				User Defined Thickness (in.)			Final Design Thickness (in.)		
	Design	SN	Nominal	SN	Mainline	Shoulder	SN	Mainline	Shoulder	SN
JPC Pavement Thickness (in)	8.0		8.0		8.0			8.0		
AC Shoulder Surface								0.00		
AC Shoulder Base								0.00		
Layer 1								0.00		
Layer 2								0.00		
Layer 3								0.00		
Layer 4								0.00		
JPC Pavement Drainage Blanket	0.0		0.0					0.00		
Crushed Stone Base	4.0		4.0					0.00		

**Concrete Pavement Design** Initial Cost: #/N/A #/N/A #/N/A lowest initial cost alternate

Driving Lane Material Selection				Shoulder Material Selection			
Item Code	Description	Unit Cost	Item Code	Description	Unit Cost	Item Code	Description
#/N/A		#/N/A	JPC Shoulder		#/N/A	#/N/A	
#/N/A		#/N/A	Asphalt Shoulder Surface		#/N/A	#/N/A	
#/N/A		#/N/A	Asphalt Shoulder Base		#/N/A	#/N/A	
#/N/A		#/N/A	Layer 1		#/N/A	#/N/A	
#/N/A		#/N/A	Layer 2		#/N/A	#/N/A	
#/N/A		#/N/A	Layer 3		#/N/A	#/N/A	
#/N/A		#/N/A	Layer 4		#/N/A	#/N/A	
#/N/A		#/N/A	Drainage Blanket		#/N/A	#/N/A	
#/N/A		#/N/A	Aggregate Base	3	Crushed Stone Base	17.50	



**DATE:** 6/16/2015

**I. PROJECT INFORMATION**

**Item No:** 4-153.01 **County:** Hardin

**Route:** 0

**Project Length:** 0 miles

**Letting:** 10/1/2015

- Alternative 1: Asphalt Pavement
- Alternative 2: Concrete Pavement
- Alternative 3: Alternate Pavement Bidding

Alternative Selected: \_\_\_\_\_

\_\_\_\_\_  
State Highway Engineer

\_\_\_\_\_  
Date

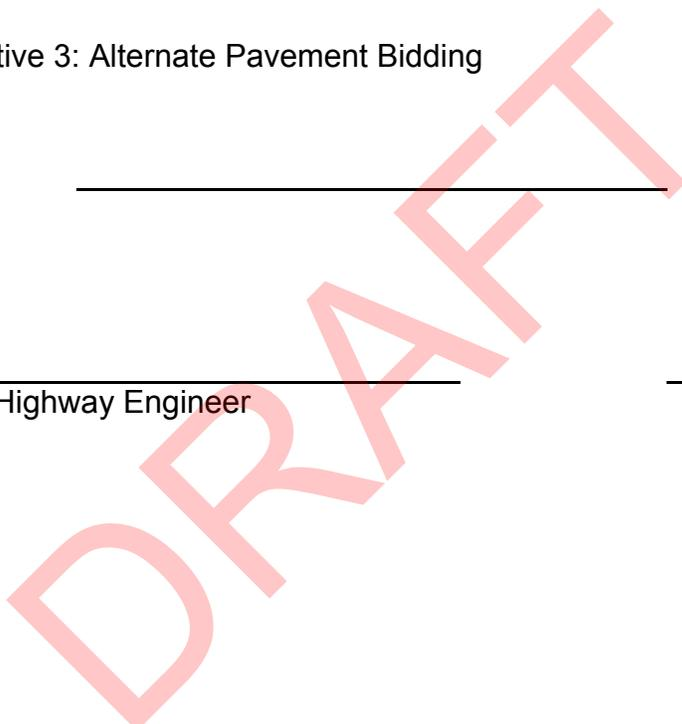

KENTUCKY TRANSPORTATION CABINET  
 DIVISION OF HIGHWAY DESIGN  
 PAVEMENT BRANCH

TC 61-29  
 REV. 02-07

Sheet 1

**Pavement Design <20,000,000 ESALs  
 & Off the National Highway System**

County Hardin Item 4-153.01 UPN 0  
 Road Name KY 251 ( ) F.P.   
 Description Reconstruction of KY 251 from Bluegrass Road to intection  
with KY 434.

Traffic 5,700 2016 9,000 2036 ESAL 1,200,000 20-yr  
 Existing: Type Asphalt Thickness 12 inches  
 Length 3.30 Miles Design Speed 45 M.P.H. Design CBR 4.4

Note:

FOR TYPICAL SECTION SEE ATTACHED SHEET(S)

**ROADBED PREPARATION**

**PAVEMENT**

**Asphalt Alternate**

Traffic Lanes:

3 Crushed Stone Base 4" depth  
 212 CL 2 ASPH BASE 1.00D PG64-22 3" depth  
 212 CL 2 ASPH BASE 1.00D PG64-22 3" depth  
 212 CL 2 ASPH BASE 1.00D PG64-22 3" depth  
 307 CL 2 ASPH SURF 0.38B PG64-22 1.25" depth

Shoulders:

3 Crushed Stone Base 4" depth  
 212 CL 2 ASPH BASE 1.00D PG64-22 3" depth  
 #N/A CL 2 ASPH BASE 1.00D PG64-22 3" depth  
 212 CL 2 ASPH BASE 1.00D PG64-22 3" depth  
 301 CL 2 ASPH SURF 0.38D PG64-22 1.25" depth

SUBMITTED: BFW Engineering & Testing, Inc. DATE: 9-22-15

Designer

APPROVED \_\_\_\_\_ DATE \_\_\_\_\_

Project Manager



KENTUCKY TRANSPORTATION CABINET  
 DIVISION OF HIGHWAY DESIGN  
 PAVEMENT BRANCH

TC 61-29  
 REV. 02-07

Sheet 1

**Pavement Design <20,000,000 ESALs  
 & Off the National Highway System**

County Hardin Item 4-153.01 UPN 0  
 Road Name KY 434 ( ) F.P.   
 Description

Traffic 4,100 2016  2036 ESAL 1,500,000 20-yr  
 Existing: Type  Thickness  inches  
 Length 3.10 Miles Design Speed  M.P.H. Design CBR 5.5

Note:

FOR TYPICAL SECTION SEE ATTACHED SHEET(S)

**ROADBED PREPARATION**

**PAVEMENT**

Traffic Lanes:

3 Crushed Stone Base 4" depth  
 212 CL 2 ASPH BASE 1.00D PG64-22 3" depth  
 212 CL 2 ASPH BASE 1.00D PG64-22 3" depth  
 212 CL 2 ASPH BASE 1.00D PG64-22 3" depth  
 301 CL 2 ASPH SURF 0.38D PG64-22 1.25" depth

Shoulders:

3 Crushed Stone Base 4" depth  
 212 CL 2 ASPH BASE 1.00D PG64-22 3" depth  
 #N/A CL 2 ASPH BASE 1.00D PG64-22 3" depth  
 212 CL 2 ASPH BASE 1.00D PG64-22 3" depth  
 301 CL 2 ASPH SURF 0.38D PG64-22 1.25" depth

SUBMITTED: BFW Engineering

DATE: 9-22-15

Designer

RECOMMENDED \_\_\_\_\_ DATE \_\_\_\_\_

Project Manager

APPROVED \_\_\_\_\_ DATE \_\_\_\_\_

TEBM for Pavements

Asphalt Seal required from outside edge of paved shoulder to a point 2 feet down the ditch or fill slope. Two applications of the following:

103	ASPHALT SEAL COAT	2.40 lb/sy
100	ASPHALT SEAL AGGREGATE	20 lb/sy (Size No.8 or 9M)

**PLAN NOTE NO.:**

**SPECIAL NOTE FOR:**

**SPECIAL PROVISION FOR:**

DRAFT